



BSI Standards Publication

Optical fibre cables

Part 4-20: Aerial optical cables along electrical power lines — Family specification for ADSS (All Dielectric Self Supported) optical cables

National foreword

This British Standard is the UK implementation of EN 60794-4-20:2012. It is identical to IEC 60794-4-20:2012.

The UK participation in its preparation was entrusted by Technical Committee GEL/86, Fibre optics, to Subcommittee GEL/86/1, Optical fibres and cables.

A list of organizations represented on this committee can be obtained on request to its secretary.

This publication does not purport to include all the necessary provisions of a contract. Users are responsible for its correct application.

© The British Standards Institution 2013.

Published by BSI Standards Limited 2013.

ISBN 978 0 580 70839 8

ICS 33.180.10

Compliance with a British Standard cannot confer immunity from legal obligations.

This British Standard was published under the authority of the Standards Policy and Strategy Committee on 31 January 2013.

Amendments issued since publication

Amd. No.	Date	Text affected
-----------------	-------------	----------------------

English version

**Optical fibre cables -
Part 4-20: Aerial optical cables along electrical power lines -
Family specification for ADSS (All Dielectric Self Supported)
optical cables
(IEC 60794-4-20:2012)**

Câbles à fibres optiques -
Partie 4-20: Câbles optiques aériens
installés le long des lignes d'énergie
électrique - Spécification de famille
pour les câbles optiques autoportés
par le diélectrique (ADSS)
(CEI 60794-4-20:2012)

Lichtwellenleiterkabel -
Teil 4-20: Lichtwellenleiter-Luftkabel
auf Starkstrom-Freileitungen -
Familienspezifikation für ADSS-LWL-
Kabel (dielektrische, selbsttragende
LWL-Kabel)
(IEC 60794-4-20:2012)

This European Standard was approved by CENELEC on 2012-11-29. CENELEC members are bound to comply with the CEN/CENELEC Internal Regulations which stipulate the conditions for giving this European Standard the status of a national standard without any alteration.

Up-to-date lists and bibliographical references concerning such national standards may be obtained on application to the CEN-CENELEC Management Centre or to any CENELEC member.

This European Standard exists in three official versions (English, French, German). A version in any other language made by translation under the responsibility of a CENELEC member into its own language and notified to the CEN-CENELEC Management Centre has the same status as the official versions.

CENELEC members are the national electrotechnical committees of Austria, Belgium, Bulgaria, Croatia, Cyprus, the Czech Republic, Denmark, Estonia, Finland, Former Yugoslav Republic of Macedonia, France, Germany, Greece, Hungary, Iceland, Ireland, Italy, Latvia, Lithuania, Luxembourg, Malta, the Netherlands, Norway, Poland, Portugal, Romania, Slovakia, Slovenia, Spain, Sweden, Switzerland, Turkey and the United Kingdom.

CENELEC

European Committee for Electrotechnical Standardization
Comité Européen de Normalisation Electrotechnique
Europäisches Komitee für Elektrotechnische Normung

Management Centre: Avenue Marnix 17, B - 1000 Brussels

Foreword

The text of document 86A/1467/FDIS, future edition 1 of IEC 60794-4-20, prepared by SC 86A "Fibres and cables" of IEC/TC 86 "Fibre optics" was submitted to the IEC-CENELEC parallel vote and approved by CENELEC as EN 60794-4-20:2012.

The following dates are fixed:

- latest date by which the document has to be implemented at national level by publication of an identical national standard or by endorsement (dop) 2013-08-29
- latest date by which the national standards conflicting with the document have to be withdrawn (dow) 2015-11-29

Attention is drawn to the possibility that some of the elements of this document may be the subject of patent rights. CENELEC [and/or CEN] shall not be held responsible for identifying any or all such patent rights.

Endorsement notice

The text of the International Standard IEC 60794-4-20:2012 was approved by CENELEC as a European Standard without any modification.

In the official version, for Bibliography, the following notes have to be added for the standards indicated:

IEC 60060-1:2010	NOTE	Harmonised as EN 60060-1:2010 (not modified).
IEC 60794 Series	NOTE	Harmonised as 60794 Series (not modified).
IEC 60794-1-2X Series	NOTE	Harmonised as EN 60794-1-2X Series (not modified).
IEC 60794-3	NOTE	Harmonised as EN 60794-3.
ISO 9001	NOTE	Harmonised as EN ISO 9001.

Annex ZA (normative)

Normative references to international publications with their corresponding European publications

The following documents, in whole or in part, are normatively referenced in this document and are indispensable for its application. For dated references, only the edition cited applies. For undated references, the latest edition of the referenced document (including any amendments) applies.

NOTE When an international publication has been modified by common modifications, indicated by (mod), the relevant EN/HD applies.

<u>Publication</u>	<u>Year</u>	<u>Title</u>	<u>EN/HD</u>	<u>Year</u>
IEC 60304	-	Standard colours for insulation for low-frequency cables and wires	HD 402 S2	-
IEC 60793-1-40	-	Optical fibres - Part 1-40: Measurement methods and test procedures - Attenuation	EN 60793-1-40	-
IEC 60793-1-44	-	Optical fibres - Part 1-44: Measurement methods and test procedures - Cut-off wavelength	EN 60793-1-44	-
IEC 60793-1-48	-	Optical fibres - Part 1-48: Measurement methods and test procedures - Polarization mode dispersion	EN 60793-1-48	-
IEC 60793-2-50	-	Optical fibres - Part 2-50: Product specifications - Sectional specification for class B single-mode fibres	EN 60793-2-50	-
IEC 60794-1-1	-	Optical fibre cables - Part 1-1: Generic specification - General	EN 60794-1-1	-
IEC 60794-1-2	-	Optical fibre cables - Part 1-2: Generic specification - Basic optical cable test procedures	EN 60794-1-2	-
IEC 60794-1-22	-	Optical fibre cables - Part 1-22: Generic specification - Basic optical cable test procedures - Environmental test methods	EN 60794-1-22	-
IEC 60794-1-23	-	Optical fibre cables - Part 1-23: Generic specification - Basic optical cable test procedures - Cable element test methods	EN 60794-1-23	-
IEC 60794-4	-	Optical fibre cables - Part 4: Sectional specification - Aerial optical cables along electrical power lines	EN 60794-4	-
IEC 61395	-	Overhead electrical conductors - Creep test procedures for stranded conductors	EN 61395	-

CONTENTS

1	Scope	6
2	Normative references	6
3	Terms, definitions and abbreviations	7
4	Optical fibres	9
4.1	General	9
4.2	Attenuation	9
4.2.1	Attenuation coefficient	9
4.2.2	Attenuation discontinuities	9
4.3	Cut-off wavelength of cabled fibre	9
4.4	Fibre colouring	9
4.5	Polarisation mode dispersion (PMD)	9
5	Cable elements	9
6	Optical fibre cable constructions	10
6.1	General	10
6.2	Optical unit	10
6.3	Cable protection elements	10
7	Main requirements for installation and operating conditions	11
8	Cable design considerations	11
9	Cable tests	12
9.1	General	12
9.2	Classification of tests	12
9.2.1	Type tests	12
9.2.2	Factory acceptance tests	13
9.2.3	Routine tests	13
9.3	Tensile performance	13
9.3.1	General	13
9.3.2	Maximum allowed tension (MAT)	13
9.4	Installation capability	13
9.4.1	General	13
9.4.2	Sheave test	13
9.4.3	Repeated bending	14
9.4.4	Impact	14
9.4.5	Crush	15
9.4.6	Kink	15
9.4.7	Torsion	15
9.5	Vibration testing	16
9.5.1	Aeolian vibration test	16
9.5.2	Low frequency vibration test (galloping test)	16
9.6	Temperature cycling	17
9.7	Water penetration	18
9.8	Weathering resistance	18

9.9	Tracking and erosion resistance test	18
9.10	Creep behaviour	19
9.11	Fitting compatibility	19
10	Factory acceptance tests	19
11	Routine tests	19
12	Quality assurance	20
Annex A (informative)	Packaging and marking	21
Annex B (informative)	Installation considerations for ADSS cables	22
Annex C (informative)	Electrical test (TRACKING)	23
Annex D (informative)	All Dielectric Self-Supported (ADSS) cables to be used in overhead power lines (Blank detail specification)	31
	Bibliography	33
Figure C.1	Draft of test equipment	25
Figure C.2	Test chamber	25
Figure C.3	Electric scheme for the test	27
Figure C.4	Details of the sample	27
Figure C.5	Nozzle	28
Figure C.6	Details for the spraying	29
Figure C.7	Pollution model	30
Figure C.8	Basic circuit for arcing test	30
Table 1	Cable design characteristics	11
Table 2	Optional parameters (if required by customer)	12
Table C.1	R_{eq} and C_{eq} values for different pollution index values	29
Table D.1	Blank detail specification	31

OPTICAL FIBRE CABLES –

Part 4-20: Aerial optical cables along electrical power lines – Family specification for ADSS (All Dielectric Self Supported) optical cables

1 Scope

This part of IEC 60794, which is a family specification, covers optical telecommunication cables, commonly with single-mode fibres to be used primarily in overhead power lines applications. The cable may also be used in other overhead utility networks, such as for telephony or TV services. Requirements of the sectional specification IEC 60794-4 for aerial optical cables along electrical power lines are applicable to cables covered by this standard.

NOTE In some particular situations in the electrical industry, short overhead links can be also designed with multimode fibres.

The ADSS cable consists of single-mode optical fibres contained in one or more protective dielectric fibre optic units surrounded by or attached to suitable dielectric strength members and sheaths. The cable does not contain metallic components. An ADSS cable is designed to meet the optical and mechanical requirements under different types of installation, operating and environmental conditions and loading, as described in Annex B.

This standard covers the construction, mechanical, electrical, and optical performance, installation guidelines, acceptance criteria, test requirements, environmental considerations, and accessories compatibility for an all dielectric, self-supporting fibre optic (ADSS) cable. The standard provides both construction and performance requirements that ensure, within the guidelines of this standard, that the mechanical capabilities of the cable components and maintenance of optical fibre integrity and optical transmissions are proper.

This standard excludes any “lashed” or “wrapped” OPAC cables.

Cables intended for installation in conformity with ISO/IEC 24702 and related standards may require the specification of additional tests to ensure their suitability in the applicable environments defined by the mechanical, ingress, climatic and chemical, and electromagnetic (MICE) classification. These tests are outside of the scope of IEC 60794 cable specifications, and MICE criteria are not part of the requirements for IEC 60794 specifications. The MICE tests may be the same as, similar to, or substantially different from, the tests required by IEC 60794 specifications. Cables manufactured per IEC 60794 specifications may or may not meet the MICE criteria. For supplemental discussion, see IEC/TR 62362.

2 Normative references

The following documents, in whole or in part, are normatively referenced in this document and are indispensable for its application. For dated references, only the edition cited applies. For undated references, the latest edition of the referenced document (including any amendments) applies.

IEC 60304, *Standard colours for insulation for low-frequency cables and wires*

IEC 60793-1-40, *Optical fibres – Part 1-40: Measurement methods and test procedures – Attenuation*

IEC 60793-1-44, *Optical fibres – Part 1-44: Measurement methods and test procedures – Cut-off wavelength*

IEC 60793-1-48, *Optical fibres – Part 1-48: Measurement methods and test procedures – Polarization mode dispersion*

IEC 60793-2-50, *Optical fibres – Part 2-50: Product specifications – Sectional specification for class B single-mode fibres*

IEC 60794-1-1, *Optical fibre cables – Part 1: Generic specification – General*

IEC 60794-1-2, *Optical fibre cables – Part 1-2: Generic specification – Basic optical cable test procedures*^{1, 2}

IEC 60794-1-22, *Optical fibre cables – Part 1-22: Generic specification – Basic optical cable test procedures – Environmental test methods*

IEC 60794-1-23, *Optical fibre cables – Part 1-23: Generic specification – Basic optical cable test procedures – Cable element test methods*

IEC 60794-4, *Optical fibre cables – Part 4: Sectional Specification – Aerial optical cables along electrical power lines*

IEC 61395, *Overhead electrical conductors – Creep test procedures for stranded conductors*

3 Terms, definitions and abbreviations

For the purposes of this document, the terms and definitions given in IEC 60794-1-1 and IEC 60794-4, as well as the following, apply.

3.1

maximum allowable tension

MAT

maximum tensile load that may be applied to the cable without detriment to the performance requirements (optical performance, fibre durability) due to fibre strain

Note 1 to entry: Due to installation codes the MAT value is sometimes restricted to be less than 60 % of the breaking tension of the cable.

3.2

maximum operation tension

MOT

tensile load that can be applied to the cable either permanently or for a long term without producing any strain to the fibres

Note 1 to entry: This condition should correspond to the tension with no ice and no gale wind at average mean temperatures throughout the year, assumed to be between 16 °C and 20 °C.

3.3

zero strain margin

tensile load that the cable can sustain without strain on fibres due to cable elongation

¹ This document has been withdrawn, but can still be purchased, if necessary. Until IEC 60794-1-21 will be available, the tests stated in Clause 9 have to be taken from IEC 60794-1-2.

² This standard will be replaced by IEC 60794-1-21, *Optical fibre cables – Part 1-21: Generic specification – Basic optical cable test procedures – Mechanical test methods* (see also Bibliography), as soon as it will be available.

3.4 breaking tension

tensile load that will produce physical rupture of the cable

Note 1 to entry: There is no optical consideration related to this parameter.

Note 2 to entry: The breaking tension should be calculated. The design model shall be validated; the cables do not need to be tested.

3.5 maximum installation tension MIT

maximum load that should be applied during the installation procedure

Note 1 to entry: The maximum installation tension refers mainly to the final adjust of sag (also called sagging load), and the same tension limit can be used for the deployment of the cable (also called stringing load).

Note 2 to entry: This is a recommended value aimed at avoiding tension values higher than MAT during operational life due to wind, ice or temperature changes.

3.6 ADSS

all dielectric self supported cable

dielectric cable that is capable of enduring aerial installation and providing long term service, without any external tensile support

3.7 OPAC

optical attached cable

dielectric, not self-supported, optical attached cable

Note 1 to entry: OPACs can be used with one of the following attachment methods:

- wrapped, known as an all-dielectric (wrap): using special machinery, a lightweight flexible non-metallic cable is wrapped helically around either the earth wire or the phase conductor;
- lashed: non-metallic cables are installed longitudinally alongside the earth wire, the phase conductor or on a separate support cable (on a pole route) and are held in position with a binder or adhesive cord;
- spiral attached: similar to the lashed cables except that the method of attachment involves the use of special preformed spiral attachment clips.

Note 2 to entry: OPAC cable designs are not covered by this specification.

3.8 cable fittings and dampers

3.8.1 suspension cable fitting

device to hold up the cable in intermediate support points along an aerial line, where the cable is under tension at both sides of the fitting

3.8.2 dead end cable fitting

device designed to terminate an installation run, isolate a splice location or maintenance coil, provide slack span locations, or provide for extreme angle turns, where the cable is under tensional load on one side of the fitting and tension free on the other

3.8.2 damper

device attached to a cable in order to suppress or minimize vibrations due to wind

4 Optical fibres

4.1 General

Single mode optical fibres shall be used which meet the requirements of IEC 60793-2-50. In this clause only the main characteristics are mentioned.

Fibres other than those specified above can be used, if mutually agreed between the customer and supplier. In this case, fibre characteristics and attenuation criteria for mechanical tests shall be specified in the detail specification.

4.2 Attenuation

4.2.1 Attenuation coefficient

The requirements for the uncabled fibres shall be according to IEC 60793-2-50.

Unless other values are agreed between supplier and customer, the maximum attenuation coefficient of the cabled fibres shall be 0,35 dB/km when measured at 1 310 nm and/or 0,25 dB/km at 1 550 nm.

Different values from those stated above can be agreed between customer and supplier.

The attenuation coefficient shall be measured in accordance with IEC 60793-1-40.

4.2.2 Attenuation discontinuities

The local attenuation shall not have point discontinuities in excess of 0,10 dB.

The test method used to verify the functional requirements shall be in accordance with IEC 60793-1-40.

4.3 Cut-off wavelength of cabled fibre

The cabled fibre cut-off wavelength λ_{cc} shall be lower than the operational wavelength when measured in accordance with IEC 60793-1-44.

4.4 Fibre colouring

The primary coated fibres shall be coloured for identification. The coloured coating shall be readily identifiable throughout the lifetime of the cable and shall be at a reasonable match to the requirements stated on IEC 60304. If required, the colouring shall permit sufficient light to be transmitted through the primary coating to allow local light injection and detection.

4.5 Polarisation mode dispersion (PMD)

PMD shall meet the values indicated in IEC 60793-2-50. The measurement procedure shall be in accordance with IEC 60793-1-48.

5 Cable elements

Refer to the relevant parts of the sectional specification IEC 60794-4; the following requirements apply specifically to ADSS cables:

The material(s) used for a cable element shall be selected to be compatible with the other elements in contact with it.

Optical elements (cable elements containing optical fibres) and each fibre within a cable element shall be uniquely identified, for example, by colours, by a positional scheme, by markings or as agreed between customer and manufacturer.

For loose tube construction, one or more primary coated fibres or optical elements are packaged, loosely in a tube construction, with a suitable water-blocking system. The plastic tube may be reinforced with a composite wall.

If required by the customer, the suitability of the tube shall be determined by an evaluation of its kink resistance in accordance with IEC 60794-1-23, Method G7.

When used, optical fibre ribbons should comply with the requirements stated in IEC 60794-3.

6 Optical fibre cable constructions

6.1 General

The cable shall not contain any metallic material.

6.2 Optical unit

Optical unit elements as described in Clause 5 may be laid up as follows:

Single optical unit in the cable centre, which may contain one or more optical elements:

- a) number of loose tubes using helical or SZ stranding configurations around a central element of reinforced plastic, epoxy-glass, or other dielectric material. Ribbon elements may be laid up by stacking two or more elements inside the loose tubes;
- b) configuration based on a channelled dielectric rod, containing units such as ribbons or plastic tubes, which may contain one or more optical elements.

6.3 Cable protection elements

In addition to optical unit, the cable construction may consist of the following.

- a) The outer sheath shall be a weather-resistant type material. In certain conditions it shall be necessary to consider the use of a tracking-resistant sheath.
- b) ADSS cable shall contain self-supported systems that are integral to the cable. The purpose of the support system is to ensure that the cable meets the optical requirements under specified installation conditions, temperatures, and environmental loading for its whole operating design life. This standard excludes any “lashed” or “wrapped” OPAC cables.
- c) The basic annular construction may have strength yarns (e.g. aramid yarns) or other dielectric strands or a channelled dielectric rod as a support structure. In addition, other cable elements, such as central members, may be load bearing.
- d) Fibre strain allowance
- e) The cable shall be designed such that fibre strain does not exceed the limit allowed by the cable manufacturer under design tension limits of the cable (MAT). Maximum allowable fibre strain under MAT condition will generally be a function of the proof test level and strength and fatigue parameters of the optical fibre, 0,33 % is specified for fibre proof tested to 1 %.
- f) A water blocking material shall be used to prevent water penetration to the optical units and to the cable core. The material shall be easily removed without the use of materials considered to be hazardous or dangerous. Water swell able blocking materials can also be used.

When used in the cable construction, the filling compound shall not flow at temperatures lower than the maximum specified operation temperature of cable.

NOTE In some countries, a special requirement of shotgun resistance can be specified for aerial cables. ADSS covered by this standard are not designed for this condition.

Cables with reinforced textile protection, could still meet the dielectric condition, but the increase in diameter and weight would require a significant enhancement of the tensile performance of the cable.

7 Main requirements for installation and operating conditions

Operating conditions are particularly important for ADSS cables.

Installation and operating conditions shall be agreed between customer and supplier. For ADSS a detailed study of the field conditions and an important amount of technical support by the supplier or third party expert should precede the agreement. Annex B provides a general view of such considerations.

The type of fittings and hardware used to attach the ADSS to the structures shall be approved between the customer and the supplier. Their compatibility has to be checked according to 9.11 and the supplier or the customer fittings' specification.

8 Cable design considerations

Table 1 is a summary of cable characteristics which may be of importance as specifications to both the customer and the supplier. Table 2 includes optional engineering parameters relevant for the design and installation of the overhead line with ADSS cable. Other characteristics may be mutually agreed upon by both customer and supplier. A complete blank specification is shown in Annex D.

Table 1 – Cable design characteristics

Reference	Characteristics	Units
4	Number and type of fibres	NA
–	Modularity of cable core (fibres per tube)	NA
6	Detailed description of cable design	NA
–	Overall cable diameter	mm
	Cable weight	kg/km
3.1	MAT maximum allowable tension	kN
9.6	Allowable temperature for storage, installation and operation	°C
9.4.2	Minimum bending diameter during installation	mm
9.4.3	Minimum bending radius installed	mm

Table 2 – Optional parameters (if required by customer)

Reference	Characteristics	Units
3.5	MIT maximum installation (or sagging) load	kN
–	Modulus of elasticity	MPa
–	Coefficient of thermal expansion	$10^{-6}/^{\circ}\text{C}$
3.1	Fibre strain at MAT load	%
3.2	Zero strain margin	kN
9.9	Creep behaviour	mm
	Maximum Sag at MOT and MAT	m
	Environmental loading conditions – reference to local or regional installation code	NA

9 Cable tests

9.1 General

The parameters specified in this standard may be affected by measurement uncertainty arising either from measurement errors or calibration errors due to the lack of suitable standards. Acceptance criteria shall be interpreted with respect to this consideration. For some of the parameters specified in this standard, the objective is no change in attenuation.

These parameters may be affected by measurement uncertainty arising either from measurement errors or calibration errors due to a lack of suitable standards. Acceptance criteria shall be interpreted with respect to this consideration. The total uncertainty of measurement for this standard shall be $\leq 0,05$ dB for attenuation or 0,05 dB/km for attenuation coefficient.

Any measured value within this range, either positive or negative, shall be considered as “no change in attenuation”. By agreement between customer and supplier, minor deviation from this limit may be accepted at some low frequency, e.g. less than 10 % of the fibres. However, for mechanical tests no deviation in excess of 0,15 dB shall be accepted.

In some environmental and installation tests, some increase is accepted.

The number of fibres tested shall be representative of the cable design according to fibre sampling indicated IEC 60794-1-1. Different sampling can be agreed between customer and supplier.

The tests applicable for aerial cables are listed below. The minimum acceptance criteria for the different designs of cables shall be indicated in the product specification.

The specimens for the tests shall be taken from the supplier in advance to the tests.

9.2 Classification of tests

9.2.1 Type tests

Tests required to be carried out before supplying a cable covered by this standard on a general commercial basis in order to demonstrate satisfactory performance characteristics to meet the intended application. These tests shall be carried out on a cable length which meets the requirements of the relevant routine tests. These tests are of such a nature that, after they have been made, they need not to be repeated unless significant changes are made in the cable material, design or type of manufacturing process which might change the performance characteristics.

A full type verification of a cable design includes all tests and characteristics specified in this standard. Tests to be repeated shall be agreed between the customer and the supplier.

9.2.2 Factory acceptance tests

Tests made on samples of completed cable, or components taken from a completed cable to verify that the finished product meets the design specifications. Scope and incidence of sample tests, if required, shall be agreed between the customer and the supplier.

Failure of a test specimen to comply with any one of the requirements of this standard shall constitute grounds for rejection of the lot represented by the specimen. If any lot is so rejected, the supplier shall have the right to test, only once, all individual drums of cables in the lot and submit those which meet the requirements for acceptance.

9.2.3 Routine tests

Tests made on all production cable lengths to demonstrate their integrity.

Failure of a test specimen to comply with any one of the requirements of this standard shall constitute grounds for rejection of the lot represented by the specimen. If any lot is so rejected, the supplier shall have the right to test, only once, all individual drums of cables in the lot and submit those which meet the requirements for acceptance.

9.3 Tensile performance

9.3.1 General

The tensile performance of the cable is verified with the test methods in 9.2.1 and 9.2.2. The cable manufacturer shall specify the MOT and the MAT for the ADSS design. Both tests shall be evaluated on the same cable sample, subjecting in a first step, the sample to the MOT test, releasing the load to zero tension and then applying the MAT test.

9.3.2 Maximum allowed tension (MAT)

The cable shall be terminated with suitable dead end fittings adequate to the type of cable and tested following Methods E1A and E1B, indicated in IEC 60794-1-2.

A minimum length of 50 m of cable shall be loaded until the specified MAT is applied and sustain this load level for 1 h. Under this load, the strain in the fibre should not be higher than 0,33 % for fibres proof tested at 1 % strain. The attenuation increase shall not exceed 0,15 dB at 1 550 nm.

9.4 Installation capability

9.4.1 General

Compatibility of ADSS design and hardware with common installation conditions and practices shall be demonstrated by evaluation of the following tests.

9.4.2 Sheave test

The test shall be performed to verify that the installation of the cables will not damage or degrade their performance. The cable shall be tested in accordance with Method E18, procedure 3 or 4 of IEC 60794-1-2.

The sheave test shall be performed on a sample cable of a minimum length of 9 m. Dead-end fittings shall be clamped a minimum of 3 m apart. The optical fibres shall be connected to each other by means of fusion or equally reliable splices. The test length of optical fibre shall be a minimum of 100 m long.

The cable shall be pulled at one dead-end at the maximum stringing tension (MIT) specified by the ADSS cable manufacturer. The method of attachment, although not rigid, shall limit the amount of twist that could occur at the lead end. A dynamometer and a swivel shall be installed between the yoke and the other dead-end.

A 2 m minimum length of the ADSS test sample shall be pulled 40 times forward and backward through the sheave (20 times in each direction).

The diameter of the sheave for the angle of pull shall be no smaller than the manufacturer's minimum bend diameter for the ADSS cable under test. A minimum diameter of $40 \times$ the outside diameter of the cable is recommended. Before the first pull, the beginning, midpoint, and end of the length shall be marked. After the test is completed, the attenuation shall be measured and the ADSS cable shall be removed in the tested section, and the cable shall be visually examined for any damage. The ADSS cable may be dissected to observe for any signs of damage to the inner structure.

- Family requirement

Maximum permanent increase in attenuation; 0,1 dB at 1 550 nm.

- Test conditions
 - Procedure 3 or 4 of E18 of IEC 60794-1-2
 - Tension level applied during test; maximum stringing load (or MIT)
 - Length of the cable: 9 m minimum. Length bent under tension; 2 m
 - Diameter (D) of roller / cylinders; \leq manufacturer's minimum bend diameter (approximately ≤ 40 times cable outside diameter is recommended)
 - Bending angle; $45^\circ \pm 15^\circ$
 - Moving speed $1 \text{ m/s} \leq \text{speed} \leq 10 \text{ m/s}$
 - Number of complete moving cycles: 20
 - The cable should be terminated with the recommended dead end fittings

9.4.3 Repeated bending

The cable shall be tested in accordance with the method specified in IEC 60794-1-2, Method E6.

- Family requirements:

Under visual examination without magnification there shall be no damage to the sheath or cable elements. There shall no attenuation increase greater to 0,05 dB at 1 550 nm after the completion of the test.

- Test conditions
 - Bending radius: 20 d
 - Load: Adequate to assure uniform contact with the mandrel
 - Number of cycles: 25
 - Duration of cycle: Approximately 2 s

Particular conditions may be agreed between manufacturer and supplier.

9.4.4 Impact

The cable construction shall be tested in accordance with the method specified in IEC 60794-1-2, Method E4, without physical damage on the cable elements or attenuation increase greater to 0,05 dB after the completion of the test.

- Family requirements:

Under visual examination without magnification there shall be no damage to the sheath or to the cable elements. The imprint of the striking surface on the sheath is not considered mechanical damage.

The increase in attenuation shall be $\leq 0,05$ dB at 1 550 nm.

- Test conditions

- Striking surface radius: 10 mm or 300 mm
- Impact energy: 10 J with striking surface radius of 300 mm or 3J with surface radius of 10 mm
- Number of impacts: Three, each in a different place spaced not less than 500 mm apart

9.4.5 Crush

The cable shall be tested in accordance with the method specified in IEC 60794-1-2, Method E3, without physical damage or attenuation increase greater than 0,05 dB.

Under visual examination, there shall be no damage to the sheath or to the cable elements.

The imprint of the plate or mandrel on the sheath is not considered mechanical damage.

- Family requirements

- Long term ≥ 10 min. Attenuation increase $\leq 0,05$ dB; (prior to release of load)
- Short term ≥ 1 min. Attenuation increase $\leq 0,05$ dB; (after test)

- Test conditions

- Load (plate/plate): 2,2 kN for short term load, 1,1 kN for long term load
- Duration of load: 1 min of short term load, followed by 10 min of long term load
- Number of tests: 3
- Spacing between test places: 500 mm

9.4.6 Kink

The cable shall be tested in accordance with the method specified in IEC 60794-1-2, Method E10, without physical damage on the cable elements.

The minimum diameter shall be agreed between the customer and the supplier.

9.4.7 Torsion

The cable shall be tested in accordance with the method specified in IEC 60794-1-2, Method E7.

- Family requirements

Under visual examination without magnification there shall be no damage to the sheath or to the cable elements.

The variation on attenuation after the test shall be no greater than 0,05 dB at 1 550 nm.

- Test conditions

- Length under test: 2 m
- Number of turns: One half turn (through 180°) over the length of 2 m in each direction

- Number of cycles: 10

9.5 Vibration testing

9.5.1 Aeolian vibration test

The resistance of the cable to Aeolian vibration shall be tested in accordance with Method E19 of IEC 60794-1-2.

- Family requirement

Under visual examination without magnification there shall be no damage to the sheath or to the cable elements. The variation on attenuation after the test shall be no greater than 0,1 dB at 1 550 nm

- Test conditions
 - Number of cycles; 100 000 000
 - Frequency of vibration; 60 Hz \pm 10 Hz, or the calculated values for specific operation conditions, requested by the customer
 - Tension applied: 40 % of MAT
 - The cable should be terminated with the recommended dead end and suspension fittings.

9.5.2 Low frequency vibration test (galloping test)

The resistance of the cable to low frequency vibration will be tested in accordance with Method E26 as soon as this test method will be available³.

- Family requirement
 - The attenuation at 1 550 nm shall be less than or equal to 1,0 dB/km
 - The sheath shall have no cracks or splits
- Test conditions
 - Number of cycles: 100 000
 - Peak-to-peak antinode amplitude/loop length ratio: 1/25
 - Tension: The cable should be tensioned to a level that permits induced galloping in the defined amplitude; 5 % to 10 % of MAT is an adequate tension level.
 - The overall span between dead-end assemblies should be a minimum of 35 m. The end abutments are used to load and maintain tension in the fibre optic cable. The test section is contained between the two intermediate abutments. End and intermediate abutments need not be separate units if the combined unit affords sufficient space for the apparatus specified below. The fibre optic cable to be tested should be a sufficient length beyond the intermediate abutments to allow removal of the cable outer coverings and to allow access to the optical fibres. The test sample shall be terminated at both ends prior to tensioning in such a way that the optical fibres cannot move relative to the cable. A dynamometer, load cell, calibrated beam, or other device should be used to measure cable tension. Some means should be provided to maintain constant tension to allow for temperature fluctuations during the testing. However, some tension fluctuations are expected from the galloping activity itself.
 - A suitable suspension assembly shall be located approximately midway between the two dead-end assemblies. It shall be supported at a height such that the static sag angle of the cable to horizontal does not exceed 1°.
 - Means shall be provided for measuring and monitoring the mid-loop (antinode), single loop galloping amplitude. A suitable shaker shall be used to excite the cable in the

³ Test method E26 is planned to be specified in IEC 60794-1-21 (under consideration).

vertical plane. The shaker armature shall be securely fastened to the cable in the vertical plane.

- The test length (i.e., between dead-end assemblies) of the optical fibre shall be a minimum of 100 m. To achieve this length several fibres may be spliced together. At least one fibre shall be tested from each buffer tube or fibre bundle. Splices should be made so the optical equipment can be located at the same end. Optical measurements shall be made using a light source with a nominal wavelength of 1 550 nm for single-mode fibres and a nominal wavelength of 1 300 nm for multimode fibres. The source shall be split into two signals. One signal shall be connected to an optical power meter and shall act as a reference. The other signal shall be connected to a free end of the test fibre. The returning signal shall be connected to a second optical power meter. All optical connections and splices shall remain intact through the entire test duration.
- An initial optical measurement shall be taken when the span is pre-tensioned to approximately 5 % of maximum installation tension prior to final tensioning to maximum installation tension. The difference between the two signals for the initial measurement provides a reference level. The change in this difference during the test shall indicate the change in attenuation of the test fibre. The signals may be output on a strip chart recorder for a continuous hardcopy record.
- The cable shall be subjected to a minimum of 100 000 galloping cycles. The test frequency shall be the single loop resonant frequency. The minimum peak-to-peak antinode amplitude/loop length ratio shall be maintained at a value of 1/25, as measured in the active span.
- Mechanical and optical data shall be read and recorded approximately every 2 000 cycles.
- The optical power meters shall be continuously monitored beginning at least 1 h before the test and ending at least 2 h after the test.
- The final optical measurement shall be taken at least 2 h after the completion of the vibration test. A section of cable from the location of the hardware support shall be loaded to the MOT, and the attenuation shall comply with 4.2.1.

9.6 Temperature cycling

The cable shall be tested in accordance with the method specified in IEC 60794-1-22, Method F1, one cycle procedure with the temperature limits, according to operation limits in the product specification, or combined test procedure if different storage limits are specified.

- Family requirements

For T_A and T_B (T_{A1} and T_{B1} in combined test) there shall be no change in attenuation ($\leq 0,05$ dB/km) from the reference room temperature measurement when measured in the 1 550 nm region or at the operational wavelength when specified by the user. T_{A1} and T_{B1} temperature levels are only required during the last cycle.

For T_{A2} and T_{B2} , the change in attenuation coefficient shall be $\leq 0,15$ dB/km during the last cycle from the reference room temperature measurement.

On completion of the test there shall be no change in attenuation ($\leq 0,05$ dB/km). The measurement shall be made in the 1 550 nm.

- Test conditions

- Sample length: Finished cable length of at least 500 m
- High temperature, T_B for one cycle procedure (T_{B1} for combined test): +60 °C
- High temperature, T_{B2} : +70 °C (only for combined test)
- Low temperature, T_A for one cycle procedure (T_{A1} for combined test): –20 °C
- Low temperature, T_{A2} : –40 °C, (only for combined test)

- Rate of heating: Sufficiently slow so that the effect of changing the temperature does not cause a temperature shock or 40°/h, if not specified
 - t_1 : Time enough to get temperature stability in the sample,
 - Number of cycles: 2, additional cycles may be required depending on user requirements
- Temperature values may vary depending on user requirements.

9.7 Water penetration

The cable shall be tested in accordance with IEC 60794-1-22, Method F5B.

No water shall be detected at the unsealed end of the sample during and at the end of the test.

9.8 Weathering resistance

The outer sheath shall be made of UV-stabilized weather-resistant material in accordance with IEC 60794-1-22. In certain conditions it shall be necessary to consider the use of a tracking-resistant sheath.

Further requirements are under consideration.

9.9 Tracking and erosion resistance test

Dielectric cables installed on power lines are exposed to electrical fields. The magnitude of this field (space potential) depends on the line voltage, tower design, conductor configuration, and installation location for the ADSS. Together with specific environmental conditions, especially desert or highly polluted areas close to the sea, this can lead to electrical degradation (e.g. dry-band arcing), which can cause severe damage to the outer cable sheath and finally can cause a total cable failure. The sensitivity to electrical degradation depends on a combination of the space potential, the cable, environment, and sheath material used. In areas with higher space potentials or poor environmental conditions, track resistant sheath materials may be essential to alleviate the risk to product life.

Experience has shown that the formerly used >12 kV space potential transition point for using track resistant sheath materials may be too high depending on the environmental conditions. Under certain environmental conditions, as mentioned above, tracking resistant sheaths may be needed with space potentials down to 4 kV. Even with tracking resistant sheath materials, special consideration about the feasibility of ADSS applications is required for levels higher than 20 kV.

Tracking resistant sheath materials shall be used in the following field conditions:

- a) power lines with an operation voltage of 150 kV or higher;
- b) power lines producing space potential of 4 kV or higher in salty or polluted areas.

If the ADSS cable is used in telecommunication poles or low voltage distribution lines, track resistant requirements can be waived.

Three current options for evaluating the quality of track resistant sheath materials are given in Annex C as follows.

- 1) Salt fog method: evaluates cable in a wet condition (continuous salt water spray).
- 2) Alternating wet drying cycles in either normal or desert conditions.
- 3) Alternating wet dry cycles with different current levels to reflect different degrees of resistivity resulting from varying degrees of regional environmental conditions.

Other test conditions may be needed to evaluate ADSS tracking resistance for specific environments.

9.10 Creep behaviour

Creep behaviour is engineering information, not a specification. The cable is tested in accordance with IEC 61395, and the applied load should be MOT, the maximal operational tension.

9.11 Fitting compatibility

The type of fittings shall be approved between the customer and the supplier and their compatibility has to be verified as follows.

- Dead end fittings shall be used during the MAT test (9.3.2), with a maximum of 3 mm of displacement between fitting and cable during and after the test. (Under consideration.)
- A cable sample with dead end fittings shall stand 24 h at a temperature of $60\text{ °C} \pm 2\text{ °C}$ and controlled 85 % HR, under MAT load, with a maximum displacement of 3 mm between each fitting and cable. (Under consideration.)
- Suspension fitting shall be used during vibration tests (9.5) with no damage to the cable during the test. Vibration dampers can also be qualified during this test.
- Following the completed testing, the hardware fittings shall be removed and the cable outer sheath inspected. There shall be no splits or tears in the other sheath.

NOTE The use of vibration dampers is not compulsory. but is an installation option.

10 Factory acceptance tests

Sample tests and factory acceptance tests shall be carried out according to the quality plan of the supplier and, if required, in the presence of the customer or their representative.

Additional tests may be agreed between customer and supplier. The test methods and requirements are given in this standard.

Typical tests:

- Visual inspection of the cable elements
- Diameter of cable
- Weight of cable
- Optical fibre attenuation coefficient at 1 550 nm or other agreed operational wavelength
- Maximal allowed tension MAT – during product qualification or requalification, or as directed by customers for type test approval
- Maximal operational tension MOT – during product qualification or requalification, or as directed by customers for type test approval.

11 Routine tests

Routine tests shall be carried out on all manufactured cables and in accordance with the quality plan of the supplier.

Additional tests may be agreed between customer and supplier. The test methods and requirements are given by this standard.

Typical tests are the following:

- inspection of incoming raw materials according to the manufacturer's quality plan;
- optical fibre attenuation coefficient at operational wavelength;
- quality of cable surface;
- diameter of cable.

12 Quality assurance

The supplier shall establish, introduce and maintain a quality management system in accordance with ISO 9001 or equivalent.

Annex A (informative)

Packaging and marking

Cable should be tightly and uniformly wound onto reel(s) in layers. Reel lengths may be either standard length or specified length. Standard lengths are reel lengths normally provided by a supplier. This length will be defined by the supplier. Specified lengths are reel lengths which are specified by the customer. A tolerance of $\pm 2,0$ % should be maintained for specified lengths and standard lengths.

Reels should be either wooden non-returnable or steel returnable type. Unless specified otherwise by the customer, the supplier will determine the size and type reel that will withstand normal shipping, handling, storage and stringing operations without damage to the cable.

The reel and inside flanges should be manufactured in a manner that damage will not occur to the cable during shipping, handling, storage and stringing.

Cable should be adequately protected against mechanical damage and solar heating.

Reel numbers should be identified in a clear and legible manner on the outside of each flange on two opposite locations.

Each reel should be tagged with a shipping tag. Tags should be weather resistant. All essential information such as supplier's name, cable size and number of fibres, order number, reel number, cable number and cable lengths, and gross, tare, and net weight, should appear legibly on the tags. The tags should clearly indicate the type of cable in the description.

The cable ends should be securely fastened to prevent the cable from becoming loose during shipment. The inner end of the cable should be accessible for connection to optical measuring equipment. This length of cable should be securely fastened and protected during shipment.

A seal should be applied to each end of the cable to prevent the entrance of moisture into the optical fibres or the escape of filling compound during shipment and storage.

Each reel should be marked on the outside flange to indicate the direction the reel should be rolled during shipment in order to prevent loosening of the cable on the reel.

Annex B (informative)

Installation considerations for ADSS cables

In most cases, for underground application cables, the maximum mechanical stress (due to tension, torsion, compression, etc.) occurs during the installation process. During the rest of its operative life, the cable, if properly installed, will suffer stress eventually or just a residual permanent value.

On the contrary, aerial cables will be during the working life permanently under the installation tension and can be periodically subjected to higher tensions due to variable environmental conditions.

In aerial applications, in order to guarantee a long working life for the cable, it is not enough only to perform a careful installation procedure and test the fibres at the end of the job. It is necessary to know the environmental conditions and weather cycles in the location and from that information select or design the cable.

The combination of all these parameters in a field condition define the tensile strength required in the cable and a detailed engineering study considering several parameters affecting the required strength of the cable, span, sag, temperature, wind speed, and ice formation; all of them are considered for the design of an aerial power line. Some additional considerations have to be made to ensure the selected cable is adequate.

- a) In conductor cables, the mechanical strength is proportional to cable size, which is part of the electrical design of the line. So the physical design of the link necessarily takes into account the cable's mechanical resistance. As the ADSS has no electrical function and is frequently installed in existing power lines, its mechanical analysis is independent and the lack of information could lead to an over-design or under-design of the cable.
- b) The reference parameter in metallic cables is the breaking load. In critical conditions the cable can be under short term stress close to the limit without intrinsic damage. In a similar situation for an ADSS, the fibres could be broken. Since not the integrity of the cable, but the fibres themselves are the first concern in a telecommunication link, breaking strength is not the selected parameter to specify an ADSS cable. In order to protect fibre integrity, the reference should be the maximal allowed load (MAT).
- c) Breaking load is not a parameter in the optical/mechanical performance of an ADSS cable. In some countries, the breaking strength of aerial cables is a regulation as an installation requirement.
- d) The MAT gives the key specification values for cable performance. It shall be matched with the critical stress situations (wind, heavy ice, temperature) that, although not frequent, are expected to be present in the area.
- e) Elasticity module, coefficient of linear expansion and creep behaviour are engineering data. These values should be provided by the manufacturer to be used for tension/sag calculations, if requested by the customer or sag/tension tables should be provided.
- f) Maximum span distance, minimum or maximum sag can be recommended for particular installation cases only after the detailed engineering study.
- g) The placement of the ADSS cable as it relates to the power conductor and its associated voltage affects the space potential the ADSS cable is exposed. Compatibility with this space potential shall be considered.

For information on necessary installation procedures and safety issues for personnel and equipment when installing or maintaining ADSS cables on overhead power lines, see IEC/TR 62263.

Annex C **(informative)**

Electrical test (TRACKING)

C.1 General

If the cable sheath is affected by electrical erosion due to various conditions, there is no universal test method for its evaluation. However, 3 possibilities (options) are described in this annex.

Option C1 is a well established way to control a sheath material referred to in a specification. It is very useful to the industry for material qualification, although it has no correlation to cable behavior in the field.

Option C2 is an example of test method for particular environment.

Option C3 correlates the result of the test to different pollution conditions.

C.2 Option C1 – Sheath material qualification

C.2.1 Overview

The objective of this test is to demonstrate the resistance of the cable sheath to erosion and tracking under combined electrical and mechanical stresses, while exposed to humid (salt fog) conditions.

C.2.2 Test arrangements

A length of cable shall be taken from a production run and sealed at each end against moisture ingress before being supported horizontally inside a salt fog chamber between two anchor points. This will enable it to be tensioned mechanically to a level that represents the value of operation conditions for the cable. The earth termination shall be identical to that proposed by the supplier for use in service adjacent to a support tower and may consist, for example, of spiral-wrap gripping wires together with any suitable mechanical or electrical stress-relieving accessories. This design of the high-voltage termination shall be at the discretion of the supplier.

The gauge length between terminations shall be great enough to avoid flashovers from taking place during the salt fog test, and a length of 25 mm/kV is usually adequate. The separation between electrode terminations should be 40 mm at least. The cable should be tensioned with such means so that any creep of the cable material during the test does not result in a major reduction in tension. At suitable intervals during the test, for example every 100 h, the tension should be checked, and if it has changed by more than 10 % of the initial value, it should be adjusted to fall within range again.

A conduction fog shall be produced within the chamber by the use of a suitable number of atomizing nozzles similar to the design shown in Figure 18 of IEC 60060-1:2010 Bi 11. A useful guide is to have one nozzle for each 2 m³ of chamber volume. The salt solution to the nozzle shall be prepared dissolving (10,0 ± 0,5) kg NaCl in 1 000 l of distilled and de-ionized water. The droplet size should be in the range of 5 µm to 20 µm and the flow rate of this solution in the chamber should be (0,4 ± 0,1) l/h for each cubic meter of chamber volume. This generally requires an injection of dry air at a pressure of 3,3 bars to the nozzles. The nozzles shall be distributed evenly around the chamber to give a homogeneous fog density, and no jet should point directly at the cable. An aperture of no more than 80 cm² should be provided on the chamber wall for the natural exhaust of air.

A power frequency test transformer shall be used with a minimum continuous rating of 250 mA r.m.s. and a trip level set at 1 A r.m.s. There shall be a clearance of at least 300 mm to earth in the vicinity of the cable.

C.2.3 Test procedure

After tensioning the cable to the MOT load, it shall be wiped with a cloth or paper towel soaked in water and then subjected to the salt fog.

After verifying the droplet size, the homogeneity of fog inside of chamber and the homogeneity of electrodes separation, for a period of 1 000 h, note that IEEE 1222 uses 1 000, a voltage level shall be applied on the evaluation circuit according to the following classification.

For ADSS cables intended to be installed on tracking generator environments, due to high level induced voltage and/or due to high concentration of contamination particles, the test voltage should be set at 3,0 kV/cm of separation between electrodes.

The salt water may not be recirculated. Several interruptions of the test for inspection purposes are permissible, each not exceeding 15 min. Interruption periods, which typically occur at 24 h intervals, do not count toward test duration.

C.2.4 Requirements

After completion of the test, from visual examination, there shall be no signs of internal material exposed to the external environment through the sheath neither on the voltage application area nor on the cable fixation points for mechanical tension application.

The cable sheath shall show tracking erosion no greater than 30 % of the original sheath thickness. A transversal cut should be made on the tested section of cable sheath in order to verify the test compliance by measurement with calibrated calliper.

C.3 Option C2 – Example of test for Sahara desert conditions

C.3.1 Overview

The objective of this test method is to demonstrate the resistance of the cable sheath to erosion and tracking under combined electrical and mechanical stresses under two environments; humid climate or dry desert like conditions.

C.3.2 Test arrangement

The equipment described in the following (see Figure C.1) was designed to test the cable under most realistic conditions. Therefore, parameters like installation tension, tilt of the cable, capacitive coupling between cable and HV power lines and environmental conditions (pollution, humidity) were taken into account.

A length of cable (typically between 5 m and 7 m) should be taken from a production run and sealed at each end against moisture ingress before being installed in the test chamber. The cable is installed in the set-up under an angle of 3° from the horizontal plane and under a mechanical tension equivalent to MOT load. Standard spiral-wrap gripping is used to tension the cable.

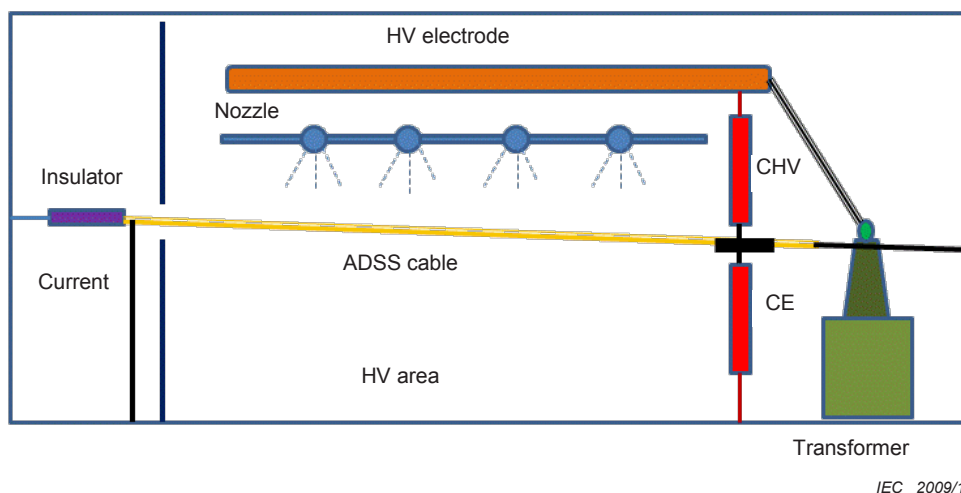

Figure C.1 – Draft of test equipment

The capacitive coupling between the cable and the power line is simulated by an electrode which is attached to a HV transformer (0 to 80) kV. The realistic cable length is taken into account by the two capacitors CHV and CE which are in the order of 200 pF each.

To achieve a slightly conductive cable surface a spraying mechanism was installed. Several spraying nozzles were arranged along the cable in order to achieve homogeneous humidity condition. The flow as well as the spray time should be controlled electronically.

To achieve sufficient conductivity approximately 0,4 g of salt should be dissolved in 1 l of water. To speed up the test and enhance the statistics more than one cable sample should be tested at the same time. Figure C.2 shows a photograph of a test set-up.

C.3.3 Sample preparation

Depending on the environment where the cable is going to be installed the cable sample has to be prepared differently. For simplicity, only two environments were distinguished. The “normal” environment is characterized by a typical mid-European climate with regular rain fall and thus no continuous pollution on the cable surface. The desert-like environment leads to a sometimes complete coverage of the cable surface by a dust layer with a thickness in the millimetre range. Together with the daily dew a conductive path can be formed on the cable which finally leads to dry band arcing which can destroy the cable sheath.



Figure C.2 – Test chamber

C.3.3.1 “Normal” environment

Cable will be installed in the test chamber without any specific treatment of the outer surface.

C.3.3.2 Desert-like environment

To simulate the “worst case” installation conditions in a desert-like environment the cable has to be specially prepared for testing. The cable sheath has to be covered with an artificial “dust layer” to simulate the conditions in a desert.

A 50 % emulsion of dust, with the same composition (3 % NaCl, 10 % gypsum, 32 % chalk, 50 % clay, 5 % cement) as the Egyptian desert, in water is applied by paint brush. A spatula is used to create a constant emulsion thickness of 0,5 mm on the cable. This corresponds to conditions found in the field. The last part of sample preparation is allowing the water in the deposit to evaporate.

C.3.4 Test procedure

The measurement phase is divided into cycles. A cycle starts by spraying a salt solution in the atmosphere of the test chamber for 4 min. A salt solution as defined in C.3.2 is used instead of water for two reasons: in case of the “normal environment” the salt provides a certain conductivity of the cable surface and in the case of the “desert-like environment” it prevents salt from being washed out of the deposit layer. Next the chamber is ventilated to remove moisture from the air and to evaporate the water from the field electrodes.

Now the AC high voltage is switched on (typically 10 kV to 50 kV) and the surface current is monitored. Time of test starts counting at this point. The induced current is at least 1,5 mA for a tension of 30 kV. As the cable is drying, the current drops and sparks can appear on the outside of the cable, especially close to the upper end connection. If the current has dropped substantially (below 0,5 mA) no more sparks occur and the high voltage is switched off (after 20 min). The cycle is now complete.

The measuring cycles are repeated continuously and the observed current through the cable is recorded. If the current suddenly increases at least once a day, the cable is inspected visually.

C.3.5 Requirements

After completion of the number of cycles indicated in the product specification, from visual examination, there shall be no signs of internal material exposed to the external environment through the sheath either on the voltage application area or on the cable fixation points for mechanical tension application.

The cable sheath should show tracking erosion no greater than 30 % of original sheath thickness. A transversal cut should be made on the tested section of cable sheath in order to verify the test compliance by measurement with calibrated calliper.

C.4 Option C3 – Pollution level and tracking resistance

C.4.1 Overview

The objective of this test method is to demonstrate the resistance of the cable sheath to erosion and tracking under different arc voltages and degrees of pollution resistance. This test method uses a Thevenin equivalent circuit shown in Figure C.3 to represent the effect of space potential in the presence of different pollution levels which affect the surface resistance. V_{OC} represents the open circuit voltage across a dry band of wet pollution in the absence of arc current (see Figure C.3). Contamination levels are represented by the R and C in the circuit. More details of this test method can be found in IEEE paper, TPWRD 00498-2004, (see Bibliography).

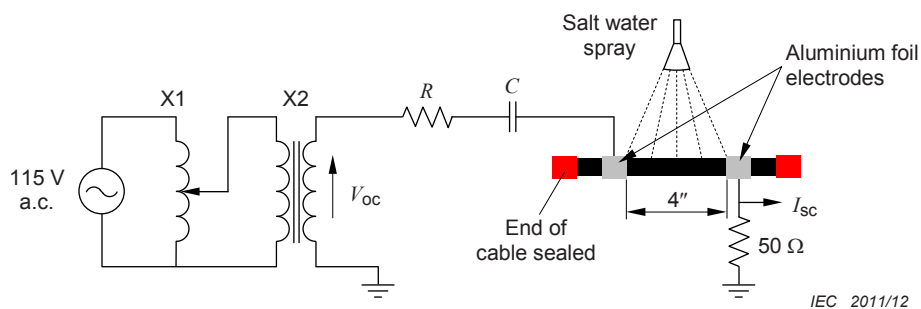

Key

- X1 Autotransformer
- X1 High voltage transformer
- I_{sc} Short circuit current
- R, C Limiting impedance
- V_{oc} Open circuit voltage

Figure C.3 – Electric scheme for the test

C.4.2 Test set up

A 460 mm (18") long cable sample shall be prepared in accordance with Figure C.4. The cable ends are to be sealed. The foil shall be cut into 2 trapezoid shapes, as shown in the diagram below (see Figure C.4), and wrapped around the cable. The foil shall be separated by 100 mm (4 in) and shall be placed near the centre of the sample.

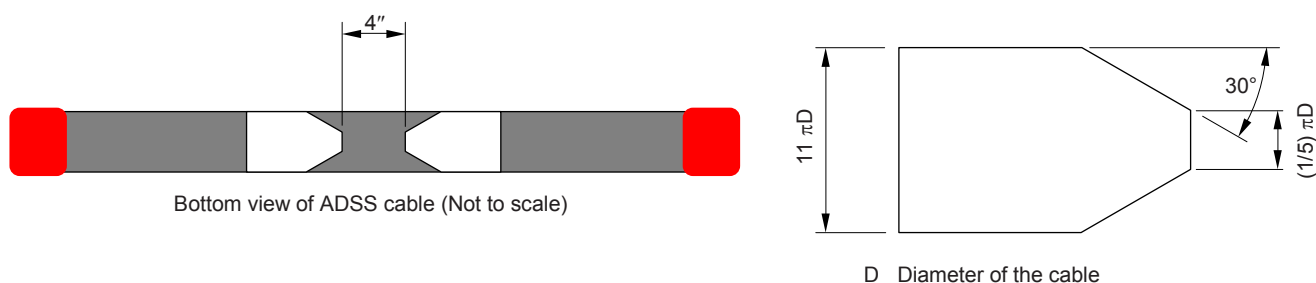

Figure C.4 – Details of the sample

An autotransformer X1 controls the primary voltage of the high voltage transformer X2. Other supply designs are permissible provided the output voltage supplied to the limiting impedance is variable up to 40 kV.

The limiting impedance is denoted by resistor R in series with capacitor C1. This impedance is defined as the ratio of the open circuit voltage of a dry band arc (i.e. arc current extinguished) to the short circuit current of the arc (current in pollution layer just prior to the arc formation). The 50 Ω resistor serves as an AC milliamperemeter.

Multiple samples are permitted provided each sample has a dedicated RC network connected to V_{oc} .

To produce a uniform conductive layer on the cable surface, a nozzle, as shown in Figure C.5, is used. The nozzle consists of a 50 mm × 127 mm stainless steel sheet with 3,6 mm diameter water holes which are arranged in an array to uniformly spray the sample between the electrodes. The cable sample is placed 10 cm below the nozzle.

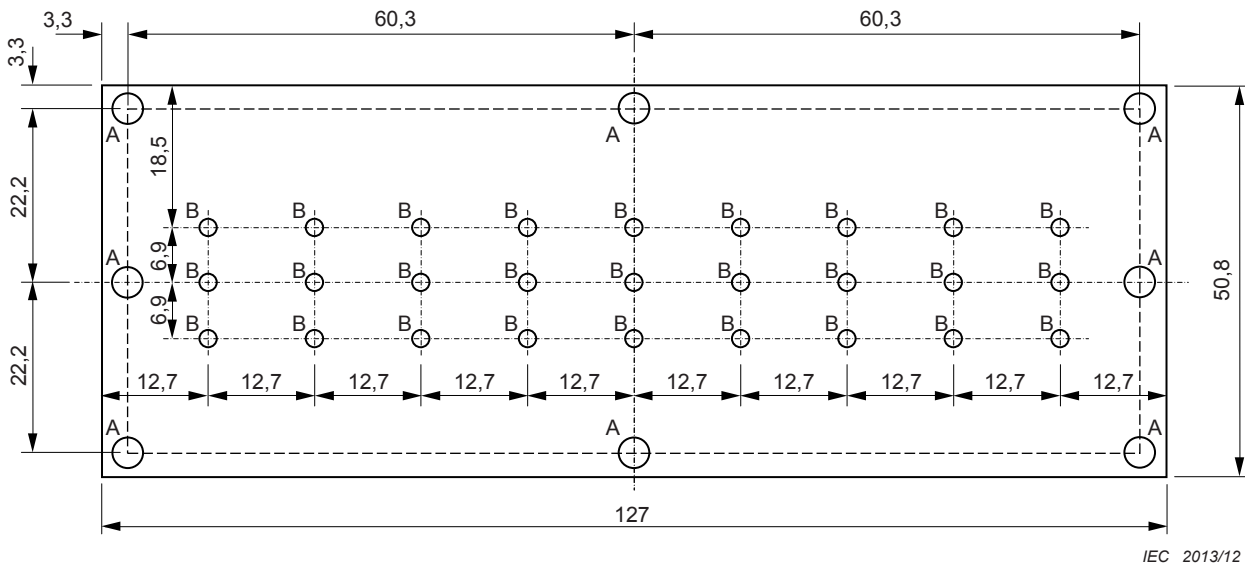

Key

- a) All dimensions in mm.
- b) Material: 0,8 mm thick stainless steel sheet.
- c) All holes marked A have a diameter of 3,6 mm (8 holes).
- d) The water holes are marked B arranged in a 9 × 3 array.
- e) Water holes marked B have a diameter of 1,2 mm.

Figure C.5 – Nozzle

A flow diagram of the pollution delivery system is shown in Figure C.6. Salt water is mixed in a plastic tank or bucket that serves as a storage tank. The pump drives the water through the control valve, filter, flow meter and the rain nozzle. After spraying, it is collected in a stainless steel storage tank and flows back to the reservoir. The flow rate and water salinity are kept constant during the test

Salinity: 1 % (wait 12 h after adding salt to allow the salt to completely dissolve).
Check the salinity every 24 h to assure a salinity of 1 % or greater.

Flow rate: (2 to 3) l/min

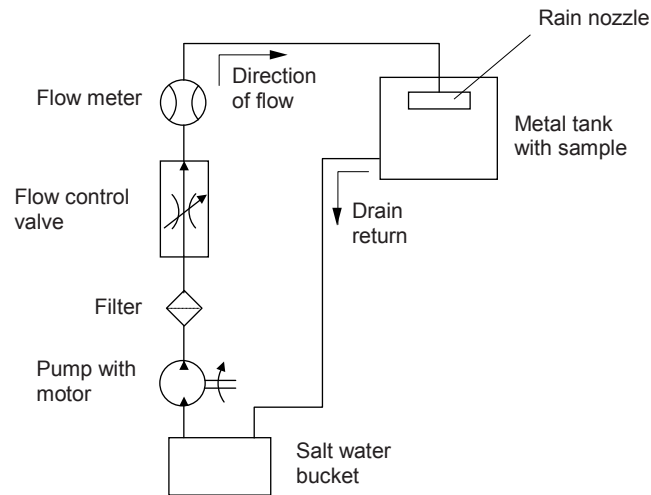

IEC 2014/12

Figure C.6 – Details for the spraying

C.4.3 Test method

The appropriate R_{eq} , C_{eq} , and V_{oc} are chosen. R_{eq} and C_{eq} are chosen to represent the pollution level. V_{oc} is chosen to represent the desired space potential, as shown in Table C.1.

Table C.1 – R_{eq} and C_{eq} values for different pollution index values

PI	Ohms/meter Ω/m	Category	R_{eq} Ω	C_{eq} pF
5	100 000	Heavy	$4,2 \times 10^6$	650
5,3	200 000	Heavy	$5,8 \times 10^6$	457
5,7	500 000	Heavy	$9,2 \times 10^6$	290
6	1 000 000	Medium	$13,1 \times 10^6$	200
6,3	2 000 000	Medium	$18,6 \times 10^6$	145
6,7	5 000 000	Medium	$30,0 \times 10^6$	90
7	10 000 000	Light	$42,0 \times 10^6$	65

The ADSS sample is subjected to repeated cycles of salt spray and drying. The samples are wetted for 2 min and allowed to dry for 13 min. During the drying period, arcing will appear on the sample. The test is performed under normal room temperatures and humidity.

Dry band arcing shall not erode through the cable sheath prior to completing 300 cycles for the appropriate pollution index for the region. Unless a pollution index (PI) for the region can be determined, the customer may need to specify a low pollution index. The suppliers cable shall be capable of completing 300 cycles at less than or equal to the customer's specified pollution index (PI).

C.4.4 Overview of pollution model and electrical test

An overview of a pollution model is detailed in Figure C.7. Allowing the first lumped resistor (connecting V_1 to the grounded tower) to be very large (e.g. $10^{14} \Omega$) and repeating the computation provides the value V_{oc} which is the voltage across a dry band in the wet pollution near the tower. I_0 , from the previous computation, becomes the arc current when the band flashes over.

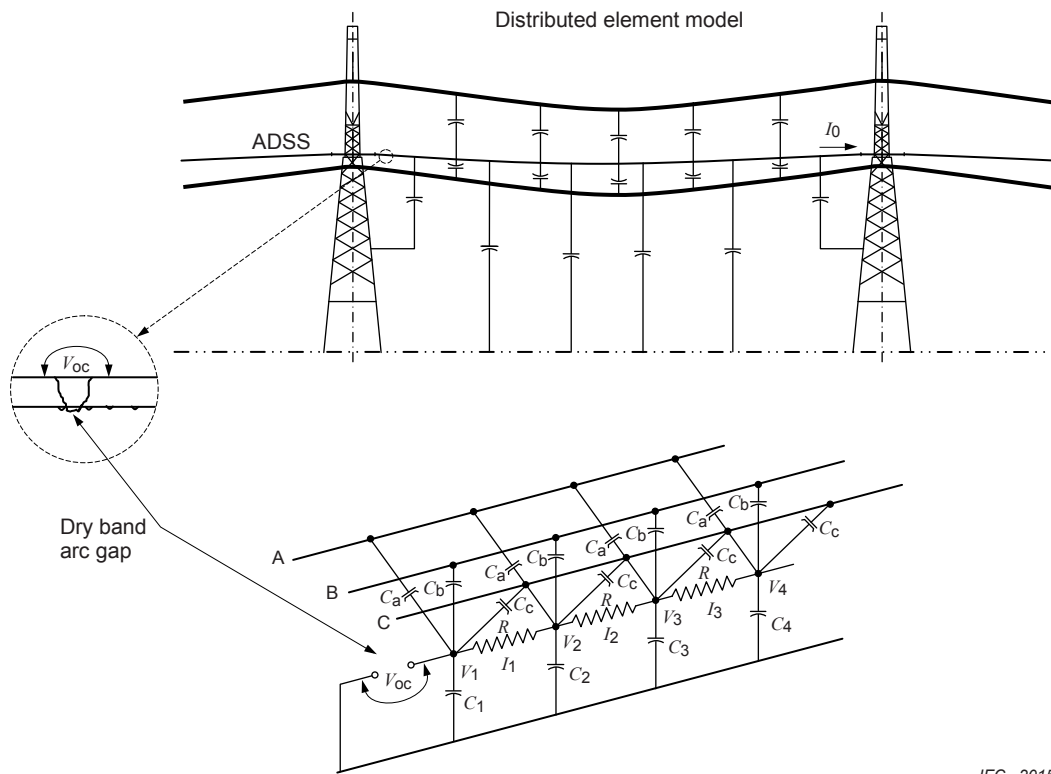

IEC 2015/12

R are the ohms per distance (metres, feet, etc.); represents pollution resistance

Figure C.7 – Pollution model

The entire model can be reduced to an electrical equivalent by dividing V_{oc} by I_0 . A and B are the phase angles of each quantity. This is the basic circuit for the arcing test, see Figure C.8.

$$Z_{eq} = \frac{V_{oc}(A)}{I_0(B)} = \frac{V_{oc}(\cos A) + jV_{oc}(\sin A)}{I_0(\cos B) + jI_0(\sin B)} = R_{eq} - jX$$

$$C_{eq} = \frac{1}{\omega X}$$

$$\omega = 2\pi f$$

$$f = 60 \text{ (Hz)}$$

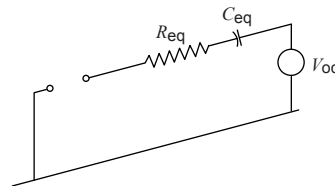

IEC 2016/12

Figure C.8 – Basic circuit for arcing test

Annex D
(informative)

**All Dielectric Self-Supported (ADSS) cables to be used
in overhead power lines (Blank detail specification)**

Table D.1 – Blank detail specification

(1) Prepared by		(2) Document N ^o : Issue : Date :
(3) Available from:	(4) Generic specification: Sectional specification:	IEC 60794-4-20; IEC 60794-1-2X series IEC 60794-4
(5) Additional references:		
(6) Cable description:		
(7) Cable construction:		
<u>Optical fibres</u>		
<u>Range of fibre count</u>		
Modularity		
<u>Construction</u> – Loose tube – filled – Loose tube – unfilled – Slotted core – filled – Slotted core – unfilled – Ribbon in slotted core – Ribbon in loose tube – Central (strength) member – non metallic – Core filling – regular water blocking – Core filling – water swell able materials		Additional remarks
<u>Lay-up</u> – Stranding (helical or SZ) – Single unit		
(7) Cable construction (continued) Inner sheath Peripheral strength member – Non-metallic Moisture Barrier Outer sheath Armouring – Non-metallic armouring Outer protection – Polyethylene sheath – Performance of tracking resistant sheath Marking identification – Customer requirement – Identification of manufacturer		Additional remarks

(8) Application information:	
General	
Maximum outer diameter (d)	mm
Installation load (MIT)	N
Allowed short term load (MAT)	N
Minimum bending radius for no load bending	mm or $n \times d$
Minimum bending radius for rated load bending	mm or $n \times d$
Temperature range:	
– Transport and storage	°C
– Installation	°C
– Operation	°C
Cable weight	kg/km
Manufacturing cable length	
– Typical	m
– Nominal /tolerances	-0 %, +1 %
– Modulus of elasticity	kPa
– Coefficient of linear expansion	$10^{-6}/^{\circ}\text{C}$
– Creep behaviour	mm or %
Particular (cables designed for specific projects)	
– ice thickness	mm
– wind speed	km/h
– Maximum span distance while under the maximum weather load	m
– Minimum sag for maximum span (not exceeding MAT under weather load)	m or %

Bibliography

IEC 60060-1:2010, *High-voltage test techniques – Part 1: General definitions and test requirements*

IEC 60794 (all parts), *Optical fibre cables*

IEC 60794-1-2X (all subparts), *Optical fibre cables – Part 1-2X: Generic specification – Basic optical cable test procedures*

IEC 60794-1-21, *Optical fibre cables – Part 1-21: Generic specification – Basic optical cable test procedures – Mechanical test methods⁴*

IEC 60794-3, *Optical fibre cables – Part 3: Sectional specification – Outdoor cables*

IEC/TR 62362, *Selection of optical fibre cable specifications relative to mechanical, ingress, climatic or electromagnetic characteristics – Guidance*

ISO/IEC 24702, *Information technology – Generic cabling – Industrial premises*

ISO 9001, *Quality management systems – Requirements*

IEEE 1222, *IEEE standard for testing and performance for all-dielectric self-supporting (ADSS) fiber optic cable for use on electric utility power lines*

IEEE TPWRD 00498-2004, *Experimental Verification of the Proposed IEEE Performance and Testing Standard for ADSS Fiber Optic Cable for Use on Electric Utility Power Lines*, Essam Al-Ammar, George G. Karady, Baozhuang Shi and Monty W. Tuominen

⁴ Under consideration.

British Standards Institution (BSI)

BSI is the national body responsible for preparing British Standards and other standards-related publications, information and services.

BSI is incorporated by Royal Charter. British Standards and other standardization products are published by BSI Standards Limited.

About us

We bring together business, industry, government, consumers, innovators and others to shape their combined experience and expertise into standards-based solutions.

The knowledge embodied in our standards has been carefully assembled in a dependable format and refined through our open consultation process. Organizations of all sizes and across all sectors choose standards to help them achieve their goals.

Information on standards

We can provide you with the knowledge that your organization needs to succeed. Find out more about British Standards by visiting our website at bsigroup.com/standards or contacting our Customer Services team or Knowledge Centre.

Buying standards

You can buy and download PDF versions of BSI publications, including British and adopted European and international standards, through our website at bsigroup.com/shop, where hard copies can also be purchased.

If you need international and foreign standards from other Standards Development Organizations, hard copies can be ordered from our Customer Services team.

Subscriptions

Our range of subscription services are designed to make using standards easier for you. For further information on our subscription products go to bsigroup.com/subscriptions.

With **British Standards Online (BSOL)** you'll have instant access to over 55,000 British and adopted European and international standards from your desktop. It's available 24/7 and is refreshed daily so you'll always be up to date.

You can keep in touch with standards developments and receive substantial discounts on the purchase price of standards, both in single copy and subscription format, by becoming a **BSI Subscribing Member**.

PLUS is an updating service exclusive to BSI Subscribing Members. You will automatically receive the latest hard copy of your standards when they're revised or replaced.

To find out more about becoming a BSI Subscribing Member and the benefits of membership, please visit bsigroup.com/shop.

With a **Multi-User Network Licence (MUNL)** you are able to host standards publications on your intranet. Licences can cover as few or as many users as you wish. With updates supplied as soon as they're available, you can be sure your documentation is current. For further information, email bsmusales@bsigroup.com.

BSI Group Headquarters

389 Chiswick High Road London W4 4AL UK

Revisions

Our British Standards and other publications are updated by amendment or revision.

We continually improve the quality of our products and services to benefit your business. If you find an inaccuracy or ambiguity within a British Standard or other BSI publication please inform the Knowledge Centre.

Copyright

All the data, software and documentation set out in all British Standards and other BSI publications are the property of and copyrighted by BSI, or some person or entity that owns copyright in the information used (such as the international standardization bodies) and has formally licensed such information to BSI for commercial publication and use. Except as permitted under the Copyright, Designs and Patents Act 1988 no extract may be reproduced, stored in a retrieval system or transmitted in any form or by any means – electronic, photocopying, recording or otherwise – without prior written permission from BSI. Details and advice can be obtained from the Copyright & Licensing Department.

Useful Contacts:

Customer Services

Tel: +44 845 086 9001

Email (orders): orders@bsigroup.com

Email (enquiries): cservices@bsigroup.com

Subscriptions

Tel: +44 845 086 9001

Email: subscriptions@bsigroup.com

Knowledge Centre

Tel: +44 20 8996 7004

Email: knowledgecentre@bsigroup.com

Copyright & Licensing

Tel: +44 20 8996 7070

Email: copyright@bsigroup.com



...making excellence a habit.™