

Safety of machinery — Electrical equipment of machines —

Part 1: General requirements

ICS 13.110; 31.020; 29.020

National foreword

This British Standard is the UK implementation of EN 60204-1:2006+A1:2009. It is derived from IEC 60204-1:2005, incorporating amendment 1:2008. It supersedes BS EN 60204-1:2006 which is withdrawn.

The start and finish of text introduced or altered by amendment is indicated in the text by tags. Tags indicating changes to IEC text carry the number of the IEC amendment. For example, text altered by IEC amendment 1 is indicated by **A1** **A1**.

The CENELEC common modifications have been implemented at the appropriate places in the text. The start and finish of each common modification is indicated in the text by tags **C** **C**.

The UK participation in its preparation was entrusted to Technical Committee MCE/3, Safeguarding of machinery.

A list of organizations represented on this committee can be obtained on request to its secretary.

This publication does not purport to include all the necessary provisions of a contract. Users are responsible for its correct application.

Compliance with a British Standard cannot confer immunity from legal obligations.

This British Standard was published under the authority of the Standards Policy and Strategy Committee on 30 June 2006

© BSI 2009

ISBN 978 0 580 61903 8

Amendments/corrigenda issued since publication

Date	Comments
30 April 2009	Implementation of IEC amendment 1:2008 with CENELEC endorsement A1:2009

English version

**Safety of machinery –
Electrical equipment of machines
Part 1: General requirements
(IEC 60204-1:2005, modified)**

Sécurité des machines –
Équipement électrique des machines
Partie 1: Règles générales
(CEI 60204-1:2005, modifiée)

Sicherheit von Maschinen –
Elektrische Ausrüstung von Maschinen
Teil 1: Allgemeine Anforderungen
(IEC 60204-1:2005, modifiziert)

This European Standard was approved by CENELEC on 2006-06-01. CENELEC members are bound to comply with the CEN/CENELEC Internal Regulations which stipulate the conditions for giving this European Standard the status of a national standard without any alteration.

Up-to-date lists and bibliographical references concerning such national standards may be obtained on application to the Central Secretariat or to any CENELEC member.

This European Standard exists in three official versions (English, French, German). A version in any other language made by translation under the responsibility of a CENELEC member into its own language and notified to the Central Secretariat has the same status as the official versions.

CENELEC members are the national electrotechnical committees of Austria, Belgium, Cyprus, the Czech Republic, Denmark, Estonia, Finland, France, Germany, Greece, Hungary, Iceland, Ireland, Italy, Latvia, Lithuania, Luxembourg, Malta, the Netherlands, Norway, Poland, Portugal, Romania, Slovakia, Slovenia, Spain, Sweden, Switzerland and the United Kingdom.

CENELEC

European Committee for Electrotechnical Standardization
Comité Européen de Normalisation Electrotechnique
Europäisches Komitee für Elektrotechnische Normung

Central Secretariat: rue de Stassart 35, B - 1050 Brussels

Foreword

The text of the International Standard IEC 60204-1:2005, prepared by IEC TC 44, Safety of machinery – Electrotechnical aspects, together with common modifications prepared by the Technical Committee CENELEC TC 44X, Safety of machinery – Electrotechnical aspects, was approved by CENELEC as EN 60204-1 on 2006-06-01.

This European Standard supersedes EN 60204-1:1997.

The following dates were fixed:

- latest date by which the EN has to be implemented at national level by publication of an identical national standard or by endorsement (dop) 2007-06-01
- latest date by which the national standards conflicting with the EN have to be withdrawn (dow) 2009-06-01

NOTE The application of this standard can involve the selection of components and/or parts that are to be integrated with the electrical equipment of a machine in accordance with the instructions and/or specifications of the manufacturers of the components and/or parts.

Also, in the context of legislative duties that are applicable to machinery manufacturers within the European Union it is important to recognise that the safety of electrical equipment can involve the use of equipment and services provided by other parties (see 3.54).

To assist manufacturers in satisfying these duties it can be necessary for the supplier of the equipment to obtain information about its intended use. This can be facilitated by establishing an agreement between the user and supplier on basic conditions and additional user requirements to enable proper design, application and utilization of the electrical equipment of the machine. An enquiry form that can be used for this purpose is provided in Annex B. Such an agreement is not intended to reduce the level of safety of the electrical equipment provided by this standard.

Endorsement notice

The text of the International Standard IEC 60204-1:2005 was approved by CENELEC as a European Standard with agreed common modifications.

Foreword to amendment A1

The text of document 44/575/CDV, future amendment 1 to IEC 60204-1:2005, prepared by IEC TC 44, Safety of machinery - Electrotechnical aspects, was submitted to the IEC-CENELEC parallel vote and was approved by CENELEC as amendment A1 to EN 60204-1:2006 on 2009-02-01.

The following dates were fixed:

- latest date by which the amendment has to be implemented at national level by publication of an identical national standard or by endorsement (dop) 2009-11-01
- latest date by which the national standards conflicting with the amendment have to be withdrawn (dow) 2012-02-01

Annex ZA has been added by CENELEC.

Endorsement notice

The text of amendment 1:2008 to the International Standard IEC 60204-1:2005 was approved by CENELEC as an amendment to the European Standard without any modification.

CONTENTS

INTRODUCTION	8
1 Scope	10
2 Normative references	11
3 Definitions	13
4 General requirements	20
4.1 General considerations	20
4.2 Selection of equipment	21
4.3 Electrical supply	22
4.4 Physical environment and operating conditions	23
4.5 Transportation and storage	25
4.6 Provisions for handling	25
4.7 Installation	25
5 Incoming supply conductor terminations and devices for disconnecting and switching off	25
5.1 Incoming supply conductor terminations	25
5.2 Terminal for connection to the external protective earthing system	26
5.3 Supply disconnecting (isolating) device	26
5.4 Devices for switching off for prevention of unexpected start-up	29
5.5 Devices for disconnecting electrical equipment	29
5.6 Protection against unauthorized, inadvertent and/or mistaken connection	30
6 Protection against electric shock	30
6.1 General	30
6.2 Protection against direct contact	30
6.3 Protection against indirect contact	33
6.4 Protection by the use of PELV	34
7 Protection of equipment	35
7.1 General	35
7.2 Overcurrent protection	35
7.3 Protection of motors against overheating	38
7.4 Abnormal temperature protection	39
7.5 Protection against supply interruption or voltage reduction and subsequent restoration	39
7.6 Motor overspeed protection	40
7.7 Earth fault/residual current protection	40
7.8 Phase sequence protection	40
7.9 Protection against overvoltages due to lightning and to switching surges	40
8 Equipotential bonding	40
8.1 General	40
8.2 Protective bonding circuit	43
8.3 Functional bonding	46
8.4 Measures to limit the effects of high leakage current	46

9	Control circuits and control functions	46
9.1	Control circuits	46
9.2	Control functions	47
9.3	Protective interlocks	52
9.4	Control functions in the event of failure	53
10	Operator interface and machine-mounted control devices	57
10.1	General	57
10.2	Push-buttons	58
10.3	Indicator lights and displays	60
10.4	Illuminated push-buttons	61
10.5	Rotary control devices	61
10.6	Start devices	61
10.7	Emergency stop devices	61
10.8	Emergency switching off devices	62
10.9	Enabling control device	63
11	Controlgear: location, mounting, and enclosures	63
11.1	General requirements	63
11.2	Location and mounting	63
11.3	Degrees of protection	65
11.4	Enclosures, doors and openings	65
11.5	Access to controlgear	66
12	Conductors and cables	67
12.1	General requirements	67
12.2	Conductors	67
12.3	Insulation	68
12.4	Current-carrying capacity in normal service	68
12.5	Conductor and cable voltage drop	69
12.6	Flexible cables	70
12.7	Conductor wires, conductor bars and slip-ring assemblies	71
13	Wiring practices	73
13.1	Connections and routing	73
13.2	Identification of conductors	74
13.3	Wiring inside enclosures	76
13.4	Wiring outside enclosures	76
13.5	Ducts, connection boxes and other boxes	79
14	Electric motors and associated equipment	81
14.1	General requirements	81
14.2	Motor enclosures	82
14.3	Motor dimensions	82
14.4	Motor mounting and compartments	82
14.5	Criteria for motor selection	82
14.6	Protective devices for mechanical brakes	83
15	Accessories and lighting	83
15.1	Accessories	83
15.2	Local lighting of the machine and equipment	83

16	Marking, warning signs and reference designations	84
16.1	General	84
16.2	Warning signs	85
16.3	Functional identification	85
16.4	Marking of equipment	85
16.5	Reference designations	86
17	Technical documentation	86
17.1	General	86
17.2	Information to be provided	86
17.3	Requirements applicable to all documentation	87
17.4	Installation documents	87
17.5	Overview diagrams and function diagrams	88
17.6	Circuit diagrams	88
17.7	Operating manual	89
17.8	Maintenance manual	89
17.9	Parts list	89
18	Verification	89
18.1	General	89
18.2	Verification of conditions for protection by automatic disconnection of supply	90
18.3	Insulation resistance tests	93
18.4	Voltage tests	94
18.5	Protection against residual voltages	94
18.6	Functional tests	94
18.7	Retesting	94
	Annex A (normative) Protection against indirect contact in TN-systems	95
	Annex B (informative) Enquiry form for the electrical equipment of machines	99
	Annex C (informative) Examples of machines covered by this part of IEC 60204	103
	Annex D (informative) Current-carrying capacity and overcurrent protection of conductors and cables in the electrical equipment of machines	105
	Annex E (informative) Explanation of emergency operation functions	111
	Annex F (informative) Guide for the use of this part of IEC 60204	112
	Annex G (informative) Comparison of typical conductor cross-sectional areas	114
	Annex ZA (normative) Normative references to international publications with their corresponding European publications	116
	Annex ZZ (informative) Coverage of Essential Requirements of EC Directives	120
	Bibliography	121
	Index	123
	Figure 1 – Block diagram of a typical machine	9
	Figure 2 – Example of equipotential bonding for electrical equipment of a machine	42
	Figure 3 – Method a)	56
	Figure 4 – Method b)	56
	Figure A.1 – Typical arrangement for fault loop impedance measurement	98

Figure D.1 – Methods of conductor and cable installation independent of number of conductors/cables.....	106
Figure D.2 – Parameters of conductors and protective devices.....	108
Table 1 – Minimum cross-sectional area of the external protective copper conductor.....	26
Table 2 – Colour-coding for push-button actuators and their meanings.....	59
Table 3 – Symbols for push-buttons.....	59
Table 4 – Colours for indicator lights and their meanings with respect to the condition of the machine.....	60
Table 5 – Minimum cross-sectional areas of copper conductors.....	67
Table 6 – Examples of current-carrying capacity (I_Z) of PVC insulated copper conductors or cables under steady-state conditions in an ambient air temperature of +40 °C for different methods of installation.....	69
Table 7 – Derating factors for cables wound on drums.....	71
Table 8 – Minimum permitted bending radii for the forced guiding of flexible cables.....	78
Table 9 – Application of the test methods for TN-systems.....	92
Table 10 – Examples of maximum cable length from each protective device to its load.....	93
Table A.1 – Maximum disconnecting times for TN systems.....	95
Table D.1 – Correction factors.....	105
Table D.2 – Derating factors from I_Z for grouping.....	107
Table D.3 – Derating factors from I_Z for multicore cables up to 10 mm ²	107
Table D.4 – Classification of conductors.....	108
Table D.5 – Maximum allowable conductor temperatures under normal and short-circuit conditions.....	109
Table F.1 – Application options.....	113
Table G.1 – Comparison of conductor sizes.....	114

INTRODUCTION

This part of IEC 60204 provides requirements and recommendations relating to the electrical equipment of machines so as to promote:

- safety of persons and property;
- consistency of control response;
- ease of maintenance.

More guidance on the use of this part of IEC 60204 is given in Annex F.

Figure 1 has been provided as an aid to the understanding of the inter-relationship of the various elements of a machine and its associated equipment. Figure 1 is a block diagram of a typical machine and associated equipment showing the various elements of the electrical equipment addressed in this part of IEC 60204. Numbers in parentheses () refer to Clauses and Subclauses in this part of IEC 60204. It is understood in Figure 1 that all of the elements taken together including the safeguards, tooling/fixturing, software, and the documentation, constitute the machine, and that one or more machines working together with usually at least one level of supervisory control constitute a manufacturing cell or system.

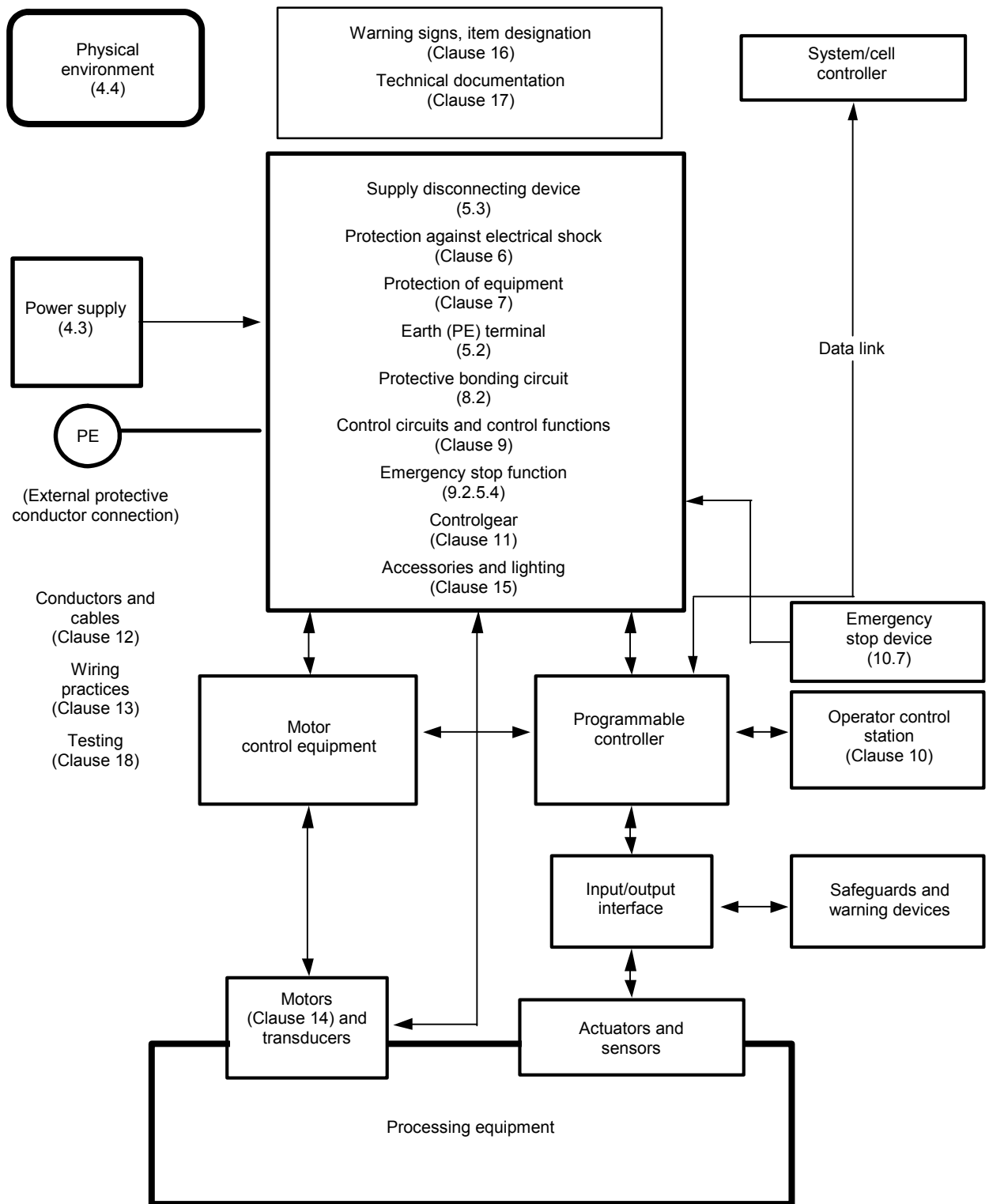

IEC 1388/05

Figure 1 – Block diagram of a typical machine

SAFETY OF MACHINERY – ELECTRICAL EQUIPMENT OF MACHINES –

Part 1: General requirements

1 Scope

This part of IEC 60204 applies to the application of electrical, electronic and programmable electronic equipment and systems to machines not portable by hand while working, including a group of machines working together in a co-ordinated manner.

NOTE 1 This part of IEC 60204 is an application standard and is not intended to limit or inhibit technological advancement.

NOTE 2 In this part of IEC 60204, the term *electrical* includes electrical, electronic and programmable electronic matters (i.e. *electrical equipment* means electrical, electronic and programmable electronic equipment).

NOTE 3 In the context of this part of IEC 60204, the term *person* refers to any individual and includes those persons who are assigned and instructed by the user or his agent(s) in the use and care of the machine in question.

The equipment covered by this part of IEC 60204 commences at the point of connection of the supply to the electrical equipment of the machine (see 5.1).

NOTE 4 The requirements for the electrical supply installation in buildings are given in the IEC 60364 series.

This part of IEC 60204 is applicable to the electrical equipment or parts of the electrical equipment that operate with nominal supply voltages not exceeding 1 000 V for alternating current (a.c.) and not exceeding 1 500 V for direct current (d.c.), and with nominal supply frequencies not exceeding 200 Hz.

NOTE 5 For higher voltages, see IEC 60204-11.

This part of IEC 60204 does not cover all the requirements (for example guarding, interlocking, or control) that are needed or required by other standards or regulations in order to protect persons from hazards other than electrical hazards. Each type of machine has unique requirements to be accommodated to provide adequate safety.

This part specifically includes, but is not limited to, the electrical equipment of machines as defined in 3.35.

NOTE 6 Annex C lists examples of machines whose electrical equipment can be covered by this part of IEC 60204.

Ⓒ This part of EN 60204 does not specify additional and special requirements that can apply to the electrical equipment of machines including those that

- are intended for use in open air (i.e. outside buildings or other protective structures);
- use, process, or produce potentially explosive material (for example paint or sawdust);
- are intended for use in potentially explosive and/or flammable atmospheres;
- have special risks when producing or using certain materials;
- are intended for use in mines;
- are sewing machines, units, and systems;
- are hoisting machines.

NOTE 7 For sewing machines, see EN 60204-31.

NOTE 8 For hoisting machines, see EN 60204-32. Ⓒ

Power circuits where electrical energy is directly used as a working tool are excluded from this part of IEC 60204.

2 Normative references

The following referenced documents are indispensable for the application of this part of IEC 60204. For dated references, only the edition cited applies. For undated references, the latest edition of the referenced document (including any amendments) applies.

IEC 60034-1, *Rotating electrical machines – Part 1: Rating and performance*

IEC 60034-5, *Rotating electrical machines – Part 5: Degrees of protection provided by the integral design of rotating electrical machines (IP code) – Classification*

IEC 60034-11, *Rotating electrical machines – Part 11: Thermal protection*

IEC 60072-1, *Dimensions and output series for rotating electrical machines – Part 1: Frame numbers 56 to 400 and flange numbers 55 to 1 080*

IEC 60072-2, *Dimensions and output series for rotating electrical machines – Part 2: Frame numbers 355 to 1 000 and flange numbers 1 180 to 2 360*

IEC 60073:2002, *Basic and safety principles for man-machine interface, marking and identification – Coding principles for indicators and actuators*

IEC 60309-1:1999, *Plugs, socket-outlets, and couplers for industrial purposes – Part 1: General requirements*

IEC 60364-4-41:2005, *Low-voltage electrical installations – Part 4-41: Protection for safety – Protection against electric shock*

IEC 60364-4-43:2001, *Electrical installations of buildings – Part 4-43: Protection for safety – Protection against overcurrent*

IEC 60364-5-52:2001, *Electrical installations of buildings – Part 5-52: Selection and erection of electrical equipment – Wiring systems*

IEC 60364-5-53:2002, *Electrical installations of buildings – Part 5-53: Selection and erection of electrical equipment – Isolation, switching and control*

IEC 60364-5-54:2002, *Electrical installations of buildings – Part 5-54: Selection and erection of electrical equipment – Earthing arrangements, protective conductors and protective bonding conductors*

IEC 60364-6-61:2001, *Electrical installations of buildings – Part 6-61: Verification – Initial verification*

IEC 60417-DB:2002¹, *Graphical symbols for use on equipment*

¹ “DB” refers to the IEC on-line database.

IEC 60439-1:1999, *Low-voltage switchgear and controlgear assemblies – Part 1: Type-tested and partially type-tested assemblies*

IEC 60445:1999, *Basic and safety principles for man-machine interface, marking and identification – Identification of equipment terminals and of terminations of certain designated conductors, including general rules for an alphanumeric system*

IEC 60446:1999, *Basic and safety principles for man-machine interface, marking and identification – Identification of conductors by colours or numerals*

IEC 60447:2004, *Basic and safety principles for man-machine interface, marking and identification – Man-machine interface (MMI) – Actuating principles*

IEC 60529:1999, *Degrees of protection provided by enclosures (IP Code)*
Amendment 1 (2001)

IEC 60617-DB:2001², *Graphical symbols for diagrams*

IEC 60621-3:1979, *Electrical installations for outdoor sites under heavy conditions (including open-cast mines and quarries) – Part 3: General requirements for equipment and ancillaries*

IEC 60664-1:1992, *Insulation co-ordination for equipment within low-voltage systems – Part 1: Principles, requirements and tests*

IEC 60947-1:2004, *Low-voltage switchgear and controlgear – Part 1: General rules*

IEC 60947-2:2003, *Low-voltage switchgear and controlgear – Part 2: Circuit-breakers*

IEC 60947-3:1999, *Low-voltage switchgear and controlgear – Part 3: Switches, disconnectors, switch-disconnectors, and fuse combination units*

IEC 60947-5-1:2003, *Low-voltage switchgear and controlgear – Part 5-1: Control circuit devices and switching elements – Electromechanical control circuit devices*

IEC 60947-7-1:2002, *Low-voltage switchgear and controlgear – Part 7-1: Ancillary equipment – Terminal blocks for copper conductors*

IEC 61082-1:1991, *Preparation of documents used in electrotechnology – Part 1: General requirements*

IEC 61082-2:1993, *Preparation of documents used in electrotechnology – Part 2: Function-oriented diagrams*

IEC 61082-3:1993, *Preparation of documents used in electrotechnology – Part 3: Connection diagrams, tables and lists*

IEC 61082-4:1996, *Preparation of documents used in electrotechnology – Part 4: Location and installation documents*

IEC 61140:2001, *Protection against electric shock – Common aspects for installation and equipment*

IEC 61310 (all parts), *Safety of machinery – Indication, marking and actuation*

IEC 61346 (all parts), *Industrial systems, installations and equipment and industrial products – Structuring principles and reference designations*

² “DB” refers to the IEC on-line database.

IEC 61557-3:1997, *Electrical safety in low voltage distribution systems up to 1000 V a.c. and 1500 V d.c. – Equipment for testing, measuring or monitoring of protective measures –Part 3: Loop impedance*

IEC 61558-1:1997, *Safety of power transformers, power supply units and similar – Part 1: General requirements and tests*
Amendment 1 (1998)

IEC 61558-2-6, *Safety of power transformers, power supply units and similar – Part 2-6: Particular requirements for safety isolating transformers for general use*

IEC 61984:2001, *Connectors – Safety requirements and tests*

IEC 62023:2000, *Structuring of technical information and documentation*

IEC 62027:2000, *Preparation of parts lists*

IEC 62061:2005, *Safety of machinery – Functional safety of safety-related electrical, electronic and programmable electronic control systems*

IEC 62079:2001, *Preparation of instructions – Structuring, content and presentation*

ISO 7000:2004, *Graphical symbols for use on equipment – Index and synopsis*

ISO 12100-1:2003, *Safety of machinery – Basic concepts, general principles for design – Part 1: Basic terminology, methodology*

ISO 12100-2:2003, *Safety of machinery – Basic concepts, general principles for design – Part 2: Technical principles*

☞ ISO 13849-1:2006, *Safety of machinery – Safety-related parts of control systems – Part 1: General principles for design* ☞

ISO 13849-2:2003, *Safety of machinery – Safety-related parts of control systems – Part 2: Validation*

☞ ISO 13850:2006, *Safety of machinery – Emergency stop – Principles for design* ☞

3 Terms and definitions

For the purposes of this document, the following terms and definitions apply.

3.1

actuator

part of a device to which an external manual action is to be applied

NOTE 1 The actuator may take the form of a handle, knob, push-button, roller, plunger, etc.

NOTE 2 There are some actuating means that do not require an external actuating force, but only an action.

NOTE 3 See also 3.34.

3.2

ambient temperature

temperature of the air or other medium where the equipment is to be used

3.3

barrier

part providing protection against direct contact from any usual direction of access

3.4**cable tray**

cable support consisting of a continuous base and raised edges and no covering

NOTE A cable tray may be perforated or non-perforated.

[IEV 826-15-08]

3.5**cable trunking system**

system of closed enclosures comprising a base with a removable cover intended for the complete surrounding of insulated conductors, cables, cords and for the accommodation of other electrical equipment

3.6**concurrent**

acting in conjunction; used to describe a situation wherein two or more control devices exist in an actuated condition at the same time (but not necessarily synchronously)

3.7**conduit**

part of a closed wiring system of circular or non-circular cross-section for insulated conductors and/or cables in electrical installations, allowing them to be drawn in and/or replaced

NOTE Conduits should be sufficiently close-jointed so that the insulated conductors and/or cables can only be drawn in and not inserted laterally.

[IEV 826-06-03]

3.8**control circuit (of a machine)**

circuit used for the control, including monitoring, of a machine and the electrical equipment

3.9**control device**

device connected into the control circuit and used for controlling the operation of the machine (for example position sensor, manual control switch, relay, contactor, magnetically operated valve)

3.10**controlgear**

switching devices and their combination with associated control, measuring, protective, and regulating equipment, also assemblies of such devices and equipment with associated interconnections, accessories, enclosures, and supporting structures, intended in principle for the control of electrical energy consuming equipment

[IEV 441-11-03, modified]

3.11**controlled stop**

stopping of machine motion with electrical power to the machine actuators maintained during the stopping process

3.12**direct contact**

contact of persons or livestock with live parts

[IEV 826-12-03]

3.13

direct opening action (of a contact element)

achievement of contact separation as the direct result of a specified movement of the switch actuator through non-resilient members (for example not dependent upon springs)

[IEC 60947-5-1, K.2.2]

3.14

duct

enclosed channel designed expressly for holding and protecting electrical conductors, cables, and busbars

NOTE Conduits (see 3.7), cable trunking systems (see 3.5) and underfloor channels are types of duct.

3.15

electrical operating area

room or location for electrical equipment to which access is intended to be restricted to skilled or instructed persons, by the opening of a door or the removal of a barrier without the use of a key or tool, and which is clearly marked by appropriate warning signs

3.16

electronic equipment

part of the electrical equipment containing circuitry dependent for its operation on electronic devices and components

3.17

emergency stop device

manually actuated control device used to initiate an emergency stop function

[ISO 13850, 3.2]

NOTE See Annex E.

3.18

emergency switching off device

manually actuated control device used to switch off the supply of electrical energy to all or a part of an installation where a risk of electric shock or another risk of electrical origin is involved

NOTE See Annex E.

3.19

enclosed electrical operating area

room or location for electrical equipment to which access is intended to be restricted to skilled or instructed persons by the opening of a door or the removal of a barrier by the use of a key or tool and which is clearly marked by appropriate warning signs

3.20**enclosure**

part providing protection of equipment against certain external influences and, in any direction, protection against direct contact

NOTE The definition taken from the existing IEV needs the following explanations within the scope of this part of IEC 60204:

- a) Enclosures provide protection of persons or livestock against access to hazardous parts.
- b) Barriers, shaped openings, or any other means suitable to prevent or limit the penetration of the specified test probes, whether attached to the enclosure or formed by the enclosed equipment, are considered as part of the enclosure, except where they can be removed without the use of a key or tool.
- c) An enclosure may be:
 - a cabinet or box, either mounted on the machine or separate from the machine;
 - a compartment consisting of an enclosed space within the machine structure.

3.21**equipment**

material, fittings, devices, components, appliances, fixtures, apparatus, and the like used as part of, or in connection with, the electrical equipment of machines

3.22**equipotential bonding**

provision of electric connections between conductive parts, intended to achieve equipotentiality

[IEV 195-1-10]

3.23**exposed conductive part**

conductive part of electrical equipment, which can be touched and which is not live under normal operating conditions, but which can become live under fault conditions

[IEV 826-12-10, modified]

3.24**extraneous conductive part**

conductive part not forming part of the electrical installation and liable to introduce a potential, generally the earth potential

[IEV 826-12-11, modified]

3.25**failure**

termination of the ability of an item to perform a required function

NOTE 1 After failure, the item has a fault.

NOTE 2 "Failure" is an event, as distinguished from "fault", which is a state.

NOTE 3 This concept as defined does not apply to items consisting of software only.

[IEV 191-04-01]

NOTE 4 In practice, the terms fault and failure are often used synonymously.

3.26**fault**

state of an item characterized by inability to perform a required function, excluding the inability during preventive maintenance or other planned actions, or due to lack of external resources

NOTE 1 A fault is often the result of a failure of the item itself, but may exist without prior failure.

NOTE 2 In English, the term "fault" and its definition are identical with those given in IEC 60050-191-05-01. In the field of machinery, the French term "défaut" and the German term "Fehler" are used rather than the terms "panne" and "Fehlzustand" that appear with this definition.

3.27

functional bonding

equipotential bonding necessary for proper functioning of electrical equipment

3.28

hazard

potential source of physical injury or damage to health

NOTE 1 The term hazard can be qualified in order to define its origin (for example, mechanical hazard, electrical hazard) or the nature of the potential harm (for example, electric shock hazard, cutting hazard, toxic hazard, fire hazard).

NOTE 2 The hazard envisaged in this definition:

- either is permanently present during the intended use of the machine (for example motion of hazardous moving elements, electric arc during a welding phase, unhealthy posture, noise emission, high temperature);
- or can appear unexpectedly (for example: explosion, crushing hazard as a consequence of an unintended/unexpected start-up, ejection as a consequence of a breakage, fall as a consequence of acceleration/deceleration).

[ISO 12100-1, 3.6, modified]

3.29

indirect contact

contact of persons or livestock with exposed conductive parts which have become live under fault conditions

[IEV 826-12-04, modified]

3.30

inductive power supply system

system of inductive power transfer, consisting of a track converter and a track conductor, along which one or more pick-up(s) and associated pick-up converter(s) can move, without any galvanic or mechanical contact, in order to transfer electrical power for example to a mobile machine

NOTE The track conductor and the pick-up are analogous to the primary and secondary of a transformer respectively.

3.31

(electrically) instructed person

person adequately advised or supervised by an electrically skilled person to enable him or her to perceive risks and to avoid hazards which electricity can create

[IEV 826-18-02, modified]

3.32

interlock (for safeguarding)

arrangement that interconnects guard(s) or device(s) with the control system and/or all or part of the electrical supply to the machine

3.33

live part

conductor or conductive part intended to be energized in normal use, including a neutral conductor, but, by convention, not a PEN conductor

NOTE This term does not necessarily imply a risk of electric shock.

3.34**machine actuator**

power mechanism used to effect motion of the machine

3.35**machinery****machine**

assembly of linked parts or components, at least one of which moves, with the appropriate machine actuators, control and power circuits, joined together for a specific application, in particular for the processing, treatment, moving or packaging of a material.

The term "machinery" also covers an assembly of machines which, in order to achieve the same end, are arranged and controlled so that they function as an integral whole

[ISO 12100-1, 3.1, modified]

NOTE The term "component" is used here in a general sense and it does not refer only to electrical components.

3.36**marking**

signs or inscriptions primarily for the purpose of identifying equipment, components and/or devices, which can include certain features thereof

3.37**neutral conductor****N**

conductor connected to the neutral point of a system and capable of contributing to the transmission of electrical energy

[IEV 826-14-07, modified]

3.38**obstacle**

part preventing unintentional direct contact, but not preventing direct contact by deliberate action

3.39**overcurrent**

current exceeding the rated value. For conductors, the rated value is the current-carrying capacity

[IEV 826-11-14, modified]

3.40**overload (of a circuit)**

time/current relationship in a circuit which is in excess of the rated full load of the circuit when the circuit is not under a fault condition

NOTE *Overload* should not be used as a synonym for *overcurrent*.

3.41**plug/socket combination**

component and a suitable mating component, appropriate to terminate conductors, intended for connection or disconnection of two or more conductors

NOTE Examples of plug/socket combination include:

- connectors which fulfil the requirements of IEC 61984;
- a plug and socket-outlet, a cable coupler, or an appliance coupler in accordance with IEC 60309-1;
- a plug and socket-outlet in accordance with IEC 60884-1 or an appliance coupler in accordance with IEC 60320-1.

3.42

power circuit

circuit that supplies power from the supply network to units of equipment used for productive operation and to transformers supplying control circuits

3.43

protective bonding

equipotential bonding for protection against electric shock

NOTE Measures for protection against electric shock can also reduce the risk of burns or fire.

3.44

protective bonding circuit

protective conductors and conductive parts connected together to provide protection against electric shock in the event of an insulation failure

3.45

protective conductor

conductor required for protective bonding by some measures for protection against electric shock for electrically connecting any of the following parts:

- exposed conductive parts;
- extraneous conductive parts;
- main earthing terminal (PE)

[IEV 826-13-22, modified]

3.46

redundancy

application of more than one device or system, or part of a device or system, with the objective of ensuring that in the event of one failing to perform its function, another is available to perform that function

3.47

reference designation

distinctive code which serves to identify an object in the documentation and on the equipment

NOTE ???

3.48

risk

combination of the probability of occurrence of harm (i.e. physical injury or damage to health) and the severity of that harm

[ISO 12100-1, 3.11, modified]

3.49

safeguard

guard or protective device provided as a means to protect persons from a hazard

3.50

safeguarding

protective measure using safeguards to protect persons from the hazards which cannot reasonably be eliminated or from the risks which cannot be sufficiently reduced by inherently safe design measures

[ISO 12100-1, 3.20]

3.51**servicing level**

level on which persons stand when operating or maintaining the electrical equipment

3.52**short-circuit current**

overcurrent resulting from a short circuit due to a fault or an incorrect connection in an electric circuit

[IEV 441-11-07]

3.53**(electrically) skilled person**

person with relevant training, education and experience to enable him or her to perceive risks and to avoid hazards associated with electricity

[IEV 826-18-01, modified]

3.54**supplier**

entity (for example manufacturer, contractor, installer, integrator) who provides equipment or services associated with the machine

NOTE The user organization may also act in the capacity of a supplier to itself.

3.55**switching device**

device designed to make and/or break the current in one or more electric circuits

[IEV 441-14-01, modified]

NOTE A switching device may perform one or both of these actions.

3.56**uncontrolled stop**

stopping of machine motion by removing electrical power to the machine actuators

[C] NOTE This definition does not imply any particular state of other (for example, non-electrical) stopping devices, for example mechanical or hydraulic brakes that are outside the scope of this standard. **[C]**

3.57**user**

entity who utilizes the machine and its associated electrical equipment

4 General requirements

4.1 General

This part of IEC 60204 is intended to apply to electrical equipment used with a wide variety of machines and with a group of machines working together in a co-ordinated manner.

The risks associated with the hazards relevant to the electrical equipment shall be assessed as part of the overall requirements for risk assessment of the machine. This will determine the adequate risk reduction, and the necessary protective measures for persons who can be exposed to those hazards, while still maintaining an acceptable level of performance of the machine and its equipment.

Hazardous situations can result from, but are not limited to, the following causes:

- failures or faults in the electrical equipment resulting in the possibility of electric shock or electrical fire;
- failures or faults in control circuits (or components and devices associated with those circuits) resulting in the malfunctioning of the machine;
- disturbances or disruptions in power sources as well as failures or faults in the power circuits resulting in the malfunctioning of the machine;
- loss of continuity of circuits that depend upon sliding or rolling contacts, resulting in a failure of a safety function;
- electrical disturbances for example, electromagnetic, electrostatic either from outside the electrical equipment or internally generated, resulting in the malfunctioning of the machine;
- release of stored energy (either electrical or mechanical) resulting in, for example, electric shock, unexpected movement that can cause injury;
- C *Text deleted* C
- surface temperatures that can cause injury.

Safety measures are a combination of the measures incorporated at the design stage and those measures required to be implemented by the user.

The design and development process shall identify hazards and the risks arising from them. Where the hazards cannot be removed and/or the risks cannot be sufficiently reduced by inherently safe design measures, protective measures (for example safeguarding,) shall be provided to reduce the risk. Additional means (for example, awareness means) shall be provided where further risk reduction is necessary. In addition, working procedures that reduce risk can be necessary.

The use of the enquiry form as shown in Annex B of this part of IEC 60204 is recommended in order to facilitate an appropriate agreement between the user and the supplier(s) on basic conditions and additional user specifications related to the electrical equipment. Those additional specifications are to:

- provide additional features that are dependent on the type of machine (or group of machines) and the application;
- facilitate maintenance and repair; and
- improve the reliability and ease of operation.

4.2 Selection of equipment

4.2.1 General

Electrical components and devices shall:

- be suitable for their intended use; and
- conform to relevant IEC standards where such exist; and
- be applied in accordance with the supplier's instructions.

4.2.2 Electrical equipment in compliance with the EN 60439 series

The electrical equipment of the machine shall satisfy the safety requirements identified by the risk assessment of the machine. Depending upon the machine, its intended use and its electrical equipment, the designer may select parts of the electrical equipment of the machine that are in compliance with EN 60439-1 and, as necessary, other relevant parts of the EN 60439 series (see also Annex F). 

4.3 Electrical supply

4.3.1 General

The electrical equipment shall be designed to operate correctly with the conditions of the supply:

- as specified in 4.3.2 or 4.3.3, or
- as otherwise specified by the user (see Annex B), or
- as specified by the supplier in the case of a special source of supply such as an on-board generator.

4.3.2 AC supplies

Voltage	Steady state voltage: 0,9 to 1,1 of nominal voltage.
Frequency	0,99 to 1,01 of nominal frequency continuously; 0,98 to 1,02 short time.
Harmonics	Harmonic distortion not exceeding 10 % of the total r.m.s. voltage between live conductors for the sum of the 2 nd through to the 5 th harmonic. An additional 2 % of the total r.m.s. voltage between live conductors for the sum of the 6 th through to the 30 th harmonic is permissible.
Voltage unbalance	Neither the voltage of the negative sequence component nor the voltage of the zero sequence component in three-phase supplies exceeding 2 % of the positive sequence component.
Voltage interruption	Supply interrupted or at zero voltage for not more than 3 ms at any random time in the supply cycle with more than 1 s between successive interruptions.
Voltage dips	Voltage dips not exceeding 20 % of the peak voltage of the supply for more than one cycle with more than 1 s between successive dips.

4.3.3 DC supplies

From batteries:

Voltage	0,85 to 1,15 of nominal voltage; 0,7 to 1,2 of nominal voltage in the case of battery-operated vehicles.
Voltage interruption	Not exceeding 5 ms.

From converting equipment:

Voltage	0,9 to 1,1 of nominal voltage.
Voltage interruption	Not exceeding 20 ms with more than 1 s between successive interruptions.

NOTE This is a variation to IEC Guide 106 to ensure proper operation of electronic equipment.

Ripple (peak-to-peak) Not exceeding 0,15 of nominal voltage.

4.3.4 Special supply systems

For special supply systems such as on-board generators, the limits given in 4.3.2 and 4.3.3 may be exceeded provided that the equipment is designed to operate correctly with those conditions.

4.4 Physical environment and operating conditions

4.4.1 General

☐ The electrical equipment shall be suitable for the physical environment and operating conditions of its intended use. The requirements of 4.4.2 to 4.4.8 cover the physical environment and operating conditions of the majority of machines covered by this part of EN 60204. When special conditions apply or the limits specified are exceeded, an agreement between user and supplier (see 4.1) is recommended (see Annex B). ☐

4.4.2 Electromagnetic compatibility (EMC)

The equipment shall not generate electromagnetic disturbances above levels that are appropriate for its intended operating environment. In addition, the equipment shall have a level of immunity to electromagnetic disturbances so that it can function in its intended environment.

NOTE 1 The generic EMC standards IEC 61000-6-1 or IEC 61000-6-2 and CISPR 61000-6-3 or IEC 61000-6-4 give general EMC emission and immunity limits.

NOTE 2 IEC 61000-5-2 gives guidelines for earthing and cabling of electrical and electronic systems aimed at ensuring EMC. If specific product standards exist (for example, IEC 61496-1, IEC 61800-3, IEC 60947-5-2) they take precedence over generic standards.

Measures to limit the generation of electromagnetic disturbances, i.e. conducted and radiated emissions include:

- power supply filtering;
- cable shielding;
- enclosures designed to minimize RF radiation;
- RF suppression techniques.

Measures to enhance the immunity of the equipment against conducted and radiated RF disturbance include:

- design of functional bonding system taking into account the following;
 - connection of sensitive electrical circuits to the chassis. Such terminations should be marked or labelled with the symbol IEC 60417-5020 (DB:2002-10):



- connection of the chassis to earth (PE) using a conductor with low RF impedance and as short as practicable;
- connection of sensitive electrical equipment or circuits directly to the PE circuit or to a functional earthing conductor (FE) (see Figure 2), to minimize common mode disturbance. This latter terminal should be marked or labelled by the symbol IEC 60417-5018 (DB:2002-10):



- separation of sensitive circuits from disturbance sources;
- enclosures designed to minimize RF transmission;
- EMC wiring practices:
 - using twisted conductors to reduce the effect of differential mode disturbances,
 - keeping sufficient distance between conductors emitting disturbances and conductors of sensitive circuits,
 - using cable orientation as close to 90° as possible when cables cross,
 - running the conductors as close as possible to the ground plane,
 - using electrostatic screens and/or electromagnetic shields with a low RF impedance termination.

4.4.3 Ambient air temperature

☐ Electrical equipment shall be capable of operating correctly in the intended ambient air temperature. The minimum requirement for all electrical equipment is correct operation between air temperatures of +5 °C and +40 °C. For very hot environments (for example hot climates, steel mills, paper mills) and for cold environments, additional measures are recommended (see Annex B). ☐

4.4.4 Humidity

The electrical equipment shall be capable of operating correctly when the relative humidity does not exceed 50 % at a maximum temperature of +40 °C. Higher relative humidities are permitted at lower temperatures (for example 90 % at 20 °C).

Harmful effects of occasional condensation shall be avoided by design of the equipment or, where necessary, by additional measures (for example built-in heaters, air conditioners, drain holes).

4.4.5 Altitude

Electrical equipment shall be capable of operating correctly at altitudes up to 1 000 m above mean sea level.

4.4.6 Contaminants

Electrical equipment shall be adequately protected against the ingress of solids and liquids (see 11.3).

The electrical equipment shall be adequately protected against contaminants (for example dust, acids, corrosive gases, salts) that can be present in the physical environment in which the electrical equipment is to be installed (see Annex B).

4.4.7 Ionizing and non-ionizing radiation

☐ When equipment is subject to radiation (for example microwave, ultraviolet, lasers, X-rays), additional measures shall be taken to avoid malfunctioning of the equipment and accelerated deterioration of the insulation. A special agreement is recommended between the supplier and the user (see Annex B). ☐

4.4.8 Vibration, shock, and bump

☐ Undesirable effects of vibration, shock and bump (including those generated by the machine and its associated equipment and those created by the physical environment) shall be avoided by the selection of suitable equipment, by mounting it away from the machine, or by provision of anti-vibration mountings. A special agreement is recommended between the supplier and the user (see Annex B). ☐

4.5 Transportation and storage

Electrical equipment shall be designed to withstand, or suitable precautions shall be taken to protect against, the effects of transportation and storage temperatures within a range of $-25\text{ }^{\circ}\text{C}$ to $+55\text{ }^{\circ}\text{C}$ and for short periods not exceeding 24 h at up to $+70\text{ }^{\circ}\text{C}$. Suitable means shall be provided to prevent damage from humidity, vibration, and shock. A special agreement can be necessary between the supplier and the user (see Annex B).

NOTE Electrical equipment susceptible to damage at low temperatures includes PVC insulated cables.

4.6 Provisions for handling

Heavy and bulky electrical equipment that has to be removed from the machine for transport, or that is independent of the machine, shall be provided with suitable means for handling by cranes or similar equipment.

4.7 Installation

Electrical equipment shall be installed in accordance with the electrical equipment supplier's instructions.

5 Incoming supply conductor terminations and devices for disconnecting and switching off

5.1 Incoming supply conductor terminations

It is recommended that, where practicable, the electrical equipment of a machine is connected to a single incoming supply. Where another supply is necessary for certain parts of the equipment (for example, electronic equipment that operates at a different voltage), that supply should be derived, as far as is practicable, from devices (for example, transformers, converters) forming part of the electrical equipment of the machine. For large complex machinery comprising a number of widely-spaced machines working together in a co-ordinated manner, there can be a need for more than one incoming supply depending upon the site supply arrangements (see 5.3.1).

Unless a plug is provided with the machine for the connection to the supply (see 5.3.2 e), it is recommended that the supply conductors are terminated at the supply disconnecting device.

Where a neutral conductor is used it shall be clearly indicated in the technical documentation of the machine, such as in the installation diagram and in the circuit diagram, and a separate insulated terminal, labelled **N** in accordance with 16.1, shall be provided for the neutral conductor (see also Annex B).

There shall be no connection between the neutral conductor and the protective bonding circuit inside the electrical equipment nor shall a combined PEN terminal be provided.

Exception: a connection may be made between the neutral terminal and the PE terminal at the point of the connection of the power supply to the machine for TN-C systems.

All terminals for the incoming supply connection shall be clearly identified in accordance with IEC 60445 and 16.1. For the identification of the external protective conductor terminal, see 5.2.

Ⓒ See 17.8 for the provision of instructions for maintenance. Ⓒ

5.2 Terminal for connection to the external protective earthing system

For each incoming supply, a terminal shall be provided in the vicinity of the associated phase conductor terminals for connection of the machine to the external protective earthing system or to the external protective conductor, depending upon the supply distribution system.

The terminal shall be of such a size as to enable the connection of an external protective copper conductor with a cross-sectional area in accordance with Table 1.

Table 1 – Minimum cross-sectional area of the external protective copper conductor

Cross-sectional area of copper phase conductors supplying the equipment $S \text{ mm}^2$	Minimum cross-sectional area of the external protective copper conductor $S_p \text{ mm}^2$
$S \leq 16$	S
$16 < S \leq 35$	16
$S > 35$	$S/2$

Where an external protective conductor of a material other than copper is used, the terminal size shall be selected accordingly (see also 8.2.2).

At each incoming supply point, the terminal for connection of the external protective earthing system or the external protective conductor shall be marked or labelled with the letters **PE** (see IEC 60445).

5.3 Supply disconnecting (isolating) device

5.3.1 General

A supply disconnecting device shall be provided:

- for each incoming source of supply to a machine(s);

NOTE The incoming supply can be connected directly to the machine or via a feeder system. Feeder systems of machines can include conductor wires, conductor bars, slip-ring assemblies, flexible cable systems (reeled, festooned) or inductive power supply systems.

- for each on-board power supply.

The supply disconnecting device shall disconnect (isolate) the electrical equipment of the machine from the supply when required (for example for work on the machine, including the electrical equipment).

When two or more supply disconnecting devices are provided, protective interlocks for their correct operation shall also be provided in order to prevent a hazardous situation, including damage to the machine or to the work in progress.

5.3.2 Type

The supply disconnecting device shall be one of the following types:

- a) switch-disconnector, with or without fuses, in accordance with IEC 60947-3, utilization category AC-23B or DC-23B;
- b) disconnector, with or without fuses, in accordance with IEC 60947-3, that has an auxiliary contact that in all cases causes switching devices to break the load circuit before the opening of the main contacts of the disconnector;
- c) a circuit-breaker suitable for isolation in accordance with IEC 60947-2;
- d) any other switching device in accordance with an IEC product standard for that device and which meets the isolation requirements of IEC 60947-1 as well as a utilization category defined in the product standard as appropriate for on-load switching of motors or other inductive loads;
- e) a plug/socket combination for a flexible cable supply.

5.3.3 Requirements

When the supply disconnecting device is one of the types specified in 5.3.2 a) to d) it shall fulfil all of the following requirements:

- isolate the electrical equipment from the supply and have one OFF (isolated) and one ON position marked with "O" and "I" (symbols IEC 60417-5008 (DB:2002-10) and IEC 60417-5007 (DB:2002-10), see 10.2.2);
- have a visible contact gap or a position indicator which cannot indicate OFF (isolated) until all contacts are actually open and the requirements for the isolating function have been satisfied;
- have an external operating means (for example handle), (**exception:** power-operated switchgear need not be operable from outside the enclosure where there are other means to open it). Where the external operating means is not intended for emergency operations, it is recommended that it be coloured BLACK or GREY (see 10.7.4 and 10.8.4);
- be provided with a means permitting it to be locked in the OFF (isolated) position (for example by padlocks). When so locked, remote as well as local closing shall be prevented;
- disconnect all live conductors of its power supply circuit. However, for TN supply systems, the neutral conductor may or may not be disconnected except in countries where disconnection of the neutral conductor (when used) is compulsory;
- have a breaking capacity sufficient to interrupt the current of the largest motor when stalled together with the sum of the normal running currents of all other motors and/or loads. The calculated breaking capacity may be reduced by the use of a proven diversity factor.

When the supply disconnecting device is a plug/socket combination, it shall fulfil the following requirements:

- have the switching capability, or be interlocked with a switching device that has a breaking capacity, sufficient to interrupt the current of the largest motor when stalled together with the sum of the normal running currents of all other motors and/or loads. The calculated breaking capacity may be reduced by the use of a proven diversity factor. When the interlocked switching device is electrically operated (for example a contactor) it shall have an appropriate utilisation category.
- a) to f) of 13.4.5.

NOTE A suitably rated plug and socket-outlet, cable coupler, or appliance coupler, in accordance with IEC 60309-1 can fulfil these requirements.

Where the supply disconnecting device is a plug/socket combination, a switching device with an appropriate utilisation category shall be provided for switching the machine on and off. This can be achieved by the use of the interlocked switching device described above.

5.3.4 Operating means

The operating means (for example, a handle) of the supply disconnecting device shall be easily accessible and located between 0,6 m and 1,9 m above the servicing level. An upper limit of 1,7 m is recommended.

NOTE The direction of operation is given in IEC 61310-3.

5.3.5 Excepted circuits

The following circuits need not be disconnected by the supply disconnecting device:

- lighting circuits for lighting needed during maintenance or repair;
- plug and socket outlets for the exclusive connection of repair or maintenance tools and equipment (for example hand drills, test equipment);
- undervoltage protection circuits that are only provided for automatic tripping in the event of supply failure;
- circuits supplying equipment that should normally remain energized for correct operation (for example temperature controlled measuring devices, product (work in progress) heaters, program storage devices);
- control circuits for interlocking.

It is recommended, however, that such circuits be provided with their own disconnecting device.

Where such a circuit is not disconnected by the supply disconnecting device:

- permanent warning label(s) in accordance with 16.1 shall be appropriately placed in proximity to the supply disconnecting device;
- a corresponding statement shall be included in the maintenance manual, and one or more of the following shall apply;
 - a permanent warning label in accordance with 16.1 is affixed in proximity to each excepted circuit, or
 - the excepted circuit is separated from other circuits, or
 - the conductors are identified by colour taking into account the recommendation of 13.2.4.

5.4 Devices for switching off for prevention of unexpected start-up

Devices for switching off for the prevention of unexpected start-up shall be provided (for example where, during maintenance, a start-up of the machine or part of the machine can create a hazard).

Such devices shall be appropriate and convenient for the intended use, shall be suitably placed, and readily identifiable as to their function and purpose (for example by a durable marking in accordance with 16.1 where necessary).

NOTE 1 This part of IEC 60204 does not address all provisions for prevention of unexpected start up. See ISO 14118 (EN 1037).

Means shall be provided to prevent inadvertent and/or mistaken closure of these devices either at the controller or from other locations (see also 5.6).

NOTE 2 Further information on the location and actuation of devices such as those used for the prevention of unexpected start-up is provided in EN 60447. 

The following devices that fulfil the isolation function may be provided for this purpose:

- devices described in 5.3.2,
- disconnectors, withdrawable fuse links and withdrawable links only if located in an enclosed electrical operating area (see 3.19).

Devices that do not fulfil the isolation function (for example a contactor switched off by a control circuit) may only be provided where intended to be used for situations that include:

- inspections;
- adjustments;
- work on the electrical equipment where:
 - there is no hazard arising from electric shock (see Clause 6) and burn;
 - the switching off means remains effective throughout the work;
 - the work is of a minor nature (for example replacement of plug-in devices without disturbing existing wiring).

NOTE 3 The selection of a device should take into account, for example, information derived from the risk assessment, intended use and foreseeable misuse of the device. For example, the use of disconnectors, withdrawable fuse links or withdrawable links located in enclosed electrical operating areas can be inappropriate for use by cleaners (see 17.2 b)12)). 

5.5 Devices for disconnecting electrical equipment

Devices shall be provided for disconnecting (isolating) electrical equipment to enable work to be carried out when it is de-energised and isolated. Such devices shall be:

- appropriate and convenient for the intended use;
- suitably placed;
- readily identifiable as to which part(s) or circuit(s) of the equipment is served (for example by durable marking in accordance with 16.1 where necessary).

Means shall be provided to prevent inadvertent and/or mistaken closure of these devices either at the controller or from other locations (see also 5.6).

The supply disconnecting device (see 5.3) may, in some cases, fulfil that function. However, where it is necessary to work on individual parts of the electrical equipment of a machine, or on one of a number of machines fed by a common conductor bar, conductor wire or inductive power supply system, a disconnecting device shall be provided for each part, or for each machine, requiring separate isolation.

In addition to the supply disconnecting device, the following devices that fulfil the isolation function may be provided for this purpose:

- devices described in 5.3.2;
- disconnectors, withdrawable fuse links and withdrawable links only if located in an electrical operating area (see 3.15) and relevant information is provided with the electrical equipment (see 17.2 b)9) and b)12)).

NOTE Where protection against electric shock is provided in accordance with 6.2.2 c), withdrawable fuse links or withdrawable links for this purpose are intended for use by skilled or instructed persons.

5.6 Protection against unauthorized, inadvertent and/or mistaken connection

The devices described in 5.4 and 5.5 that are located outside an enclosed electrical operating area shall be equipped with means to secure them in the OFF position (disconnected state), (for example by provisions for padlocking, trapped key interlocking). When so secured, remote as well as local reconnection shall be prevented.

Where a non-lockable disconnecting device (for example withdrawable fuse-links, withdrawable links) other means of protection against reconnection (for example warning labels in accordance with 16.1) may be provided.

However, when a plug/socket combination according to 5.3.2 e) is so positioned that it can be kept under the immediate supervision of the person carrying out the work, means for securing in the disconnected state need not be provided.

6 Protection against electric shock

6.1 General

The electrical equipment shall provide protection of persons against electric shock from:

- direct contact (see 6.2 and 6.4);
- indirect contact (see 6.3 and 6.4).

The measures for this protection given in 6.2, 6.3, and, for PELV, in 6.4, are a recommended selection from IEC 60364-4-41. Where those recommended measures are not practicable, for example due to the physical or operational conditions, other measures from IEC 60364-4-41 may be used.

6.2 Protection against direct contact

6.2.1 General

For each circuit or part of the electrical equipment, the measures of either 6.2.2 or 6.2.3 and, where applicable, 6.2.4 shall be applied.

Exception: where those measures are not appropriate, other measures for protection against direct contact (for example by using barriers, by placing out of reach, using obstacles, using construction or installation techniques that prevent access) as defined in IEC 60364-4-41 may be applied (see 6.2.5 and 6.2.6).

When the equipment is located in places open to all persons, which can include children, measures of either 6.2.2 with a minimum degree of protection against direct contact corresponding to IP4X or IPXXD (see IEC 60529), or 6.2.3 shall be applied.

6.2.2 Protection by enclosures

Live parts shall be located inside enclosures that conform to the relevant requirements of Clauses 4, 11, and 14 and that provide protection against direct contact of at least IP2X or IPXXB (see IEC 60529).

Where the top surfaces of the enclosure are readily accessible, the minimum degree of protection against direct contact provided by the top surfaces shall be IP4X or IPXXD.

Opening an enclosure (i.e. opening doors, lids, covers, and the like) shall be possible only under one of the following conditions:

- a) The use of a key or tool is necessary for access. For enclosed electrical operating areas, see IEC 60364-4-41, or IEC 60439-1 as appropriate.

NOTE 1 The use of a key or tool is intended to restrict access to skilled or instructed persons (see 17.2 b)12)).

All live parts, that are likely to be touched when resetting or adjusting devices intended for such operations while the equipment is still connected, shall be protected against direct contact to at least IP2X or IPXXB. Other live parts on the inside of doors shall be protected against direct contact to at least IP1X or IPXXA.

- b) The disconnection of live parts inside the enclosure before the enclosure can be opened. This may be accomplished by interlocking the door with a disconnecting device (for example, the supply disconnecting device) so that the door can only be opened when the disconnecting device is open and so that the disconnecting device can only be closed when the door is closed.

Exception: a special device or tool as prescribed by the supplier can be used to defeat the interlock provided that:

- it is possible at all times while the interlock is defeated to open the disconnecting device and lock the disconnecting device in the OFF (isolated) position or otherwise prevent unauthorised closure of the disconnecting device;
- upon closing the door, the interlock is automatically restored;
- all live parts, that are likely to be touched when resetting or adjusting devices intended for such operations while the equipment is still connected, are protected against direct contact to at least IP2X or IPXXB and other live parts on the inside of doors are protected against direct contact to at least IP1X or IPXXA;
- relevant information is provided with the electrical equipment (see 17.2 b)9) and b)12)).

NOTE 2 The special device or tool is intended for use only by skilled or instructed persons (see 17.2 b)12)).

Means shall be provided to restrict access to live parts behind doors not directly interlocked with the disconnecting means to skilled or instructed persons. (See 17.2 b)12)).

All parts that are still live after switching off the disconnecting device(s) (see 5.3.5) shall be protected against direct contact to at least IP2X or IPXXB (see IEC 60529). Such parts shall be marked with a warning sign in accordance with 16.2.1 (see also 13.2.4 for identification of conductors by colour).

Excepted from this requirement for marking are:

- parts that can be live only because of connection to interlocking circuits and that are distinguished by colour as potentially live in accordance with 13.2.4;
- the supply terminals of the supply disconnecting device when the latter is mounted alone in a separate enclosure.

- c) Opening without the use of a key or a tool and without disconnection of live parts shall be possible only when all live parts are protected against direct contact to at least IP2X or IPXXB (see IEC 60529). Where barriers provide this protection, either they shall require a tool for their removal or all live parts protected by them shall be automatically disconnected when the barrier is removed.

NOTE 3 Where protection against direct contact is achieved in accordance with 6.2.2 c), and a hazard can be caused by manual actuation of devices (for example manual closing of contactors or relays), such actuation should be prevented by barriers or obstacles that require a tool for their removal.

6.2.3 Protection by insulation of live parts

Live parts protected by insulation shall be completely covered with insulation that can only be removed by destruction. Such insulation shall be capable of withstanding the mechanical, chemical, electrical, and thermal stresses to which it can be subjected under normal operating conditions.

NOTE Paints, varnishes, lacquers, and similar products alone are generally considered to be inadequate for protection against electric shock under normal operating conditions.

6.2.4 Protection against residual voltages

Live parts having a residual voltage greater than 60 V after the supply has been disconnected shall be discharged to 60 V or less within a time period of 5 s after disconnection of the supply voltage provided that this rate of discharge does not interfere with the proper functioning of the equipment. Exempted from this requirement are components having a stored charge of 60 μC or less. Where this specified rate of discharge would interfere with the proper functioning of the equipment, a durable warning notice drawing attention to the hazard and stating the delay required before the enclosure may be opened shall be displayed at an easily visible location on or immediately adjacent to the enclosure containing the capacitances.

In the case of plugs or similar devices, the withdrawal of which results in the exposure of conductors (for example pins), the discharge time shall not exceed 1 s, otherwise such conductors shall be protected against direct contact to at least IP2X or IPXXB. If neither a discharge time of 1 s nor a protection of at least IP2X or IPXXB can be achieved (for example in the case of removable collectors on conductor wires, conductor bars, or slip-ring assemblies, see 12.7.4), additional switching devices or an appropriate warning device (for example a warning notice in accordance with 16.1) shall be applied.

6.2.5 Protection by barriers

For protection by barriers, 412.2 of IEC 60364-4-41 shall apply.

6.2.6 Protection by placing out of reach or protection by obstacles

For protection by placing out of reach, 412.4 of IEC 60364-4-41 shall apply. For protection by obstacles, 412.3 of IEC 60364-4-41 shall apply.

For conductor wire systems or conductor bar systems with a degree of protection less than IP2X, see 12.7.1.

6.3 Protection against indirect contact

6.3.1 General

Protection against indirect contact (3.29) is intended to prevent hazardous situations due to an insulation fault between live parts and exposed conductive parts.

For each circuit or part of the electrical equipment, at least one of the measures in accordance with 6.3.2 to 6.3.3 shall be applied:

- measures to prevent the occurrence of a touch voltage (6.3.2); or
- automatic disconnection of the supply before the time of contact with a touch voltage can become hazardous (6.3.3).

NOTE 1 The risk of harmful physiological effects from a touch voltage depends on the value of the touch voltage and the duration of possible exposure.

NOTE 2 For classes of equipment and protective provisions, see IEC 61140.

6.3.2 Prevention of the occurrence of a touch voltage

6.3.2.1 General

Measures to prevent the occurrence of a touch voltage include the following:

- provision of class II equipment or by equivalent insulation;
- electrical separation.

6.3.2.2 Protection by provision of class II equipment or by equivalent insulation

This measure is intended to prevent the occurrence of touch voltages on the accessible parts through a fault in the basic insulation.

This protection is provided by one or more of the following:

- class II electrical devices or apparatus (double insulation, reinforced insulation or by equivalent insulation in accordance with IEC 61140);
- switchgear and controlgear assemblies having total insulation in accordance with IEC 60439-1;
- supplementary or reinforced insulation in accordance with 413.2 of IEC 60364-4-41.

6.3.2.3 Protection by electrical separation

Electrical separation of an individual circuit is intended to prevent a touch voltage through contact with exposed conductive parts that can be energized by a fault in the basic insulation of the live parts of that circuit.

For this type of protection, the requirements of 413.5 of IEC 60364-4-41 apply.

6.3.3 Protection by automatic disconnection of supply

This measure consists of the interruption of one or more of the line conductors by the automatic operation of a protective device in case of a fault. This interruption shall occur within a sufficiently short time to limit the duration of a touch voltage to a time within which the touch voltage is not hazardous. Interruption times are given in Annex A.

This measure necessitates co-ordination between:

- the type of supply and earthing system;
- the impedance values of the different elements of the protective bonding system;
- the characteristics of the protective devices that detect insulation fault(s).

Automatic disconnection of the supply of any circuit affected by an insulation fault is intended to prevent a hazardous situation resulting from a touch voltage.

This protective measure comprises both:

- protective bonding of exposed conductive parts (see 8.2.3),
- and either:
 - a) overcurrent protective devices for the automatic disconnection of the supply on detection of an insulation fault in TN systems, or
 - b) residual current protective devices to initiate the automatic disconnection of the supply on detection of an insulation fault from a live part to exposed conductive parts or to earth in TT systems, or
 - c) insulation monitoring or residual current protective devices to initiate automatic disconnection of IT systems. Except where a protective device is provided to interrupt the supply in the case of the first earth fault, an insulation monitoring device shall be provided to indicate the occurrence of a first fault from a live part to exposed conductive parts or to earth. This insulation monitoring device shall initiate an audible and/or visual signal which shall continue as long as the fault persists.

NOTE In large machines, the provision of an earth fault location system can facilitate maintenance.

Where automatic disconnection is provided in accordance with a), and disconnection within the time specified in Clause A.1 cannot be assured, supplementary bonding shall be provided as necessary to meet the requirements of Clause A.3.

6.4 Protection by the use of PELV

6.4.1 General requirements

The use of PELV (Protective Extra-Low Voltage) is to protect persons against electric shock from indirect contact and limited area direct contact (see 8.2.5).

PELV circuits shall satisfy all of the following conditions:

- a) the nominal voltage shall not exceed:
 - 25 V a.c. r.m.s. or 60 V ripple-free d.c. when the equipment is normally used in dry locations and when large area contact of live parts with the human body is not expected; or
 - 6 V a.c. r.m.s. or 15 V ripple-free d.c. in all other cases;

NOTE *Ripple-free* is conventionally defined for a sinusoidal ripple voltage as a ripple content of not more than 10 % r.m.s.

- b) one side of the circuit or one point of the source of the supply of that circuit shall be connected to the protective bonding circuit;
- c) live parts of PELV circuits shall be electrically separated from other live circuits. Electrical separation shall be not less than that required between the primary and secondary circuits of a safety isolating transformer (see IEC 61558-1 and IEC 61558-2-6);
- d) conductors of each PELV circuit shall be physically separated from those of any other circuit. When this requirement is impracticable, the insulation provisions of 13.1.3 shall apply;
- e) plugs and socket-outlets for a PELV circuit shall conform to the following:
 - 1) plugs shall not be able to enter socket-outlets of other voltage systems;
 - 2) socket-outlets shall not admit plugs of other voltage systems.

6.4.2 Sources for PELV

The source for PELV shall be one of the following:

- a safety isolating transformer in accordance with IEC 61558-1 and IEC 61558-2-6;
- a source of current providing a degree of safety equivalent to that of the safety isolating transformer (for example a motor generator with winding providing equivalent isolation);
- an electrochemical source (for example a battery) or another source independent of a higher voltage circuit (for example a diesel-driven generator);
- an electronic power supply conforming to appropriate standards specifying measures to be –taken to ensure that, even in the case of an internal fault, the voltage at the outgoing terminals cannot exceed the values specified in 6.4.1.

7 Protection of equipment

7.1 General

This Clause details the measures to be taken to protect equipment against the effects of:

- overcurrent arising from a short circuit;
- overload and/or loss of cooling of motors;
- abnormal temperature;
- loss of or reduction in the supply voltage;
- overspeed of machines/machine elements;
- earth fault/residual current;
- incorrect phase sequence;
- overvoltage due to lightning and switching surges.

7.2 Overcurrent protection

7.2.1 General

Overcurrent protection shall be provided where the current in a machine circuit can exceed either the rating of any component or the current carrying capacity of the conductors, whichever is the lesser value. The ratings or settings to be selected are detailed in 7.2.10.

7.2.2 Supply conductors

Unless otherwise specified by the user, the supplier of the electrical equipment is not responsible for providing the overcurrent protective device for the supply conductors to the electrical equipment (see Annex B).

The supplier of the electrical equipment shall state on the installation diagram the data necessary for selecting the overcurrent protective device (see 7.2.10 and 17.4).

7.2.3 Power circuits

Devices for detection and interruption of overcurrent, selected in accordance with 7.2.10, shall be applied to each live conductor.

The following conductors, as applicable, shall not be disconnected without disconnecting all associated live conductors:

- the neutral conductor of a.c. power circuits;
- the earthed conductor of d.c. power circuits;
- d.c. power conductors bonded to exposed conductive parts of mobile machines.

Where the cross-sectional area of the neutral conductor is at least equal to or equivalent to that of the phase conductors, it is not necessary to provide overcurrent detection for the neutral conductor nor a disconnecting device for that conductor. For a neutral conductor with a cross-sectional area smaller than that of the associated phase conductors, the measures detailed in 524 of IEC 60364-5-52 shall apply.

In IT systems, it is recommended that the neutral conductor is not used. However, where a neutral conductor is used, the measures detailed in 431.2.2 of IEC 60364-4-43 shall apply.

7.2.4 Control circuits

Conductors of control circuits directly connected to the supply voltage and of circuits supplying control circuit transformers shall be protected against overcurrent in accordance with 7.2.3.

Conductors of control circuits supplied by a control circuit transformer or d.c. supply shall be protected against overcurrent (see also 9.4.3.1):

- in control circuits connected to the protective bonding circuit, by inserting an overcurrent protective device into the switched conductor;
- in control circuits not connected to the protective bonding circuit;
 - where the same cross sectional area conductors are used in all control circuits, by inserting an overcurrent protective device into the switched conductor, and;
 - where different cross sectional areas conductors are used in different sub-circuits, by inserting an overcurrent protective device into both switched and common conductors of each sub-circuit.

7.2.5 Socket outlets and their associated conductors

Overcurrent protection shall be provided for the circuits feeding the general purpose socket outlets intended primarily for supplying power to maintenance equipment. Overcurrent protective devices shall be provided in the unearthed live conductors of each circuit feeding such socket outlets.

7.2.6 Lighting circuits

All unearthed conductors of circuits supplying lighting shall be protected against the effects of short circuits by the provision of overcurrent devices separate from those protecting other circuits.

7.2.7 Transformers

Transformers shall be protected against overcurrent in accordance with the manufacturer's instructions. Such protection shall (see also 7.2.10):

- avoid nuisance tripping due to transformer magnetizing inrush currents;
- avoid a winding temperature rise in excess of the permitted value for the insulation class of transformer when it is subjected to the effects of a short circuit at its secondary terminals.

The type and setting of the overcurrent protective device should be in accordance with the recommendations of the transformer supplier.

7.2.8 Location of overcurrent protective devices

An overcurrent protective device shall be located at the point where a reduction in the cross-sectional area of the conductors or another change reduces the current-carrying capacity of the conductors, except where all the following conditions are satisfied:

- the current carrying capacity of the conductors is at least equal to that of the load;
- the part of the conductor between the point of reduction of current-carrying capacity and the position of the overcurrent protective device is no longer than 3 m;
- the conductor is installed in such a manner as to reduce the possibility of a short-circuit, for example, protected by an enclosure or duct.

7.2.9 Overcurrent protective devices

The rated short-circuit breaking capacity shall be at least equal to the prospective fault current at the point of installation. Where the short-circuit current to an overcurrent protective device can include additional currents other than from the supply (for example from motors, from power factor correction capacitors), those currents shall be taken into consideration.

A lower breaking capacity is permitted where another protective device (for example the overcurrent protective device for the supply conductors (see 7.2.2) having the necessary breaking capacity is installed on the supply side. In that case, the characteristics of the two devices shall be co-ordinated so that the let-through energy (I^2t) of the two devices in series does not exceed that which can be withstood without damage to the overcurrent protective device on the load side and to the conductors protected by that device (see Annex A of IEC 60947-2).

NOTE The use of such a co-ordinated arrangement of overcurrent protective devices can result in the operation of both overcurrent protective devices.

Where fuses are provided as overcurrent protective devices, a type readily available in the country of use shall be selected, or arrangements shall be made for the supply of spare parts.

7.2.10 Rating and setting of overcurrent protective devices

The rated current of fuses or the setting current of other overcurrent protective devices shall be selected as low as possible but adequate for the anticipated overcurrents (for example during starting of motors or energizing of transformers). When selecting those protective devices, consideration shall be given to the protection of switching devices against damage due to overcurrents (for example welding of the switching device contacts).

The rated current or setting of an overcurrent protective device is determined by the current carrying capacity of the conductors to be protected in accordance with 12.4, D.2 and the maximum allowable interrupting time t in accordance with Clause D.3, taking into account the needs of co-ordination with other electrical devices in the protected circuit.

7.3 Protection of motors against overheating

7.3.1 General

Protection of motors against overheating shall be provided for each motor rated at more than 0,5 kW.

Exceptions:

In applications where an automatic interruption of the motor operation is unacceptable (for example fire pumps), the means of detection shall give a warning signal to which the operator can respond.

Protection of motors against overheating can be achieved by:

- overload protection (7.3.2),

NOTE 1 Overload protective devices detect the time and current relationships (I^2t) in a circuit that are in excess of the rated full load of the circuit and initiate appropriate control responses.

- over-temperature protection (7.3.3), or

NOTE 2 Temperature detection devices sense over-temperature and initiate appropriate control responses.

- current-limiting protection (7.3.4).

Automatic restarting of any motor after the operation of protection against overheating shall be prevented where this can cause a hazardous situation or damage to the machine or to the work in progress.

7.3.2 Overload protection

Where overload protection is provided, detection of overload(s) shall be provided in each live conductor except for the neutral conductor. However, where the motor overload detection is not used for cable overload protection (see also Clause D.2), the number of overload detection devices may be reduced at the request of the user (see also Annex B). For motors having single-phase or d.c. power supplies, detection in only one unearthed live conductor is permitted.

Where overload protection is achieved by switching off, the switching device shall switch off all live conductors. The switching of the neutral conductor is not necessary for overload protection.

Where motors with special duty ratings are required to start or to brake frequently (for example, motors for rapid traverse, locking, rapid reversal, sensitive drilling) it can be difficult to provide overload protection with a time constant comparable with that of the winding to be protected. Appropriate protective devices designed to accommodate special duty motors or over-temperature protection (see 7.3.3) can be necessary.

For motors that cannot be overloaded (for example torque motors, motion drives that either are protected by mechanical overload protection devices or are adequately dimensioned), overload protection is not required.

7.3.3 Over-temperature protection

The provision of motors with over-temperature protection (see IEC 60034-11) is recommended in situations where the cooling can be impaired (for example dusty environments). Depending upon the type of motor, protection under stalled rotor or loss of phase conditions is not always ensured by over-temperature protection, and additional protection should then be provided.

Over-temperature protection is also recommended for motors that cannot be overloaded (for example torque motors, motion drives that are either protected by mechanical overload protection devices or are adequately dimensioned), where the possibility of over-temperature exists (for example due to reduced cooling).

7.3.4 Current limiting protection

Where protection against the effects of overheating in three phase motors is achieved by current limitation, the number of current limitation devices may be reduced from 3 to 2 (see 7.3.2). For motors having single phase a.c or d.c. power supplies, current limitation in only one unearthed live conductor is permitted.

7.4 Abnormal temperature protection

Resistance heating or other circuits that are capable of attaining or causing abnormal temperatures (for example, due to short-time rating or loss of cooling medium) and therefore can cause a hazardous situation shall be provided with suitable detection to initiate an appropriate control response.

7.5 Protection against supply interruption or voltage reduction and subsequent restoration

Where a supply interruption or a voltage reduction can cause a hazardous situation, damage to the machine, or to the work in progress, undervoltage protection shall be provided by, for example, switching off the machine at a predetermined voltage level.

Where the operation of the machine can allow for an interruption or a reduction of the voltage for a short time period, delayed undervoltage protection may be provided. The operation of the undervoltage device shall not impair the operation of any stopping control of the machine.

Upon restoration of the voltage or upon switching on the incoming supply, automatic or unexpected restarting of the machine shall be prevented where such a restart can cause a hazardous situation.

Where only a part of the machine or of the group of machines working together in a co-ordinated manner is affected by the voltage reduction or supply interruption, the undervoltage protection shall initiate appropriate control responses to ensure co-ordination.

7.6 Motor overspeed protection

Overspeed protection shall be provided where overspeeding can occur and could possibly cause a hazardous situation taking into account measures in accordance with 9.3.2. Overspeed protection shall initiate appropriate control responses and shall prevent automatic restarting.

The overspeed protection should operate in such a manner that the mechanical speed limit of the motor or its load is not exceeded.

NOTE This protection can consist, for example, of a centrifugal switch or speed limit monitor.

7.7 Earth fault/residual current protection

In addition to providing overcurrent protection for automatic disconnection as described in 6.3, earth fault/residual current protection can be provided to reduce damage to equipment due to earth fault currents less than the detection level of the overcurrent protection.

The setting of the devices shall be as low as possible consistent with correct operation of the equipment.

7.8 Phase sequence protection

Where an incorrect phase sequence of the supply voltage can cause a hazardous situation or damage to the machine, protection shall be provided.

NOTE Conditions of use that can lead to an incorrect phase sequence include:

- a machine transferred from one supply to another;
- a mobile machine with a facility for connection to an external power supply.

7.9 Protection against overvoltages due to lightning and to switching surges

Protective devices can be provided to protect against the effects of overvoltages due to lightning or to switching surges.

Where provided:

- devices for the suppression of overvoltages due to lightning shall be connected to the incoming terminals of the supply disconnecting device.
- devices for the suppression of overvoltages due to switching surges shall be connected across the terminals of all equipment requiring such protection.

8 Equipotential bonding

8.1 General

This Clause provides requirements for both protective bonding and functional bonding. Figure 2 illustrates those concepts.

Protective bonding is a basic provision for fault protection to enable protection of persons against electric shock from indirect contact (see 6.3.3 and 8.2).

The objective of functional bonding (see 8.3) is to minimize:

- the consequence of an insulation failure which could affect the operation of the machine;
- the consequences of electrical disturbances to sensitive electrical equipment which could affect the operation of the machine.

Normally functional bonding is achieved by connection to the protective bonding circuit, but where the level of electrical disturbances on the protective bonding circuit is not sufficiently low for proper functioning of electrical equipment, it may be necessary to connect the functional bonding circuit to a separate functional earthing conductor (see Figure 2).

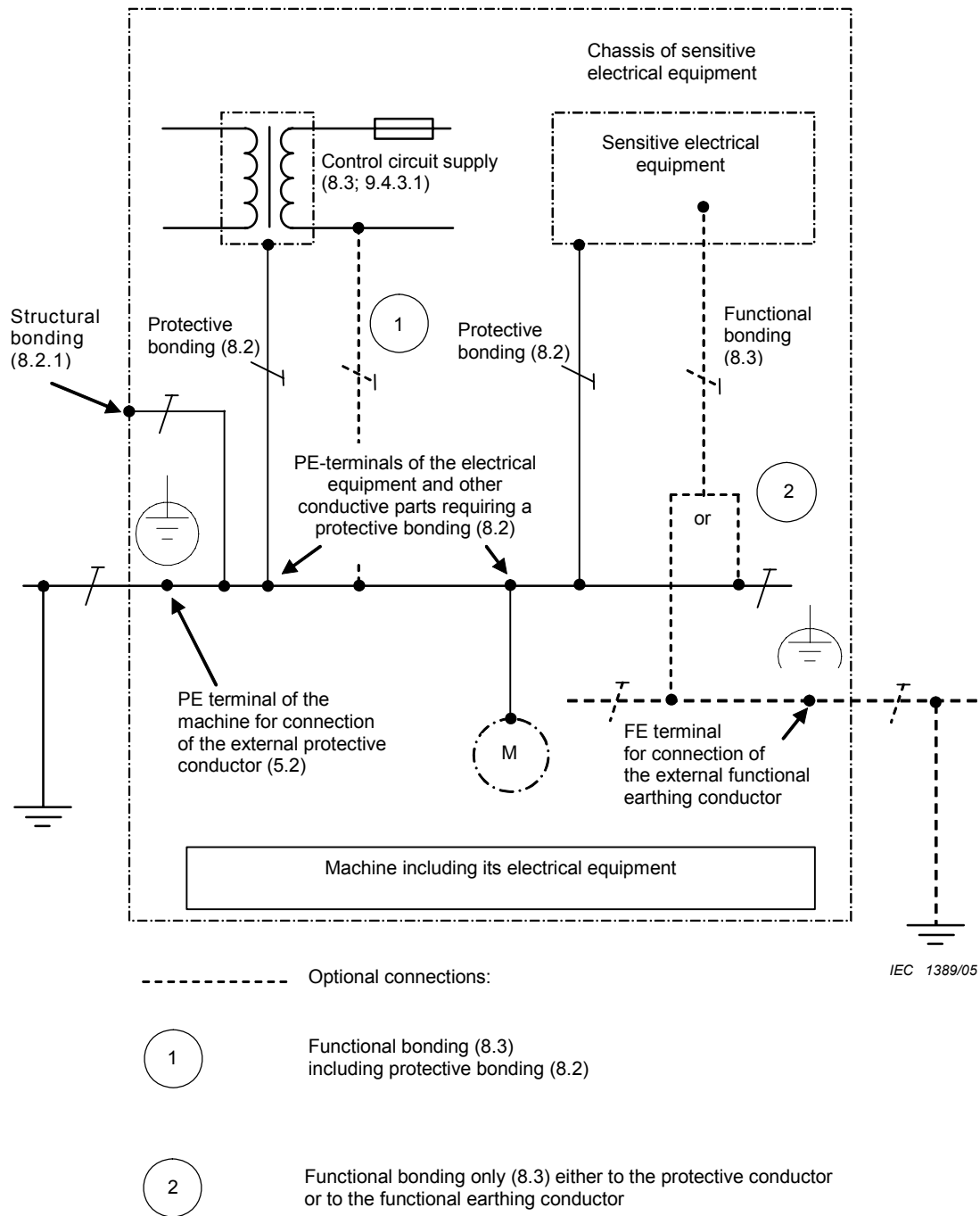

NOTE The functional earthing conductor was previously referred to as 'noiseless earth conductor' and the 'FE' terminal was previously designated 'TE' (see IEC 60445).

Figure 2 – Example of equipotential bonding for electrical equipment of a machine

8.2 Protective bonding circuit

8.2.1 General

The protective bonding circuit consists of:

- PE terminal(s) (see 5.2);
- the protective conductors in the equipment of the machine including sliding contacts where they are part of the circuit;
- the exposed conductive parts and conductive structural parts of the electrical equipment;
- those extraneous conductive parts which form the structure of the machine.

All parts of the protective bonding circuit shall be so designed that they are capable of withstanding the highest thermal and mechanical stresses that can be caused by earth-fault currents that could flow in that part of the protective bonding circuit.

Where the conductance of structural parts of the electrical equipment or of the machine is less than that of the smallest protective conductor connected to the exposed conductive parts, a supplementary bonding conductor shall be provided. This supplementary bonding conductor shall have a cross-sectional area not less than half that of the corresponding protective conductor.

If an IT distribution system is used, the machine structure shall be part of the protective bonding circuit and insulation monitoring shall be provided. See 6.3.3 c).

Conductive structural parts of equipment in accordance with 6.3.2.2 need not be connected to the protective bonding circuit. Extraneous conductive parts which form the structure of the machine need not be connected to the protective bonding circuit where all the equipment provided is in accordance with 6.3.2.2.

Exposed conductive parts of equipment in accordance with 6.3.2.3 shall not be connected to the protective bonding circuit.

8.2.2 Protective conductors

Protective conductors shall be identified in accordance with 13.2.2.

Copper conductors are preferred. Where a conductor material other than copper is used, its electrical resistance per unit length shall not exceed that of the allowable copper conductor and such conductors shall be not less than 16 mm² in cross-sectional area.

The cross-sectional area of protective conductors shall be determined in accordance with the requirements of:

- 543 of IEC 60364-5-54; or
- 7.4.3.1.7 of IEC 60439-1, as appropriate.

This requirement is met in most cases where the relationship between the cross-sectional area of the phase conductors associated with that part of the equipment and the cross-sectional area of the associated protective conductor is in accordance with Table 1 (see 5.2).

See also 8.2.8.

8.2.3 Continuity of the protective bonding circuit

All exposed conductive parts shall be connected to the protective bonding circuit in accordance with 8.2.1.

Exception: see 8.2.5.

Where a part is removed for any reason (for example routine maintenance), the protective bonding circuit for the remaining parts shall not be interrupted.

Connection and bonding points shall be so designed that their current-carrying capacity is not impaired by mechanical, chemical, or electrochemical influences. Where enclosures and conductors of aluminium or aluminium alloys are used, particular consideration should be given to the possibility of electrolytic corrosion.

Metal ducts of flexible or rigid construction and metallic cable sheaths shall not be used as protective conductors. Nevertheless, such metal ducts and the metal sheathing of all connecting cables (for example cable armouring, lead sheath) shall be connected to the protective bonding circuit.

Where the electrical equipment is mounted on lids, doors, or cover plates, continuity of the protective bonding circuit shall be ensured and a protective conductor (see 8.2.2) is recommended. Otherwise fastenings, hinges or sliding contacts designed to have a low resistance shall be used (see 18.2.2, Test 1).

The continuity of the protective conductor in cables that are exposed to damage (for example flexible trailing cables) shall be ensured by appropriate measures (for example monitoring).

For requirements for the continuity of the protective conductor using conductor wires, conductor bars and slip-ring assemblies, see 12.7.2.

8.2.4 Exclusion of switching devices from the protective bonding circuit

The protective bonding circuit shall not incorporate a switching device or an overcurrent protective device (for example switch, fuse).

No means of interruption of the protective bonding conductor shall be provided.

Exception: links for test or measurement purposes that cannot be opened without the use of a tool and that are located in an enclosed electrical operating area.

Where the continuity of the protective bonding circuit can be interrupted by means of removable current collectors or plug/socket combinations, the protective bonding circuit shall be interrupted by a first make last break contact. This also applies to removable or withdrawable plug-in units (see also 13.4.5).

8.2.5 Parts that need not be connected to the protective bonding circuit

It is not necessary to connect exposed conductive parts to the protective bonding circuit where those parts are mounted so that they do not constitute a hazard because:

- they cannot be touched on large surfaces or grasped with the hand and they are small in size (less than approximately 50 mm × 50 mm); or
- they are located so that either contact with live parts, or an insulation failure, is unlikely.

This applies to small parts such as screws, rivets, and nameplates and to parts inside an enclosure, irrespective of their size (for example electromagnets of contactors or relays and mechanical parts of devices) (see also 410.3.3.5 of IEC 60364-4-41).

8.2.6 Protective conductor connecting points

All protective conductors shall be terminated in accordance with 13.1.1. The protective conductor connecting points shall have no other function and are not intended, for example, to attach or connect appliances or parts.

Each protective conductor connecting point shall be marked or labelled as such using the symbol IEC 60417-5019 (DB:2002-10):



or with the letters **PE**, the graphical symbol being preferred, or by use of the bicolour combination GREEN-AND-YELLOW, or by any combination of these.

8.2.7 Mobile machines

On mobile machines with on-board power supplies, the protective conductors, the conductive structural parts of the electrical equipment, and those extraneous conductive parts which form the structure of the machine shall all be connected to a protective bonding terminal to provide protection against electric shock. Where a mobile machine is also capable of being connected to an external incoming power supply, this protective bonding terminal shall be the connection point for the external protective conductor.

NOTE When the supply of electrical energy is self-contained within stationary, mobile, or movable items of equipment, and when there is no external supply connected (for example when an on-board battery charger is not connected), there is no need to connect such equipment to an external protective conductor.

8.2.8 Additional protective bonding requirements for electrical equipment having earth leakage currents higher than 10 mA a.c. or d.c.

NOTE 1 Earth leakage current is defined as "current flowing from the live parts of an installation to earth, in the absence of an insulation fault" (IEV 442-01-24). This current may have a capacitive component including that resulting from the deliberate use of capacitors.

NOTE 2 Most adjustable speed electrical power drive systems that comply with relevant parts of IEC 61800 will have an earth leakage current greater than 3,5 mA a.c. A touch current measurement method is specified as a type test in IEC 61800-5-1 to determine the earth leakage current of an adjustable speed electrical power drive system.

Where electrical equipment has an earth leakage current (for example adjustable speed electrical power drive systems and information technology equipment) that is greater than 10 mA a.c. or d.c. in any incoming supply, one or more of the following conditions for the associated protective bonding circuit shall be satisfied:

- a) the protective conductor shall have a cross-sectional area of at least 10 mm² Cu or 16 mm² Al, through its total run;
- b) where the protective conductor has a cross-sectional area of less than 10 mm² Cu or 16 mm² Al, a second protective conductor of at least the same cross-sectional area shall be provided up to a point where the protective conductor has a cross-sectional area not less than 10 mm² Cu or 16 mm² Al.

NOTE 3 This can require that the electrical equipment has a separate terminal for a second protective conductor.

- c) automatic disconnection of the supply in case of loss of continuity of the protective conductor.

To prevent difficulties associated with electromagnetic disturbances, the requirements of 4.4.2 also apply to the installation of duplicate protective conductors.

In addition, a warning label shall be provided adjacent to the PE terminal, and where necessary on the nameplate of the electrical equipment. The information provided under 17.2 b)1) shall include information about the leakage current and the minimum cross-sectional area of the external protective conductor.

8.3 Functional bonding

Protection against maloperation as a result of insulation failures can be achieved by connecting to a common conductor in accordance with 9.4.3.1.

For recommendations regarding functional bonding to avoid maloperation due to electromagnetic disturbances, see 4.4.2.

8.4 Measures to limit the effects of high leakage current

The effects of high leakage current can be restricted to the equipment having high leakage current by connection of that equipment to a dedicated supply transformer having separate windings. The protective bonding circuit shall be connected to exposed conductive parts of the equipment and, in addition, to the secondary winding of the transformer. The protective conductor(s) between the equipment and the secondary winding of the transformer shall comply with one or more of the arrangements described in 8.2.8.

9 Control circuits and control functions

9.1 Control circuits

9.1.1 Control circuit supply

Where control circuits are supplied from an a.c. source, control transformers shall be used for supplying the control circuits. Such transformers shall have separate windings. Where several transformers are used, it is recommended that the windings of those transformers be connected in such a manner that the secondary voltages are in phase.

Where d.c. control circuits derived from an a.c. supply are connected to the protective bonding circuit (see 8.2.1), they shall be supplied from a separate winding of the a.c. control circuit transformer or by another control circuit transformer.

NOTE Switch-mode units fitted with transformers having separate windings in accordance with IEC 61558-2-17 meet this requirement.

Transformers are not mandatory for machines with a single motor starter and/or a maximum of two control devices (for example interlock device, start/stop control station).

9.1.2 Control circuit voltages

The nominal value of the control voltage shall be consistent with the correct operation of the control circuit. The nominal voltage shall not exceed 277 V when supplied from a transformer.

9.1.3 Protection

Control circuits shall be provided with overcurrent protection in accordance with 7.2.4 and 7.2.10.

9.2 Control functions

A1 NOTE 1 Information on the safety-related aspects of control functions is given in ISO 13849-1, ISO 13849-2, and IEC 62061. **A1**

NOTE 2 This subclause does not specify requirements for the equipment used to implement control functions. Examples of such requirements are given in Clause 10.

9.2.1 Start functions

Start functions shall operate by energizing the relevant circuit (see 9.2.5.2).

9.2.2 Stop functions

There are three categories of stop functions as follows:

- stop category 0: stopping by immediate removal of power to the machine actuators (i.e. an uncontrolled stop – see 3.56);
- stop category 1: a controlled stop (see 3.11) with power available to the machine actuators to achieve the stop and then removal of power when the stop is achieved;
- stop category 2: a controlled stop with power left available to the machine actuators.

9.2.3 Operating modes

Each machine can have one or more operating modes determined by the type of machine and its application. When a hazardous situation can result from a mode selection, unauthorised and/or inadvertent selection shall be prevented by suitable means (for example key operated switch, access code).

Mode selection by itself shall not initiate machine operation. A separate actuation of the start control shall be required.

For each specific operating mode, the relevant safety functions and/or protective measures shall be implemented.

Indication of the selected operating mode shall be provided (for example the position of a mode selector, the provision of an indicating light, a visual display indication).

9.2.4 Suspension of safety functions and/or protective measures

Where it is necessary to suspend safety functions and/or protective measures (for example for setting or maintenance purposes), protection shall be ensured by:

- disabling all other operating (control) modes; and
- other relevant means (see 4.11.9 of ISO 12100-2:2003), that can include, for example, one or more of the following:
 - initiation of operation by a hold-to-run device or by a similar control device;
 - a portable control station with an emergency stop device and, where appropriate, an enabling device. Where a portable control station is in use, initiation of motion shall only be possible from that control station;

- a cableless control station with a device to initiate stop functions in accordance with 9.2.7.3 and, where appropriate, an enabling device. Where a cableless control station is in use, initiation of motion shall only be possible from that control station;
- limitation of the speed or the power of motion;
- limitation of the range of motion.

9.2.5 Operation

9.2.5.1 General

The necessary safety functions and/or protective measures (for example interlocks (see 9.3)) shall be provided for safe operation.

Measures shall be taken to prevent movement of the machine in an unintended or unexpected manner after any stopping of the machine (for example due to locked-off condition, power supply fault, battery replacement, lost signal condition with cableless control).

Where a machine has more than one control station, measures shall be provided to ensure that initiation of commands from different control stations do not lead to a hazardous situation.

9.2.5.2 Start

The start of an operation shall be possible only when all of the relevant safety functions and/or protective measures are in place and are operational except for conditions as described in 9.2.4.

On those machines (for example mobile machines) where safety functions and/or protective measures cannot be applied for certain operations, manual control of such operations shall be by hold-to-run controls, together with enabling devices, as appropriate.

Suitable interlocks shall be provided to secure correct sequential starting.

In the case of machines requiring the use of more than one control station to initiate a start, each of these control stations shall have a separate manually actuated start control device. The conditions to initiate a start shall be:

- all required conditions for machine operation shall be met, and
- all start control devices shall be in the released (off) position, then
- all start control devices shall be actuated concurrently (see 3.6).

9.2.5.3 Stop

Stop category 0 and/or stop category 1 and/or stop category 2 stop functions shall be provided as indicated by the risk assessment and the functional requirements of the machine (see 4.1).

NOTE The supply disconnecting device (see 5.3) when operated achieves a stop category 0.

Stop functions shall override related start functions (see 9.2.5.2).

Where required, facilities to connect protective devices and interlocks shall be provided. If such a protective device or interlock causes a stop of the machine, it may be necessary for that condition to be signalled to the logic of the control system. The reset of the stop function shall not initiate any hazardous situation.

Where more than one control station is provided, stop commands from any control station shall be effective when required by the risk assessment of the machine.

9.2.5.4 Emergency operations (emergency stop, emergency switching off)

9.2.5.4.1 General

This part of IEC 60204 specifies the requirements for the emergency stop and the emergency switching off functions of the emergency operations listed in Annex E, both of which are, in this part of IEC 60204, initiated by a single human action.

Once active operation of an emergency stop (see 10.7) or emergency switching off (see 10.8) actuator has ceased following a command, the effect of this command shall be sustained until it is reset. This reset shall be possible only by a manual action at that location where the command has been initiated. The reset of the command shall not restart the machinery but only permit restarting.

It shall not be possible to restart the machinery until all emergency stop commands have been reset. It shall not be possible to reenergize the machinery until all emergency switching off commands have been reset.

NOTE Emergency stop and emergency switching off are complementary protective measures that are not primary means of risk reduction for hazards (for example trapping, entanglement, electric shock or burn) at a machine (see ISO 12100 (all parts)).

9.2.5.4.2 Emergency stop

Principles for the design of emergency stop equipment, including functional aspects, are given in ISO 13850.

The emergency stop shall function either as a stop category 0 or as a stop category 1 (see 9.2.2). The choice of the stop category of the emergency stop depends on the results of a risk assessment of the machine.

In addition to the requirements for stop (see 9.2.5.3), the emergency stop function has the following requirements:

- it shall override all other functions and operations in all modes;
- power to the machine actuators that can cause a hazardous situation(s) shall be either removed immediately (stop category 0) or shall be controlled in such a way to stop the hazardous motion as quickly as possible (stop category 1) without creating other hazards;
- reset shall not initiate a restart.

9.2.5.4.3 Emergency switching off

The functional aspects of emergency switching off are given in 536.4 of IEC 60364-5-53.

Emergency switching off should be provided where:

- protection against direct contact (for example with conductor wires, conductor bars, slipping assemblies, controlgear in electrical operating areas) is achieved only by placing out of reach or by obstacles (see 6.2.6); or
- there is the possibility of other hazards or damage caused by electricity.

Emergency switching off is accomplished by switching off the relevant incoming supply by electromechanical switching devices, effecting a stop category 0 of machine actuators connected to this incoming supply. When a machine cannot tolerate this stop category 0 stop, it may be necessary to provide other measures, for example protection against direct contact, so that emergency switching off is not necessary.

9.2.5.5 Monitoring of command actions

Movement or action of a machine or part of a machine that can result in a hazardous situation shall be monitored by providing, for example, overtravel limiters, motor overspeed detection, mechanical overload detection or anti-collision devices.

NOTE On some manually controlled machines, operators provide monitoring.

9.2.6 Other control functions

9.2.6.1 Hold-to-run controls

Hold-to-run controls shall require continuous actuation of the control device(s) to achieve operation.

NOTE Hold-to-run control can be accomplished by two-hand control devices.

9.2.6.2 Two-hand control

Three types of two-hand control are defined in ISO 13851, the selection of which is determined by the risk assessment. These shall have the following features:

Type I: this type requires:

- the provision of two control devices and their concurrent actuation by both hands;
- continuous concurrent actuation during the hazardous situation;
- machine operation shall cease upon the release of either one or both of the control devices when hazardous situations are still present.

A Type I two-hand control device is not considered to be suitable for the initiation of hazardous operation.

Type II: a type I control requiring the release of both control devices before machine operation can be reinitiated.

Type III: a type II control requiring concurrent actuation of the control devices as follows:

- it shall be necessary to actuate the control devices within a certain time limit of each other, not exceeding 0,5 s;
- where this time limit is exceeded, both control devices shall be released before machine operation can be initiated.

9.2.6.3 Enabling control

☐ Enabling control (see also 10.9) is a manually activated control function interlock that:

- a) when activated allows a machine operation to be initiated by a separate start control, and ☐

Ⓒ b) when de-activated

- initiates a stop function in accordance with 9.2.5.3, and
- prevents initiation of machine operation.

Enabling control shall be so arranged as to minimize the possibility of defeating, for example by requiring the de-activation of the enabling control device before machine operation may be reinitiated. It should not be possible to defeat the enabling function by simple means. Ⓒ

9.2.6.4 Combined start and stop controls

Push-buttons and similar control devices that, when operated, alternately initiate and stop motion shall only be provided for functions which cannot result in a hazardous situation.

9.2.7 Cableless control

9.2.7.1 General

This subclause deals with the functional requirements of control systems employing cableless (for example radio, infra-red) techniques for transmitting commands and signals between a machine control system and operator control station(s).

NOTE Some of these application and system considerations can also be applicable to control functions employing serial data communication techniques where the communications link uses a cable (for example coaxial, twisted-pair, optical fibre).

Means shall be provided to readily remove or disconnect the power supply of the operator control station (see also 9.2.7.3).

Means (for example key operated switch, access code) shall be provided, as necessary, to prevent unauthorized use of the operator control station.

Each operator control station shall carry an unambiguous indication of which machine(s) is (are) intended to be controlled by that operator control station.

9.2.7.2 Control limitation

Measures shall be taken to ensure that control commands:

- affect only the intended machine;
- affect only the intended functions.

Measures shall be taken to prevent the machine from responding to signals other than those from the intended operator control station(s).

Where necessary, means shall be provided so that the machine can only be controlled from operator control stations in one or more predetermined zones or locations.

9.2.7.3 Stop

Ⓒ Cableless control stations shall include a separate and clearly identifiable means to initiate the stop function of the machine or of all the operations that can cause a hazardous situation. The actuating means to initiate this stop function shall not be marked or labelled as an emergency stop device (see 10.7). Ⓒ

A machine which is equipped with cableless control shall have a means of automatically initiating the stopping of the machine and of preventing a potentially hazardous operation, in the following situations:

- when a stop signal is received;
- when a fault is detected in the cableless control system;
- when a valid signal (which includes a signal that communication is established and maintained) has not been detected within a specified period of time (see Annex B), except when a machine is executing a pre-programmed task taking it outside the range of the cableless control where no hazardous situation can occur.

9.2.7.4 Use of more than one operator control station

Where a machine has more than one operator control station, including one or more cableless control stations, measures shall be provided to ensure that only one of the control stations can be enabled at a given time. An indication of which operator control station is in control of the machine shall be provided at suitable locations as determined by the risk assessment of the machine.

Exception: a stop command from any one of the control stations shall be effective when required by the risk assessment of the machine.

9.2.7.5 Battery-powered operator control stations

A variation in the battery voltage shall not cause a hazardous situation. If one or more potentially hazardous motions are controlled using a battery-powered cableless operator control station, a clear warning shall be given to the operator when a variation in battery voltage exceeds specified limits. Under those circumstances, the cableless operator control station shall remain functional long enough for the operator to put the machine into a non-hazardous situation.

9.3 Protective interlocks

9.3.1 Reclosing or resetting of an interlocking safeguard

The reclosing or resetting of an interlocking safeguard shall not initiate hazardous machine operation.

NOTE Requirements for interlocking guards with a start function (control guards) are given in 5.3.2.5 of ISO 12100-2.

9.3.2 Exceeding operating limits

Where an operating limit (for example speed, pressure, position) can be exceeded leading to a hazardous situation, means shall be provided to detect when a predetermined limit(s) is exceeded and initiate an appropriate control action.

9.3.3 Operation of auxiliary functions

The correct operation of auxiliary functions shall be checked by appropriate devices (for example pressure sensors).

Where the non-operation of a motor or device for an auxiliary function (for example lubrication, supply of coolant, swarf removal) can cause a hazardous situation, or cause damage to the machine or to the work in progress, appropriate interlocking shall be provided.

9.3.4 Interlocks between different operations and for contrary motions

All contactors, relays, and other control devices that control elements of the machine and that can cause a hazardous situation when actuated at the same time (for example those which initiate contrary motion), shall be interlocked against incorrect operation.

Reversing contactors (for example those controlling the direction of rotation of a motor) shall be interlocked in such a way that in normal service no short circuit can occur when switching.

Where, for safety or for continuous operation, certain functions on the machine are required to be interrelated, proper co-ordination shall be ensured by suitable interlocks. For a group of machines working together in a co-ordinated manner and having more than one controller, provision shall be made to co-ordinate the operations of the controllers as necessary.

Where a failure of a mechanical brake actuator can result in the brake being applied when the associated machine actuator is energized and a hazardous situation can result, interlocks shall be provided to switch off the machine actuator.

9.3.5 Reverse current braking

Where braking of a motor is accomplished by current reversal, measures shall be provided to prevent the motor starting in the opposite direction at the end of braking where that reversal can cause a hazardous situation or damage to the machine or to the work in progress. For this purpose, a device operating exclusively as a function of time is not permitted.

Control circuits shall be so arranged that rotation of a motor shaft, for example manually, shall not result in a hazardous situation.

9.4 Control functions in the event of failure

9.4.1 General requirements

Where failures or disturbances in the electrical equipment can cause a hazardous situation or damage to the machine or to the work in progress, appropriate measures shall be taken to minimize the probability of the occurrence of such failures or disturbances. The required measures and the extent to which they are implemented, either individually or in combination, depend on the level of risk associated with the respective application (see 4.1).

The electrical control circuits shall have an appropriate level of safety performance that has been determined from the risk assessment at the machine. A1 The requirements of IEC 62061 and/or ISO 13849-1, ISO 13849-2 shall apply. A1

Measures to reduce those risks include but are not limited to:

- protective devices on the machine (for example interlocking guards, trip devices);
- protective interlocking of the electrical circuit;
- use of proven circuit techniques and components (see 9.4.2.1);
- provision of partial or complete redundancy (see 9.4.2.2) or diversity (see 9.4.2.3);
- provision for functional tests (see 9.4.2.4).

Where memory retention is achieved for example, by battery power, measures shall be taken to prevent hazardous situations arising from failure or removal of the battery.

Means shall be provided to prevent unauthorized or inadvertent memory alteration by, for example, requiring the use of a key, access code or tool.

9.4.2 Measures to minimize risk in the event of failure

9.4.2.1 Use of proven circuit techniques and components

These measures include but are not limited to:

- bonding of control circuits to the protective bonding circuit for functional purposes (see 9.4.3.1 and Figure 2);
- connection of control devices in accordance with 9.4.3.1;
- stopping by de-energizing (see 9.2.2);
- the switching of all control circuit conductors to the device being controlled (see 9.4.3.1);
- switching devices having direct opening action (see IEC 60947-5-1);
- circuit design to reduce the possibility of failures causing undesirable operations.

9.4.2.2 Provisions of partial or complete redundancy

By providing partial or complete redundancy, it is possible to minimize the probability that one single failure in the electrical circuit can result in a hazardous situation. Redundancy can be effective in normal operation (on-line redundancy) or designed as special circuits that take over the protective function (off-line redundancy) only where the operating function fails.

Where off-line redundancy which is not active during normal operation is provided, suitable measures shall be taken to ensure that those control circuits are available when required.

9.4.2.3 Provision of diversity

The use of control circuits having different principles of operation, or using different types of components or devices can reduce the probability of hazards resulting from faults and/or failures. Examples include:

- the combination of normally open and normally closed contacts operated by interlocking guards;
- the use of different types of control circuit components in the circuit;
- the combination of electromechanical and electronic equipment in redundant configurations.

The combination of electrical and non-electrical systems (for example mechanical, hydraulic, pneumatic) may perform the redundant function and provide the diversity.

9.4.2.4 Provision for functional tests

Functional tests may be carried out automatically by the control system, or manually by inspection or tests at start-up and at predetermined intervals, or a combination as appropriate (see also 17.2 and 18.6).

9.4.3 Protection against maloperation due to earth faults, voltage interruptions and loss of circuit continuity

9.4.3.1 Earth faults

Earth faults on any control circuit shall not cause unintentional starting, potentially hazardous motions, or prevent stopping of the machine.

Methods to meet these requirements include but are not limited to the following:

Method a) Control circuits, fed by control transformers:

- 1) In case of earthed control circuit supplies, the common conductor is connected to the protective bonding circuit at the point of supply. All contacts, solid state elements etc., which are intended to operate an electromagnetic or other device (for example, a relay, indicator light) are inserted between one side, the switched conductor of the control circuit supply and one terminal of the coil or device. The other terminal of the coil or device (preferably always having the same marking) is connected directly to the common conductor of the control circuit supply without any switching elements (see Figure 3).

Exception: Contacts of protective devices may be connected between the common conductor and the coils, provided that:

- the circuit is interrupted automatically in the event of an earth fault, or
 - the connection is very short (for example in the same enclosure) so that an earth fault is unlikely (for example overload relays).
- 2) Control circuits fed from a control transformer and not connected to the protective bonding circuit, having the same arrangement as shown in Figure 3 and provided with a device that interrupts the circuit automatically in the event of an earth fault (see also 7.2.4).

Method b) Control circuits fed from a control transformer with a centre-tapped winding, this centre tap connected to the protective bonding circuit, arranged as shown in Figure 4 with the overcurrent protective device having switching elements in all control circuit supply conductors.

NOTE 1 On a centre-tapped earthed control circuit, the presence of one earth fault can leave 50 % voltage on a relay coil. In this condition, a relay can hold on, resulting in inability to stop a machine.

NOTE 2 Coils or devices may be switched on either or both sides.

Method c) Where the control circuit is not fed from a control transformer and is either:

- 1) directly connected between the phase conductors of an earthed supply, or;
- 2) directly connected between the phase conductors or between a phase conductor and a neutral conductor of a supply that is not earthed or is earthed through a high impedance,

Multi-pole control switches that switch all live conductors are used for START or STOP of those machine functions that can cause a hazardous situation or damage to the machine in the event of unintentional starting or failure to stop, or in the case of c) 2), a device shall be provided that interrupts the circuit automatically in the event of an earth fault.

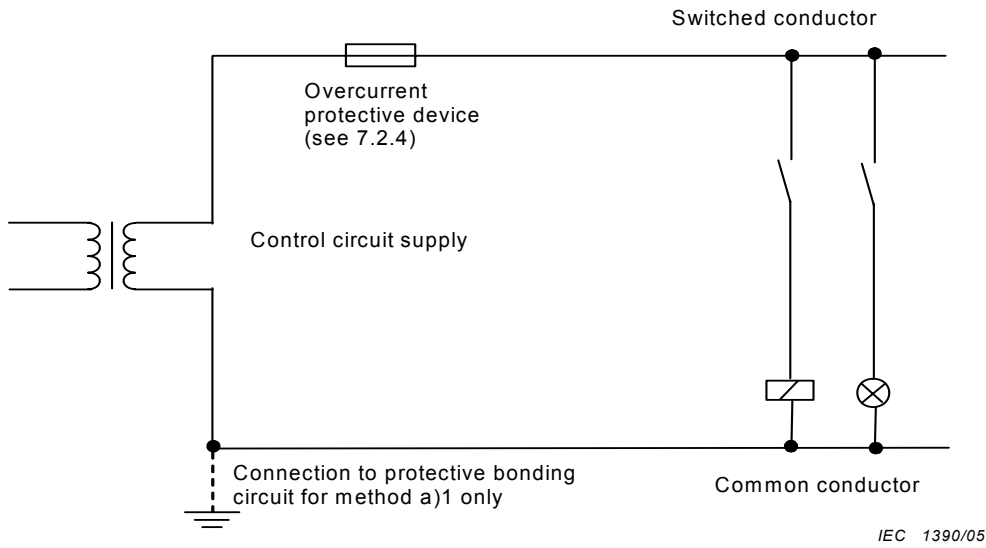

Figure 3 – Method a)

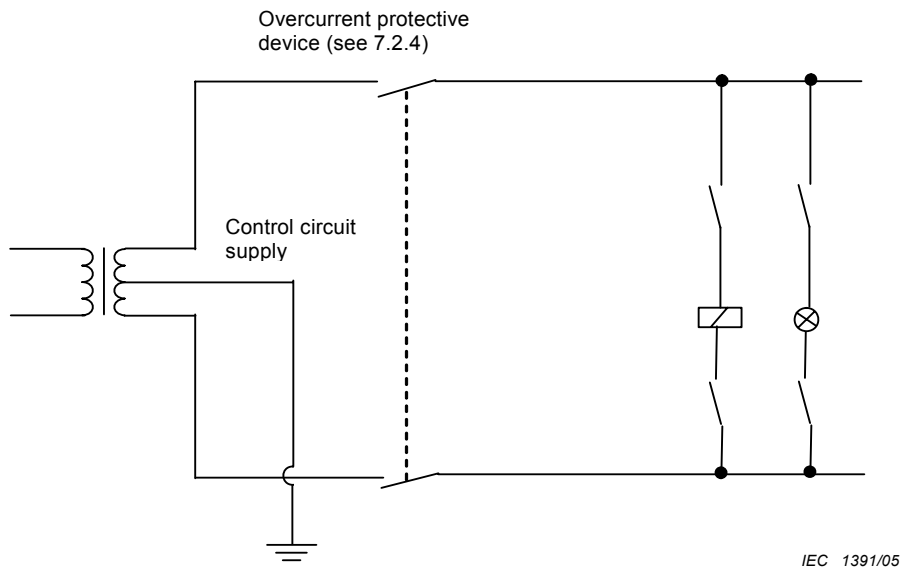

Figure 4 – Method b)

9.4.3.2 Voltage interruptions

The requirements detailed in 7.5 shall apply.

Where the control system uses a memory device(s), proper functioning in the event of power failure shall be ensured (for example by using a non-volatile memory) to prevent any loss of memory that can result in a hazardous situation.

9.4.3.3 Loss of circuit continuity

Where the loss of continuity of safety-related control circuits depending upon sliding contacts can result in a hazardous situation, appropriate measures shall be taken (for example by duplication of the sliding contacts).

10 Operator interface and machine-mounted control devices

10.1 General

10.1.1 General device requirements

This Clause contains requirements for devices mounted outside or partially outside control enclosures.

As far as is practicable, those devices shall be selected, mounted, and identified or coded in accordance with relevant parts of IEC 61310.

The possibility of inadvertent operation shall be minimized by, for example, positioning of devices, suitable design, provision of additional protective measures. Particular consideration shall be given to the selection, arrangement, programming and use of operator input devices such as touchscreens, keypads and keyboards, for the control of hazardous machine operations. See IEC 60447.

10.1.2 Location and mounting

As far as is practicable, machine-mounted control devices shall be:

- readily accessible for service and maintenance;
- mounted in such a manner as to minimize the possibility of damage from activities such as material handling.

The actuators of hand-operated control devices shall be selected and installed so that:

- they are not less than 0,6 m above the servicing level and are within easy reach of the normal working position of the operator;
- the operator is not placed in a hazardous situation when operating them.

The actuators of foot-operated control devices shall be selected and installed so that:

- they are within easy reach of the normal working position of the operator;
- the operator is not placed in a hazardous situation when operating them.

10.1.3 Protection

The degree of protection (see IEC 60529) together with other appropriate measures shall afford protection against:

- the effects of aggressive liquids, vapours, or gases found in the physical environment or used on the machine;
- the ingress of contaminants (for example swarf, dust, particulate matter).

In addition, the operator interface control devices shall have a minimum degree of protection against direct contact of IPXXD (see IEC 60529).

10.1.4 Position sensors

Position sensors (for example position switches, proximity switches) shall be so arranged that they will not be damaged in the event of overtravel.

Position sensors in circuits with safety-related control functions shall have direct opening action (see IEC 60947-5-1) or shall provide similar reliability (see 9.4.2).

NOTE A safety-related control function is intended to maintain the safe condition of the machine or prevent hazardous situations arising at the machine.

10.1.5 Portable and pendant control stations

Portable and pendant operator control stations and their control devices shall be so selected and arranged as to minimize the possibility of inadvertent machine operations caused by shocks and vibrations (for example if the operator control station is dropped or strikes an obstruction) (see also 4.4.8).

10.2 Push-buttons

10.2.1 Colours

Push-button actuators shall be colour-coded in accordance with Table 2 (see also 9.2 and Annex B).

The colours for START/ON actuators should be WHITE, GREY, BLACK or GREEN with a preference for WHITE. RED shall not be used.

The colour RED shall be used for emergency stop and emergency switching off actuators.

The colours for STOP/OFF actuators should be BLACK, GREY, or WHITE with a preference for BLACK. GREEN shall not be used. RED is permitted, but it is recommended that RED is not used near an emergency operation device.

WHITE, GREY, or BLACK are the preferred colours for push-button actuators that alternately act as START/ON and STOP/OFF push-buttons. The colours RED, YELLOW, or GREEN shall not be used (see also 9.2.6).

WHITE, GREY, or BLACK are the preferred colours for push-button actuators that cause operation while they are actuated and cease the operation when they are released (for example hold-to-run). The colours RED, YELLOW, or GREEN shall not be used.

Reset push-buttons shall be BLUE, WHITE, GREY, or BLACK. Where they also act as a STOP/OFF button, the colours WHITE, GREY, or BLACK are preferred with the main preference being for BLACK. GREEN shall not be used.

Where the same colour WHITE, GREY, or BLACK is used for various functions (for example WHITE for START/ON and for STOP/OFF actuators) a supplementary means of coding (for example shape, position, symbol) shall be used for the identification of push-button actuators.

Table 2 – Colour-coding for push-button actuators and their meanings



Colour	Meaning	Explanation	Examples of application
RED	Emergency	Actuate in the event of a hazardous situation or emergency	Emergency stop Initiation of emergency function (see also 10.2.1)
YELLOW	Abnormal	Actuate in the event of an abnormal condition	Intervention to suppress abnormal condition Intervention to restart an interrupted automatic cycle
BLUE	Mandatory	Actuate for a condition requiring mandatory action	Reset function
GREEN	Normal	Actuate to initiate normal conditions	(See 10.2.1)
WHITE	No specific meaning assigned	For general initiation of functions except for emergency stop	START/ON (preferred) STOP/OFF
GREY			START/ON STOP/OFF
BLACK			START/ON STOP/OFF (preferred)

Ⓒ

10.2.2 Markings

In addition to the functional identification as described in 16.3, it is recommended that push-buttons be marked, near to or preferably directly on the actuators, with the symbols given in Table 3.

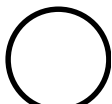
Table 3 – Symbols for push-buttons

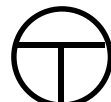
START or ON	STOP or OFF	Push-buttons acting alternately as START or STOP buttons and as ON or OFF buttons	Push-buttons acting as START or ON buttons when pressed and as STOP or OFF buttons when released (i.e. hold-to-run)
IEC 60417-5007 (DB:2002-10) 	IEC 60417-5008 (DB:2002-10) 	IEC 60417-5010 (DB:2002-10) 	IEC 60417-5011 (DB:2002-10) 

10.3 Indicator lights and displays

10.3.1 General

Indicator lights and displays serve to give the following types of information:

- indication: to attract the operator's attention or to indicate that a certain task should be performed. The colours RED, YELLOW, BLUE, and GREEN are normally used in this mode; for flashing indicator lights and displays, see 10.3.3.
- confirmation: to confirm a command, or a condition, or to confirm the termination of a change or transition period. The colours BLUE and WHITE are normally used in this mode and GREEN may be used in some cases.

Indicator lights and displays shall be selected and installed in such a manner as to be visible from the normal position of the operator (see also IEC 61310-1).

Indicator light circuits used for warning lights shall be fitted with facilities to check the operability of these lights.

10.3.2 Colours

Unless otherwise agreed between the supplier and the user (see Annex B), indicator lights shall be colour-coded with respect to the condition (status) of the machine in accordance with Table 4.

Table 4 – Colours for indicator lights and their meanings with respect to the condition of the machine

Colour	Meaning	Explanation	Action by operator
RED	Emergency	Hazardous condition	Immediate action to deal with hazardous condition (for example switching off the machine supply, being alert to the hazardous condition and staying clear of the machine)
YELLOW	Abnormal	Abnormal condition Impending critical condition	Monitoring and/or intervention (for example by re-establishing the intended function)
BLUE	Mandatory	Indication of a condition that requires action by the operator	Mandatory action
GREEN	Normal	Normal condition	Optional
WHITE	Neutral	Other conditions; may be used whenever doubt exists about the application of RED, YELLOW, GREEN, BLUE	Monitoring

Indicating towers on machines should have the applicable colours in the following order from the top down; RED, YELLOW, BLUE, GREEN and WHITE.

10.3.3 Flashing lights and displays

For further distinction or information and especially to give additional emphasis, flashing lights and displays can be provided for the following purposes:

- to attract attention;
- to request immediate action;
- to indicate a discrepancy between the command and actual state;
- to indicate a change in process (flashing during transition).

It is recommended that higher frequency flashing lights or display be used for higher priority information (see IEC 60073 for recommended flashing rates and pulse/pause ratios).

Where flashing lights or displays are used to provide higher priority information, audible warning devices should also be provided.

10.4 Illuminated push-buttons

Illuminated push-button actuators shall be colour-coded in accordance with Tables 2 and 4. Where there is difficulty in assigning an appropriate colour, WHITE shall be used. The colour RED for the emergency stop actuator shall not depend on the illumination of its light.

10.5 Rotary control devices

Devices having a rotational member, such as potentiometers and selector switches, shall have means of prevention of rotation of the stationary member. Friction alone shall not be considered sufficient.

10.6 Start devices

Actuators used to initiate a start function or the movement of machine elements (for example slides, spindles, carriers) shall be constructed and mounted so as to minimize inadvertent operation. However, mushroom-type actuators may be used for two-hand control (see also ISO 13851).

10.7 Emergency stop devices

10.7.1 Location of emergency stop devices

Devices for emergency stop shall be readily accessible.

Emergency stop devices shall be located at each operator control station and at other locations where the initiation of an emergency stop can be required (**exception**: see 9.2.7.3).

There can be circumstances where confusion can occur between active and inactive emergency stop devices caused by disabling the operator control station. In such cases, means (for example, information for use) shall be provided to minimise confusion.

10.7.2 Types of emergency stop device

The types of device for emergency stop include:

- a push-button operated switch with a palm or mushroom head type;
- a pull-cord operated switch;
- a pedal-operated switch without a mechanical guard.

The devices shall have direct opening operation (see IEC 60947-5-1, Annex K).

10.7.3 Colour of actuators

Actuators of emergency stop devices shall be coloured RED. If a background exists immediately around the actuator, then this background shall be coloured YELLOW. See also ISO 13850.

10.7.4 Local operation of the supply disconnecting device to effect emergency stop

The supply disconnecting device may be locally operated to serve the function of emergency stop when:

- it is readily accessible to the operator; and
- it is of the type described in 5.3.2 a), b), c), or d).

When also intended for such use, the supply disconnecting device shall meet the colour requirements of 10.7.3.

10.8 Emergency switching off devices

10.8.1 Location of emergency switching off devices

Emergency switching off devices shall be located as necessary for the given application. Normally, those devices will be located separate from operator control stations. Where it is necessary to provide a control station with an emergency stop device and an emergency switching off device, means shall be provided to avoid confusion between these devices.

NOTE This can be achieved by, for example, the provision of a break-glass enclosure for the emergency switching off device.

10.8.2 Types of emergency switching off device

The types of device for emergency switching off include:

- a push-button operated switch with a palm or mushroom head type of actuator;
- a pull-cord operated switch.

The devices shall have direct opening action (see IEC 60947-5-1, Annex K).

The push-button operated switch may be in a break-glass enclosure.

10.8.3 Colour of actuators

Actuators of emergency switching off devices shall be coloured RED. If a background exists immediately around the actuator, then this background shall be coloured YELLOW.

Where confusion can occur between emergency stop and emergency switching off devices, means shall be provided to minimise confusion.

10.8.4 Local operation of the supply disconnecting device to effect emergency switching off

Where the supply disconnecting device is to be locally operated for emergency switching off, it shall be readily accessible and should meet the colour requirements of 10.8.3.

10.9 Enabling control device

When an enabling control device is provided as a part of a system, it shall signal the enabling control to allow operation when actuated in one position only. In any other position, operation shall be stopped or prevented.

Enabling control devices shall be selected and arranged so as to minimize the possibility of defeating.

Enabling control devices shall be selected that have the following features:

- designed in accordance with ergonomic principles;
- for a two-position type:
 - position 1: off-function of the switch (actuator is not operated);
 - position 2: enabling function (actuator is operated).
- for a three-position type:
 - position 1: off-function of the switch (actuator is not operated);
 - position 2: enabling function (actuator is operated in its mid position);
 - position 3: off-function (actuator is operated past its mid position);
 - when returning from position 3 to position 2, the enabling function is not activated.

NOTE The enabling control function is described in 9.2.6.3.

11 Controlgear: location, mounting, and enclosures

11.1 General requirements

All controlgear shall be located and mounted so as to facilitate:

- its accessibility and maintenance;
- its protection against the external influences or conditions under which it is intended to operate;
- operation and maintenance of the machine and its associated equipment.

11.2 Location and mounting

11.2.1 Accessibility and maintenance

All items of controlgear shall be placed and oriented so that they can be identified without moving them or the wiring. For items that require checking for correct operation or that are liable to need replacement, those actions should be possible without dismantling other equipment or parts of the machine (except opening doors or removing covers, barriers or obstacles). Terminals not part of controlgear components or devices shall also conform to these requirements.

All controlgear shall be mounted so as to facilitate its operation and maintenance from the front. Where a special tool is necessary to adjust, maintain, or remove a device, such a tool shall be supplied. Where access is required for regular maintenance or adjustment, the relevant devices shall be located between 0,4 m and 2,0 m above the servicing level. It is recommended that terminals be at least 0,2 m above the servicing level and be so placed that conductors and cables can be easily connected to them.

No devices except devices for operating, indicating, measuring, and cooling shall be mounted on doors or on normally removable access covers of enclosures. Where control devices are connected through plug-in arrangements, their association shall be made clear by type (shape), marking or reference designation, singly or in combination (see 13.4.5).

Plug-in devices that are handled during normal operation shall be provided with non-interchangeable features where the lack of such a facility can result in malfunctioning.

Plug/socket combinations that are handled during normal operation shall be located and mounted so as to provide unobstructed access.

Test points for connection of test equipment, where provided, shall be:

- mounted so as to provide unobstructed access;
- clearly identified to correspond with the documentation (see 17.3);
- adequately insulated;
- sufficiently spaced.

11.2.2 Physical separation or grouping

Non-electrical parts and devices, not directly associated with the electrical equipment, shall not be located within enclosures containing controlgear. Devices such as solenoid valves should be separated from the other electrical equipment (for example in a separate compartment).

Control devices mounted in the same location and connected to the supply voltage, or to both supply and control voltages, shall be grouped separately from those connected only to the control voltages.

Terminals shall be separated into groups for:

- power circuits;
- associated control circuits;
- other control circuits, fed from external sources (for example for interlocking).

The groups may be mounted adjacently, provided that each group can be readily identified (for example by markings, by use of different sizes, by use of barriers or by colours).

When arranging the location of devices (including interconnections), the clearances and creepage distances specified for them by the supplier shall be maintained, taking into account the external influences or conditions of the physical environment.

11.2.3 Heating effects

Heat generating components (for example heat sinks, power resistors) shall be so located that the temperature of each component in the vicinity remains within the permitted limit.

11.3 Degrees of protection

The protection of controlgear against ingress of solid foreign objects and of liquids shall be adequate taking into account the external influences under which the machine is intended to operate (i.e. the location and the physical environmental conditions) and shall be sufficient against dust, coolants, and swarf.

NOTE 1 Requirements for protection against electric shock are given in Clause 6.

NOTE 2 The degrees of protection against ingress of water are covered by IEC 60529. Additional protective measures can be necessary against other liquids.

Enclosures of controlgear shall provide a degree of protection of at least IP22 (see IEC 60529).

Exceptions:

- a) Where an electrical operating area is used as a protective enclosure for an appropriate degree of protection against the ingress of solid bodies and liquids.
- b) Where removable collectors on conductor wire or conductor bar systems are used and IP22 is not achieved, but the measures of 6.2.5 are applied.

NOTE 3 Some examples of applications, along with the degree of protection typically provided by their enclosures, are listed below:

– ventilated enclosure, containing only motor starter resistor and other large size equipment	IP10
– ventilated enclosure, containing other equipment	IP32
– enclosure used in general industry	IP32, IP43 and IP54
– enclosure used in locations that are cleaned with low-pressure water jets (hosing)	IP55
– enclosure providing protection against fine dust	IP65
– enclosure containing slip-ring assemblies	IP2X

Depending upon the conditions where installed, another degree of protection can be appropriate.

11.4 Enclosures, doors and openings

Enclosures shall be constructed using materials capable of withstanding the mechanical, electrical and thermal stresses as well as the effects of humidity and other environmental factors that are likely to be encountered in normal service.

Fasteners used to secure doors and covers should be of the captive type. Windows provided for viewing internally mounted indicating devices shall be of a material suitable to withstand mechanical stress and chemical attack (for example toughened glass or polycarbonate sheet of not less than 3 mm thickness).

It is recommended that enclosure doors be not wider than 0,9 m and have vertical hinges, with an angle of opening of at least 95°.

The joints or gaskets of doors, lids, covers and enclosures shall withstand the chemical effects of the aggressive liquids, vapours, or gases used on the machine. The means provided to maintain the degree of protection of an enclosure on doors, lids and covers that require opening or removal for operation or maintenance shall:

- be securely attached to either the door/cover or the enclosure;
- not deteriorate due to removal or replacement of the door or the cover, and so impair the degree of protection.

Where openings in enclosures are provided (for example, for cable access), including those towards the floor or foundation or to other parts of the machine, means shall be provided to ensure the degree of protection specified for the equipment. Openings for cable entries shall be easily re-opened on site. A suitable opening may be provided in the base of enclosures within the machine so that moisture due to condensation can drain away.

There shall be no opening between enclosures containing electrical equipment and compartments containing coolant, lubricating or hydraulic fluids, or those into which oil, other liquids, or dust can penetrate. This requirement does not apply to electrical devices specifically designed to operate in oil (for example electromagnetic clutches) nor to electrical equipment in which coolants are used.

Where there are holes in an enclosure for mounting purposes, means may be necessary to ensure that after mounting, the holes do not impair the required protection.

Equipment that, in normal or abnormal operation, can attain a surface temperature sufficient to cause a risk of fire or harmful effect to an enclosure material shall:

- be located within an enclosure that will withstand, without risk of fire or harmful effect, such temperatures as can be generated; and
- be mounted and located at a sufficient distance from adjacent equipment so as to allow safe dissipation of heat (see also 11.2.3); or
- be otherwise screened by material that can withstand, without risk of fire or harmful effect, the heat emitted by the equipment.

NOTE A warning label in accordance with 16.2.2 may be necessary.

11.5 Access to controlgear

Doors in gangways and for access to electrical operating areas shall:

- be at least 0,7 m wide and 2,1 m high;
- open outwards;
- have a means (for example panic bolts) to allow opening from the inside without the use of a key or tool.

Enclosures which readily allow a person to fully enter shall be provided with means to allow escape, for example panic bolts on the inside of doors. Enclosures intended for such access, for example for resetting, adjusting, maintenance, shall have a clear width of at least 0,7 m and a clear height of at least 2,1 m.

In cases where:

- equipment is likely to be live during access; and
- conducting parts are exposed,

the clear width shall be at least 1,0 m. In cases where such parts are present on both sides of the access way, the clear width shall be at least 1,5 m.

NOTE These dimensions are derived from ISO 14122 series.

12 Conductors and cables

12.1 General requirements

Conductors and cables shall be selected so as to be suitable for the operating conditions (for example voltage, current, protection against electric shock, grouping of cables) and external influences (for example ambient temperature, presence of water or corrosive substances, mechanical stresses (including stresses during installation), fire hazards) that can exist.

NOTE Further information is given in CENELEC HD 516 S2.

These requirements do not apply to the integral wiring of assemblies, subassemblies, and devices that are manufactured and tested in accordance with their relevant IEC standard (for example IEC 60439-1).

12.2 Conductors

In general, conductors shall be of copper. Where aluminium conductors are used, the cross-sectional area shall be at least 16 mm².

To ensure adequate mechanical strength, the cross-sectional area of conductors should not be less than as shown in Table 5. However, conductors with smaller cross-sectional areas or other constructions than shown in Table 5 may be used in equipment provided adequate mechanical strength is achieved by other means and proper functioning is not impaired.

NOTE Classification of conductors is given in Table D.4.

Table 5 – Minimum cross-sectional areas of copper conductors

Location		Type of conductor, cable				
		Single core		Multicore		
		Flexible Class 5 or 6	Solid (class 1) or stranded (class 2)	Two core, shielded	Two core not shielded	Three or more cores, shielded or not
Wiring outside (protecting) enclosures	Power circuits, fixed	1,0	1,5	0,75	0,75	0,75
	Power circuits, subjected to frequent movements	1,0	-	0,75	0,75	0,75
	Control circuits	1,0	1,0	0,2	0,5	0,2
	Data communication	-	-	-	-	0,08
Wiring inside enclosures ¹⁾	Power circuits (connections not moved)	0,75	0,75	0,75	0,75	0,75
	Control circuits	0,2	0,2	0,2	0,2	0,2
	Data communication	-	-	-	-	0,08

NOTE All cross-sections in mm².

¹⁾ Except special requirements of individual standards, see also 12.1.

Class 1 and class 2 conductors are primarily intended for use between rigid, non-moving parts.

All conductors that are subject to frequent movement (for example one movement per hour of machine operation) shall have flexible stranding of class 5 or class 6.

12.3 Insulation

The types of insulation include (but are not limited to):

- polyvinyl chloride (PVC);
- rubber, natural and synthetic;
- silicone rubber (SiR);
- mineral;
- cross-linked polyethylene (XLPE);
- ethylene propylene compound (EPR).

Where the insulation of conductors and cables (for example PVC) can constitute hazards due to the propagation of a fire or the emission of toxic or corrosive fumes, guidance from the cable supplier should be sought. It is important to give special attention to the integrity of a circuit having a safety-related function.

The insulation of cables and conductors used, shall be suitable for a test voltage:

- not less than 2 000 V a.c. for a duration of 5 min for operation at voltages higher than 50 V a.c. or 120 V d.c., or
- not less than 500 V a.c. for a duration of 5 min for PELV circuits (see IEC 60364-4-41, class III equipment).

The mechanical strength and thickness of the insulation shall be such that the insulation cannot be damaged in operation or during laying, especially for cables pulled into ducts.

12.4 Current-carrying capacity in normal service

The current-carrying capacity depends on several factors, for example insulation material, number of conductors in a cable, design (sheath), methods of installation, grouping and ambient temperature.

NOTE 1 Detailed information and further guidance can be found in IEC 60364-5-52, in some national standards or given by the manufacturer.

One typical example of the current-carrying capacities for PVC insulated wiring between enclosures and individual items of equipment under steady-state conditions is given in Table 6.

NOTE 2 For specific applications where the correct cable dimensioning can depend on the relationship between the period of the duty cycle and the thermal time constant of the cable (for example starting against high-inertia load, intermittent duty), the cable manufacturer should be consulted.

Table 6 – Examples of current-carrying capacity (I_z) of PVC insulated copper conductors or cables under steady-state conditions in an ambient air temperature of +40 °C for different methods of installation

Cross-sectional area mm ²	Installation method (see D.1.2)			
	B1	B2	C	E
	Current-carrying capacity I_z for three phase circuits A			
0,75	8,6	8,5	9,8	10,4
1,0	10,3	10,1	11,7	12,4
1,5	13,5	13,1	15,2	16,1
2,5	18,3	17,4	21	22
4	24	23	28	30
6	31	30	36	37
10	44	40	50	52
16	59	54	66	70
25	77	70	84	88
35	96	86	104	110
50	117	103	125	133
70	149	130	160	171
95	180	156	194	207
120	208	179	225	240
Electronic (pairs)				
0,20	Not applicable	4,3	4,4	4,4
0,5	Not applicable	7,5	7,5	7,8
0,75	Not applicable	9,0	9,5	10
<p>NOTE 1 The values of the current-carrying capacity of Table 6 are based on:</p> <ul style="list-style-type: none"> – one symmetrical three-phase circuit for cross-sectional areas 0,75 mm² and greater; – one control circuit pair for cross-sectional areas between 0,2 mm² and 0,75 mm². <p>Where more loaded cables/pairs are installed, derate the values of Table 6 in accordance with Tables D.2 or D.3.</p> <p>NOTE 2 For ambient temperatures other than 40 °C, correct the current-carrying capacities by using values given in Table D.1.</p> <p>NOTE 3 These values are not applicable to flexible cables wound on drums (see 12.6.3).</p> <p>NOTE 4 For the current-carrying capacities of other cables, see IEC 60364-5-52.</p>				

12.5 Conductor and cable voltage drop

The voltage drop from the point of supply to the load shall not exceed 5 % of the nominal voltage under normal operating conditions. In order to conform to this requirement, it can be necessary to use conductors having a larger cross-sectional area than that derived from Table 6.

12.6 Flexible cables

12.6.1 General

Flexible cables shall have Class 5 or Class 6 conductors.

NOTE 1 Class 6 conductors have smaller diameter strands and are more flexible than Class 5 conductors (see Table D.4).

Cables that are subjected to severe duties shall be of adequate construction to protect against:

- abrasion due to mechanical handling and dragging across rough surfaces;
- kinking due to operation without guides;
- stress resulting from guide rollers and forced guiding, being wound and re-wound on cable drums.

NOTE 2 Cables for such conditions are specified in relevant national standards.

NOTE 3 The operational life of the cable will be reduced where unfavourable operating conditions such as high tensile stress, small radii, bending into another plane and/or where frequent duty cycles coincide.

12.6.2 Mechanical rating

The cable handling system of the machine shall be so designed to keep the tensile stress of the conductors as low as is practicable during machine operations. Where copper conductors are used, the tensile stress applied to the conductors shall not exceed 15 N/mm² of the copper cross-sectional area. Where the demands of the application exceed the tensile stress limit of 15 N/mm², cables with special construction features should be used and the allowed maximal tensile stress should be agreed with the cable manufacturer.

The maximum stress applied to the conductors of flexible cables with material other than copper shall be within the cable manufacturer's specification.

NOTE The following conditions affect the tensile stress on the conductors:

- acceleration forces;
- speed of motion;
- dead (hanging) weight of the cables;
- method of guiding;
- design of cable drum system.

12.6.3 Current-carrying capacity of cables wound on drums

Cables to be wound on drums shall be selected with conductors having a cross-sectional area such that, when fully wound on the drum and carrying the normal service load, the maximum allowable conductor temperature is not exceeded.

For cables of circular cross-sectional area installed on drums, the maximum current-carrying capacity in free air should be derated in accordance with Table 7 (see also Clause 44 of IEC 60621-3).

NOTE The current-carrying capacity of cables in free air can be found in manufacturers' specifications or in relevant national standards.

Table 7 – Derating factors for cables wound on drums

Drum type	Number of layers of cable				
	Any number	1	2	3	4
Cylindrical ventilated	–	0,85	0,65	0,45	0,35
Radial ventilated	0,85	–	–	–	–
Radial non-ventilated	0,75	–	–	–	–

NOTE 1 A radial type drum is one where spiral layers of cable are accommodated between closely spaced flanges; if fitted with solid flanges, the drum is described as non-ventilated and if the flanges have suitable apertures, as ventilated.

NOTE 2 A ventilated cylinder drum is one where the layers of cable are accommodated between widely spaced flanges and the drum and end flanges have ventilating apertures.

NOTE 3 It is recommended that the use of derating factors be discussed with the cable and the cable drum manufacturers. This may result in other factors being used.

12.7 Conductor wires, conductor bars and slip-ring assemblies

12.7.1 Protection against direct contact

Conductor wires, conductor bars and slip-ring assemblies shall be installed or enclosed in such a way that, during normal access to the machine, protection against direct contact is achieved by the application of one of the following protective measures:

- protection by partial insulation of live parts, or where this is not practicable;
- protection by enclosures or barriers of at least IP2X (see 412.2 of IEC 60364-4-41).

Horizontal top surfaces of barriers or enclosures that are readily accessible shall provide a degree of protection of at least IP4X (see 412.2.2 of IEC 60364-4-41).

Where the required degree of protection is not achieved, protection by placing live parts out of reach in combination with emergency switching off in accordance with 9.2.5.4.3 shall be applied.

Conductor wires and conductor bars shall be so placed and/or protected as to:

- prevent contact, especially for unprotected conductor wires and conductor bars, with conductive items such as the cords of pull-cord switches, strain-relief devices and drive chains;
- prevent damage from a swinging load.

12.7.2 Protective conductor circuit

Where conductor wires, conductor bars and slip-ring assemblies are installed as part of the protective bonding circuit, they shall not carry current in normal operation. Therefore, the protective conductor (PE) and the neutral conductor (N) shall each use a separate conductor wire, conductor bar or slip-ring. The continuity of the protective conductor circuit using sliding contacts shall be ensured by taking appropriate measures (for example, duplication of the current collector, continuity monitoring).

12.7.3 Protective conductor current collectors

Protective conductor current collectors shall have a shape or construction so that they are not interchangeable with the other current collectors. Such current collectors shall be of the sliding contact type.

12.7.4 Removable current collectors with a disconnecter function

Removable current collectors having a disconnecter function shall be so designed that the protective conductor circuit is interrupted only after the live conductors have been disconnected, and the continuity of the protective conductor circuit is re-established before any live conductor is reconnected (see also 8.2.4).

12.7.5 Clearances in air

Clearances between the respective conductors, and between adjacent systems, of conductor wires, conductor bars, slip-ring assemblies and their current collectors shall be suitable for at least a rated impulse voltage of an overvoltage category III in accordance with IEC 60664-1.

12.7.6 Creepage distances

Creepage distances between the respective conductors, between adjacent systems of conductor wires, conductor bars and slip-ring assemblies, and their current collectors shall be suitable for operation in the intended environment, for example open air (IEC 60664-1), inside buildings, protected by enclosures.

In abnormally dusty, moist or corrosive environments, the following creepage distance requirements apply:

- unprotected conductor wires, conductor bars, and slip-ring assemblies shall be equipped with insulators with a minimum creepage distance of 60 mm;
- enclosed conductor wires, insulated multipole conductor bars and insulated individual conductor bars shall have a minimum creepage distance of 30 mm.

The manufacturer's recommendations shall be followed regarding special measures to prevent a gradual reduction in the insulation values due to unfavourable ambient conditions (for example deposits of conductive dust, chemical attack).

12.7.7 Conductor system sectioning

Where conductor wires or conductor bars are arranged so that they can be divided into isolated sections, suitable design measures shall be employed to prevent the energization of adjacent sections by the current collectors themselves.

12.7.8 Construction and installation of conductor wire, conductor bar systems and slip-ring assemblies

Conductor wires, conductor bars and slip-ring assemblies in power circuits shall be grouped separately from those in control circuits.

Conductor wires, conductor bars and slip-ring assemblies shall be capable of withstanding, without damage, the mechanical forces and thermal effects of short-circuit currents.

Removable covers for conductor wire and conductor bar systems laid underground or underfloor shall be so designed that they cannot be opened by one person without the aid of a tool.

Where conductor bars are installed in a common metal enclosure, the individual sections of the enclosure shall be bonded together and connected to a protective bonding conductor at several points depending upon their length. Metal covers of conductor bars laid underground or underfloor shall also be bonded together and connected to a protective bonding conductor.

Ⓒ The protective bonding circuit shall include the covers or cover plates of metal enclosures or underfloor ducts. Where metal hinges form a part of the bonding circuit, their continuity shall be verified (see Clause 18). Ⓒ

Underground and underfloor conductor bar ducts shall have drainage facilities.

13 Wiring practices

13.1 Connections and routing

13.1.1 General requirements

All connections, especially those of the protective bonding circuit, shall be secured against accidental loosening.

The means of connection shall be suitable for the cross-sectional areas and nature of the conductors being terminated.

The connection of two or more conductors to one terminal is permitted only in those cases where the terminal is designed for that purpose. However, only one protective conductor shall be connected to one terminal connecting point.

Soldered connections shall only be permitted where terminals are provided that are suitable for soldering.

Terminals on terminal blocks shall be plainly marked or labelled to correspond with markings on the diagrams.

Where an incorrect electrical connection (for example, arising from replacement of devices) can be a source of risk and it is not practicable to reduce the possibility of incorrect connection by design measures, the conductors and/or terminations shall be identified in accordance with 13.2.1.

The installation of flexible conduits and cables shall be such that liquids shall drain away from the fittings.

Means of retaining conductor strands shall be provided when terminating conductors at devices or terminals that are not equipped with this facility. Solder shall not be used for that purpose.

Shielded conductors shall be so terminated as to prevent fraying of strands and to permit easy disconnection.

Identification tags shall be legible, permanent, and appropriate for the physical environment.

Terminal blocks shall be mounted and wired so that the internal and external wiring does not cross over the terminals (see IEC 60947-7-1).

13.1.2 Conductor and cable runs

Conductors and cables shall be run from terminal to terminal without splices or joints. Connections using plug/socket combinations with suitable protection against accidental disconnection are not considered to be joints for the purpose of this Subclause.

Exception: Where it is impracticable to provide terminals in a junction box (for example on mobile machines, on machines having long flexible cables; cable connections exceeding a length which is not practical to be supplied by the cable manufacturer on one cable drum; repair of cable due to mechanical stresses during installation and operation), splices or joints may be used.

Where it is necessary to connect and disconnect cables and cable assemblies, a sufficient extra length shall be provided for that purpose.

The terminations of cables shall be adequately supported to prevent mechanical stresses at the terminations of the conductors.

Wherever practicable, the protective conductor shall be placed close to the associated live conductors in order to decrease the impedance of the loop.

13.1.3 Conductors of different circuits

Conductors of different circuits may be laid side by side, may occupy the same duct (for example conduit, cable trunking system), or may be in the same multiconductor cable provided that the arrangement does not impair the proper functioning of the respective circuits. Where those circuits operate at different voltages, the conductors shall be separated by suitable barriers or shall be insulated for the highest voltage to which any conductor within the same duct can be subjected, for example line to line voltage for unearthed systems and phase to earth voltage for earthed systems.

13.1.4 Connection between pick-up and pick-up converter of an inductive power supply system

The cable between the pick-up and the pick-up converter as specified by the manufacturer of the inductive power supply shall be:

- as short as practicable;
- adequately protected against mechanical damage.

NOTE The output of the pick-up can be a current source, therefore damage to the cable can result in a high voltage hazard.

13.2 Identification of conductors

13.2.1 General requirements

Each conductor shall be identifiable at each termination in accordance with the technical documentation (see Clause 17).

It is recommended (for example to facilitate maintenance) that conductors be identified by number, alphanumeric, colour (either solid or with one or more stripes), or a combination of colour and numbers or alphanumeric. When numbers are used, they shall be Arabic; letters shall be Roman (either upper or lower case).

NOTE Annex B can be used for agreement between supplier and user regarding a preferred method of identification.

13.2.2 Identification of the protective conductor

The protective conductor shall be readily distinguishable by shape, location, marking, or colour. When identification is by colour alone, the bicolour combination GREEN-AND-YELLOW shall be used throughout the length of the conductor. This colour identification is strictly reserved for the protective conductor.

For insulated conductors, the bicolour combination GREEN-AND-YELLOW shall be such that on any 15 mm length, one of the colours covers at least 30 % and not more than 70 % of the surface of the conductor, the other colour covering the remainder of the surface.

Where the protective conductor can be easily identified by its shape, position, or construction (for example a braided conductor, uninsulated stranded conductor), or where the insulated conductor is not readily accessible, colour coding throughout its length is not necessary but the ends or accessible locations shall be clearly identified by the graphical symbol IEC 60417-5019 (DB:2002-10) or by the bicolour combination GREEN-AND-YELLOW.

13.2.3 Identification of the neutral conductor

Where a circuit includes a neutral conductor that is identified by colour alone, the colour used for this conductor shall be BLUE. In order to avoid confusion with other colours, it is recommended that an unsaturated blue be used, called here "light blue" (see 3.2.2 of IEC 60446). Where the selected colour is the sole identification of the neutral conductor, that colour shall not be used for identifying any other conductor where confusion is possible.

Where identification by colour is used, bare conductors used as neutral conductors shall be either coloured by a stripe, 15 mm to 100 mm wide in each compartment or unit and at each accessible location, or coloured throughout their length.

13.2.4 Identification by colour

Where colour-coding is used for identification of conductors (other than the protective conductor (see 13.2.2) and the neutral conductor (see 13.2.3)), the following colours may be used:

BLACK, BROWN, RED, ORANGE, YELLOW, GREEN, BLUE (including LIGHT BLUE), VIOLET, GREY, WHITE, PINK, TURQUOISE.

NOTE This list of colours is derived from IEC 60757.

It is recommended that, where colour is used for identification, the colour be used throughout the length of the conductor either by the colour of the insulation or by colour markers at regular intervals and at the ends or accessible location.

For safety reasons, the colour GREEN or the colour YELLOW should not be used where there is a possibility of confusion with the bicolour combination GREEN-AND-YELLOW (see 13.2.2).

Colour identification using combinations of those colours listed above may be used provided there can be no confusion and that GREEN or YELLOW is not used except in the bicolour combination GREEN-AND-YELLOW.

Where colour-coding is used for identification of conductors, it is recommended that they be colour-coded as follows:

- BLACK: a.c. and d.c. power circuits;
- RED: a.c. control circuits;

- BLUE: d.c. control circuits;
- ORANGE: excepted circuits in accordance with 5.3.5.

Exceptions: to the above are permitted where:

- insulation is used that is not available in the colours recommended; or
- multiconductor cable is used, but not the bicolour combination GREEN-AND-YELLOW.

13.3 Wiring inside enclosures

Conductors inside enclosures shall be supported where necessary to keep them in place. Non-metallic ducts shall be permitted only when they are made with a flame-retardant insulating material (see the IEC 60332 series).

It is recommended that electrical equipment mounted inside enclosures be designed and constructed in such a way as to permit modification of the wiring from the front of the enclosure (see also 11.2.1). Where that is not practicable and control devices are connected from the rear of the enclosure, access doors or swingout panels shall be provided.

Connections to devices mounted on doors or to other movable parts shall be made using flexible conductors in accordance with 12.2 and 12.6 to allow for the frequent movement of the part. The conductors shall be anchored to the fixed part and to the movable part independently of the electrical connection (see also 8.2.3 and 11.2.1).

Conductors and cables that do not run in ducts shall be adequately supported.

Terminal blocks or plug/socket combinations shall be used for control wiring that extends beyond the enclosure. For plug/socket combinations, see also 13.4.5 and 13.4.6.

Power cables and cables of measuring circuits may be directly connected to the terminals of the devices for which the connections were intended.

13.4 Wiring outside enclosures

13.4.1 General requirements

The means of introduction of cables or ducts with their individual glands, bushings, etc., into an enclosure shall ensure that the degree of protection is not reduced (see 11.3).

13.4.2 External ducts

Conductors and their connections external to the electrical equipment enclosure(s) shall be enclosed in suitable ducts (i.e. conduit or cable trunking systems) as described in 13.5 except for suitably protected cables that may be installed without ducts and with or without the use of open cable trays or cable support means. Where devices such as position switches or proximity switches are supplied with a dedicated cable, their cable need not be enclosed in a duct when the cable is suitable for the purpose, sufficiently short, and so located or protected, that the risk of damage is minimized.

Fittings used with ducts or multiconductor cable shall be suitable for the physical environment.

Flexible conduit or flexible multiconductor cable shall be used where it is necessary to employ flexible connections to pendant push-button stations. The weight of the pendant stations shall be supported by means other than the flexible conduit or the flexible multiconductor cable, except where the conduit or cable is specifically designed for that purpose.

13.4.3 Connection to moving elements of the machine

Connections to frequently moving parts shall be made using conductors in accordance with 12.2 and 12.6. Flexible cable and flexible conduit shall be so installed as to avoid excessive flexing and straining, particularly at the fittings.

Cables subject to movement shall be supported in such a way that there is no mechanical strain on the connection points nor any sharp flexing. When this is achieved by the provision of a loop, it shall have sufficient length to provide for a bending radius of the cable of at least 10 times the diameter of the cable.

Flexible cables of machines shall be so installed or protected as to minimize the possibility of external damage due to factors that include the following cable use or potential abuse:

- being run over by the machine itself;
- being run over by vehicles or other machines;
- coming into contact with the machine structure during movements;
- running in and out of cable baskets, or on or off cable drums;
- acceleration forces and wind forces on festoon systems or suspended cables;
- excessive rubbing by cable collector;
- exposure to excessive radiated heat.

The cable sheath shall be resistant to the normal wear that can be expected from movement and to the effects of environmental contaminants (for example oil, water, coolants, dust).

Where cables subject to movement are close to moving parts, precautions shall be taken to maintain a space of at least 25 mm between the moving parts and the cables. Where that distance is not practicable, fixed barriers shall be provided between the cables and the moving parts.

The cable handling system shall be so designed that lateral cable angles do not exceed 5°, avoiding torsion in the cable when:

- being wound on and off cable drums; and
- approaching and leaving cable guidance devices.

Measures shall be taken to ensure that at least two turns of flexible cables always remain on a drum.

Devices serving to guide and carry a flexible cable shall be so designed that the inner bending radius at all points where the cable is bent is not less than the values given in Table 8, unless otherwise agreed with the cable manufacturer, taking into account the permissible tension and the expected fatigue life.

Table 8 – Minimum permitted bending radii for the forced guiding of flexible cables

Application	Cable diameter or thickness of flat cable (<i>d</i>) mm		
	$d \leq 8$	$8 < d \leq 20$	$d > 20$
Cable drums	$6 d$	$6 d$	$8 d$
Guide rollers	$6 d$	$8 d$	$8 d$
Festoon systems	$6 d$	$6 d$	$8 d$
All others	$6 d$	$6 d$	$8 d$

The straight section between two bends shall be at least 20 times the diameter of the cable.

Where flexible conduit is adjacent to moving parts, the construction and supporting means shall prevent damage to the flexible conduit under all conditions of operation.

Flexible conduit shall not be used for connections subject to rapid or frequent movements except when specifically designed for that purpose.

13.4.4 Interconnection of devices on the machine

Where several machine-mounted switching devices (for example position sensors, push-buttons) are connected in series or in parallel, it is recommended that the connections between those devices be made through terminals forming intermediate test points. Such terminals shall be conveniently placed, adequately protected, and shown on the relevant diagrams.

13.4.5 Plug/socket combinations

Where plug/socket combinations are provided, they shall fulfil one or more of the following requirements as applicable:

Exception: The following requirements do not apply to components or devices inside an enclosure, terminated by fixed plug/socket combinations (no flexible cable), or components connected to a bus system by a plug/socket combination.

- When installed correctly in accordance with f), plug/socket combinations shall be of such a type as to prevent unintentional contact with live parts at any time, including during insertion or removal of the connectors. The degree of protection shall be at least IPXXB. PELV circuits are excepted from this requirement.
- Have a first make last break protective bonding contact (earthing contact) (see also 6.3, 8.2.4) if used in TN- or TT-systems.
- Plug/socket combinations intended to be connected or disconnected during load conditions shall have sufficient load-breaking capacity. Where the plug/socket combination is rated at 30 A, or greater, it shall be interlocked with a switching device so that the connection and disconnection is possible only when the switching device is in the OFF position.
- Plug/socket combinations that are rated at more than 16 A shall have a retaining means to prevent unintended or accidental disconnection.
- Where an unintended or accidental disconnection of plug/socket combinations can cause a hazardous situation, they shall have a retaining means.

The installation of plug/socket combinations shall fulfil the following requirements as applicable:

- f) The component which remains live after disconnection shall have a degree of protection of at least IP2X or IPXXB, taking into account the required clearance and creepage distances. PELV circuits are excepted from this requirement.
- g) Metallic housings of plug/socket combinations shall be connected to the protective bonding circuit. PELV circuits are excepted from this requirement.
- h) Plug/socket combinations intended to carry power loads but not to be disconnected during load conditions shall have a retaining means to prevent unintended or accidental disconnection and shall be clearly marked that they are not intended to be disconnected under load.
- i) Where more than one plug/socket combination is provided in the same electrical equipment, the associated combinations shall be clearly identifiable. It is recommended that mechanical coding be used to prevent incorrect insertion.
- j) Plug/socket combinations used in control circuits shall fulfil the applicable requirements of IEC 61984. **Exception:** see item k).
- k) Plug/socket combinations intended for household and similar general purposes shall not be used for control circuits. In plug/socket combinations in accordance with IEC 60309-1, only those contacts shall be used for control circuits which are intended for those purposes.

Exception: The requirements of item k) do not apply to control functions using high frequency signals on the power supply.

13.4.6 Dismantling for shipment

Where it is necessary that wiring be disconnected for shipment, terminals or plug/socket combinations shall be provided at the sectional points. Such terminals shall be suitably enclosed and plug/socket combinations shall be protected from the physical environment during transportation and storage.

13.4.7 Additional conductors

Consideration should be given to providing additional conductors for maintenance or repair. When spare conductors are provided, they shall be connected to spare terminals or isolated in such a manner as to prevent contact with live parts.

13.5 Ducts, connection boxes and other boxes

13.5.1 General requirements

Ducts shall provide a degree of protection suitable for the application (see IEC 60529).

All sharp edges, flash, burrs, rough surfaces, or threads with which the insulation of the conductors can come in contact shall be removed from ducts and fittings. Where necessary, additional protection consisting of a flame-retardant, oil-resistant insulating material shall be provided to protect conductor insulation.

Drain holes of 6 mm diameter are permitted in cable trunking systems, connection boxes, and other boxes used for wiring purposes that can be subject to accumulations of oil or moisture.

In order to prevent confusion of conduits with oil, air, or water piping, it is recommended that the conduits be either physically separated or suitably identified.

Ducts and cable trays shall be rigidly supported and positioned at a sufficient distance from moving parts and in such a manner so as to minimize the possibility of damage or wear. In areas where human passage is required, the ducts and cable trays shall be mounted at least 2 m above the working surface.

Ducts shall be provided only for mechanical protection (see 8.2.3 for requirements for connection to the protective bonding circuit).

Cable trays that are partially covered should not be considered to be ducts or cable trunking systems (see 13.5.6), and the cables used shall be of a type suitable for installation with or without the use of open cable trays or cable support means.

13.5.2 Percentage fill of ducts

Consideration of the percentage fill of ducts should be based on the straightness and length of the duct and the flexibility of the conductors. It is recommended that the dimensions and arrangement of the ducts be such as to facilitate the insertion of the conductors and cables.

13.5.3 Rigid metal conduit and fittings

Rigid metal conduit and fittings shall be of galvanized steel or of a corrosion-resistant material suitable for the conditions. The use of dissimilar metals in contact that can cause galvanic action should be avoided.

Conduits shall be securely held in place and supported at each end.

Fittings shall be compatible with the conduit and appropriate for the application. Fittings shall be threaded unless structural difficulties prevent assembly. Where threadless fittings are used, the conduit shall be securely fastened to the equipment.

Conduit bends shall be made in such a manner that the conduit shall not be damaged and the internal diameter of the conduit shall not be effectively reduced.

13.5.4 Flexible metal conduit and fittings

A flexible metal conduit shall consist of a flexible metal tubing or woven wire armour. It shall be suitable for the expected physical environment.

Fittings shall be compatible with the conduit and appropriate for the application.

13.5.5 Flexible non-metallic conduit and fittings

Flexible non-metallic conduit shall be resistant to kinking and shall have physical characteristics similar to those of the sheath of multiconductor cables.

The conduit shall be suitable for use in the expected physical environment.

Fittings shall be compatible with the conduit and appropriate for the application.

13.5.6 Cable trunking systems

Cable trunking systems external to enclosures shall be rigidly supported and clear of all moving or contaminating portions of the machine.

Covers shall be shaped to overlap the sides; gaskets shall be permitted. Covers shall be attached to cable trunking systems by suitable means. On horizontal cable trunking systems, the cover shall not be on the bottom unless specifically designed for such installation.

NOTE Requirements for cable trunking and ducting systems for electrical installations are given in the IEC 61084 series.

Where the cable trunking system is furnished in sections, the joints between sections shall fit tightly but need not be gasketed.

The only openings permitted shall be those required for wiring or for drainage. Cable trunking systems shall not have opened but unused knockouts.

13.5.7 Machine compartments and cable trunking systems

The use of compartments or cable trunking systems within the column or base of a machine to enclose conductors is permitted provided the compartments or cable trunking systems are isolated from coolant or oil reservoirs and are entirely enclosed. Conductors run in enclosed compartments and cable trunking systems shall be so secured and arranged that they are not subject to damage.

13.5.8 Connection boxes and other boxes

Connection boxes and other boxes used for wiring purposes shall be accessible for maintenance. Those boxes shall provide protection against the ingress of solid bodies and liquids, taking into account the external influences under which the machine is intended to operate (see 11.3).

Those boxes shall not have opened but unused knockouts nor any other openings and shall be so constructed as to exclude materials such as dust, flyings, oil, and coolant.

13.5.9 Motor connection boxes

Motor connection boxes shall enclose only connections to the motor and motor-mounted devices (for example brakes, temperature sensors, plugging switches, tachometer generators).

14 Electric motors and associated equipment

14.1 General requirements

Electric motors should conform to the relevant parts of IEC 60034 series.

The protection requirements for motors and associated equipment are given in 7.2 for overcurrent protection, in 7.3 for overload protection, and in 7.6 for overspeed protection.

As many controllers do not switch off the supply to a motor when it is at rest, care shall be taken to ensure compliance with the requirements of 5.3, 5.4, 5.5, 7.5, 7.6 and 9.4. Motor control equipment shall be located and mounted in accordance with Clause 11.

14.2 Motor enclosures

It is recommended that motor enclosures be chosen from those included in IEC 60034-5.

The degree of protection shall be at least IP23 (see IEC 60529) for all motors. More stringent requirements can be needed depending on the application and the physical environment (see 4.4). Motors incorporated as an integral part of the machine shall be so mounted that they are adequately protected from mechanical damage.

14.3 Motor dimensions

As far as is practicable, the dimensions of motors shall conform to those given in the IEC 60072 series.

14.4 Motor mounting and compartments

Each motor and its associated couplings, belts, pulleys, or chains, shall be so mounted that they are adequately protected and are easily accessible for inspection, maintenance, adjustment and alignment, lubrication, and replacement. The motor mounting arrangement shall be such that all motor hold-down means can be removed and all terminal boxes are accessible.

Motors shall be so mounted that proper cooling is ensured and the temperature rise remains within the limits of the insulation class (see IEC 60034-1).

Where practicable, motor compartments should be clean and dry, and when required, shall be ventilated directly to the exterior of the machine. The vents shall be such that ingress of swarf, dust, or water spray is at an acceptable level.

There shall be no opening between the motor compartment and any other compartment that does not meet the motor compartment requirements. Where a conduit or pipe is run into the motor compartment from another compartment not meeting the motor compartment requirements, any clearance around the conduit or pipe shall be sealed.

14.5 Criteria for motor selection

The characteristics of motors and associated equipment shall be selected in accordance with the anticipated service and physical environmental conditions (see 4.4). In this respect, the points that shall be considered include:

- type of motor;
- type of duty cycle (see IEC 60034-1);
- fixed speed or variable speed operation, (and the consequent variable influence of the ventilation);
- mechanical vibration;
- type of motor control;

- influence of the harmonic spectrum of the voltage and/or current feeding the motor (particularly when it is supplied from a static converter) on the temperature rise;
- method of starting and the possible influence of the inrush current on the operation of other users of the same power supply, taking also into account possible special considerations stipulated by the supply authority;
- variation of counter-torque load with time and speed;
- influence of loads with large inertia;
- influence of constant torque or constant power operation;
- possible need of inductive reactors between motor and converter.

14.6 Protective devices for mechanical brakes

Operation of the overload and overcurrent protective devices for mechanical brake actuators shall initiate the simultaneous de-energization (release) of the associated machine actuators.

NOTE Associated machine actuators are those associated with the same motion, for example cable drums and long-travel drives.

15 Accessories and lighting

15.1 Accessories

Where the machine or its associated equipment is provided with socket-outlets that are intended to be used for accessory equipment (for example hand-held power tools, test equipment), the following apply:

- the socket-outlets should conform to IEC 60309-1. Where that is not practicable, they should be clearly marked with the voltage and current ratings;
- the continuity of the protective bonding circuit to the socket-outlet shall be ensured except where protection is provided by PELV;
- all unearthed conductors connected to the socket-outlet shall be protected against overcurrent and, when required, against overload in accordance with 7.2 and 7.3 separately from the protection of other circuits;
- where the power supply to the socket-outlet is not disconnected by the supply disconnecting device for the machine or the section of the machine, the requirements of 5.3.5 apply.

NOTE 1 See also Annex B.

NOTE 2 Circuits for socket-outlets can be provided with residual current protective devices (RCDs).

15.2 Local lighting of the machine and equipment

15.2.1 General

Connections to the protective bonding circuit shall be in accordance with 8.2.2.

The ON/OFF switch shall not be incorporated in the lampholder or in the flexible connecting cords.

Stroboscopic effects from lights shall be avoided by the selection of appropriate luminaires.

Where fixed lighting is provided in an enclosure, electromagnetic compatibility should be taken into account using the principles outlined in 4.4.2.

15.2.2 Supply

The nominal voltage of the local lighting circuit shall not exceed 250 V between conductors. A voltage not exceeding 50 V between conductors is recommended.

Lighting circuits shall be supplied from one of the following sources (see also 7.2.6):

- a dedicated isolating transformer connected to the load side of the supply disconnecting device. Overcurrent protection shall be provided in the secondary circuit;
- a dedicated isolating transformer connected to the line side of the supply disconnecting device. That source shall be permitted for maintenance lighting circuits in control enclosures only. Overcurrent protection shall be provided in the secondary circuit (see also 5.3.5 and 13.1.3);
- a machine circuit with dedicated overcurrent protection;
- an isolating transformer connected to the line side of the supply disconnecting device, provided with a dedicated primary disconnecting means (see 5.3.5) and secondary overcurrent protection, and mounted within the control enclosure adjacent to the supply disconnecting device (see also 13.1.3);
- an externally supplied lighting circuit (for example factory lighting supply). This shall be permitted in control enclosures only, and for the machine work light(s) where their total power rating is not more than 3 kW.

Exception: where fixed lighting is out of reach of operators during normal operations, the provisions of this Subclause do not apply.

15.2.3 Protection

Local lighting circuits shall be protected in accordance with 7.2.6.

15.2.4 Fittings

Adjustable lighting fittings shall be suitable for the physical environment.

The lampholders shall be:

- in accordance with the relevant IEC standard;
- constructed with an insulating material protecting the lamp cap so as to prevent unintentional contact.

Reflectors shall be supported by a bracket and not by the lampholder.

Exception: where fixed lighting is out of reach of operators during normal operation, the provisions of this Subclause do not apply.

16 Marking, warning signs and reference designations

16.1 General

Warning signs, nameplates, markings, and identification plates shall be of sufficient durability to withstand the physical environment involved.

16.2 Warning signs

16.2.1 Electric shock hazard

Enclosures that do not otherwise clearly show that they contain electrical equipment that can give rise to a risk of electric shock shall be marked with the graphical symbol IEC 60417-5036 (DB:2002-10).



The warning sign shall be plainly visible on the enclosure door or cover.

The warning sign may be omitted (see also 6.2.2 b)) for:

- an enclosure equipped with a supply disconnecting device;
- an operator-machine interface or control station;
- a single device with its own enclosure (for example position sensor).

16.2.2 Hot surfaces hazard

Where the risk assessment shows the need to warn against the possibility of hazardous surface temperatures of the electrical equipment, the graphical symbol IEC 60417-5041 (DB:2002-10) shall be used.



NOTE For electrical installations, this measure is dealt with in IEC 60364-4-42, Clause 423 and Table 42A.

16.3 Functional identification

Control devices, visual indicators, and displays (particularly those related to safety) shall be clearly and durably marked with regard to their functions either on or adjacent to the item. Such markings may be as agreed between the user and the supplier of the equipment (see Annex B). Preference should be given to the use of standard symbols given in IEC 60417-DB:2002 and ISO 7000.

16.4 Marking of equipment

Equipment (for example controlgear assemblies) shall be legibly and durably marked in a way that is plainly visible after the equipment is installed. A nameplate giving the following information shall be attached to the enclosure adjacent to each incoming supply:

- name or trade mark of supplier;
- certification mark, when required;
- serial number, where applicable;
- rated voltage, number of phases and frequency (if a.c.), and full-load current for each supply;

- short-circuit rating of the equipment;
- main document number (see IEC 62023).

The full-load current shown on the nameplate shall be not less than the running currents for all motors and other equipment that can be in operation at the same time under normal conditions.

Where only a single motor controller is used, that information may instead be provided on the machine nameplate where it is plainly visible.

16.5 Reference designations

All enclosures, assemblies, control devices, and components shall be plainly identified with the same reference designation as shown in the technical documentation.

17 Technical documentation

17.1 General



The information necessary for installation, operation, and maintenance of the electrical equipment of a machine shall be supplied in the appropriate forms, for example, drawings, diagrams, charts, tables, instructions. The information shall be in an agreed language (see also Annex B). The information provided may vary with the complexity of the electrical equipment. For very simple equipment, the relevant information may be contained in one document, provided that the document shows all the devices of the electrical equipment and enables the connections to the supply network to be made.

NOTE 1 The technical documentation provided with items of electrical equipment can form part of the documentation of the electrical equipment of the machine.

NOTE 2 In some countries, the requirement to use specific language(s) is covered by legal requirements.

17.2 Information to be provided

The information provided with the electrical equipment shall include:

- a) A main document (parts list or list of documents);
- b) Complementary documents including:
 - 1) a clear, comprehensive description of the equipment, installation and mounting, and the connection to the electrical supply(ies);
 - 2) electrical supply(ies) requirements;
 - 3)  information on the physical environment (for example lighting, vibration, atmospheric contaminants) where appropriate; 
 - 4) overview (block) diagram(s) where appropriate;
 - 5) circuit diagram(s);
 - 6) information (as applicable) on:
 - programming, as necessary for use of the equipment;
 - sequence of operation(s);
 - frequency of inspection;
 - frequency and method of functional testing;
 - guidance on the adjustment, maintenance, and repair, particularly of the protective devices and circuits;
 - recommended spare parts list; and
 - list of tools supplied.

- 7) a description (including interconnection diagrams) of the safeguards, interlocking functions, and interlocking of guards against hazards, particularly for machines operating in a co-ordinated manner;
- 8) a description of the safeguarding and of the means provided where it is necessary to suspend the safeguarding (for example for setting or maintenance), (see 9.2.4);
- 9) instructions on the procedures for securing the machine for safe maintenance; (see also 17.8);
- 10) information on handling, transportation and storage;
- 11) information regarding load currents, peak starting currents and permitted voltage drops, as applicable;
- 12) information on the residual risks due to the protection measures adopted, indication of whether any particular training is required and specification of any necessary personal protective equipment.

17.3 Requirements applicable to all documentation

Unless otherwise agreed between manufacturer and user:

- the documentation shall be in accordance with relevant parts of IEC 61082;
- reference designations shall be in accordance with relevant parts of IEC 61346;
- instructions/manuals shall be in accordance with IEC 62079.
- parts lists where provided shall be in accordance with IEC 62027, class B.

NOTE See item 13 of Annex B.

For referencing of the different documents, the supplier shall select one of the following methods:

- where the documentation consists of a small number of documents (for example less than 5) each of the documents shall carry as a cross-reference the document numbers of all other documents belonging to the electrical equipment; or
- for single level main documents only (see IEC 62023), all documents shall be listed with document numbers and titles in a drawing or document list; or
- all documents of a certain level (see IEC 62023) of the document structure shall be listed, with document numbers and titles, in a parts list belonging to the same level.

17.4 Installation documents

The installation documents shall give all information necessary for the preliminary work of setting up the machine (including commissioning). In complex cases, it may be necessary to refer to the assembly drawings for details.

The recommended position, type, and cross-sectional areas of the supply cables to be installed on site shall be clearly indicated.

The data necessary for choosing the type, characteristics, rated currents, and setting of the overcurrent protective device(s) for the supply conductors to the electrical equipment of the machine shall be stated (see 7.2.2).

Where necessary, the size, purpose, and location of any ducts in the foundation that are to be provided by the user shall be detailed (see Annex B).

The size, type, and purpose of ducts, cable trays, or cable supports between the machine and the associated equipment that are to be provided by the user shall be detailed (see Annex B).

Where necessary, the diagram shall indicate where space is required for the removal or servicing of the electrical equipment.

NOTE 1 Examples of installation diagrams can be found in IEC 61082-4.

In addition, where it is appropriate, an interconnection diagram or table shall be provided. That diagram or table shall give full information about all external connections. Where the electrical equipment is intended to be operated from more than one source of electrical supply, the interconnection diagram or table shall indicate the modifications or interconnections required for the use of each supply.

NOTE 2 Examples of interconnection diagrams/tables can be found in IEC 61082-3.

17.5 Overview diagrams and function diagrams

Where it is necessary to facilitate the understanding of the principles of operation, an overview diagram shall be provided. An overview diagram symbolically represents the electrical equipment together with its functional interrelationships without necessarily showing all of the interconnections.

NOTE 1 Examples of overview diagrams can be found in IEC 61082 series.

Function diagrams may be provided as either part of, or in addition to, the overview diagram.

NOTE 2 Examples of function diagrams can be found in IEC 61082-2.

17.6 Circuit diagrams

A circuit diagram(s) shall be provided. This diagram(s) shall show the electrical circuits on the machine and its associated electrical equipment. Any graphical symbol not shown in IEC 60617-DB:2001 shall be separately shown and described on the diagrams or supporting documents. The symbols and identification of components and devices shall be consistent throughout all documents and on the machine.

Where appropriate, a diagram showing the terminals for interface connections shall be provided. That diagram may be used in conjunction with the circuit diagram(s) for simplification. The diagram should contain a reference to the detailed circuit diagram of each unit shown.

Switch symbols shall be shown on the electromechanical diagrams with all supplies turned off (for example electricity, air, water, lubricant) and with the machine and its electrical equipment ready for a normal start.

Conductors shall be identified in accordance with 13.2.

Circuits shall be shown in such a way as to facilitate the understanding of their function as well as maintenance and fault location. Characteristics relating to the function of the control devices and components which are not evident from their symbolic representation shall be included on the diagrams adjacent to the symbol or referenced to a footnote.

17.7 Operating manual

The technical documentation shall contain an operating manual detailing proper procedures for set-up and use of the electrical equipment. Particular attention should be given to the safety measures provided.

Where the operation of the equipment can be programmed, detailed information on methods of programming, equipment required, program verification, and additional safety procedures (where required) shall be provided.

17.8 Maintenance manual

The technical documentation shall contain a maintenance manual detailing proper procedures for adjustment, servicing and preventive inspection, and repair. Recommendations on maintenance/service intervals and records should be part of that manual. Where methods for the verification of proper operation are provided (for example software testing programs), the use of those methods shall be detailed.

17.9 Parts list

The parts list, where provided, shall comprise, as a minimum, information necessary for ordering spare or replacement parts (for example components, devices, software, test equipment, technical documentation) required for preventive or corrective maintenance including those that are recommended to be carried in stock by the user of the equipment.

18 Verification

18.1 General

This part of IEC 60204 gives general requirements for the electrical equipment of machines.

The extent of verification will be given in the dedicated product standard for a particular machine. Where there is no dedicated product standard for the machine, the verifications shall always include the items a), b) and f) and may include one or more of the items c) to e):

- a) verification that the electrical equipment complies with its technical documentation;
- b) in case of protection against indirect contact by automatic disconnection, conditions for protection by automatic disconnection shall be verified according to 18.2;
- c) insulation resistance test (see 18.3);
- d) voltage test (see 18.4);
- e) protection against residual voltage (see 18.5);
- f) functional tests (see 18.6).

When these tests are performed, it is recommended that they follow the sequence listed above.

When the electrical equipment is modified, the requirements stated in 18.7 shall apply.

☐ For tests in accordance with 18.2 and 18.3, measuring equipment in accordance with the EN 61557 series is applicable.

NOTE For other tests as required by this standard measuring equipment in accordance with relevant IEC or European Standards should be used. ☐

The results of the verification shall be documented.

18.2 Verification of conditions for protection by automatic disconnection of supply

18.2.1 General

The conditions for automatic disconnection of supply (see 6.3.3) shall be verified by tests.

For TN-systems, those test methods are described in 18.2.2; their application for different conditions of supply are specified in 18.2.3.

For TT and IT systems, see IEC 60364-6-61.

18.2.2 Test methods in TN-systems

Test 1 verifies the continuity of the protective bonding circuit. Test 2 verifies the conditions for protection by automatic disconnection of the supply.

Test 1 – Verification of the continuity of the protective bonding circuit

The resistance of each protective bonding circuit between the PE terminal ☐ (see 5.2 and Figure 2) ☐ and relevant points that are part of each protective bonding circuit shall be measured with a current between at least 0,2 A and approximately 10 A derived from an electrically separated supply source (for example SELV, see 413.1 of IEC 60364-4-41) having a maximum no-load voltage of 24 V a.c. or d.c.. It is recommended not to use a PELV supply since such supplies can produce misleading results in this test. The resistance measured shall be in the expected range according to the length, the cross sectional area and the material of the related protective bonding conductor(s).

NOTE 1 Larger currents used for the continuity test increases the accuracy of the test result, especially with low resistance values, i.e. larger cross sectional areas and/or lower conductor length.

Test 2 – Fault loop impedance verification and suitability of the associated overcurrent protective device

The connections of the power supply and of the incoming external protective conductor to the PE terminal of the machine, shall be verified by inspection.

The conditions for the protection by automatic disconnection of supply in accordance with 6.3.3 and Annex A shall be verified by both:

- 1) verification of the fault loop impedance by:
 - calculation, or
 - measurement in accordance with A.4, and

- 2) confirmation that the setting and characteristics of the associated overcurrent protective device are in accordance with the requirements of Annex A.

NOTE 2 A fault loop impedance measurement can be carried out for circuits where the conditions of protection by automatic disconnection requires a current I_a up to about 1 kA (I_a is the current causing the automatic operation of the disconnecting device within the time specified in Annex A).

18.2.3 Application of the test methods for TN-systems

Test 1 of 18.2.2 shall be carried out on each protective bonding circuit of a machine.

When Test 2 of 18.2.2 is carried out by measurement, it shall always be preceded by Test 1.

NOTE A discontinuity of the protective bonding circuit can cause a hazardous situation for the tester or other persons, or damage to the electrical equipment during the loop impedance test.

The tests that are necessary for machines of different status are specified in Table 9. Table 10 can be used to enable determination of the machine status.

Table 9 – Application of the test methods for TN-systems

Procedure	Machine status	Verification on site
A	Electrical equipment of machines, erected and connected on site, where the continuity of the protective bonding circuits has not been confirmed following erection and connection on site.	<p>Test 1 and test 2 (see 18.2.2)</p> <p>Exception: If previous calculations of the fault loop impedance or resistance by the manufacturer are available and where:</p> <ul style="list-style-type: none"> • the arrangement of the installations permits the verification of the length and cross-sectional area of the conductors used for the calculation, and • it can be confirmed that the supply source impedance on site is less than or equal to that of the supply used for the value assumed for the calculation by the manufacturer. <p>Test 1 (see 18.2.2) of the protective bonding circuits connected on site and verification by inspection of the connections of the power supply and of the incoming external protective conductor to the PE-terminal of the machine is sufficient.</p>
B	<p>Machine supplied with confirmation of the verification (see 18.1) of continuity of the protective bonding circuits by test 1 or test 2 by measurement, having protective bonding circuits exceeding the cable length for which examples are given in Table 10.</p> <p>Case B1) supplied fully assembled and not dismantled for shipment,</p> <p>Case B2) supplied dismantled for shipment, where the continuity of protective conductors is ensured after dismantling, transportation and reassembly (for example by the use of plug/socket connections).</p>	<p>Test 2 (see 18.2.2)</p> <p>Exception:</p> <p>Where it can be confirmed that the supply source impedance on site is less than or equal to that used for the calculation, or that of the test supply during a test 2 by measurement, no test is required on site apart from verification of the connections:</p> <ul style="list-style-type: none"> • in case B1) of the power supply and of the incoming external protective conductor to the PE-terminal of the machine; • in case B2) of the power supply and of the incoming external protective conductor to the PE-terminal of the machine and of all connections of the protective conductor(s) that were disconnected for shipment.
C	<p>Machine having protective bonding circuits not exceeding the cable length for which examples are given in Table 10, supplied with confirmation of the verification (see 18.1) of continuity of the protective bonding circuits by test 1 or test 2 (see 18.2.2) by measurement.</p> <p>Case C1) supplied fully assembled and not dismantled for shipment.</p> <p>Case C2) supplied dismantled for shipment, where the continuity of protective conductors is ensured after dismantling, transportation and reassembly (for example by the use of plug/socket combination(s)).</p>	<p>No test required on site. For a machine not connected to the power supply by a plug/socket combination, the correct connection of the incoming external protective conductor to the PE-terminal of the machine shall be verified by visual inspection.</p> <p>In case C2), the installation documents (see 17.4) shall require that all connections of the protective conductor(s) that were disconnected for shipment are verified, for example by visual inspection.</p>

Table 10 – Examples of maximum cable length from each protective device to its load

1 Supply source impedance to each protective device	2 Cross-sectional area	3 Nominal rating or setting of the protective device I_N	4 Fuse disconnect time 5 s	5 Fuse disconnect time 0,4 s	6 Miniature circuit-breaker char.B ³ $I_a = 5 \times I_N$ disconnect time 0,1 s	7 Miniature circuit-breaker char.C ⁴ $I_a = 10 \times I_N$ disconnect time 0,1 s	8 Adjustable circuit-breaker $I_a = 8 \times I_N$ disconnect time 0,1 s
mΩ	mm ²	A	Maximum cable length in m from each protective device to its load				
500	1,5	16	97	53	76	30	28
500	2,5	20	115	57	94	34	36
500	4,0	25	135	66	114	35	38
400	6,0	32	145	59	133	40	42
300	10	50	125	41	132	33	37
200	16	63	175	73	179	55	61
200	25 (line)/16 (PE)	80	133				38
100	35 (line)/16 (PE)	100	136				73
100	50 (line)/25 (PE)	125	141				66
100	70 (line)/35 (PE)	160	138				46
50	95 (line)/50 (PE)	200	152				98
50	120 (line)/70 (PE)	250	157				79

The values of the maximum cable length in Table 10 are based on the following assumptions:

- PVC cable with copper conductors, conductor temperature under short circuit conditions 160 °C (see Table D.5);
- cables with line conductors up to 16 mm² provide a protective conductor of equal cross sectional area to that of the line conductors;
- cables above 16 mm² provide a reduced size protective conductor as shown;
- 3-phase system, nominal voltage of the power supply 400 V;
- maximum supply source impedance to each protective device in accordance with column 1;
- column 3 values are correlated with Table 6 (see 12.4).

A deviation from these assumptions can require a complete calculation or measurement of the fault loop impedance. Further information is available from IEC 60228 and IEC 61200-53.

18.3 Insulation resistance tests

When insulation resistance tests are performed, the insulation resistance measured at 500 V d.c. between the power circuit conductors and the protective bonding circuit shall be not less than 1 MΩ. The test may be made on individual sections of the complete electrical installation.

Exception: for certain parts of electrical equipment, incorporating for example busbars, conductor wire or conductor bar systems or slip-ring assemblies, a lower minimum value is permitted, but that value shall not be less than 50 kΩ.

³ In accordance with the IEC 60898 series.

⁴ In accordance with the IEC 60898 series.

If the electrical equipment of the machine contains surge protection devices which are likely to operate during the test, it is permitted to either:

- disconnect these devices, or
- reduce the test voltage to a value lower than the voltage protection level of the surge protection devices, but not lower than the peak value of the upper limit of the supply (phase to neutral) voltage.

18.4 Voltage tests

When voltage tests are performed, test equipment in accordance with IEC 61180-2 should be used.

The test voltage shall be at a nominal frequency of 50 Hz or 60 Hz.

The maximum test voltage shall have a value of twice the rated supply voltage of the equipment or 1 000 V, whichever is the greater. The maximum test voltage shall be applied between the power circuit conductors and the protective bonding circuit for a period of approximately 1 s. The requirements are satisfied if no disruptive discharge occurs.

Components and devices that are not rated to withstand the test voltage shall be disconnected during testing.

Components and devices that have been voltage tested in accordance with their product standards may be disconnected during testing.

18.5 Protection against residual voltages

Where appropriate, tests shall be performed to ensure compliance with 6.2.4.

18.6 Functional tests

The functions of electrical equipment shall be tested.

The function of circuits for electrical safety (for example earth fault detection) shall be tested.

18.7 Retesting

Where a portion of the machine and its associated equipment is changed or modified, that portion shall be reverified and retested, as appropriate (see 18.1).

Particular attention should be given to the possible adverse effects that retesting can have on the equipment (for example overstressing of insulation, disconnection/reconnection of devices).

Annex A
(normative)

Protection against indirect contact in TN-systems

(Derived from IEC 60364-4-41:2001, and IEC 60364-6-61:2001)

A.1 General

Protection against indirect contact shall be provided by an overcurrent protective device that automatically disconnects the supply to the circuit or equipment in the event of a fault between a live part and an exposed conductive part or a protective conductor in the circuit or equipment, within a sufficiently short disconnecting time. A disconnecting time not exceeding 5 s is considered sufficiently short for machines.

Exception: Where this disconnecting time cannot be assured, measures shall be implemented (for example supplementary protective bonding) to prevent a prospective touch voltage from exceeding 50 V a.c. or 120 V ripple-free d.c. between simultaneously accessible conductive parts. See A.3.

For circuits which supply, through socket-outlets or directly without socket-outlets, Class I hand-held equipment or portable equipment (for example socket-outlets on a machine for accessory equipment, see 15.1) Table A.1 specifies the maximum disconnecting times that are considered sufficiently short.

Table A.1 – Maximum disconnecting times for TN systems

U_o ^{a)} V	Disconnecting time s
120	0,8
230	0,4
277	0,4
400	0,2
>400	0,1

a) U_o is the nominal a.c. r.m.s. voltage to earth.

NOTE 1 For voltages which are within the tolerance band stated in IEC 60038, the disconnecting time appropriate to the nominal voltage applies.

NOTE 2 For intermediate values of voltage, the next higher value in the above table is to be used.

A.2 Conditions for protection by automatic disconnection of the supply by overcurrent protective devices

The characteristics of overcurrent protective devices and the circuit impedances shall be such that, if a fault of negligible impedance occurs anywhere in the electrical equipment between a phase conductor and a protective conductor or exposed conductive part, automatic disconnection of the supply will occur within the specified time (i.e. ≤ 5 s or \leq values in accordance with Table A.1). The following condition fulfils this requirement:

$$Z_s \times I_a \leq U_0$$

where

Z_s is the impedance of the fault loop comprising the source, the live conductor up to the point of the fault and the protective conductor between the point of the fault and the source;

I_a is the current causing the automatic operation of the disconnecting protective device within the specified time;

U_0 is the nominal a.c. voltage to earth.

The increase of the resistance of the conductors with the increase of temperature due to the fault current shall be taken into account (see A.4.3).

NOTE Information for calculating short circuit currents can be found in, for example, the IEC 60909 series or from suppliers of short-circuit protective devices.

A.3 Condition for protection by reducing the touch voltage below 50 V

Where the requirements of Clause A.2 cannot be assured and supplementary bonding is selected as the means of ensuring protection against hazardous touch voltages, the condition for this protection is that the touch voltage has been reduced to below 50 V and it is achieved when the impedance of the protective circuit (Z_{PE}) does not exceed:

$$Z_{PE} \leq \frac{50}{U_0} \times Z_s$$

where Z_{PE} is the impedance of the protective bonding circuit between the equipment anywhere in the installation and the PE terminal of the machine (see 5.2 and Figure 2) or between simultaneously accessible exposed conductive parts and/or extraneous conductive parts.

Confirmation of this condition can be achieved by using the method of Test 1 of 18.2.2 to measure the resistance R_{PE} . The condition for protection is achieved when the measured value of R_{PE} does not exceed:

$$R_{PE} \leq \frac{50}{I_{a(5s)}}$$

where

$I_{a(5s)}$ is the 5 s operating current of the protective device;

R_{PE} is the resistance of the protective bonding circuit between the PE terminal (see 5.2 and Figure 2) and the equipment anywhere on the machine, or between simultaneously accessible exposed conductive parts and/or extraneous conductive parts.

NOTE 1 Supplementary protective bonding is considered as an addition to protection against indirect contact.

NOTE 2 Supplementary protective bonding may involve the entire installation, a part of the installation, an item of apparatus, or a location.

A.4 Verification of conditions for protection by automatic disconnection of the supply

A.4.1 General

The effectiveness of the measures for protection against indirect contact by automatic disconnection of supply in accordance with Clause A.2 is verified as follows:

- verification of the characteristics of the associated protective device by visual inspection of the nominal current setting for circuit-breakers and the current rating for fuses, and;
- measurement of the fault loop impedance (Z_s).

Exception: Where the calculations of the fault loop impedance or of the resistance of the protective conductors are available and when the arrangement of the installations permits the verification of the length and cross-sectional area of the conductors, verification of the continuity of the protective conductors may replace the measurement.

A.4.2 Measurement of the fault loop impedance

Measurement of the fault loop impedance shall be performed using measuring equipment that complies with IEC 61557-3. The information about the accuracy of the measuring results, and the procedures to be followed given in the documentation of the measuring equipment shall be considered.

Measurement shall be performed when the machine is connected to a supply having the same frequency as the nominal frequency of the supply at the intended installation.

NOTE Figure A.1 illustrates a typical arrangement for measuring the fault loop impedance on a machine. If it is not practicable for the motor to be connected during the test, the two phase conductors not used in the test can be opened, for example, by removing fuses.

The measured value of the fault loop impedance shall comply with A.2.

A.4.3 Consideration of the difference between the measured value of resistance of the conductors and the actual value under fault conditions

NOTE As the measurements are made at ambient temperature, with low currents, it is necessary to take into account the increase of resistance of the conductors with the increase of temperature under fault conditions, to verify the compliance of the measured value of the fault loop impedance with the requirements of Clause A.2.

The increase of resistance of the conductors with the increase of temperature due to the fault current is taken into account in the following equation:

$$Z_{s(m)} \leq \frac{2}{3} \times \frac{U_0}{I_a}$$

where $Z_{s(m)}$ is the measured value of Z_s .

A1) Where the measured value of the fault loop impedance exceeds $2U_0/3I_a$, a more precise assessment can be made in accordance with the procedure described in C.61.3.6.2 of IEC 60364-6:2006. **A1)**

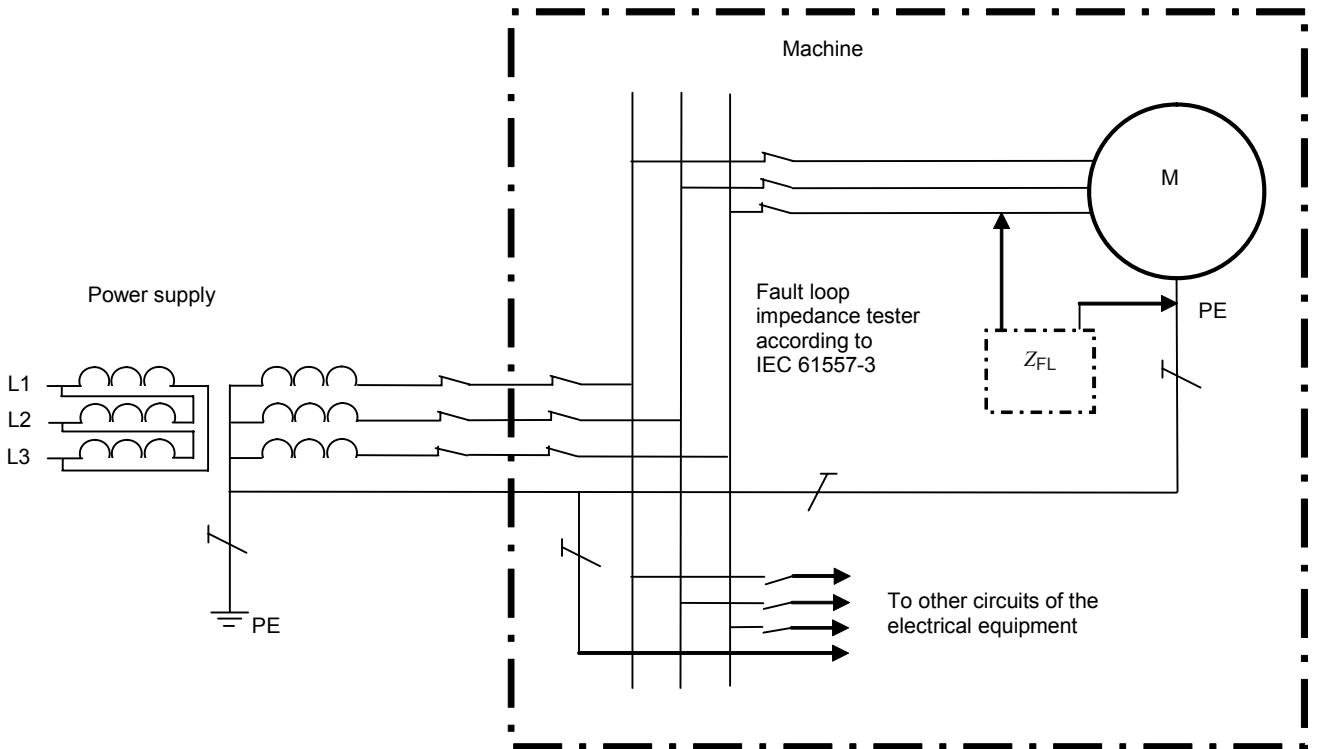

IEC 1392/05

Figure A.1 – Typical arrangement for fault loop impedance measurement

Annex B (informative)

Enquiry form for the electrical equipment of machines

It is recommended that the following information be provided by the intended user of the equipment. It can facilitate an agreement between the user and supplier on basic conditions and additional user requirements to enable proper design, application and utilization of the electrical equipment of the machine (see 4.1).

Name of manufacturer/supplier			
Name of end user			
Tender/order number		Date	
Type of machine		Serial number	
1. Special conditions (see Clause 1)			
a) Is the machine to be used in the open air?	Yes		No
b) Will the machine use, process or produce explosive or flammable material?	Yes/No		If yes, specification
c) Is the machine for use in potentially explosive or flammable atmospheres?	Yes/No		If yes, specification
d) Can the machine present special hazards when producing or consuming certain materials?	Yes/No		If yes, specification
e) Is the machine for use in mines?	Yes		No
2. Electrical supplies and related conditions (see 4.3)			
a) Anticipated voltage fluctuations (if more than $\pm 10\%$)			
b) Anticipated frequency fluctuations (if more than $\pm 2\%$)	Continuous		Short time
c) Indicate possible future changes in electrical equipment that will require an increase in the electrical supply requirements			
d) Specify voltage interruptions in supply if longer than specified in Clause 4 where electrical equipment has to maintain operation under such conditions			
3. Physical environment and operating conditions (see 4.4)			
a) Electromagnetic environment (see 4.4.2)	Residential, commercial or light industrial environment		Industrial environment
Special conditions or requirements			
b) Ambient temperature range			
c) Humidity range			
d) Altitude			
e) Special environmental conditions (for example corrosive atmospheres, dust, wet environments)			

f) Radiation				
g) Vibration, shock				
h) Special installation and operation requirements (for example flame-retardant cables and conductors)				
i) Transportation and storage (for example, temperatures outside the range specified in Subclause 4.5)				
4. Incoming electrical supplies				
Specify for each source of supply:				
a) Nominal voltage (V)	a.c.		d.c.	
	If a.c., number of phases		Frequency	
Prospective short-circuit current at the point of supply to the machine (kA r.m.s.) (see also item 2)				
b) Type of power supply earthing (see IEC 60364-1)	TN (system with one point directly earthed, with a protective conductor (PE) directly connected to that point); specify if the earthed point is the neutral point (centre of the star) or another point)		TT (system with one point directly earthed but the protective conductor (PE) of the machine not connected to that earth point of the system)	
	IT (system that is not directly earthed)			
c) Is the electrical equipment to be connected to a neutral (N) supply conductor? (See 5.1)	Yes		No	
d) Supply disconnecting device				
Is disconnection of the neutral (N) conductor required?	Yes		No	
Is a removable link for disconnecting the neutral (N) required?	Yes		No	
Type of supply disconnecting device to be provided				
5. Protection against electric shock (see Clause 6)				
a) For which of the following classes of persons is access to the interior of enclosures required during normal operation of the equipment?	Electrically skilled persons		Electrically instructed persons	
b) Are locks with removable keys to be provided for securing the doors or covers? (see 6.2.2)	Yes		No	

6. Protection of equipment (see Clause 7)			
a) Will the user or the supplier provide the overcurrent protection of the supply conductors? (see 7.2.2)			
Type and rating of overcurrent protective devices			
b) Largest (kW) three-phase a.c. motor that may be started direct-on-line			
c) May the number of motor overload detection devices be reduced? (see 7.3)	Yes		No
7. Operation			
For cableless control systems, specify the time delay before automatic machine shutdown is initiated in the absence of a valid signal.			
8. Operator interface and machine-mounted control devices (see Clause 10)			
Special colour preferences (for example to align with existing machinery):	Start		Stop
	Other		
9. Controlgear			
Degree of protection of enclosures (see Subclause 11.3) or special conditions:			
10. Wiring practices (see Clause 13)			
Is there a specific method of identification to be used for the conductors? (see 13.2.1)	Yes		No
Type			
11. Accessories and lighting (see Clause 15)			
a) Is a particular type of socket-outlet required?	Yes		No
If yes, which type?			
b) Are the socket-outlets for maintenance to be provided with additional protection by the use of Residual Current protective Devices (RCD)?	Yes		No
c) Where the machine is equipped with local lighting:	Highest permissible voltage (V)		If lighting circuit voltage is not obtained directly from the power supply, state preferred voltage
12. Marking, warnings and reference designations (see Clause 16)			
a) Functional identification (see 16.3)			
Specifications:			
b) Inscriptions/special markings	On electrical equipment?		In which language?
c) Mark of certification	Yes		No
If yes, which one?			

13. Technical documentation (see Clause17)				
a) Technical documentation (see 17.1)	On what media?		In which language?	
b) Size, location and purpose of ducts, open cable trays or cable supports to be provided by the user (see 17.5)				
c) Indicate if special limitations on the size or weight affect the transport of a particular machine or controlgear assemblies to the installation site:	Maximum dimensions		Maximum weight	
d) In the case of specially built machines, is a certificate of operating tests with the loaded machine to be supplied?	Yes		No	
e) In the case of other machines, is a certificate of operating type tests on a loaded prototype machine to be supplied?	Yes		No	

Annex C (informative)

Examples of machines covered by this part of IEC 60204

The following list shows examples of machines whose electrical equipment should conform to this part of IEC 60204. The list is not intended to be exhaustive but is consistent with the definition of machinery (3.35). This part of IEC 60204 need not be applied to machines that are household and similar domestic appliances within the scope of the IEC 60335 series of standards.

Metalworking machinery

- metal cutting machines
- metal forming machines

Plastics and rubber machinery

- injection moulding machines
- extrusion machines
- blow moulding machines
- thermoset moulding machines
- size reduction machines

Wood machinery

- woodworking machines
- laminating machines
- sawmill machines

Assembly machines

Material handling machines

- robots
- conveyors
- transfer machines
- storage and retrieval machines

Textile machines

Refrigeration and air-conditioning machines

Food machinery

- dough breaks
- mixing machines
- pie and tart machines
- meat processing machines

Printing, paper and board machinery

- printing machines
- finishing machines, guillotines, folders
- reeling and slitting machines
- folder box gluing machines
- paper and board making machines

Inspecting/testing machinery

- co-ordinate measuring machines
- in-process gauging machines

Compressors

Packaging machinery

- palletizers/depalletizers
- wrapping and shrink-wrapping machines

Laundry machines

Heating and ventilating machines

Leather/imitation leather goods and footwear machinery

- cutting and punching machines
- roughing, scouring, buffing, trimming and brushing machines
- footwear moulding machines
- lasting machines

Hoisting machinery (see IEC 60204-32)

- cranes
- hoists

Machinery for transportation of persons

- escalators
- ropeways for transportation of persons, for example chairlifts, ski lifts
- passenger lifts

Power-operated doors**Leisure machinery**

- fairground rides

Pumps**Agriculture and forestry machines****Construction and building materials machinery**

- tunnelling machines
- concrete batching machines
- brick-making machines
- stone, ceramic and glass-making machines

Transportable machinery

- wood working machines
- metal working machines

Mobile machinery

- lifting platforms
- fork lift trucks
- construction machines

Machines for hot metal processing**Tanning machinery**

- multi-roller machines
- bandknife machines
- hydraulic tanning machines

Mining and quarrying machines

Annex D
(informative)

**Current-carrying capacity and overcurrent protection
of conductors and cables in the electrical equipment of machines**

The purpose of this Annex is to provide additional information on the selection of conductor sizes where the conditions given for Table 6 (see Clause 12) have to be modified (see notes to Table 6).

D.1 General operating conditions

D.1.1 Ambient air temperature

The current carrying capacity for PVC insulated conductors given in Table 6 is related to an ambient air temperature of +40 °C. For other ambient air temperatures, the correction factors are given in Table D.1.

The correction factors for rubber insulated cables are given by the manufacturer.

Table D.1 – Correction factors

Ambient air temperature °C	Correction factor
30	1,15
35	1,08
40	1,00
45	0,91
50	0,82
55	0,71
60	0,58

NOTE The correction factors are derived from IEC 60364-5-52.
The maximum temperature under normal conditions for PVC 70 °C.

D.1.2 Methods of installation

In machines, the methods of conductor and cable installation between enclosures and individual items of the equipment shown in Figure D.1 are assumed to be typical (the letters used are in accordance with IEC 60364-5-52: 2001):

- Method B1: using conduits (3.7) and cable trunking systems (3.5) for holding and protecting conductors or single core cables;
- Method B2: same as B1 but used for multicore cables;
- Method C: multicore cables installed in free air, horizontal or vertical without gap between cables on walls;
- Method E: multicore cables in free air, horizontal or vertical laid on open cable trays (3.4).

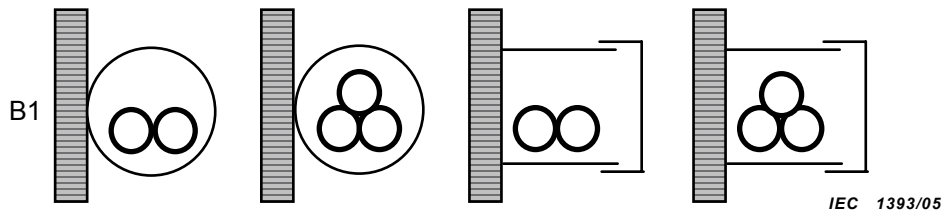

Conductors/single core cables in conduit and cable trunking systems

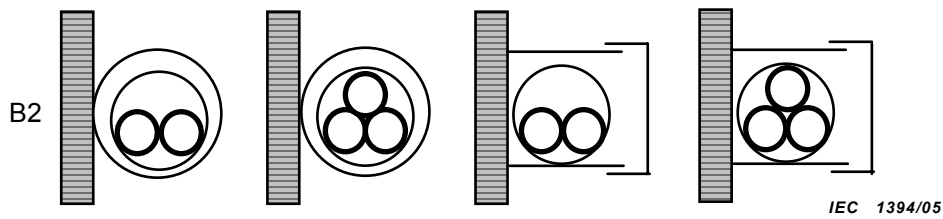

Cables in conduit and cable trunking systems

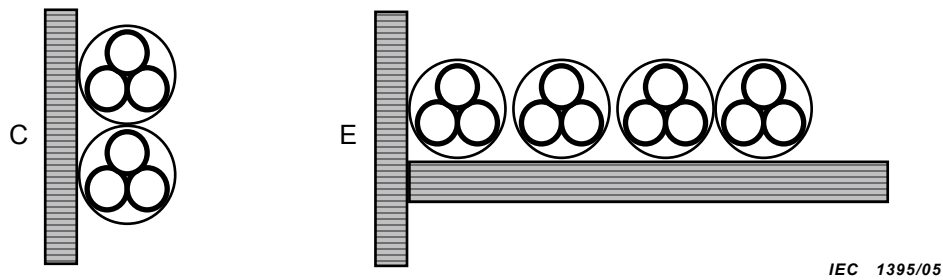

Cables on walls

Cables on open cable trays

Figure D.1 – Methods of conductor and cable installation independent of number of conductors/cables

D.1.3 Grouping

Where more loaded conductors in cables or conductor pairs are installed, derate the values of I_z , given in Table 6 or by the manufacturer in accordance with Tables D.2 or D.3.

NOTE Circuits with $I_b < 30\%$ of I_z need not be derated.

Table D.2 – Derating factors from I_z for grouping

Methods of installation (see Figure D.1) (see Note 3)	Number of loaded circuits/cables			
	2	4	6	9
B1 (circuits) and B2 (cables)	0,80	0,65	0,57	0,50
C single layer with no gap between cables	0,85	0,75	0,72	0,70
E single layer on one perforated tray without gap between cables	0,88	0,77	0,73	0,72
E as before but with 2 to 3 trays, with a vertical spacing between each tray of 300 mm (see Note 4)	0,86	0,76	0,71	0,66
Control circuit pairs $\leq 0,5\text{mm}^2$ independent of methods of installation	0,76	0,57	0,48	0,40
<p>NOTE 1 These factors are applicable to</p> <ul style="list-style-type: none"> – cables, all equally loaded, the circuit itself symmetrically loaded; – groups of circuits of insulated conductors or cables having the same allowable maximum operating temperature. <p>NOTE 2 The same factors are applied to</p> <ul style="list-style-type: none"> – groups of two or three single-core cables; – multicore cables. <p>NOTE 3 Factors derived from IEC 60364-5-52:2001.</p> <p>NOTE 4 A perforated cable tray is a tray where the holes occupy more than 30 % of the area of the base. (Derived from IEC 60364-5-52:2001).</p>				

Table D.3 – Derating factors from I_z for multicore cables up to 10 mm^2

Number of loaded conductors or pairs	Conductors ($> 1\text{ mm}^2$) (see Note 3)	Pairs ($0,25\text{ mm}^2$ to $0,75\text{ mm}^2$)
1	-	1,0
3	1,0	-
5	0,75	0,39
7	0,65	0,34
10	0,55	0,29
24	0,40	0,21
<p>NOTE 1 Applicable to multicore cables with equally loaded conductors/pairs.</p> <p>NOTE 2 For grouping of multicore cables, see derating factors of Table D.2.</p> <p>NOTE 3 Factors derived from IEC 60364-5-52:2001.</p>		

D.1.4 Classification of conductors

Table D.4 – Classification of conductors

Class	Description	Use/application
1	Solid copper or aluminium conductors	Fixed installations
2	Stranded copper or aluminium conductors	
5	Flexible stranded copper conductors	Machine installations with presence of vibration; connection to moving parts
6	Flexible stranded copper conductors conductors that are more flexible than class 5	For frequent movements

NOTE Derived from IEC 60228.

D.2 Co-ordination between conductors and protective devices providing overload protection

Figure D.2 illustrates the relationship between the parameters of conductors and the parameters of protective devices providing overload protection.

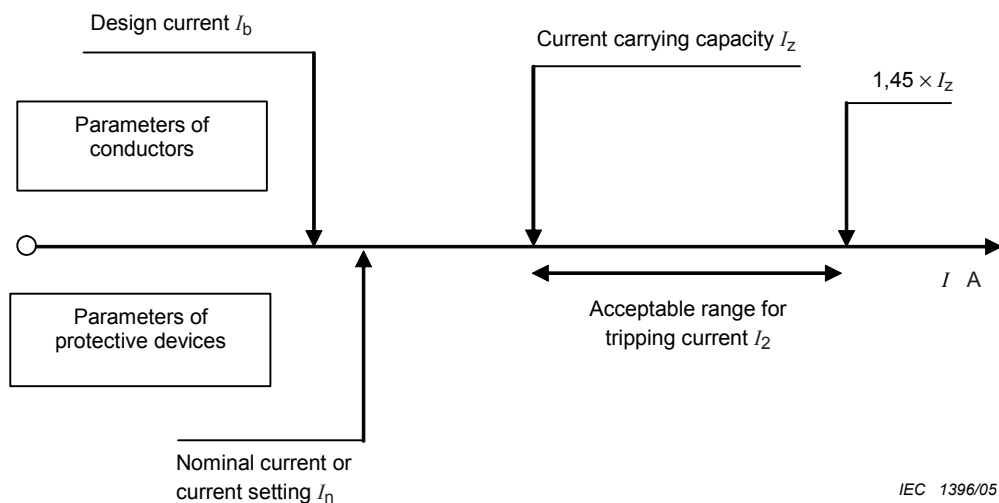

Figure D.2 – Parameters of conductors and protective devices

Correct protection of a cable requires that the operating characteristics of a protective device (for example overcurrent protective device, motor overload protective device) protecting the cable against overload satisfy the two following conditions:

$$I_b \leq I_n \leq I_z \tag{1}$$

$$I_2 \leq 1,45 \times I_z \tag{2}$$

where

I_b is the current for which the circuit is designed;

I_Z is the effective current-carrying capacity, in amperes, of the cable for continuous service according to Table 6 for the particular installation conditions:

- temperature, derating of I_Z see Table D.1;
- grouping, derating of I_Z see Table D.2;
- multicore cables, derating of I_Z see Table D.3.

I_n is the nominal current of the protective device;

NOTE 1 For adjustable protective devices, the nominal current I_n is the current setting selected.

I_2 is the minimum current ensuring effective operation of the protective device within a specified time (for example 1 h for protective devices up to 63 A).

The current I_2 ensuring effective operation of the protective device is given in the product standard or may be provided by the manufacturer.

NOTE 2 For motor circuit conductors, overload protection for conductor(s) can be provided by the overload protection for the motor(s) whereas the short-circuit protection is provided by short-circuit protective devices.

Where a device that provides both overload and short-circuit protection is used in accordance with this Clause for conductor overload protection, it does not ensure complete protection in all cases (for example overload with currents less than I_2), nor will it necessarily result in an economical solution. Therefore, such a device can be unsuitable where overloads with currents less than I_2 are likely to occur.

D.3 Overcurrent protection of conductors

All conductors are required to be protected against overcurrent (see 7.2) by protective devices inserted in all live conductors so that any short circuit current flowing in the cable is interrupted before the conductor has reached the maximum allowable temperature.

NOTE For neutral conductors, see 7.2.3, second paragraph.

Table D.5 – Maximum allowable conductor temperatures under normal and short-circuit conditions

Type of insulation	Maximum temperature under normal conditions °C	Ultimate short-time conductor temperature under short circuit conditions ^{a)} °C
Polyvinyl chloride (PVC)	70	160
Rubber	60	200
Cross-linked polyethylene (XLPE)	90	250
Ethylene propylene compound (EPR)	90	250
Silicone rubber (SiR)	180	350
NOTE For ultimate short-time conductor temperatures greater than 200 °C, neither tinned nor bare copper conductors are suitable. Silver-plated or nickel-plated copper conductors are suitable for use above 200 °C.		
a) These values are based on the assumption of adiabatic behaviour for a period of not more than 5 s.		

In practice, the requirements of 7.2 are fulfilled when the protective device at a current I causes the interruption of the circuit within a time that in no case exceeds the time t where $t < 5$ sec.

The value of the time t in seconds shall be calculated using the following formula:

$$t = (k \times S/I)^2$$

where:

S is the cross-sectional area in square millimetres;

I is the effective short-circuit current in amperes expressed for a.c. as the r.m.s. value;

k is the factor shown for copper conductors when insulated with the following material:

PVC 115

Rubber 141

SiR 132

XLPE 143

EPR 143

The use of fuses with characteristics gG or gM (see IEC 60269-1) and circuit-breakers with characteristics B and C in accordance with the IEC 60898 series, ensures that the temperature limits in Table D.5 will not be exceeded, provided that the nominal current I_n is chosen in accordance with Table 6 where $I_n \leq I_z$.

Annex E (informative)

Explanation of emergency operation functions

NOTE These concepts are included here to give the reader an understanding of these terms even though in this part of IEC 60204 only two of them are used.

Emergency operation

Emergency operation includes separately or in combination:

- emergency stop;
- emergency start;
- emergency switching off;
- emergency switching on.

Emergency stop

An emergency operation intended to stop a process or a movement that has become hazardous.

Emergency start

An emergency operation intended to start a process or a movement to remove or to avoid a hazardous situation.

Emergency switching off

An emergency operation intended to switch off the supply of electrical energy to all or a part of an installation where a risk of electric shock or another risk of electrical origin is involved.

Emergency switching on

An emergency operation intended to switch on the supply of electrical energy to a part of an installation that is intended to be used for emergency situations.

Annex F (informative)

Guide for the use of this part of IEC 60204

F.1 General

This part of IEC 60204 gives a large number of general requirements that may or may not be applicable to the electrical equipment of a particular machine. A simple reference without any qualification to the complete standard IEC 60204-1 is therefore not sufficient. Choices need to be made to cover all requirements of this part of IEC 60204. A technical committee preparing a product family or a dedicated product standard (type C in CEN), and the supplier of a machine for which no product family or dedicated product standard exists, should use this part of IEC 60204:

- a) by reference; and
- b) by selection of the most appropriate option(s) from the requirements given in the relevant Clauses; and
- c) by modification of certain Clauses, as necessary, where the particular requirements for the equipment of the machine are adequately covered by other relevant standards,

providing the options selected and the modifications made do not adversely affect the level of protection required for that machine according to the risk assessment.

When applying the three principles a), b) and c) listed above, it is recommended that:

- reference be made to the relevant Clauses and Subclauses of this standard:
 - 1) that are complied with, indicating where relevant the applicable option;
 - 2) that have been modified or extended for the specific machine or equipment requirements; and
- reference be made directly to the relevant standard, for those requirements for the electrical equipment that are adequately covered by that standard.

In all cases, expertise is essential to be able to:

- perform the necessary risk assessment of the machine;
- read and understand all of the requirements of this part of IEC 60204;
- choose the applicable requirements from this part of IEC 60204 where alternatives are given;
- identify alternative or additional particular requirements that differ from or are not included in the requirements of this part of IEC 60204, and that are determined by the machine and its use; and
- specify precisely those particular requirements.

Figure 1 of this part of IEC 60204 is a block diagram of a typical machine and can be used as the starting point of this task. It indicates the Clauses and Subclauses dealing with particular requirements/equipment. However, this part of IEC 60204 is a complex document and Table F.1 can help identify the application options for a particular machine and gives reference to other relevant standards.

Table F.1 – Application options

Subject	Clause or Subclause	i)	ii)	iii)	iv)
Scope	1		X		
General requirements	4	X	X	X	ISO 12100 (all parts) ISO 14121
Selection of equipment	4.2.2		X	X	IEC 60439 series
Supply disconnecting (isolating) device	5.3	X			
Excepted circuits	5.3.5	X		X	ISO 12100 (all parts)
Prevention of unexpected start-up, isolation	5.4, 5.5 and 5.6	X	X	X	ISO 14118
Protection against electric shock	6	X			IEC 60364-4-41
Emergency operations	9.2.5.4	X		X	ISO 13850
Two-hand control	9.2.6.2	X	X		ISO 13851
Cableless control	9.2.7	X	X	X	
Control functions in the event of failure	9.4	X	X	X	ISO 14121 ISO 13849 (all parts) IEC 62061
Position sensors	10.1.4	X	X	X	ISO 14119
Colours and markings of operator interface devices	10.2, 10.3 and 10.4	X	X		IEC 60073 IEC 61310 (all parts)
Emergency stop devices	10.7	X	X		ISO 13850
Emergency switching off devices	10.8	X			
Controlgear – protection against ingress of contaminants, etc.	10.1.3 and 11.3	X	X	X	IEC 60529
Identification of conductors	13.2	X	X		
Verification	18	X	X	X	
Additional user requirements	Annex B		X	X	
<p>Clauses and Subclauses of this part of IEC 60204 where action should be considered (shown by X) with respect to:</p> <ul style="list-style-type: none"> i) selection from the measures given; ii) additional requirements; iii) different requirements; iv) other standards that can be relevant. 					

Annex G (informative)

Comparison of typical conductor cross-sectional areas

Table G.1 provides a comparison of the conductor cross-sectional areas of the American Wire Gauge (AWG) with square millimetres, square inches, and circular mils.

Table G.1 – Comparison of conductor sizes

Wire size	Gauge No	Cross-sectional area		d.c. resistance of copper at 20°C Ohms per km	Circular mils
		mm ²	inches ²		
0,2		0,196	0,000 304	91,62	387
	24	0,205	0,000 317	87,60	404
0,3		0,283	0,000 438	63,46	558
	22	0,324	0,000 504	55,44	640
0,5		0,500	0,000 775	36,70	987
	20	0,519	0,000 802	34,45	1 020
0,75		0,750	0,001 162	24,80	1 480
	18	0,823	0,001 272	20,95	1 620
1,0		1,000	0,001 550	18,20	1 973
	16	1,31	0,002 026	13,19	2 580
1,5		1,500	0,002 325	12,20	2 960
	14	2,08	0,003 228	8,442	4 110
2,5		2,500	0,003 875	7,56	4 934
	12	3,31	0,005 129	5,315	6 530
4		4,000	0,006 200	4,700	7 894
	10	5,26	0,008 152	3,335	10 380
6		6,000	0,009 300	3,110	11 841
	8	8,37	0,012 967	2,093	16 510
10		10,000	0,001 550	1,840	19 735
	6	13,3	0,020 610	1,320	26 240
16		16,000	0,024 800	1,160	31 576
	4	21,1	0,032 780	0,829 5	41 740
25		25,000	0,038 800	0,734 0	49 338
	2	33,6	0,052 100	0,521 1	66 360
35		35,000	0,054 200	0,529 0	69 073
	1	42,4	0,065 700	0,413 9	83 690
50		47,000	0,072 800	0,391 0	92 756

The resistance for temperatures other than 20°C can be found using the formula:

$$R = R_I [1 + 0,003\ 93 (t - 20)]$$

Where:

R_I is the resistance at 20°C;

R is the resistance at a temperature t °C.

Annex ZA (normative)

Normative references to international publications with their corresponding European publications

The following referenced documents are indispensable for the application of this document. For dated references, only the edition cited applies. For undated references, the latest edition of the referenced document (including any amendments) applies.

NOTE When an international publication has been modified by common modifications, indicated by (mod), the relevant EN/HD applies.

<u>Publication</u>	<u>Year</u>	<u>Title</u>	<u>EN/HD</u>	<u>Year</u>
IEC 60034-1	- ¹⁾	Rotating electrical machines Part 1: Rating and performance	EN 60034-1	2004 ²⁾
IEC 60034-5	- ¹⁾	Rotating electrical machines Part 5: Degrees of protection provided by the integral design of rotating electrical machines (IP code) - Classification	EN 60034-5	2001 ²⁾
IEC 60034-11	- ¹⁾	Rotating electrical machines Part 11: Thermal protection	EN 60034-11	2004 ²⁾
IEC 60072-1	- ¹⁾	Dimensions and output series for rotating electrical machines - Part 1: Frame numbers 56 to 400 and flange numbers 55 to 1 080	-	-
IEC 60072-2	- ¹⁾	Dimensions and output series for rotating electrical machines Part 2: Frame numbers 355 to 1 000 and flange numbers 1 180 to 2 360	-	-
IEC 60073	2002	Basic and safety principles for man-machine interface, marking and identification - Coding principles for indicators and actuators	EN 60073	2002
IEC 60309-1	1999	Plugs, socket-outlets and couplers for industrial purposes Part 1: General requirements	EN 60309-1 + A11	1999 2004
IEC 60364-4-41 (mod)	2005	Low-voltage electrical installations - Part 4-41: Protection for safety - Protection against electric shock	HD 60364-4-41 + corr. July	2007 2007
IEC 60364-4-43 + corr. August	2001 2002	Electrical installations of buildings Part 4-43: Protection for safety - Protection against overcurrent	-	-
IEC 60364-5-52	2001	Electrical installations of buildings Part 5-52: Selection and erection of electrical equipment - Wiring systems	-	-

¹⁾ Undated reference.

²⁾ Valid edition at date of issue.

<u>Publication</u>	<u>Year</u>	<u>Title</u>	<u>EN/HD</u>	<u>Year</u>
IEC 60364-5-53 + A1	2001 2002	Electrical installations of buildings Part 5-53: Selection and erection of electrical equipment - Isolation, switching and control	-	-
IEC 60364-5-54 (mod)	2002	Electrical installations of buildings Part 5-54: Selection and erection of electrical equipment - Earthing arrangements, protective conductors and protective bonding conductors	HD 60364-5-54	2006
IEC 60364-6-61	2001	Electrical installations of buildings Part 6-61: Verification - Initial verification	-	-
IEC 60417	data- base	Graphical symbols for use on equipment	-	-
IEC 60439-1	1999	Low-voltage switchgear and controlgear assemblies Part 1: Type-tested and partially type-tested assemblies	EN 60439-1	1999
IEC 60445 + corr. July	1999 2002	Basic and safety principles for man-machine interface, marking and identification - Identification of equipment terminals and of terminations of certain designated conductors, including general rules for an alphanumeric system	EN 60445	2000
IEC 60446 + corr. July	1999 2002	Basic and safety principles for man-machine interface, marking and identification - Identification of conductors by colours or numerals	EN 60446	1999
IEC 60447	2004	Basic and safety principles for man-machine interface, marking and identification - Actuating principles	EN 60447	2004
IEC 60529 + A1	1989 1999	Degrees of protection provided by enclosures (IP Code)	EN 60529 + corr. May + A1	1991 1993 2000
IEC 60617	data- base	Graphical symbols for diagrams	-	-
IEC 60621-3	1979	Electrical installations for outdoor sites under heavy conditions (including open-cast mines and quarries) Part 3: General requirements for equipment and ancillaries	-	-
IEC 60664-1 (mod)	1992	Insulation coordination for equipment within low-voltage systems Part 1: Principles, requirements and tests	EN 60664-1 ³⁾	2003
IEC 60947-1	2004	Low-voltage switchgear and controlgear Part 1: General rules	EN 60947-1 + corr. November	2004 2004
IEC 60947-2	2003	Low-voltage switchgear and controlgear Part 2: Circuit-breakers	EN 60947-2	2003

³⁾ EN 60664-1 includes A1:2000 + A2:2002 to IEC 60664-1 (mod).

<u>Publication</u>	<u>Year</u>	<u>Title</u>	<u>EN/HD</u>	<u>Year</u>
IEC 60947-3 + corr. July	1999 1999	Low-voltage switchgear and controlgear Part 3: Switches, disconnectors, switch- disconnectors and fuse-combination units	EN 60947-3	1999
IEC 60947-5-1	2003	Low-voltage switchgear and controlgear Part 5-1: Control circuit devices and switching elements - Electromechanical control circuit devices	EN 60947-5-1 + corr. July	2004 2005
IEC 60947-7-1 + corr. March	2002 2003	Low-voltage switchgear and controlgear Part 7-1: Ancillary equipment - Terminal blocks for copper conductors	EN 60947-7-1	2002
IEC 61082-1 + corr. November	1991 1993	Preparation of documents used in electrotechnology Part 1: General requirements	EN 61082-1	1993
IEC 61082-2	1993	Preparation of documents used in electrotechnology Part 2: Function-oriented diagrams	EN 61082-2	1994
IEC 61082-3	1993	Preparation of documents used in electrotechnology Part 3: Connection diagrams, tables and lists	EN 61082-3	1994
IEC 61082-4	1996	Preparation of documents used in electrotechnology Part 4: Location and installation documents	EN 61082-4	1996
IEC 61140	2001	Protection against electric shock - Common aspects for installation and equipment	EN 61140	2002
IEC 61310	Series	Safety of machinery - Indication, marking and - actuation		-
IEC 61346	Series	Industrial systems, installations and equipment and industrial products - Structuring principles and reference designations	EN 61346	Series
IEC 61557-3	1997	Electrical safety in low voltage distribution systems up to 1 kV a.c. and 1,5 kV d.c. - Equipment for testing, measuring or monitoring of protective measures Part 3: Loop impedance	EN 61557-3	1997
IEC 61558-1 (mod) + A1	1997 1998	Safety of power transformers, power supply units and similar Part 1: General requirements and tests	EN 61558-1 + corr. April + A1 + A11 ⁴⁾	1997 2003 1998 2003
IEC 61558-2-6	- ¹⁾	Safety of power transformers, power supply units and similar Part 2-6: Particular requirements for safety isolating transformers for general use	EN 61558-2-6	1997 ²⁾
IEC 61984	2001	Connectors - Safety requirements and tests	EN 61984	2001

⁴⁾ EN 61558-1 is superseded by EN 61558-1:2005, which is based on IEC 61558-1:2005.

<u>Publication</u>	<u>Year</u>	<u>Title</u>	<u>EN/HD</u>	<u>Year</u>
IEC 62023	2000	Structuring of technical information and documentation	EN 62023	2000
IEC 62027	2000	Preparation of parts lists	EN 62027	2000
IEC 62061 + corr. July	2005 2005	Safety of machinery - Functional safety of safety-related electrical, electronic and programmable electronic control systems	EN 62061	2005
IEC 62079	2001	Preparation of instructions - Structuring, content and presentation	EN 62079	2001
ISO 7000	2004	Graphical symbols for use on equipment - Index and synopsis	-	-
ISO 12100-1	2003	Safety of machinery - Basic concepts, general principles for design Part 1: Basic terminology, methodology	EN ISO 12100-1	2003
ISO 12100-2	2003	Safety of machinery - Basic concepts, general principles for design Part 2: Technical principles	EN ISO 12100-2	2003
ISO 13849-1	2006	Safety of machinery - Safety-related parts of control systems - Part 1: General principles for design	EN ISO 13849-1	2008
ISO 13849-2	2003	Safety of machinery - Safety-related parts of control systems Part 2: Validation	EN ISO 13849-2	2003
ISO 13850	2006	Safety of machinery - Emergency stop - Principles for design	EN ISO 13850	2008

Annex ZZ (informative)

Coverage of Essential Requirements of EC Directives

This European Standard has been prepared under a mandate given to CENELEC by the European Commission and the European Free Trade Association and within its scope the standard covers only the following essential requirements out of those given in Annex I of the EC Directive 98/37/EC:

- 1.1.2
- 1.2
- 1.5.1
- 1.5.4
- 1.6.3 (for isolation of electrical supplies of machinery)
- 1.6.4 (for access to electrical equipment)
- 1.7.0
- 1.7.1
- 1.7.2 (for residual risks of an electrical nature)
- 1.7.4(c)

Compliance with this standard provides one means of conformity with the specified essential requirements of the Directive concerned.

WARNING: Other requirements and other EC Directives may be applicable to the products falling within the scope of this standard.

Bibliography

IEC 60038:2002, *IEC standard voltages*

IEC 60204-11:2000, *Safety of machinery – Electrical equipment of machines – Part 11: Requirements for HV equipment for voltages above 1 000 V a.c. or 1 500 V d.c. and not exceeding 36 kV*

IEC 60204-31:2001, *Safety of machinery – Electrical equipment of machines – Part 31: Particular safety and EMC requirements for sewing machines, units, and systems*

IEC 60204-32:1998, *Safety of machinery – Electrical equipment of machines – Part 32: Requirements for hoisting machines*

IEC 60228:2004, *Conductors of insulated cables*

IEC 60269-1:1998, *Low-voltage fuses – Part 1: General requirements*

IEC 60287 (all parts), *Electric cables – Calculation of the current rating*

IEC 60332 (all parts), *Tests on electric and optical fibre cables under fire conditions*

IEC 60335 (all parts): *Household and similar electrical appliances – Safety*

IEC 60364 (all parts): *Electrical installations of buildings*

IEC 60757:1983, *Code for designation of colours*

IEC 60947-5-2:1997, *Low-voltage switchgear and controlgear – Part 5-2: Control circuit devices and switching elements – Proximity switches*
Amendment 1 (1999)
Amendment 2 (2003)

IEC 61000-5-2:1997, *Electromagnetic compatibility (EMC) – Part 5: Installation and mitigation guidelines – Section 2: Earthing and cabling*

IEC 61000-6-1:1997, *Electromagnetic compatibility (EMC) – Part 6: Generic standards – Section 1: Immunity for residential, commercial and light-industrial environments*

IEC 61000-6-2:2005, *Electromagnetic compatibility (EMC) – Part 6-2: Generic standards – Immunity for industrial environments*

IEC 61000-6-4:1997, *Electromagnetic compatibility (EMC) – Part 6: Generic standards – Section 4: Emission standard for industrial environments*

IEC 61084-1:1991, *Cable trunking and ducting systems for electrical installations – Part 1: General requirements*

IEC 61180-2:1994, *High-voltage test techniques for low-voltage equipment – Part 2: Test equipment*

IEC 61200-53:1994, *Electrical installation guide – Part 53: Selection and erection of electrical equipment – Switchgear and controlgear*

IEC 61496-1:2004, *Safety of machinery – Electro-sensitive protective equipment – Part 1: General requirements and tests*

IEC 61557 (all parts), *Electrical safety in low voltage distribution systems up to 1 000 V a.c. and 1500 V d.c. – Equipment for testing, measuring or monitoring of protective measures –*

IEC 61558-2-17:1997, *Safety of power transformers, power supply units and similar – Part 2: Particular requirements for transformers for switch mode power supplies*

IEC 61800-3:2004, *Adjustable speed electrical power drive systems – Part 3: EMC requirements and standard including specific test methods*

IEC 61800-5-1:2003, *Adjustable speed electrical power drive systems – Part 5-1: Safety requirements – Electrical, thermal and energy*

CISPR 61000-6-3:1996, *Electromagnetic compatibility (EMC) – Part 6: Generic standards – Section 3: Emission standard for residential, commercial and light-industrial environments*

IEC Guide 106:1996, *Guide for specifying environmental conditions for equipment performance rating*

ISO 3864-1:2002, *Graphical symbols – Safety colours and safety signs – Part 1: Design principles for safety signs in workplaces and public areas*

ISO 13849-2:2003, *Safety of machinery – Safety-related parts of control systems – Part 2: Validation*

ISO 13851:2002, *Safety of machinery – Two-hand control devices – Functional aspects and design principles*

ISO 14118:2000, *Safety of machinery – Prevention of unexpected start-up*

ISO 14122-1:2001, *Safety of machinery – Permanent means of access to machinery – Part 1: Choice of fixed means of access between two levels*

ISO 14122-2:2001, *Safety of machinery – Permanent means of access to machinery – Part 2: Working platforms and walkways*

ISO 14122-3:2001, *Safety of machinery – Permanent means of access to machinery – Part 3: Stairs, stepladders and guard-rails*

CENELEC HD 516 S2, *Guide to use of low-voltage harmonized cables*

Index

This index lists, in alphabetical order, the terms defined in Clause 3 and indicates the subclauses where they are used in the text of this part of IEC 60204. The number of each definition is given in bold text.

actuator	3.1 , 3.13, 9.2.5.4.1, 10.1.2, 10.2.1, 10.2.2, 10.4, 10.6, 10.7.3, 10.8.2, 10.8.3, 10.9
ambient temperature	3.2 , 12.1, 12.4, A.4.3, Annex B
barrier	3.3 , 3.15, 3.20, 3.21, 3.29, 6.2.1, 6.2.2, 6.2.5, 11.2.1, 11.2.2, 12.7.1, 13.1.3, 13.4.3
cable tray	3.4 , 13.4.2, 13.5.1, 17.4, Annex B
cable trunking system	3.5 , 3.14, 13.1.3, 13.4.2, 13.5.1, 13.5.6
concurrent	3.6 , 9.2.5.2, 9.2.6.2
conduit	3.7 , 3.14, 13.1.1, 13.1.3, 13.4.2, 13.4.3, 13.5.1, 13.5.3, 13.5.4, 13.5.5, 14.4, D.1.2
control circuit	3.8 , 3.9, 3.42, 4.1, 5.3.5, 5.4, 7.2.4, 9.1.1, 9.1.2, 9.1.3, 9.3.5, 9.4.2.1, 9.4.2.2, 9.4.2.3, 9.4.3.1, 9.4.3.3, 11.2.2, 12.2, 12.4, 12.7.8, 13.2.4, 13.4.5, D.1.3
control device	3.9 , 3.17, 3.18, 9.1.1, 9.2.4, 9.2.5.2, 9.2.6.1, 9.2.6.2, 9.2.6.3, 9.3.4, 9.4.2.1, 10.1.2, 10.1.3, 10.1.5, 10.5, 11.2.1, 11.2.2, 13.3, 16.3, 16.5, 17.6, Annex B
controlgear	3.10 , 4.2.2, 6.3.2.2, 9.2.5.4.3, 11.1, 11.2.1, 11.2.2, 11.3, 11.5, 16.4, Annex B
controlled stop	3.11 , 9.2.2
direct contact	3.12 , 3.20, 3.38, 6.1, 6.2.1, 6.2.2, 6.2.4, 9.2.5.4, 10.1.3, 12.7.1
direct opening action	3.13 , 9.4.2.1, 10.1.4, 10.8.2
duct	3.14 , 7.2.8, 8.2.3, 12.3, 12.7.8, 13.1.3, 13.3, 13.4.1, 13.4.2, 13.5.1, 13.5.2, 17.4
electrical operating area	3.15 , 5.5, 9.2.5.4.3, 11.3, 11.5
electronic equipment	3.16 , 4.3.3, 4.4.2, 5.1, 9.4.2.3
emergency stop device	3.17 , 9.2.4, 9.2.7.2, 10.7, 10.8.1
emergency switching off device	3.18 , 9.2.5.4.1, 9.2.5.4.3, 10.2.1, 10.8, 12.7.1

enclosed electrical operating area	3.19 , 5.4, 5.6, 6.2.2, 8.2.4
enclosure	3.20 , 3.10, 4.4.2, 5.3.3, 6.2.2, 6.2.4, 7.2.8, 8.2.3, 8.2.5, 9.4.3.1, 10.8.1, 10.8.2, 11.2.1, 11.2.2, 11.3, 11.4, 11.5, 12.7.1, 12.7.6, 12.7.8, 13.3, 13.5.6, 14.2, 15.2.1, 15.2.2, 16.2.1, 16.4, 16.5, Annex B
equipment	3.21 , 1., 3.2, 3.5, 3.8, 3.10, 3.15, 3.16, 3.19, 3.20, 3.21, 3.23, 3.27, 3.42, 3.47, 3.51, 3.54, 3.57, 4.1, 4.2, 4.3.1, 4.3.4, 4.4.1, 4.4.2, 4.4.3, 4.4.4, 4.4.5, 4.4.6, 4.4.7, 4.4.8, 4.5, 4.6, 4.7, 5.1, 5.2, 5.3.1, 5.3.5, 5.4, 5.5, 6.1, 6.2.1, 6.2.2, 6.2.4, 6.3.1, 6.3.2.1, 6.3.2.2, 6.4.1, 7.1, 7.2.2, 7.2.5, 7.7, 7.9, 8.1, 8.2.1, 8.2.2, 8.2.3, 8.2.7, 8.2.8, 8.4, 9.2.5.4.1, 9.4.1, 10.3.2, 11.1, 11.2.1, 11.2.2, 11.3, 11.4, 11.5, 12.2, 12.3, 12.4, 13.3, 13.4.2, 13.4.5, 13.5.3, 14.1, 14.5, 15.2, 16.1, 16.2.1, 16.2.2, 16.3, 16.4, 17.1, 17.2, 17.3, 17.4, 17.6, 17.7, 17.9, 18.1, 18.2.2, 18.2.3, 18.3, 18.4, 18.6, 18.7, A.1, A.2, A.3, Annex B, D.1.2,
equipotential bonding	3.22 , 3.27, 3.43, 8.1
exposed conductive part	3.23 , 3.30, 3.45, 6.3.1, 6.3.3, 7.2.3, 8.2.1, 8.2.3, 8.2.5, 8.4, A.1, A.2, A.3, A.4.2
extraneous conductive part	3.24 , 3.45, 8.2.1, A.3
failure	3.25 , 3.26, 3.44, 4.1, 6.3.2.2, 8.1, 8.2.5, 8.3, 9.3.4, 9.4.1, 9.4.2, 9.4.2.1, 9.4.2.2, 9.4.2.3, 9.4.3.1, 9.4.3.2
fault	3.26 , 3.23, 3.25, 3.29, 3.40, 3.52, 4.1, 6.3.2.2, 6.3.2.3, 6.3.3, 6.4.2, 7.1, 7.2.9, 7.7, 8.1, 8.2.1, 8.2.8, 9.2.5.1, 9.2.7.3, 9.4.2.3, 9.4.3.1, 17.6, 18.2.2, 18.2.3, 18.6, A.1, A.2, A.4.1, A.4.2, A.4.3
functional bonding	3.27 , 4.4.2, 8.1, 8.3
hazard, hazardous	3.28 , 1, 3.20, 3.30, 3.49, 3.50, 3.53, 4.1, 5.4, 6.2.2, 6.2.4, 6.3.1, 6.3.2, 6.3.3, 7.3.1, 7.4, 7.5, 7.6, 7.8, 8.2.5, 9.2.3, 9.2.5.1, 9.2.5.3, 9.2.5.4.1, 9.2.5.4.2, 9.2.5.4.3, 9.2.5.5, 9.2.6.1, 9.2.6.4, 9.2.7.3, 9.2.7.5, 9.3.1, 9.3.2, 9.3.3, 9.3.4, 9.3.5, 9.4.1, 9.4.2.2, 9.4.2.3, 9.4.3.1, 9.4.3.2, 9.4.3.3, 10.1.1, 10.1.2, 10.1.4, 10.2.1, 10.3.2, 12.1, 12.3, 13.1, 13.4.5, 16.2.1, 16.2.2, 17.2, 18.2.3, Annex B, Annex E
indirect contact	3.29 , 6.1, 6.3, 6.4, 8.1, 18.1, Annex A
inductive power supply system	3.30 , 5.3.1, 5.5, 13.1.4
(electrically) instructed person	3.31 , 3.15, 3.19, 5.5, 6.2.2, Annex B
interlock	3.32 , 1, 6.2.2, 9.1.1, 9.2.5.3, 9.2.6.3, 9.3, 9.4.2.3, 11.2.2, 13.4.5, 17.2

live part	3.33 , 3.12, 6.2.2, 6.2.3, 6.2.4, 6.3.1, 6.3.2, 6.3.3, 6.4.1, 8.2.5, 8.2.8, 12.7.1, 13.4.5, 13.4.7, A.1
machine actuator	3.34 , 3.11, 3.35, 3.56, 9.2.2, 9.2.5.4.2, 9.2.5.4.3, 9.3.4, 14.6
machine, machinery	3.35 , 1, 3.8, 3.11, 3.20, 3.21, 3.26, 3.28, 3.30, 3.32, 3.34, 3.54, 3.56, 3.57, 4.1, 4.2.2, 4.4.1, 4.4.8, 4.6, 5.1, 5.2, 5.3.1, 5.3.4, 5.4, 5.5, 7.1, 7.2.1, 7.2.3, 7.3.1, 7.5, 7.8, 8.1, 8.2.1, 8.2.7, 9.1.1, 9.2.2, 9.2.3, 9.2.5.1, 9.2.5.2, 9.2.5.3, 9.2.5.4.1, 9.2.5.4.2, 9.2.5.4.3, 9.2.5.5, 9.2.6.2, 9.2.6.3, 9.2.7.1, 9.2.7.2, 9.2.7.3, 9.2.7.4, 9.2.7.5, 9.3.1, 9.3.3, 9.3.4, 9.3.5, 9.4.1, 9.4.3.1, 10.1.1, 10.1.2, 10.1.3, 10.1.4, 10.1.5, 10.3.2, 10.6, 11.1, 11.2.1, 11.3, 11.4, 11.5, 12.2, 12.6.2, 12.7.1, 13.1.2, 13.4.3, 13.4.4, 13.5.6, 13.5.7, 13.5.8, 14.2, 14.4, 15.1, 15.2, 16.2.1, 16.3, 16.4, 17.1, 17.2, 17.4, 17.6, 18.1, 18.2.1, 18.2.2, 18.2.3, 18.3, 18.7, A.1, A.3, A.4.2, Annex B, Annex C, D.1.2, F.1
marking	3.36 , 5.4, 5.5, 6.2.2, 9.4.3.1, 10.2.2, 11.2.1, 11.2.2, 13.1.1, 13.2.2, 16, Annex B
neutral conductor	3.37 , 3.33, 5.1, 5.3.3, 7.2.3, 7.3.2, 9.4.3.1, 12.7.2, 13.2.3, 13.2.4, D.3
obstacle	3.38 , 6.2.1, 6.2.2, 6.2.6, 9.2.5.4.3, 11.2.1
overcurrent	3.39 , 3.40, 3.52, 6.3.3, 7.1, 7.2, 7.7, 8.2.4, 9.1.3, 9.4.3.1, 14.1, 14.6, 15.1, 15.2.2, 17.4, 18.2.2, A.1, A.2, Annex B, D.2, D.3
overload	3.40 , 7.1, 7.3.1, 7.3.2, 7.3.3, 9.2.5.5, 9.4.3.1, 14.1, 14.6, 15.1, Annex B, D.2
plug/socket combination	3.41 , 5.3.2, 5.3.3, 5.6, 8.2.4, 11.2.1, 13.1.2, 13.3, 13.4.5, 13.4.6, 18.2.3
power circuit	3.42 , 1, 3.35, 4.1, 7.2.3, 11.2.2, 12.2, 12.7.8, 13.2.4, 18.3, 18.4
protective bonding	3.43 , 3.44, 3.45, 5.1, 6.3.3, 6.4.1, 7.2.4, 8.1, 8.2, 8.3, 9.1.1, 9.4.2.1, 9.4.3.1, 12.7.2, 12.7.8, 13.1.1, 13.4.5, 13.5.1, 15.1, 15.2.1, 18.1, 18.2.2, 18.2.3, 18.3, 18.4, A.1, A.3, A.4.2
protective bonding circuit	3.44 , 5.1, 6.4.1, 7.2.4, 8.1, 8.2, 8.4, 9.1.1, 9.4.2.1, 9.4.3.1, 12.7.2, 13.1.1, 13.4.5, 13.5.1, 15.1, 15.2.1, 18.1, 18.2.2, 18.2.3, 18.3, 18.4, A.3, A.4.2
protective conductor	3.45 , 3.44, 5.1, 5.2, 8.2.1, 8.2.2, 8.2.3, 8.2.6, 8.2.7, 8.2.8, 8.4, 12.7.2, 12.7.3, 12.7.4, 13.1.1, 13.1.2, 13.2.2, 13.2.4, 18.2.2, A.1, A.2, A.4.1, Annex B
redundancy	3.46 , 9.4.1, 9.4.2.2

reference designation	3.47 , 11.2.1, 16.5, 17.3, 17.9, Annex B
risk	3.48 , 1, 3.31, 3.33, 3.43, 3.50, 3.53, 4.1, 4.2.2, 5.4, 9.2.4, 9.2.5.3, 9.2.5.4.1, 9.2.5.4.2, 9.2.6.2, 9.2.7.4, 9.4.1, 9.4.2, 11.4, 13.2.1, 13.4.2, 16.2.1, 16.2.2, A.1, Annex E, F.1
safeguard	3.49 , 3.50, 4.1, 9.3.1, 17.2
safeguarding	3.50 , 3.32, 4.1, 17.2
servicing level	3.51 , 5.3.4, 10.1.2, 11.2.1
short-circuit current	3.52 , 7.2.9, 12.7.8, Annex B, D.3
(electrically) skilled person	3.53 , 3.15, 3.19, 3.31, 5.5, 6.2.2, Annex B
supplier	3.54 , 4.1, 4.2.1, 4.3.1, 4.4.1, 4.4.7, 4.4.8, 4.5, 4.7, 6.2.2, 7.2.2, 7.2.7, 7.2.10, 10.3.2, 11.2.2, 11.4, 12.3, 13.2.1, 16.1, 16.3, 16.4, 17.1, 17.3, 17.9, Annex B, F.1
switching device	3.55 , 3.10, 5.3.2, 5.3.3, 6.2.4, 7.2.10, 7.3.2, 8.2.4, 9.2.5.4.3, 9.4.2.1, 9.4.3.1, 13.4.4, 13.4.5
uncontrolled stop	3.56 , 9.2.2
user	3.57 , 1, 3.54, 4.1, 4.3.2, 4.4.1, 4.4.7, 4.4.8, 4.5, 7.2.2, 7.2.9, 7.3.2, 10.3.2, 13.2.1, 14.5, 16.3, 17.3, 17.4, 17.9, Annex B, F.1

British Standards Institution (BSI)

BSI is the independent national body responsible for preparing British Standards. It presents the UK view on standards in Europe and at the international level. It is incorporated by Royal Charter.

Revisions

British Standards are updated by amendment or revision. Users of British Standards should make sure that they possess the latest amendments or editions.

It is the constant aim of BSI to improve the quality of our products and services. We would be grateful if anyone finding an inaccuracy or ambiguity while using this British Standard would inform the Secretary of the technical committee responsible, the identity of which can be found on the inside front cover.
Tel: +44 (0)20 8996 9000 Fax: +44 (0)20 8996 7400

BSI offers members an individual updating service called PLUS which ensures that subscribers automatically receive the latest editions of standards.

Buying standards

Orders for all BSI, international and foreign standards publications should be addressed to Customer Services.

Tel: +44 (0)20 8996 9001 Fax: +44 (0)20 8996 7001

Email: orders@bsigroup.com

You may also buy directly using a debit/credit card from the BSI Shop on the Website <http://www.bsigroup.com/shop>.

In response to orders for international standards, it is BSI policy to supply the BSI implementation of those that have been published as British Standards, unless otherwise requested.

Information on standards

BSI provides a wide range of information on national, European and international standards through its Library and its Technical Help to Exporters Service. Various BSI electronic information services are also available which give details on all its products and services. Contact the Information Centre.

Tel: +44 (0)20 8996 7111 Fax: +44 (0)20 8996 7048

Email: info@bsigroup.com

Subscribing members of BSI are kept up to date with standards developments and receive substantial discounts on the purchase price of standards. For details of these and other benefits contact Membership Administration.

Tel: +44 (0)20 8996 7002 Fax: +44 (0)20 8996 7001

Email: membership@bsigroup.com

Information regarding online access to British Standards via British Standards Online can be found at <http://www.bsigroup.com/BSOL>.

Further information about BSI is available on the BSI website at <http://www.bsigroup.com>.

Copyright

Copyright subsists in all BSI publications. BSI also holds the copyright, in the UK, of the publications of the international standardization bodies. Except as permitted under the Copyright, Designs and Patents Act 1988 no extract may be reproduced, stored in a retrieval system or transmitted in any form or by any means – electronic, photocopying, recording or otherwise – without prior written permission from BSI.

This does not preclude the free use, in the course of implementing the standard, of necessary details such as symbols, and size, type or grade designations. If these details are to be used for any other purpose than implementation then the prior written permission of BSI must be obtained.

Details and advice can be obtained from the Copyright & Licensing Manager.

Tel: +44 (0)20 8996 7070 Email: copyright@bsigroup.com