

BS EN 15400:2011



BSI Standards Publication

Solid recovered fuels — Determination of calorific value

bsi.

...making excellence a habit.™

National foreword

This British Standard is the UK implementation of EN 15400:2011. It supersedes DD CEN/TS 15400:2006 which is withdrawn.

The UK participation in its preparation was entrusted to Technical Committee PTI/17, Solid biofuels.

A list of organizations represented on this committee can be obtained on request to its secretary.

This publication does not purport to include all the necessary provisions of a contract. Users are responsible for its correct application.

© BSI 2011

ISBN 978 0 580 68164 6

ICS 75.160.10

Compliance with a British Standard cannot confer immunity from legal obligations.

This British Standard was published under the authority of the Standards Policy and Strategy Committee on 31 March 2011.

Amendments issued since publication

Date	Text affected
------	---------------

EUROPEAN STANDARD

EN 15400

NORME EUROPÉENNE

EUROPÄISCHE NORM

March 2011

ICS 75.160.10

Supersedes CEN/TS 15400:2006

English Version

Solid recovered fuels - Determination of calorific valueCombustibles solides de récupération - Détermination du
pouvoir calorifique

Feste Sekundärbrennstoffe - Bestimmung des Brennwertes

This European Standard was approved by CEN on 22 January 2011.

CEN members are bound to comply with the CEN/CENELEC Internal Regulations which stipulate the conditions for giving this European Standard the status of a national standard without any alteration. Up-to-date lists and bibliographical references concerning such national standards may be obtained on application to the CEN-CENELEC Management Centre or to any CEN member.

This European Standard exists in three official versions (English, French, German). A version in any other language made by translation under the responsibility of a CEN member into its own language and notified to the CEN-CENELEC Management Centre has the same status as the official versions.

CEN members are the national standards bodies of Austria, Belgium, Bulgaria, Croatia, Cyprus, Czech Republic, Denmark, Estonia, Finland, France, Germany, Greece, Hungary, Iceland, Ireland, Italy, Latvia, Lithuania, Luxembourg, Malta, Netherlands, Norway, Poland, Portugal, Romania, Slovakia, Slovenia, Spain, Sweden, Switzerland and United Kingdom.

EUROPEAN COMMITTEE FOR STANDARDIZATION
COMITÉ EUROPÉEN DE NORMALISATION
EUROPÄISCHES KOMITEE FÜR NORMUNG**Management Centre: Avenue Marnix 17, B-1000 Brussels**

Contents

Page

Foreword.....	3
Introduction	4
1 Scope	5
2 Normative references	5
3 Terms and definitions	5
4 Principle	6
5 Reagents	7
6 Apparatus	7
7 Preparation of test sample.....	10
8 Calorimetric procedure	11
9 Calibration	17
10 Gross calorific value	22
11 Precision	26
12 Calculation of net calorific value at constant pressure	27
13 Test report	28
Annex A (normative) Adiabatic bomb calorimeters	29
Annex B (normative) Isoperibol and static-jacket bomb calorimeters	33
Annex C (normative) Automated bomb calorimeters	38
Annex D (informative) Checklists for the design and procedures of combustion experiments	41
Annex E (informative) Examples to illustrate the main calculations used in this European Standard if an automated (adiabatic) bomb calorimeter is used for determinations	46
Annex F (informative) List of symbols used in this European Standard.....	49
Annex G (informative) Key-word index	52
Annex H (informative) Flow chart for a routine calorific value determination	55
Annex I (informative) Interlaboratory test results	56
Bibliography	58

Foreword

This document (EN 15400:2011) has been prepared by Technical Committee CEN/TC 343 “Solid recovered fuels”, the secretariat of which is held by SFS.

This European Standard shall be given the status of a national standard, either by publication of an identical text or by endorsement, at the latest by September 2011, and conflicting national standards shall be withdrawn at the latest by September 2011.

This document supersedes CEN/TS 15400:2006.

Attention is drawn to the possibility that some of the elements of this document may be the subject of patent rights. CEN [and/or CENELEC] shall not be held responsible for identifying any or all such patent rights.

This document has been prepared under a mandate given to CEN by the European Commission and the European Free Trade Association.

This document differs from CEN/TS 15400:2006 mainly as follows:

- a) specification respectively recommendation regarding repeatability and reproducibility limits deleted;
- b) results of interlaboratory tests informatively added in Annex I;
- c) whole document editorially revised.

According to the CEN/CENELEC Internal Regulations, the national standards organizations of the following countries are bound to implement this European Standard: Austria, Belgium, Bulgaria, Croatia, Cyprus, Czech Republic, Denmark, Estonia, Finland, France, Germany, Greece, Hungary, Iceland, Ireland, Italy, Latvia, Lithuania, Luxembourg, Malta, Netherlands, Norway, Poland, Portugal, Romania, Slovakia, Slovenia, Spain, Sweden, Switzerland and United Kingdom.

Introduction

WARNING — Strict adherence to all of the provisions specified in this document should ensure against explosive rupture of the bomb, or a blow-out, provided that the bomb is of proper design and construction and in good mechanical condition.

This European Standard is based on ISO 1928 and EN 14918 and modified to solid recovered fuels with some additions and alterations specific to solid recovered fuels properties.

The result obtained is the gross calorific value of the sample analysed at constant volume with all the water of the combustion products as liquid water. In practice, solid recovered fuels are burned at a constant (atmospheric) pressure and the water is either not condensed (removed as vapour with the flue gases) or condensed. Under both conditions, the operative heat of combustion to be used is the net calorific value of the fuel at constant pressure. The net calorific value at constant volume can also be used; equations are given for calculating both values.

General principles and procedures for the calibrations and the solid recovered fuels experiments are presented in the normative text, whereas those pertaining to the use of a particular type of calorimetric instrument are specified in Annexes A to C. Annex D contains checklists for performing calibration and fuel experiments using specified types of calorimeters. Annex E gives examples to illustrate some of the calculations.

1 Scope

This European Standard specifies a method for the determination of gross calorific value of solid recovered fuels at constant volume and at the reference temperature 25 °C in a bomb calorimeter calibrated by combustion of certified benzoic acid.

2 Normative references

The following referenced documents are indispensable for the application of this document. For dated references, only the edition cited applies. For undated references, the latest edition of the referenced document (including any amendments) applies.

EN 15296, *Solid biofuels — Conversion of analytical results from one basis to another*

EN 15357:2011, *Solid recovered fuels — Terminology, definitions and descriptions*

EN 15358, *Solid recovered fuels — Quality management systems — Particular requirements for their application to the production of solid recovered fuels*

EN 15414-3, *Solid recovered fuels — Determination of moisture content using the oven dry method — Part 3: Moisture in general analysis sample*

EN 15440, *Solid recovered fuels — Methods for the determination of biomass content*

EN 15443, *Solid recovered fuels — Methods for the preparation of the laboratory sample*

EN ISO 10304-1, *Water quality — Determination of dissolved anions by liquid chromatography of ions — Part 1: Determination of bromide, chloride, fluoride, nitrate, nitrite, phosphate and sulfate (ISO 10304-1:2007)*

3 Terms and definitions

For the purposes of this document, the terms and definitions given in EN 15357:2011 and the following apply.

3.1

gross calorific value at constant volume

absolute value of the specific energy of combustion, in Joules, for unit mass of a solid recovered fuel burned in oxygen in a calorimetric bomb under the conditions specified

NOTE The products of combustion are assumed to consist of gaseous oxygen, nitrogen, carbon dioxide and sulphur dioxide, of liquid water (in equilibrium with its vapour) saturated with carbon dioxide under the conditions of the bomb reaction, and of solid ash, all at the reference temperature.

3.2

net calorific value at constant volume

absolute value of the specific energy of combustion, in Joules, for unit mass of a solid recovered fuel burned in oxygen under conditions of constant volume and such that all the water of the reaction products remains as water vapour (in a hypothetical state at 0,1 MPa), the other products being, as for the gross calorific value, all at the reference temperature

3.3

net calorific value at constant pressure

absolute value of the specific heat (enthalpy) of combustion, in Joules, for unit mass of a solid recovered fuel burned in oxygen at constant pressure under such conditions that all the water of the reaction products remains as water vapour (at 0,1 MPa), the other products being as for the gross calorific value, all at the reference temperature

3.4 reference temperature

international reference temperature for thermo-chemistry of 25 °C is adopted as the reference temperature for calorific values (see 8.7)

NOTE The temperature dependence of the calorific value of solid recovered fuels is small [less than 1 J/(g · K)].

3.5 effective heat capacity of the calorimeter

amount of energy required to cause unit change in temperature of the calorimeter

3.6 corrected temperature rise

change in calorimeter temperature caused solely by the processes taking place within the combustion bomb

NOTE 1 It is the total observed temperature rise corrected for heat exchange, stirring power etc. (see 8.6).

NOTE 2 The change in temperature can be expressed in terms of other units: resistance of a platinum or thermistor thermometer, frequency of a quartz crystal resonator etc., provided that a functional relationship is established between this quantity and a change in temperature. The effective heat capacity of the calorimeter can be expressed in units of energy per such an arbitrary unit. Criteria for the required linearity and closeness in conditions between calibrations and fuel experiments are given in 9.3.

NOTE 3 A list of the symbols used and their definitions is given in Annex F.

4 Principle

4.1 Gross calorific value

A weighed portion of the analysis sample of a solid recovered fuel is burned in high-pressure oxygen in a bomb calorimeter under specified conditions. The effective heat capacity of the calorimeter is determined in calibration experiments by the combustion of certified benzoic acid under similar conditions, accounted for in the certificate. The corrected temperature rise is established from observations of temperature before, during and after the combustion reaction takes place. The duration and frequency of the temperature observations depend on the type of calorimeter used. Water is added to the bomb initially to give a saturated vapour phase prior to combustion (see 8.2.1 and 9.2.2), thereby allowing all the water formed, from the hydrogen and moisture in the sample, to be regarded as liquid water.

The gross calorific value is calculated from the corrected temperature rise and the effective heat capacity of the calorimeter, with allowances made for contributions from ignition energy, combustion of the fuse(s) and for thermal effects from side reactions such as the formation of nitric acid. Furthermore, a correction is applied to account for the difference in energy between the aqueous sulphuric acid formed in the bomb reaction and gaseous sulphur dioxide, i.e. the required reaction product of sulphur in the solid recovered fuel. The corresponding energy effect between aqueous and gaseous hydrochloric acid is neglected for solid recovered fuels.

NOTE The corresponding energy effect between aqueous and gaseous hydrochloric acid depends on the sample characteristics, e.g. the content of inorganic and organic chlorine, mineral composition and the actual pH-value in bomb liquid. At the present time no values are available for this chlorine correction. Attention should be paid to the extremely high chlorine content in the test sample because e.g. PVC fractions can affect the calorific value significantly.

4.2 Net calorific value

The net calorific value at constant volume and the net calorific value at constant pressure of the solid recovered fuel are obtained by calculation from the gross calorific value at constant volume determined on the analysis sample. The calculation of the net calorific value at constant volume requires information about the moisture and hydrogen contents of the analysis sample. In principle, the calculation of the net calorific value at constant pressure also requires information about the oxygen and nitrogen contents of the sample.

5 Reagents

5.1 Oxygen, at a pressure high enough to fill the bomb to 3 MPa, pure with an assay of at least 99,5 % volume fraction, and free from combustible matter.

NOTE Oxygen made by the electrolytic process can contain up to 4 % volume fraction of hydrogen.

5.2 Fuse

5.2.1 Ignition wire, of nickel-chromium 0,16 mm to 0,20 mm in diameter, platinum 0,05 mm to 0,10 mm in diameter, or another suitable conducting wire with well-characterized thermal behaviour during combustion.

5.2.2 Cotton fuse, of white cellulose cotton, or equivalent, if required (see NOTE 1 of 8.2.1).

5.3 Combustion aids, of known gross calorific value, composition and purity, e.g. benzoic acid, n-dodecane, paraffin oil, combustion bags or capsules.

5.4 Standard volumetric solutions and indicators, only for use if analysis of final bomb solutions is required.

5.4.1 Barium hydroxide solution, $c[\text{Ba}(\text{OH})_2] = 0,05 \text{ mol/l}$.

5.4.2 Sodium carbonate solution, $c(\text{Na}_2\text{CO}_3) = 0,05 \text{ mol/l}$.

5.4.3 Sodium hydroxide solution, $c(\text{NaOH}) = 0,1 \text{ mol/l}$.

5.4.4 Hydrochloric acid solution, $c(\text{HCl}) = 0,1 \text{ mol/l}$.

5.4.5 Screened methyl orange indicator, 1 g/l solution: Dissolve 0,25 g of methyl orange and 0,15 g of xylene cyanole FF in 50 ml of ethanol with a volume fraction of 95 % and dilute to 250 ml with water.

5.4.6 Phenolphthalein, 10 g/l solution: Dissolve 2,5 g of phenolphthalein in 250 ml ethanol with a volume fraction of 95 %.

5.5 Benzoic acid, of calorimetric-standard quality, certified by (or with certification unambiguously traceable to) a recognized standardizing authority.

NOTE 1 Benzoic acid is the sole substance recommended for calibration of an oxygen-bomb calorimeter. For the purpose of checking the overall reliability of the calorimetric measurements, test substances, e.g. n-dodecane, are used. Test substances are mainly used to prove that certain characteristics of a sample, e.g. burning rate or chemical composition, do not introduce bias in the results.

NOTE 2 The benzoic acid is burned in the form of pellets. It is usually used without drying or any treatment other than pelletizing; the sample certificate provides information. It does not absorb moisture from the atmosphere at relative humidities below 90 %.

The benzoic acid shall be used as close to certification conditions as is feasible; significant departures from these conditions shall be accounted for in accordance with the directions in the certificate. The energy of combustion of the benzoic acid, as defined by the certificate for the conditions utilized, shall be adopted in calculating the effective heat capacity of the calorimeter (see 9.2).

6 Apparatus

6.1 General

The calorimeter (see Figure 1), consists of the assembled combustion bomb (6.2.1), the calorimeter can (6.2.2) (with or without a lid), the calorimeter stirrer (6.2.3), water, temperature sensor, and leads with

connectors inside the calorimeter can required for ignition of the sample or as part of temperature measurement or control circuits. During measurements the calorimeter is enclosed in a thermostat (6.2.4). The manner in which the thermostat temperature is controlled defines the working principle of the instrument and hence the strategy for evaluation of the corrected temperature rise.

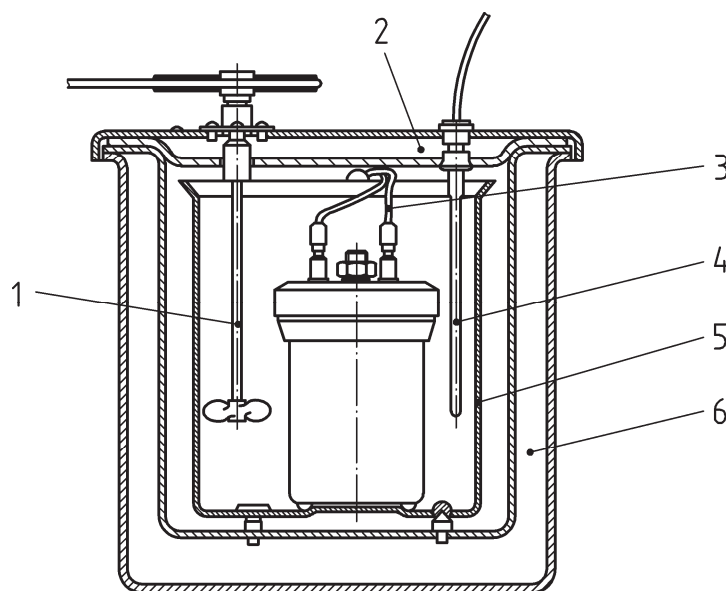

Key

- | | | | |
|---|-----------------|---|-------------------------|
| 1 | stirrer (6.2.3) | 4 | thermometer |
| 2 | thermostat lid | 5 | calorimeter can (6.2.2) |
| 3 | ignition leads | 6 | thermostat (6.2.4) |

Figure 1 — Classical-type bomb combustion calorimeter with thermostat

In aneroid systems (systems without a fluid) the calorimeter can, stirrer and water are replaced by a metal block. The combustion bomb itself constitutes the calorimeter in some aneroid systems.

In combustion calorimetric instruments with a high degree of automation, especially in the evaluation of the results, the calorimeter is in a few cases not as well-defined as the traditional, classical-type calorimeter. Using such an automated calorimeter is, however, within the scope of this European Standard as long as the basic requirements are met with respect to calibration conditions, comparability between calibration and fuel experiments, ratio of sample mass to bomb volume, oxygen pressure, bomb liquid, reference temperature of the measurements and repeatability of the results. A print-out of some specified parameters from the individual measurements is essential. Details are given in Annex C.

As the room conditions (temperature fluctuation, ventilation etc.) can have an influence on the precision of the determination, the manufacturers instructions for the placing of the instrument shall always be followed.

Equipment, adequate for determinations of calorific value in accordance with this European Standard, is specified in 6.2 to 6.8.

6.2 Calorimeter with thermostat

6.2.1 Combustion bomb, capable of withstanding safely the pressures developed during combustion. The design shall permit complete recovery of all liquid products. The material of construction shall resist corrosion by the acids produced in the combustion of solid recovered fuels. A suitable internal volume of the bomb would be from 250 ml to 350 ml.

WARNING — Bomb parts shall be inspected regularly for wear and corrosion; particular attention shall be paid to the condition of the threads of the main closure. Manufacturers' instructions and any local regulations regarding the safe handling and use of the bomb shall be observed. If more than one bomb of the same design is used, it is imperative to use each bomb as a complete unit. Swapping of parts can lead to a serious accident.

6.2.2 Calorimeter can, made of metal, highly polished on the outside and capable of holding an amount of water sufficient to completely cover the flat upper surface of the bomb while the water is being stirred. A lid generally helps reduce evaporation of calorimeter water, but unless it is in good thermal contact with the can it lags behind in temperature during combustion, giving rise to undefined heat exchange with the thermostat and a prolonged main period.

6.2.3 Stirrer, working at constant speed. The stirrer shaft should have a low-heat-conduction and/or a low-mass section below the cover of the surrounding thermostat (6.2.4) to minimise transmission of heat to or from the system; this is of particular importance if the stirrer shaft is in direct contact with the stirrer motor. If a lid is used for the calorimeter can (6.2.2), this section of the shaft should be above the lid.

NOTE The rate of stirring for a stirred-water type calorimeter should be large enough to make sure that hot spots do not develop during the rapid part of the change in temperature of the calorimeter. A rate of stirring such that the length of the main period can be limited to 10 min or less is usually adequate (see Annexes A and B).

6.2.4 Thermostat (water jacket), completely surrounding the calorimeter, with an air gap of approximately 10 mm separating calorimeter and thermostat.

The mass of water of a thermostat intended for isothermal operation shall be sufficiently large to outbalance thermal disturbances from the outside. The temperature should be controlled to within $\pm 0,1$ K or better throughout the experiment. A passive constant temperature ("static") thermostat shall have a heat capacity large enough to restrict the change in temperature of its water. Criteria for satisfactory behaviour of this type of water jacket are given in Annex B.

NOTE 1 For an insulated metal static jacket, satisfactory properties are usually ensured by making a wide annular jacket with a capacity for water of at least 12,5 l.

NOTE 2 Calorimeters surrounded by insulating material, creating a thermal barrier, are regarded as static-jacket calorimeters.

If the thermostat (water jacket) is required to follow closely the temperature of the calorimeter, it should be of low mass and preferably have immersion heaters. Energy shall be supplied at a rate sufficient to maintain the temperature of the water in the thermostat to within 0,1 K of that of the calorimeter water after the charge has been fired. If in a steady state at 25 °C, the calculated mean drift in temperature of the calorimeter shall not exceed 0,000 5 K/min (see A.3.2).

6.2.5 Temperature measuring instrument, capable of indicating temperature with a resolution of at least 0,001 K so that temperature intervals of 2 K to 3 K can be determined with a resolution of 0,002 K or better. The absolute temperature shall be known to the nearest 0,1 K at the reference temperature of the calorimetric measurements. The temperature measuring device should be linear, or linearized, in its response to changes in temperature over the interval it is used.

As alternatives to the traditional mercury-in-glass thermometers, suitable temperature sensors are platinum resistance thermometers, thermistors, quartz crystal resonators etc. which together with a suitable resistance bridge, null detector, frequency counter or other electronic equipment provide the required resolution. The short-term repeatability of this type of device shall be 0,001 K or better. Long-term drift shall not exceed the equivalent of 0,05 K for a period of six months. For sensors with linear response (in terms of temperature), drift is less likely to cause bias in the calorimetric measurements than are non-linear sensors.

Mercury-in-glass thermometers which conform to ISO 651, ISO 652, ISO 1770 or ISO 1771 satisfy the requirements. A viewer with magnification about 5× is needed for reading the temperature with the resolution required.

A mechanical vibrator to tap the thermometer is suitable for preventing the mercury column from sticking (see 8.4). If this is not available, the thermometer shall be tapped manually before reading the temperature.

6.2.6 Ignition circuit

The electrical supply shall be 6 V to 12 V alternating current from a step-down transformer or direct current from batteries. It is desirable to include a pilot light in the circuit to indicate if current is flowing.

Where the firing is done manually, the firing switch shall be of the spring-loaded, usually open type, located in such a manner that any undue risk to the operator is avoided (see warning in 8.4).

6.3 Crucible, of silica, nickel-chromium, platinum or similar unreactive material.

The crucible should be 15 mm to 25 mm in diameter, flat based and about 20 mm deep. Silica crucibles should be about 1,5 mm thick and metal crucibles about 0,5 mm thick.

If smears of unburned carbon occur, a small low-mass platinum or nickel-chromium crucible, for example 0,25 mm thick, 15 mm in diameter and 7 mm deep, may be used.

6.4 Ancillary pressure equipment

6.4.1 **Pressure regulator**, to control the filling of the bomb with oxygen.

6.4.2 **Pressure gauge** (e.g. 0 MPa to 5 MPa), to indicate the pressure in the bomb with a resolution of 0,05 MPa.

6.4.3 **Relief valve or bursting disk**, operating at 3,5 MPa, and installed in the filling line, to prevent overfilling the bomb.

CAUTION — Equipment for high-pressure oxygen shall be kept free from oil and grease (high vacuum grease recommended by the manufacturer may be used according to the operating manual of the instrument). Do not test or calibrate the pressure gauge with hydrocarbon fluid.

6.5 **Timer**, indicating minutes and seconds.

6.6 Balances

6.6.1 **Balance for weighing the sample, fuse**, with a resolution of at least 0,1 mg; 0,01 mg is preferable and is recommended if the sample mass is of the order of 0,5 g or less (see 8.2.1).

6.6.2 **Balance for weighing the calorimeter water**, with a resolution of 0,5 g (unless water can be dispensed into the calorimeter by volume with the required accuracy, see 8.3).

6.7 **Thermostat** (optional), for equilibrating the calorimeter water before each experiment to a predetermined initial temperature, within about $\pm 0,3$ K.

6.8 **Pellet press**, capable of applying a pressure resulting from a mass of about 10^3 kg, either hydraulically or mechanically, and having a die suitable to press a pellet having a diameter of about 13 mm and a mass of $(1 \pm 0,1)$ g.

7 Preparation of test sample

The solid recovered fuel sample used for the determination of calorific value shall be the general analysis sample (ground to pass a test sieve with an aperture of 1,0 mm) prepared according to the procedure given in EN 15443.

The preparation of test sample for determining calorific value of biomass/non-biomass part of SRF shall be carried out in accordance with EN 15440.

Due to the low density of solid recovered fuels they shall be tested in a pellet form. Press a pellet with a mass of $(1 \pm 0,1)$ g with a suitable force to produce a compact test piece. Alternatively, the test may be carried out in powder form, closed in a combustion bag or capsule.

NOTE 1 For sample materials containing high content of plastics or rubber, the mass of the sample should be reduced to a mass in the range from 0,4 g to 0,8 g.

NOTE 2 For sample materials containing a mass fraction of ash ≥ 30 % on dry basis, it is recommended to use a combustion aid (see 8.2.2).

The sample shall be well-mixed and in reasonable moisture equilibrium with the laboratory atmosphere. The moisture content shall either be determined simultaneously with the weighing of the samples for the determination of calorific value or the sample shall be kept in a small, effectively closed container until moisture analyses are performed, to allow appropriate corrections for moisture in the analysis sample.

The moisture content of the analysis sample shall be determined in accordance with EN 15414-3.

8 Calorimetric procedure

8.1 General

The calorimetric determination consists of two separate experiments, combustion of the calibration reference (benzoic acid) and combustion of the solid recovered fuels, both under same specified conditions. The calorimetric procedure for the two types of experiment is essentially the same. In fact, the overall similarity is a requirement for proper cancellation of systematic deviations caused, for example, by uncontrolled heat leaks not accounted for in the evaluation of the corrected temperature rise θ .

The experiment consists of quantitatively carrying out a combustion reaction (in high-pressure oxygen in the bomb) to defined products of combustion and of measuring the change in temperature caused by the total bomb process.

The temperature measurements required for the evaluation of the corrected temperature rise θ are made during a fore period, a main (= reaction) period, and an after period as outlined in Figure 2. For the adiabatic type calorimeter, the fore and after periods need, in principle, be only as long as required to establish the initial (firing) and final temperatures, respectively (see Annex A). For the isoperibol (isothermal jacket) and the static-jacket type calorimeters, the fore and after periods serve to establish the heat exchange properties of the calorimeter required to allow proper correction for heat exchange between calorimeter and thermostat during the main period if combustion takes place. The fore and after periods then have to be longer (see Annex B).

The power of stirring shall be maintained constant throughout an experiment which calls for a constant rate of stirring. An excessive rate of stirring results in an undesirable increase in the power of stirring with ensuing difficulties in keeping it constant. A wobbling stirrer is likely to cause significant short-term variations in stirring power.

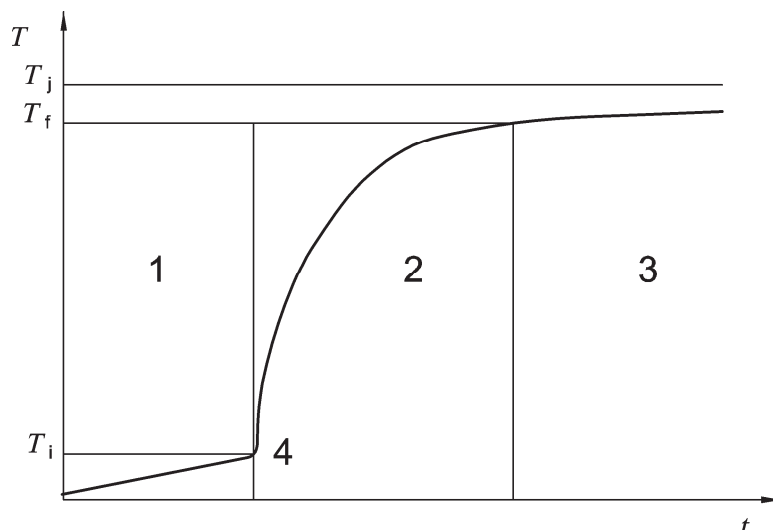

Key

- 1 fore period
- 2 main period
- 3 after period
- 4 ignition temperature, T_i

Figure 2 — Time-temperature curve (isoperibol calorimeter)

During combustion, the bomb head will become appreciably hotter than other parts of the bomb, and it is important to have enough well-stirred water above it to maintain reasonably small temperature gradients in the calorimeter water during the rapid part of the rise in temperature. For aneroid systems, the particular design determines to what extent hot spots can develop (see Annex C).

Certain solid recovered fuels can persistently burn incompletely; “exploding” and/or leaving residues that contain significant amounts of unburned sample or soot. By adding known amounts of an auxiliary material (e.g. benzoic acid, n-dodecane or paraffin oil), by using bags or capsules or cotton fuse, or by omitting the distilled water from the bomb, or by using a lower oxygen filling pressure, clean combustion can in most instances be achieved.

The auxiliary material shall be chemically stable, have known composition and purity, a low vapour pressure and a well-established energy of combustion; the energy should be known to within 0,10 % for the particular material used. The amount used should be limited to the minimum amount required to achieve complete combustion of the sample. It should not exceed an amount that contributes half of the total energy in an experiment. The optimum proportion of the sample to auxiliary material depends on the properties of the fuel, and needs to be determined by experiment.

The mass of the auxiliary material shall be determined as accurately as possible so that its contribution can be correctly accounted for; this is particularly important if a hydrocarbon oil is used as its specific energy of combustion is considerably higher than that of the solid recovered fuel.

8.2 Preparing the bomb for measurement

8.2.1 General procedure

Weigh the sample pellet, or the filled combustion bag or capsule, in the crucible (6.3), with a weighing resolution of 0,01 % or better. For 1 g samples (see 9.2 and 10.2), this means weighing to the nearest 0,1 mg. Weigh the combustible fuse and/or ignition wire either with a precision comparable with that for weighing the sample, or keep its mass constant, within specified limits, for all experiments (see 9.4 and 9.6.1).

Fasten the ignition wire securely between the electrodes in the combustion bomb (6.2.1) (see also NOTE 1). Check the resistance of the ignition circuit of the bomb; for most bombs it shall not exceed 10Ω , measured between the outside connectors of the bomb head, or between the connector for the insulated electrode and the bomb head.

Tie, or attach firmly, the fuse (if needed, see NOTE 1) to the ignition wire, place the crucible in its support and bring the fuse into contact with the sample pellet or capsule. Make sure that the position of the crucible in the assembled bomb is symmetrical with respect to the surrounding bomb wall.

If the ignition wire is combustible as well as electrically conducting, an alternative procedure may be adopted. A longer piece of wire, enough to make an open loop, may be connected to the electrodes. After mounting of the crucible, the loop shall be brought in contact with the sample pellet or capsule. For some types of calorimeters the ignition process is better checked if the wire is kept at a small distance above the sample pellet.

NOTE 1 Care should be taken to prevent any contact between ignition wire and crucible, in particular if a metal crucible is used since this would result in shorting the ignition circuit. A special fuse is superfluous under these conditions. The resistance of the ignition circuit of the bomb will be increased by a small amount only. For closer details of preparing the bomb refer also to manufacturers instructions.

Add a defined amount of distilled water to the combustion bomb (6.2.1). The amount shall always be exactly the same in both calibration and in determinations (see 9.2.1 and 9.2.2).

NOTE 2 As a main principle for solid recovered fuels, $(1,0 \pm 0,1)$ ml distilled water is added into the bomb. With some solid recovered fuels (and some calorimeters) the complete combustion can be achieved by omitting the distilled water from the bomb or by using a combustion aid. In some cases, the total absorption of the gaseous combustion products can provide the use of a larger amount of distilled water (e.g. 5 ml).

Assemble the combustion bomb (6.2.1) and charge it slowly with oxygen to a pressure of $(3,0 \pm 0,2)$ MPa without displacing the original air or, flush the bomb (with the outlet valve open, see manufacturers instructions) with oxygen for about 30 s, close the valve slowly and charge the bomb to the pressure of $(3,0 \pm 0,2)$ MPa. The same procedure shall be used both in calibration and in determinations. If the bomb is inadvertently charged with oxygen above 3,3 MPa, discard the test and begin again.

WARNING — Do not reach over the combustion bomb during charging.

The combustion bomb (6.2.1) is now ready for mounting in the calorimeter can (6.2.2).

8.2.2 Using combustion aids

The following combustion aids may be used:

- a) Liquid combustion aid: After the mass of the sample pellet has been determined, the auxiliary liquid material shall be added drop by drop on the pellet placed in the crucible, allowing the liquid to be absorbed; and determined precisely by weighing;
- b) solid combustion aid: Solid combustion aids (benzoic acid recommended) should not be used without combustion bags or capsules;

NOTE It can be difficult to achieve a homogenous mixture of sample and combustion aid before pressing the test pellet.

- c) combustion bags or capsules: Combustion capsules or bags, or combustible crucibles with precisely known calorific value (gelatine, aceto butyrate or polyethylene) may be used as combustion aids (as such or with e.g. benzoic acid) according to the manufacturers instructions. They shall be weighed precisely before filling (see also 8.1). The sample and the combustion aid like benzoic acid shall be mixed cautiously in the bag or capsule before testing.

8.3 Assembling the calorimeter

Bring the calorimeter water to within $\pm 0,3$ K of the selected initial temperature and fill the calorimeter can (6.2.2) with the required amount. The quantity of water in the calorimeter shall be the same to within 0,5 g or better, in all experiments (see 9.6.1). Make sure that the outer surface of the can is dry and clean before the latter is placed in the thermostat (6.2.4). Mount the combustion bomb (6.2.1) in the calorimeter can containing the correct amount of water after the can has been placed in the thermostat.

Alternatively, the system may be operated on a constant total-calorimeter-mass basis (see 9.6.2). The combustion bomb (6.2.1) is then mounted in the calorimeter can (6.2.2) before this is weighed with the water. The total mass of the calorimeter can, with the assembled bomb and the calorimeter water, shall be within the limiting deviation of 0,5 g or better in all experiments.

The assembled calorimeter shall contain enough water to cover completely the flat upper surface of the bomb head and cap.

Weigh the water to within 0,5 g if the effective heat capacity is in the order of 10 kJ/K.

Check the combustion bomb (6.2.1) for gas leaks as soon as its top becomes covered with water. If the gas valves are not fully submerged, check for leaks with a drop of water across the exposed opening. Connect the leads for the ignition circuit (6.2.6) and mount the thermometer.

WARNING — If gas escapes from the bomb, discard the test, eliminate the cause of leakage and begin again. Apart from being a hazard, leaks will inevitably lead to erroneous results.

Cooling water, temperature controls, stirrers etc. are turned on and adjusted, as outlined in the instrument manual. Make sure that the calorimeter stirrer (6.2.3) works properly. A period of about 5 min is usually required for the assembled calorimeter to reach a steady state in the thermostat or jacket, irrespective of the type of calorimeter. The criteria for when steady state has been attained depend on the working principle of the calorimeter (see Annexes A and B).

8.4 Combustion reaction and temperature measurements

Start taking temperature readings, to the nearest 0,001 K or better, as soon as the calorimeter has reached steady-state conditions. Readings at 1 min intervals usually suffices to establish the drift rate of the fore period or check the proper functioning of an adiabatic system. If a mercury-in-glass thermometer is used for the temperature measurements, tap the thermometer lightly for about 10 s before each reading and take care to avoid parallax deviations.

At the end of the fore period, if the initial temperature T_i has been established, the combustion is initiated by firing the fuse. Hold the switch closed only for as long as it takes to ignite the fuse. Usually, the current is automatically interrupted as the conducting wire starts burning or partially melts. As long as the resistance of the ignition circuit of the combustion bomb is kept at its usual low value, the electrical energy required to initiate the reaction is so small that there is no need to measure and account for it separately.

WARNING — Do not extend any part of the body over the calorimeter during firing, nor for 20 s thereafter.

Continue taking temperature readings at 1 min intervals. The time corresponding to T_i marks the beginning of the main period. During the first few minutes after the charge has been fired, if the temperature is rising rapidly, readings to the nearest 0,02 K are adequate. Resume reading temperatures to the nearest 0,001 K or better as soon as is practicable, but no later than 5 min after the beginning of the main period. Criteria for the length of the fore, main and after periods, and hence the total number of temperature readings required, are given in Annexes A and B.

8.5 Analysis of products of combustion

At the end of the after period, if all the required temperature readings have been completed, remove the combustion bomb (6.2.1) from the calorimeter, release the pressure slowly (following manufacturers manual) and dismantle the bomb. Examine the interior of the bomb, the crucible (6.3) and any solid residue carefully for signs of incomplete combustion. Discard the test if unburned sample or any soot deposit is visible. Remove and measure any pieces of combustible ignition wire which have not reacted during the combustion process.

NOTE Another symptom of incomplete combustion is the presence of carbon monoxide in the bomb gas. Slow release of the gas through a suitable detector tube reveals any presence of carbon monoxide and indicates the concentration level. 0,1 ml/l of carbon monoxide in the combustion gas from a 300 ml bomb corresponds to a deviation of about 10 J.

Wash the contents of the bomb into a beaker with distilled water. Make sure that the underside of the bomb head, the electrodes and the outside of the crucible are also washed.

In the case of calibration experiments, determine the formed nitric acid from the combined bomb washings either by ion-chromatography (as nitrate) as specified in EN ISO 10304-1 or dilute the combined washings to about 50 ml and analyse for nitric acid, e.g. by titration with the sodium hydroxide solution (5.4.3) to a pH value of about 5,5 or by using the screened methyl orange solution (5.4.5) as an indicator.

If the "sulphur" and/or nitric acid corrections are based on the actual amounts formed in the bomb process, the bomb washings from fuel combustions shall be analysed by the procedure specified in a) to c) of this subclause or by an equivalent method. If the sulphur content of the solid recovered fuels and the nitric acid correction are known, analysis of the final bomb liquid may be omitted (see 10.1).

- a) Determine the amounts of nitric and sulphuric acid formed (as nitrate and as sulphate, respectively) by ion-chromatography as specified in EN ISO 10304-1;
- b) dilute the combined bomb washings to about 100 ml. Boil the washings to expel carbon dioxide and titrate the solution with barium hydroxide solution (5.4.1) while it is still hot using the phenolphthalein solution (5.4.6) as an indicator. Add 20,0 ml of the sodium carbonate solution (5.4.2), filter the warm solution and wash the precipitate with distilled water. If cold, titrate the filtrate with the hydrochloric acid solution (5.4.4), using the screened methyl orange solution (5.4.5) as an indicator, ignoring the phenolphthalein colour change;
- c) if the sulphur content of the solid recovered fuel is known, the boiled bomb washings may be titrated, while still hot, with a simplified method using sodium hydroxide solution (5.4.3) and phenolphthalein as an indicator (5.4.6).

8.6 Corrected temperature rise θ

8.6.1 Observed temperature rise

The temperature at the end of the main period T_f gives, together with the initial or firing temperature T_i , the observed temperature rise $T_f - T_i$.

8.6.2 Isoperibol and static-jacket calorimeters

In addition to the rise in temperature caused by the processes in the combustion bomb, the observed temperature rise contains contributions from heat exchange between calorimeter and thermostat and from stirring power. Allowance for heat exchange is made by the so called heat leak correction ΔT_{ex} which includes the contribution from stirring power, i.e.

$$T_f - T_i = \theta + \Delta T_{ex} \quad (1)$$

and hence

$$\theta = (T_f - T_i) - \Delta T_{\text{ex}} \quad (2)$$

There are various ways of evaluating the term ΔT_{ex} . The most common procedures used are the Regnault-Pfaundler and the Dickinson extrapolation methods.

NOTE The Regnault-Pfaundler method automatically accounts for variations in the time-temperature relationship for different types of samples and is hence the more reliable of the two methods.

Detailed instructions for the numerical evaluation of ΔT_{ex} , and the corrected temperature rise θ for isoperibol and static-jacket calorimeters are given in Annex B. The resulting equations for ΔT_{ex} are summarized as follows:

a) Regnault-Pfaundler method (see B.5.2):

$$\Delta T_{\text{ex}} = (t_f - t_i) \times g_f + \frac{g_i - g_f}{T_{\text{mf}} - T_{\text{mi}}} \times \left[n \times T_{\text{mf}} - \frac{(T_i + T_f)}{2} - \sum_{k=1}^{n-1} T_k \right] \quad (3)$$

where

g_i is the drift rate in the fore (initial rating) period, in Kelvin per minute;

g_f is the drift rate in the after (final rating) period, in Kelvin per minute;

T_{mi} is the mean temperature in the fore period, in degrees Celsius;

T_{mf} is the mean temperature in the after period, in degrees Celsius;

T_i ($= T_0$) is the temperature at the beginning of the main period (the time for ignition), in degrees Celsius;

T_f ($= T_n$) is the temperature at the end of the main period, in degrees Celsius;

T_k are the successive temperature readings taken at 1 min intervals during the main period (T_1 , being the temperature one minute after the beginning of the main period and $T_n = T_f$), in degrees Celsius;

t_i is the time at the beginning of the main period (time of ignition), in minutes;

t_f is the time at the end of the main period, in minutes;

n is the number of 1 min intervals in the main period;

k $k = 1, \dots, n - 1$.

b) Dickinson extrapolation method (see B.5.3):

$$\Delta T_{\text{ex}} = g_i(t_x - t_i) + g_f(t_f - t_x) \quad (4)$$

where

t_x is the time, where the change in temperature ($T_x - T_i$) is 0,6 times the observed temperature rise ($T_f - T_i$), in minutes;

g_i, g_f are, in principle, the drift rate at t_i respectively t_f as calculated for the Regnault-Pfaundler method, in Kelvin per minute.

Alternatively, temperature may be expressed in some arbitrary unit throughout (see 9.6.1).

8.6.3 Adiabatic calorimeters

In adiabatic systems, heat exchange is by definition negligible. It is, however, common practice to compensate for the stirring power by an offset in temperature in the adiabatic control system (see Annex A). The corrected temperature rise θ then becomes

$$\theta = T_f - T_i \quad (5)$$

Stirring power is otherwise manifested as a constant drift in temperature throughout the experiment and is easily corrected for, but can prolong the total period of temperature observations.

Detailed instructions for the numerical evaluation of the corrected temperature rise θ for adiabatic calorimeters are given in Annex A.

8.6.4 Thermometer corrections

If a mercury-in-glass thermometer is used, the corrections specified in the certificate issued with the thermometer shall be applied to the observed initial temperature T_i and the final temperature T_f .

8.7 Reference temperature

The temperature at the end of the main period, the final temperature T_f , is the reference temperature of the individual experiment.

9 Calibration

9.1 Principle

Combustion of certified benzoic acid under specified conditions to gaseous carbon dioxide and liquid water serves to make a change in temperature of the calorimeter of one unit interpretable in defined units of energy. The classical type of combustion calorimeter can be maintained unchanged over extended periods of time in terms of mass (heat capacity), geometry and heat exchange surfaces. This allows for calibration of the instrument to be carried out as a separate series of measurements, establishing the effective heat capacity ε of the calorimeter.

This calibration constant ε should not change significantly over time, provided minor repairs or other changes in the system are correctly accounted for. Some of the fully automated calorimetric instruments are, however, physically less well-defined and therefore require more frequent calibrations, for some systems even daily.

Systematic deviations can arise, for example from evaporation of calorimeter water, from uncontrolled heat exchange along various paths and/or imperfections and lag in an adiabatic temperature control system during the reaction period. Cancellation of this type of deviation depends largely on the similarity between the calibration experiments and combustion of the fuel samples with respect to time-temperature profile and total change in temperature of the calorimeter. Systematic variation in the mass of benzoic acid used in the calibration experiments is an expedient way of establishing the requirements for "similarity" for a particular calorimetric system (see 9.3).

9.2 Calibration reference

9.2.1 Certification conditions

The certificate value for the energy of combustion of benzoic acid refers to a process where the mass of sample and initial water, respectively, is 3 g/l of free bomb volume, the initial pressure of oxygen is 3,0 MPa

and the reference temperature is 25 °C. The products of combustion are defined as gaseous carbon dioxide, liquid water and an equilibrium amount of carbon dioxide dissolved in the aqueous phase. Any nitric acid formed is corrected for by the energy for the process, where the acid is decomposed to form liquid water and gaseous nitrogen and oxygen. If calibrations are performed under different conditions, the certificate value shall be adjusted. A numerical expression to correct for such deviations is given in the certificate.

9.2.2 Calibration conditions

The calibration conditions determine the overall calorimetric conditions for the subsequent fuel determinations. For bombs with an internal volume of about 300 ml, 1 g of calibration reference and 1 ml of water initially in the bomb are usually used (see 8.2.1). For bombs with a volume nearer to 200 ml, 0,6 g of benzoic acid are preferable; the amount of water should then be reduced accordingly (both in calibration and in determinations).

NOTE 1 The correction terms (per gram of benzoic acid) for deviations from certificate conditions, quoted from a typical benzoic acid certificate, are for the initial pressure, mass of sample, mass of water and reference temperature of the experiment, respectively 5 J/MPa; 1,1 J/g·l⁻¹; 0,8 J/g·l⁻¹ and – 1,2 J/K.

NOTE 2 As long as the initial pressure of oxygen and the reference temperature are kept within (3,0 ± 0,3) MPa and (25 ± 2) °C, respectively, the departure from certification conditions caused by pressure and/or temperature deviations is within ± 3 J/g and therefore is not to be accounted for.

NOTE 3 If larger amounts of water, e.g. 5 ml/g calibration reference is used, this is usually the most significant deviation from the certification conditions. For a 300 ml bomb, this causes an increase in the certified value of 11 J/g. If 1,0 g of benzoic acid and 5,0 ml of water are used in a 200 ml bomb, the certified value increases by 20 J/g. The change is mostly caused by an increase in the fraction of carbon dioxide dissolved in the bomb liquid. If no water is used, the certified value decreases by 2 J/g.

NOTE 4 If the total heat capacity of the calorimeter is small, for example in aneroid systems, the sample mass can be reduced in order to limit the total change in temperature (see Annex C).

9.3 Valid working range of the effective heat capacity ε

It ought to be possible to vary the amount of calibration reference by at least ± 25 % without getting a significant trend in the values obtained for the effective heat capacity. If this is not the case, the working limits for a constant value of ε shall be defined in terms of total temperature rise measured. All subsequent measurements of calorific value shall be kept within these temperature rise limits by adjusting the sample weight of solid recovered fuel to be measured.

A plot of ε values, as a function of mass of calibration reference used, reveals whether there is a significant trend in the effective heat capacity for a particular calorimeter. In this test, the calibration reference mass should be varied from 0,7 g to 1,3 g, or an equivalent relative amount, and a minimum of eight experiments should be performed. There is no need to vary the initial amount of water in the combustion bomb (6.2.1).

A convenient way of checking a system already calibrated by combustion of for example 1,0 g samples is to use the benzoic acid as an unknown. The mean values from triplicate runs on 0,7 g and 1,3 g sample masses, respectively, are compared with the certificate values. This usually suffices to ascertain whether the effective heat capacity is constant for the range of heat produced. Deviations are generally expected to be in the direction of "low" calorific values for larger sample masses, equivalent to obtaining ε value on the high side if derived from large samples. Using benzoic acid as a test substance is particularly useful in checking the performance of highly automated systems.

The required range for a verified (validated) value of ε depends on the total variation in calorific value of the fuels usually analysed. A moderate trend in ε , e.g. ± 0,3 % for a ± 30 % variation in the observed temperature rise, can be compensated for by expressing the effective heat capacity ε as a function of ($T_f - T_i$) over some defined range. Similarly, if a non-linearized temperature sensor is used, ε may be expressed as a (linear) function of ($T_f - T_i$), provided stringent criteria are also established for how much T_f or T_i is allowed to vary.

Deviation of ε from a constant value, as discussed here, is caused by the physical design of the calorimeter and/or shortcomings in the temperature control of the instrument. For a particular set-up, examination of the

applicable range of ε from a given set of calibration conditions should be carried out if the instrument is new or has been subjected to major repair or moved to a different location, and if changes in the temperature control system have occurred. Some adiabatic systems need to be checked on a more regular basis (see Annex A). Some automated calorimeters require calibration with a prescribed variation in sample mass (see Annex C).

9.4 Ancillary contributions

In addition to the energy from combustion of benzoic acid (5.5), there are contributions from the combustion of the fuse(s) and the formation of nitric acid (from "air" nitrogen in the gaseous phase). The contribution from a fuse is derived from the amount involved and the appropriate energy of combustion. Any fuse wire which has not reacted shall be taken into account, i.e. subtracted from the initial amount.

The amount of nitric acid formed is determined on the final bomb solution, for example by acid-base titration (see 8.5).

In most systems the contribution from the fuse(s) can be kept nearly the same in all experiments (fuel and calibration) and can consequently be assigned a constant value. For a given bomb configuration, the amount of nitric acid formed in calibration experiments is approximately proportional to the amount of benzoic acid (5.5) burned.

9.5 Calibration procedure

For the ordinary series of calibrations, five satisfactory combustions on benzoic acid shall be carried out. The sample shall be burned as pellets (see 5.5). The calorimetric procedure specified in Clause 8 shall be followed. Recommendations concerning sample mass and initial amount of bomb water are given in 9.2.2. It is advantageous to use a crucible (6.3) of low mass for the benzoic acid combustions. The initial temperature shall be chosen such that the reference temperature of the experiment (defined as T_f , see 8.7) is within the chosen range for the reference temperature.

The design of the calibration experiment, in terms of oxygen pressure, amount of bomb water, reference temperature, duration of the fore, main and after periods etc., defines the detailed procedure for subsequent fuel combustions.

If the effective heat capacity ε of a calorimeter cannot be regarded as constant over the required working range but needs to be expressed as a function of $(T_f - T_i)$ (see 9.3), the number of calibration experiments shall be increased to eight or more. The mass of sample for the individual experiments shall be chosen to yield values for the change in temperature over the entire intended working range, with a few replicate measurements around the end points, to define the slope of the ε versus $(T_f - T_i)$ relationship.

9.6 Calculation of effective heat capacity for the individual experiment

9.6.1 Constant mass-of-calorimeter-water basis

For systems where the quantity of water in the calorimeter vessel is kept the same in all experiments, ε is calculated as follows:

$$\varepsilon = \frac{m_{\text{ba}} \times q_{V,\text{ba}} + Q_{\text{fuse}} + Q_{\text{ign}} + Q_{\text{N}}}{\theta} \quad (6)$$

where

m_{ba} is the mass of benzoic acid (5.5), in grams;

$q_{V,\text{ba}}$ is the certified gross calorific value at constant volume, for the benzoic acid (5.5) (see 9.2.1), in Joules per gram;

Q_{fuse} is the contribution from combustion of the fuse, in Joules;

Q_{ign} is the contribution from oxidation of the ignition wire (5.2.1), in Joules;

Q_{N} is the contribution from formation of nitric acid (from liquid water and gaseous nitrogen and oxygen, see 8.5 and 9.2.1), in Joules;

θ is the corrected temperature rise, in Kelvin or in an arbitrary unit (see 3.6 and 8.6).

NOTE ε is usually expressed in Joules per Kelvin. If θ is expressed in arbitrary units, ε , is, of course, expressed in Joules per this arbitrary unit, e.g. Joules per Ohm.

The contribution from combustion of the cotton fuse (5.2.2) is 17 500 J/g and from a nickel-chromium wire 6 000 J/g. Platinum wire melts and resolidifies and gives no net contribution.

If the sum $Q_{\text{fuse}} + Q_{\text{ign}}$ is nearly the same, within a few Joules, in all experiments, it may be assigned a constant value. It is not generally recommended to incorporate $Q_{\text{fuse}} + Q_{\text{ign}}$ in the value of ε , unless it is in itself small and the variation in θ is less than $\pm 20\%$.

For the formation of nitric acid from liquid water and gaseous nitrogen and oxygen, the contribution is 60 J/mmol.

Q_{N} in Joules is calculated from the found mass fraction of nitrate, $w(\text{NO}_3)$, expressed in milligrams, determined by ion-chromatography using the following equation:

$$Q_{\text{N}} = 0,97 \times w(\text{NO}_3) \quad (7)$$

or

from the titration result of $[c(\text{NaOH}) = 0,1 \text{ mol/l}]$, in millilitres, using the following equation:

$$Q_{\text{N}} = 6,0 \times \text{ml (see 8.5)}. \quad (8)$$

9.6.2 Constant total-calorimeter-mass basis

If the system is operated such that the calorimeter can (6.2.2) with the assembled combustion bomb (6.2.1) and the water always has the same total mass, the amount of water in the can will vary slightly, depending mainly upon the mass of the crucible (6.3) used. It is then convenient to define ε_0 as the effective heat capacity for the hypothetical calorimeter with no crucible in the bomb, as given by the following equation:

$$\varepsilon_0 = \varepsilon_{\bullet} + m_{\text{cr}} \times c_{p,\text{aq}} \quad (9)$$

where

ε_{\bullet} is equal to ε as defined in 9.6.1;

m_{cr} is the mass of the crucible used in the calibration experiment (see NOTE in this subclause), in grams;

$c_{p,\text{aq}}$ is the specific heat capacity of water, in Joules per gram per Kelvin (if the ε values are in Joules per Kelvin; it is equal to 4,18 J/(g · K) at 25 °C).

If arbitrary "units of temperature" are used, the value of $c_{p,\text{aq}}$ shall be adjusted accordingly. The relation between the Kelvin and the unit utilized need only be known to within $\pm 10\%$ for this purpose.

NOTE In Equation (9) the second term is derived from:

$$m_{\text{cr}} \times (c_{p,\text{aq}} - c_{p,\text{cr}}) + m_{\text{sample}} \times (c_{p,\text{aq}} - c_{p,\text{sample}})$$

where

$c_{p,cr}$ is the specific heat capacity of the crucible, in Joules per gram per Kelvin;

$c_{p,sample}$ is the specific heat capacity of the sample, in Joules per gram per Kelvin;

m_{sample} is the mass of the sample, in grams.

The second part of the expression in the NOTE may be incorporated in ε_0 without loss in accuracy, as its value will not vary significantly between calibration and fuel experiments. The expression is then reduced to:

$$m_{cr} \times (c_{p,aq} - c_{p,cr})$$

which in most cases may be simplified to $m_{cr} \times c_{p,aq}$ as given in Equation (9). However, if a wide variety of crucibles are used, the heat capacity of the crucible may have to be accounted for. For instance, if a 10 g platinum crucible is used for the calibration experiments and a 10 g quartz crucible is used for the fuel combustions, a deviation of 6 J/K is introduced if $c_{p,cr}$ is not taken into account, corresponding to 18 J for a 3 K temperature rise. The correct equation is then:

$$\varepsilon_0 = \varepsilon_0 + m_{cr} \times (c_{p,aq} - c_{p,cr}) \quad (10)$$

The specific heat capacities for platinum, quartz and steel are 0,133 J/(g · K), 0,74 J/(g · K) and 0,45 J/(g · K), respectively.

9.7 Precision of the mean value of the effective heat capacity ε

9.7.1 Constant value of ε

Calculate the arithmetic mean $\varepsilon_{(n)}$ and the standard deviation from the results of the individual calibration experiments, ε (see 9.6.1) or ε_0 (see 9.6.2), respectively. The standard deviation shall not exceed 0,20 %. All results from the current series of calibrations shall be included in the calculations; only experiments with evidence of incomplete combustion shall be discarded.

Provided the precision requirement is met, the arithmetic mean $\varepsilon_{(n)}$ or $\varepsilon_{0(n)}$, respectively, is regarded as the value for the effective heat capacity of the calorimeter.

If the precision requirement is not met, the cause for the unsatisfactory results shall be identified and corrected, and a new series of calibration experiments shall be performed.

9.7.2 ε as a function of the observed temperature rise

If ε cannot be regarded as constant, list the individual values of ε (see 9.6.1) or ε_0 (see 9.6.2), respectively, together with the corresponding values for the observed temperature rise ($T_f - T_i$), for clarity denoted ΔT . Fit the results to a straight line by linear regression with ΔT as the independent variable. In addition to calculating the coefficients

a and b for:

$$\hat{\varepsilon} = a + b \times \Delta T \quad (11)$$

the estimate of the variance s^2 about the line shall be calculated. For convenience, θ may be used instead of ΔT .

The standard deviation s shall not exceed 0,20 %. Only results from experiments with evidence of incomplete combustion may, and shall, be discarded in the calculations.

Provided the precision requirement is met, $\hat{\varepsilon}$ as defined above is regarded as the value for the effective heat capacity of the calorimeter to be used in the calculations of the calorific values for the fuels. The valid working range in terms of the observed temperature rise shall be clearly specified.

If the precision requirement is not met, the cause for the unsatisfactory results shall be identified and corrected, and a new series of calibration experiments shall be performed.

9.8 Repetition of the determination of effective heat capacity

If any significant part of the system is changed, the determination of the mean effective heat capacity shall be repeated (see 9.3). The repeating determination shall be carried out in intervals not longer than six months.

NOTE It is recommended, especially on a new system, to check the calibration regularly by performing a few monthly experiments using benzoic acid as a test substance (see 9.3).

Where a change to the system is not involved, the new mean value of s shall be within 0,15 % of the previous value. If the difference is greater than 0,15 %, experimental procedures shall be examined and the cause of the problem identified and dealt with.

10 Gross calorific value

10.1 General

The calorimetric conditions for the solid recovered fuel combustions shall be consistent with those of the calibration experiments (see 8.2.1, 9.2.2 and 9.5). With the calorimetric procedure under satisfactory control, ascertaining complete combustion of the solid recovered fuels is the most important issue.

Some solid recovered fuels might be difficult to burn completely in the bomb and may have to be burned with a combustion aid or by using a combustion bag or capsule, with well-established energy of combustion, or by omitting the distilled water from the bomb (see Clause 7 and 8.2) or by reducing the oxygen pressure.

The bomb washings for sulphuric and nitric acid shall be analysed using procedures specified in 8.5 or a constant value for nitric acid (see below) together with a typical or default value for sulphur shall be used for corrections (10.3.2, E.4).

Nitric acid formation is largely dependent on the combustion temperature and enhanced by the nitrogen content of the sample. The nitric acid correction is usually different for fuel and benzoic acid combustions, respectively, and may also vary significantly for different types of solid recovered fuels.

The variation in the correction for nitric acid might be with solid recovered fuels having low nitrogen content on the borderline of significance. If the sulphur content is determined separately on the sample, the nitric acid correction may be assigned a constant per-gram-of-sample value. A similar strategy shall then be adopted for the calibration experiments.

10.2 Combustion

Duplicate combustions shall be made. A representative sample shall be taken from the analysis sample (see Clause 7) and a pellet shall be pressed or capsule shall be used. The mass of the sample burned (or the sample together with combustion aid or capsule) shall be such that the observed temperature rise is within the range of the calibration experiments. The calorimetric procedure specified in 8.2.1 to 8.6 shall be followed, with the same calorimetric conditions as in the calibration experiments (see 9.2.2).

Usually a mass of about 1 g of solid recovered fuel sample is adequate. If the observed temperature rise falls outside the valid range for ε , the sample size of the solid recovered fuels shall be adjusted to meet the valid temperature rise range or the calibration shall be confirmed for the extended range of ε (see 9.3).

10.3 Calculation of gross calorific value

10.3.1 General

The energy change for the total bomb process is given by the effective heat capacity ε multiplied by the corrected temperature rise θ . To derive the energy of combustion of the solid recovered fuel sample, the energy contributions from all the ancillary reactions shall be subtracted from $\varepsilon \times \theta$ (see 9.4). If a combustion aid is used, its contribution is usually the largest ancillary quantity and shall be accurately accounted for.

Moreover, sulphur in the sample quantitatively yields sulphuric acid in the combustion bomb (6.2.1), whereas the required state of sulphur for the calorific value of the fuel is gaseous sulphur dioxide (see 4.1). This is accounted for by a term representing the decomposition, at constant volume, of the aqueous sulphuric acid into gaseous sulphur dioxide and oxygen, and liquid water.

The derived calorific value for the solid recovered fuel is the gross calorific value at constant volume.

10.3.2 Constant mass-of-calorimeter-water basis

Calculate the gross calorific value at constant volume from the individual experiment by substituting into the following equation:

$$q_{V,gr} = \frac{\varepsilon_{(n)} \times \theta - Q_{\text{fuse}} - Q_{\text{ign}} - Q_{\text{N}} - m_2 \times q_{V,2}}{m_1} - \frac{Q_{\text{S}}}{m_1} \quad (12)$$

where

$q_{V,gr}$ is the gross calorific value at constant volume of the fuel as analysed, in Joules per gram;

$\varepsilon_{(n)}$ is the mean value of the effective heat capacity of the calorimeter as determined in the calibrations (see 9.6.1), in Joules per Kelvin, or, alternatively, in Joules per some arbitrary unit (see NOTE in 9.6.1);

Q_{S} is the correction for taking the sulphur from the aqueous sulphuric acid to gaseous sulphur dioxide, in Joules;

m_1 is the mass of the sample of the fuel, in grams;

m_2 is the mass of the combustion aid (if relevant), in grams;

$q_{V,2}$ is the gross calorific value at constant volume of the combustion aid (if relevant), in Joules per gram;

θ , Q_{fuse} , Q_{ign} and Q_{N} see 9.6.1.

If no buoyancy correction is applied to m_2 , care shall be taken to ensure that $q_{V,2}$ is valid for "per gram weighed in air".

The energy quantities required to calculate the contributions from cotton fuse (5.2.2), ignition wire (5.2.1) and formation of nitric acid are given in 9.6.1. Specific heat capacities for water and some common crucible materials are given in 9.6.2.

To account for the reaction where sulphuric acid decomposes into liquid water and gaseous sulphur dioxide and oxygen, the correction is 302 J/mmol, equivalent to 9,41 J/mg of sulphur, which in turn corresponds to a Q_{S}/m_1 value of 94,1 J/g of sample for 1 % of sulphur in the analysis sample.

$$Q_S = 94,1 \times w(S) \times m_1 \quad (13)$$

where

$w(S)$ is the mass fraction of sulphur in the sample (as analysed), in percent.

If the analytical procedures specified in 8.5 are used, the contributions from sulphuric and nitric acids are given by

a) Determination by ion-chromatography:

$$Q_S = 3,14 \times w(\text{SO}_4) \quad (14)$$

$$Q_N = 0,97 \times w(\text{NO}_3) \quad (15)$$

where

$w(\text{SO}_4)$ is the mass fraction of sulphate and $w(\text{NO}_3)$ the mass fraction of nitrate found, respectively, in milligrams.

b) Titration with barium hydroxide and hydrochloric acid:

$$Q_S = 15,1 (V_1 + V_2 - 20,0) \text{ and,} \quad (16)$$

$$Q_N = 6,0 (20,0 - V_2), \text{ respectively,} \quad (17)$$

where

V_1 is the volume fraction used of the barium hydroxide solution (5.4.1), in millilitres;

V_2 is the volume fraction used of the hydrochloric acid solution (5.4.4), in millilitres.

c) Titration with sodium hydroxide:

The corrections for nitric acid and sulphuric acid are calculated using a combined correction $Q_{N,S}$ instead of Q_N together with an additional correction for sulphur (Q_S) in the equation of $q_{V,gr}$ (one part of Q_S , namely 2×60 J/mmol is included in $Q_{N,S}$; the additional correction needed is $302 - 2 \times 60 = 182$ J/mmol which is equal to 5,7 J/mg sulphur in the sample).

$$Q_{N,S} = 6,0 \times V \quad (18)$$

$$Q_S = 57 \times w(S) \times m_1 \quad (19)$$

where

V is the volume fraction used of sodium hydroxide solution (5.4.3), in millilitres.

$w(S)$ is the mass fraction of sulphur of the sample as analysed, in percent.

The certification-condition value may be used for benzoic acid utilized as a combustion aid, provided 1 ml of water is used initially in the bomb. For larger amounts of water, it is recommended to adjust the per-gram value in accordance with the amount-of-water term in the certificate.

The mean value of duplicate determinations is regarded as the gross calorific value for the analysis sample of the solid recovered fuel.

10.3.3 Constant total-calorimeter-mass basis

Calculate the gross calorific value at constant volume from the individual experiment by substituting into the following equation:

$$q_{V,gr} = \frac{\varepsilon_{\bullet} \times \theta - Q_{\text{fuse}} - Q_{\text{ign}} - Q_{\text{N}} - m_2 \times q_{V,2} - \frac{Q_{\text{S}}}{m_1}}{m_1} \quad (20)$$

where

ε_{\bullet} is derived from $\varepsilon_{\bullet} = \varepsilon_{0(n)} - m_{\text{cr}} \times c_{p,\text{aq}}$;

m_{cr} is the mass of the crucible in the individual experiment, in grams.

In this case, the mean value of the effective heat capacity $\varepsilon_{0(n)}$ is the one derived from the individual ε_0 results (see 9.6.2) and represents the calorimeter without a crucible. The value of ε valid for the actual fuel experiment is:

$$\varepsilon_{\bullet} = \varepsilon_{0(n)} - m_{\text{cr}} \times c_{p,\text{aq}} \quad (21)$$

where

m_{cr} is the mass of the crucible used in the fuel combustion, in grams;

$\varepsilon_{0(n)}$, $c_{p,\text{aq}}$ see 9.6.2.

If the heat capacity of the crucible has been taken into account (see NOTE in 9.6.2) in computing the ε_0 values, $(c_{p,\text{aq}} - c_{p,\text{cr}})$ shall be substituted for $c_{p,\text{aq}}$ in the calculations of ε_{\bullet} .

ε_{\bullet} replaces $\varepsilon_{(n)}$ in Equation (12) in 10.3.2 for the calculation of the gross calorific value at constant volume for the solid recovered fuels sample from an individual experiment. The mean value of duplicate determinations is regarded as the resulting value for the analysis sample of the solid recovered fuels.

10.3.4 ε as a function of the observed temperature rise

If it is required that the effective heat capacity of the calorimeter is expressed as a function of the observed temperature rise (see 9.3 and 9.7.2), $\varepsilon_{(n)}$ in Equation (12) and $\varepsilon_{0(n)}$ in Equation (21), respectively, shall be replaced by:

$$\hat{\varepsilon} = a + b \times \Delta T \quad (22)$$

where the coefficients a and b are derived from the calibrations (see 9.7.2). ΔT is the notation for the observed temperature rise $(T_f - T_i)$, in Kelvin or the arbitrary unit used, for the actual fuel experiment. For convenience, θ may be used instead of ΔT (see 9.7.2).

The mean value of duplicate determinations is regarded as the resulting value for the analysis sample of the solid recovered fuel.

10.4 Expression of results

As the moisture content of the actual analysis sample is of interest merely in connection with the calculation to other bases, it is recommended to calculate a value for the gross calorific value at constant volume for the dry fuel (dry basis, in dry matter), using the following equation:

$$q_{V,gr,d} = q_{V,gr} \times \frac{100}{100 - M_{ad}} \quad (23)$$

where

$q_{V,gr,d}$ is the gross calorific value at constant volume of the dry (moisture-free) fuel, in Joules per gram;

M_{ad} is the mass fraction of moisture in the analysis sample, in percent;

$q_{V,gr}$ see 10.3.2.

The calorific value at constant volume required for any particular moisture content basis $q_{V,gr,m}$ is derived by the following equation:

$$q_{V,gr,m} = q_{V,gr,d} \times (1 - 0,01M) \quad (24)$$

where M is the mass fraction of moisture, expressed in percent, for which the calorific value is required, usually for the fuel as sampled or as fired (total moisture content as received, M_{ar}), and

$$(1 - 0,01M_{ar}) = \frac{100 - M_{ar}}{100} \quad (25)$$

The result shall be reported to the nearest multiple of 10 J/g with unambiguous statements concerning the states constant volume, gross (liquid water), and moisture basis (dry, and also "as sampled" if it is reasonable).

10.5 Calculation to other bases

For the calculation of results to other bases follow EN 15358 and EN 15296.

11 Precision

11.1 Repeatability limit

The maximum difference to be expected between two independent single test results of one laboratory at a confidence level of 95 % will not exceed the repeatability limit in more than 5 % of cases when measuring the same measurand in the same medium, using the same facilities and fulfilling all requirements of the test method (interlaboratory testing).

Precision data derived from the interlaboratory test are given in Annex I.

11.2 Reproducibility limit

The maximum difference to be expected between two independent single test results of different laboratories at a confidence level of 95 % will not exceed the reproducibility limit in more than 5 % of cases when measuring the same measurand in the same medium, each laboratory using their own facilities and fulfilling all requirements of the test method (interlaboratory testing).

Precision data derived from the interlaboratory test are given in Annex I.

12 Calculation of net calorific value at constant pressure

12.1 General

The main difference between the gross and net calorific values is related to the physical state of water in the reaction products (compare definitions 3.1 to 3.3). The calorific value of the fuel most commonly used for practical purposes is the net calorific value at constant pressure for the fuel with some specified moisture content. This value may be derived from the gross calorific value at constant volume for the dry sample, provided that the total hydrogen content of the moisture-free sample can be determined by experiment or, for the particular solid recovered fuel, reliably estimated. In addition, the oxygen and nitrogen contents of the moisture-free sample shall be "added" to the gaseous phase of the product system and should, in principle, be taken into account. For this purpose the nitrogen may be included in the term for oxygen.

NOTE The net calorific value at constant volume (3.2) for the solid recovered fuels at some specified moisture level is easily calculated, once a measure of the hydrogen content is available. In this case, the oxygen and nitrogen content is of no consequence.

12.2 Calculations

The net calorific value at constant pressure (3.3) at required moisture levels is calculated by the following equations. For calculations to other bases follow EN 15296.

Net calorific value at constant pressure for a dry sample (dry basis, in dry matter) is calculated by:

$$q_{p,\text{net,d}} = q_{V,\text{gr,d}} + 6,15 \times w(\text{H})_{\text{d}} - 0,8 \times [w(\text{O})_{\text{d}} + w(\text{N})_{\text{d}}] - 218,3 \times w(\text{H})_{\text{d}} \quad (26)$$

$$= q_{V,\text{gr,d}} - 212,2 \times w(\text{H})_{\text{d}} - 0,8 \times [w(\text{O})_{\text{d}} + w(\text{N})_{\text{d}}] \quad (27)$$

The expression $0,8 \times [w(\text{O})_{\text{d}} + w(\text{N})_{\text{d}}]$ in Equation (27) may be neglected by equating to zero if the sum of mass fractions of oxygen and nitrogen in the solid recovered fuel concerned is less than 10 %.

Net calorific value at constant pressure at a required moisture content M (e.g. as received, M_{ar} , whereupon the symbol of calorific value is $q_{p,\text{net,ar}}$) is calculated by:

$$q_{p,\text{net,m}} = \{q_{V,\text{gr,d}} - 212w(\text{H})_{\text{d}} - 0,8[w(\text{O})_{\text{d}} + w(\text{N})_{\text{d}}]\} \times (1 - 0,01M) - 24,43M \quad (28)$$

$$= q_{p,\text{net,d}} \times (1 - 0,01M) - 24,43 \times M \quad (29)$$

where

$q_{p,\text{net,m}}$ is the net calorific value at constant pressure, of the solid recovered fuel with moisture content M ; (usually as received M_{ar}), in Joules per gram;

$q_{V,\text{gr,d}}$ is the gross calorific value at constant volume, of the moisture-free fuel (see 10.4), in Joules per gram;

$w(\text{H})_{\text{d}}$ is the mass fraction of hydrogen of the moisture-free (dry) solid recovered fuel (including the hydrogen from the water of hydration of the mineral matter as well as the hydrogen in the solid recovered fuels substance), in percent;

$w(\text{O})_{\text{d}}$ is the mass fraction of oxygen of the moisture-free solid recovered fuel, in percent;

$w(\text{N})_{\text{d}}$ is the mass fraction of nitrogen of the moisture-free solid recovered fuel, in percent;

M is the mass fraction of moisture for which the calculation is required, in percent (on the dry basis, $M = 0$; on the air-dried basis, $M = M_{\text{ad}}$ (see 10.4); on the as-sampled or as-fired (as received, ar) basis, $M = M_{\text{ar}}$ (total moisture content as received).

The enthalpy of vaporization (constant pressure) for water at 25 °C is 44,01 kJ/mol. This corresponds to 218,3 J/g for a mass fraction of hydrogen of 1 % in the solid recovered fuel sample or 24,43 J/g for a mass fraction of moisture of 1 %.

NOTE 1 $[w(\text{O})_d + w(\text{N})_d]$ can be derived by subtracting from 100 the percentages of ash, carbon, hydrogen and sulphur.

NOTE 2 The net calorific value at constant volume is calculated from the following equation:

$$V_{\text{net,m}} = [q_{V,\text{gr,d}} - 206w(\text{H})_d] \times (1 - 0,01M) - 23,0M \quad (29)$$

where

$q_{V,\text{net,m}}$ is the net calorific value at constant volume, of the fuel with a moisture content of M , in Joules per gram;

other symbols see above.

13 Test report

The test report shall include the following information:

- a) an identification of the laboratory performing the test and the date when the test was undertaken;
- b) an identification of the solid recovered fuel and the sample tested;
- c) a reference to this European Standard, i.e. EN 15400;
- d) test results with reference to the state(s) valid for the calorific value(s):
 - gross calorific value (at constant volume) of dry solid recovered fuel (dry basis, in dry matter) ($q_{V,\text{gr,d}}$);
 - net calorific value (at constant pressure) of dry solid recovered fuel (dry basis, in dry matter) ($q_{p,\text{net,d}}$);
 - net calorific value of the moist solid recovered fuel (as sampled or as received, $_{\text{ar}}$) ($q_{p,\text{net,ar}}$);
- e) values of hydrogen, oxygen, nitrogen, sulphur, chlorine used to calculate gross calorific value and net calorific value (the reference shall be mentioned);
- f) any unusual features noted during the determination.

Annex A (normative)

Adiabatic bomb calorimeters

A.1 Principle

In a truly adiabatic calorimeter there is no heat exchange between the calorimeter and its surrounding thermostat (water jacket) (6.2.4). Heat exchange takes place via common boundaries, the driving force being a net difference in temperature. Ideally, therefore, the whole of the outside surface of the calorimeter can, including the lid, should have a uniform temperature which at all times during an experiment is to be matched by the, also uniform, temperature of the inner wall of the thermostat and lid that are facing the calorimeter. Without any difference in temperature, i.e. with zero thermal head, there is no net flow of heat between calorimeter and thermostat. However, there will still be a slow rise in calorimeter temperature caused mainly by the stirring power, with additional positive or negative contributions, from thermometer probe self-heating and from conduction of heat along the stirrer shaft, ignition leads, thermometers etc. For convenience, "adiabatic" calorimeters are often operated with a small negative thermal head to balance, i.e. to offset, this upward drift in temperature.

A.2 Sources of deviation for the real calorimeter

Truly adiabatic conditions are difficult to achieve in practice, in particular during the rapid part of the rise in calorimeter temperature upon ignition of the sample. The design of the thermostat (6.2.4) and the way it is operated determines how effectively it responds to the change in calorimeter temperature and hence also the extent of uncontrolled heat exchange.

If the calorimeter itself has no lid, its upper heat exchange properties are largely determined by the surface of the calorimeter water together with the surface of, for example, bomb parts extending above the water. With such an "open" calorimeter there is always some uncontrolled evaporation of calorimeter water during the main period, accompanied by a corresponding "heat loss". The magnitude of this deviation is mainly a function of how much the thermostat lid lags behind in temperature during the main period.

Unless special precautions have been taken in its design and mounting, a calorimeter lid is usually in poor thermal contact with the calorimeter itself. It then lags behind in temperature and can, for instance, be responsible for uncontrolled heat leakage from the thermostat. It can also prolong the time required for the calorimeter to reach thermal equilibrium or steady-state. On the other hand, a lid prevents a net heat loss from evaporation of calorimeter water since this will condense on the inside of the lid, restoring the evaporation energy to the calorimeter. In fact, the condensing water assists the thermal equilibrium of the lid with the rest of the calorimeter.

To minimise heat exchange caused by temporary temperature differences that cannot be prevented entirely, it is important to keep the outside surface of the calorimeter, and the "inside" of the thermostat, clean (polished) and dry. Generally, deviations and insufficiencies that differ or vary between calibration and fuel experiments are the ones that in the end affect the accuracy of the final results.

A.3 Adiabatic conditions

A.3.1 Thermostat

If the thermostat is heated by passing an electrical current directly through the thermostat water, care shall be taken to keep the salt concentration (usually Na_2CO_3) at the specified level in order to maintain the heating power about the same in all experiments. A diminishing salt concentration can significantly hamper the heating rate, eventually leading to difficulties in achieving adiabatic conditions during the combustion of the sample.

Inadequate adiabatic control during the first half of the main period is easily overlooked. Irrespective of the mode of heating the thermostat, checks should be made at regular intervals (weekly) to ascertain, for example, that the time it takes for the thermostat to catch up with the rapidly rising calorimeter temperature during combustion does not gradually increase.

A.3.2 Adiabatic control

The controls for achieving adiabatic conditions shall be adjusted as prescribed in the instrument manual. In particular, select the setting of the bridge circuit that results in zero or minimum drift in calorimeter temperature at the final temperature of the experiments (see A.5).

NOTE Non-linear sensors are often used in the temperature control circuits. Unless the two sensors are perfectly matched, it is not possible to obtain zero drift in temperature over the whole of the selected working range. Neither is it then possible to achieve zero thermal head over the whole range with one bridge setting. Imperfectly matched sensors also put restrictions on the acceptable variation in the final temperature of the experiments.

In a well-behaved calorimeter, the adiabatic control settings usually need little or no short-term adjustment. This shall, however, be verified by regularly checking the drift rate at the final temperature, for example by following the temperature over a 5 min to 10 min period in excess of the normal duration of the experiment. A drift rate of 0,001 K/min or more at the final temperature shall be eliminated by adjustment of the control settings, or corrected for (see 6.2.4 and A.5).

A.4 Initial steady state and length of the main period

The equilibrium period serves to let the various components of the assembled calorimeter reach a uniform temperature. Simultaneously, the adiabatic controls work to bring the thermostat to its working temperature, close to that of the calorimeter. Let a few minutes pass after the controls have indicated that the temperature of the thermostat and of the calorimeter are about the same before taking readings of the calorimeter temperature at 1 min intervals.

If three consecutive readings yield the same value, within 0,001 K or better, or if they all change by the same (limited) amount (constant drift rate) the charge may be fired.

NOTE The expected duration of the combined equilibrium and fore period for most adiabatic systems is of the order of 8 min to 10 min. However, subjecting any part of the calorimeter to substantially deviating temperatures in between experiments can significantly prolong the time for thermal equilibrium of the calorimeter.

Depending on the type of sample, the combustion in the bomb takes from about 10 s to 25 s. The time required for the total amount of heat released to become uniformly distributed, i.e. for all parts of the calorimeter to attain a uniform temperature, is primarily a function of stirring pattern and stirrer efficiency. The main period shall cover this temperature equilibrium period but there is no merit in making it longer than necessary.

The length of the main period is determined in a series of calibration experiments where readings of temperature are taken at 1 min intervals from the time of firing the charge in each experiment. From these observations, note the time, in minutes, from the time of firing until the second of three consecutive readings

that do not differ by more than 0,001 K is reached. The largest of these specific times from five calibration experiments defines the length of the main period. It shall not exceed 10 min, nor shall the time periods evaluated from the individual experiments differ by more than 2 min.

If usual operation involves a slight drift of the final temperature of the experiment, the requirement of “constant temperature” changes to one of constant drift rate to within 0,001 K/min for three consecutive 1 min intervals.

A.5 Correction for drift at the final temperature

If the adiabatic controls are set to give zero drift at the final temperature, the corrected temperature rise is $\theta = T_f - T_i$ (see 8.6.3) where T_i is the calorimeter temperature at the time of firing the charge and T_f is the temperature at the end of the main period.

A limited drift in temperature prior to ignition of the sample need not be accounted for in the calculations. Significant drift at the end of and beyond the main period shall, however, be taken into account. It may be regarded as a constant contribution throughout most of the main period. A reasonable approach is to make a correction commencing 1 min after ignition of the sample. The drift rate should, in principle, be determined for the individual run. But insofar as the final drift rate has been established as constant over extended periods of time for a defined range of final temperature, the correction may be based on such a fixed rate.

NOTE 1 A drift rate of 0,001 K/min unaccounted for would, with a main period of about 10 min, result in a deviation of approximately 0,01 K. For ε values of about 10 kJ/K, the resulting deviation in the calorific value of the fuel would be in the order of 100 J/g. If exactly the same deviation from the same source is made in the calibrations and in all fuel experiments, it will of course be of no consequence for the final result, at least as long as the variation in θ stays within about $\pm 30\%$.

The final drift rate g_f in K/min, shall be determined over a time period that is at least half of what the correction is supposed to cover. For a main period of 9 min, this gives a rating period of 4 min.

NOTE 2 If the total temperature change of the calorimeter is expressed in units other than temperature (see 9.6.1), g_f is the corresponding per minute value of that unit.

The corrected temperature rise θ , corrected for drift at the final temperature, is calculated by the equation:

$$\theta = T_f - T_i - g_f \times (\Delta t - 1) \quad (\text{A.1})$$

where

Δt is the length of the main period, in minutes;

g_f is calculated from the equation

$$g_f = \frac{T_{f+a} - T_f}{a} \quad (\text{A.2})$$

where T_{f+a} is the temperature a minutes after the end of the main period.

Another way of evaluating g_f is as the slope of a linear regression fitting of time-temperature readings at 1 min intervals from the end of the main period onwards.

A.6 Strategy for checking on bias

For adiabatic combustion calorimeters, the main source for systematic deviation in the measurement is related to difficulties in maintaining adiabatic conditions during the rapid part of the temperature change in the calorimeter. This is manifested as an upward trend in the values obtained for the effective heat capacity with increasing sample mass. Fast-burning samples, such as paraffin oil, usually aggravate this problem and this type of heat-leak deviation cannot be cancelled between calibration and fuel experiments.

In most calorimeters, a check on temperature lag in the thermostat as a function of sample mass and type is readily made. The change in thermostat temperature upon ignition of the sample is measured for about 3 min and plotted as a function of time together with time-temperature values for the calorimeter. For adiabatic calorimeters, readings of calorimeter temperature are, in fact, not required during the first part of the main period for other than diagnostic purposes. For the check on thermostat lag, they are required at a frequency sufficient to outline the features of the time-temperature curve.

No particular calibration of the thermostat thermometer is required, but it shall have a response time comparable to that of the calorimeter thermometer. On the graph, the two temperature "scales" are simply made to coincide at the time for ignition of the sample. The two temperatures should of course be close at the upper end where the system is approaching thermal equilibrium. The area between the two curves is a measure of potential heat leak, and a significant increase of this area as a function of sample mass, i.e. of θ , or sample type for comparable values of θ , indicates that there is a risk of systematic deviation in the determinations of calorific value. Special care is then required to restrict the variation in heat evolved per experiment to a safe level and range.

Annex B (normative)

Isoperibol and static-jacket bomb calorimeters

B.1 Principle

The characteristic feature of isoperibol calorimeters is the isothermal jacket. The temperature of the surrounding thermostat is kept constant throughout the experiment by active control. The thermostat of a static-jacket calorimeter has a thermal capacity such that, even without active control, its temperature remains nearly constant during measurements. In both cases there is a flow of heat between the calorimeter itself and the thermostat. Calorimeters surrounded by thermally insulating material behave largely as static-jacket calorimeters.

Heat exchange between calorimeter and thermostat takes place via common boundaries, the driving force being the thermal head. Ideally, the whole of the outside surface of the calorimeter can, including the lid, should have a uniform temperature equal to that measured by the temperature sensor in the calorimeter. The temperature of the inner wall of the thermostat well and lid facing the calorimeter should remain constant and uniform throughout the experiment.

To make it possible to evaluate and correct for the actual heat exchange, the calorimeter as a whole shall behave in conformity with Newton's law of cooling, i.e. the heat flow between calorimeter and thermostat shall be directly proportional to the actual temperature difference for a sufficiently large range of thermal head. For the calorimeter this is expressed as:

$$\frac{dq}{dt} = k(T_j - T) \quad (\text{B.1})$$

where

$\frac{dq}{dt}$ is the heat flow into the calorimeter;

T_j is the jacket temperature;

T is the calorimeter temperature;

$(T_j - T)$ is the thermal head;

k is the Newton's law cooling constant.

In the above equation dq (heat change) may be replaced by $c_p dT$ (heat capacity \times temperature change). As the heat capacity of the calorimeter ε can be regarded as constant over the temperature range of an experiment, the equation then becomes:

$$\frac{dq}{dt} = G(T_j - T) + P_{st} \quad (\text{B.2})$$

where

$\frac{dq}{dt}$ is the rate of temperature change (drift) in the calorimeter caused by the flow of heat;

G is a constant generally referred to as the specific rate constant;

P_{st} is the power of stirring.

The requirement that the power of stirring shall be constant throughout an experiment (see 8.1) allows dq/dt to be expressed as:

$$dq/dt = G(T_{\infty} - T) \quad (\text{B.3})$$

where

T_{∞} is the temperature that the calorimeter would eventually attain if left running for an extended period of time;

G and T_{∞} are evaluated from the time-temperature measurements of the rating periods, the fore and the after period, respectively (see Figure 2 in 8.1).

The contribution from heat exchange to the total observed temperature rise in the main period is obtained by integration using the time-temperature readings (T, t) of the main period:

$$\Delta T_{\text{ex}} = \int_{t_i}^{t_f} (dT / dt) dt = \int_{t_i}^{t_f} G(T_{\infty} - T) dt \quad (\text{B.4})$$

B.2 Sources of deviation for the real calorimeter

Making the isothermal jacket of an isoperibol calorimeter behave as required in terms of constant and uniform temperature presents no real problem, provided that the thermostat fluid is circulated through the thermostat lid at a reasonable rate.

In a static-jacket calorimeter, the thermostat temperature will change slightly during an experiment, with a somewhat different profile if the calorimeter temperature rises upon firing the charge. The thermal capacity of the thermostat shall be such that for a specific rate (cooling) constant G of $0,002 \text{ 0 min}^{-1}$, the rise in temperature of the jacket water is less than $0,16 \text{ K}$ from the time of firing the charge to the end of the after period; for a specific rate constant of $0,003 \text{ 0 min}^{-1}$, it shall be less than $0,11 \text{ K}$. The drift in temperature of the thermostat is proportional to the thermal head.

A calorimeter lid in poor thermal contact with the main part of the calorimeter lags behind if the temperature changes rapidly in the main period, and can give rise to an unpredictable heat exchange with the thermostat. It can also prolong the time required for the calorimeter to reach thermal equilibrium or steady state. On the other hand, a lid prevents a net heat loss from evaporation of calorimeter water since this will condense on the inside of the lid, restoring the evaporation energy to the calorimeter. In fact, the condensing water assists the thermal equilibrium of the lid with the rest of the calorimeter. The choice of thermostat temperature affects the evaporation losses if the calorimeter has no lid.

Variations in heat exchange properties are minimised by keeping the outside surface of the calorimeter and the "inside" of the thermostat clean (polished) and dry. The specific rate constant G then should not vary by more than $\pm 3 \%$ from one experiment to the other. Larger deviations can, for example, be indicative of stirrer malfunction. It should be emphasized that the deviations which really affect the accuracy of the final results are those that differ or vary between calibration and fuel experiments.

B.3 Choice of jacket temperature

It is good calorimetric practice to run the thermostat of an isoperibol calorimeter at a temperature that is $0,2 \text{ K}$ to $0,4 \text{ K}$ higher than the final temperature of the calorimeter. In this way the calorimeter will be the colder part throughout the experiment, hence minimising evaporation losses. This is particularly important if the calorimeter has no lid.

The same argument applies to static-jacket calorimeters.

B.4 Rating periods

B.4.1 Initial steady state and fore period

A few minutes should be allowed to let the various components of the assembled calorimeter reach a uniform temperature after turning the stirrer on, before readings of temperature are taken at 1 min intervals. The initial rating period, the fore period, in principle begins as soon as the calorimeter reaches a steady state in terms of temperature drift rate. For successive 1 min intervals, the temperature increments should then not differ by more than 0,002 K/min or the average difference should not exceed 0,001 K/min. A fore period of 5 min (6 readings; 5 increments) should suffice to establish the value of $(dT/dt)_i = g_i$, the initial drift rate. For an increase in temperature, g_i has a positive value (> 0).

NOTE The calorimeter temperature, as a function of time as a whole, is an exponential going asymptotically to T_∞ . However, during rating periods of 10 min or less, the curvature is negligible except in cases of a large thermal head, in excess of 5 K, in combination with a large value for the specific rate constant, greater than $0,005 \text{ min}^{-1}$.

The charge is fired directly upon taking the last reading of temperature in the fore period (see 8.4).

B.4.2 After period and length of the main period

The final rating period (the after period) begins if all parts of the calorimeter have attained a uniform temperature after combustion of the sample, i.e. if the calorimeter has reached a new steady state in terms of temperature drift rate. The time required for the total amount of heat released to become uniformly distributed is primarily a function of stirring pattern and stirrer efficiency. The duration of the main period shall be chosen so that temperature equalization is ensured, but there is no merit in making the main period longer than necessary.

The main period begins at the last reading of temperature in the fore period and ends with the beginning of the after period. The latter is determined in a series of calibration experiments and is taken as the time if, for a subsequent 5 min period, the average deviation of the individual 1 min temperature increments is not more than 0,001 K/min. The mean of the length of time for the main period determined from five calibration experiments, rounded to the nearest minute, defines the length of the main period. It shall not exceed 10 min. Nor shall the time intervals evaluated from the individual experiments differ by more than 2 min.

The length of the main period shall be the same in the calibration and in the fuel experiments. If θ is meant to vary over a wide range, it is advisable to determine the length of the main period at the larger values of θ .

The duration of the after period should be 5 min to 7 min in order to establish the final drift rate g_f well enough for the calculation of the correction for heat exchange ΔT_{ex} . For an increase in temperature with time, g_f has a positive value (> 0).

B.5 Calculation of the corrected temperature rise B

B.5.1 General

The observed temperature rise, $T_f - T_i$, is the sum of θ , the change in temperature caused by the processes in the combustion bomb, and ΔT_{ex} , the contribution from heat exchange with the surrounding thermostat (including the contribution from stirring power). The time-temperature readings taken during the fore, main and after periods contain the information required for the evaluation of ΔT_{ex} , and hence θ from the equation:

$$\theta = T_f - T_i - \Delta T_{\text{ex}} \quad (\text{B.5})$$

The rating periods yield

$$g_i = \left(\frac{dT}{dt} \right)_i = G(T_\infty - T_{mi}) \quad (\text{B.6})$$

and

$$g_f = \left(\frac{dT}{dt} \right)_f = G(T_\infty - T_{mf}) \quad (\text{B.7})$$

utilized in the calculation of the specific rate constant

$$G = \frac{g_i - g_f}{T_{mf} - T_{mi}} \quad (\text{B.8})$$

where

g_i is the drift rate in the fore (initial rating) period, in Kelvin per minute;

g_f is the drift rate in the after (final rating) period, in Kelvin, per minute;

T_{mf} is the mean temperature in the after period, in degrees Celsius;

T_{mi} is the mean temperature in the fore period, in degrees Celsius.

Temperature may be expressed in some arbitrary unit throughout (see 9.6.1).

g_i and g_f are preferably evaluated as the slope of a linear least-squares fitting of the time-temperature values of the fore and after periods, respectively. Alternatively, they are taken as the mean values of the 1 min temperature increments in the rating periods.

B.5.2 Regnault-Pfaundler method

For time-temperature readings in the main period all taken at equal time intervals (e.g. 1 min), ΔT_{ex} may be expressed as:

$$\Delta T_{\text{ex}} = G \int_{t_i}^{t_f} (T_\infty - T) dt = [g_f + G(T_{mf} - T_m)] \times (t_f - t_i) \quad (\text{B.9})$$

where T_m (the integrated mean temperature) is calculated from the following equation:

$$T_m = \frac{1}{n} \left[\frac{T_0 + T_n}{2} + \sum_{k=1}^{n-1} T_k \right] \quad (\text{B.10})$$

$$k = 1, \dots, n-1$$

where

n is the number of 1 min intervals in the main period;

T_0 ($= T_i$) is the temperature at the beginning of the main period;

$T_1, T_2, \dots, T_k, \dots, T_n$ are the successive temperature readings taken during the main period, T_n ($= T_f$) being that at the end;

t_i and t_f are the times at the beginning and end of the main period, respectively.

B.5.3 Dickinson extrapolation method

In the Dickinson extrapolation method, the objective is to find a time t_x such that:

$$g_i(t_x - t_i) + g_f(t_f - t_x) = G \int_{t_i}^{t_f} (T_\infty - T) dt = \Delta T_{ex} \quad (\text{B.11})$$

This is accomplished if the hatched areas a and b in Figure B.1 are of equal size. The corrected temperature rise θ becomes:

$$\theta = T_f - T_i - g_i(t_x - t_i) - g_f(t_f - t_x) = T_f^* - T_i^* \quad (\text{B.12})$$

where g_i and g_f represent, in principle, the drift rates at t_i and t_f , respectively.

For a combustion reaction, the time-temperature curve is close to being an exponential which means that t_x is the time associated with the temperature where the change in temperature ($T_x - T_i$) is 0,6 times the total (observed) temperature rise ($T_f - T_i$). The quantity ($t_x - t_i$) varies with the kinetic behaviour of the combustion reaction of the type of sample studied.

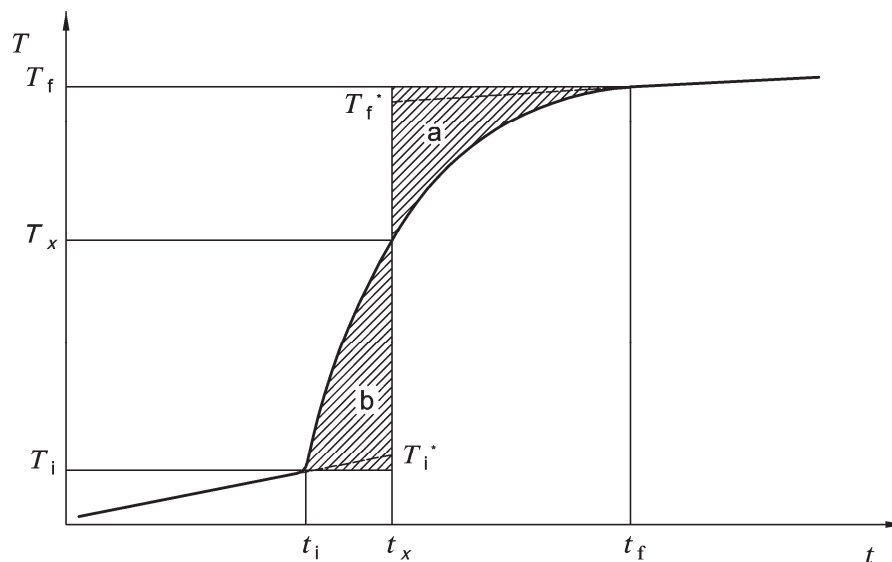

Figure B.1 — Dickinson extrapolation

Annex C (normative)

Automated bomb calorimeters

C.1 The instrument

Among the various types of fully automated bomb combustion calorimeters there are instruments that fulfil all the basic requirements regarding a physically well-defined calorimeter, as well as instruments whose thermal behaviour has to be specified empirically. The former type of instrument usually demands less in terms of comparability, for example in the amount of heat released in calibrations and in fuel experiments, respectively, in order to yield reliable results. Also, the effective heat capacity ε of a well-defined calorimeter as a rule remains constant over long periods of time.

There is no particular reason to assume that instruments with a less well-defined calorimeter could not produce calorific values with the required accuracy, provided that the repeatability is within some set limits and the user is aware of and adheres to restrictions in the choice of operating conditions. Usually a calorimeter of this kind requires more frequent calibrations, in some cases every day that it is used.

Aneroid calorimeters (see 6.1) are convenient for automated operation as the circulation of the calorimeter water is inapplicable, thereby also eliminating evaporation deviations. They are usually operated as adiabatic or quasi-adiabatic systems but can equally well be of the isoperibol type. Characteristically they have a small heat capacity, leading to large changes in calorimeter temperature, thus facilitating the measurement of θ with a relatively high resolution. Conversely, large values of θ tend to increase the risk for introducing systematic deviation, in aneroid systems aggravated by difficulties in achieving uniform calorimeter surface temperature during combustion of the sample. A countermeasure is to limit the sample mass, bearing in mind that for smaller samples particular attention shall be given to their being representative.

In certain cases, well-defined stable calorimetric systems allow operation in dynamic mode, i.e. already a few minutes into the main period it is possible to predict the final outcome of the experiment in terms of θ , without any loss in accuracy of the results.

C.2 Calibration

The effective heat capacity ε shall, in principle, be determined as specified in Clause 9 with particular reference to 9.2, 9.4 and 9.5.

The instrument manufacturer may specify bomb conditions (ratio of sample mass to bomb volume, initial bomb water, oxygen pressure) that deviate significantly from those defined in 9.2.1. If these bomb conditions cause changes in the energy of combustion of the calibration reference (benzoic acid) larger than ± 5 J/g (see 9.2.2), it shall be possible to adjust any preset value for benzoic acid, i.e. to input the correct value for the calculations of ε .

Recommendations to exclude the initial amount of water in the bomb should primarily be disregarded. The amount, however, may be kept quite small (or even zero) but should be the same both in calibration and in all experiments.

The reference temperature of the experiments (equal to the final temperature T_f of the main period) should be kept the same, within ± 1 K, in all experiments. If necessary, it may be chosen arbitrarily within ± 10 K from 25 °C without seriously affecting the numerical values of the determinations of calorific value. A deviation in excess of ± 5 K from 25 °C should be quoted with the test result.

NOTE 1 Ancillary quantities given in 9.6.1, 9.6.2 and 10.3.2 refer, in principle, to states and reactions at 25 °C.

Some instruments call for calibration using samples differing by about a factor of 2 in mass. Correctly implemented, this offers considerable flexibility for subsequent fuel measurements. Establishing a valid working range for the effective heat capacity ε is always required (see 9.3). If the range is narrow in terms of the amount of heat released, special attention shall be given to performing all experiments within these limits.

For instruments that require frequent calibration, some manufacturers provide benzoic acid pellets of appropriate mass with an assigned value for the energy of combustion. As a rule these pellets do not qualify as the calibration reference (see 5.5 and 9.2) but are convenient for everyday use. An alternative is to check the calibration by making a series of measurements on a pelletised sample of certified benzoic acid at regular intervals and whenever a new batch of the manufacturer's sample is used. The mean value from a series of five combustions, with the sample mass of about the same throughout, shall not differ by more than ± 50 J/g from the certified value, recalculated if applicable, to the actual bomb conditions.

NOTE 2 Some instruments require preconditioning by combustion of a few samples before yielding stable results. Almost any benzoic acid (pelletised) or combustion aid (see 8.1) can be used for this purpose. The results from these conditioning runs should be disregarded.

Combustion of certified benzoic acid as an "unknown" is generally the most convenient way of checking the performance of a calorimeter (see 9.3).

C.3 Precision requirements for calibrations

The values of ε for the individual calibration experiments should be printed or displayed so that they can be manually recorded (in Joules per Kelvin or in arbitrary units together with θ in these units). Generally, the precision requirements for ε , as given in 9.7, apply.

Some systems compensate for significant drift by using the mean of the previous mean value and the value for ε from the latest calibration experiment as the measure for the effective heat capacity. In such a case, the individual values of ε for a series of calibration experiments cannot be used to evaluate the precision characteristics of the measurements. Instead, a series of individual measurements using certified benzoic acid as the sample shall be performed over a period of one day or, at the most, two days. For a series of five benzoic acid combustions, the standard deviation shall not exceed 0,20 %. The mean value shall not differ by more than ± 50 J/g from the certificate value (see C.2).

C.4 Comparability of calibration and fuel experiments

The conditions specified in 10.1 to 10.3 apply, including arguments about whether thermal contributions from combustion of the fuse and/or side reactions, such as the formation of nitric acid, need to be taken into account in the evaluations (see 9.6.1).

In the calculation procedures of automated instruments there are usually no provisions to allow specifically for the use of crucibles of widely different material and mass.

In aneroid systems or systems working on a constant mass-of-water basis, the deviation ε from disregarding a difference in heat capacity of individual crucibles is:

$$\varepsilon = \frac{\theta \times \Delta C}{m_1} \quad (\text{C.1})$$

where

ΔC is the difference in heat capacity ($m_{\text{cr}} \times c_{p,\text{cr}}$) of the crucible used in the calibrations and that used in combustion of the fuel;

m_1 is the mass of fuel burned.

For calorimeters working on a constant total-calorimeter-mass basis, the deviation ε is estimated by:

$$\varepsilon = \frac{\theta \times \Delta m_{\text{cr}} \times c_{p,\text{aq}}}{m_1} \quad (\text{see 9.6.2}). \quad (\text{C.2})$$

Achieving a complete combustion is the first priority. Optimizing the overall conditions to achieve it is usually worthwhile.

C.5 Documentation and print-out

The evaluation of the gross calorific value at constant volume $q_{V,\text{gr}}$ for the analysis sample shall, in principle, be in accordance with 10.4. The value shall be given in Joules per gram or another convenient unit.

The printed or otherwise recorded information on the individual experiment shall allow the user to verify the calculations starting from values of θ , ε , mass of sample, fuse and any combustion aid. The equations used should be given in the manual itself or in an annex. Ancillary quantities used in the calculations shall be unambiguously identifiable, and it shall be possible to make the necessary alterations in the program required by changes in procedure, including a change in the numerical value used for the energy of combustion of the calibration reference in calibration experiments. Corrections applied for ignition energy, side reactions etc. shall be clearly stated.

The reference temperature of the experiment shall be identified to the nearest 0,2 K.

C.6 Precision requirements for fuel experiments

The precision requirements in terms of repeatability limit of the results of duplicate measurements are stated in Clause 11.

Annex D (informative)

Checklists for the design and procedures of combustion experiments

D.1 Introduction

This annex contains checklists intended as aids in setting up and carrying out a complete determination of a calorific value, including calibration of the instrument, using a specified type of calorimeter. Equations, identical to those given in the main text, are repeated here for clarity.

The general experimental conditions are defined in D.2 which is common to the use of all types of bomb calorimeters. D.3 contains information pertinent to the use of adiabatic calorimeters, D.4 applies to isoperibol calorimeters and D.5 deals with the highly automated bomb-calorimetric systems. Static-jacket calorimeters can be treated as isoperibol systems.

Numbers in parentheses refer to clauses or subclauses in the main text or Annexes A to C. The basic calorimetric procedure is specified in Clause 8. The calibration procedures are specified in 9.5 and 9.6. The experimental and calculation procedures for the fuel combustions are specified in 10.2 to 10.4. Additional information required for the particular type of calorimeter is given in:

- Annex A and D.3 for adiabatic calorimeters;
- Annex B and D.4 for isoperibol or static-jacket calorimeters;
- Annex C and D.5 for automated bomb calorimeters.

D.2 Choice of general parameters

Calibration conditions, the basis for the conditions of subsequent fuel experiments (see 9.2.2 and 9.3 for general calibration requirements):

Bomb volume, V_{bomb} , in litres	=	
Mass of benzoic acid, m_{ba} , in grams	=	
Mass of bomb water, m_{aq} , in grams	=	(V_{aq} , in millilitres, can be substituted for m_{aq})
Initial pressure of oxygen, p_{O} , in megapascals	=	
Reference temperature, T_{ref} , in degrees Celsius	=	

Calculation of the bomb condition value of benzoid acid:

This value is used in the calculations of the effective heat capacity of the calorimeter, ε (consult the particular benzoic acid certificate; see also 9.6.1 and 9.6.2).

Certificate value of benzoic acid, in Joules per gram	=	(see 9.2.1)
$(m_{\text{ba}}/V_{\text{bomb}})$, in grams per litre — 3,0 g/l	=	
$(V_{\text{aq}}/V_{\text{bomb}})$, in millilitres per litre — 3,0 ml/l	=	
p_{O} , in megapascals — 3,0 MPa	=	

T_{ref} , in degrees Celsius — 25 °C	=	(see 8.7)
Adjustment to certificate value, in Joules per gram	=	(according to the equation in the certificate)
This yields $q_{V,\text{ba}}$, in Joules per gram	=	

Amount of calorimeter water (8.1 and 8.3; not relevant for aneroid systems):

a) **Constant mass-of-calorimeter-water basis** (see 8.3; 9.6.1; 10.3.2):

Mass of calorimeter water = g

Or alternatively for

b) **Constant total-calorimeter-mass basis** (see 8.3; 9.6.2; 10.3.3):

Mass of (calorimeter + water + assembled bomb) = g

Additional parameters to consider:

Ignition wire (fuse): l_{wire} = cm or constant $Q_{\text{ign}} = \text{J}$ (see 9.4; 9.6.1)

Fuse: m_{fuse} = g or constant $Q_{\text{fuse}} = \text{J}$ (see 9.4; 9.6.1)

Decide whether the correction for nitric acid Q_{N} needs to be determined by analysis for the individual experiment or assigned a constant **per-gram** value (not necessarily the same for calibration reference and fuel experiments, respectively) or **per-experiment** value (see 9.4; 10.1).

D.3 Adiabatic calorimeters

D.3.1 Determination of the corrected temperature rise θ

Make the necessary adjustments to achieve adiabatic conditions (see A.3.1; A.3.2).

Estimate the heat capacity of the system and, from the choice of mass of sample, make a prediction of the expected temperature rise Δt in order to determine the starting temperature ($T_{\text{ref}} - \Delta T$).

Determine what the conditions are for an initial steady state (see A.4).

Make a series of experiments to determine the length of the main period (see A.4; 8.2 to 8.5; 9.5).

From the time-temperature measurements (t_k, T_k) for a set of benzoic acid combustions, calculate the corrected temperature rise θ for the individual experiments (see A.5) by:

$$\theta = T_f - T_i \quad (\text{D.1})$$

For a significant (but limited) drift at the end of the main period, θ is derived by (see A.5):

$$\theta = T_f - T_i - g_f \times (\Delta t - 1) \quad (\text{D.2})$$

D.3.2 Evaluation of the effective heat capacity ε

Calculate the effective heat capacity ε for the individual experiments.

For alternative D.2 a), the **constant mass-of-calorimeter-water basis** (see 9.6.1), ε is calculated by:

$$\varepsilon = \frac{m_{\text{ba}} \times q_{V,\text{ba}} + Q_{\text{fuse}} + Q_{\text{ign}} + Q_{\text{N}}}{\theta} \quad (\text{D.3})$$

For alternative D.2 b), the **constant total-calorimeter-mass basis** (see 9.6.2), ε_0 is calculated from:

$$\varepsilon_0 = \varepsilon_{\bullet} + m_{\text{cr}} \times c_{p,\text{aq}} \quad (\text{D.4})$$

where

ε_{\bullet} is equal to ε as defined above;

m_{cr} is the mass of the crucible used in the individual calibration experiment. Compare NOTE in 9.6.2.

Calculate the mean value $\varepsilon_{(n)}$ or $\varepsilon_{0(n)}$, respectively, and make sure that the precision requirements are met (see 9.7).

The system is now calibrated and the main calorimetric parameters set for subsequent combustion measurements on fuel samples.

Ancillary quantities required in the calculations are given in 9.6.1.

D.3.3 The gross calorific value at constant volume $q_{V,\text{gr}}$

Perform the fuel combustions in accordance with the instructions in 10.2 and 10.3. θ is calculated in the same way as for the calibrations (see A.5).

For alternative D.2 a), a calorimeter operated on the **constant mass-of-calorimeter-water basis**, calculate the calorific value (see 10.3.2) by:

$$q_{V,\text{gr}} = \frac{\varepsilon_{(n)} \times \theta - Q_{\text{fuse}} - Q_{\text{ign}} - Q_{\text{N}} - m_2 \times q_{V,2}}{m_1} - \frac{Q_{\text{S}}}{m_1} \quad (\text{D.5})$$

For alternative D.2 b), a calorimeter operated on the **constant total-calorimeter-mass basis**, calculate the calorific value (see 10.3.3) by:

$$q_{V,\text{gr}} = \frac{\varepsilon_{\bullet} \times \theta - Q_{\text{fuse}} - Q_{\text{ign}} - Q_{\text{N}} - m_2 \times q_{V,2}}{m_1} - \frac{Q_{\text{S}}}{m_1} \quad (\text{D.6})$$

where

ε_{\bullet} is derived from $\varepsilon_{\bullet} = \varepsilon_{0(n)} - m_{\text{cr}} \times c_{p,\text{aq}}$;

m_{cr} is the mass of the crucible in the individual experiment, in grams.

Always use the crucible best suited for the particular sample under investigation.

Ancillary quantities required in the calculations are given in 9.6.1 and 10.3.2.

D.4 Isoperibol calorimeters

D.4.1 Determination of the corrected temperature rise θ

Set the jacket temperature to the value chosen for the experiments (see B.3).

Estimate the heat capacity of the system and, from the choice of mass of sample, make a prediction of the expected temperature rise ΔT in order to determine the starting temperature ($T_{\text{ref}} - \Delta T$).

Investigate what the conditions are for an initial steady state and decide upon the length of the fore or initial rating period (B.4.1).

Make a series of experiments to determine the length of the main period (see B.4.2; 8.2 to 8.5; 9.5).

From the time-temperature measurements (t_k, T_k) for a set of benzoic acid combustions, calculate the corrected temperature rise θ for the individual experiments, utilizing either the Regnault-Pfaundler (see a)) or the Dickinson method (see b)).

a) Regnault-Pfaundler method (B.5.1; B.5.2)

Determine the drift rates g_i and g_f and the mean temperatures T_{mi} and T_{mf} of the rating periods and calculate the specific rate constant G by:

$$G = \frac{g_i - g_f}{T_{\text{mf}} - T_{\text{mi}}} \quad (\text{D.7})$$

Then calculate T_m (the integrated mean temperature) and ΔT_{ex} , (the contribution from heat exchange) by:

$$T_m = \frac{1}{n} \left[\frac{T_0 + T_n}{2} + \sum_{k=1}^{n-1} t_k \right] \quad (\text{D.8})$$

and

$$\Delta T_{\text{ex}} = G \int_{t_i}^{t_f} (T_{\infty} - T) dt = [g_f + G(T_{\text{mf}} - T_m)] \times (t_f - t_i) \quad (\text{D.9})$$

Finally, calculate θ by:

$$\theta = T_f - T_i - \Delta T_{\text{ex}} \quad (\text{D.10})$$

b) Dickinson extrapolation method (see B.5.1; B.5.3)

Record a graph of the time-temperature (t_k, T_k) values of the main period and determine the time for $T_i + 0,6 \times (T_f - T_i)$. This time is taken as t_x . Determine the drift rates, i.e. the slopes of the rating periods, as follows:

$$g_i = (dT/dt)_i \quad \text{and} \quad g_f = (dT/dt)_f \quad (\text{D.11})$$

Then calculate θ by:

$$\theta = T_f - T_i - g_i(t_x - t_i) - g_f(t_f - t_x) \quad (\text{D.12})$$

NOTE The extrapolation time t_x for the fuel experiments is likely to differ from that for the calibrations.

D.4.2 Evaluation of the effective heat capacity ε

Calculate the effective heat capacity for the individual experiments using the appropriate equation [alternative D.2 a) or D.2 b)] as given in D.3.2.

Calculate the mean value $\varepsilon_{(n)}$ or $\varepsilon_{0(n)}$, respectively, and make sure that the precision requirements are met (see 9.7).

The system is now calibrated and the main calorimetric parameters set for subsequent combustion measurements on fuel samples.

D.4.3 The gross calorific value at constant volume $q_{V,gr}$

Perform the fuel combustions in accordance with the instructions in 10.2 and 10.3. θ is calculated in the same way as for the calibrations.

Calculate the calorific value using the appropriate equation [alternative D.2 a) or D.2 b)] as given in D.3.3.

D.5 Automated bomb calorimeters

Operate the calorimeter according to the instructions. The corrected temperature rise θ is usually derived automatically by the system.

Make sure that the correct value is used for the energy of combustion of the calibration reference under the bomb conditions utilized (see D.2) in the evaluation of the calibration constant.

Make sure that the precision requirements are met. If necessary, check the system by burning benzoic acid as an unknown. Any restrictions set by the manufacturer, on the amount of sample burned, shall be adhered to.

Define the valid working range for subsequent measurements.

Make a check on the calculations with respect to fuse wire and nitric acid corrections. Unless the correction for sulphuric acid to sulphur dioxide (Q_S/m_1) is already taken care of by the system, use the value given in 10.3.2.

Annex E (informative)

Examples to illustrate the main calculations used in this European Standard if an automated (adiabatic) bomb calorimeter is used for determinations

E.1 Gross calorific value at constant volume

a) Calibration data:

No	m_{ba}, g	T_i, K	T_f, K	θ, K	Q_{fuse}, J	Q_{ign}, J	NaOH, ml	Q_N, J	$\varepsilon, J/K$
1	1,028 2	1,059	4,102	3,043	0	21,5	6,5	39,0	8 962
2	1,052 5	0,454	3,568	3,114	0	21,5	5,9	35,4	8 963
3	1,001 9	0,892	3,859	2,967	0	21,5	6,4	38,4	8 957
4	1,022 9	0,942	3,970	3,028	0	21,5	5,7	34,2	8 959
5	1,014 6	0,373	3,375	3,002	0	21,5	6,4	38,4	8 964
average $\varepsilon_{(n)}$									8 961

$$q_{V,ba} = 26\,465 \text{ J/g}$$

$l_{wire} = 10$ cm of ignition wire; of which 8 cm is burned ($q_{ign} = 2,69$ J/cm)

No fuse, cotton etc., was used

NaOH, [$c = 0,1$ mol/l]

b) Corrected temperature rise θ

Difference of initial and final temperatures ($T_f - T_i$) or directly read temperature rise θ (see above).

c) Calculation of the effective heat capacity ε

The effective heat capacity ε is derived from the total energy change of the overall bomb process; e.g.

$$(1,028\,2 \times 26\,465 + 21,5 + 39,0) \text{ divided by } \theta(3,043), \text{ i.e. } \varepsilon = 8\,962 \text{ J/K.}$$

d) Calculation of the gross calorific value $q_{V,gr}$

For the combustion of about 1 g of a solid recovered fuel sample the parameters of the experiment were

$$m_1 = 1,192\,4 \text{ g} \quad Q_{fuse} = 0$$

$$l_{wire} = 8 \text{ cm} \quad Q_{ign} = 21,5 \text{ J}$$

$$\theta = 2,630 \text{ K} \quad Q_{N,S} = 29,4 \text{ J}$$

The nitric acid correction (and a part of the sulphuric acid correction) was determined by titration with NaOH (method c) as $Q_{N,S}$.

The “combustion energy” from the solid recovered fuel sample is derived from $(\varepsilon_{(n)} \times \theta)$ minus the contributions from the ignition wire and the formation of nitric acid, i.e. (21,5 + 29,4) J, divided by the mass of the solid recovered fuels sample m_1 .

Hence

$$\frac{8\,961 \times 2,630 - 21,5 - 29,4}{1,192\,4} = 19\,722 \text{ J/g where } \varepsilon \text{ was used as } \varepsilon_{(n)} \quad (\text{E.1})$$

The mass fraction of sulphur of the solid recovered fuels analysis sample was 0,02 %. The correction to account for the reaction from aqueous sulphuric acid to gaseous sulphur dioxide is $0,02 \times 57 = 1 \text{ J/g}$ ($Q_S/m_1 = (57 \times S \times m_1)/m_1$), which is to be subtracted from 19 722 J/g, yielding 19 721 J/g as the gross calorific value at constant volume for the analysis sample, $q_{V,gr}$.

The mass fraction of total moisture as received (M_{ar}) for the solid recovered fuels in question was 40,0 %; the mass fraction of moisture of the analysis sample (M_{ad}) was 3,0 %. For the dry sample (dry basis, in dry matter) the gross calorific value at constant volume is:

$$q_{V,gr,d} = 19\,721 \times \frac{100}{100 - 3,0} \text{ J/g} = 20\,330 \text{ J/g or } 20,33 \text{ MJ/kg} \quad (\text{E.2})$$

For the original (moist, as received) solid recovered fuels sample the gross calorific value at constant volume is:

$$q_{V,gr,ar} = 20\,330 \times (1 - 0,01 \times 40,0) = 12\,198 \text{ J/g or } 12,20 \text{ MJ/kg.} \quad (\text{E.3})$$

E.2 Gross calorific value at constant pressure

If the solid recovered fuel was burnt in oxygen at constant pressure, instead of at constant volume in the bomb, the volume of the system would change. The hydrogen in the fuel, reacting with gaseous oxygen to give liquid water, causes a decrease in the volume of the system. If the carbon containing in solid recovered fuel reacts with gaseous oxygen, an equal volume of gaseous carbon dioxide is formed and hence no change in volume occurs in combustion of the carbon. The oxygen and nitrogen in the solid recovered fuel both give rise to an increase in volume. The change in the volume of the gaseous phase for the combustion reaction can be expressed as:

$$\Delta n_g = 0,01 \times \left[-\frac{0,5 \times w(\text{H})}{2,016} + \frac{w(\text{O})}{31,999} + \frac{w(\text{N})}{28,013} \right] \text{ moles per gram of sample} \quad (\text{E.4})$$

where $w(\text{H})$, $w(\text{O})$ and $w(\text{N})$ are the total percentages of hydrogen, oxygen and nitrogen, respectively, in the solid recovered fuel solid material in the state specified for the conversion from a constant volume calorific value to a constant pressure value.

The Δn_g value is to be multiplied by T_{ref} to interpret the volume change in terms of the associated change in energy. T_{ref} in this context is the reference temperature for calorific values, i.e. 298,15 K (25 °C).

For convenience, the dry state values are used to show the relation between the gross calorific value at constant pressure and that at constant volume:

$$q_{p,gd,d} = q_{V,gr,d} + \{6,15 \times w(\text{H})_d - 0,8 \times [w(\text{O})_d + w(\text{N})_d]\} \text{ J/g} \quad (\text{E.5})$$

where $w(\text{H})_d$, $w(\text{O})_d$ and $w(\text{N})_d$ have the same significance as in 12.2. $w(\text{H})$, $w(\text{O})$ and $w(\text{N})$ do not contain any contributions from the mineral matter of the fuel sample. The uncertainty introduced by substituting $w(\text{H})_d$, $w(\text{O})_d$ and $w(\text{N})_d$ is, however, negligible. The coefficient for $w(\text{N})_d$, strictly, is 0,9 but can be taken to be the same as that for oxygen since the term as such is small.

E.3 Net calorific value

E.3.1 Net calorific value at constant volume

The energy of vaporization (constant volume) for water at 25 °C is 41,53 kJ/mol. This corresponds to 206,0 J/g for a mass fraction of hydrogen of 1 % in the fuel sample or 23,05 J/g for a mass fraction of moisture of 1 %, respectively.

The net calorific value at constant volume, $q_{V,\text{net}}$, is derived from the corresponding gross calorific value, for example:

$$q_{V,\text{net},d} = q_{V,\text{gr},d} - 206,0 \times w(\text{H})_d \quad (\text{E.6})$$

where $w(\text{H})_d$ is the hydrogen content, in percentage by mass, of the moisture-free fuel (see 12.2).

For the required mass fraction of moisture M (e.g. total moisture content as received, M_{ar}) the net calorific value at constant volume is calculated from:

$$q_{V,\text{net},m} = [q_{V,\text{gr},d} - 206,0 \times w(\text{H})_d] \times (1 - 0,01 \times M) - 23,05 \times M \quad (\text{E.7})$$

E.3.2 Net calorific value at constant pressure

The enthalpy of vaporization (constant pressure) for water at 25 °C is 44,01 kJ/mol. This corresponds to 218,3 J/g for a mass fraction of hydrogen of 1 % in the fuel sample or 24,43 J/g for a mass fraction of moisture of 1 %, respectively.

The net calorific value at constant pressure for the dry sample can be derived from that at constant volume according to:

$$\begin{aligned} q_{p,\text{net},d} &= q_{V,\text{gr},d} + 6,15 \times w(\text{H})_d - 0,8 \times [w(\text{O})_d + w(\text{N})_d] - 218,3 \times w(\text{H})_d \\ &= q_{V,\text{gr},d} - 212,2 \times w(\text{H})_d - 0,8 \times [w(\text{O})_d + w(\text{N})_d] \end{aligned} \quad (\text{E.8})$$

For the required moisture content M (e.g. total moisture content as received, M_{ar}) the net calorific value at constant pressure is calculated from:

$$q_{p,\text{net},m} = \{q_{V,\text{gr},d} - 212,2 \times w(\text{H})_d - 0,8 \times [w(\text{O})_d + w(\text{N})_d]\} \times (1 - 0,01M) - 24,43 \times M \quad (\text{E.9})$$

E.4 Use of typical or default values to calculate calorific values

For well defined and characterized virgin solid recovered fuels typical values with well documented references, or if such are not available, default values for hydrogen (H), nitrogen (N), oxygen (O) and sulphur (S) can be used instead of determined values on the calculations of gross calorific values and net calorific values.

For other solid recovered fuels and solid recovered fuels blends and mixtures the determination of H, O, N, S, Cl should be done simultaneously with the determination of calorific value.

Annex F (informative)

List of symbols used in this European Standard

$q_{V,gr}$	Gross calorific value at constant volume of the solid recovered fuel as analysed
$q_{V,gr,d}$	Gross calorific value at constant volume of the dry (moisture-free) fuel (dry basis, in dry matter)
$q_{V,gr,m}$	Gross calorific value at constant volume of the solid recovered fuel with moisture content M
$q_{p,gr,d}$	Gross calorific value at constant pressure of the dry (moisture-free) fuel (dry basis, in dry matter)
$q_{V,net,m}$	Net calorific value at constant volume of the solid recovered fuel with moisture content M
$q_{p,net}$	Net calorific value at constant pressure
$q_{p,net,d}$	Net calorific value at constant pressure of the dry (moisture-free) fuel (dry basis, in dry matter)
$q_{p,net,m}$	Net calorific value at constant pressure of the solid recovered fuel with moisture content M (e.g. as received, $q_{p,net,ar}$)
$q_{V,ba}$	Certified gross calorific value at constant volume for benzoic acid
$q_{V,2}$	Gross calorific value at constant volume of a combustion aid
Q_{fuse}	Contribution from combustion of the fuse
Q_{ign}	Contribution from oxidation of the ignition wire
Q_N	Contribution from formation of nitric acid (from liquid water and gaseous nitrogen and oxygen)
Q_S	Correction for taking the sulphur from the aqueous sulphuric acid in the bomb to gaseous sulphur dioxide
Q_{Cl}	Correction for taking the chlorine from the aqueous hydrochloric acid in the bomb to gaseous chlorine dioxide
$Q_{N,S}$	Combined correction for nitric and sulphuric acids
M	Moisture content of the solid recovered fuel for which the calculation is required
M_{ad}	Moisture in the general analysis sample
M_{ar}	Total moisture as received (as sampled)
m_{ba}	Mass of benzoic acid
m_1	Mass of solid recovered fuel sample
m_2	Mass of combustion aid
m_{cr}	Mass of crucible
ε	Effective heat capacity of the calorimeter

ε_0	Effective heat capacity of hypothetical calorimeter with no crucible in the bomb
ε	Effective heat capacity of calorimeter on a “total-calorimeter-mass” basis
$\varepsilon_{(n)}$	Mean effective heat capacity of the calorimeter based on n determinations of ε
$\varepsilon_{0(n)}$	Mean effective heat capacity of the calorimeter based on n determinations of ε_0
$\hat{\varepsilon}$	Best estimate (corresponds to “mean” value) of ε from linear regression of ε as a function of the observed temperature rise ($T_f - T_i$)
$c_{p,cr}$	Specific heat capacity of the crucible
$c_{p,aq}$	Specific heat capacity of water
θ	Corrected temperature rise
T	Calorimeter temperature
T_{ref}	Reference temperature
T_i	Initial temperature of the main period
T_f	Final temperature of the main period (= reference temperature)
$T_f - T_i$	Observed temperature rise
ΔT_{ex}	Heat-leak correction
T_j	Thermostat (jacket) temperature
$T_j - T$	Thermal head
T_∞	Asymptotic temperature of an isoperibol calorimeter (at “infinite” time)
T_{mi}	Mean temperature in the fore period
T_{mf}	Mean temperature in the after period
t_{f+a}	Temperature a min after the end of the main period
T_x	Temperature at the time t_x
t	Time
t_i	Time at the beginning of the main period
t_f	Time at the end of the main period
t_x	Dickinson extrapolation time
G	Specific rate constant
g	Drift rate (dT/dt) in the rating periods
g_i	Drift rate in the fore period
g_f	Drift rate in the after period

P_{st}	Power of stirring
$w(H)_d$	Hydrogen content of the moisture-free solid recovered fuel (includes the hydrogen from the water of hydration of the mineral matter as well as hydrogen in the solid recovered fuel)
$w(O)_d$	Oxygen content of the moisture-free solid recovered fuel
$w(N)_d$	Nitrogen content of the moisture-free solid recovered fuel

Annex G (informative)

Key-word index

Key word	Clause or subclause
adiabatic bomb calorimeters, principle	A.1
adiabatic calorimeter, check on bias	A.6
adiabatic calorimeter, correction, drift	A.5
adiabatic calorimeters, sources of deviation	A.2
adiabatic conditions, thermostat	A.3.1
adiabatic control	A.3.2
analysis sample	7
analytical procedures	8.5
automated bomb calorimeters	C.1
automated calorimeters, calibration	C.2
automated calorimeters, precision	C.3, C.6
automated calorimeters, print-out	C.5
balances, apparatus	6.6
barium hydroxide solution	5.4.1
benzoic acid	5.5
bursting disk	6.4.3
calculation of B, isoperibol calorimeter	B.5
calculation to other bases	10.5
calibration reference	9.2
calibration conditions, calibration reference	9.2.2
calibration procedure	9.5
calibration, principle	9.1
calorimeter can, apparatus	6.2.2
calorimeter, apparatus	6
calorimetric procedure	8
certification conditions, calibration reference	9.2.1
combustion	10.2
combustion aid	8.2.2
combustion bomb, apparatus	6.2.1
corrected temperature rise, adiabatic	8.6.3
corrected temperature rise, definition	3.6
corrected temperature rise, isoperibol	8.6.2

cotton fuse	5.2.2
crucible lining material	5.3
crucible, apparatus	6.3
definitions	3
Dickinson extrapolation method	B.5.3
ε as a function of temperature rise	9.7.2
effective heat capacity, calculation	9.6
effective heat capacity, definition	3.5
effective heat capacity, redetermination	9.8
expression of results	10.4
fuel sample	7
fuse	5.2
gross calorific value, calculation	10.3
gross calorific value, definition	3.1
gross calorific value, principle	4.1
hydrochloric acid solution	5.4.4
ignition circuit	6.2.6
ignition wire	5.2.1
indicators	5.4
initial steady state, adiabatic calorimeter	A.4
initial steady state, isoperibol calorimeter	B.4.1
isoperibol calorimeter, calculation of B	B.5
isoperibol calorimeter, jacket temperature	B.3
isoperibol calorimeter, sources of deviation	B.2
isoperibol calorimeters, principle	B.1
main period, adiabatic calorimeter	A.4
main period, isoperibol calorimeter	B.4.2
mercury-in-glass thermometers	6.2.5
methyl orange indicator, screened	5.4.5
net calorific value	3.2, 3.3
net calorific value at constant pressure	12
net calorific value, calculation	12.2
net calorific value, principle	4.2
normative references	2
observed temperature rise	8.6.1
oxygen	5.1
phenolphthalein indicator	5.4.6
precision	11
precision requirements, calibration	9.7

pressure gauge	6.4.2
pressure regulator	6.4.1
principle	4
rating periods, isoperibol calorimeters	B.4
reagents	5
reference temperature, definition	3.4
reference temperature, experiment	8.7, D.2, E.2
Regnault-Pfaundler method	B.5.2
relief valve	6.4.3
repeatability	11.1
reproducibility	11.2
scope	1
sodium carbonate solution	5.4.2
sodium hydroxide solution	5.4.3
solutions, standard volumetric	5.4
stirrer, apparatus	6.2.3
temperature measuring instrument	6.2.5
thermometer corrections	8.6.4
thermostat, apparatus	6.2.4
thermostat, calorimeter water	6.7
timer, apparatus	6.5
valid working range of calibration	9.3

Annex H
(informative)

Flow chart for a routine calorific value determination

Figure H.1 shows a flow chart for a routine determination of calorific value.

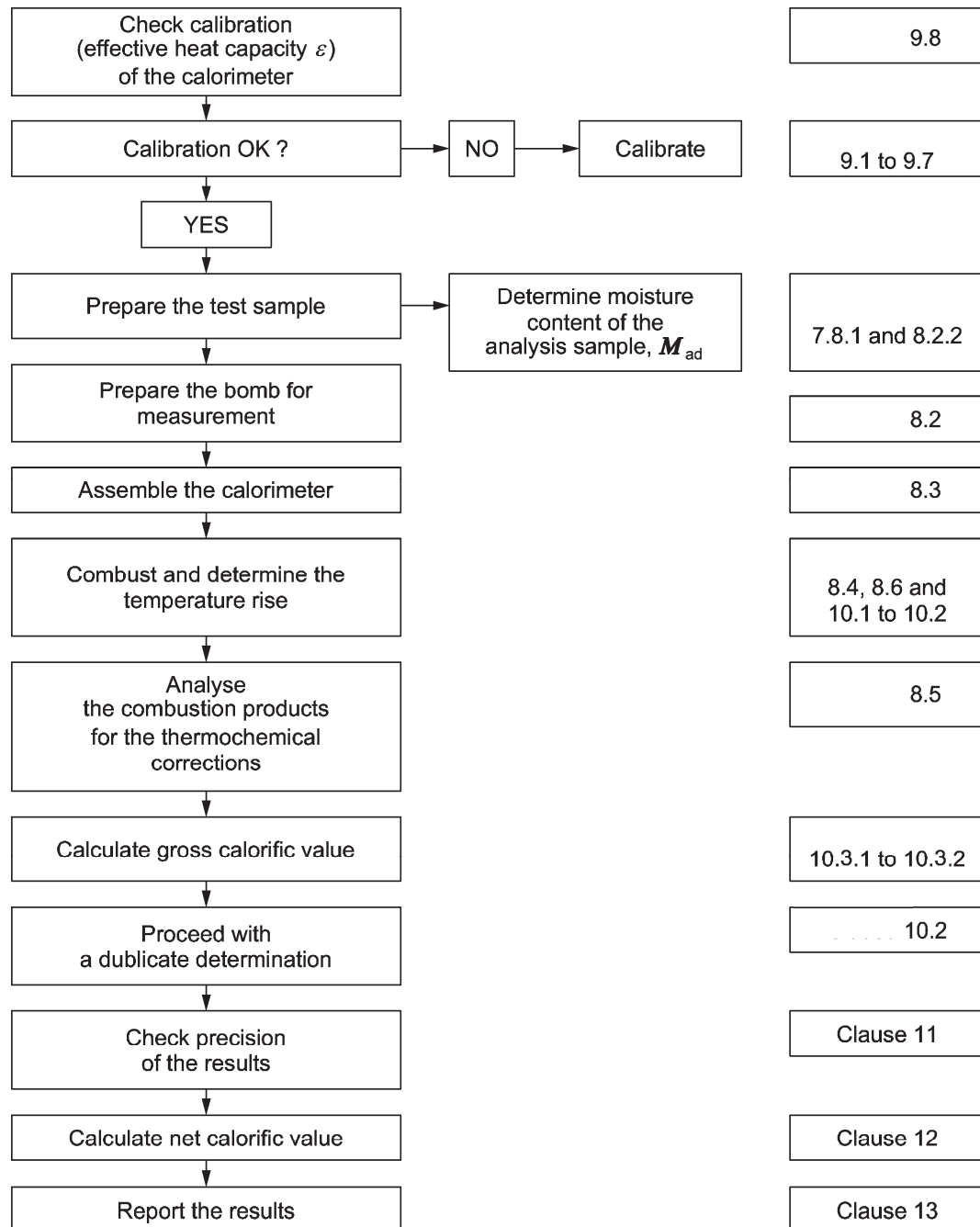

Figure H.1 — Flow chart for a routine calorific value determination

Annex I (informative)

Interlaboratory test results

The statistic evaluation of the interlaboratory test results was carried out in accordance with ISO 5725-5 [11]. The precision data obtained are shown in Table I.1.

Table I.1 — Precision data

Designation	Shredded tyre	Demolition wood	Dried sludge	Municipal waste	Plastic/paper fluff
Number of laboratories participating	14	14	14	14	14
Total number of values (without outliers)	174	172	138	168	180
Mean of gross calorific value, in MJ/kg	31,55	18,07	11,88	19,82	19,38
Laboratory effect, in MJ/kg	1,16	1,52	0,18	0,51	0,86
Sample effect, in MJ/kg	0,50	0,09	0,01	0,17	0,19
Repeatability standard deviation, s_r , in MJ/kg	1,05	0,20	0,06	0,27	0,56
Repeatability limit, r : ($r = 2,8 \times s_r$) in MJ/kg	2,94	0,56	0,17	0,76	1,57
Reproducibility standard deviation, s_R in MJ/kg	1,57	1,53	0,19	0,58	1,03
Reproducibility limit, R : ($R = 2,8 \times s_R$) in MJ/kg	4,40	4,28	0,53	1,62	2,88

The deviations of the test results between the individual laboratories for each sample type are shown in Figures I.1 a) to I.1 e).

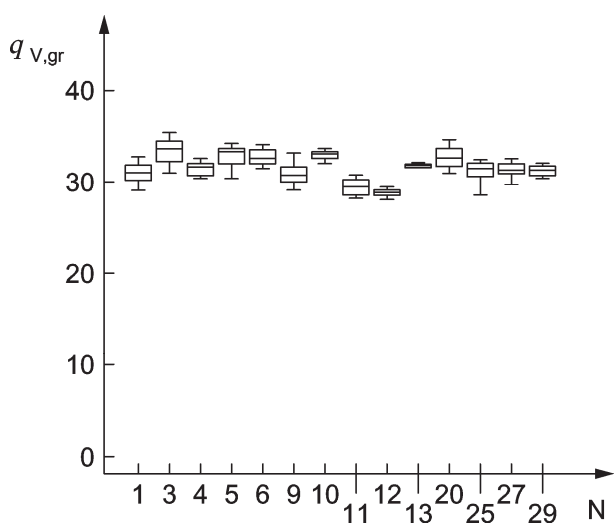

a) Shredded tyre

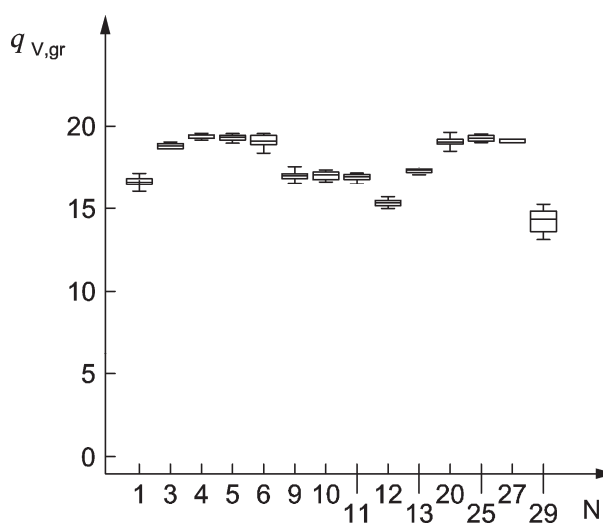

b) Demolition wood

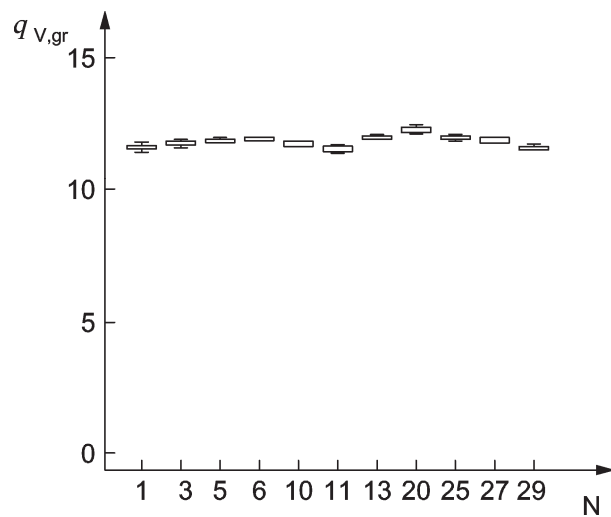

c) Dried sludge

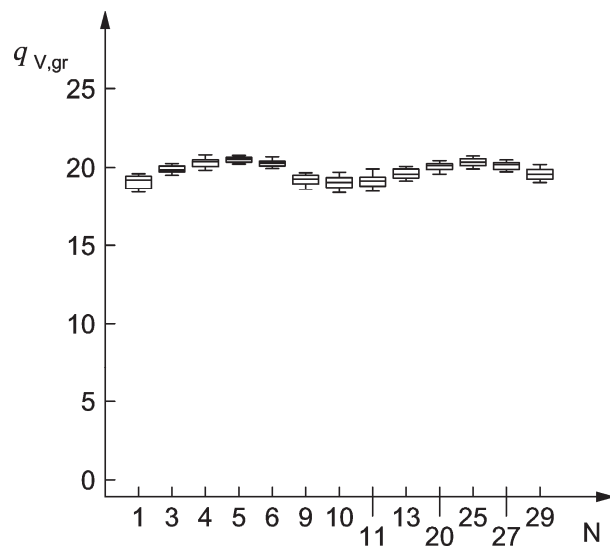

d) Municipal waste

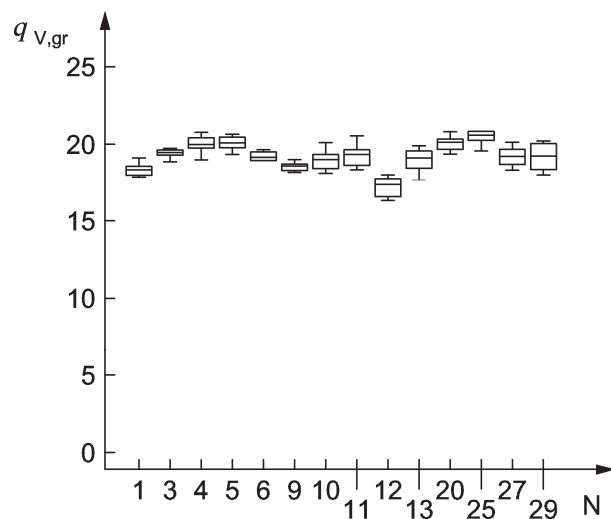

e) Plastic and paper fluffs

Key

$q_{V,gr}$ gross calorific value in MJ/kg
N number of the individual laboratory

Figure I.1 — Deviations of the test results between the individual laboratories for each sample type

Bibliography

- [1] EN 14918, *Solid biofuels — Determination of calorific value*
- [2] EN 15359, *Solid recovered fuels — Specifications and classes*
- [3] EN 15408, *Solid recovered fuels — Methods for the determination of sulphur (S), chlorine (Cl), fluorine (F) and bromine (Br) content*
- [4] CEN/TS 15414-1, *Solid recovered fuels — Determination of moisture content using the oven dry method — Part 1: Determination of total moisture by a reference method*
- [5] CEN/TS 15414-2, *Solid recovered fuels — Determination of moisture content using the oven dry method — Part 2: Determination of total moisture by a simplified method*
- [6] ISO 651:1975, *Solid-stem calorimeter thermometers*
- [7] ISO 652:1975, *Enclosed-scale calorimeter thermometers*
- [8] ISO 1770:1981, *Solid-stem general purpose thermometers*
- [9] ISO 1771:1981, *Enclosed-scale general purpose thermometers*
- [10] ISO 1928, *Solid mineral fuels — Determination of gross calorific value by the bomb calorimetric method and calculation of net calorific value*
- [11] ISO 5725-5, *Accuracy (trueness and precision) of measurement methods and results — Part 5: Alternative methods for the determination of the precision of a standard measurement method*

British Standards Institution (BSI)

BSI is the national body responsible for preparing British Standards and other standards-related publications, information and services.

BSI is incorporated by Royal Charter. British Standards and other standardization products are published by BSI Standards Limited.

About us

We bring together business, industry, government, consumers, innovators and others to shape their combined experience and expertise into standards-based solutions.

The knowledge embodied in our standards has been carefully assembled in a dependable format and refined through our open consultation process. Organizations of all sizes and across all sectors choose standards to help them achieve their goals.

Information on standards

We can provide you with the knowledge that your organization needs to succeed. Find out more about British Standards by visiting our website at bsigroup.com/standards or contacting our Customer Services team or Knowledge Centre.

Buying standards

You can buy and download PDF versions of BSI publications, including British and adopted European and international standards, through our website at bsigroup.com/shop, where hard copies can also be purchased.

If you need international and foreign standards from other Standards Development Organizations, hard copies can be ordered from our Customer Services team.

Subscriptions

Our range of subscription services are designed to make using standards easier for you. For further information on our subscription products go to bsigroup.com/subscriptions.

With **British Standards Online (BSOL)** you'll have instant access to over 55,000 British and adopted European and international standards from your desktop. It's available 24/7 and is refreshed daily so you'll always be up to date.

You can keep in touch with standards developments and receive substantial discounts on the purchase price of standards, both in single copy and subscription format, by becoming a **BSI Subscribing Member**.

PLUS is an updating service exclusive to BSI Subscribing Members. You will automatically receive the latest hard copy of your standards when they're revised or replaced.

To find out more about becoming a BSI Subscribing Member and the benefits of membership, please visit bsigroup.com/shop.

With a **Multi-User Network Licence (MUNL)** you are able to host standards publications on your intranet. Licences can cover as few or as many users as you wish. With updates supplied as soon as they're available, you can be sure your documentation is current. For further information, email bsmusales@bsigroup.com.

BSI Group Headquarters

389 Chiswick High Road London W4 4AL UK

Revisions

Our British Standards and other publications are updated by amendment or revision.

We continually improve the quality of our products and services to benefit your business. If you find an inaccuracy or ambiguity within a British Standard or other BSI publication please inform the Knowledge Centre.

Copyright

All the data, software and documentation set out in all British Standards and other BSI publications are the property of and copyrighted by BSI, or some person or entity that owns copyright in the information used (such as the international standardization bodies) and has formally licensed such information to BSI for commercial publication and use. Except as permitted under the Copyright, Designs and Patents Act 1988 no extract may be reproduced, stored in a retrieval system or transmitted in any form or by any means – electronic, photocopying, recording or otherwise – without prior written permission from BSI. Details and advice can be obtained from the Copyright & Licensing Department.

Useful Contacts:

Customer Services

Tel: +44 845 086 9001

Email (orders): orders@bsigroup.com

Email (enquiries): cservices@bsigroup.com

Subscriptions

Tel: +44 845 086 9001

Email: subscriptions@bsigroup.com

Knowledge Centre

Tel: +44 20 8996 7004

Email: knowledgecentre@bsigroup.com

Copyright & Licensing

Tel: +44 20 8996 7070

Email: copyright@bsigroup.com



...making excellence a habit.™