

Heating systems in buildings — Method for calculation of the design heat load

ICS 91.140.10

National foreword

This British Standard is the UK implementation of EN 12831:2003. Together with BS EN 12828:2003 and BS EN 14336:2004, it supersedes BS 5449:1990, which is withdrawn.

The UK participation in its preparation was entrusted to Technical Committee RHE/24, Central heating installations.

A list of organizations represented on this committee can be obtained on request to its secretary.

Informative guidance on the use of BS EN 12831:2003 in the UK for forced circulation hot water central heating systems, which may include those for domestic hot water, with heat requirements up to a total of 45 kW is given in National Annex NA (informative).

This publication does not purport to include all the necessary provisions of a contract. Users are responsible for its correct application.

Compliance with a British Standard cannot confer immunity from legal obligations.

This British Standard was published under the authority of the Standards Policy and Strategy Committee on 22 August 2008

© The British Standards Institution 2013.
Published by BSI Standards Limited 2013

Amendments/corrigenda issued since publication

Date	Comments
31 January 2009	Revision of National Annex NA (informative). Update to supersession details and additional information added to National foreword.
30 September 2013	Revision of National Annex NA (informative)

EUROPEAN STANDARD

EN 12831

NORME EUROPÉENNE

EUROPÄISCHE NORM

March 2003

ICS 91.140.10

English version

Heating systems in buildings - Method for calculation of the design heat load

Systèmes de chauffage dans les bâtiments - Méthode de calcul des déperditions calorifiques de base

Heizungsanlagen in Gebäuden - Verfahren zur Berechnung der Norm-Heizlast

This European Standard was approved by CEN on 6 July 2002.

CEN members are bound to comply with the CEN/CENELEC Internal Regulations which stipulate the conditions for giving this European Standard the status of a national standard without any alteration. Up-to-date lists and bibliographical references concerning such national standards may be obtained on application to the Management Centre or to any CEN member.

This European Standard exists in three official versions (English, French, German). A version in any other language made by translation under the responsibility of a CEN member into its own language and notified to the Management Centre has the same status as the official versions.

CEN members are the national standards bodies of Austria, Belgium, Czech Republic, Denmark, Finland, France, Germany, Greece, Hungary, Iceland, Ireland, Italy, Luxembourg, Malta, Netherlands, Norway, Portugal, Slovak Republic, Spain, Sweden, Switzerland and United Kingdom.



EUROPEAN COMMITTEE FOR STANDARDIZATION
COMITÉ EUROPÉEN DE NORMALISATION
EUROPÄISCHES KOMITEE FÜR NORMUNG

Management Centre: rue de Stassart, 36 B-1050 Brussels

Contents

	page
FOREWORD	4
INTRODUCTION	5
1 - SCOPE	5
2 - NORMATIVE REFERENCES	6
3 - TERMS, DEFINITIONS AND SYMBOLS	7
3.1 - TERMS AND DEFINITIONS	7
3.2 - SYMBOLS AND UNITS	9
4 - PRINCIPLE OF THE CALCULATION METHOD	11
5 - GENERAL CONSIDERATIONS	12
5.1 - CALCULATION PROCEDURE FOR A HEATED SPACE	12
5.2 - CALCULATION PROCEDURE FOR A BUILDING ENTITY OR A BUILDING	12
5.3 - CALCULATION PROCEDURE FOR THE SIMPLIFIED METHOD	12
6 - DATA REQUIRED	14
6.1 - CLIMATIC DATA	14
6.2 - INTERNAL DESIGN TEMPERATURE	14
6.3 - BUILDING DATA	14
7 - TOTAL DESIGN HEAT LOSS FOR A HEATED SPACE - BASIC CASES	16
7.1 - DESIGN TRANSMISSION HEAT LOSS	16
7.1.1 - Heat losses directly to the exterior - heat loss coefficient $H_{T,ie}$	16
7.1.2 - Heat losses through unheated space - heat loss coefficient $H_{T,iue}$	17
7.1.3 - Heat losses through the ground - heat loss coefficient $H_{T,ig}$	18
7.1.4 - Heat losses to or from spaces heated at a different temperature - heat loss coefficient $H_{T,ij}$	24
7.2 - DESIGN VENTILATION HEAT LOSS	25
7.2.1 - Hygiene - air flow rate $\dot{V}_{min,i}$	27
7.2.2 - Infiltration through building envelope - air flow rate $\dot{V}_{inf,i}$	27
7.2.3 - Air flow rates due to ventilation systems	28
7.3 - INTERMITTENTLY HEATED SPACES	29
8 - DESIGN HEAT LOAD	30
8.1 - DESIGN HEAT LOAD FOR A HEATED SPACE.....	30
8.2 - DESIGN HEAT LOAD FOR A BUILDING ENTITY OR A BUILDING.....	30
9 - SIMPLIFIED CALCULATION METHOD	31
9.1 - DESIGN HEAT LOSS FOR A HEATED SPACE.....	32
9.1.1 - Total design heat loss	32
9.1.2 - Design transmission heat loss.....	32
9.1.3 - Design ventilation heat loss.....	32
9.2 - DESIGN HEAT LOAD FOR A HEATED SPACE	33
9.2.1 - Total design heat load	33
9.2.2 - Intermittently heated spaces	33
9.3 - TOTAL DESIGN HEAT LOAD FOR A BUILDING ENTITY OR A BUILDING.....	34
ANNEX A (INFORMATIVE) BASIC PARAMETERS ON HUMAN COMFORT IN INTERIOR	

THERMAL ENVIRONMENTS - SIGNIFICANCE OF OPERATIVE TEMPERATURE IN HEAT LOAD CALCULATIONS	35
ANNEX B (INFORMATIVE) INSTRUCTIONS FOR DESIGN HEAT LOSS CALCULATION FOR SPECIAL CASES	38
B.1 CEILING HEIGHT AND LARGE ENCLOSURE	38
B.2 BUILDINGS WHERE AIR TEMPERATURE AND MEAN RADIANT TEMPERATURE DIFFER SIGNIFICANTLY	39
ANNEX C (INFORMATIVE) EXAMPLE OF A DESIGN HEAT LOAD CALCULATION.....	41
C.1 - GENERAL DESCRIPTION OF THE CALCULATION EXAMPLE.....	41
C.1.1 - Sample building description.....	41
C.1.2 - Plans of the building	41
C.1.3 - Calculations performed.....	41
C.2 - PLANS OF THE BUILDING.....	42
C.3 - SAMPLE CALCULATION	50
C.3.1 - General data	50
C.3.2 - Data on materials.....	51
C.3.3 - Data on building elements	52
C.3.4 - Data on thermal bridges	54
C.3.5 - Room transmission heat losses.....	56
C.3.6 - Room ventilation heat losses.....	58
C.3.7 - Heating-up capacity.....	61
C.3.8 - Total heat load	62
C.3.9 - Room heat load with the simplified method	64
C.3.10 - Total heat load with the simplified method	65
ANNEX D (NORMATIVE) DEFAULT VALUES FOR THE CALCULATIONS IN CLAUSES 6 TO 9...66	66
D.1 - CLIMATIC DATA (SEE 6.1).....	66
D.2 - INTERNAL DESIGN TEMPERATURE (SEE 6.2)	66
D.3 - BUILDING DATA (SEE 6.3).....	67
D.4 - DESIGN TRANSMISSION HEAT LOSS.....	67
D.4.1 - Heat losses directly to the exterior - $H_{T,ie}$ (see 7.1.1).....	67
D.4.2 - Heat losses through unheated space - $H_{T,iue}$ (see 7.1.2).....	69
D.4.3 - Heat losses through the ground - $H_{T,ig}$ (see 7.1.3).....	70
D.4.4 - Heat losses to or from spaces heated at a different temperature - $H_{T,ij}$ (see 7.1.4).....	70
D.5 - DESIGN VENTILATION HEAT LOSS - $H_{V,1}$	70
D.5.1 - Minimum external air exchange rate - n_{min} (see 7.2.1 and 9.1.3).....	70
D.5.2 - Air exchange rate - n_{50} (see 7.2.2).....	71
D.5.3 - Shielding coefficient - e (see 7.2.2).....	71
D.5.4 - Height correction factor - ϵ (see 7.2.2).....	72
D.6 - INTERMITTENTLY HEATED SPACES (SEE 7.3 AND 9.2.2).....	72
D.7 - SIMPLIFIED CALCULATION METHOD (SEE 9).....	74
D.7.1 - Restrictions of use.....	74
D.7.2 - Temperature correction factor - f_k (see 9.1.2).....	74
D.7.3 - Temperature correction factor - $f_{\Delta\theta}$ (see 9.1.1).....	75
BIBLIOGRAPHY	76

FOREWORD

This document EN 12831:2003 has been prepared by Technical Committee CEN/TC 228 "Heating systems in buildings", the secretariat of which is held by DS.

This European Standard shall be given the status of a national standard, either by publication of an identical text or by endorsement, at the latest by September 2003, and conflicting national standards shall be withdrawn at the latest by March 2004.

This document includes one normative annex, annex D, and three informative annexes, annex A, B and C.

This document includes a Bibliography.

The subjects covered by CEN/TC 228 are the following:

- Design of heating systems (water based, electrical etc.);
- Installation of heating systems;
- Commissioning of heating systems;
- Instructions for operation, maintenance and use of heating systems;
- Methods for calculation of the design heat loss and heat loads;
- Methods for calculation of the energy performance of heating systems.

Heating systems also include the effect of attached systems such as hot water production systems.

All these standards are systems standards, i.e. they are based on requirements addressed to the system as a whole and not dealing with requirements to the products within the system.

Where possible, reference is made to other European or International Standards, a.o product standards. However, use of products complying with relevant product standards is no guarantee of compliance with the system requirements.

The requirements are mainly expressed as functional requirements, i.e. requirements dealing with the function of the system and not specifying shape, material, dimensions or the like.

The guidelines describe ways to meet the requirements, but other ways to fulfil the functional requirements might be used if fulfilment can be proved.

Heating systems differ among the member countries due to climate, traditions and national regulations. In some cases requirements are given as classes so national or individual needs may be accommodated.

In cases where the standards contradict with national regulations, the latter should be followed.

According to the CEN/CENELEC Internal Regulations, the national standards organizations of the following countries are bound to implement this European Standard: Austria, Belgium, Czech Republic, Denmark, Finland, France, Germany, Greece, Hungary, Iceland, Ireland, Italy, Luxembourg, Malta, Netherlands, Norway, Portugal, Slovak Republic, Spain, Sweden, Switzerland and the United Kingdom.

INTRODUCTION

This standard specifies a calculation method for calculation of the heat supply needed under standard design conditions in order to make sure that the required internal design temperature is obtained.

This standard describes calculation of the design heat load:

- on a room by room or heated space by heated space approach, for the purpose of dimensioning the heat emitters;
- on a whole building or building entity approach, for the purpose of dimensioning the heat supply.

This standard also provides a simplified calculation method.

The set values and factors required for calculation of the heat load should be determined in a national annex to this standard. Annex D tabulates all factors, which may be determined on a national level and gives default values for cases where no national values are available.

1 - SCOPE

This standard specifies methods for calculating the design heat loss and the design heat load for basic cases at the design conditions.

Basic cases comprise all buildings:

- with a limited room height (not exceeding 5 m);
- assumed to be heated to steady state conditions under the design conditions.

Examples of such buildings are: residential buildings; office and administration buildings; schools; libraries; hospitals; recreational buildings; prisons; buildings used in the catering trade; department stores and other buildings used for business purposes; industrial buildings.

In the annexes, information is also given for dealing with the following special cases:

- high ceiling buildings or large enclosure;
- buildings where air temperature and mean radiant temperature differ significantly.

2 - NORMATIVE REFERENCES

This European Standard incorporates by dated or undated reference, provisions from other publications. These normative references are cited at the appropriate places in the text, and the publications are listed hereafter. For dated references, subsequent amendments to or revisions of any of these publications apply to this European Standard only when incorporated in it by amendment or revision. For undated references the latest edition of the publication referred to applies (including amendments).

EN 673

Glass in building - Determination of thermal transmittance (U value) - Calculation method.

EN ISO 6946

Building components and building elements - Thermal resistance and thermal transmittance - Calculation method (ISO 6946:1996).

EN ISO 10077-1

Thermal performance of windows, doors and shutters - Calculation of thermal transmittance - Part 1: Simplified method (ISO 10077-1:2000).

prEN ISO 10077-2

Thermal performance of windows, doors and shutters - Calculation of thermal transmittance - Part 2: Numerical method for frames (ISO/DIS 10077-2:1998).

EN ISO 10211-1

Thermal bridges in building construction - Heat flows and surface temperatures - Part 1: General calculation methods (ISO 10211-1:1995).

EN ISO 10211-2

Thermal bridges in building construction - Calculation of heat flows and surface temperatures - Part 2: Linear thermal bridges (ISO 10211-2:2001).

EN ISO 10456

Building materials and products - Procedures for determining declared and design thermal values (ISO 10456:1999).

EN 12524

Building materials and products - Hygrothermal properties - Tabulated design values.

EN ISO 13370

Thermal performance of buildings - Heat transfer via the ground - Calculation methods (ISO 13370:1998).

EN ISO 14683

Thermal bridges in building construction - Linear thermal transmittance - Simplified methods and default values (ISO 14683:1999).

3 - TERMS, DEFINITIONS AND SYMBOLS

3.1 - TERMS AND DEFINITIONS

For the purposes of this European Standard, the following terms and definitions apply.

3.1.1

basement

a room is considered as a basement if more than 70% of its external wall area is in contact with the ground

3.1.2

building element

building component such as a wall, a floor

3.1.3

building entity

total volume of heated spaces served by one common heating system (i.e. single dwellings) where the heat supplied to each single dwelling can be centrally controlled by the occupant

3.1.4

design temperature difference

difference between the internal design temperature and the external design temperature

3.1.5

design heat loss

quantity of heat per unit time leaving the building to the external environment under specified design conditions

3.1.6

design heat loss coefficient

design heat loss per unit of temperature difference

3.1.7

design heat transfer

heat transferred inside a building entity or a building

3.1.8

design heat load

required heat flow necessary to achieve the specified design conditions

3.1.9

design transmission heat loss of the considered space

heat loss to the exterior as a result of thermal conduction through the surrounding surfaces, as well as heat transfer between heated spaces inside a building

3.1.10

design ventilation heat loss of the considered space

heat loss to the exterior by ventilation and infiltration through the building envelope and the heat transferred by ventilation from one heated space to another heated space

3.1.11

external air temperature

temperature of the air outside the building

3.1.12

external design temperature

external air temperature which is used for calculation of the design heat losses

3.1.13

heated space

space which is to be heated to the specified internal design temperature

3.1.14

internal air temperature

temperature of the air inside the building

3.1.15

internal design temperature

operative temperature at the centre of the heated space (between 0,6 and 1,6 m height) used for calculation of the design heat losses

3.1.16

annual mean external temperature

mean value of the external temperature during the year

3.1.17

operative temperature

arithmetic average of the internal air temperature and the mean radiant temperature

3.1.18

thermal zone

part of the heated space with a given set-point temperature and with negligible spatial variations of the internal temperature

3.1.19

unheated space

space which is not part of the heated space

3.1.20

ventilation system

system to provide specified air flow rates

3.1.21

zone

group of spaces having similar thermal characteristics

3.2 - SYMBOLS AND UNITS

For the purposes of this European Standard, the following symbols, units and indices apply.

Table 1 - Symbols and units

Symbol	Name	Unit
a, b, c, f	various correction factors	-
A	area	m^2
B'	characteristic parameter	m
c_p	specific heat capacity at constant pressure	J/(kg·K)
d	thickness	m
e_i	shielding coefficient	-
e_k, e_l	correction factors for the exposure	-
G_w	ground water correction factor	-
h	surface coefficient of heat transfer	W/($m^2 \cdot K$)
H	heat loss coefficient, heat transfer coefficient	W/K
l	length	m
n	external air exchange rate	h^{-1}
n_{50}	air exchange rate at 50 Pa pressure difference between the inside and the outside of the building	h^{-1}
P	perimeter of the floor slab	m
Q	quantity of heat, quantity of energy	J
T	thermodynamic temperature on the Kelvin scale	K
U	thermal transmittance	W/($m^2 \cdot K$)
v	wind velocity	m/s
V	volume	m^3
\dot{V}	air flow rate	m^3/s
ε	height correction factor	-
Φ	heat loss, heat power	W
Φ_{HL}	heat load	W
η	efficiency	%
λ	conductivity	W/(m·K)
θ	temperature on the Celsius scale	°C
ρ	density of air at $\theta_{int,i}$	kg/ m^3
Ψ	linear thermal transmittance	W/(m·K)

Table 2 – Indices

a : air	h : height	o : operative
A : building entity	inf : infiltration	r : mean radiant
bdg,B : building	int : internal	RH : reheat
bf : basement floor	i, j : heated space	su : supply
bw : basement wall	k : building element	T : transmission
e : external, exterior	l : thermal bridge	tb : type of building
env : envelope	m : annual mean	u : unheated space
equiv : equivalent	mech : mechanical	V : ventilation
ex : exhaust	min : minimum	$\Delta\theta$: higher indoor temperature
g : ground	nat : natural	W : water, window/wall

4 - PRINCIPLE OF THE CALCULATION METHOD

The calculation method for the basic cases is based on the following hypotheses:

- the temperature distribution (air temperature and design temperature) is assumed to be uniform;
- the heat losses are calculated in steady state conditions assuming constant properties, such as values for temperature, characteristics of building elements, etc.

The procedure for basic cases can be used for the majority of buildings:

- with a ceiling height not exceeding 5 m;
- heated or assumed to be heated at a specified steady state temperature;
- where the air temperature and the operative temperature are assumed to be of the same value.

In poorly insulated buildings and/or during heating-up periods with emission systems with a high convection heat transfer, e.g. air heating, or large heating surfaces with significant radiation components, e.g. floor or ceiling heaters, there may be significant differences between the air temperature and the operative temperature, as well as a deviation from a uniform temperature distribution over the room, which could lead to substantial deviation from the basic case. These cases shall be considered as special cases (see annex B). The case of a non-uniform temperature distribution can also be considered in 7.1.4.

Initially, the design heat losses are calculated. These results are then used to determine the design heat load.

For the calculation of the design heat losses of a heated space, the following components shall be considered:

- the design transmission heat loss, which is the heat loss to the exterior as a result of thermal conduction through the surrounding surfaces, as well as heat transfer between heated spaces due to the fact, that adjacent heated spaces may be heated, or conventionally assumed to be heated, at different temperatures. For example, adjacent rooms belonging to another apartment can be assumed to be heated at a fixed temperature corresponding to an unoccupied apartment;
- the design ventilation heat loss, which is the heat loss to the exterior by ventilation or by infiltration through the building envelope and the heat transferred by ventilation from one heated space to another heated space inside the building.

5 - GENERAL CONSIDERATIONS

5.1 - CALCULATION PROCEDURE FOR A HEATED SPACE

The steps of the calculation procedure for a heated space are as follows (see Figure 1):

- a) determine the value of the external design temperature and the annual mean external temperature;
- b) specify the status of each space (heated or unheated) and the values of the internal design temperature of each heated space;
- c) determine the dimensional and thermal characteristics of all building elements for each heated and unheated space;
- d) calculate the design transmission heat loss coefficient and multiply by the design temperature difference to obtain the design transmission heat loss of the heated space;
- e) calculate the design ventilation heat loss coefficient and multiply by the design temperature difference to obtain the design ventilation heat loss of the heated space;
- f) obtain the total design heat loss of the heated space by adding the design transmission heat loss and the design ventilation heat loss;
- g) calculate the heating-up capacity of the heated space, i.e. additional power required to compensate for the effects of intermittent heating;
- h) obtain the total design heat load of the heated space by adding the total design heat loss and the heating-up capacity.

5.2 - CALCULATION PROCEDURE FOR A BUILDING ENTITY OR A BUILDING

For sizing of the heat supply, e.g. a heat exchanger or a heat generator, the total design heat load of the building entity or the building shall be calculated. The calculation procedure is based on the results of the heated space by heated space calculation.

The steps of the calculation procedure for a building entity or a building are as follows:

- a) sum up the design transmission heat losses of all heated spaces without considering the heat transferred inside the specified system boundaries to obtain the total design transmission heat loss of the building entity or the building;
- b) sum up the design ventilation heat losses of all heated spaces without considering the heat transferred inside the specified system boundaries to obtain the total design ventilation heat loss of the building entity or the building;
- c) obtain the total design heat loss of the building entity or the building by adding the total design transmission heat loss and the total design ventilation heat loss;
- d) sum up the heating-up capacities of all heated spaces to obtain the total heating-up capacity of the building entity or the building required to compensate for the effects of intermittent heating;
- e) obtain the total design heat load of the building entity or the building by adding the total design heat loss and the total heating-up capacity.

5.3 - CALCULATION PROCEDURE FOR THE SIMPLIFIED METHOD

The calculation procedure for the simplified method follows the procedure given in 5.1 and 5.2. However, simplifications are made when determining the different heat losses. The simplified method is described in clause 9.

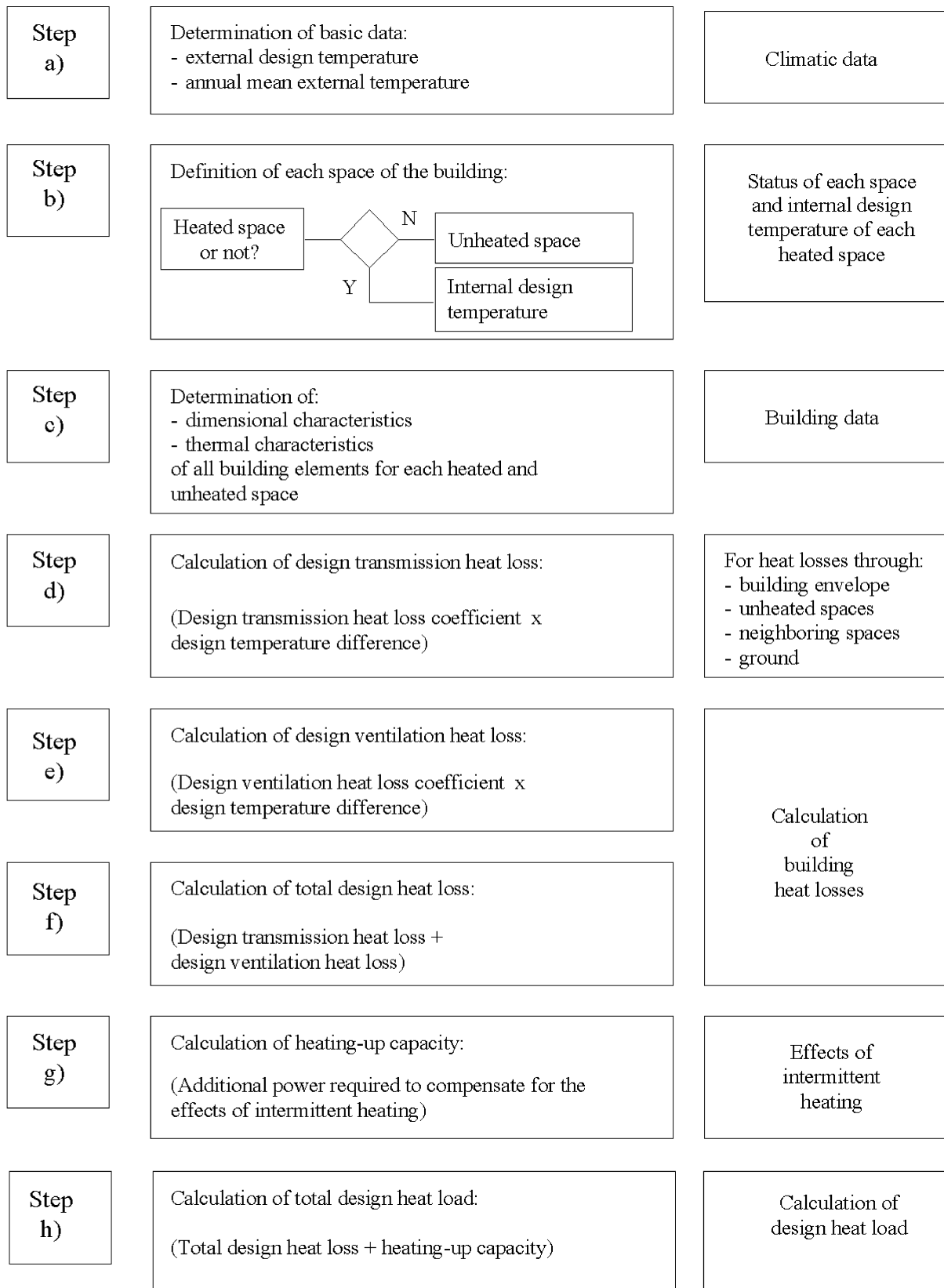

Figure 1 - Calculation procedure for a heated space

6 - DATA REQUIRED

Annex D of this standard provides information on the appropriate data required for performing the heat load calculation. Where no national annex to this standard is available as a reference providing national values, the necessary information may be obtained from the default values stated in annex D.

The following data is required.

6.1 - CLIMATIC DATA

For this calculation method, the following climatic data is used:

- external design temperature, θ_e , for the design heat loss calculation to the exterior;
- annual mean external temperature, $\theta_{m,e}$, for the heat loss calculation to the ground.

Calculations have to be made in order to determine the design climatic data. As there is not yet a European agreement on the calculation and presentation of these climatic parameters, defined and published national values shall be used.

For calculation and presentation of the external design temperature, national or public bodies can refer to prEN ISO 15927-5. Another possibility for determining the external design temperature is to use the lowest two-day mean temperature, which has been registered ten times over a twenty-year period.

6.2 - INTERNAL DESIGN TEMPERATURE

The internal temperature used for calculation of the design heat loss, is the internal design temperature, θ_{int} . For the basic case, the operative temperature and the internal air temperature are assumed to be of the same value. In cases where this does not apply, annex B gives more information.

Information on the internal design temperature and values to be used shall be given in a national annex to this standard or in the project specifications. Where no national annex is available, default values are given in D.2.

6.3 - BUILDING DATA

The input data required for a room by room calculation are listed below:

- V_i internal air volume of each room (heated and unheated spaces) in cubic metres (m^3);
- A_k area of each building element in square metres (m^2);
- U_k thermal transmittance of each building element in Watts per square metres per Kelvin ($W/m^2 \cdot K$);
- Ψ_l linear thermal transmittance of each linear thermal bridge in Watts per metres per Kelvin ($W/m \cdot K$);
- l_l length of each linear thermal bridge in metres (m).

Calculation of the thermal transmittance (U-value) of building elements shall be carried out with respect to the boundary conditions and the material characteristics which are defined and recommended in the (pr)EN-standards. An overview of all parameters, which are used when calculating U-values of building elements, together with reference to the appropriate standard to be applied, is given in the following table. National values can be used if typical local conditions or regulations apply. Such values shall be defined and published at a national level.

Table 3 – Parameters for calculation of U-values

Symbol and unit	NAME OF PARAMETER	Reference of related (pr)EN-standard
R_{si} ($m^2 \cdot K/W$)	Internal surface resistance	EN ISO 6946
R_{se} ($m^2 \cdot K/W$)	External surface resistance	EN ISO 6946
λ ($W/m \cdot K$)	Thermal conductivity (homogeneous materials): <ul style="list-style-type: none"> determination of declared and design values (procedure) tabulated design values (safe values) ground types local placement and humidity conditions (country dependent) 	EN ISO 10456 EN 12524 EN ISO 13370 national standards
R ($m^2 \cdot K/W$)	Thermal resistance of (non) homogeneous materials	EN ISO 6946
R_a ($m^2 \cdot K/W$)	Thermal resistance of air layers or cavities: <ul style="list-style-type: none"> unventilated, slightly and well ventilated air layers in coupled and double windows 	EN ISO 6946 EN ISO 10077-1
U ($W/m^2 \cdot K$)	Thermal transmittance: <ul style="list-style-type: none"> general calculation method windows, doors (calculated and tabulated values) frames (numerical method) glazing 	EN ISO 6946 EN ISO 10077-1 prEN ISO 10077-2 EN 673
Ψ ($W/m \cdot K$)	Linear thermal transmittance (thermal bridges): <ul style="list-style-type: none"> detailed calculation (numerical - 3D) detailed calculation (2D) simplified calculation 	EN ISO 10211-1 EN ISO 10211-2 EN ISO 14683
χ (W/K)	Point-thermal transmittance (3D thermal bridges)	EN ISO 10211-1

For determining the ventilation heat loss coefficient, the following quantities are used as appropriate:

n_{min} minimum external air exchange rate per hour (h^{-1});

n_{50} air exchange rate at 50 Pa pressure difference between inside and outside per hour (h^{-1});

\dot{V}_{inf} infiltration air flow rate due to the untightness of the building envelope, taking into account wind and stack-effects, in cubic metres per second (m^3/s);

\dot{V}_{su} supply air flow rate in cubic metres per second (m^3/s);

\dot{V}_{ex} exhaust air flow rate in cubic metres per second (m^3/s);

η_V efficiency of the heat recovery system on exhaust air.

The choice of building dimensions used shall be clearly stated. Whatever the choice, the losses through the total external wall area shall be included. Internal, external or overall internal dimensions can be used according to EN ISO 13789, but the choice of building dimensions shall be clearly stated and kept the same throughout the calculation. Be aware that EN ISO 13789 does not cover a room by room approach.

7 – TOTAL DESIGN HEAT LOSS FOR A HEATED SPACE - BASIC CASES

The total design heat loss for a heated space (i), Φ_i , is calculated as follows:

$$\Phi_i = \Phi_{T,i} + \Phi_{V,i} \quad [\text{W}] \quad (1)$$

where:

- $\Phi_{T,i}$ = design transmission heat loss for heated space (i) in Watts (W);
 $\Phi_{V,i}$ = design ventilation heat loss for heated space (i) in Watts (W).

7.1 - DESIGN TRANSMISSION HEAT LOSS

The design transmission heat loss for a heated space (i), $\Phi_{T,i}$, is calculated as follows:

$$\Phi_{T,i} = (H_{T,ie} + H_{T,iue} + H_{T,ig} + H_{T,ij}) \cdot (\theta_{int,i} - \theta_e) \quad [\text{W}] \quad (2)$$

where:

- $H_{T,ie}$ = transmission heat loss coefficient from heated space (i) to the exterior (e) through the building envelope in Watts per Kelvin (W/K);
 $H_{T,iue}$ = transmission heat loss coefficient from heated space (i) to the exterior (e) through the unheated space (u) in Watts per Kelvin (W/K);
 $H_{T,ig}$ = steady state ground transmission heat loss coefficient from heated space (i) to the ground (g) in Watts per Kelvin (W/K);
 $H_{T,ij}$ = transmission heat loss coefficient from heated space (i) to a neighbouring heated space (j) heated at a significantly different temperature, i.e. an adjacent heated space within the building entity or a heated space of an adjacent building entity, in Watts per Kelvin (W/K);
 $\theta_{int,i}$ = internal design temperature of heated space (i) in degrees Celcius (°C);
 θ_e = external design temperature in degrees Celcius (°C).

7.1.1 - HEAT LOSSES DIRECTLY TO THE EXTERIOR - HEAT LOSS COEFFICIENT $H_{T,IE}$

The design transmission heat loss coefficient from heated space (i) to the exterior (e), $H_{T,ie}$, is due to all building elements and linear thermal bridges separating the heated space from the external environment, such as walls, floor, ceiling, doors, windows. $H_{T,ie}$ is calculated as follows:

$$H_{T,ie} = \sum_k A_k \cdot U_k \cdot e_k + \sum_l \Psi_l \cdot l_l \cdot e_l \quad [\text{W/K}] \quad (3)$$

where:

- A_k = area of building element (k) in square metres (m²);
 e_k, e_l = correction factors for the exposure taking into account climatic influences such as different insulation, moisture absorption of building elements, wind velocity and temperature, provided these influences have not already been taken into account in the determination of the U-values (EN ISO 6946).

e_k and e_l shall be determined on a national basis. In the absence of national values, default values are given in D.4.1;

- U_k = thermal transmittance of building element (k) in Watts per square metres per Kelvin ($W/m^2 \cdot K$), calculated according to:
- EN ISO 6946 (for opaque elements);
 - EN ISO 10077-1 (for doors and windows);
 - or from indications given in European Technical Approvals;
- l = length of the linear thermal bridge (l) between the interior and the exterior in metres (m);
- Ψ_l = linear thermal transmittance of the linear thermal bridge (l) in Watts per metre per Kelvin ($W/m \cdot K$). Ψ_l shall be determined in one of the following two ways:
- for a rough assessment, use of tabulated values provided in EN ISO 14683;
 - or calculated according to EN ISO 10211-2.

Tabulated values of Ψ_l in EN ISO 14683 are given for a whole building approach and not for a room by room approach. The proportional split of the Ψ_l -value between rooms is at the discretion of the system designer.

Non-linear thermal bridges are not taken into account in this calculation.

Simplified method for linear transmission heat losses

The following simplified method can be used for calculation of the linear transmission heat losses:

$$U_{kc} = U_k + \Delta U_{tb} \quad [W/m^2 \cdot K] \quad (4)$$

where:

- U_{kc} = corrected thermal transmittance of building element (k), taking into account linear thermal bridges, in Watts per square metres per Kelvin ($W/m^2 \cdot K$);
- U_k = thermal transmittance of building element (k) in Watts per square metres per Kelvin ($W/m^2 \cdot K$);
- ΔU_{tb} = correction factor in Watts per square metres per Kelvin ($W/m^2 \cdot K$), depending on the type of building element. Default values are given in D.4.1.

7.1.2 - HEAT LOSSES THROUGH UNHEATED SPACE - HEAT LOSS COEFFICIENT $H_{T,iue}$

If there is an unheated space (u) between the heated space (i) and the exterior (e), the design transmission heat loss coefficient, $H_{T,iue}$, from the heated space to the exterior is calculated as follows:

$$H_{T,iue} = \sum_k A_k \cdot U_k \cdot b_u + \sum_l \Psi_l \cdot l \cdot b_u \quad [W/K] \quad (5)$$

where:

- b_u = temperature reduction factor taking into account the difference between temperature of the unheated space and external design temperature.

The temperature reduction factor, b_u , can be determined by one of the following three methods:

- a) if the temperature of the unheated space, θ_u , under design conditions is specified or calculated, b_u is given by:

$$b_u = \frac{\theta_{\text{int},i} - \theta_u}{\theta_{\text{int},i} - \theta_e} \quad [-] \quad (6)$$

b) if θ_u is unknown, b_u is given by:

$$b_u = \frac{H_{ue}}{H_{iu} + H_{ue}} \quad [-] \quad (7)$$

where:

- H_{iu} = heat loss coefficient from the heated space (i) to the unheated space (u) in Watts per Kelvin (W/K), taking into account:
- the transmission heat losses (from the heated space to the unheated space);
 - the ventilation heat losses (air flow rate between the heated space and the unheated space);
- H_{ue} = heat loss coefficient from the unheated space (u) to the exterior (e) in Watts per Kelvin (W/K), taking into account:
- the transmission heat losses (to the exterior and to the ground);
 - the ventilation heat losses (between the unheated space and the exterior).

c) Reference to a national annex to this standard, providing values of b_u for each case. In the absence of national values, default values are given in D.4.2.

7.1.3 - HEAT LOSSES THROUGH THE GROUND - HEAT LOSS COEFFICIENT $H_{T,ig}$

The rate of heat loss through floors and basement walls, directly or indirectly in contact with the ground, depends on several factors. These include the area and exposed perimeter of the floor slab, the depth of a basement floor beneath ground level, and the thermal properties of the ground.

For the purpose of this standard, the rate of heat loss to the ground can be calculated according to EN ISO 13370:

- in a detailed manner;
- or in a simplified manner described below. In this case, the heat losses due to thermal bridges are not taken into account.

The design steady state ground transmission heat loss coefficient, $H_{T,ig}$, from heated space (i) to the ground (g) is calculated as follows:

$$H_{T,ig} = f_{g1} \cdot f_{g2} \cdot \left(\sum_k A_k \cdot U_{\text{equiv},k} \right) \cdot G_w \quad [\text{W/K}] \quad (8)$$

where:

- f_{g1} = correction factor taking into account the influence from annual variation of the external temperature. This factor shall be determined on a national basis. In the absence of national values, default value is given in D.4.3;

f_{g2} = temperature reduction factor taking into account the difference between annual mean external temperature and external design temperature, given by:

$$f_{g2} = \frac{\theta_{\text{int},i} - \theta_{\text{m,e}}}{\theta_{\text{int},i} - \theta_e};$$

A_k = area of building element (k) in contact with the ground in square metres (m²);

$U_{\text{equiv},k}$ = equivalent thermal transmittance of building element (k) in Watts per square metres per Kelvin (W/m²·K), determined according to the floor-typology (see Figures 3 to 6 and Tables 4 to 7);

G_w = correction factor taking into account the influence from ground water. If the distance between the assumed water table and the basement floor level (floor slab) is less than 1 m, this influence has to be taken into account. This factor can be calculated according to EN ISO 13370 and shall be determined on a national basis. In the absence of national values, default values are given in D.4.3.

Figures 3 to 6 and Tables 4 to 7 provide values of $U_{\text{equiv},k}$ for the different floor-typologies distinguished in EN ISO 13370, as a function of the U-value of the building elements and the characteristic parameter, B' . In these figures and tables, the thermal conductivity of the ground is assumed to be $\lambda_g = 2.0 \text{ W/m}\cdot\text{K}$ and the effects of edge insulation are not taken into account.

The characteristic parameter, B' , is given by (see Figure 2):

$$B' = \frac{A_g}{0,5 \cdot P} \quad [\text{m}] \quad (9)$$

where:

A_g = area of the considered floor slab in square metres (m²). For a whole building, A_g is the total ground floor area. For part of a building, e.g. a building entity in a row of houses, A_g is the ground floor area under consideration;

P = perimeter of the considered floor slab in metres (m). For a whole building, P is the total perimeter of the building. For part of a building, e.g. a building entity in a row of houses, P includes only the length of external walls separating the heated space under consideration from the external environment.

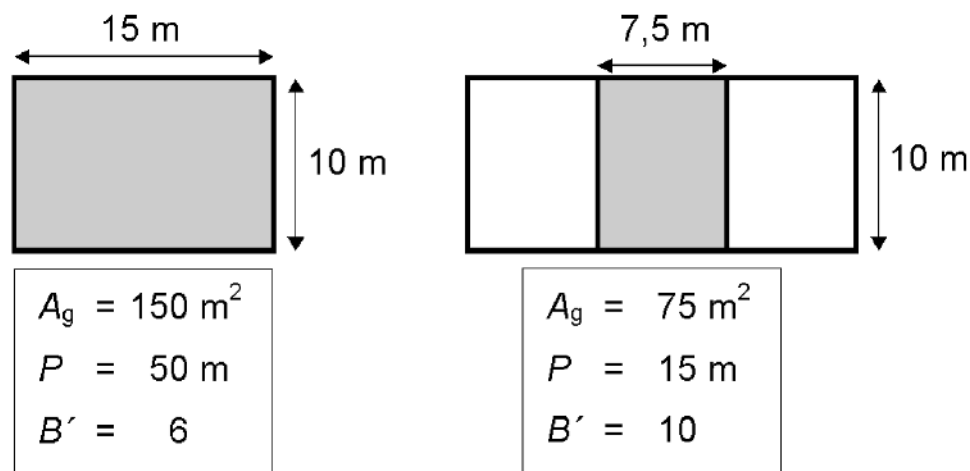

Figure 2 – Determination of the characteristic parameter B'

In EN ISO 13370, the parameter B' is calculated for the building as a whole. For a room by room approach, B' shall be determined for each room in one of the following three ways:

- for all rooms without external walls separating the heated space under consideration from the external environment, use the B' -value calculated for the building as a whole;
- for all rooms with well insulated floor ($U_{\text{floor}} < 0,5 \text{ W/m}^2\cdot\text{K}$), use the B' -value calculated for the building as a whole;
- for all other rooms, calculate separately the B' -value on a room by room approach (conservative calculation).

Floor slab on ground level

The equivalent thermal transmittance of the basement floor is given in Figure 3 and Table 4, as a function of the thermal transmittance of the floor and the characteristic parameter B' .

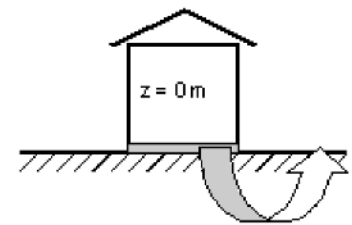
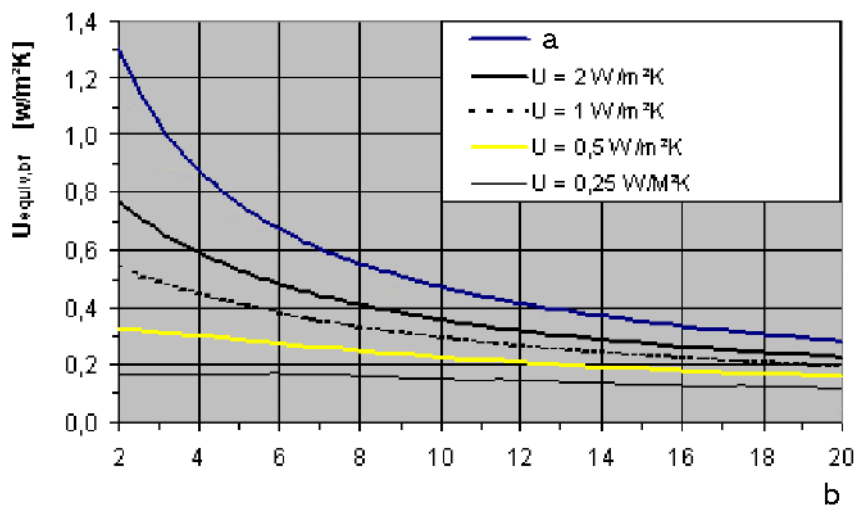

$U_{\text{equiv,bf}}$

Key

a Concrete floor (no insulation)

b B' -value [m]

Figure 3 - $U_{\text{equiv,bf}}$ -value of the basement floor for floor slab on ground level, as a function of thermal transmittance of the floor and the B' -value

Table 4 - $U_{\text{equiv,bf}}$ -value of the basement floor for floor slab on ground level, as a function of thermal transmittance of the floor and the B' -value

B' -value m	$U_{\text{equiv,bf}}$ (for $z = 0$ metre) $\text{W/m}^2\cdot\text{K}$				
	no insulation	$U_{\text{floor}} = 2,0 \text{ W/m}^2\cdot\text{K}$	$U_{\text{floor}} = 1,0 \text{ W/m}^2\cdot\text{K}$	$U_{\text{floor}} = 0,5 \text{ W/m}^2\cdot\text{K}$	$U_{\text{floor}} = 0,25 \text{ W/m}^2\cdot\text{K}$
2	1,30	0,77	0,55	0,33	0,17
4	0,88	0,59	0,45	0,30	0,17
6	0,68	0,48	0,38	0,27	0,17
8	0,55	0,41	0,33	0,25	0,16
10	0,47	0,36	0,30	0,23	0,15
12	0,41	0,32	0,27	0,21	0,14
14	0,37	0,29	0,24	0,19	0,14
16	0,33	0,26	0,22	0,18	0,13
18	0,31	0,24	0,21	0,17	0,12
20	0,28	0,22	0,19	0,16	0,12

Heated basement with floor slab beneath ground level

The basis for calculation of the equivalent thermal transmittance for a heated basement partly or fully beneath ground level is similar to that for the floor slab on ground level, but involves two types of building elements, i.e. $U_{\text{equiv,bf}}$ for floor elements and $U_{\text{equiv,bw}}$ for wall elements.

The equivalent thermal transmittance for floor elements is given in Figures 4 to 5 and Tables 5 to 6, as a function of the thermal transmittance of the floor and the characteristic parameter B' . The equivalent thermal transmittance for wall elements is given in Figure 6 and Table 7, as a function of the thermal transmittance of the wall and the depth beneath ground level.

For a heated basement partly beneath ground level, heat losses directly to the exterior from those parts of the basement which are above ground level, are determined according to 7.1.1 with no influences from the ground and considering only those parts of the building elements which are above ground level.

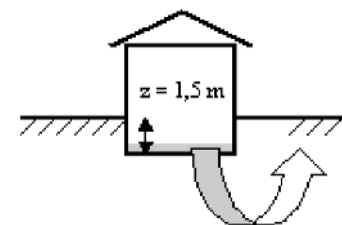
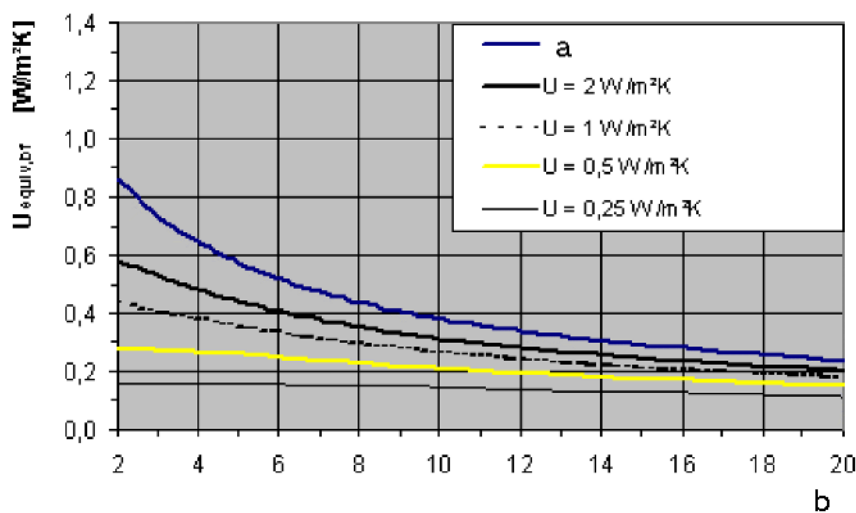

$U_{\text{equiv,bf}}$

Key

a Concrete floor (no insulation)

b B' -value [m]

Figure 4 - $U_{\text{equiv,bf}}$ -value for floor elements of a heated basement with floor slab 1,5 m beneath ground level, as a function of thermal transmittance of the floor and the B' -value

Table 5 - $U_{\text{equiv,bf}}$ -value for floor elements of a heated basement with floor slab 1,5 m beneath ground level, as a function of thermal transmittance of the floor and the B' -value

B' -value m	$U_{\text{equiv,bf}}$ (for $z = 1,5$ metres) $\text{W/m}^2\cdot\text{K}$				
	no insulation	$U_{\text{floor}} = 2,0 \text{ W/m}^2\cdot\text{K}$	$U_{\text{floor}} = 1,0 \text{ W/m}^2\cdot\text{K}$	$U_{\text{floor}} = 0,5 \text{ W/m}^2\cdot\text{K}$	$U_{\text{floor}} = 0,25 \text{ W/m}^2\cdot\text{K}$
2	0,86	0,58	0,44	0,28	0,16
4	0,64	0,48	0,38	0,26	0,16
6	0,52	0,40	0,33	0,25	0,15
8	0,44	0,35	0,29	0,23	0,15
10	0,38	0,31	0,26	0,21	0,14
12	0,34	0,28	0,24	0,19	0,14
14	0,30	0,25	0,22	0,18	0,13
16	0,28	0,23	0,20	0,17	0,12
18	0,25	0,22	0,19	0,16	0,12
20	0,24	0,20	0,18	0,15	0,11

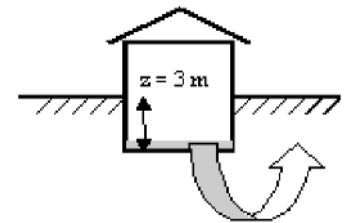
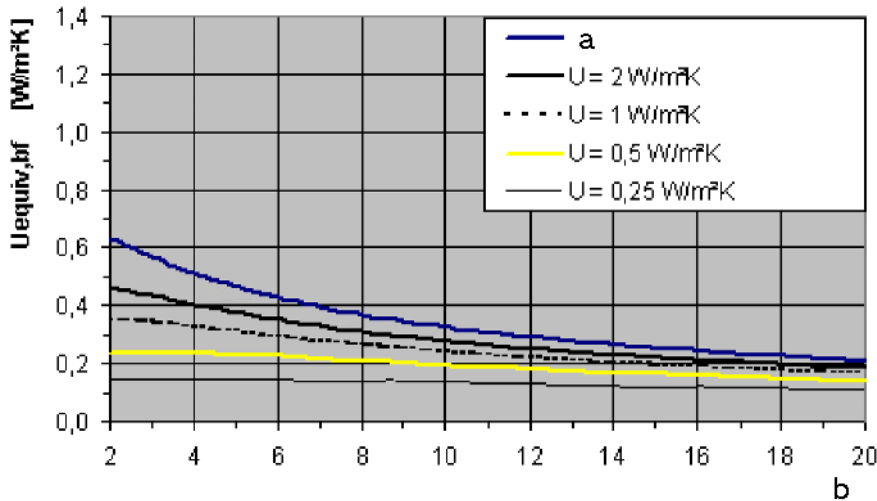

$U_{\text{equiv,bf}}$

Key

- a Concrete floor (no insulation)
- b B' -value [m]

Figure 5 - $U_{\text{equiv,bf}}$ -value for floor elements of a heated basement with floor slab 3,0 m beneath ground level, as a function of thermal transmittance of the floor and the B' -value

Table 6 - $U_{\text{equiv,bf}}$ -value for floor elements of a heated basement with floor slab 3,0 m beneath ground level, as a function of thermal transmittance of the floor and the B -value

B -value m	$U_{\text{equiv,bf}}$ (for $z = 3,0$ metres) $\text{W/m}^2\cdot\text{K}$				
	no insulation	$U_{\text{floor}} = 2,0 \text{ W/m}^2\cdot\text{K}$	$U_{\text{floor}} = 1,0 \text{ W/m}^2\cdot\text{K}$	$U_{\text{floor}} = 0,5 \text{ W/m}^2\cdot\text{K}$	$U_{\text{floor}} = 0,25 \text{ W/m}^2\cdot\text{K}$
2	0,63	0,46	0,35	0,24	0,14
4	0,51	0,40	0,33	0,24	0,14
6	0,43	0,35	0,29	0,22	0,14
8	0,37	0,31	0,26	0,21	0,14
10	0,32	0,27	0,24	0,19	0,13
12	0,29	0,25	0,22	0,18	0,13
14	0,26	0,23	0,20	0,17	0,12
16	0,24	0,21	0,19	0,16	0,12
18	0,22	0,20	0,18	0,15	0,11
20	0,21	0,18	0,16	0,14	0,11

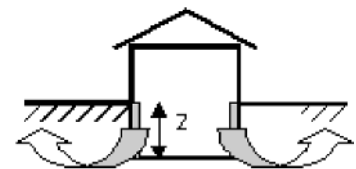
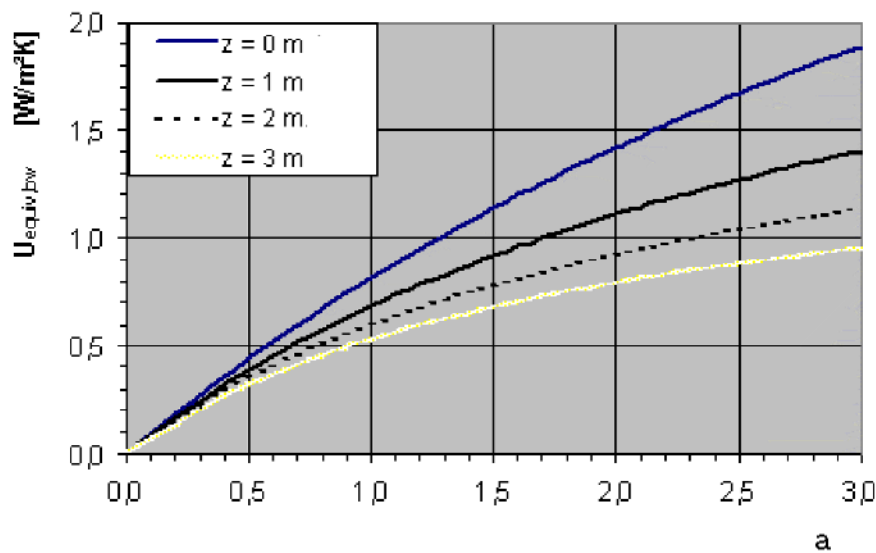

$U_{\text{equiv,bw}}$

Key

a U-value of the walls [$\text{W/m}^2\cdot\text{K}$]

Figure 6 - $U_{\text{equiv,bw}}$ -value for wall elements of a heated basement, as a function of thermal transmittance of the walls and the depth z beneath ground level

Table 7 - $U_{\text{equiv,bw}}$ -value for wall elements of a heated basement, as a function of thermal transmittance of the walls and the depth z beneath ground level

U_{wall} $\text{W/m}^2\text{K}$	$U_{\text{equiv,bw}}$ $\text{W/m}^2\text{K}$			
	$z = 0 \text{ m}$	$z = 1 \text{ m}$	$z = 2 \text{ m}$	$z = 3 \text{ m}$
0,00	0,00	0,00	0,00	0,00
0,50	0,44	0,39	0,35	0,32
0,75	0,63	0,54	0,48	0,43
1,00	0,81	0,68	0,59	0,53
1,25	0,98	0,81	0,69	0,61
1,50	1,14	0,92	0,78	0,68
1,75	1,28	1,02	0,85	0,74
2,00	1,42	1,11	0,92	0,79
2,25	1,55	1,19	0,98	0,84
2,50	1,67	1,27	1,04	0,88
2,75	1,78	1,34	1,09	0,92
3,00	1,89	1,41	1,13	0,96

Unheated basement

The transmission heat loss coefficient of the floor separating a heated space from an unheated basement is calculated according to 7.1.2. The U-value of the floor is calculated in the same way as for a floor with no influences from the ground, i.e. equation 8 (and thus factors f_{g1} , f_{g2} and G_w) does not apply.

Suspended floor

The transmission heat loss coefficient of a suspended floor is calculated according to 7.1.2. The U-value of the suspended floor is calculated in the same way as for a floor with no influences from the ground, i.e. equation 8 (and thus factors f_{g1} , f_{g2} and G_w) does not apply.

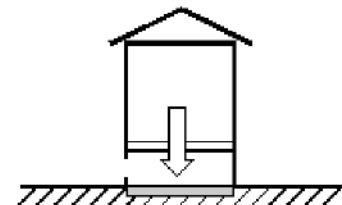

7.1.4 - HEAT LOSSES TO OR FROM SPACES HEATED AT A DIFFERENT TEMPERATURE - HEAT LOSS COEFFICIENT $H_{T,ij}$

$H_{T,ij}$ expresses the heat transferred by transmission from a heated space (i) to a neighbouring heated space (j) heated at a significantly different temperature. This can be an adjacent room within the building entity (e.g. bathroom, medical examination room, storeroom), a room belonging to an adjacent building entity, (e.g. apartment) or a room belonging to an adjacent building which may be unheated.

$H_{T,ij}$ is calculated as follows:

$$H_{T,ij} = \sum_k f_{ij} \cdot A_k \cdot U_k \quad [\text{W/K}] \quad (10)$$

where:

f_{ij} = temperature reduction factor taking into account the difference between

temperature of the adjacent space and external design temperature, given by:

$$f_{ij} = \frac{\theta_{\text{int},i} - \theta_{\text{adjacent space}}}{\theta_{\text{int},i} - \theta_e}$$

In the absence of national values of the temperature of adjacent heated spaces, default values are given in D.4.4. In a national annex to this standard, the clause corresponding to D.4.4 may include information on the effect of vertical temperature gradients;

- A_k = area of building element (k) in square metres (m²);
 U_k = thermal transmittance of building element (k) in Watts per square metres per Kelvin (W/m²·K).

The effects of thermal bridges are not taken into account in this calculation.

7.2 - DESIGN VENTILATION HEAT LOSS

The design ventilation heat loss, $\Phi_{V,i}$, for a heated space (i) is calculated as follows:

$$\Phi_{V,i} = H_{V,i} \cdot (\theta_{\text{int},i} - \theta_e) \quad [\text{W}] \quad (11)$$

where:

- $H_{V,i}$ = design ventilation heat loss coefficient in Watts per Kelvin (W/K);
 $\theta_{\text{int},i}$ = internal design temperature of heated space (i) in degrees Celsius (°C);
 θ_e = external design temperature in degrees Celsius (°C).

The design ventilation heat loss coefficient, $H_{V,i}$, of a heated space (i) is calculated as follows:

$$H_{V,i} = \dot{V}_i \cdot \rho \cdot c_p \quad [\text{W/K}] \quad (12)$$

where:

- \dot{V}_i = air flow rate of heated space (i) in cubic metres per second (m³/s);
 ρ = density of air at $\theta_{\text{int},i}$ in kilograms per cubic metre (kg/m³);
 c_p = specific heat capacity of air at $\theta_{\text{int},i}$ in kilo Joule per kilogram per Kelvin (kJ/kg·K).

Assuming constant ρ and c_p , equation (12) is reduced to:

$$H_{V,i} = 0,34 \cdot \dot{V}_i \quad [\text{W/K}] \quad (13)$$

where \dot{V}_i is now expressed in cubic metres per hour (m³/h).

The calculation procedure for determining the relevant air flow rate, \dot{V}_i , depends upon the case considered, i.e. with or without ventilation system.

Without ventilation system:

In the absence of ventilation systems, it is assumed that the supplied air has the thermal characteristics of external air. Therefore, the heat loss is proportional to the difference between internal design temperature and external air temperature.

The value of the air flow rate of heated space (i), which is used for calculating the design ventilation heat loss coefficient, is the maximum of the infiltration air flow rate, $\dot{V}_{inf,i}$, due to air flow through cracks and joints in the building envelope and the minimum air flow rate, $\dot{V}_{min,i}$, required for hygienic reasons:

$$\dot{V}_i = \max (\dot{V}_{inf,i} , \dot{V}_{min,i}) \quad [m^3/h] \quad (14)$$

where:

$\dot{V}_{inf,i}$ shall be determined according to 7.2.2

$\dot{V}_{min,i}$ shall be determined according to 7.2.1

With ventilation system:

If there is a ventilation system, the supplied air does not necessarily have the thermal characteristics of external air, for instance:

- when heat recovery systems are used;
- when the external air is pre-heated centrally;
- when the supplied air comes from adjacent spaces.

In these cases, a temperature reduction factor is introduced taking into account the difference between supply air temperature and external design temperature.

In systems with a surplus exhaust air flow rate, this air is replaced by external air entering through the building envelope, which also has to be taken into account.

The equation for determining the air flow rate of heated space (i), which is used for calculating the design ventilation heat loss coefficient, is as follows:

$$\dot{V}_i = \dot{V}_{inf,i} + \dot{V}_{su,i} \cdot f_{V,i} + \dot{V}_{mech,inf,i} \quad [m^3/h] \quad (15)$$

where:

$\dot{V}_{inf,i}$ = infiltration air flow rate of heated space (i) in cubic metres per hour (m³/h);

$\dot{V}_{su,i}$ = supply air flow rate of heated space (i) in cubic metres per hour (m³/h);

$\dot{V}_{mech,inf,i}$ = surplus exhaust air flow rate of heated space (i) in cubic metres per hour (m³/h), determined according to 7.2.3.2;

$f_{V,i}$ = temperature reduction factor, given by:

$$f_{v,i} = \frac{\theta_{\text{int},i} - \theta_{\text{su},i}}{\theta_{\text{int},i} - \theta_e}$$

$\theta_{\text{su},i}$ = supply air temperature into the heated space (i), (either from the central air heating system, from a neighbouring heated or unheated space, or from the external environment), in degrees Celsius ($^{\circ}\text{C}$). If a heat recovery system is used, $\theta_{\text{su},i}$ can be calculated from the efficiency of the heat recovery system. $\theta_{\text{su},i}$ may be higher or lower than the internal air temperature.

\dot{V}_i shall be equal to or greater than the minimum air exchange rate according to 7.2.1.

A method for determining the air flow rates in buildings in a precise manner is given in prEN 13465.

Simplified methods for determining the air flow rates are given in 7.2.2 and 7.2.3.

7.2.1 - HYGIENE - AIR FLOW RATE $\dot{V}_{\text{min},i}$

For reasons of hygiene, a minimum air flow rate is required. Where no national information is available, the minimum air flow rate, $\dot{V}_{\text{min},i}$, of a heated space (i) can be determined as follows:

$$\dot{V}_{\text{min},i} = n_{\text{min}} \cdot V_i \quad [\text{m}^3/\text{h}] \quad (16)$$

where:

n_{min} = minimum external air exchange rate per hour (h^{-1});

V_i = volume of heated space (i) in cubic metres (m^3), calculated on the basis of internal dimensions.

The minimum external air exchange rate shall be determined in a national annex to this standard or by specification. Where no national annex is available, default values are given in D.5.1. Further information on air flow rates can be obtained from CR 1752.

The air exchange rates given in D.5.1 are based on internal dimensions. If external dimensions are used in the calculation, the air exchange rate values given in D.5.1 shall be multiplied by the ratio between internal and external volume of the space (as an approximation, the default value of this ratio = 0,8).

For open fireplaces, be aware of higher ventilation rates required for combustion air.

7.2.2 - INFILTRATION THROUGH BUILDING ENVELOPE - AIR FLOW RATE $\dot{V}_{\text{inf},i}$

The infiltration air flow rate, $\dot{V}_{\text{inf},i}$, of heated space (i), induced by wind and stack effect on the building envelope, can be calculated from:

$$\dot{V}_{\text{inf},i} = 2 \cdot V_i \cdot n_{50} \cdot e_i \cdot \varepsilon_i \quad [\text{m}^3/\text{h}] \quad (17)$$

where:

n_{50} = air exchange rate per hour (h^{-1}), resulting from a pressure difference of 50 Pa between

the inside and the outside of the building, including the effects of air inlets;

e_i = shielding coefficient;

ε_i = height correction factor, which takes into account the increase in wind velocity with the height of the space from ground level.

A factor 2 is introduced in equation (17) because the n_{50} -value is given for the whole building. The calculation must take into account the worst case, where all infiltration air enters on one side of the building.

The value of $\dot{V}_{inf,i}$ shall be equal to or greater than zero.

Values for n_{50} shall be given in a national annex to this standard. Where no national annex is available, default values for different building construction types are given in D.5.2.

Values for the shielding coefficient and the height correction factor shall be given in a national annex to this standard. Where no national annex is available, default values are given in D.5.3 and D.5.4.

7.2.3 - AIR FLOW RATES DUE TO VENTILATION SYSTEMS

7.2.3.1 Supply air flow rate $\dot{V}_{su,i}$

If the ventilation system is unknown, the ventilation heat loss is calculated as for an installation without a ventilation system.

If the ventilation system is known, the supply air flow rate of heated space (i), $\dot{V}_{su,i}$, is determined by sizing of the ventilation system and is given by the ventilation system designer.

If the supplied air comes from (an) adjacent room(s), it has the thermal characteristics of air in this(-ese) room(s). If the supplied air enters the room via ducts, it is generally preheated. In both cases, the air flow path shall be defined and the appropriate air flow rates shall be accounted for in the affected rooms.

7.2.3.2 Surplus exhaust air flow rate $\dot{V}_{mech,inf,i}$

The surplus exhaust air in any ventilation system is replaced by external air entering through the building envelope.

If the surplus exhaust air flow rate is not otherwise determined, it can be calculated for the whole building as follows:

$$\dot{V}_{mech,inf} = \max(\dot{V}_{ex} - \dot{V}_{su}, 0) \quad [\text{m}^3/\text{h}] \quad (18)$$

where

\dot{V}_{ex} = exhaust air flow rate for the whole building in cubic metres per hour (m^3/h);

\dot{V}_{su} = supply air flow rate for the whole building in cubic metres per hour (m^3/h).

In residential buildings, the supply air flow rate for the whole building is often set to be zero.

Initially, $\dot{V}_{mech,inf}$ is determined for the whole building. Subsequently, distribution of this external air flow

rate on each space in the building is calculated from the permeability¹ of each space in proportion to the permeability of the whole building. If no values on permeability are available, distribution of the external air flow rate can be calculated in a simplified manner in proportion to the volume of each space, given by:

$$\dot{V}_{\text{mech,inf},i} = \dot{V}_{\text{mech,inf}} \cdot \frac{V_i}{\sum V_i} \quad [\text{m}^3/\text{h}] \quad (19)$$

Where V_i is the volume of space (i). This equation can be used correspondingly for determining the supply air flow rate of each space if only the supply air flow rate for the whole building is given.

7.3 - INTERMITTENTLY HEATED SPACES

Intermittently heated spaces require heating-up capacity to attain the required internal design temperature after setback within a given time. The heating-up capacity depends on the following factors:

- the heat capacity of the building elements;
- the reheat time;
- the temperature drop during setback;
- the characteristics of the control system.

A heating-up capacity may not always be necessary, for example if:

- the control system is able to cancel the setback during the coldest days;
- the heat losses (ventilation losses) can be reduced during the setback period.

The heating-up capacity shall be agreed with the client.

The heating-up capacity can be determined in a detailed manner by dynamic calculation procedures.

In the following cases, a simplified calculation method, given below, can be used to determine the heating-up capacity required for the heat generator and the heat emitters:

- for residential buildings:
 - the period of restriction (night setback) is within 8 h;
 - the building construction is not light (such as wood frame construction).
- for non-residential buildings:
 - the period of restriction is within 48 h (weekend-setback);
 - the period of occupancy during working days is greater than 8 h per day;
 - the internal design temperature is between 20°C and 22°C.

For heat emitters with a high thermal mass, be aware that longer reheat times are required.

Simplified method to determine the heating-up capacity

¹ The expression «permeability» considers the effects of air tightness of the building envelope and the designed natural openings of the building

The heating-up capacity required to compensate for the effects of intermittent heating, $\Phi_{RH,i}$, in a heated space (i) is calculated as follows:

$$\Phi_{RH,i} = A_i \cdot f_{RH} \quad [W] \quad (20)$$

where:

- A_i = floor area of heated space (i) in square metres (m²);
- f_{RH} = correction factor depending on the reheat time and the assumed drop of the internal temperature during setback, in Watts per square metres (W/m²). This correction factor shall be given in a national annex to this standard. Where no national annex is available, default values are given in D.6. These default values do not apply to storage heating systems.

8 - DESIGN HEAT LOAD

The design heat load can be calculated for a heated space, for a building entity and for the building as a whole, in order to determine the heat load for sizing the heat emitter, the heat exchanger, the heat generator, etc.

8.1 - DESIGN HEAT LOAD FOR A HEATED SPACE

For a heated space (i), the design heat load, $\Phi_{HL,i}$, is calculated as follows:

$$\Phi_{HL,i} = \Phi_{T,i} + \Phi_{V,i} + \Phi_{RH,i} \quad [W] \quad (21)$$

where:

- $\Phi_{T,i}$ = transmission heat loss of heated space (i) in Watts (W);
- $\Phi_{V,i}$ = ventilation heat loss of heated space (i) in Watts (W);
- $\Phi_{RH,i}$ = heating-up capacity required to compensate for the effects of intermittent heating of heated space (i) in Watts (W).

8.2 - DESIGN HEAT LOAD FOR A BUILDING ENTITY OR A BUILDING

Calculation of the design heat load for a building entity or a building shall not take into account the heat transferred by transmission and ventilation within the heated envelope of the building entity, e.g. heat losses between apartments.

The design heat load for a building entity or a building, Φ_{HL} , is calculated as follows:

$$\Phi_{HL} = \sum \Phi_{T,i} + \sum \Phi_{V,i} + \sum \Phi_{RH,i} \quad [W] \quad (22)$$

where:

- $\sum \Phi_{T,i}$ = sum of transmission heat losses of all heated spaces excluding the heat transferred inside the building entity or the building, in Watts (W);
- $\sum \Phi_{V,i}$ = ventilation heat losses of all heated spaces excluding the heat transferred inside the building entity or the building, in Watts (W).

Equation 22 implies an overall building air flow rate. Since the air flow rate of each space is based on a worst case for each particular space, it is not appropriate to sum up the air flow rates of all spaces, because the worst case only occurs in part of the spaces simultaneously. The building air flow rate, $\Sigma \dot{V}_i$, is calculated as follows:

without ventilation system:

$$\Sigma \dot{V}_i = \max (0,5 \cdot \Sigma \dot{V}_{inf,j} , \Sigma \dot{V}_{min,i})$$

with ventilation system:

$$\Sigma \dot{V}_i = 0,5 \cdot \Sigma \dot{V}_{inf,j} + (1 - \eta_v) \cdot \Sigma \dot{V}_{su,j} + \Sigma \dot{V}_{mech,inf,j}$$

where η_v is the efficiency of the heat recovery system on exhaust air. In case of no heat recovery, $\eta_v = \text{zero}$.

For sizing the heat generator, a 24-h average is used. If the supplied air is heated by an adjacent system, the required heat load shall be accounted for there;

$\Sigma \Phi_{RH,i}$ = sum of heating-up capacities of all heated spaces required to compensate for the effects of intermittent heating, in Watts (W).

9 - SIMPLIFIED CALCULATION METHOD

Restrictions for use of this simplified calculation method shall be determined in a national annex to this standard. Where no national annex is available, information is given in D.7.

External dimensions shall be used as a basis for this calculation (see Figure 7). The basis for vertical dimensions is the distance from floor surface to floor surface (i.e. the thickness of the basement floor is not taken into account). When considering internal walls, the basis for horizontal dimensions is the distance to the centre of the wall (i.e. internal walls are considered up to half their thickness).

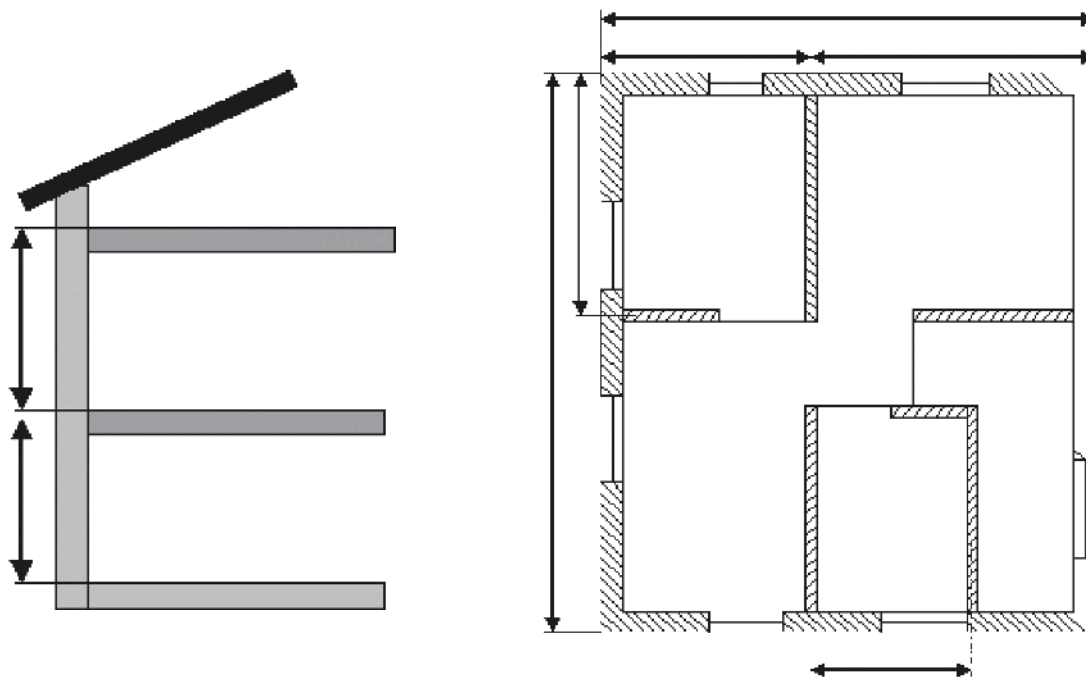

Figure 7 - Examples of external dimensions in the simplified calculation method

9.1 - DESIGN HEAT LOSS FOR A HEATED SPACE

9.1.1 - TOTAL DESIGN HEAT LOSS

The total design heat loss for a heated space (i), Φ_i , is calculated as follows:

$$\Phi_i = (\Phi_{T,i} + \Phi_{V,i}) \cdot f_{\Delta\theta,i} \quad [\text{W}] \quad (23)$$

where:

- $\Phi_{T,i}$ = design transmission heat loss for heated space (i) in Watts (W);
- $\Phi_{V,i}$ = design ventilation heat loss for heated space (i) in Watts (W);
- $f_{\Delta\theta,i}$ = temperature correction factor taking into account the additional heat loss of rooms heated at a higher temperature than the adjacent heated rooms, e.g. bathroom heated at 24°C.

The values of $f_{\Delta\theta,i}$ shall be given in a national annex to this standard. Where no national annex is available, default values are given in D.7.3.

9.1.2 - DESIGN TRANSMISSION HEAT LOSS

The design transmission heat loss, $\Phi_{T,i}$, for a heated space (i) is calculated as follows:

$$\Phi_{T,i} = \sum_k f_k \cdot A_k \cdot U_k \cdot (\theta_{int,i} - \theta_e) \quad [\text{W}] \quad (24)$$

where:

- f_k = temperature correction factor for building element (k), taking into account the difference between the temperature of the appropriate case considered and the external design temperature;
- A_k = area of building element (k) in square metres (m²);
- U_k = thermal transmittance of building element (k) in Watts per square metres per Kelvin (W/m²·K).

The values of the temperature correction factor, f_k , shall be given in a national annex to this standard. Where no national annex is available, default values are given in D.7.2.

9.1.3 - DESIGN VENTILATION HEAT LOSS

The design ventilation heat loss, $\Phi_{V,i}$, for a heated space (i) is calculated as follows:

$$\Phi_{V,i} = 0,34 \cdot \dot{V}_{min,i} \cdot (\theta_{int,i} - \theta_e) \quad [\text{W}] \quad (25)$$

where:

- $\dot{V}_{min,i}$ = minimum air flow rate of heated space (i) required for hygienic reasons, in cubic metres per hour (m³/h);

The minimum air flow rate of heated space (i) required for hygienic reasons is determined according

to:

$$\dot{V}_{\min,i} = n_{\min} \cdot V_i \quad [\text{m}^3/\text{h}] \quad (26)$$

where:

- n_{\min} = minimum external air exchange rate per hour (h^{-1});
 V_i = volume of heated space (i) in cubic metres (m^3), calculated on the basis of internal dimensions. As an approximation, this volume is 0,8 times the volume of the space calculated on the basis of external dimensions.

The values of the minimum external air exchange rate shall be given in a national annex to this standard. Where no national annex is available, default values are given in D.5.1.

NOTE In the case of mechanical ventilation systems, the mechanical air flow rates depend on the design and the sizing of the ventilation system. An equivalent external air exchange rate can be calculated for each mechanical ventilated room, based on the mechanical air flow rate (provided by the ventilation system designer), the temperature of supplied air and the air volume of each room.

9.2 – DESIGN HEAT LOAD FOR A HEATED SPACE

9.2.1 - TOTAL DESIGN HEAT LOAD

The total design heat load for a heated space (i), $\Phi_{\text{HL},i}$, is calculated as follows:

$$\Phi_{\text{HL},i} = \Phi_i + \Phi_{\text{RH},i} \quad [\text{W}] \quad (27)$$

where:

- Φ_i = total design heat loss of heated space (i) in Watts (W);
 $\Phi_{\text{RH},i}$ = heating-up capacity of heated space (i) in Watts (W).

9.2.2 - INTERMITTENTLY HEATED SPACES

The heating-up capacity required to compensate for the effects of intermittent heating, $\Phi_{\text{RH},i}$, in a heated space (i) is calculated as follows:

$$\Phi_{\text{RH},i} = A_i \cdot f_{\text{RH}} \quad [\text{W}] \quad (28)$$

where:

- A_i = floor area of heated space (i) in square metres (m^2);
 f_{RH} = reheat factor depending on the type of building, building construction, reheat time and assumed drop of the internal temperature during setback.

The values of the reheat factor, f_{RH} , shall be given in a national annex to this standard. Where no national annex is available, default values are given in D.6.

9.3 - TOTAL DESIGN HEAT LOAD FOR A BUILDING ENTITY OR A BUILDING

Calculation of the design heat load for a building entity or a building shall not take into account the heat transferred by transmission and ventilation within the heated envelope of the building entity, e.g. heat losses between apartments.

The design heat load for a building entity or a building, Φ_{HL} , is calculated as follows:

$$\Phi_{HL} = \Sigma \Phi_{T,i} + \Sigma \Phi_{V,i} + \Sigma \Phi_{RH,i} \quad [W] \quad (29)$$

where:

- $\Sigma \Phi_{T,i}$ = sum of transmission heat losses of all heated spaces excluding the heat transferred inside the building entity or the building;
- $\Sigma \Phi_{V,i}$ = ventilation heat losses of all heated spaces excluding the heat transferred inside the building entity or the building;
- $\Sigma \Phi_{RH,i}$ = sum of heating-up capacities of all heated spaces required to compensate for the effects of intermittent heating.

ANNEX A
(INFORMATIVE)

BASIC PARAMETERS ON HUMAN COMFORT IN INTERIOR THERMAL ENVIRONMENTS - SIGNIFICANCE OF OPERATIVE TEMPERATURE IN HEAT LOAD CALCULATIONS

The objective of calculating the design heat load is to ensure an acceptable internal thermal environment at design exterior temperature conditions. The internal design temperature for heating is given at a national level or in annex D. The following gives a method for determining an internal design temperature.

The design for the internal thermal environment should be based on EN ISO 7730, where the quality of the thermal environment is expressed by the PMV and PPD values.

The desired thermal quality in a space can be selected from the three categories A, B and C listed in Table A.1.

Table A.1 - Three categories of the internal thermal environment

Category of the internal thermal environment	Thermal state of the body as a whole	
	Predicted percentage of dissatisfied PPD	Predicted Mean Vote PMV
A	< 6%	- 0,2 < PMV < + 0,2
B	< 10%	- 0,5 < PMV < + 0,5
C	< 15%	- 0,7 < PMV < + 0,7

Figure A.1 shows the optimum operative temperature and the permissible temperature range as a function of clothing and activity for each of the three categories. The optimum operative temperature is the same for the three categories, while the permissible temperature range around the optimum operative temperature varies.

The operative temperature at all locations within the occupied heated space should at all times be within the permissible temperature range. This means that the permissible temperature range should cover both spatial and temporary variations, including fluctuations caused by the control system.

The internal design temperature for heating should be selected as the lower operative temperature of the permissible temperature range in the selected category. Assuming a certain clothing and activity, the internal design temperature can be found from Figure A.1, from Table A.2, or from EN ISO 7730.

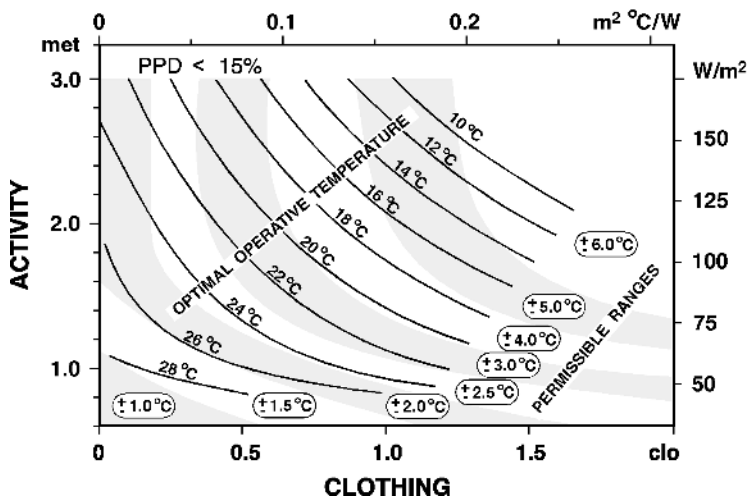
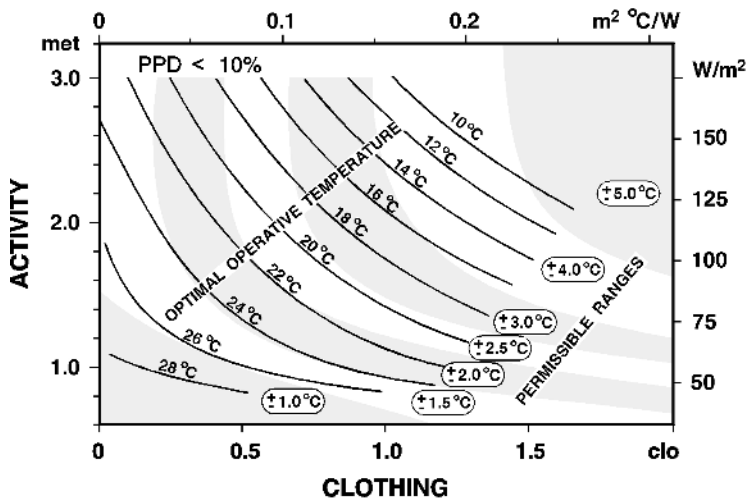
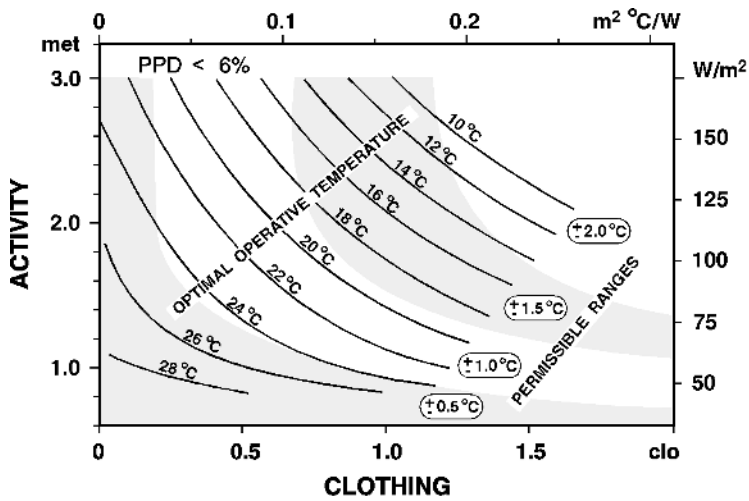

Figure A.1 - The optimum operative temperature as a function of clothing and activity for the three categories of the internal thermal environment. The three diagrams also show the permissible temperature range around the optimum operative temperature for the three categories.

The relative air velocity, v_{ar} , caused by body movement is estimated to be zero (m/s) for a metabolic rate, M, less than 1 (met) and 0,3 (m/s) for a metabolic rate, M, greater than 1 (met). The diagrams are determined according to a relative humidity of 50%.

Table A.2 – Internal design temperature

Type of building/space	Clothing, winter clo	Activity met	Category of internal thermal environment	Operative temperature, winter °C
Single office	1,0	1,2	A	21,0 - 23,0
			B	20,0 - 24,0
			C	19,0 - 25,0
Landscaped office	1,0	1,2	A	21,0 - 23,0
			B	20,0 - 24,0
			C	19,0 - 25,0
Conference room	1,0	1,2	A	21,0 - 23,0
			B	20,0 - 24,0
			C	19,0 - 25,0
Auditorium	1,0	1,2	A	21,0 - 23,0
			B	20,0 - 24,0
			C	19,0 - 25,0
Cafeteria/ Restaurant	1,0	1,2	A	21,0 - 23,0
			B	20,0 - 24,0
			C	19,0 - 25,0
Classroom	1,0	1,2	A	21,0 - 23,0
			B	20,0 - 24,0
			C	19,0 - 25,0
Nursery	1,0	1,2	A	21,0 - 23,0
			B	20,0 - 24,0
			C	19,0 - 25,0
Department store	1,0	1,6	A	17,5 - 20,5
			B	16,0 - 22,0
			C	15,0 - 23,0
Residential	1,0	1,2	A	21,0 - 23,0
			B	20,0 - 24,0
			C	19,0 - 25,0
Bathroom	0,2	1,6	A	24,5 - 25,5
			B	23,5 - 26,5
			C	23,0 - 27,0
Church	1,5	1,3	A	16,5 - 19,5
			B	15,0 - 21,0
			C	14,0 - 22,0
Museum/ Gallery	1,0	1,6	A	17,5 - 20,5
			B	16,0 - 22,0
			C	15,0 - 23,0

ANNEX B
(INFORMATIVE)

INSTRUCTIONS FOR DESIGN HEAT LOSS CALCULATION FOR SPECIAL CASES

B.1 Ceiling height and large enclosure

For the basic case, the heat losses are calculated assuming a uniform temperature of heated spaces with height of 5 m or less. This assumption is not valid if the room height exceeds 5 m, as the vertical air temperature gradient, which enhances the heat losses particularly through the roof, in this case cannot be neglected.

The vertical air temperature gradient increases with increasing room height and is also considerably dependent on the total design heat losses (insulation level of the building envelope and external design temperature) and on the type and location of heaters.

These effects should be taken into account by additions to the design heat losses. These additional design heat losses are best determined using the results of dynamic simulation calculations, as these take into account the individual properties of the building.

For buildings with design heat losses less than or equal to 60 Watts per square metre of floor area, the total design heat loss, Φ_i , for spaces with high ceilings can be corrected by introducing a ceiling height correction factor, $f_{h,i}$, as follows:

$$\Phi_i = (\Phi_{r,i} + \Phi_{v,i}) \cdot f_{h,i} \quad [W] \quad (30)$$

where values of $f_{h,i}$ are given in Table B.1.

Table B.1 - Ceiling height correction factor, $f_{h,i}$

Method of heating and type or location of heaters	$f_{h,i}$	
	Height of heated space	
	5 to 10 m	10 to 15 m
MAINLY RADIANT		
Warm floor	1	1
Warm ceiling (temperature level < 40°C)	1,15	not appropriate for this application
Medium and high temperature downward radiation from high level	1	1,15
MAINLY CONVECTIVE		
Natural warm air convection	1,15	not appropriate for this application
FORCED WARM AIR		
Cross flow at low level	1,30	1,60
Downward from high level	1,21	1,45
Medium and high temperature cross air flow from intermediate level	1,15	1,30

B.2 Buildings where air temperature and mean radiant temperature differ significantly

For the basic case, it is assumed that the air temperature, the mean radiant temperature and the operative temperature are of the same value. Therefore, the transmission and ventilation heat losses are calculated by using the operative temperature.

For spaces where there is a significant difference between the air temperature and the mean radiant temperature, heat loss calculations using the operative temperature leads to incorrect results.

For these cases, the transmission heat losses are still calculated using the operative temperature, but the ventilation heat losses should be calculated using the internal air temperature. Otherwise, calculation of the heat loss due to ventilation (infiltration) will give too high values for radiant heating systems and too low values for convective heating systems.

This shall be taken into account if the error on the calculated ventilation heat loss is more than 5 %.

For example, at a design temperature difference of 30 K, a difference between air temperature and operative temperature of 1,5 K corresponds to a 5 % difference in calculated ventilation heat loss. This corresponds to a 3 K difference between air temperature and mean radiant temperature.

For spaces where the average U-value of the outside window/wall satisfies the following expression, there is a need to correct for a difference between air temperature and operative temperature:

$$U_w > \frac{50}{\theta_{\text{int}} - \theta_e} \quad [\text{W/m}^2 \cdot \text{K}] \quad (31)$$

where:

- U_w = average U-value of window/wall in Watts per square metres per Kelvin ($\text{W/m}^2 \cdot \text{K}$);
- θ_{int} = internal design temperature in degrees Celsius ($^{\circ}\text{C}$);
- θ_e = external design temperature in degrees Celsius ($^{\circ}\text{C}$).

For these cases, the mean radiant temperature is calculated from the internal surface temperatures. Internal surface temperatures can be calculated for given U-values, internal design temperature, external design temperature and surface temperature of the heat emitters. If the calculated mean radiant temperature deviates more than 1,5 K from the internal design temperature, the heat loss due to ventilation can be calculated using the air temperature, θ_a , given by:

$$\theta_a = 2 \cdot \theta_o - \theta_r \quad [^{\circ}\text{C}] \quad (32)$$

where:

- θ_o = operative temperature in degrees Celsius ($^{\circ}\text{C}$);
- θ_r = mean radiant temperature in degrees Celsius ($^{\circ}\text{C}$).

In some industrial spaces where the air velocity exceeds 0,20 m/s, a more correct relation between operative temperature, air temperature and mean radiant temperature is given by:

$$\theta_o = F_B \cdot \theta_a + (1 - F_B) \cdot \theta_r \quad [^{\circ}\text{C}] \quad (33)$$

where:

BS EN 12831:2003 (E)
EN 12831:2003 (E)

$F_B = 0,5$	for air velocity less than 0,2 m/s;
$F_B = 0,6$	for air velocity between 0,2 m/s and 0,6 m/s;
$F_B = 0,7$	for air velocity greater than 0,6 m/s.

ANNEX C (INFORMATIVE)

EXAMPLE OF A DESIGN HEAT LOAD CALCULATION

C.1 - General description of the calculation example

C.1.1 - Sample building description

The sample calculation is performed on the "Vivaldi" house.

This house is a semi-detached house with a ground floor and a basement cellar. The west wall of the living room is in contact with the neighbouring house. The ground floor is raised 0,5 m above the ground level. The living room has a suspended floor. The rest of the ground floor is above the basement. In the basement there is a cellar, a garage and a heated hobby room.

The house has internal insulation.

C.1.2 - Plans of the building

Detailed plans and sections of the house are given in Figures C.1 to C.4. The structures and the thermal bridges are detailed in Figures C.5 to C.7. A second plan of the ground floor is given in Figure C.8, showing the external dimensions used for the calculation example with the simplified method.

C.1.3 - Calculations performed

The sample calculation is performed both with the detailed method and the simplified method. The detailed method is performed using internal dimensions. Data on thermal bridges correspond to internal dimensions.

Calculation of ventilation heat losses with the detailed method is performed for the following 3 different typical cases:

- natural ventilation only (opening windows);
- balanced ventilation system with air supplied at 12°C;
- only air extraction in the kitchen, bathroom and WC.

Calculation of transmission heat losses is independent of these options.

Calculation of transmission heat losses is detailed for one room only, both with the detailed method and the simplified method.

C.2 - Plans of the building

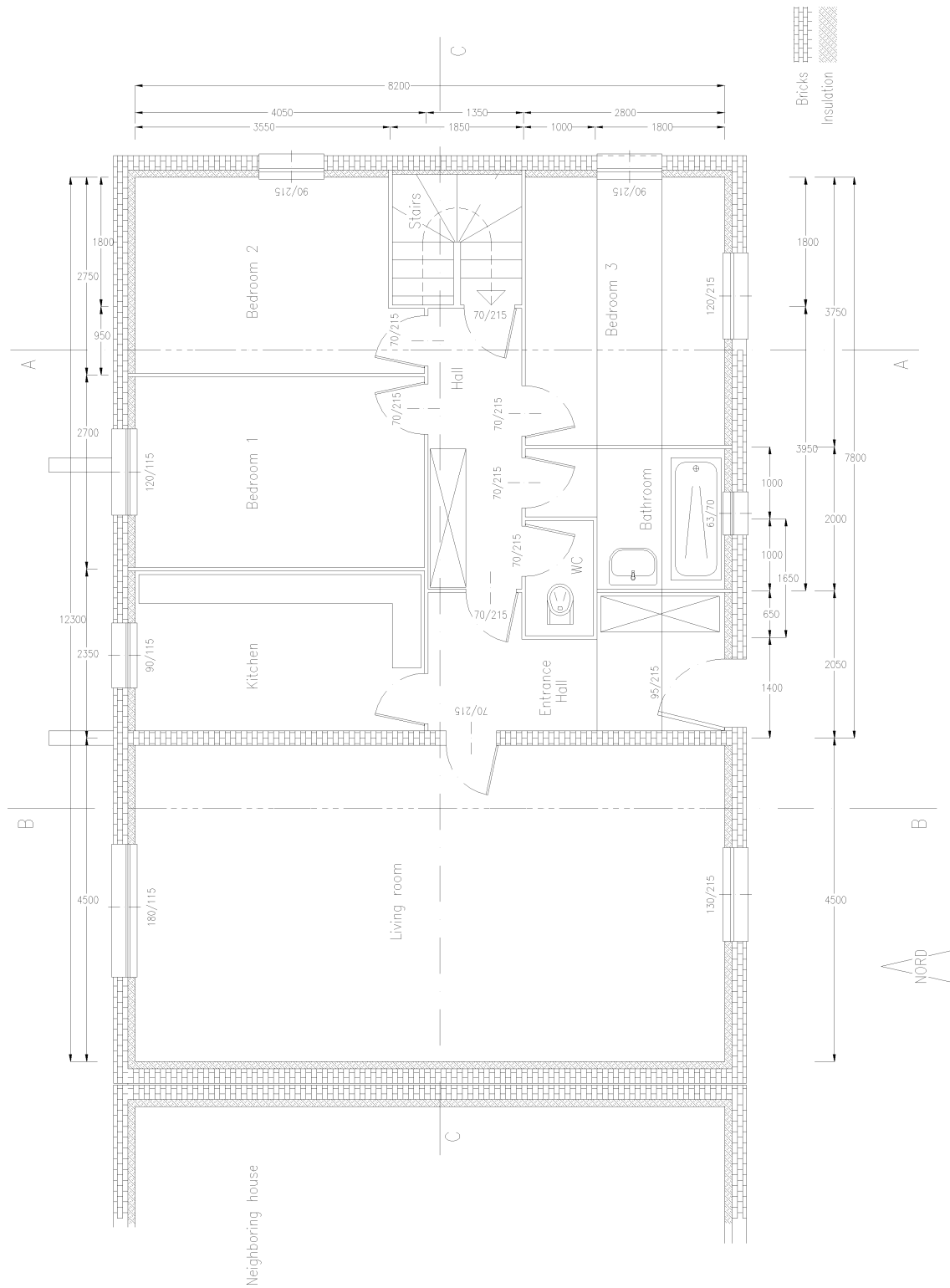

Figure C.1 - Ground floor plan

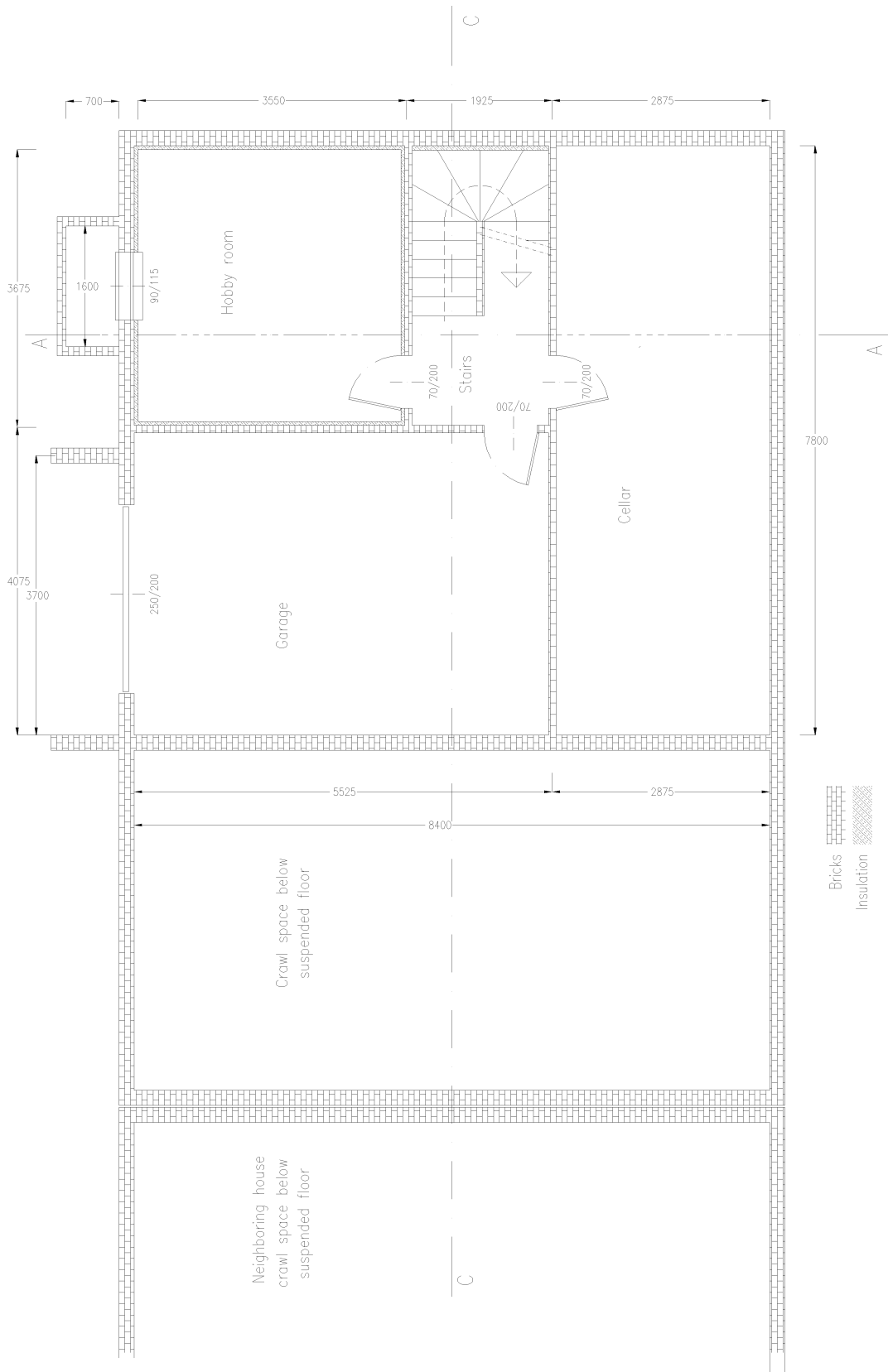
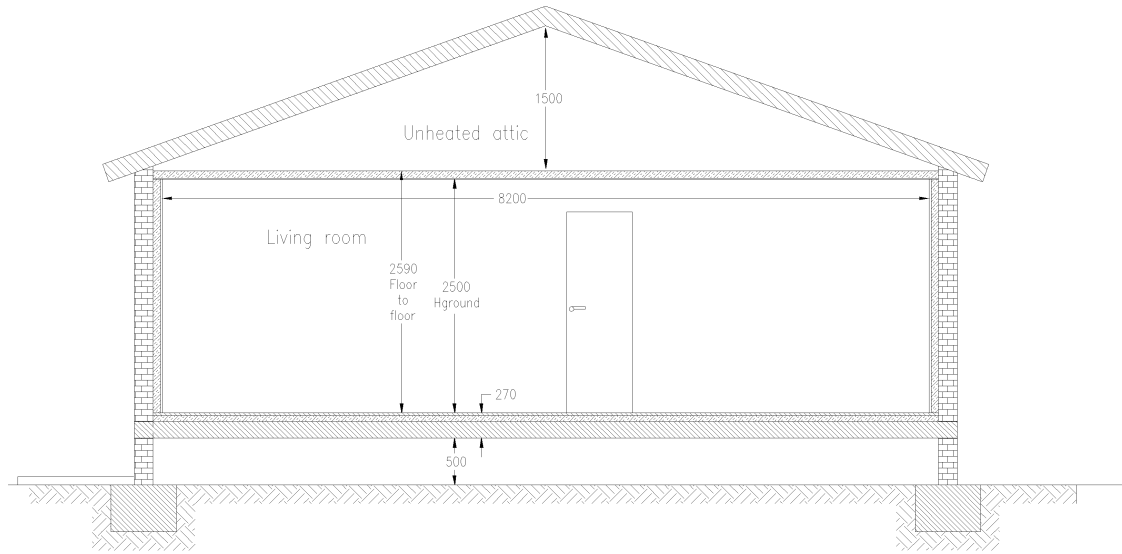
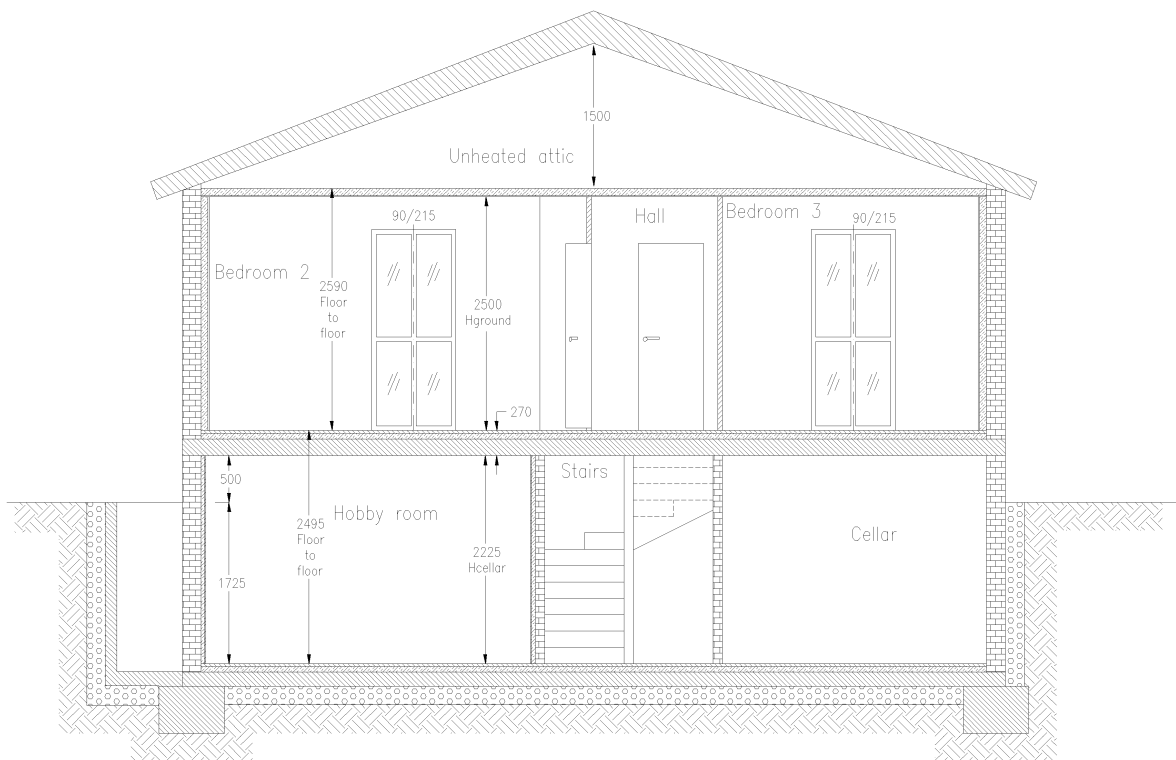

Figure C.2 - Basement plan



Cross section B-B



Cross section A-A

Bricks		Gravel	
Concrete		Earth	
Insulation		Roof	

Figure C.3 - Cross sections A-A and B-B

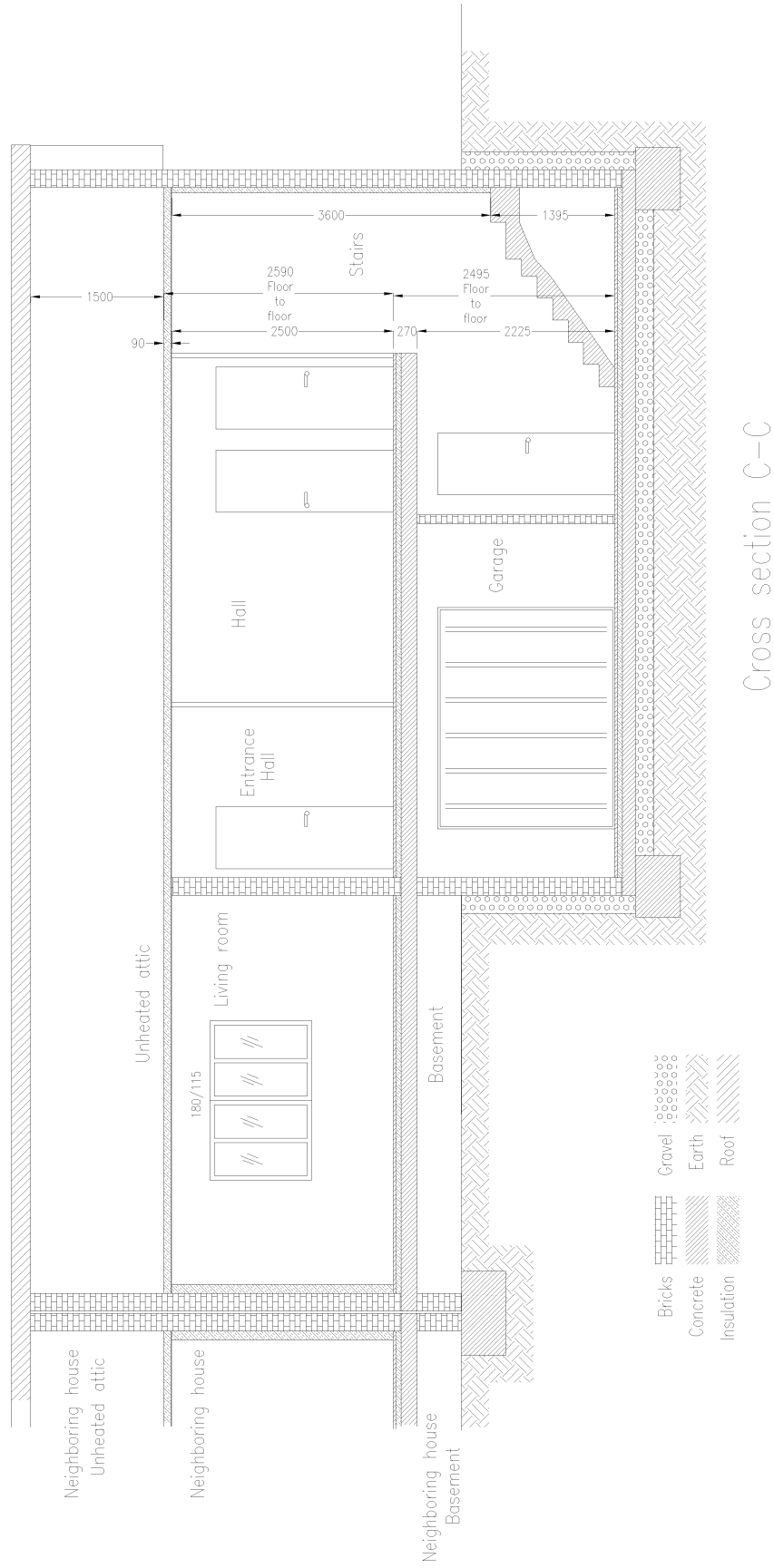

Figure C.4 - Cross section C-C

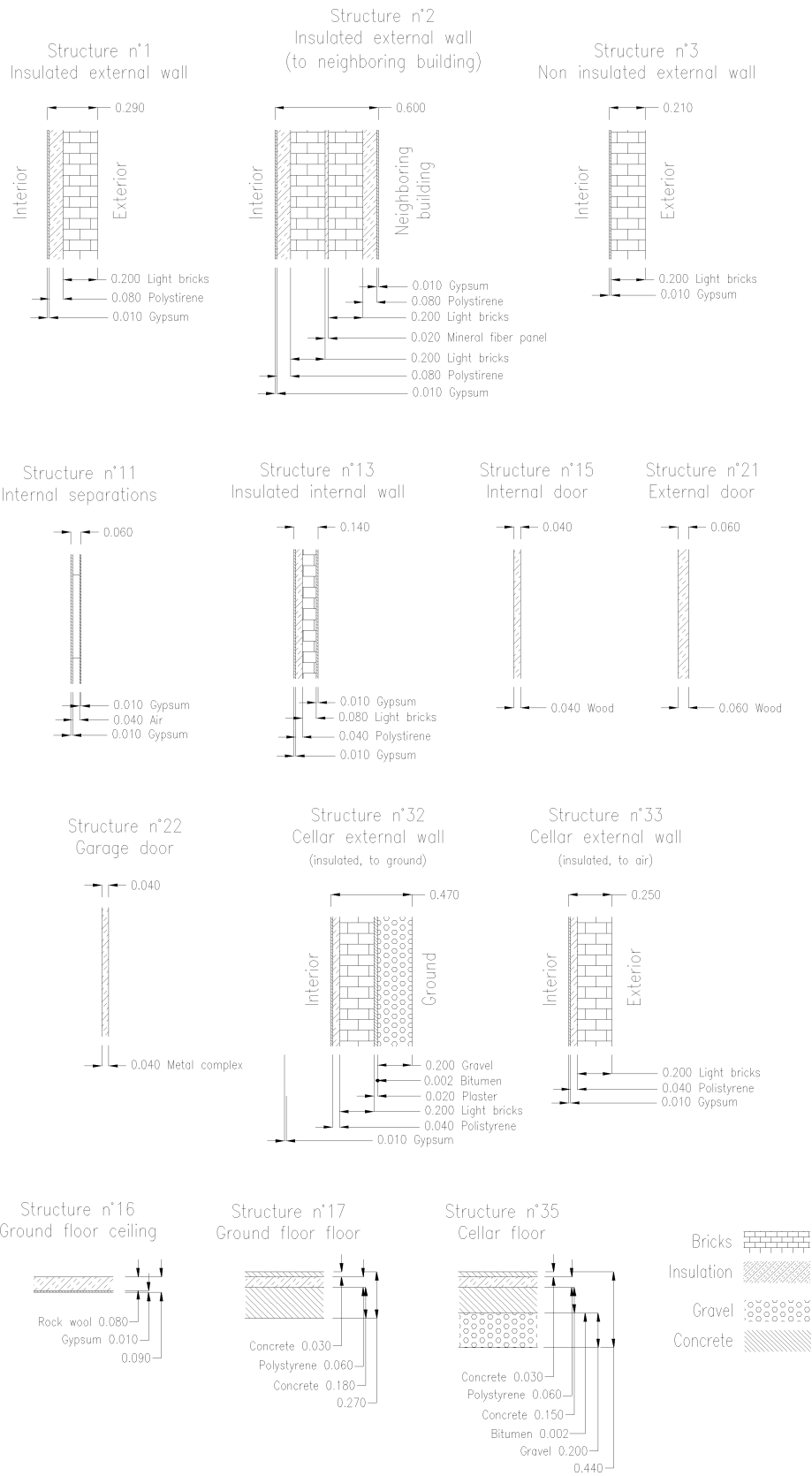

Figure C.5 - Building elements

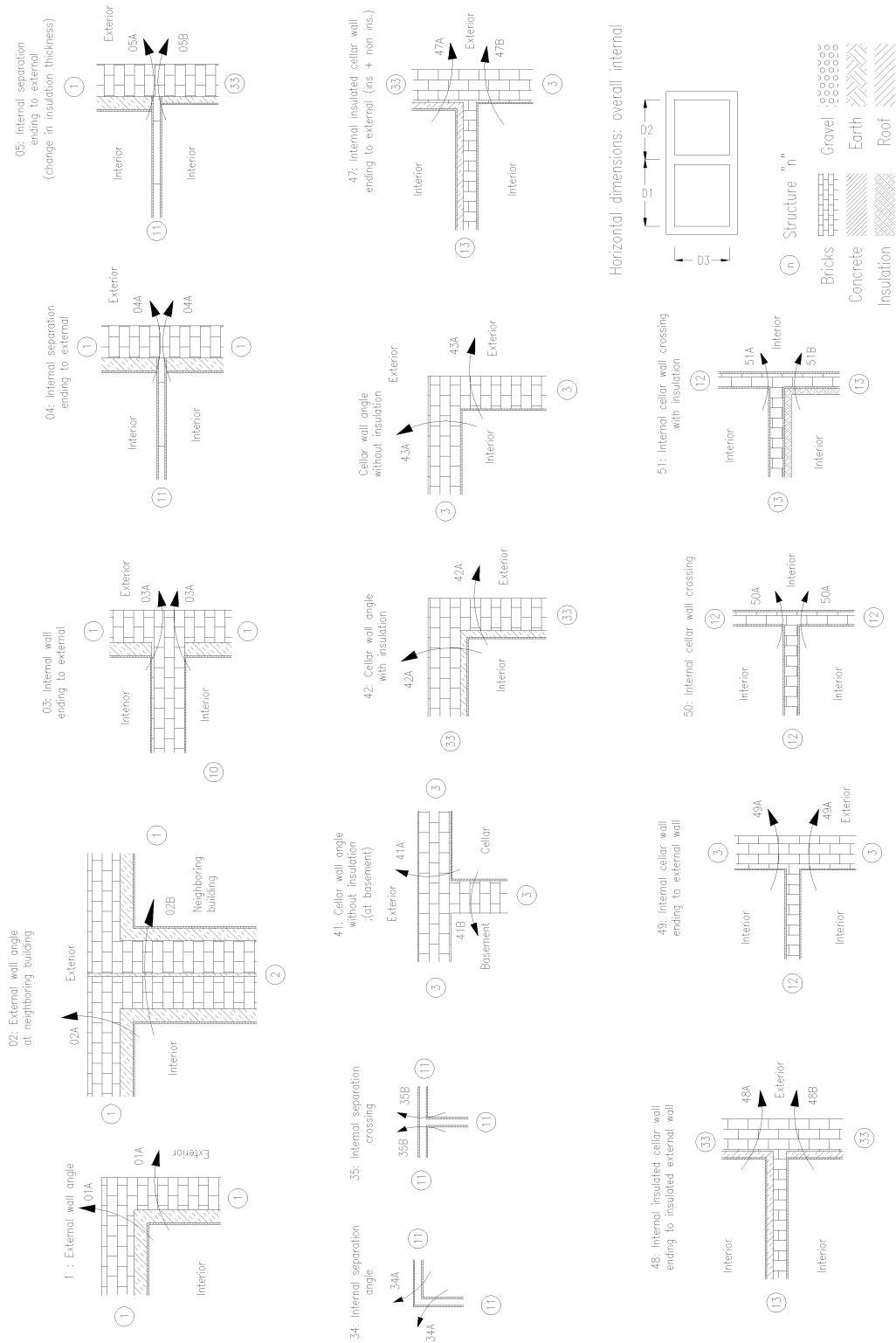

Figure C.6 - Vertical thermal bridges

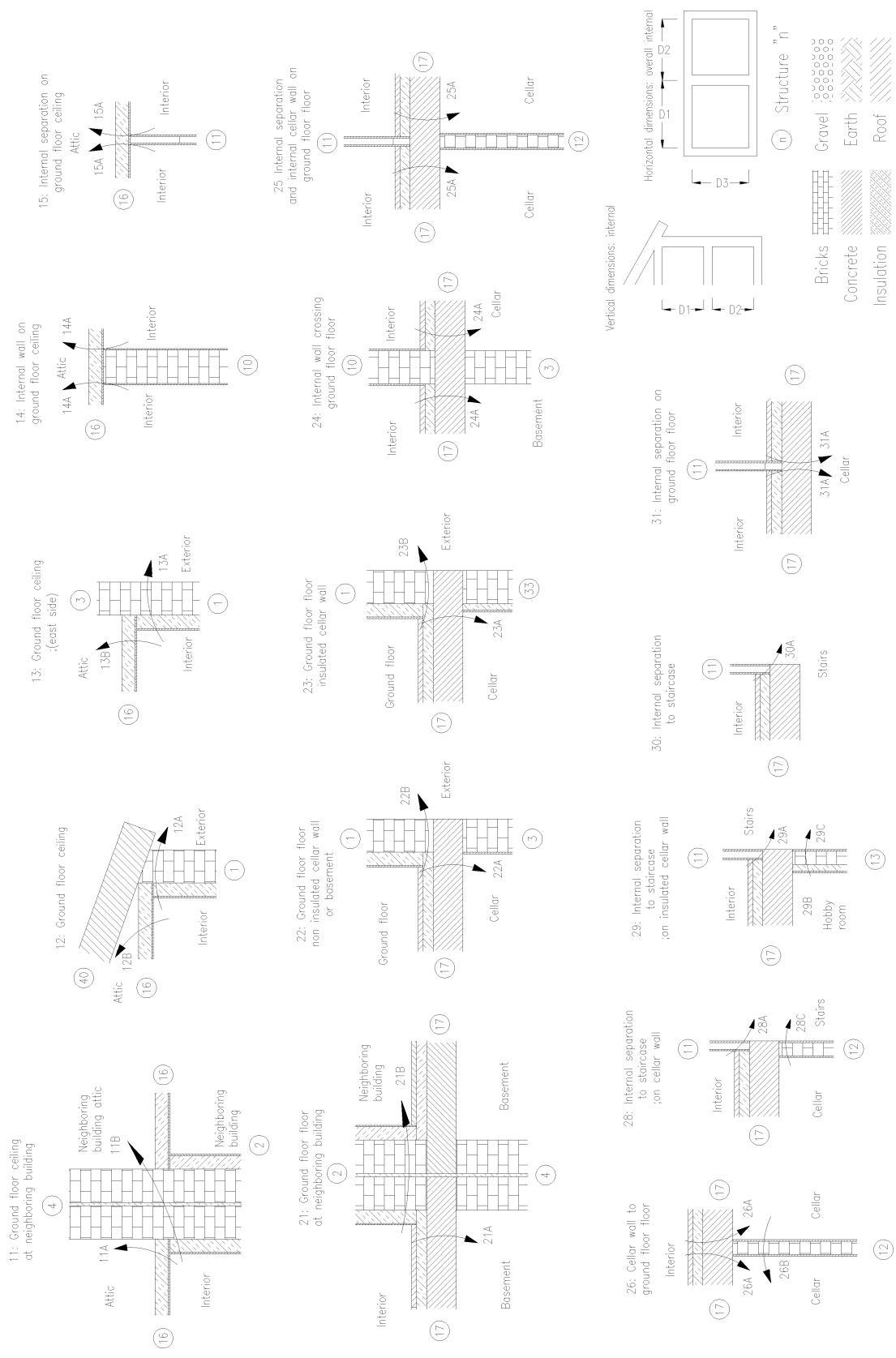

Figure C.7 – Horizontal thermal bridges

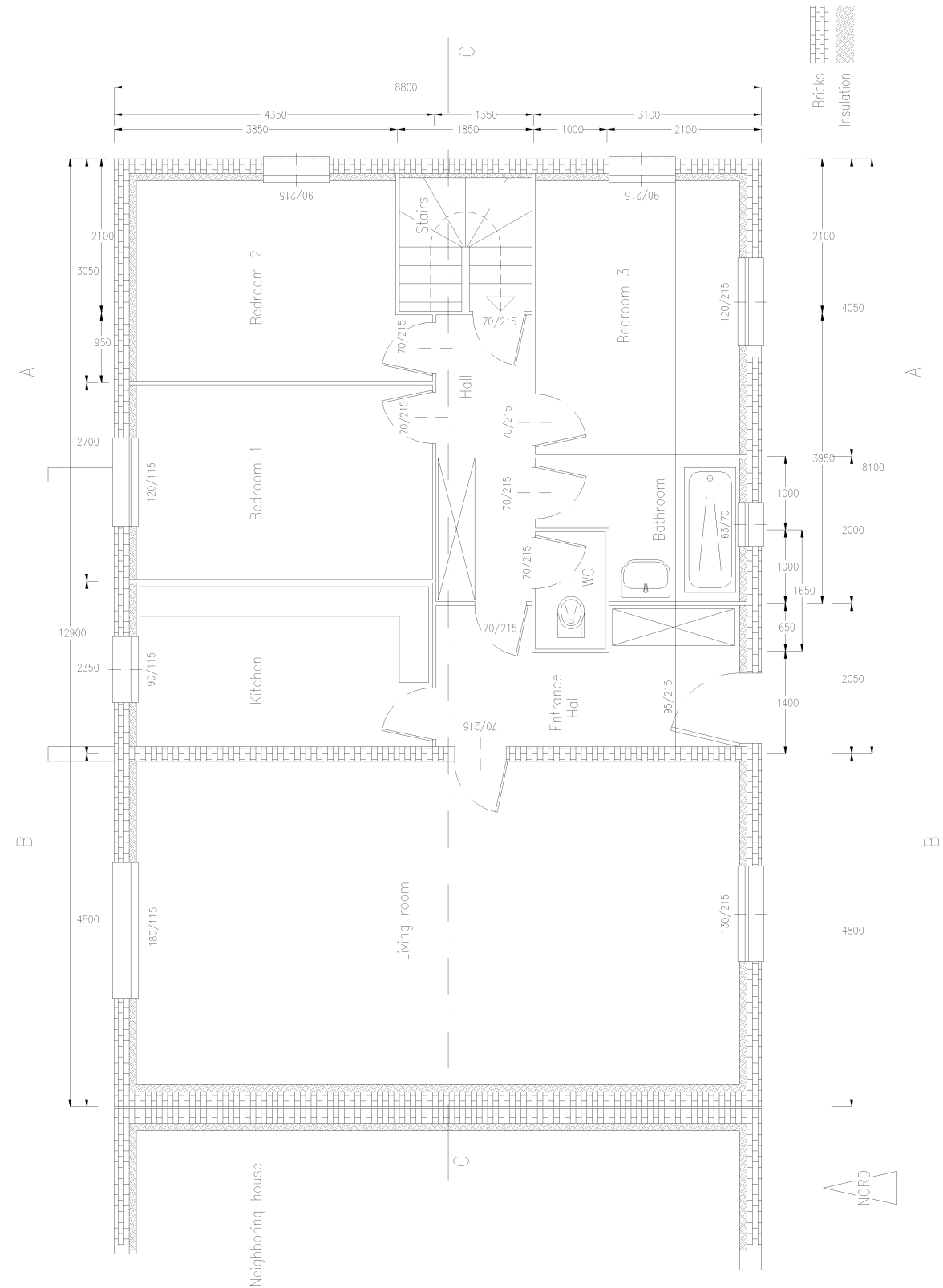

Figure C.8 - Ground floor plan with external dimensions used for the simplified method

C.3 - Sample calculation

C.3.1 - General data

General data needed for the calculation is summarized in Table C.1.

Table C.1 - General data

Climatic data			
Description	Symbol	Unit	Value
Design external temperature	θ_e	°C	-10,0
Annual mean external temperature	$\theta_{m,e}$	°C	12
Exposure coefficients e_k and e_l			
Orientation			Value
			p.u.
All			1,00
Data on heated rooms			
Room name	Design temperature	Room area	Internal volume
	$\theta_{int,i}$	A_i	V_i
	°C	m ²	m ³
Hobby room	20	13,0	29,0
Living room	20	36,9	92,3
Kitchen	20	9,5	23,8
Bedroom 1	20	10,9	27,3
Bedroom 2	20	10,2	25,6
Bedroom 3	20	10,5	26,3
Bathroom	24	4,6	11,5
Entrance hall	20	7,9	19,6
Hall	20	5,3	13,3
WC	20	1,7	4,1
Total		110,6	272,9
Data on unheated rooms			
Room name	b-value	Temperature	
	b_u	θ_u	
	p.u.	°C	
Neighbouring house	-	12	
Garage	0,8	-4	
Stairs	0,4	8	
Cellar	0,5	5	
Unheated attic	0,9	-7	
Ground floor suspended floor	0,8	-4	
Neighbouring house ground floor suspended floor	0,8	-4	

C.3.2 - Data on materials

Data on materials are summarized in Table C.2. Materials are identified by a "material code", which is used as a reference in the subsequent Table C.3 on U-values of building elements.

Table C.2 - Data on materials

Conductivity of materials		
Material code	Description	λ
		W/m·K
1	Light bricks	0,8
2	Concrete	1,75
11	Gypsum	0,35
13	Cement plastering	1,15
21	Polystyrene	0,043
23	Rock wool	0,042
24	Extruded polystyrene	0,037
25	Mineral fiber panel DIN 18165	0,041
31	Gravel	0,7
32	Bitumen	0,23
41	Unventilated air layer s=40 mm	0
51	Wood	0,15
53	Metal composite	0,12
Surface resistances (between air and structures)		
Material code	Description	R_{si} or R_{se}
		m ² ·K/W
41	Unventilated air layer s=40 mm	0,18
61	Internal surface resistance (horizontal heat flow)	0,13
62	External surface resistance (horizontal heat flow)	0,04
63	Internal surface resistance (heat flow upwards)	0,10
66	Internal surface resistance (heat flow downwards)	0,17

C.3.3 - Data on building elements

Table C.3 shows the calculation of U-value of each building element.

Table C.3 - Calculation of U-values of building elements

Codes		Description	d	λ	R	U_k
Element	Material		m	W/m·K	m ² ·K/W	W/m ² ·K
Building element code	Building element name					
	Code	Internal laminar layer name			R_{si}	
	Code	Material name	d_1	λ_1	$R_1=d_1/\lambda_1$	
	
	Code	Material name	d_n	λ_n	$R_n=d_n/\lambda_n$	
	Code	External laminar layer name			R_{se}	
Total thickness and U_k			Σd_i		ΣR_i	$1/\Sigma R_i$
1	Insulated external wall					
	61	Internal surface resistance (horizontal heat flow)			0,13	
	11	Gypsum	0,010	0,350	0,03	
	21	Polystyrene	0,080	0,043	1,86	
	1	Light bricks	0,200	0,800	0,25	
	62	External surface resistance (horizontal heat flow)			0,04	
Total thickness and U_k			0,290		2,31	0,433
2	Insulated external wall (to neighbouring building)					
	61	Internal surface resistance (horizontal heat flow)			0,13	
	11	Gypsum	0,010	0,350	0,03	
	21	Polystyrene	0,080	0,043	1,86	
	1	Light bricks	0,200	0,800	0,25	
	25	Mineral fiber panel DIN 18 165	0,020	0,041	0,49	
	1	Light bricks	0,200	0,800	0,25	
	21	Polystyrene	0,080	0,043	1,86	
	11	Gypsum	0,010	0,350	0,03	
	61	Internal surface resistance (horizontal heat flow)			0,13	
Total thickness and U_k			0,600		5,03	0,199
3	Non-insulated external wall					
	61	Internal surface resistance (horizontal heat flow)			0,13	
	11	Gypsum	0,010	0,350	0,03	
	1	Light bricks	0,200	0,800	0,25	
	62	External surface resistance (horizontal heat flow)			0,04	
Total thickness and U_k			0,210		0,45	2,229
11	Internal separations					
	61	Internal surface resistance (horizontal heat flow)			0,13	
	11	Gypsum	0,010	0,350	0,03	
	41	Unventilated air layer s=40 mm			0,18	
	11	Gypsum	0,010	0,350	0,03	
	61	Internal surface resistance (horizontal heat flow)			0,13	
Total thickness and U_k			0,020		0,50	2,011
13	Internal separations					
	61	Internal surface resistance (horizontal heat flow)			0,13	
	11	Gypsum	0,010	0,350	0,03	
	21	Polystyrene	0,040	0,043	0,93	
	1	Light bricks	0,080	0,800	0,10	
	11	Gypsum	0,010	0,350	0,03	
Total thickness and U_k			0,140		1,35	0,742

Table C.3 (continued) - Calculation of U-values of building elements

Codes		Description	d	λ	R	U_k
Element	Material		m	W/m·K	m ² ·K/W	W/m ² ·K
15	Internal door					
	61	Internal surface resistance (horizontal heat flow)			0,13	
	51	Wood	0,040	0,150	0,27	
	61	Internal surface resistance (horizontal heat flow)			0,13	
	Total thickness and U_k			0,040		0,53
16	Ground floor ceiling					
	63	Internal surface resistance (heat flow upwards)			0,1	
	11	Gypsum	0,010	0,350	0,03	
	23	Rock wool	0,080	0,042	1,90	
	63	Internal surface resistance (heat flow upwards)			0,10	
Total thickness and U_k			0,090		2,13	0,469
17	Ground floor floor					
	66	Internal surface resistance (heat flow downwards)			0,17	
	2	Concrete	0,030	1,750	0,02	
	24	Extruded polystyrene	0,060	0,037	1,62	
	2	Concrete	0,180	1,750	0,10	
	66	Internal surface resistance (heat flow downwards)			0,17	
Total thickness and U_k			0,270		2,08	0,480
20	Windows					
	Total thickness and U_k			-		-
21	External door					
	61	Internal surface resistance (horizontal heat flow)			0,13	
	51	Wood	0,060	0,150	0,40	
	62	External surface resistance (horizontal heat flow)			0,04	
	Total thickness and U_k			0,060		0,57
32	Cellar external wall (insulated, to ground)					
	61	Internal surface resistance (horizontal heat flow)			0,13	
	11	Gypsum	0,010	0,350	0,03	
	21	Polystyrene	0,040	0,043	0,93	
	1	Light bricks	0,200	0,800	0,25	
	13	Cement plastering	0,020	1,150	0,02	
	32	Bitumen	0,002	0,230	0,01	
	31	Gravel	0,200	0,700	0,29	
Total thickness and U_k			0,472		1,65	0,606
33	Cellar external wall (insulated, to air)					
	61	Internal surface resistance (horizontal heat flow)			0,13	
	11	Gypsum	0,010	0,350	0,03	
	21	Polystyrene	0,040	0,043	0,93	
	1	Light bricks	0,200	0,800	0,25	
	62	External surface resistance (horizontal heat flow)			0,04	
Total thickness and U_k			0,250		1,38	0,725
35	Cellar floor (insulated, to ground)					
	66	Internal surface resistance (heat flow downwards)			0,17	
	2	Concrete	0,030	1,750	0,02	
	24	Extruded polystyrene	0,060	0,037	1,62	
	2	Concrete	0,150	1,750	0,09	
	32	Bitumen	0,002	0,230	0,01	
	31	Gravel	0,200	0,700	0,29	
Total thickness and U_k			0,442		2,19	0,457

C.3.4 - Data on thermal bridges

Table C.4 lists data on thermal bridges. The thermal bridges are identified by a code, which is used as a reference in the subsequent tables on the heat losses of rooms.

Table C.4 – Data on thermal bridges

Code	Description	Ψ_1
		W/m·K
01A	External wall angle	0,01
02A	External wall angle at neighbouring building, interior to exterior	0,01
02B	External wall angle at neighbouring building, interior to neighbouring building	0,01
03A	Internal wall ending to external insulated wall	0,195
04A	Internal separation ending to external insulated wall, to exterior	0,125
05A	Internal separation ending to external insulated wall, to exterior through maximum insulation	0,125
05B	Internal separation ending to external insulated wall, to exterior through minimum insulation	0,125
11A	Ground floor ceiling to attic at neighboring building	0,33
11B	Ground floor ceiling to neighbouring attic	0,33
12A	Ground floor ceiling, interior to external air	0,33
12B	Ground floor ceiling, interior to attic	0,33
13A	Ground floor ceiling at east facade, interior to external air	0,33
13B	Ground floor ceiling at east facade, interior to attic	0,33
14A	Ground floor ceiling to attic, internal wall	0,01
15A	Ground floor ceiling to attic, internal separation, to attic	0,01
21A	Ground floor floor to basement at neighbouring building	0,325
21B	Ground floor floor to neighbouring building	0,325
22A	Ground floor floor, non-insulated cellar wall or basement, interior to basement or cellar	0,325
22B	Ground floor floor, non-insulated cellar wall or basement, interior to exterior	0,325
23A	Ground floor floor, insulated cellar wall, interior to cellar	0,325
23B	Ground floor floor, insulated cellar wall, interior to exterior	0,325
24A	Internal wall crossing ground floor, interior to cellar or basement, direct	0,24
25A	Internal separation on ground floor, on cellar wall, interior to cellar, direct	0,24
28A	Internal separation to staircase (on cellar wall), interior to staircase	0,04
28C	Internal separation to staircase (on cellar wall), cellar to staircase	0,17
29A	Internal separation to staircase (on insulated cellar wall), interior to staircase	0,04
29C	Internal separation to staircase (on insulated cellar wall), cellar to staircase	0,095
30A	Internal separation to staircase (on ground floor end), interior to staircase	0,04
31A	Internal separation on ground floor floor, interior to cellar	0,04
34A	Internal separation angle	0,035
35B	Internal separation crossing, bridge through straight wall	0,03
41A	Cellar external wall angle, at basement, cellar to exterior	0,035
41B	Cellar external wall angle, at basement, cellar to basement	0,035
42A	Cellar insulated external wall angle, cellar to exterior	0,01
43A	Cellar external wall angle, cellar to exterior	0,035

Table C.4 (continued) – Data on thermal bridges

Code	Description	Ψ_1
		W/m·K
47A	Internal insulated cellar wall ending to external (insulated and non-insulated), interior to exterior through insulation	0,01
47B	Internal insulated cellar wall ending to external (insulated and non-insulated), interior to exterior through non-insulation	0,03
48A	Internal insulated cellar wall ending to insulated external, interior to exterior through insulation	0,01
48B	Internal insulated cellar wall ending to insulated external, interior to exterior through non-insulation	0,13
49A	Internal cellar wall ending to external wall, interior to exterior	0,03
50A	Internal cellar wall crossing, through straight wall	0,03
51A	Internal insulated cellar wall crossing, through straight non-insulated wall	0,03
51B	Internal insulated cellar wall crossing, through straight insulated wall	0,01
61A	Entrance door floor	0,13
61B	Entrance door top	0,12
61C	Entrance door side	0,12
62A	Window base	0,12
62B	Window top	0,12
62C	Window side	0,12
63A	Window door base	0,13
63B	Window door top	0,12
63C	Window door side	0,12
64A	Garage door base	0,13
64B	Garage door top	0,12
64C	Garage door side	0,12
65A	Internal door base	0,13
65B	Internal door top	0,12
65C	Internal door side	0,12
66	Door side on internal wall	0,54

Data on thermal bridges has been calculated according to EN ISO 10211-1 and taking into account that EN ISO 10211-1 provides the global Ψ_1 -value of each thermal bridge. In the present standard, a room by room calculation is performed, and so each thermal bridge (except for thermal bridges of windows and doors) is included twice in the calculations (once for each room on the two sides of the thermal bridge). Accordingly, the global Ψ_1 -values calculated according to EN ISO 10211-1 have been divided by two, to give the values presented in Table C.4. For thermal bridges of windows and doors, division by two has not been applied.

NOTE Table C.4 is an example of a very detailed thermal bridge calculation to indicate the importance of the thermal bridges in heat load calculations. The great amount of thermal bridges in the house is due to the fact that internal insulation is used, i.e. many thermal bridges are automatically created because of the interruption of the insulation layers at almost every wall connection.

C.3.5 - Room transmission heat losses

General

In the following, details of calculation of the design transmission heat losses are given for one room, i.e. the hobby room.

Hobby room

This room represents a room in contact with the ground.

Table C.5 - Transmission heat loss calculation of the hobby room

Heat losses directly to the exterior					
Code	Building element	A_k	U_k	e_k	$A_k \cdot U_k \cdot e_k$
		m ²	W/m ² ·K	p.u.	W/K
33	Cellar external wall (insulated, to air)	3,56	0,725	1,00	2,58
20	Windows	1,04	2,100	1,00	2,17
33	Cellar external wall (insulated, to air)	1,78	0,725	1,00	1,29
Total of building elements		$\sum_k A_k \cdot U_k \cdot e_k$ W/K			6,04
Code	Thermal bridge	Ψ_k	l_k	e_k	$\Psi_k \cdot l_k \cdot e_k$
		W/m·K	m	p.u.	W/K
47A	Internal insulated cellar wall ending to external (insulated and non-insulated), interior to exterior through insulation	0,01	0,50	1,00	0,005
42A	Cellar insulated external wall angle, cellar to exterior	0,01	1,00	1,00	0,010
48A	Internal insulated cellar wall ending to insulated external, interior to exterior through insulation	0,01	0,50	1,00	0,005
62A	Window base	0,12	0,90	1,00	0,108
62B	Window top	0,12	0,90	1,00	0,108
62C	Window side	0,12	2,30	1,00	0,276
Total of thermal bridges		$\sum_k \Psi_k \cdot l_k \cdot e_k$ W/K			0,512
Total heat loss coefficient directly to the exterior		$H_{T,ie} = \sum_k A_k \cdot U_k \cdot e_k + \sum_k \Psi_k \cdot l_k \cdot e_k$			6,557
Heat losses through unheated spaces					
Code	Building element	A_k	U_k	b_u	$A_k \cdot U_k \cdot b_u$
		m ²	W/m ² ·K	p.u.	W/K
13	Insulated internal wall (hobby room walls)	6,78	0,742	0,40	2,01
15	Internal door	1,40	1,899	0,40	1,06
13	Insulated internal wall (hobby room walls)	7,90	0,742	0,80	4,69
Total of building elements		$\sum_k A_k \cdot U_k \cdot b_u$ W/K			7,77
Code	Thermal bridge	Ψ_k	l_k	b_u	$\Psi_k \cdot l_k \cdot b_u$
		W/m·K	m	p.u.	W/K
51B	Internal insulated cellar wall crossing, through straight insulated wall	0,01	2,23	0,80	0,02
29C	Internal separation to staircase (on insulated cellar wall), cellar to staircase	0,095	1,77	0,40	0,07
Total of thermal bridges		$\sum_k \Psi_k \cdot l_k \cdot b_u$ W/K			0,085
Total heat loss coefficient through unheated spaces		$H_{T,iue} = \sum_k A_k \cdot U_k \cdot b_u + \sum_k \Psi_k \cdot l_k \cdot b_u$			7,850

Table C.5 (continued) - Transmission heat loss calculation of the hobby room

Heat losses through the ground					
		A_g	P	$B'=2 \cdot A_g/P$	
Calculation of B'		m ²	m	m	
		13,05	7,225	3,6	
Code	Building element	U_k	$U_{equiv,k}$	A_k	$A_k \cdot U_{equiv,k}$
		W/m ² ·K	W/m ² ·K	m ²	W/K
32	Cellar external wall (insulated, to ground)	0,606	0,40	12,513	5,01
35	Cellar floor (to ground)	0,457	0,25	13,046	3,26
Total of equivalent building elements		$\sum_k A_k \cdot U_{equiv,k}$		W/K	8,27
Correction factors		f_{g1}	f_{g2}	G_w	$f_{g1} \cdot f_{g2} \cdot G_w$
		p.u.	p.u.	p.u.	p.u.
		1,450	0,267	1,00	0,387
Total heat loss coefficient through the ground $H_{T,ig} = (\sum_k A_k \cdot U_{equiv,k}) \cdot f_{g1} \cdot f_{g2} \cdot G_w$					3,197
Heat losses to spaces heated at different temperatures					
Code	Building element	f_{ij}	A_k	U_k	$f_{ij} \cdot A_k \cdot U_k$
		p.u.	m ²	W/m ² ·K	W/K
-	None	-	-	-	-
Total heat loss coefficient through spaces at different temperature $H_{T,ij} = \sum_k f_{ij} \cdot A_k \cdot U_k$					0,000
Total transmission heat loss coefficient $H_{T,i} = H_{T,ie} + H_{T,iue} + H_{T,ig} + H_{T,ij}$					W/K
					17,60
Temperature data					
Design external temperature		θ_e	°C	-10	
Design internal temperature		$\theta_{int,i}$	°C	20	
Design temperature difference		$\theta_{int,i} - \theta_e$	°C	30	
Design transmission heat loss $\Phi_{T,i} = H_{T,i} \cdot (\theta_{int,i} - \theta_e)$					W
					528

C.3.6 - Room ventilation heat losses

General

In the following, details of calculation of the design ventilation heat loss of each room are given. The calculation is performed for three typical cases of ventilation.

Natural ventilation (opening windows)

It is assumed that no ventilation system is installed. The degree of air tightness of the building is medium (normal seal) and a moderate shielding is assumed.

Table C.6 - Ventilation heat loss calculation, natural ventilation only

Room name			Hobby room	Living room	Kitchen	Bedroom 1	Bedroom 2	Bedroom 3	Bathroom	Entrance hall	Hall	WC	Total
Room internal volume	V_i	m ³	29,0	92,3	23,8	27,3	25,6	26,3	11,5	19,6	13,3	4,1	273
External temperature	θ_e	°C	-10,0										
Internal temperature	$\theta_{int,i}$	°C	20,0	20,0	20,0	20,0	20,0	20,0	24,0	20,0	20,0	20,0	
Minimum hygienic needs	Minimum hygienic air exchange rate	$n_{min,i}$	h ⁻¹	0,5	0,5	1,5	0,5	0,5	0,5	1,5	0,5	0,5	1,5
	Minimum hygienic air flow rate	$V_{min,i}$	m ³ /h	14,5	46,1	35,7	13,7	12,8	13,1	17,3	9,8	6,7	6,2
Infiltration flow rate	Exposed openings	-	p.u.	1	2	1	1	1	2	1	1	0	0
	Air exchange rate at 50 Pa	n_{50}	h ⁻¹	6,0									
	Shielding coefficient	e	p.u.	0,02	0,03	0,02	0,02	0,02	0,03	0,02	0,02	0,00	0,00
	Height correction factor	ε	p.u.	1,0	1,0	1,0	1,0	1,0	1,0	1,0	1,0	1,0	1,0
	Infiltration air flow rate $V_{inf,i}=2 \cdot V_i \cdot n_{50} \cdot e \cdot \varepsilon$	$V_{inf,i}$	m ³ /h	7,0	33,2	5,7	6,6	6,1	9,5	2,8	4,7	0,0	0,0
Ventilation heat loss calculation	Selected value for calculation $V_i = \max(V_{inf,i}, V_{min,i})$	V_i	m ³ /h	14,5	46,1	35,7	13,7	12,8	13,1	17,3	9,8	6,7	6,2
	Design ventilation heat loss coefficient	$H_{V,i}$	W/K	4,9	15,7	12,1	4,6	4,4	4,5	5,9	3,3	2,3	2,1
	Temperature difference	$\theta_{int,i} - \theta_e$	°C	30,0	30,0	30,0	30,0	30,0	30,0	34,0	30,0	30,0	30,0
	Design ventilation heat loss $\Phi_{V,i} = H_{V,i} \cdot (\theta_{int,i} - \theta_e)$	$\Phi_{V,i}$	W	148	470	364	139	131	134	199	100	68	63

Forced ventilation with a heat exchanger

It is assumed that a balanced ventilation system with a heat exchanger is installed. Extracted and supplied air flow rates are given by the ventilation system design. The system is balanced, which means that the total extracted air flow rate is equal to the total supplied air flow rate.

The temperature of the supply air, under design conditions, is assumed to be 12°C. Note the effect of the air entering the bathroom at 20°C, which has to be heated to 24°C.

Table C.7 - Ventilation heat loss calculation, balanced ventilation system with heat exchanger

Room name			Hobby room	Living room	Kitchen	Bedroom 1	Bedroom 2	Bedroom 3	Bathroom	Entrance hall	Hall	WC	Total	
Room internal volume	V_i	m ³	29,0	92,3	23,8	27,3	25,6	26,3	11,5	19,6	13,3	4,1	273	
External temperature	θ_e	°C	-10,0											
Internal temperature	$\theta_{int,i}$	°C	20,0	20,0	20,0	20,0	20,0	20,0	24,0	20,0	20,0	20,0		
Temperature difference	$\theta_{int,i} - \theta_e$	°C	30,0	30,0	30,0	30,0	30,0	30,0	34,0	30,0	30,0	30,0		
Infiltration flow rate	Exposed openings	-	p.u.	1	2	1	1	1	2	1	1	0	0	
	Air exchange rate at 50 Pa	n_{50}	h ⁻¹	6,0										
	Shielding coefficient	e	p.u.	0,02	0,03	0,02	0,02	0,02	0,03	0,02	0,02	0,00	0,00	
	Height correction factor	ε	p.u.	1,0	1,0	1,0	1,0	1,0	1,0	1,0	1,0	1,0	1,0	
Infiltration air flow rate $V_{inf,i} = 2 \cdot V_i \cdot n_{50} \cdot e \cdot \varepsilon$	$V_{inf,i}$	m ³ /h	7,0	33,2	5,7	6,6	6,1	9,5	2,8	4,7	0,0	0,0	75,5	
Ventilation system air flow rates, temperatures and correction factors	Extracted air	$V_{ex,i}$	m ³ /h	0	0	120	0	0	0	30	0	0	30	180
	Supplied air	$V_{su,i}$	m ³ /h	20	50	0	30	30	30	0	10	10	0	180
	Temperature of supplied air	θ_{su}	°C	12										
	Reduction factor	$f_{v,i}$	p.u.	0,27	0,27	-	0,27	0,27	0,27	-	0,27	0,27	-	
	Air coming from adjacent rooms	$V_{ex,i} - V_{su,i}$	m ³ /h	-	-	120	-	-	-	30	-	-	30	
	Reduction factor	$f_{v,i}$	p.u.	-	-	0	-	-	-	0,12	-	-	0	
	Surplus of exhaust air total building $V_{mech,inf} = \sum V_{ex,i} - \sum V_{su,i}$	$V_{mech,inf}$	m ³ /h	0,0										
Surplus of exhaust air room by room	$V_{mech,inf,i}$	m ³ /h	0	0	0	0	0	0	0	0	0	0	0	
Ventilation heat loss calculation	Total corrected ventilation flow rate $V_i = V_{inf,i} + V_{su,i} \cdot f_{v,i} + V_{mech,inf,i}$	V_i	m ³ /h	12,3	46,5	5,7	14,6	14,1	17,5	6,3	7,4	2,7	0,0	
	Design ventilation heat loss coefficient	$H_{V,i}$	W/K	4,2	15,8	1,9	5,0	4,8	5,9	2,1	2,5	0,9	0,0	
	Design ventilation heat loss $\Phi_{V,i} = H_{V,i} \cdot (\theta_{int,i} - \theta_e)$	$\Phi_{V,i}$	W	125	475	58	149	144	178	73	75	27	0	1304

Forced extraction

It is assumed that a simple ventilation system, consisting of extraction in three rooms, is installed. The air enters the building freely and, as a first approximation, is supposed to distribute according to the room volumes.

In the bathroom, the air coming from neighbouring rooms (at 20°C) equals the extracted air flow rate minus the part of surplus exhaust air income ($V_{mech,inf,i}$ at -10°C) of the bathroom.

Table C.8 - Ventilation heat loss calculation, simple extraction

Room name			Hobby room	Living room	Kitchen	Bedroom 1	Bedroom 2	Bedroom 3	Bathroom	Entrance hall	Hall	WC	Total	
Room internal volume	V_i	m ³	29,0	92,3	23,8	27,3	25,6	26,3	11,5	19,6	13,3	4,1	273	
External temperature	θ_e	°C	-10,0											
Internal temperature	$\theta_{int,i}$	°C	20,0	20,0	20,0	20,0	20,0	20,0	24,0	20,0	20,0	20,0		
Temperature difference	$\theta_{int,i}-\theta_e$	°C	30,0	30,0	30,0	30,0	30,0	30,0	34,0	30,0	30,0	30,0		
Infiltration flow rate	Exposed openings	-	p.u.	1	2	1	1	1	2	1	1	0	0	
	Air exchange rate at 50 Pa	n_{50}	h ⁻¹	6,0										
	Shielding coefficient	e	p.u.	0,02	0,03	0,02	0,02	0,02	0,03	0,02	0,02	0,00	0,00	
	Height correction factor	ε	p.u.	1,0	1,0	1,0	1,0	1,0	1,0	1,0	1,0	1,0	1,0	
	Infiltration air flow rate $V_{inf,i}=2 \cdot V_i \cdot n_{50} \cdot e \cdot \varepsilon$	$V_{inf,i}$	m ³ /h	7,0	33,2	5,7	6,6	6,1	9,5	2,8	4,7	0,0	0,0	75,5
Ventilation system air flow rates, temperatures and correction factors	Extracted air	$V_{ex,i}$	m ³ /h	0	0	120	0	0	0	30	0	0	30	180
	Supplied air	$V_{su,i}$	m ³ /h	0	0	0	0	0	0	0	0	0	0	0
	Temperature of supplied air	θ_{su}	°C	-	-	-	-	-	-	-	-	-	-	
	Reduction factor	$f_{v,i}$	p.u.	-	-	-	-	-	-	-	-	-	-	
	Air coming from adjacent rooms	$V_{ex,i}-V_{su,i}$	m ³ /h	-	-	104	-	-	-	22	-	-	27	
	Reduction factor	$f_{v,i}$	p.u.	-	-	0	-	-	-	0,12	-	-	0	
	Surplus of exhaust air total building $V_{mech,inf}=\sum V'_{ex,i}-\sum V_{su,i}$	$V_{mech,inf}$	m ³ /h	180,0										
Surplus of exhaust air room by room	$V_{mech,inf,i}$	m ³ /h	19	61	16	18	17	17	8	13	9	3	180	
Ventilation heat loss calculation	Total corrected ventilation flow rate $V_i=V_{inf,i}+V_{su,i} \cdot f_{v,i}+V_{mech,inf,i}$	V_i	m ³ /h	26,1	94,1	21,4	24,6	23,0	26,8	13,0	17,7	8,8	2,7	
	Design ventilation heat loss coefficient	$H_{V,i}$	W/K	8,9	32,0	7,3	8,4	7,8	9,1	4,4	6,0	3,0	0,9	
	Design ventilation heat loss $\Phi_{V,i}=H_{V,i} \cdot (\theta_{int,i}-\theta_e)$	$\Phi_{V,i}$	W	266	959	218	251	235	273	150	180	90	28	2651

C.3.7 - Heating-up capacity

In the following, details of calculation of heating-up capacity for each room are given.

In this example:

- the building mass is high;
- the internal temperature drop during setback is 3 K;
- the reheat time is 4 h.

Table C.9 – Calculation of heating-up capacity

Room name	Reheat factor	Floor area	Heating-up capacity
	f_{RH}	A_i	$\Phi_{RH,i} = f_{RH} \cdot A_i$
	W/m ²	m ²	W
Hobby room	13	13,0	169,6
Living room		36,9	479,7
Kitchen		9,5	123,7
Bedroom 1		10,9	142,2
Bedroom 2		10,2	133,1
Bedroom 3		10,5	136,5
Bathroom		4,6	59,8
Entrance hall		7,9	102,1
Hall		5,3	69,3
WC		1,7	21,5

C.3.8 - Total heat load

General

In the following, the total design heat load for each room and for the building is given.

The calculation is performed for the three typical cases of ventilation already detailed. The transmission heat loss is the same for all three cases.

In the present calculations, the total heat load of the building is equal to the sum of the total heat load of all the rooms because there is only one zone.

Natural ventilation (opening windows)

It is assumed that no ventilation system is installed.

Table C.10 - Total design heat load calculation, natural ventilation only

Room name	Transmission heat load	Ventilation heat load	Heating-up capacity	Total heat load
	$\Phi_{T,i}$	$\Phi_{V,i}$	$\Phi_{RH,i}$	$\Phi_{HL,i}$
	W	W	W	W
Hobby room	528	148	170	846
Living room	2169	470	480	3119
Kitchen	515	364	124	1003
Bedroom 1	514	139	142	796
Bedroom 2	801	131	133	1064
Bedroom 3	998	134	137	1268
Bathroom	472	199	60	731
Entrance hall	451	100	102	654
Hall	199	68	69	337
WC	4	63	21	88
Total	6650	1817	1437	9905

Forced ventilation with a heat exchanger

Table C.11 - Total design heat load calculation, balanced ventilation system with heat exchanger

Room name	Transmission heat load	Ventilation heat load	Heating-up capacity	Total heat load
	$\Phi_{T,i}$	$\Phi_{V,i}$	$\Phi_{RH,i}$	$\Phi_{HL,i}$
	W	W	W	W
Hobby room	528	125	170	823
Living room	2169	475	480	3123
Kitchen	515	58	124	697
Bedroom 1	514	149	142	805
Bedroom 2	801	144	133	1078
Bedroom 3	998	178	137	1312
Bathroom	472	73	60	604
Entrance hall	451	75	102	629
Hall	199	27	69	296
WC	4	0	21	25
Total	6650	1304	1437	9392

Forced extraction

Table C.12 - Total design heat load calculation, simple extraction

Room name	Transmission heat load	Ventilation heat load	Heating-up capacity	Total heat load
	$\Phi_{T,i}$	$\Phi_{V,i}$	$\Phi_{RH,i}$	$\Phi_{HL,i}$
	W	W	W	W
Hobby room	528	266	170	964
Living room	2169	959	480	3608
Kitchen	515	218	124	857
Bedroom 1	514	251	142	907
Bedroom 2	801	235	133	1169
Bedroom 3	998	273	137	1407
Bathroom	472	150	60	681
Entrance hall	451	180	102	734
Hall	199	90	69	358
WC	4	28	21	53
Total	6650	2651	1437	10738

C.3.9 - Room heat load with the simplified method

General

In the following, details of the simplified calculation of the design heat load are given for one room, i.e. the hobby room.

Hobby room

This room represents a room in contact with the ground.

Table C.13 - Simplified total heat load calculation of the hobby room

Temperature data						
Design external temperature	θ_e	°C	-10,0			
Design internal temperature	$\theta_{int,i}$	°C	20,0			
Design temperature difference	$\theta_{int,i}-\theta_e$	°C	30,0			
Transmission heat losses						
Code	Building element	f_k	A_k	U_k	$f_k \cdot A_k \cdot U_k$	
		p.u.	m ²	W/m ² ·K	W/K	
33	Cellar external wall (insulated, to air)	1,40	4,75	0,73	4,82	
20	Windows	1,00	1,04	2,10	2,17	
33	Cellar external wall (insulated, to air)	1,40	2,93	0,73	2,97	
13	Insulated internal wall (hobby room walls)	1,12	8,39	0,74	6,98	
15	Internal door	1,12	1,40	1,90	2,98	
13	Insulated internal wall (hobby room walls)	1,12	9,48	0,74	7,88	
35	Cellar floor (to ground)	0,42	14,92	0,46	2,86	
32	Cellar external wall (insulated, to ground)	0,42	10,57	0,61	2,69	
Total transmission heat loss coefficient		$H_{T,i} = \sum_k f_k \cdot A_k \cdot U_k$		W/K	33,35	
Total transmission heat loss		$\Phi_{T,i} = H_{T,i} \cdot (\theta_{int,i} - \theta_e)$			W	1000
Ventilation heat losses						
Internal volume	V_i	m ³	29,0			
Minimum air exchange rate	n_{min}	h ⁻¹	0,5			
Total ventilation heat loss coefficient		$H_{V,i} = 0,34 \cdot V_i \cdot n_{min}$		W/K	4,93	
Total ventilation heat loss		$\Phi_{V,i} = H_{V,i} \cdot (\theta_{int,i} - \theta_e)$			W	148
Total ventilation and transmission heat loss		$\Phi_{T,i} + \Phi_{V,i}$			W	1149
Correction factor for higher temperature	$f_{\Delta\theta}$	p.u.	1,0			
Design ventilation and transmission heat loss		$\Phi_1 = (\Phi_{T,i} + \Phi_{V,i}) \cdot f_{\Delta\theta}$			W	1149
Heating-up capacity						
Floor area	A_i	m ²	13,0			
Reheat factor	f_{RH}	W/m ²	13,0			
Total heating-up capacity		$\Phi_{RH,i} = A_i \cdot f_{RH}$			W	170
Total design heat load		$\Phi_{HL,i} = \Phi_1 + \Phi_{RH,i}$			W	1318

C.3.10 - Total heat load with the simplified method

In the following, the total design heat load for each room and for the building is given.

Table C.14 - Simplified total heat load calculation of the building

Room name	Transmission heat load	Ventilation heat load	Higher temperature factor	Heating-up capacity	Total design heat load
	$\Phi_{T,i}$	$\Phi_{V,i}$	$f_{\Delta\theta}$	$\Phi_{RH,i}$	$\Phi_{HL,i}$
	W	W	p.u.	W	W
Hobby room	1000	148	1,0	170	1318
Living room	2196	470	1,0	480	3146
Kitchen	503	364	1,0	124	991
Bedroom 1	533	139	1,0	142	815
Bedroom 2	1091	131	1,0	133	1355
Bedroom 3	1332	134	1,0	137	1602
Bathroom	329	199	1,6	60	905
Entrance hall	454	100	1,0	102	656
Hall	411	68	1,0	69	548
WC	56	63	1,0	21	140
Total	7905	1817	-	1437	11476

ANNEX D
(NORMATIVE)

DEFAULT VALUES FOR THE CALCULATIONS IN CLAUSES 6 TO 9

This annex specifies the normative input data and values used for calculation of the design heat load in clauses 6 to 9. The values and parameters of the following tables included in this annex D shall be given in a national annex to this standard. In cases where no national annex is available, the default values of this annex D shall be used. The national annex can be obtained from the relevant national standardisation organisation. The national annex shall have the same structure as this annex D, but it is allowed to add or delete some cases in the tables.

NOTE The clauses indicated in parenthesis refer to clauses in the main part of this standard.

D.1 - Climatic data (see 6.1)

The external design temperature, θ_e , and the annual mean external temperature, $\theta_{m,e}$, shall be given on a national basis in the form listed in Table D.1 for different geographical zones.

Table D.1 - External design temperature and annual mean external temperature

Geographical zone	θ_e °C	$\theta_{m,e}$ °C

D.2 - Internal design temperature (see 6.2)

Default values for the internal design temperature, $\theta_{int,i}$, are given in Table D.2 for different types of building spaces.

Table D.2 - Internal design temperature

Type of building/space	$\theta_{int,i}$ °C
Single office	20
Landscaped office	20
Conference room	20
Auditorium	20
Cafeteria/Restaurant	20
Classroom	20
Nursery	20
Department store	16
Residential	20
Bathroom	24
Church	15
Museum/Gallery	16

D.3 - Building data (see 6.3)

The choice of building dimensions used for the calculations shall be determined on a national basis. If no national annex to this standard is available, external dimensions shall be used as a basis for the calculations (see clause 9, Figure 7).

D.4 - Design transmission heat loss

D.4.1 - Heat losses directly to the exterior - $H_{T,ie}$ (see 7.1.1)

Correction factors for the exposure, e_k and e_l :

The default value for the correction factors, e_k and e_l , is 1,0.

Linear transmission heat losses - correction factor ΔU_{tb} :

Default values for the correction factor, ΔU_{tb} , are given in Tables D.3a to D.3c.

Table D.3a - Correction factor, ΔU_{tb} , for vertical building elements

number of «piercing» floors ^a	number of «piercing» walls ^a	ΔU_{tb} for vertical building elements W/m ² ·K	
		space volume ≤ 100 m ³	space volume > 100 m ³
0	0	0,05	0
	1	0,10	0
	2	0,15	0,05
1	0	0,20	0,10
	1	0,25	0,15
	2	0,30	0,20
2	0	0,25	0,15
	1	0,30	0,20
	2	0,35	0,25

^a see Figure D.1

Table D.3b - Correction factor, ΔU_{tb} , for horizontal building elements

Building element		ΔU_{tb} for horizontal building elements W/m ² ·K
Light floor (wood, metal, etc.)		0
Heavy floor (concrete, etc.)	Number of sides in contact with the external environment:	1
		2
		3
		4

Table D.3c - Correction factor, ΔU_{tb} , for openings

Area of the building element	ΔU_{tb} for openings W/m ² ·K
0 – 2 m ²	0,50
>2 – 4 m ²	0,40
>4 – 9 m ²	0,30
>9 – 20 m ²	0,20
>20 m ²	0,10



«piercing» building elements

«non piercing» building elements

Figure D.1 - Description of «piercing» and «non piercing» building elements

D.4.2 - Heat losses through unheated space - $H_{T,iue}$ (see 7.1.2)

Default values for the temperature reduction factor, b_u , are given in Table D.4.

Table D.4 - Temperature reduction factor, b_u

Unheated space	b_u
Room	
with only 1 external wall	0,4
with at least 2 external walls without outer doors	0,5
with at least 2 external walls with outer doors (e.g. halls, garages)	0,6
with 3 external walls (e.g. external staircase)	0,8
Basement	
without windows/external doors	0,5
with windows/external doors	0,8
Roof space	
high ventilation rate of the roof space (e.g. roofs clad in tiles or other materials giving a discontinuous cover) without sarking felts or sarking boards	1,0
other non-insulated roof	0,9
insulated roof	0,7
Internal circulation areas (without external walls, air exchange rate less than 0.5 h^{-1})	0
Freely ventilated circulation areas (area of openings/volume of space $> 0.005 \text{ m}^2/\text{m}^3$)	1,0
Suspended floor (floor above crawl space)	0,8

A room can be considered as a basement if more than 70 % of the external wall area is in contact with the ground.

D.4.3 - Heat losses through the ground - $H_{T,ig}$ (see 7.1.3)

Default values for the correction factors f_{g1} and G_W are:

$$f_{g1} = 1,45;$$

$G_W = 1,00$ if the distance between assumed water table and floor slab is more than 1 m;
 $= 1,15$ if the distance between assumed water table and floor slab is less than 1 m.

D.4.4 - Heat losses to or from spaces heated at a different temperature - $H_{T,ij}$ (see 7.1.4)

Default values for the temperature of adjacent heated spaces are given in Table D.5.

Table D.5 - Temperature of adjacent heated spaces

Heat transferred from heated space (i) to:	$\theta_{\text{adjacent space}}$ °C
adjacent room within the same building entity	$\theta_{\text{adjacent space}}$ shall be specified: - e.g. for bathroom, storeroom - e.g. influence of vertical temperature gradient
adjacent room belonging to another building entity (e.g. apartment)	$\frac{\theta_{\text{int, i}} + \theta_{\text{m, e}}}{2}$
adjacent room belonging to a separate building (heated or unheated)	$\theta_{\text{m, e}}$

$\theta_{\text{m,e}}$ is the annual mean external temperature.

D.5 - Design ventilation heat loss - $H_{v,i}$

D.5.1 - Minimum external air exchange rate - n_{min} (see 7.2.1 and 9.1.3)

Default values for the minimum external air exchange rate, n_{min} , are given in Table D.6.

Table D.6 - Minimum external air exchange rate, n_{min}

Room type	n_{min} h^{-1}
Habitable room (default)	0,5
Kitchen or bathroom with window	1,5
Office room	1,0
Meeting room, classroom	2,0

D.5.2 - Air exchange rate - n_{50} (see 7.2.2)

Default values for the air exchange rate, n_{50} , for the whole building resulting from a pressure difference of 50 Pa between inside and outside, are given in Table D.7.

Table D.7 - Whole building air exchange rate, n_{50}

Construction	n_{50} h^{-1}		
	Degree of air-tightness of the building envelope (quality of window-seal)		
	high (high quality sealed windows and doors)	medium (double glaze windows, normal seal)	low (single glaze windows, no sealant)
single family dwellings	< 4	4 - 10	> 10
other dwellings or buildings	< 2	2 - 5	> 5

The whole building air exchange rates may be expressed for other pressure differences than 50 Pa., but these results should be adapted to suit equation 17 in 7.2.2.

D.5.3 - Shielding coefficient - e (see 7.2.2)

Default values for the shielding coefficient, e , are given in Table D.8.

Table D.8 - Shielding coefficient, e

Shielding class	e		
	Heated space without exposed openings	Heated space with one exposed opening	Heated space with more than one exposed opening
No shielding (buildings in windy areas, high rise buildings in city centres)	0	0,03	0,05
Moderate shielding (buildings in the country with trees or other buildings around them, suburbs)	0	0,02	0,03
Heavy shielding (average height buildings in city centres, buildings in forests)	0	0,01	0,02

D.5.4 - Height correction factor - ε (see 7.2.2)

Default values for the height correction factor, ε , are given in Table D.9.

Table D.9 - Height correction factor, ε

Height of heated space above ground-level (centre of room height to ground level)	ε
0 – 10 m	1,0
>10 – 30 m	1,2
>30 m	1,5

D.6 - Intermittently heated spaces (see 7.3 and 9.2.2)

Default values for the reheat factor, f_{RH} , are given in Tables D.10a and D.10b. The tables are based on internal dimensions of floor area and can be used for rooms with a mean height not exceeding 3,5 m.

The effective building mass is given as three categories, as follows:

- high building mass (concrete floors and ceilings combined with brick or concrete walls);
- medium building mass (concrete floors and ceilings, and light walls);
- light building mass (suspended ceilings and raised floors and light walls).

Table D 10a - Reheat factor, f_{RH} , for non-residential buildings, nightsetback maximum 12 h

Reheat time hours	f_{RH} W/m ²								
	Assumed internal temperature drop during setback ^a								
	2 K			3 K			4 K		
	building mass			building mass			building mass		
	low	medium	high	low	medium	high	low	medium	high
1	18	23	25	27	30	27	36	27	31
2	9	16	22	18	20	23	22	24	25
3	6	13	18	11	16	18	18	18	18
4	4	11	16	6	13	16	11	16	16

^a In well insulated and airtight buildings, an assumed internal temperature drop during set back of more than 2 to 3 K is not very likely. It will depend on the climate conditions and the thermal mass of the building.

Table D 10b - Reheat factor, f_{RH} , for residential buildings, nightsetback maximum 8 h

Reheat time hours	f_{RH} W/m ²		
	Assumed internal temperature drop during setback ^a		
	1 K	2 K	3 K
	building mass high	building mass high	building mass high
1	11	22	45
2	6	11	22
3	4	9	16
4	2	7	13

^a In well insulated and airtight buildings, an assumed internal temperature drop during set back of more than 2 to 3 K is not very likely. It will depend on the climate conditions and the thermal mass of the building.

D.7 - Simplified calculation method (see 9)

D.7.1 - Restrictions of use

Restrictions of use of the simplified calculation method given in 9 shall be given in a national annex to this standard. Where no national information is available, the simplified method may be used for residential buildings for which, the air exchange rate resulting from a pressure difference of 50 Pa between the inside and the outside of the building, n_{50} , is lower than 3 h^{-1} .

D.7.2 - Temperature correction factor - f_k (see 9.1.2)

Default values for the temperature correction factor, f_k , are given in Table D.11.

Table D.11 - Temperature correction factor, f_k , for the simplified calculation method

Heat loss:	f_k	Comments
directly to the exterior	1,00	if thermal bridges are insulated
	1,40	if thermal bridges are not insulated
	1,00	for windows, doors
through unheated space	0,80	if thermal bridges are insulated
	1,12	if thermal bridges are not insulated
through the ground	0,3	if thermal bridges are insulated
	0,42	if thermal bridges are not insulated
through the roof space	0,90	if thermal bridges are insulated
	1,26	if thermal bridges are not insulated
suspended floor	0,90	if thermal bridges are insulated
	1,26	if thermal bridges are not insulated
to an adjacent building	0,50	if thermal bridges are insulated
	0,70	if thermal bridges are not insulated
to an adjacent building entity	0,30	if thermal bridges are insulated
	0,42	if thermal bridges are not insulated

D.7.3 - Temperature correction factor - $f_{\Delta\theta}$ (see 9.1.1)

Default values for the temperature correction factor, $f_{\Delta\theta}$, for rooms heated at a higher temperature than the adjacent heated rooms, e.g. bathroom, are given in Table D.12.

Table D.12 - Temperature correction factor, $f_{\Delta\theta}$

Internal design temperature of room:	$f_{\Delta\theta}$
normal	1,0
higher	1,6

BIBLIOGRAPHY

CR 1752, *Ventilation for buildings – Design criteria for the indoor environment.*

prEN 13465, *Ventilation for buildings - Calculation methods for the determination of air flow rates in dwellings.*

EN ISO 7730, *Moderate thermal environments _ Determination of the PMV and PPD indices and specifications of the conditions for thermal comfort.*

EN ISO 13789, *Thermal performance of buildings - Transmission heat loss coefficient - Calculation method (ISO 13789:1999).*

prEN ISO 13790, *Thermal performance of buildings - Calculation of energy use for heating (ISO/DIS 13790:1999).*

prEN ISO 15927-5, *Hygrothermal performance of buildings - Calculation and presentation of climatic data - Part 5: Winter external design air temperatures and related wind data (ISO/DIS 15927-5:2002).*

National Annex NA (informative)

Guidance for the use of BS EN 12831:2003

NOTE 1 The number in parenthesis () in the title of each clause relates to the clause number in the main body of the standard BS EN 12831.

NOTE 2 The secondary references in square brackets [] refer to the clauses of BS 5449:1990 from which the text originated. "C and R" refers to commentary and recommendations.

NOTE 3 Annexes A to C of BS EN 12831: 2003 are informative and are not considered relevant for this National Annex.

NA.1 Scope (1) [1]

This National Annex applies to the calculation of the design heat loss and the design heat load, which may include those for domestic hot water, for buildings with heat requirements that can be satisfied by forced circulation hot water central heating systems up to 45 kW.

NOTE The general planning and design of heating systems is covered by BS EN 12828 and the installation and commissioning of those systems by BS EN 14336.

This National Annex covers the following types of heating systems:

- a) open vented smallbore and microbore systems
- b) sealed smallbore and microbore systems

NA.2 References (2)

The informative references that apply to this National Annex are included in the Bibliography.

NA.3 Terms and definitions (3.1) [2]

For the purposes of this National Annex, the terms and definitions given in BS EN 12828:2012 and BS EN 12831 together with the following will apply.

NA.3.1

calculated heat loss

total heat loss from a room or space within a dwelling due to the design temperature differences and ventilation rate; it is the sum of the structural heat loss and the ventilation heat loss

NA.3.2

structural heat loss

heat which is conducted through the enclosing surfaces of the room or space within a dwelling (walls, windows, floor and ceiling) due to the design temperature differences across them, taking into account the exposure of external walls to climatic influence and any heat gain from these surfaces where the adjoining room or space is at a higher design temperature than that of the considered room or space

NA.4 Principle of the calculation method (4) [8.1 & 9.1, C and R 8.1 & 9.1]

A central heating system is designed on the basis of calculated heat losses.

When calculating heat losses, reference to one of the following should be made:

- a) *Domestic Heating Design Guide* (CIBSE) {1};
- b) CIBSE Environmental Guide A (for building data and other U-values);
- c) Proprietary computer aided design software based on BS EN 12831:2003 (NA);
- d) NA.5 for thermal transmittance U-values, and Table NA.1a) for room temperatures to enable the calculation of structural heat loss, together with natural infiltration air change rates to calculate design ventilation heat losses.

Commentary and recommendations on NA.4

Before design commences, the heating system designer aided by the client or its representative, should determine system operating requirements deemed appropriate for the building and its occupants

Heat loss calculations should use Table NA.1a (for room temperatures and ventilation rates), Table NA.1b (for airchange with chimneys) and Table NA.1c (for external winter design temperatures for UK cities), together with an altitude allowance (if applicable) which decreases the external design temperature by 0,6 °C for every 100 m of additional height above sea level.

Consideration should also be given for unusual air change rates where small changes from the design rates may increase the actual operational heat losses significantly. This is particularly relevant in the case of highly insulated dwellings, where the use of mechanical heat recovery ventilation (MHRV) or mechanical extract systems is now common.

For buildings with heating systems designed to operate intermittently (high/low or on/off), a reheat allowance of 20 % should be added to the calculated heat loss. Alternatively, see EN12831 Table D.10 (b) for interruptions of 1 to 4 hours and room temperature rise 1 to 3 °C.

If any secondary heating systems are in simultaneous operation these should also be taken into account. For systems intended to run continuously (day and night), no extra reheat allowance is necessary.

To reduce unnecessary heat losses and operating costs consideration should be given to the following:

- a) Minimize air leaks through the structure, using care and judgement e.g. excessive air infiltration may be reduced by sealing cracks in boarded floors over ventilated cavities, weather-stripping all badly fitting external doors and windows, installing new double glazed windows, and sealing unused chimneys.

NOTE 1 Severe reductions of the ventilation rate in a dwelling may introduce condensation on cool surfaces. If an open fireplace is to be sealed and vented at the base of the chimney, this should be taken into account when compensating for prevention of condensation within the chimney.

NOTE 2 Airchange/hour (Table NA.1a) is required in living rooms for odour removal and fresh air supply. For ventilation of kitchens and bathrooms see UK Building Regulations Part F and Table NA.1a.

- b) BS EN 12828 requires provision of a combustion air inlet supply for open-flued gas, oil and solid fuel boilers (excluding room sealed appliances). The designer should make due allowance for heating any significant replacement air supply or for odour control required by any other appliance.
- c) Additional Insulation of ceilings and roof.

- d) Filling of cavity walls with insulating materials.
- e) External wall insulating linings internally and external wall cladding.
- f) Double or Triple glazing, with enhanced transmission characteristics.
- g) Reflective or insulating surfaces behind radiators on external walls.

Table NA.1a — Design Room Operative Temperature and Natural Ventilation rates

Room	Room Temp °C	Category A	Category B	Category C	Room	Room Temp °C	Category A	Category B	Category C
Lounge/Sitting Room	21	1,5**	1,0**	0,5	Games Room	21	1,5	1,0	0,5
Living Room	21	1,5**	1,0**	0,5	Bedroom	18	1,0	1,0	0,5
Breakfast Room	21	1,5	1,0	0,5	Bedsitting Room	21	1,5	1,0	0,5
Dining Room	21	1,5	1,0	0,5	Bedroom with Ensuite Bath	21	2,0	1,5	1,0
Kitchen	18	2,0*	1,5*	1,5*	Internal Room or Corridor	18	0,0	0,0	0,0
Family/Breakfast	21	2,0*	1,5*	1,5*	Bedroom/Study	21	1,5	1,5	0,5
Hall	18	2,0	1,0	0,5	Landing	18	2,0	1,0	0,5
Cloaks – WC	18	2,0*	1,5*	1,5*	Bathroom	22	3,0*	1,5*	1,5*
Toilet	18	3,0*	1,5*	1,5*	Shower Room	22	3,0*	1,5*	1,5*
Utility Room	18	3,0*	2,0*	0,5*	Dressing Room	18	1,5	1,0	0,5
Study	21	1,5	1,5*	0,5	Store Room	16	1,0	0,5	0,5

Category A: Air change rates for older existing buildings (pre 2000). Those with several chimneys and/or subject to preservation orders may require greater infiltration allowance than shown above.

Category B: Airchange rates for modern buildings (2000 or later) with double glazing and regulatory minimum insulation.

Category C: New (or existing) buildings constructed after 2006 and complying with all current Building Regulations

* Where mechanical extract ventilation is to be installed in a room and the extract volume exceeds the natural infiltration, due allowances should be made for the air extracted from any connecting room or corridor. .

** Where a room contains an open fire or chimney, due ventilation allowance should be made from Table NA 1b below.

Table NA.1b — Air change rates for rooms with open fires and flues up to 40 000 mm² (200 mm 6 200 mm)

Room volume (m ³)	Throat restrictor fitted to flue	Air changes per hour
Up to 40	NO	5
Up to 40	YES	3
Up to 70	NO	4
Up to 70	YES	2

Table NA.1c — External Design Temperatures

Location	Altitude (metres)	External Temp [A]	External Temp [B]
Belfast	68	-2,6 °C	-1,2 °C
Birmingham	96	-5,4 °C	-3,4 °C
Cardiff	67	-3,2 °C	-1,6 °C
Edinburgh	35	-5,4 °C	-3,4 °C
Glasgow	5	-5,9 °C	-3,9 °C
London	25	-3,3 °C	-1,8 °C
Manchester	75	-3,6 °C	-2,2 °C
Plymouth	27	-1,6 °C	-0,2 °C

Table NA.1c. is reproduced using selected data from CIBSE Environmental Guide A: Section 2 (2007). Data from the closest location should be used, with the temperature decreasing by 0,6 °C for every 100 m by which the height above sea level of the site exceeds that of the altitude given in the table.

- a) External Temperature [A] should be used for heating systems intended for continuous heating operation.
- b) External Temperature [B] should be used for heating systems designed to operate intermittently, where an intermittent heating factor of 1.2 has been allowed and is included within the design.

A new edition of CIBSE Guide A is expected in 2013, to which reference should be made for a longer list of locations and updated temperatures.

NA.5 (U-values) (6.3 and 7.1) [Appendix A]

NA.5 General

The following tables provide typical UK heat loss thermal transmittances (known as U-values) given in terms of $W/m^2 \text{ } ^\circ C$ (or $W/m^2 K$) for typical elements of both old and new building construction. For other examples, refer to CIBSE Environmental Data Guide A, or *Domestic Central Heating Guide*.

NA 5.1 UK Building Regulation (2010) minimum U-values for New Construction

Figure NA.1 shown below is constructed from a table in Building Regulations ADL1A, and sections 4, 5, & 6 of ADC, by courtesy of the DCLG Building Regulations, plus document BR443, windows and rooflights section, by courtesy of the Building Research Establishment.

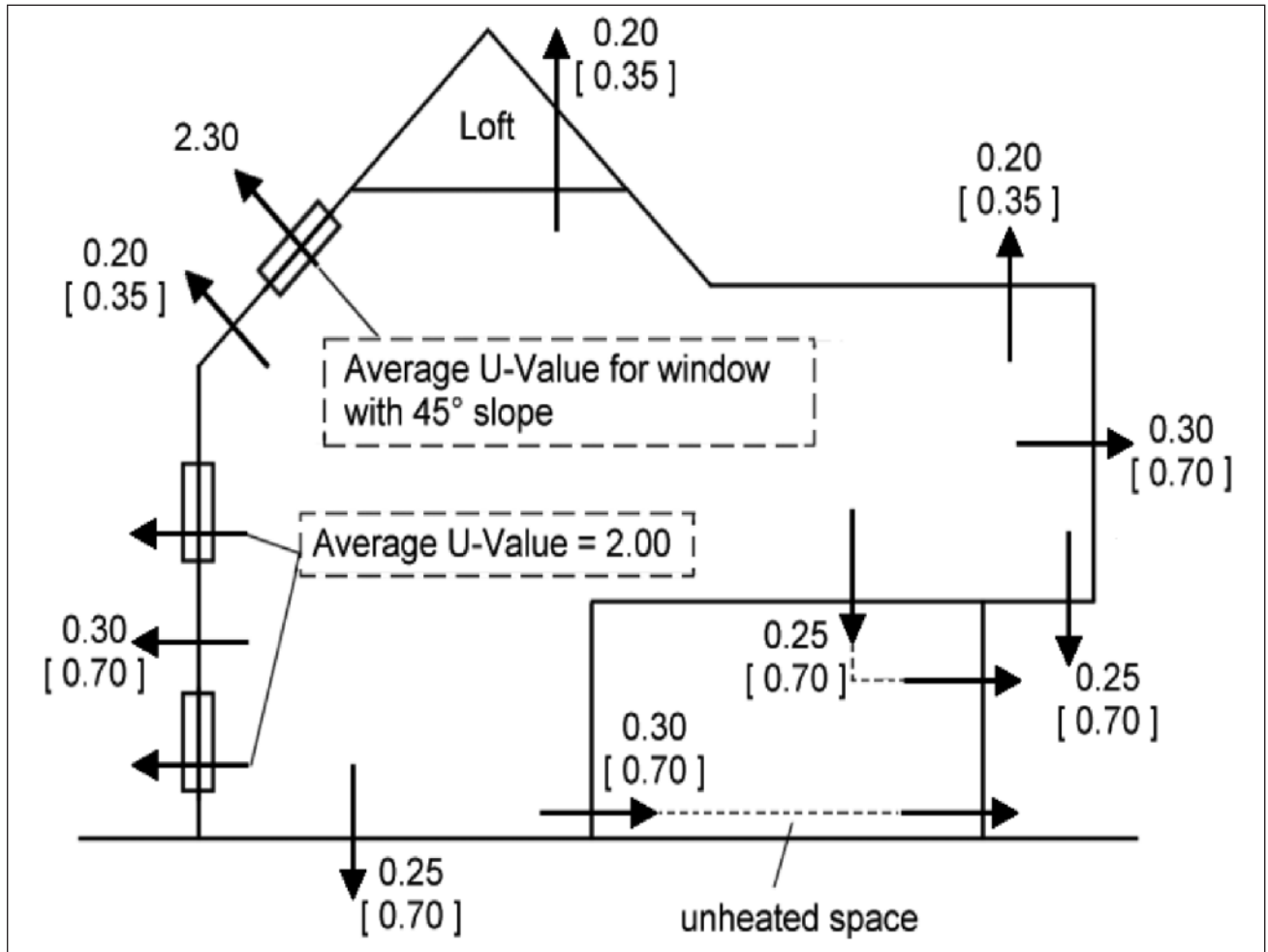

Figure NA.1 — Area weighted and [Limiting] U-Values for individual building elements

NOTE U-values shown above set out the worst acceptable area-weighted U-values for building elements of the stated type. U-values shown in square brackets [] are the limiting U-values for an individual part of an element. e.g. a single skin behind a built-in meter box in a cavity wall should not have a U-value greater than 0,7 W/m²K

NA.5.2 Solid walls

U-values for typical wall constructions of stone or brickwork or concrete blocks with no insulation, complete with internal plastered face of 13 mm plaster & skim are given in Table NA.2.

Table NA.2 — *U*-values for solid external walls (normal exposure)

Wall Fabric	Thickness (mm)	Internal Plaster & Skim (mm)	<i>U</i> -value (W/m ² K)	<i>U</i> -value with External Render
Brickwork	220	>13	2,00	1,95
Brickwork	335	>13	1,60	1,54
Brickwork	450	>13	1,24	1,21
Brickwork	600	>13	1,04	1,01
Concrete Block	200	>13	3,11	2,94
Stone	230	>13	3,06	-
Stone	342	>13	2,55	-
Stone/	455	> 13	2,17	-
Stone	610	>13	1,80	-

U-values for original wall construction as Table NA.2, but fitted with timber or metal studding on the inside face, including mineral wool insulation batts or PUR foam insulation with 13 mm plasterboard internal finish are given in Table NA.2a.

Table NA.2a — *U*-values for insulated solid external walls (normal exposure)

Original Wall Thickness with Insulation Thickness (mm)			Mineral Wool		PUR-Foam	
			<i>U</i> -value (W/m ² K)	<i>U</i> -value with External Render (W/m ² K)	<i>U</i> -value (W/m ² K)	<i>U</i> -value with External Render (W/m ² K)
	Wall	Insulation				
Brickwork	220	100	0,34	0,33	0,22	0,20
Brickwork	335	100	0,32	0,31	0,21	0,21
Brickwork	450	100	0,31	0,30	0,21	0,21
Brickwork	600	100	0,29	0,29	0,20	0,20
Concrete Block	200	100	0,36	0,35	0,23	0,22
Stone	220	100	0,36	-	0,23	-
Stone	342	100	0,35	-	0,22	-
Stone	455	100	0,34	-	0,22	-
Stone	610	100	0,33	-	0,21	-

NA5.3 Cavity walls

Walls constructed from Brick/Cavity/Brick, or Brick/Cavity/Block, or Block/Cavity/Block

Table NA.3 — *U*-values for external cavity walls

(a) Brick : Cavity : Brick (+13mm plaster)					
Brick mm	Air gap mm	Foam mm	Mineral wool mm	Brick mm	<i>U</i> -value
105	50	-	-	105	1,50
105	-	50	-	105	0,58
105	-	-	50	105	0,56
105	50	-	-	220	1,18
105	-	50	-	220	0,53
220	50	-	-	220	1,02
220	-	50	-	220	0,49

Table NA.3 — U-values for external cavity walls (continued)

(b) Brick : Cavity : Block (+13mm plaster)						
Brick mm	Air gap mm	Foam mm	Mineral wool mm	Concrete Block		U-value
				Heavy mm	Light mm	
105	50	-	-	100	-	1,79
105	-	50	-	100	-	0,62
105	50	-	-	-	100	0,98
105	-	50	-	-	100	0,48
105	-	-	50	-	100	0,47
105	25	75	-	-	100	0,35
105	25	-	75	-	100	0,34
105	-	100	-	-	100	0,30
105	-	-	100	-	100	0,29
(c) Block : Cavity : Block (+13 mm plaster)						
Concrete Block (outer)		Air gap mm	Air gap plus Insulation foam (mm)	Concrete Block (inner)		U-value
Heavy mm	Light mm			Heavy mm	Light mm	
100	-	50	-	100	-	2,01
100	-	-	25 + 25	100	-	0,58
-	100	50	-	-	100	0,69
-	100	-	25 + 25	-	100	0,38

NA 5.4 Timber framed external walls

Walls constructed of timber studwork with bracing plywood incorporating a 100 mm minimum gap (or wider, dependent on thickness and type of insulation used) are covered in Table NA.4.

The figures given assume that there is a vapour check and 12,7 mm of plaster internally.

Table NA.4 — Timber framed external walls

Cladding & Construction	Insulation thickness (mm)	Mineral wool U-value (W/m ² K)	PUR-Foam U-value (W/m ² K)
Tiles hanging, on battens, on Plywood	60	0,47	0,32
	100	0,34	0,22
	120	0,29	0,18
	140	0,25	0,16
	60	0,44	0,31
Shiplap Boarding on Plywood	80	0,36	0,24
	100	0,32	0,21
	120	0,28	0,18
	140	0,24	0,15
	60	0,43	0,30
Facing Brick Outer skin	80	0,36	0,24
	100	0,32	0,21
	120	0,28	0,18
	140	0,24	0,15

NA.5.5 Roofs (Flat & Pitched)

The *U*-values given in Table NA.5 are for flat or sloping roofs of timber trussed rafters, covered with slates or concrete tiles on wood battens. Ceiling joists are finished with 10/13 mm plasterboard. Mineral wool insulating fibre mat is laid between ceiling joists to the thickness shown.

Table NA.5 — Roof U-values

Cladding & Construction	Insulation thickness (mm)	<i>U</i> -value (W/m ² K)
Flat roof, chippings on felt on boards on joists with air gap and plasterboard ceiling	0	1,69
	50	0,53
	100	0,32
	200	0,17
	300	0,12
Pitched roof, with slate or tiles on sarking felt, on rafters with ventilated roof space, ceiling joists and plasterboard ceiling below.	0	3,13
	50	0,62
	100	0,35
	200	0,18
	300	0,12
Pitched, warm roof, tiles or slate on felt, on battens, with insulation between rafters and plasterboard ceiling below.	0	2,51
	50	0,60
	100	0,34
	200	0,18
	300	0,12

NA.5.6 Windows & Doors

The *U*-values given in Table NA.6 are for windows in which the frame occupies 20% of the area and the standard air-gap between individual glass panes is 12 mm. A thermal break is included.

Table NA.6 — Windows and doors

Type	Metal frame (W/m ² K)	PVC-C or wood frame (W/m ² K)
Single glazed	5,7	4,8
Double glazed	3,4	2,8
Double, low E glass	2,6	2,1
Double, low E glass, argon filled	2,4	1,9
Triple glazed	2,6	2,1
Triple, low E glass	2,0	1,6
Triple, low E, argon filled	1,9	1,5
Solid wood door	N/A	3,0

NA.5.7 Ground floors

The *U*-values given in Table NA.7 are for a medium size 15 m × 7,5 m plan detached house.

Figures should be decreased by 50 % for a terraced house.

Increase figures by up to 25 % for a small house with dimensions of 5 m × 10 m on plan.

Table NA.7 — *U*-values for ground floors

Floor type		Under floor		Above floor		<i>U</i> -value
Solid on Earth	Ventilated on Joists	Airbrick on one side only	Airbrick several sides	Bare Boards	Parquet, Lino, or Rubber	W/m ² K
	▶	▶		▶		0.61
	▶	▶			▶	0.59
	▶		▶	▶		0.82
	▶		▶		▶	0.68
▶						0.36

NA.5.8 Party and partition walls

Table NA.8 gives *U*-values for various constructions of party and partition walls.

Table NA.8 — *U*-values for party & partition walls

Brick	Breeze block	Air gap plus insulation	Air gap	Timber slats on studding	Plastered both sides	Plasterboard both sides	W/m ² K
105 mm					16 mm		1,9
220 mm					16 mm		1,5
	50 mm				16 mm		2,3
	75 mm				16 mm		2,0
		100 mm	>75 mm	100 mm		13 mm	1,7
				100 mm		13 mm	0,34
			>75 mm	100 mm	16 mm		1,9

NA.5.9 Intermediate floors

Table NA.9 gives *U*-values for various constructions of intermediate floors.

Table NA.9 — *U*-values for intermediate floors

Flooring description	Underside finish		Heat flow		<i>U</i> -value
	13 mm plasterboard	16 mm plaster	Upward	Downward	W/m ² K
Timber joists with 19 mm thick floor boards or particle board	▶		▶		1,62
	▶			▶	1,36
150 mm concrete floor slab with 19 mm timber boards on battens		▶	▶		1,49
		▶		▶	1,26
150 mm concrete floor slab with 50 mm floor screed		▶	▶		2,62
		▶		▶	2,13

Bibliography

British Standards publications

BS 5449:1990, Specification for forced circulation hot water central heating systems for domestic premises.

BS EN 12828:2003, Heating systems in buildings – Design for water-based heating systems.

BS EN 14336:2004, Heating systems in buildings – Installation and commissioning of water based heating systems.

Other publications

[1] The Chartered Institute of Building Services Engineers (CIBSE) Domestic Heating Design Guide, London.