

The European Union

EDICT OF GOVERNMENT

In order to promote public education and public safety, equal justice for all, a better informed citizenry, the rule of law, world trade and world peace, this legal document is hereby made available on a noncommercial basis, as it is the right of all humans to know and speak the laws that govern them.

EN 1996-3 (2006) (English): Eurocode 6: Design of masonry structures - Part 3: Simplified calculation methods for unreinforced masonry structures [Authority: The European Union Per Regulation 305/2011, Directive 98/34/EC, Directive 2004/18/EC]



BLANK PAGE



English Version

Eurocode 6 - Design of masonry structures - Part 3: Simplified calculation methods for unreinforced masonry structures

Eurocode 6 - Calcul des ouvrages en maçonnerie - Partie
3: Méthodes de calcul simplifiées pour les ouvrages en
maçonnerie non armée

Eurocode 6 - Bemessung und Konstruktion von
Mauerwerksbauten - Teil 3: Vereinfachte
Berechnungsmethoden für unbewehrte Mauerwerksbauten

This European Standard was approved by CEN on 24 November 2005.

CEN members are bound to comply with the CEN/CENELEC Internal Regulations which stipulate the conditions for giving this European Standard the status of a national standard without any alteration. Up-to-date lists and bibliographical references concerning such national standards may be obtained on application to the Central Secretariat or to any CEN member.

This European Standard exists in three official versions (English, French, German). A version in any other language made by translation under the responsibility of a CEN member into its own language and notified to the Central Secretariat has the same status as the official versions.

CEN members are the national standards bodies of Austria, Belgium, Cyprus, Czech Republic, Denmark, Estonia, Finland, France, Germany, Greece, Hungary, Iceland, Ireland, Italy, Latvia, Lithuania, Luxembourg, Malta, Netherlands, Norway, Poland, Portugal, Romania, Slovakia, Slovenia, Spain, Sweden, Switzerland and United Kingdom.



EUROPEAN COMMITTEE FOR STANDARDIZATION
COMITÉ EUROPÉEN DE NORMALISATION
EUROPÄISCHES KOMITEE FÜR NORMUNG

Management Centre: rue de Stassart, 36 B-1050 Brussels

Contents

| | |
|-------------------------------------------------------------------------------------------------------------------------|-----------|
| Background of the Eurocode programme..... | 4 |
| Status and field of application of Eurocodes..... | 5 |
| National Standards implementing Eurocodes | 6 |
| Links between Eurocodes and harmonised technical specifications (ENs and ETAs) for products..... | 6 |
| National Annex for EN 1996-3 | 7 |
| 1 General | 8 |
| 1.1 Scope Part 3 of Eurocode 6..... | 8 |
| 1.2 Normative references | 8 |
| 1.3 Assumptions | 8 |
| 1.4 Distinction between Principles and Application Rules | 8 |
| 1.5 Definitions..... | 9 |
| 1.5.1 General | 9 |
| 1.5.2 Masonry..... | 9 |
| 1.6 Symbols..... | 9 |
| 2 Basis of design | 10 |
| 2.1 General | 10 |
| 2.2 Basic variables..... | 10 |
| 2.3 Verification by the partial factor method | 10 |
| 3 Materials..... | 11 |
| 3.1 General | 11 |
| 3.2 Characteristic compressive strength of masonry | 11 |
| 3.3 Characteristic flexural strength of masonry..... | 11 |
| 3.4 Characteristic initial shear strength of masonry..... | 11 |
| 4 Design of unreinforced masonry walls using simplified calculation methods | 12 |
| 4.1 General | 12 |
| 4.2 Simplified calculation method for walls subjected to vertical and wind loading | 12 |
| 4.2.1 Conditions for application | 12 |
| 4.2.2 Determination of design vertical load resistance of a wall | 15 |
| 4.3 Simplified calculation method for walls subjected to concentrated loads..... | 18 |
| 4.4 Simplified calculation method for shear walls..... | 19 |
| 4.4.1 Verification of shear resistance of walls | 19 |
| 4.4.2 Design shear resistance | 20 |
| 4.5 Simplified calculation method for basement walls subject to lateral earth pressure..... | 21 |
| 4.6 Simplified calculation method for the design of walls subjected to limited lateral load but no vertical loads | 22 |
| 4.7 Simplified calculation method for the design of walls subjected to uniform lateral load but no vertical loads | 22 |

| | |
|-------------------------------------------------------------------------------------------------------------------------------------------------------------|-----------|
| Annex A (Informative) Simplified calculation method for unreinforced masonry walls of buildings not greater than 3 storeys..... | 23 |
| Annex B (Normative) Simplified calculation method for the design of internal walls not subject to vertical loads and with limited lateral load | 26 |
| Annex C (Informative) Simplified calculation method for the design of walls subjected to uniform lateral design load and no vertical loads | 30 |
| Annex D (Normative) Simplified method of determining the characteristic strength of masonry | 35 |

Foreword

This European Standard EN 1996-3 has been prepared by Technical Committee CEN/TC 250 “Structural Eurocodes”, the secretariat of which is held by BSI.

This European Standard shall be given the status of a national standard, either by publication of an identical text or by endorsement, at the latest by July 2006, and conflicting national standards shall be withdrawn at the latest by March 2010.

CEN/TC 250 is responsible for all Structural Eurocodes.

This document supersedes ENV 1996-3:1999

According to the CEN/CENELEC Internal Regulations, the national standards organizations of the following countries are bound to implement this European Standard: Austria, Belgium, Cyprus, Czech Republic, Denmark, Estonia, Finland, France, Germany, Greece, Hungary, Iceland, Ireland, Italy, Latvia, Lithuania, Luxembourg, Malta, Netherlands, Norway, Poland, Portugal, Romania, Slovakia, Slovenia, Spain, Sweden, Switzerland and United Kingdom.

Background of the Eurocode programme

In 1975, the Commission of the European Community decided on an action programme in the field of construction, based on article 95 of the Treaty. The objective of the programme was the elimination of technical obstacles to trade and the harmonisation of technical specifications.

Within this action programme, the Commission took the initiative to establish a set of harmonised technical rules for the design of construction works which, in a first stage, would serve as an alternative to the national rules in force in the Member States and, ultimately, would replace them.

For fifteen years, the Commission, with the help of a Steering Committee with Representatives of Member States, conducted the development of the Eurocodes programme, which led to the first generation of European codes in the 1980s.

In 1989, the Commission and the Member States of the EU and EFTA decided, on the basis of an agreement¹ between the Commission and CEN, to transfer the preparation and the publication of the Eurocodes to the CEN through a series of Mandates, in order to provide them with a future status of European Standard (EN). This links *de facto* the Eurocodes with the provisions of all the Council’s Directives and/or Commission’s Decisions dealing with European standards (e.g. the Council Directive 89/106/EEC on construction products -CPD- and Council Directives 93/37/EEC, 92/50/EEC and 89/440/EEC on public works and services and equivalent EFTA Directives initiated in pursuit of setting up the internal market). The Structural Eurocode programme comprises the following standards generally consisting of a number of Parts:

¹ Agreement between the Commission of the European Communities and the European Committee for Standardisation (CEN) concerning the work on Eurocodes for the design of building and civil engineering works (BC/CEN/03/89).

EN 1990, *Eurocode: Basis of structural design* .

EN 1991, *Eurocode 1: Actions on structures*.

EN 1992, *Eurocode 2: Design of concrete structures*.

EN 1993, *Eurocode 3: Design of steel structures*.

EN 1994, *Eurocode 4: Design of composite steel and concrete structures*.

EN 1995, *Eurocode 5: Design of timber structures*.

EN 1996, *Eurocode 6: Design of masonry structures*.

EN 1997, *Eurocode 7: Geotechnical design*.

EN 1998, *Eurocode 8: Design of structures for earthquake resistance*.

EN 1999, *Eurocode 9: Design of aluminium structures*.

Eurocode standards recognise the responsibility of regulatory authorities in each Member State and have safeguarded their right to determine values related to regulatory safety matters at national level where these continue to vary from State to State.

Status and field of application of Eurocodes

The Member States of the EU and EFTA recognise that Eurocodes serve as reference documents for the following purposes:

- as a means to prove compliance of building and civil engineering works with the essential requirements of Council Directive 89/106/EEC, particularly Essential Requirement N°1 – Mechanical resistance and stability – and Essential Requirement N°2 – Safety in case of fire;
- as a basis for specifying contracts for construction works and related engineering services;
- as a framework for drawing up harmonised technical specifications for construction products (ENs and ETAs).

The Eurocodes, as far as they concern the construction works themselves, have a direct relationship with the Interpretative Documents² referred to in Article 12 of the CPD, although they are of a different nature from harmonised product standards³. Therefore, technical aspects arising from the

² According to Article 3.3 of the CPD, the essential requirements (ERs) shall be given concrete form in interpretative documents for the creation of the necessary links between the essential requirements and the mandates for harmonised ENs and ETAGs/ETAs.

³ According to Article 12 of the CPD the interpretative documents shall:

- a) give concrete form to the essential requirements by harmonising the terminology and the technical bases and indicating classes or levels for each requirement where necessary;
- b) indicate methods of correlating these classes or levels of requirement with the technical specifications, e.g. methods of calculation and of proof, technical rules for project design, etc.;

Eurocodes work need to be adequately considered by CEN Technical Committees and/or EOTA Working Groups working on product standards with a view to achieving full compatibility of these technical specifications with the Eurocodes.

The Eurocode standards provide common structural design rules for everyday use for the design of whole structures and component products of both a traditional and an innovative nature. Unusual forms of construction or design conditions are not specifically covered and additional expert consideration will be required by the designer in such cases.

National Standards implementing Eurocodes

The National Standards implementing Eurocodes will comprise the full text of the Eurocode (including any annexes), as published by CEN, which may be preceded by a National title page and National foreword, and may be followed by a National Annex (informative).

The National Annex may only contain information on those parameters which are left open in the Eurocode for national choice, known as Nationally Determined Parameters, to be used for the design of buildings and civil engineering works to be constructed in the country concerned, i.e.:

- values and/or classes where alternatives are given in the Eurocode,
- values to be used where a symbol only is given in the Eurocode,
- country specific data (geographical, climatic, etc), e.g. snow map,
- the procedure to be used where alternative procedures are given in the Eurocode

and it may also contain

- decisions on the application of informative annexes,
- references to non-contradictory complementary information to assist the user to apply the Eurocode.

Links between Eurocodes and harmonised technical specifications (ENs and ETAs) for products.

There is a need for consistency between the harmonised technical specifications for construction products and the technical rules for works⁴. Furthermore, all the information accompanying the CE Marking of the construction products which refer to Eurocodes shall clearly mention which Nationally Determined Parameters have been taken into account.

This European Standard is part of EN 1996 which comprises the following parts:

Part 1-1: General *rules for reinforced and unreinforced masonry*.

c) serve as a reference for the establishment of harmonised standards and guidelines for European technical approvals.
The Eurocodes, *de facto*, play a similar role in the field of the ER 1 and a part of ER 2.

⁴ See Article 3.3 and Article 12 of the CPD, as well as clauses 4.2, 4.3.1, 4.3.2 and 5.2 of ID 1.

Part 1-2: General rules - *Structural fire design*.

Part 2: *Design considerations, selection of materials and execution of masonry*.

Part 3: *Simplified calculation methods for unreinforced masonry structures*.

EN 1996-1-1 describes the principles and requirements for safety, serviceability and durability of masonry structures. It is based on the limit state concept used in conjunction with a partial factor method. This EN 1996-3 describes simplified calculation methods to facilitate the design of unreinforced masonry walls based on the principles from EN 1996-1-1.

For the design of new structures, EN 1996 is intended to be used, for direct application, together with ENs 1990, 1991, 1992, 1993, 1994, 1995, 1997, 1998 and 1999.

EN 1996-3 is intended for use by:

- committees drafting standards for structural design and related product, testing and execution standards;
- clients (e.g. for the formulation of their specific requirements on reliability levels and durability);
- designers and contractors;
- relevant authorities.

National Annex for EN 1996-3

This standard gives some symbols for which a National value needs to be given, with notes indicating where national choices may have to be made. Therefore the National Standard implementing EN 1996-3 should have a National Annex containing all Nationally Determined Parameters to be used for the design of buildings and civil engineering works to be constructed in the relevant country.

National choice is allowed in EN 1996-3 through clauses:

- 2.3 (2)P Verification by the partial factor method
- 4.1 (P) Verification of the overall stability of a building
- 4.2.1.1 (1)P General conditions
- 4.2.2.3 (1) Capacity reduction factor
- D.1 (1) Characteristic compressive strength
- D.2 (1) Characteristic flexural strength
- D.3 (1) Characteristic initial shear strength.

1 General

1.1 Scope Part 3 of Eurocode 6

(1)P The scope of Eurocode 6 for Masonry Structures as given in 1.1.1 of EN 1996-1-1:2005 applies also to this EN 1996-3.

NOTE: Eurocode 6 deals only with the requirements for resistance, serviceability and durability of structures. Other requirements are not considered. Eurocode 6 does not cover the special requirements of seismic design.

(2)P EN 1996-3 provides simplified calculation methods to facilitate the design of the following unreinforced masonry walls, subject to certain conditions of application:

- walls subjected to vertical loading and wind loading;
- walls subjected to concentrated loads;
- shear walls;
- basement walls subjected to lateral earth pressure and vertical loads;
- walls subjected to lateral loads but not subjected to vertical loads.

(3)P The rules given in EN 1996-3 are consistent with those given in EN 1996-1-1, but are more conservative in respect of the conditions and limitations of their use.

(4) For those types of masonry structure or parts of structures not covered by (1), the design shall be based on EN 1996-1-1.

(5) This EN 1996-3 applies only to those masonry structures, or parts thereof, that are described in EN 1996-1-1 and EN 1996-2.

(6) The simplified calculation methods given in this EN 1996-3 do not cover the design for accidental situations.

1.2 Normative references

(1)P The references in 1.2 of EN 1996-1-1:2005 apply to this EN 1996-3.

1.3 Assumptions

(1)P The assumptions given in 1.3 of EN 1990:2002 apply to this EN 1996-3.

1.4 Distinction between Principles and Application Rules

(1)P The rules of 1.4 of EN 1990:2002 apply to this EN 1996-3.

1.5 Definitions

1.5.1 General

- (1) The terms and definitions given in 1.5 of EN 1990:2002 apply to this EN 1996-3.
- (2) The terms and definitions in 1.5 of EN 1996-1-1:2005 apply to this EN 1996-3.
- (3) Additional terms and definitions used in this EN 1996-2 are given the meanings contained in clause 1.5.2.

1.5.2 Masonry

1.5.2.1

basement wall

a retaining wall constructed partly or fully below ground level.

1.6 Symbols

- (1)P Material-independent symbols are given in 1.6 of EN 1990.
- (2)P For the purpose of this standard the symbols given in EN 1996-1-1 apply.
- (3)P Other symbols used in this EN 1996-3 are:

| | |
|------------|---------------------------------------------------------------------------------------------|
| b_c | is the distance apart of cross walls or other buttressing elements; |
| c | is a constant; |
| $f_{k,s}$ | is the characteristic compressive strength of masonry, determined from a simplified method; |
| f_{vdo} | is the design value of the initial shear strength; |
| f_{vdu} | is the design value of the limit to the shear strength; |
| h_a | is the average height of the building; |
| h_c | is the height of the wall under ground level |
| h_m | is the maximum height of a building allowed with the simplified calculation method; |
| k_G | is a constant; |
| l | is the length of a wall in the horizontal direction; |
| l_{bx} | is the plan dimension of a building in the x-direction; |
| l_{by} | is the plan dimension of a building in the y-direction; |
| l_f | is the span of a floor; |
| $l_{f,ef}$ | is the effective span of a floor; |
| l_{sx} | is the length of a shear wall orientated in the x-direction; |
| l_{sy} | is the length of a shear wall orientated in the y-direction; |

- $N_{Ed,max}$ is the design value of the maximum vertical load
 $N_{Ed,min}$ is the design value of the minimum vertical load
 q_{Ewd} is the design wind load per unit area;
 w_{Ek} is the characteristic wind load per unit area;
 α is the loading ratio;
 β is a constant;
 ρ_c is the weight per volume of the soil;
 Φ_s is the capacity reduction factor.

2 Basis of design

2.1 General

- (1)P The design of masonry buildings shall be in accordance with the general rules given in EN 1990.
- (2)P Specific provisions for masonry structures are given in section 2 of EN 1996-1-1:2005 and shall be applied.

2.2 Basic variables

- (1)P Actions shall be obtained from the relevant parts of EN 1991.
- (2)P Partial factors for load shall be obtained from EN 1990.
- (3)P Properties for materials and construction products and geometrical data to be used for design shall be those specified in EN 1996-1-1, or other relevant hENs of ETAs, unless otherwise indicated in this EN 1996-3.

2.3 Verification by the partial factor method

- (1)P The verification by the partial factor method shall be done according to clause 2.4 of EN 1996-1-1:2005.

NOTE: The notes to 2.4.2 of EN 1996-1-1:2005 also apply.

- (2)P The relevant values of the partial factor for materials γ_M shall be used for the ultimate limit state for ordinary situations.

NOTE: The numerical values to be ascribed to the symbol γ_M may be found in the National Annex. Recommended values are those as given in clause 2.4.3 of EN 1996-1-1:2005. The recommended values for masonry are repeated in the table below.

| Material | γ_M | | | | |
|----------------------------------------|------------|-----|-----|-----|-----|
| | Class | | | | |
| Masonry made with | 1 | 2 | 3 | 4 | 5 |
| Units of Category I, designed mortar | 1,5 | 1,7 | 2,0 | 2,2 | 2,5 |
| Units of Category I, prescribed mortar | 1,7 | 2,0 | 2,2 | 2,5 | 2,7 |
| Units of Category II | 2,0 | 2,2 | 2,5 | 2,7 | 3,0 |

END of NOTE

3 Materials

3.1 General

(1)P The materials used in the masonry walls referred to in this EN 1996-3 shall be in accordance with Section 3 of EN 1996-1-1:2005.

(2) Masonry units should be grouped as Group 1, Group 2, Group 3 or Group 4 according to clause 3.1.1 of EN 1996-1-1:2005.

NOTE: Normally the manufacturer will state the grouping of his units in his product declaration.

3.2 Characteristic compressive strength of masonry

(1)The characteristic compressive strength of masonry should be determined according to 3.6.1 of EN 1996-1-1:2005.

(2) A simplified method to determine the characteristic compressive strength of masonry for use in this document is provided in Annex D.

3.3 Characteristic flexural strength of masonry

(1) The characteristic flexural strength of masonry should be determined according to 3.6.3 of EN 1996-1-1:2005.

(2) A simplified method to determine the characteristic flexural strengths of masonry for use in this document is provided in Annex D.

3.4 Characteristic initial shear strength of masonry

(1) The characteristic initial shear strength of masonry, f_{vko} , should be determined according to 3.6.2 of EN 1996-1-1:2005.

(2) A simplified method to determine the characteristic initial shear strength of masonry for use in this document is provided in Annex D.

4 Design of unreinforced masonry walls using simplified calculation methods

4.1 General

(1)P The overall stability of a building, of which the wall forms a part, shall be verified.

NOTE: The verification may be carried out in accordance with 5.4(1) of EN 1996-1-1:2005 or from a simplified method, which may be given in the National Annex.

4.2 Simplified calculation method for walls subjected to vertical and wind loading

4.2.1 Conditions for application

4.2.1.1 General conditions

(1)P For use of the simplified method the following conditions shall be complied with:

- the height of the building above ground level shall not exceed h_m ; for buildings with a sloping roof the height shall be determined as average height h_a indicated in Figure 4.1.

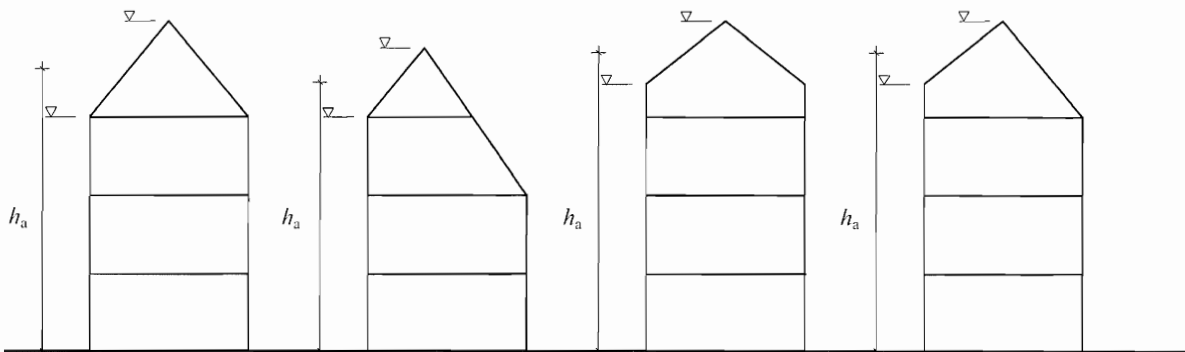

Figure 4.1 — Determination of average height

NOTE The numerical value to be ascribed to the symbol h_m for use in a country may be found in its National Annex. Recommended values, given as classes, are given in the table below.

| Class | 1 | 2 | 3 |
|-------|------|------|------|
| h_m | 20 m | 16 m | 12 m |

- the span of the floors supported by the walls shall not exceed 7,0 m;
- the span of the roof supported by the walls shall not exceed 7,0 m, except in the case of a lightweight trussed roof structure where the span shall not exceed 14,0 m;
- the clear storey height shall not exceed 3,2 m unless the overall height of the building is greater than 7,0 m, in which case the clear storey height of the ground storey may be 4,0 m.

- the characteristic values of the variable actions on the floors and the roof shall not exceed 5,0 kN/m²;
- the walls are laterally restrained by the floors and roof in the horizontal direction at right angles to the plane of the wall, either by the floors and roof themselves or by suitable methods, e.g. ring beams with sufficient stiffness according to 8.5.1.1 of EN 1996-1-1:2005
- the walls are vertically aligned throughout their height.
- the floors and roof have a bearing on the wall of at least 0,4 *t* of the thickness of the wall but not less than 75 mm;
- the final creep coefficient of the masonry ϕ_{∞} does not exceed 2,0;
- the thickness of the wall and the compressive strength of the masonry shall be checked at each storey level, unless these variables are the same at all storeys.

NOTE A further simplified calculation method, applicable to buildings not exceeding 3 storeys in height, is given in Annex A.

4.2.1.2 Additional conditions

(1) For walls acting as end supports to floors (see Figure 4.2), the simplified calculation method given in 4.2.2 may be applied only if the floor span l_f is not greater than:

$$7,0 \text{ m when } N_{Ed} \leq k_G t b f_d \quad (4.1a)$$

or

$$\text{the lesser of } 4,5 + 10 t \text{ (in m) and } 7,0 \text{ m when } f_d > 2,5 \text{ N/mm}^2 \quad (4.1b)$$

or

$$\text{the lesser of } 4,5 + 10 t \text{ (in m) and } 6,0 \text{ m when } f_d \leq 2,5 \text{ N/mm}^2 \quad (4.1c)$$

where:

- N_{Ed} is the design vertical load on the level being considered;
- t is the actual thickness of the wall, or the load bearing leaf of a cavity wall, acting as an end support, in metres;
- b is the width over which the vertical load is effective;
- f_d is the design compressive strength of the masonry;
- k_G is 0,2 for Group 1 masonry units
is 0,1 for Group 2, Group 3 and Group 4 masonry units.

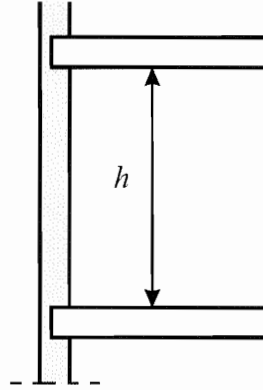

Figure 4.2 – Wall acting as end support

(2)P Walls acting as end supports to floors or roofs that are subjected to wind loading shall be designed according to 4.2.2 only if:

$$t \geq \frac{c_1 q_{Ewd} b h^2}{N_{Ed}} + c_2 h \quad (4.2)$$

where:

h is the clear storey height;

q_{Ewd} is the design wind load on the wall per unit area of the wall;

N_{Ed} is the design value of the vertical load giving the least severe effect on the wall at the top of the storey considered;

b is the width over which the vertical load is effective;

t is the actual thickness of the wall, or the load bearing leaf of a cavity wall, acting as an end support;

α is $\frac{N_{Ed}}{t b f_d}$;

c_1, c_2 are constants derived from Table 4.1.

Table 4.1 : Constants c_1 and c_2

| α | c_1 | c_2 |
|----------|-------|-------|
| 0,05 | 0,12 | 0,017 |
| 0,10 | 0,12 | 0,019 |
| 0,20 | 0,14 | 0,022 |
| 0,30 | 0,15 | 0,025 |
| 0,50 | 0,23 | 0,031 |

NOTE Linear interpolation is permitted.

NOTE Annex C gives a simplified method for lateral load design, but it may be used to obtain the thickness t instead of equation (4.2) if the design vertical load giving the most severe effect is $\frac{1}{\gamma_{AC1}} k_G b t f_d$ or less, where k_G , $\frac{1}{\gamma_{AC1}}$, b , t and f_d are as described in 4.2.1.2.

4.2.2 Determination of design vertical load resistance of a wall

4.2.2.1 General

(1)P Under the ultimate limit state it shall be verified that:

$$N_{Ed} \leq N_{Rd} \quad (4.3)$$

where:

N_{Ed} is the design vertical load on the wall;

N_{Rd} is the design vertical load resistance of the wall according to clause 4.2.2.2.

4.2.2.2 Design vertical load resistance

(1) The design vertical load resistance N_{Rd} may be determined from:

$$N_{Rd} = \Phi_s f_d A \quad (4.4)$$

where:

Φ_s is the capacity reduction factor allowing for the effects of slenderness and eccentricity of the loading, obtained from 4.2.2.3;

f_d is the design compressive strength of the masonry;

A is the loaded horizontal gross sectional area of the wall.

4.2.2.3 Capacity reduction factor

(1) The capacity reduction factor Φ_s for intermediate walls should be determined from equation (4.5a).

$$\Phi_s = 0,85 - 0,0011 \left(\frac{h_{ef}}{t_{ef}} \right)^2 \quad (4.5a)$$

For walls acting as end supports to the floors Φ_s should be determined from the lesser of equation (4.5a) or

$$\Phi_s = 1,3 - \frac{l_{f,ef}}{8} \leq 0,85 \quad (4.5b)$$

For walls at the highest level acting as end support to the top floor or roof Φ_s should be determined from the lesser of equations (4.5a), (4.5b) or

$$\Phi_s = 0,4 \quad (4.5c)$$

where:

- h_{cf} is the effective height of the wall (see 4.2.2.4);
- t_{cf} is the effective thickness determined in accordance with 5.5.1.3 of EN 1996-1-1:2005 or
- $t_{cf} = t$ for a single leaf wall
- $t_{cf} = \sqrt[3]{t_1^3 + t_2^3}$ for a cavity wall with wall ties of not less than n_{\min} , the minimum number of wall ties per m^2 , where t_1 and t_2 are the actual thicknesses of the leaves and where the modulus of elasticity of the unloaded leaf is equal to or greater than 90% of that of the loaded leaf.
- $l_{f,cf}$ is the effective span of the floor in metres for which the wall is acting as end support, as follows:
- $l_{f,cf} = l_f$ for simply supported floor structures;
- $l_{f,cf} = 0,7 l_f$ for continuous floor structures;
- $l_{f,cf} = 0,7 l_f$ for simply supported floors spanning in 2 directions where the supported length on the considered wall is not greater than two times l_f ;
- $l_{f,cf} = 0,5 l_f$ for continuous floors spanning in 2 directions where the supported length on the considered wall is not greater than two times l_f ;
- Φ_s is the capacity reduction factor which incorporates the buckling effect, the initial eccentricity, the eccentricity due to loads and the creep effect.

NOTE The value of n_{\min} for use in a country may be found in its National Annex; the recommended value is 2.

4.2.2.4 Effective height of walls

(1) The effective height may be determined by

$$h_{cf} = \rho_n h \tag{4.6}$$

where:

- h is the clear storey height;
- ρ_n is a reduction factor where $n = 2, 3$ or 4 depending on the edge restraint or stiffening of the wall.

(2) The reduction factor ρ_n may be determined as follows.

(i) For walls laterally and rotationally restrained, at top and bottom only, by reinforced or prestressed concrete floors or roofs (see Figure 4.3) and having a bearing of at least 2/3 the thickness of the wall, but not less than 85 mm:

- $\rho_2 = 1,0$ if the wall is acting as end support to a floor,
- $\rho_2 = 0,75$ for all other walls.

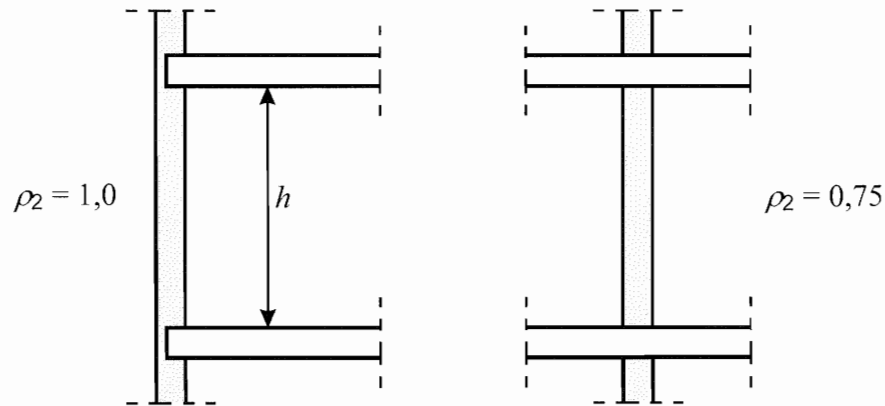

Figure 4.3 — Rotational restraint provided by floors or roof

(ii) For all walls laterally restrained at top and bottom only (e.g. by ring beams of appropriate stiffness or timber floors) but not rotationally restrained by the floors or roof (see Figure 4.4):

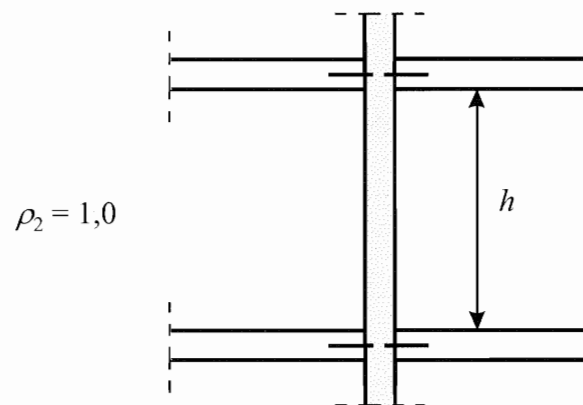

Figure 4.4 — No rotational restraint provided by floors or roof

(iii) For walls laterally restrained at top and bottom and at one vertical edge (see figure 4.5):

$$\rho_3 = 1,5 \frac{l}{h} \leq 0,75 \quad \text{in the case of rotational restraint at top and bottom only as in (i) above if the wall is not acting as end support of the floor;}$$

$$\leq 1,0 \quad \text{in all other cases in (i) and (ii) above}$$

where:

h is the clear storey height;

l is the distance from the vertically supported edge to the free edge.

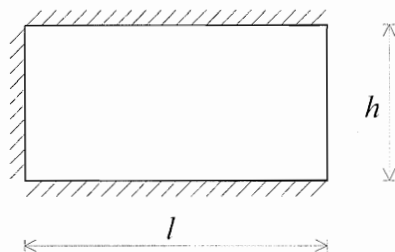

Figure 4.5 — Wall laterally restrained at top and bottom and at one vertical edge

(iv) For walls laterally restrained at top and bottom and at two vertical edges (see Figure 4.6):

$$\rho_4 = \frac{l}{2h} \leq 0,75 \quad \text{in the case of rotational restraint at top and bottom only as in (i) above if the wall is not acting as end support of the floor;}$$

$$\leq 1,0 \quad \text{in all other cases in (i) and (ii) above}$$

where:

- h is the clear storey height;
- l is the distance between the supports at the vertical edges.

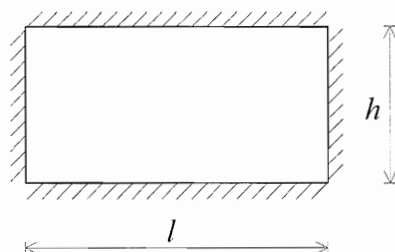

Figure 4.6 — Wall laterally restrained at top and bottom and two vertical edges

4.2.2.5 Slenderness ratio of walls

(1) The slenderness ratio of a wall h_{ef}/t_{ef} should not be greater than 27.

4.3 Simplified calculation method for walls subjected to concentrated loads

(1) The design value of the vertical concentrated load resistance of a wall, N_{Rdc} , may be obtained from:

- equation (4.7), for masonry made with Group 1 units;
- equation (4.8), for masonry made with Group 2, 3 or 4 units.

$$N_{Rdc} = f_d \left(1,2 + 0,4 \frac{a_l}{h_c}\right) A_b \quad \text{but not greater than } 1,5 f_d A_b \quad (4.7)$$

$$N_{Rdc} = f_d A_b \quad (4.8)$$

where:

- a_1 is the distance from the end of the wall to the nearest edge of the bearing area of the concentrated load (see figure 4.7);
- h_c is the height of the wall from the floor to the level of the load (see figure 4.7);
- A_b is the loaded area.

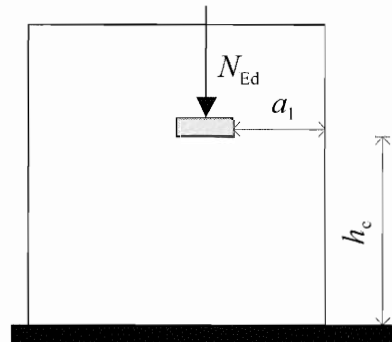

Figure 4.7 — Elevation of wall with a concentrated load, in relation to a_1 and h_c

provided that:

- the bearing area under the concentrated load neither exceeds $\frac{1}{4}$ of the cross sectional area of the wall nor exceeds the value $2t^2$, where t is the thickness of the wall;
- the eccentricity of the load from the centre plane of the wall is not greater than $t/4$;
- the adequacy of the wall at its middle height section is verified in accordance with 4.2, assuming the concentrated load spreads at an angle of 60° .

4.4 Simplified calculation method for shear walls

4.4.1 Verification of shear resistance of walls

(1)P Under the ultimate limit state, it shall be verified that:

$$V_{Ed} \leq V_{Rd} \quad (4.9)$$

where :

- V_{Ed} is the design shear load on the wall,
- V_{Rd} is the design shear resistance of the wall.

NOTE A further simplified calculation method of designing shear walls for buildings not exceeding 3 storeys in height is given in Annex A3.

4.4.2 Design shear resistance

(1) The design shear resistance V_{Rd} of a rectangular section may be determined as follows:

$$V_{Rd} = c_v \left[\frac{l}{2} - e_{Ed} \right] t f_{vdo} + 0,4 \frac{N_{Ed}}{\gamma_M} \leq 3 \left[\frac{l}{2} - e_{Ed} \right] t f_{vdu} \quad (4.10a)$$

where:

- c_v is 3 for masonry with filled perpend joints or
1,5 for masonry with unfilled perpend joints;
- l is the length of the wall in the bending direction;
- e_{Ed} is the eccentricity of the compressive load in the cross section being considered

$$e_{Ed} = \frac{M_{Ed}}{N_{Ed}} \quad (4.10b);$$

not taken less than $\frac{l}{6}$
- M_{Ed} is the design value of the moment in the cross section being considered;
- N_{Ed} is the design value of the compressive load in the cross section being considered;
- t is the thickness of the wall;
- f_{vdo} is the design value of the initial shear strength equal to f_{vko} , according to 3.4, divided by γ_M ;
- f_{vdu} is the design value of the limit to the shear strength according to 3.6.2(3) and 3.6.2(4) of EN 1996-1-1:2005.

NOTE The values of the limit to the shear strength can be found in EN 1996-1-1:2005.

(2) Equation (4.10a) may be used when:

- the masonry is not shell bedded masonry;
- the mortar is either:
 - general purpose mortar in accordance with 3.2 of EN 1996-1-1:2005 or;
 - thin layer mortar in beds of thickness 0,5 mm to 3,0 mm in accordance with EN 998-2 or;
 - lightweight mortar in accordance with EN 998-2;
- the mortar joints satisfy the requirement of 8.1.5 of EN 1996-1-1:2005;
- $N_{Ed} \leq 0,5 l t f_d$.

4.5 Simplified calculation method for basement walls subject to lateral earth pressure

(1) The following simplified method may be used for designing basement walls subject to lateral earth pressure providing the following conditions are fulfilled:

- the clear height of the basement wall, $h \leq 2,6$ m, and the wall thickness, $t \geq 200$ mm;
- the floor over the basement acts as a diaphragm and is capable of withstanding the forces resulting from the soil pressure;
- the characteristic imposed load on the ground surface in the area of influence of the soil pressure on the basement wall does not exceed 5 kN/m^2 and no concentrated load within $1,5$ m of the wall exceeds 15 kN , see figure 4.8;
- the ground surface does not rise away from the wall and the depth of fill does not exceed the wall height;
- there is no hydrostatic pressure acting on the wall;
- either no slip plane is created, for example by a damp proof course or measures are taken to resist the shear force.

NOTE For the verification of the shear action due to earth pressure a coefficient of friction of $0,6$ has been used.

(2) The design of the wall may be derived on the basis of the following expressions, as appropriate:

$$N_{\text{Ed,max}} \leq \frac{tb f_d}{3} \quad (4.11)$$

$$N_{\text{Ed,min}} \geq \frac{\rho_c b h h_c^2}{\beta t} \quad (4.12)$$

where:

$N_{\text{Ed,max}}$ is the design value of the vertical load on the wall giving the most severe effect at the mid-height of the fill;

$N_{\text{Ed,min}}$ is the design value of the the vertical load on the wall giving the least severe effect at the mid-height of the fill;

b is the width of the wall;

b_c is the distance apart of cross walls or other buttressing elements;

h is the clear height of the basement wall;

h_c is the height of the wall under ground level;

t is the wall thickness;

- ρ_c is the weight per cubic metre of the soil;
- f_d is the design compressive strength of the masonry;
- β is 20 when $b_c \geq 2h$,
- is $60 - 20 b_c / h$ when $h < b_c < 2h$,
- is 40 when $b_c \leq h$.

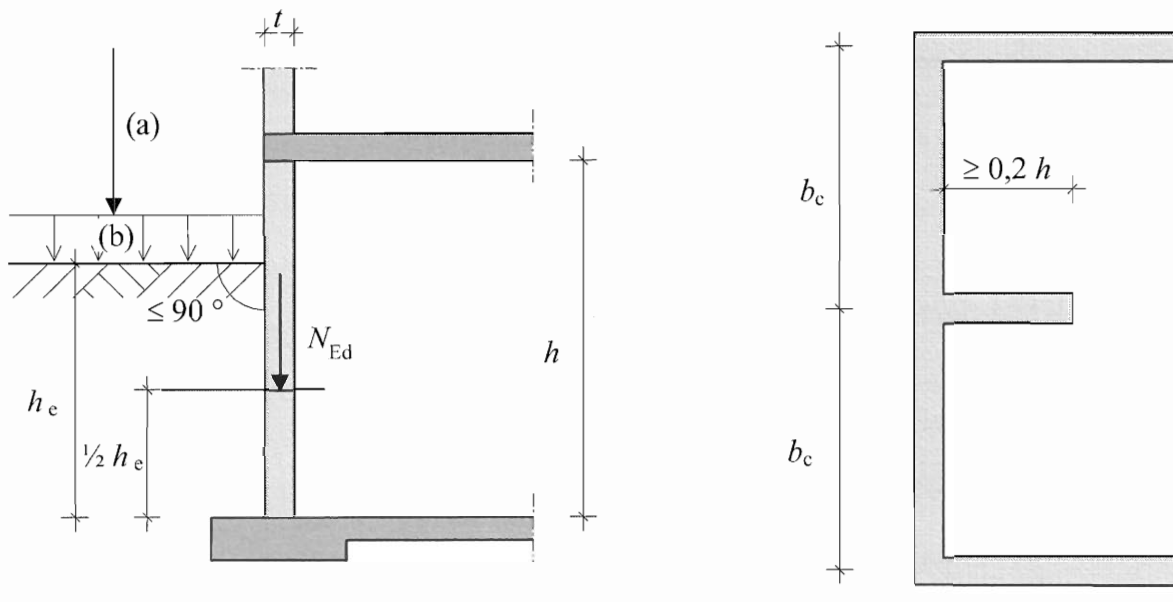

Key:

- (a) No point load ≥ 15 kN within 1,5 metres of the wall, measured in horizontal direction,
- (b) The characteristic imposed load on the ground ≤ 5 kN/m².

Figure 4.8 — Variables for basement walls shown in cross section and plan

4.6 Simplified calculation method for the design of walls subjected to limited lateral load but no vertical loads

(1) A simplified calculation method for determining the minimum thickness and limiting dimensions of internal walls, not subjected to vertical loads other than self-weight, but having variable conditions of lateral restraint, conditional on certain restrictions, is given in Annex B for walls with a limited lateral load.

4.7 Simplified calculation method for the design of walls subjected to uniform lateral load but no vertical loads

(1) Walls subjected to uniform lateral loads may be designed by a simplified method.

NOTE A simplified calculation method for determining the minimum thickness and limiting dimensions of walls having variable conditions of lateral restraint and not subject to vertical loads other than self-weight is given in Annex C for walls subject to a uniform lateral design load.

Annex A (Informative)

Simplified calculation method for unreinforced masonry walls of buildings not greater than 3 storeys

A.1 General conditions for application

(1) For buildings the simplified calculation method given in this annex may be used, provided the following conditions are fulfilled.

- the building does not exceed 3 storeys in height above the ground floor level;
- the walls are laterally restrained by the floors and roof in the horizontal direction at right angles to the plane of the wall, either by the floors and roof themselves or by suitable methods, for example ring beams with sufficient stiffness;
- the floors and roof have a bearing on the wall of at least 2/3 of the thickness of the wall but not less than 85 mm;
- the clear storey height does not exceed 3,0 m;
- the minimum plan dimension is at least 1/3 of the height;
- the characteristic values of the variable actions on the floors and the roof do not exceed 5,0 kN/m²;
- the maximum clear span of any floor is 6,0 m;
- the maximum clear span of the roof is 6,0 m, except in the case of light weight roof construction where the span does not exceed 12,0 m;
- the slenderness ratio, h_{ef}/t_{ef} , of internal and external walls is not greater than 21;

where:

- h_{ef} is the effective height of the wall in accordance with 4.2.2.4;
- t_{ef} is the effective thickness determined in accordance with 4.2.2.3.

A.2 Design vertical load resistance of the wall

(1) The design vertical load resistance N_{Rd} is given by:

$$N_{Rd} = c_A f_d A \quad (\text{A.1})$$

where:

$$c_A = 0,50 \quad \text{if } h_{ef}/t_{cf} \leq 18$$

$$= 0,36 \quad \text{if } h_{ef}/t_{cf} > 18 \text{ and } \leq 21;$$

f_d is the design compressive strength of the masonry;

A is the loaded horizontal gross cross-sectional area of the wall, excluding any openings.

A.3 Shear walls without verification of wind load resistance

(1) Shear walls may be designed without verification of the wind load resistance, if the arrangement of shear walls is sufficient to stiffen the building against horizontal forces in two perpendicular directions.

(2) The arrangement of shear walls may be presumed to be sufficient if:

- the characteristic wind load does not exceed 1,3 kN/m²;
- there are two walls or more in both perpendicular directions;
- the shear walls are load bearing and the load resistance of the shear walls excluding wind loading is verified in accordance with 4.2 assuming a reduced compressive strength of masonry of $0,8 f_k$;
- the layout of the shear walls is approximately symmetrical in plan in both directions (see Figure A.2) or at least in one direction if the ratio l_{bx}/l_{by} is not greater than 3;
- in the plan the centre lines of the shear walls do not meet in one point;
- the sum of the web areas of shear walls in each perpendicular direction, considering only webs with a length of more than $0,2 h_{tot}$ and excluding flanges, satisfies the following relationship:

$$\Sigma t l_{sx}^2 \geq c_s l_{by} h_{tot}^2 \quad \text{and} \quad \Sigma t l_{sy}^2 \geq c_s l_{bx} h_{tot}^2 \quad (\text{A.2})$$

where:

l_{bx}, l_{by} are the plan dimensions of the building considered where $l_{bx} \geq l_{by}$;

l_{sx}, l_{sy} are the shear wall lengths (see Figure A.1 and Figure A.2);

h_{tot} is the height of the building;

$c_s = c_t c_i w_{Ek}$;

c_t is a constant depending on α , obtained from Table A.1, in m²/kN;

$c_i = 1,0$ for rectangular shear walls

$= 0,67$ for I-profiled shear walls with flange areas greater than $0,4 t l$ (see Figure A1);

α is the average of the ratio $\frac{N_{Ed}}{A f_d}$ of the shear walls being considered;

N_{Ed} is the design value of the vertical load in a shear wall;

- A is the cross-sectional area of a shear wall;
- f_d is the design compressive strength of the masonry;
- w_{Ek} is the characteristic wind load, in kN/m^2 .

Table A.1 – Values of c_t [m^2/kN]

| α | f_k [N/mm^2] | | | |
|----------|---------------------------|--------|--------|----------|
| | 2 | 4 | 6 | ≥ 8 |
| 0,2 | 0,0192 | 0,0095 | 0,0064 | 0,0048 |
| 0,3 | 0,0128 | 0,0064 | 0,0042 | 0,0032 |
| 0,4 | 0,0095 | 0,0048 | 0,0032 | 0,0024 |
| 0,5 | 0,0075 | 0,0038 | 0,0025 | 0,0019 |
| 0,6 | 0,0095 | 0,0048 | 0,0032 | 0,0024 |
| 0,7 | 0,0128 | 0,0064 | 0,0042 | 0,0032 |

NOTE Linear interpolation is permitted.

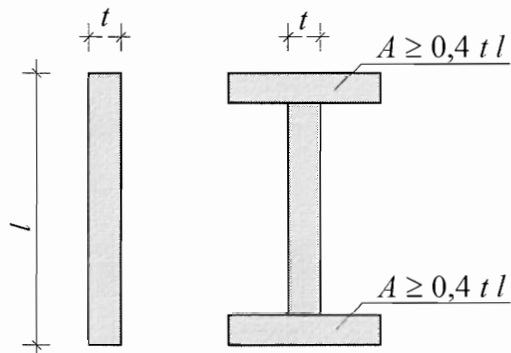

Figure A.1 – Plan of shear walls and requirement for I-shapes

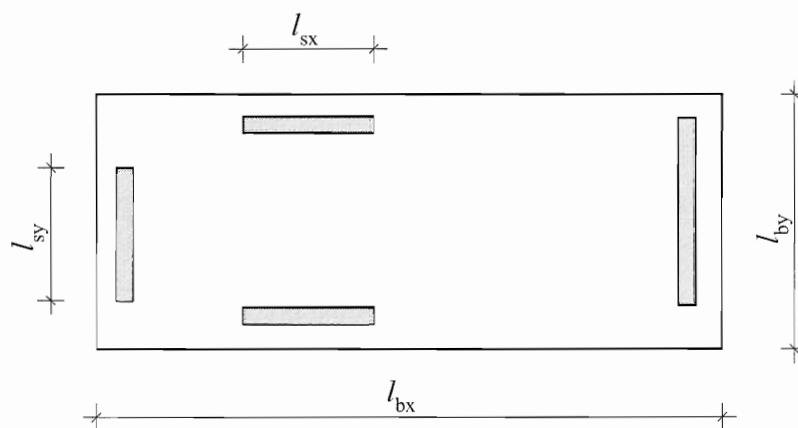

Figure A.2 – Layout of shear walls

Annex B
(Normative)

Simplified calculation method for the design of internal walls not subject to vertical loads and with limited lateral load

(1) Use of the rules given in this annex is dependent on the following dimensional and constructional requirements being adhered to:

- the clear height (h) of the wall does not exceed 6,0 m;
- the clear length (l) of the wall between structural members that give lateral restraint does not exceed 12,0 m;
- the thickness of the wall, excluding any plaster, is not less than 50 mm;
- the masonry units used for the wall construction may be any of the types referred to in EN1996-1-1:2005 under Groups 1, 2, 3 and 4.

NOTE Lateral restraints at the top, or sides, or top and sides, of a wall may need to cope with time dependent movements of the connecting structural parts (e.g. deflection due to creep of a concrete floor) and should be designed accordingly.

(2) The rules given in this clause apply only in circumstances where:

- the wall is situated inside a building;
- the external facade of the building is not pierced by a large door, or similar openings;
- the lateral loading on the wall is limited to loads from people and small furniture in rooms with small crowds of people (e.g. rooms and corridors in apartments, offices, hotels etc.);
- the wall is not subjected to any permanent or exceptional variable actions (including wind loading), other than that due to its self weight;
- the wall is not used as a support for heavy objects such as furniture, sanitary or heating equipment;
- the stability of the wall is not adversely affected by the deformation of other parts of the building (e.g. by deflection of floors) or by operations within the building;
- the effect of any door or other openings formed in the wall is taken into account (see (4) for methods of designing walls with openings);
- the effect of any chases in the wall is taken into account.

(3) The minimum thickness and limiting dimensions of the wall may be determined from Figure B.1 which provides for the following conditions of lateral restraint to the wall:

- type a: walls restrained along 4 edges;
- type b: walls restrained along all edges, except for 1 vertical edge;
- type c: walls restrained along all edges, except at the top edge;
- type d: walls restrained along the top and bottom edges only.

(4) For walls with openings the minimum thickness and limiting dimensions may also be determined from Figure B.1 provided that the type of wall is derived from the basis illustrated in Figure B.2.

The effect of openings in the wall may be ignored in the following circumstances:

- where the aggregated area of the openings is not greater than 2,5 % of the area of the wall;

and

- where the maximum area of any individual opening is not greater than 0,1 m² and the length or width of an opening is not greater than 0,5 m.

(5) Type a wall with an opening should be considered as a type b wall in which l is the greater of l_1 and l_2 , see Figure B.2.

(6) For a type c wall with an opening this annex is not applicable.

(7) For a type d wall with openings this annex is applicable for the left, middle and the right part of the wall if $l_3 \geq 2/3 l$ and $l_3 \geq 2/3 h$, see Figure B.3.

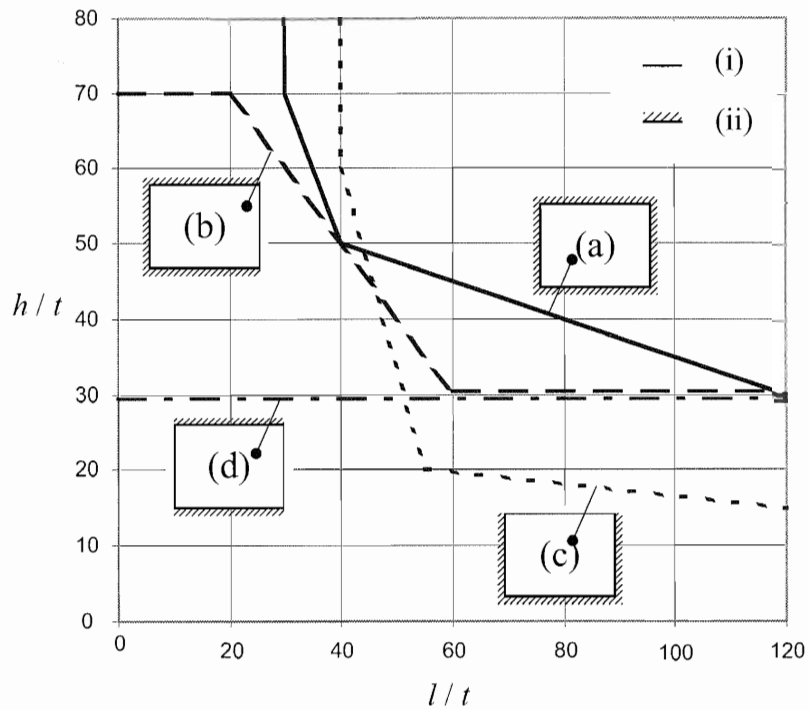

Key:

- (i) Free end
- (ii) Restrained

- (a) Type a wall
- (b) Type b wall
- (c) Type c wall
- (d) Type d wall

Figure B.1 — Limitation of size thickness ratio of internal walls not subject to vertical load but with limited lateral load

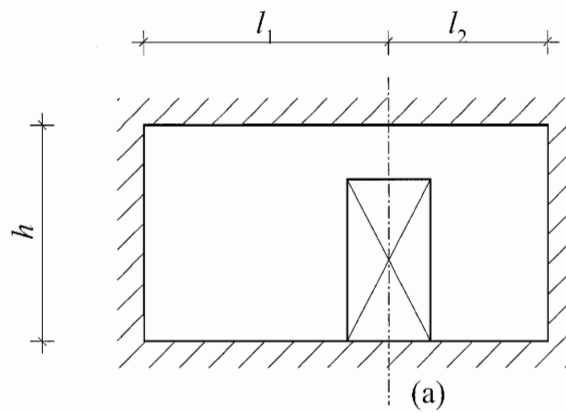

Key:

(a) Centre line of opening

Figure B.2 — Type a wall with an opening

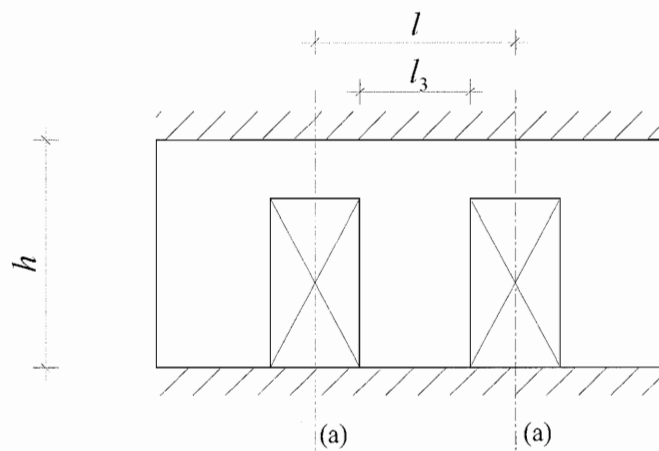

Key:

(a) Centre line of opening

Figure B.3 — Type d wall with openings

Annex C
 (Informative)

Simplified calculation method for the design of walls subjected to uniform lateral design load and no vertical loads

(1) The rules given in this clause apply only in circumstances where the dimensions of the wall fulfil the requirements from Annex B.

(2) The minimum thickness, in relation to the length and the height, for walls type a, b and c as described in Annex B,(3), may be determined from Figure C.1 to figure C.9 where:

- t is the thickness of the wall;
- l is the length of the wall;
- h is the height of the wall;
- f_{xd1} is the design flexural strength of masonry, with the plane of failure parallel to the bed joints;
- f_{xd2} is the design flexural strength of masonry, with the plane of failure perpendicular to the bed joints;
- p_{Ed} is the design value of the lateral load on the wall according to EN 1991.

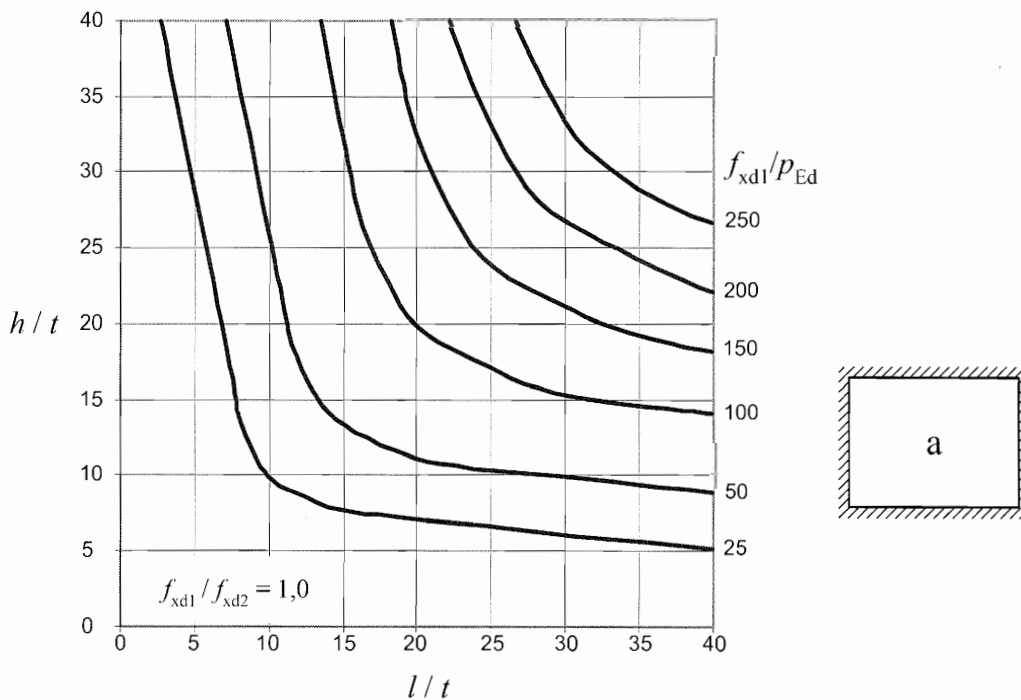

**Figure C.1 — Thickness and size limitation of non-bearing walls with lateral loading.
 Wall type a — $f_{xd1} / f_{xd2} = 1,0$**

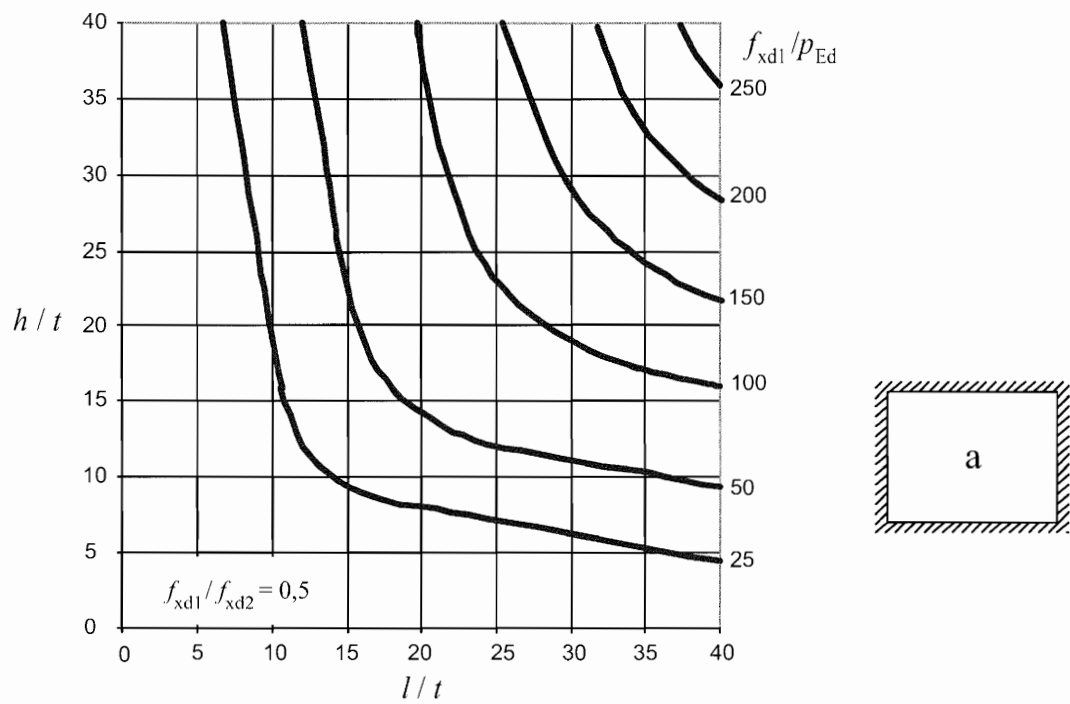

Figure C.2 — Thickness and size limitation of non-bearing walls with lateral loading.
Wall type a — $f_{xd1}/f_{xd2} = 0,5$

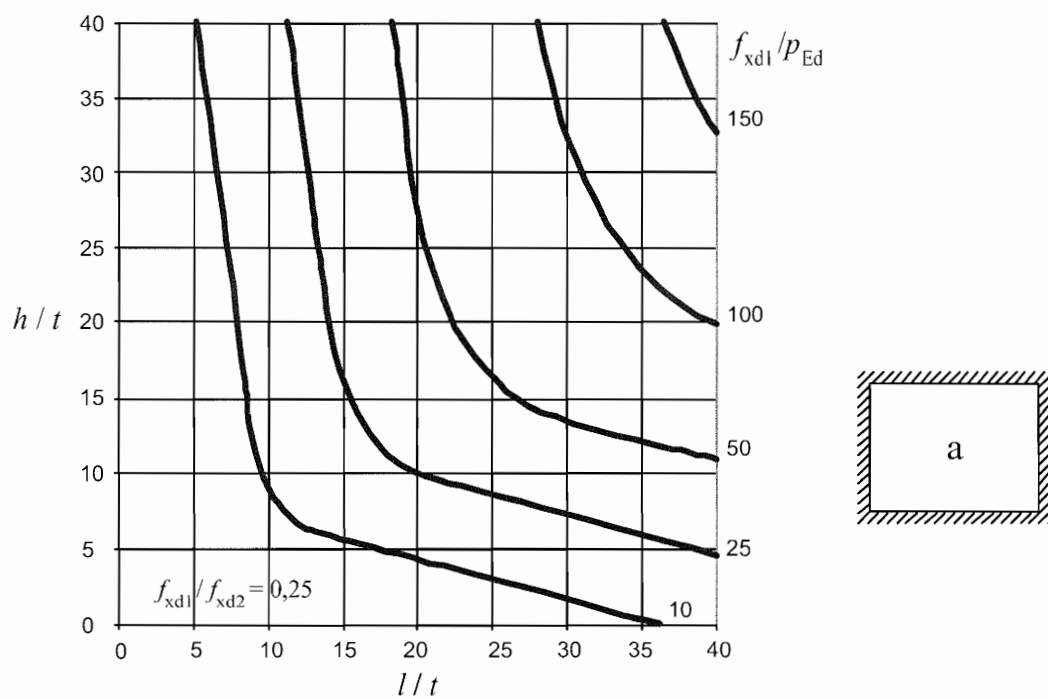

Figure C.3 — Thickness and size limitation of non-bearing walls with lateral loading.
Wall type a — $f_{xd1}/f_{xd2} = 0,25$

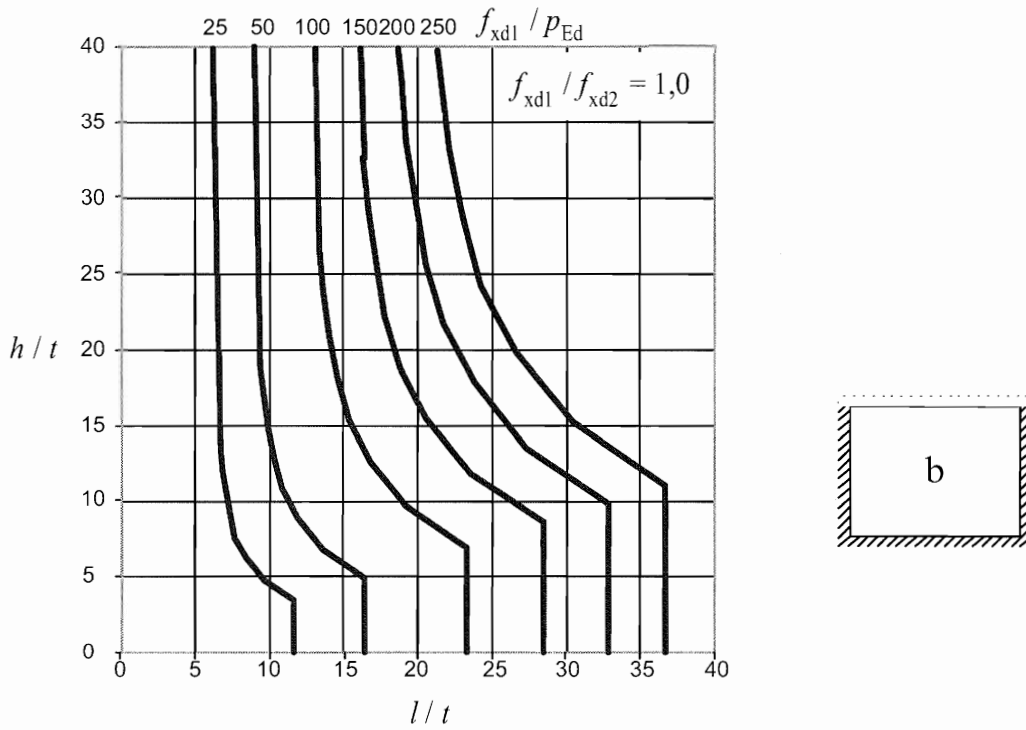

Figure C.4 — Thickness and size limitation of non-bearing walls with lateral loading.
Wall type b — $f_{xd1}/f_{xd2} = 1,0$

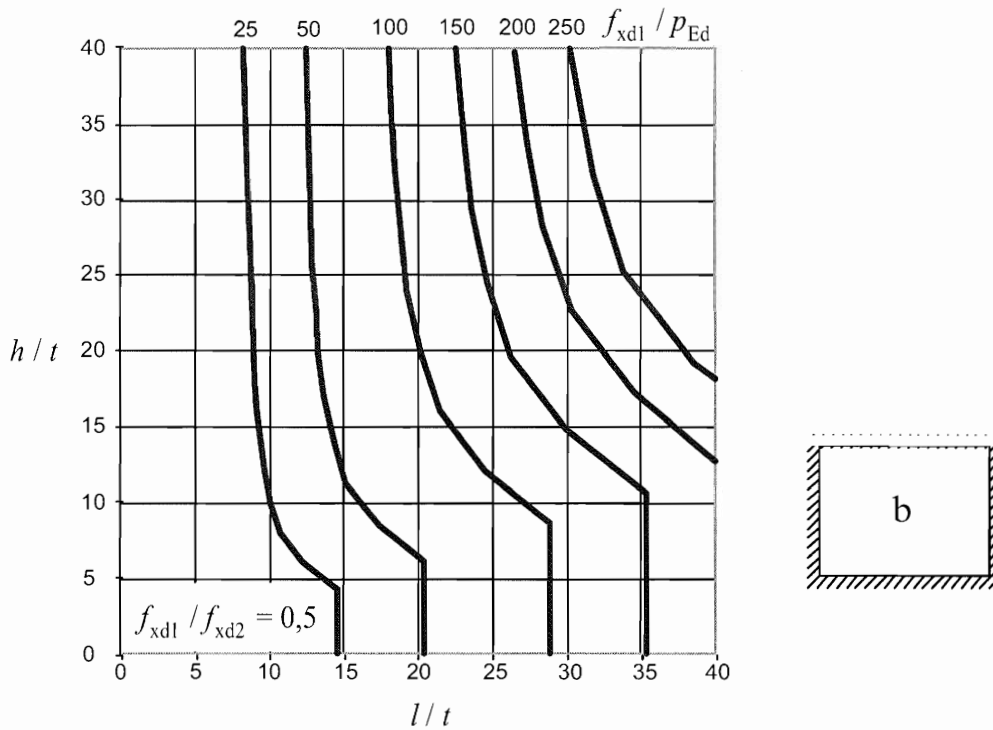

Figure C.5 — Thickness and size limitation of non-bearing walls with lateral loading.
Wall type b — $f_{xd1}/f_{xd2} = 0,5$

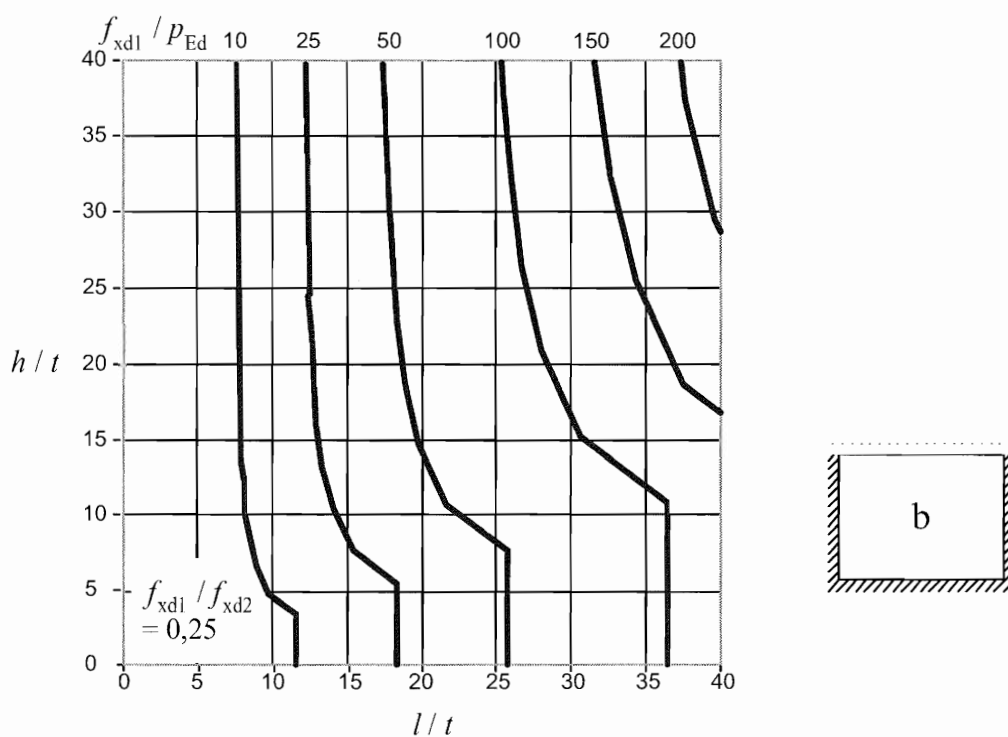

Figure C.6 – Thickness and size limitation of non-bearing walls with lateral loading.
Wall type b – $f_{xd1}/f_{xd2} = 0,25$

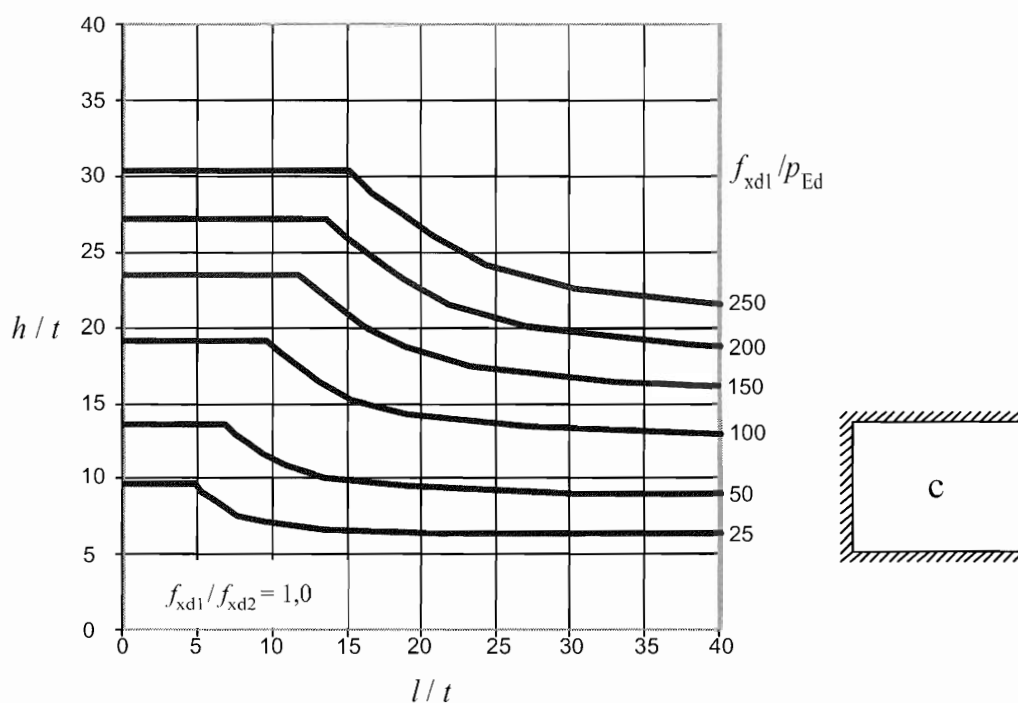

Figure C.7 – Thickness and size limitation of non-bearing walls with lateral loading.
Wall type c – $f_{xd1}/f_{xd2} = 1,0$

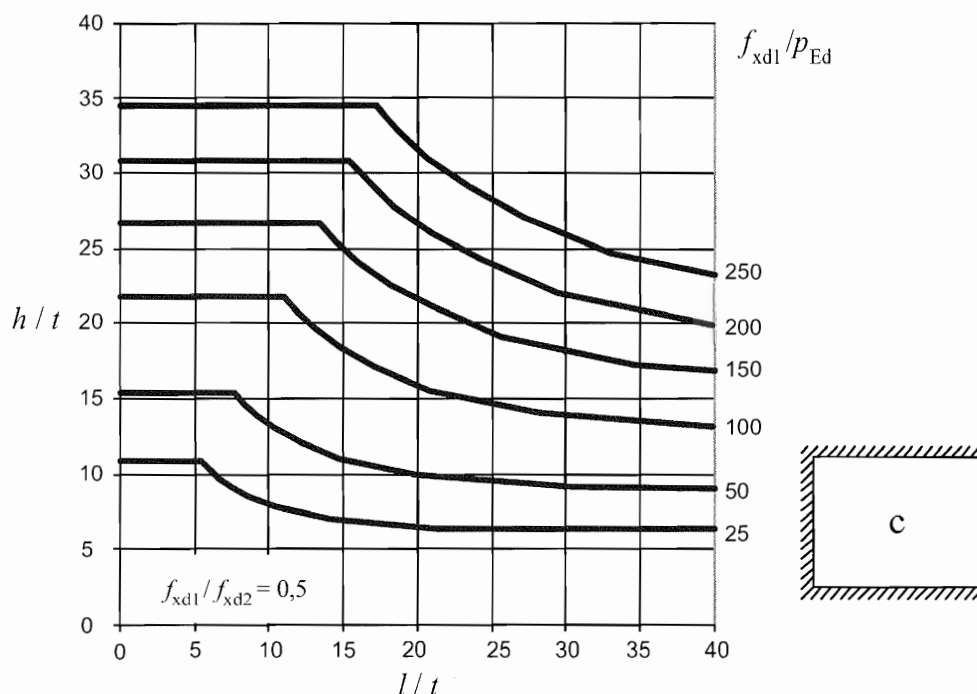

Figure C.8 — Thickness and size limitation of non-bearing walls with lateral loading.
Wall type c — $f_{xd1}/f_{xd2} = 0,5$

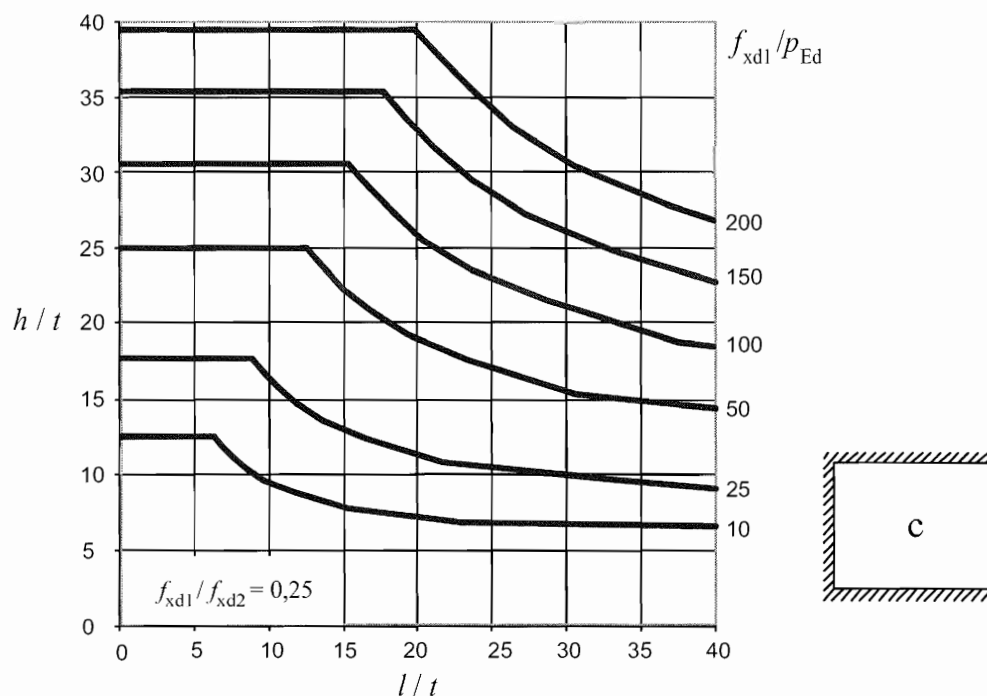

Figure C.9 — Thickness and size limitation of non-bearing walls with lateral loading.
Wall type c — $f_{xd1}/f_{xd2} = 0,25$

Annex D (Normative)

Simplified method of determining the characteristic strength of masonry

D.1 Characteristic compressive strength

(1) The characteristic compressive strength of masonry may be taken as $f_{k,s}$, the characteristic compressive strength determined from a simplified method.

NOTE Values of $f_{k,s}$ in N/mm² to be used in a country may be found in its National Annex. The following tabulated values are recommended; they are derived from clause 3.6.1.2(ii) of EN 1996-1-1:2005.

Clay Units Group 1

| f_b [N/mm ²] | General purpose mortar | | | | Thin joint | Light weight mortar | | |
|----------------------------|------------------------|------|------|------|------------|---------------------|------|------|
| | M2,5 | M5 | M10 | M20 | | M2,5 | M5 | M10 |
| 2 | 1,2 | 1,4 | 1,4 | 1,4 | 1,4 | 0,6 | 0,7 | 0,7 |
| 4 | 1,9 | 2,4 | 2,7 | 2,7 | 2,4 | 1,0 | 1,3 | 1,5 |
| 6 | 2,5 | 3,1 | 3,8 | 4,1 | 3,4 | 1,4 | 1,7 | 2,1 |
| 8 | 3,1 | 3,8 | 4,7 | 5,4 | 4,4 | 1,7 | 2,1 | 2,6 |
| 10 | 3,6 | 4,5 | 5,5 | 6,8 | 5,3 | 2,0 | 2,4 | 3,0 |
| 12 | 4,1 | 5,1 | 6,2 | 7,7 | 6,2 | 2,2 | 2,8 | 3,4 |
| 16 | 5,0 | 6,2 | 7,6 | 9,4 | 7,9 | 2,8 | 3,4 | 4,2 |
| 20 | 5,9 | 7,3 | 8,9 | 11,0 | 9,6 | 3,2 | 4,0 | 4,9 |
| 25 | 6,9 | 8,5 | 10,4 | 12,9 | 11,6 | 3,8 | 4,6 | 5,7 |
| 30 | 7,8 | 9,6 | 11,9 | 14,6 | 13,5 | 4,3 | 5,3 | 6,5 |
| 50 | 11,2 | 13,8 | 17,0 | 20,9 | 20,9 | 6,1 | 7,5 | 9,3 |
| 75 | 14,9 | 18,3 | 22,5 | 27,7 | 20,9 | 8,1 | 10,0 | 12,3 |

Clay Units Group 2

| f_b [N/mm ²] | General purpose mortar | | | | Thin joint | Light weight mortar | | |
|----------------------------|------------------------|------|------|------|------------|---------------------|-----|------|
| | M2,5 | M5 | M10 | M20 | | M2,5 | M5 | M10 |
| 2 | 1,0 | 1,1 | 1,1 | 1,1 | 1,1 | 0,5 | 0,6 | 0,6 |
| 4 | 1,6 | 1,9 | 2,2 | 2,2 | 1,8 | 0,9 | 1,1 | 1,2 |
| 6 | 2,1 | 2,6 | 3,1 | 3,3 | 2,5 | 1,2 | 1,4 | 1,7 |
| 8 | 2,5 | 3,1 | 3,8 | 4,4 | 3,0 | 1,4 | 1,7 | 2,1 |
| 10 | 3,0 | 3,7 | 4,5 | 5,5 | 3,5 | 1,6 | 2,0 | 2,5 |
| 12 | 3,4 | 4,2 | 5,1 | 6,3 | 4,0 | 1,9 | 2,3 | 2,8 |
| 16 | 4,1 | 5,1 | 6,3 | 7,7 | 4,9 | 2,3 | 2,8 | 3,5 |
| 20 | 4,8 | 5,9 | 7,3 | 9,0 | 5,7 | 2,7 | 3,3 | 4,1 |
| 25 | 5,6 | 6,9 | 8,5 | 10,5 | 6,7 | 3,1 | 3,9 | 4,7 |
| 30 | 6,4 | 7,9 | 9,7 | 12,0 | 7,6 | 3,6 | 4,4 | 5,4 |
| 50 | 9,2 | 11,3 | 13,9 | 17,1 | 10,8 | 5,1 | 6,3 | 7,7 |
| 75 | 12,2 | 15,0 | 18,4 | 22,7 | 10,8 | 6,8 | 8,3 | 10,2 |

Clay Units Group 3 and 4

| f_b [N/mm ²] | General purpose mortar | | | | Thin joint | | Light weight mortar | | |
|----------------------------|------------------------|------|------|----------------------|------------|---------|---------------------|-----|-----|
| | M2,5 | M5 | M10 | M20 | Group 3 | Group 4 | M2,5 | M5 | M10 |
| 2 | 0,7 | 0,9 | 0,9 | 0,9 | 0,8 | 0,6 | 0,4 | 0,5 | 0,5 |
| 4 | 1,2 | 1,5 | 1,7 | 1,7 | 1,3 | 1,1 | 0,7 | 0,9 | 1,0 |
| 6 | 1,6 | 2,0 | 2,4 | 2,6 | 1,8 | 1,6 | 0,9 | 1,1 | 1,4 |
| 8 | 2,0 | 2,4 | 3,0 | 3,4 | 2,1 | 2,0 | 1,1 | 1,4 | 1,7 |
| 10 | 2,3 | 2,8 | 3,5 | AC _T 4,3 | 2,5 | 2,5 | 1,3 | 1,6 | 2,0 |
| 12 | 2,6 | 3,2 | 4,0 | 4,9 | 2,8 | 2,9 | 1,5 | 1,8 | 2,3 |
| 16 | 3,2 | 4,0 | 4,9 | 6,0 | 3,5 | 3,7 | 1,8 | 2,3 | 2,8 |
| 20 | 3,8 | 4,6 | 5,7 | 7,0 | 4,1 | 4,5 | 2,1 | 2,6 | 3,2 |
| 25 | 4,4 | 5,4 | 6,6 | 8,2 | 4,8 | 5,4 | 2,5 | 3,1 | 3,8 |
| 30 | 5,0 | 6,1 | 7,6 | 9,3 | 5,4 | 6,3 | 2,8 | 3,5 | 4,3 |
| 50 | 7,1 | 8,8 | 10,8 | 13,3 | 7,7 | 9,7 | 4,1 | 5,0 | 6,2 |
| 75 | 9,5 | 11,6 | 14,3 | 17,7 AC _T | 7,7 | 9,7 | 5,4 | 6,7 | 8,2 |

Calcium silicate, aggregate concrete and autoclaved aerated concrete units Group 1

| f_b [N/mm ²] | General purpose mortar | | | | Thin joint | Light weight mortar (not for calcium silicate units) | | |
|----------------------------|------------------------|------|------|------|------------|---------------------------------------------------------|------|------|
| | M2,5 | M5 | M10 | M20 | | M2,5 | M5 | M10 |
| 2 | 1,2 | 1,4 | 1,4 | 1,4 | 1,4 | 1,0 | 1,1 | 1,1 |
| 4 | 1,9 | 2,4 | 2,7 | 2,7 | 2,6 | 1,6 | 1,9 | 2,2 |
| 6 | 2,5 | 3,1 | 3,8 | 4,1 | 3,7 | 2,1 | 2,6 | 3,1 |
| 8 | 3,1 | 3,8 | 4,7 | 5,4 | 4,7 | 2,5 | 3,1 | 3,8 |
| 10 | 3,6 | 4,5 | 5,5 | 6,8 | 5,7 | 3,0 | 3,7 | 4,5 |
| 12 | 4,1 | 5,1 | 6,2 | 7,7 | 6,6 | 3,4 | 4,2 | 5,1 |
| 16 | 5,0 | 6,2 | 7,6 | 9,4 | 8,4 | 4,1 | 5,1 | 6,3 |
| 20 | 5,9 | 7,3 | 8,9 | 11,0 | 10,2 | 4,8 | 5,9 | 7,3 |
| 25 | 6,9 | 8,5 | 10,4 | 12,9 | 12,3 | 5,6 | 6,9 | 8,5 |
| 30 | 7,8 | 9,6 | 11,9 | 14,6 | 14,4 | 6,4 | 7,9 | 9,7 |
| 50 | 11,2 | 13,8 | 17,0 | 20,9 | 22,2 | 9,2 | 11,3 | 13,9 |

Calcium silicate and aggregate concrete units Group 2

| f_b [N/mm ²] | General purpose mortar | | | | Thin joint | Light weight mortar (not for calcium silicate units) | | |
|----------------------------|------------------------|------|------|------|------------|---------------------------------------------------------|------|------|
| | M2,5 | M5 | M10 | M20 | | M2,5 | M5 | M10 |
| 2 | 1,0 | 1,1 | 1,1 | 1,1 | 1,2 | 1,0 | 1,1 | 1,1 |
| 4 | 1,6 | 1,9 | 2,2 | 2,2 | 2,1 | 1,6 | 1,9 | 2,2 |
| 6 | 2,1 | 2,6 | 3,1 | 3,3 | 3,0 | 2,1 | 2,6 | 3,1 |
| 8 | 2,5 | 3,1 | 3,8 | 4,4 | 3,8 | 2,5 | 3,1 | 3,8 |
| 10 | 3,0 | 3,7 | 4,5 | 5,5 | 4,6 | 3,0 | 3,7 | 4,5 |
| 12 | 3,4 | 4,2 | 5,1 | 6,3 | 5,4 | 3,4 | 4,2 | 5,1 |
| 16 | 4,1 | 5,1 | 6,3 | 7,7 | 6,9 | 4,1 | 5,1 | 6,3 |
| 20 | 4,8 | 5,9 | 7,3 | 9,0 | 8,3 | 4,8 | 5,9 | 7,3 |
| 25 | 5,6 | 6,9 | 8,5 | 10,5 | 10,0 | 5,6 | 6,9 | 8,5 |
| 30 | 6,4 | 7,9 | 9,7 | 12,0 | 11,7 | 6,4 | 7,9 | 9,7 |
| 50 | 9,2 | 11,3 | 13,9 | 17,1 | 18,1 | 9,2 | 11,3 | 13,8 |

Aggregate concrete units Group 3

| f_b [N/mm ²] | General purpose mortar | | | | Thin joint |
|----------------------------|------------------------|------|------|------|------------|
| | M2,5 | M5 | M10 | M20 | |
| 2 | 0,9 | 1,0 | 1,0 | 1,0 | 0,9 |
| 4 | 1,4 | 1,7 | 2,0 | 2,0 | 1,6 |
| 6 | 1,8 | 2,3 | 2,8 | 3,0 | 2,3 |
| 8 | 2,3 | 2,8 | 3,4 | 3,9 | 2,9 |
| 10 | 2,6 | 3,2 | 4,0 | 4,9 | 3,5 |
| 12 | 3,0 | 3,7 | 4,5 | 5,6 | 4,1 |
| 16 | 3,7 | 4,5 | 5,6 | 6,8 | 5,3 |
| 20 | 4,3 | 5,3 | 6,5 | 8,0 | 6,4 |
| 25 | 5,0 | 6,2 | 7,6 | 9,4 | 7,7 |
| 30 | 5,7 | 7,0 | 8,6 | 10,6 | 9,0 |
| 50 | 8,1 | 10,0 | 12,3 | 15,2 | 13,9 |

EN 998-2 gives no limit for the thickness of joints made of thin layer mortar; the values in the above tables are based on the limit on the thickness of bed joints of 0,5 m to 3 mm is to ensure that the thin layer mortar has the enhanced properties required to achieve the given values.

The thickness of the masonry is equal to the width or length of the unit, so that there is no mortar joint parallel to the face of the wall through all or any part of the length of the wall.

The coefficient of variation of the strength of the masonry units is not more than 25 %.

Where action effects are parallel to the direction of the bed joints, the characteristic compressive strength may also be determined from the tables, using the normalised compressive strength of the masonry unit, f_b , obtained from tests where the direction of application of the load to the test specimen is the same as the direction of the action effect in the masonry, but with the factor, α , as given in EN 772-1:2000, Annex A, not taken to be greater than 1,0. For Group 2 and 3 units, the value of f_k obtained from the tables should be multiplied by 0,5.

For masonry made of general purpose mortar where Group 2 and Group 3 aggregate concrete units are used with the vertical cavities filled completely with concrete, the value of f_b should be obtained by considering the units to be Group 1 with a compressive strength corresponding to the compressive strength of the units or of the concrete infill, whichever is the lesser.

When the perpend joints are unfilled, the tables may be used, with due consideration being given to any horizontal actions that might be applied to, or be transmitted by, the masonry.

For masonry made with general purpose mortar where there is a mortar joint parallel to the face of the wall through all, or any part, of the length of the wall, the values of f_k can be obtained by multiplying the values given in the tables by 0,8.

END of NOTE

D.2 Characteristic flexural strengths

(1) The characteristic flexural strengths of masonry may be taken as $f_{xk,1,s}$ and $f_{xk,2,s}$, the characteristic flexural strengths determined from a simplified method.

NOTE Values of $f_{xk,1,s}$ and $f_{xk,2,s}$ to be used in a country may be found in its National Annex. The following values are recommended; they are derived from clause 3.6.3(2) of EN 1996-1-1:2005.

| Masonry unit | $f_{xk,1,s}$ [N/mnm ²] | | | |
|-----------------------------|------------------------------------|------|-------------------|---------------------|
| | General purpose mortar | | Thin layer mortar | Light weight mortar |
| | < M5 | ≥ M5 | | |
| Clay | 0,10 | 0,10 | 0,15 | 0,10 |
| Calcium silicate | 0,05 | 0,10 | 0,20 | not used |
| Aggregate concrete | 0,05 | 0,10 | 0,20 | not used |
| Autoclaved aerated concrete | 0,05 | 0,10 | 0,15 | 0,10 |

| Masonry unit | | $f_{xk,2,s}$ [N/mnm ²] | | | |
|-----------------------------|--------------------------------------|------------------------------------|------|-------------------|---------------------|
| | | General purpose mortar | | Thin layer mortar | Light weight mortar |
| | | < M5 | ≥ M5 | | |
| Clay | | 0,20 | 0,40 | 0,15 | 0,10 |
| Calcium silicate | | 0,20 | 0,40 | 0,30 | not used |
| Aggregate concrete | | 0,20 | 0,40 | 0,30 | not used |
| Autoclaved aerated concrete | $\rho < 400$ kg/m ³ | 0,20 | 0,20 | 0,20 | 0,15 |
| | $\rho \geq 400$ kg/m ³ | 0,20 | 0,40 | 0,30 | 0,15 |

- (1) Provided that thin layer mortar and light weight mortars are M5, or stronger;
- (2) For masonry made with autoclaved aerated concrete units laid in thin layer mortar, $f_{xk,1}$ and $f_{xk,2}$ values may be taken from the tables in this note or from the following equations:

$$f_{xk,1,s} = 0,035 f_b, \text{ with filled and unfilled perpend joints;}$$

$$f_{xk,2,s} = 0,035 f_b, \text{ with filled perpend joints or } 0,025 f_b, \text{ with unfilled perpend joints.}$$

END of NOTE

D.3 Characteristic initial shear strength

(1) The characteristic initial shear strength of masonry may be taken as $f_{vk,0,s}$, the characteristic initial shear strength determined with a simplified method.

NOTE Values of $f_{vko,s}$ to be used in a country may be found in its National Annex. The following values are recommended, provided that general purpose mortars made in accordance with EN 1996-2 do not contain admixtures or additives; they are derived from Table 3.4 of EN 1996-1-1:2005.

| Masonry unit | $f_{vko,s}$ [N/mm ²] | | | |
|------------------------------------------------------|------------------------------------------------|------|-------------------|---------------------|
| | General purpose mortar of Strength Class given | | Thin layer mortar | Light weight mortar |
| Clay | M1 – M2 | 0,10 | 0,30 | 0,15 |
| | M2,5 – M9 | 0,20 | | |
| | M10 –M20 | 0,30 | | |
| Calcium silicate | M1 – M2 | 0,10 | 0,40 | 0,15 |
| | M2,5 – M9 | 0,15 | | |
| | M10 –M20 | 0,20 | | |
| Aggregate concrete Autoclaved aerated concrete | M1 – M2 | 0,10 | 0,30 | 0,15 |
| | M2,5 – M9 | 0,15 | | |
| | M10 –M20 | 0,20 | | |

END of NOTE

