

Components for slings — Safety —

Part 2: Forged steel lifting hooks with latch, Grade 8

ICS 53.020.30; 77.140.85

National foreword

This British Standard is the UK implementation of EN 1677-2:2000+A1:2008. It supersedes BS EN 1677-2:2000, which is withdrawn.

The start and finish of text introduced or altered by amendment is indicated in the text by tags. Tags indicating changes to CEN text carry the number of the CEN amendment. For example, text altered by CEN amendment A1 is indicated by **A1** **A1**.

The UK participation in its preparation was entrusted to Technical Committee MHE/1, Chains and fittings.

A list of organizations represented on this committee can be obtained on request to its secretary.

This publication does not purport to include all the necessary provisions of a contract. Users are responsible for its correct application.

Compliance with a British Standard cannot confer immunity from legal obligations.

This British Standard, having been prepared under the direction of the Engineering Sector Committee, was published under the authority of the Standards Committee and comes into effect on 15 October 2000

Amendments/corrigenda issued since publication

Date	Comments
30 September 2009	Implementation of CEN amendment A1:2008

© BSI 2009

ISBN 978 0 580 60268 9

English Version

Components for slings - Safety - Part 2: Forged steel lifting hooks with latch, Grade 8

Accessoires pour élingues - Sécurité - Partie 2: Crochets de levage en acier forgé à linguet, Classe 8

Einzelteile für Anschlagmittel - Sicherheit - Teil 2: Geschmiedete Haken mit Sicherungsklappe, Güteklasse 8

This European Standard was approved by CEN on 21 May 2000 and includes Amendment 1 approved by CEN on 21 February 2008.

CEN members are bound to comply with the CEN/CENELEC Internal Regulations which stipulate the conditions for giving this European Standard the status of a national standard without any alteration. Up-to-date lists and bibliographical references concerning such national standards may be obtained on application to the CEN Management Centre or to any CEN member.

This European Standard exists in three official versions (English, French, German). A version in any other language made by translation under the responsibility of a CEN member into its own language and notified to the CEN Management Centre has the same status as the official versions.

CEN members are the national standards bodies of Austria, Belgium, Bulgaria, Cyprus, Czech Republic, Denmark, Estonia, Finland, France, Germany, Greece, Hungary, Iceland, Ireland, Italy, Latvia, Lithuania, Luxembourg, Malta, Netherlands, Norway, Poland, Portugal, Romania, Slovakia, Slovenia, Spain, Sweden, Switzerland and United Kingdom.





EUROPEAN COMMITTEE FOR STANDARDIZATION
COMITÉ EUROPÉEN DE NORMALISATION
EUROPÄISCHES KOMITEE FÜR NORMUNG

Management Centre: rue de Stassart, 36 B-1050 Brussels

Contents

Page

Foreword.....	3
Introduction	4
1 Scope	4
2 Normative references	4
3 Terms and definitions	5
4 Hazards	5
5 Safety requirements	6
5.1 Design	6
5.2 Dimensions.....	6
5.3 Materials and heat treatment.....	9
5.4 Manufacturing methods and workmanship	9
5.5 Mechanical properties.....	9
5.6 Hook latches.....	10
6 Verification of safety requirements.....	11
6.1 Qualification of personnel	11
6.2 Type tests	11
6.3 Manufacturing test regime and acceptance criteria.....	11
6.4 Hook latches.....	11
7 Marking	12
8 Manufacturer's certificate	12
9 Instructions for use	12
Annex A (informative) Bases for the calculation of hook dimensions	13
Annex B (informative) Designation system for hooks - Grade 8.....	14
B.1 Designation	14
B.2 General format	14
Annex ZA (informative)  Relationship between this European Standard and the Essential Requirements of EU Directive 98/37/EC	15
Annex ZB (informative)  Relationship between this European Standard and the Essential Requirements of EU Directive 2006/42/EC	16

Foreword

This document (EN 1677-2:2000+A1:2008) has been prepared by Technical Committee CEN/TC 168 "Chains, ropes, webbing, slings and accessories - Safety", the secretariat of which is held by BSI.

This European Standard shall be given the status of a national standard, either by publication of an identical text or by endorsement, at the latest by October 2008, and conflicting national standards shall be withdrawn at the latest by October 2008.

This document includes Amendment 1, approved by CEN on 2008-02-21.

This document supersedes EN 1677-2:2000.

The start and finish of text introduced or altered by amendment is indicated in the text by tags \square_{A1} \square_{A1} .

This document has been prepared under a mandate given to CEN by the European Commission and the European Free Trade Association, and supports essential requirements of EU Directive(s).

For relationship with EU Directive(s), see informative Annexes ZA and ZB, which are integral parts of this document.

The other Parts of EN 1677 for components for slings are:

- Part 1: Forged steel components - Grade 8
- Part 3: Forged steel self-locking hooks - Grade 8
- Part 4: Links - Grade 8
- Part 5: Forged steel lifting hooks with latch - Grade 4
- Part 6: Links - Grade 4

Annexes A and B of this European Standard are informative.

According to the CEN/CENELEC Internal Regulations, the national standards organizations of the following countries are bound to implement this European Standard: Austria, Belgium, Bulgaria, Cyprus, Czech Republic, Denmark, Estonia, Finland, France, Germany, Greece, Hungary, Iceland, Ireland, Italy, Latvia, Lithuania, Luxembourg, Malta, Netherlands, Norway, Poland, Portugal, Romania, Slovakia, Slovenia, Spain, Sweden, Switzerland and United Kingdom.

Introduction

This European Standard has been prepared to be a harmonized standard providing one means of complying with the essential safety requirements of the Machinery Directive and associated EFTA regulations.

The hooks covered by this Part of EN 1677 are normally supplied to be part of a sling, but they may also be used for other applications. In such instances it is important that the hook design is checked to ensure its fitness for the intended use.

The extent to which hazards are covered is indicated in the scope. In addition, lifting equipment shall conform as appropriate to EN 292 for hazards that are not covered by this standard.

1 Scope

This Part of EN 1677 specifies requirements for forged steel lifting hooks with latch of grade 8 having eye or clevis and pin up to 63 t WLL, mainly for use in:

- chain slings according to EN 818-4
- steel wire rope slings according to prEN 13414-1:1999
- textile slings according to prEN 1492-1:2000, prEN 1492-2:2000

intended for lifting objects, materials or goods.

This Part of EN 1677 does not apply to hand forged hooks.

The hazards covered by this Part of EN 1677 are identified in clause 4.

Annex A is informative, and gives the bases for calculation of hook dimensions.

Annex B is informative, and gives an example of a designation system for hooks of grade 8.

A1 Annexes ZA and ZB give **A1** the relationship with EU-Directives.

2 Normative references

This European Standard incorporates, by dated or undated reference, provisions from other publications. These normative references are cited at appropriate places in the text and the publications are listed hereafter. For dated references, subsequent amendments to or revisions of any of these publications apply to this European Standard only when incorporated in it by amendment or revision. For undated references the latest edition of the publication referred to applies.

EN 292-1, Safety of machinery - Basic concepts - General principles for design - Part 1: Basic terminology, methodology

EN 292-2:1991/A1:1995, Safety of machinery - Basic concepts - General principles for design - Part 2: Technical principles and specifications (Amendment 1: 1995)

EN 818-4, Short-link chain for lifting purposes – Safety - Part 4: Chain slings Grade 8

EN 818-6:2000, Short link chain for lifting purposes - Safety - Part 6: Chain slings - Specification for information for use and maintenance to be provided by the manufacturer

EN 1050:1996, Safety of machinery - Principles of risk assessment

EN 1677-1:2000+A1:2008, Components for slings – Safety - Part 1: Forged steel components - Grade 8

EN 1492-1:2000, Textile slings – Safety - Part 1: Flat woven webbing slings made of man-made fibres

EN 1492-2:2000, Textile slings – Safety - Part 2: Round slings made of man-made fibres

prEN 13414-1:1999, Steel wire rope slings – Safety - Part 1: Wire rope slings

3 Terms and definitions

For the purpose of this Part of EN 1677, the definitions given in EN 1677-1:2000+A1:2008 apply.

4 Hazards

Accidental release of a load, or release of a load due to failure of a hook, puts at risk, either directly or indirectly, the safety or health of those persons within the danger zone.

In order to provide the necessary strength and durability of hooks, this Part of EN 1677 gives requirements for the design, manufacture and testing to ensure the specified levels of performance are met.

Since failure can be caused by the incorrect choice of grade and specification of hook, this Part of EN 1677 also gives requirements for marking and the manufacturer's certificate.

Errors in fitting can also lead to failure and this Part of EN 1677 contains dimensional requirements to allow correct fit.

Risk of injury due to sharp edges, sharp angles or rough surfaces when handling is also covered by this standard.

Those aspects of safe use associated with good practice are given in EN 818-6:2000.

Table 1 contains those hazards which require action to reduce risk identified by risk assessment as being specific and significant for forged steel lifting hooks with latch, Grade 8.

Table 1 — Hazards and associated requirements

Hazards identified in annex A of EN 1050: 1996		Relevant clause of annex A of EN 292-2: 1991/ A1: 1995	Relevant clause/subclause of this Part of EN 1677
1	Mechanical Hazard due to Inadequacy of Strength	1.3.2	5
		4.1.2.3	5
		4.1.2.5	5
		4.2.4	5
		1.7.3	7
		1.7.4	9
1.3	Cutting hazard	1.3.4	5.4
1.8	Friction or abrasion hazard	1.3.4	5.4
15	Errors of fitting Hazard	1.5.4	5.2 9
17	Falling objects	1.3.3	5.6

5 Safety requirements

5.1 Design

The articulation and relative movement shall be in accordance with 5.1 of A1 EN 1677-1:2000+A1:2008 A1 .

NOTE The form of the hook is not specified in detail. For example, a minimum value of dimension F (see figure 1) as measured in any direction is specified so that the eye of the hook can accommodate a pin, but the eye of the hook need not be circular.

The form of the upper end shall be either of the eye type or the clevis type as designated in table 2 and figure 1.

Each hook shall have a spring loaded latch conforming to 5.6 to ensure that the load cannot become accidentally unhooked.

Table 2 — Forms of hooks

Form	Description	Principal use
E	Eye type	Chain slings, wire rope slings and textile slings
C	Clevis type	Mechanically assembled chain slings

5.2 Dimensions

The principal dimensions of the hooks shall conform to table 3, in which the hook dimensions are related to the working load limit.

NOTE 1 With an eye type hook, connecting devices may be required between the hook and the rest of the sling.

NOTE 2 For direct use in wire ropeslings and textile slings, dimension F should be larger than the minimum value given in table 3.

In addition, the following requirements shall be met:

- a) the actual point height B shall be equal to or greater than the full throat opening O (see figure 1);
- b) the full throat opening O shall not exceed 95 % of the actual seat diameter D;
- c) the hook latch shall be capable of closing over the maximum diameter of bar A, as indicated in figure 1, that can be admitted through the actual throat opening O_1 .

Bought by Mrs Trina McAnulty, Certex Lifting Ltd., on 07/12/2011 10:18 Latest version. Not to be distributed/networked. For multi-user access www.bsigroup.com/license © BSI

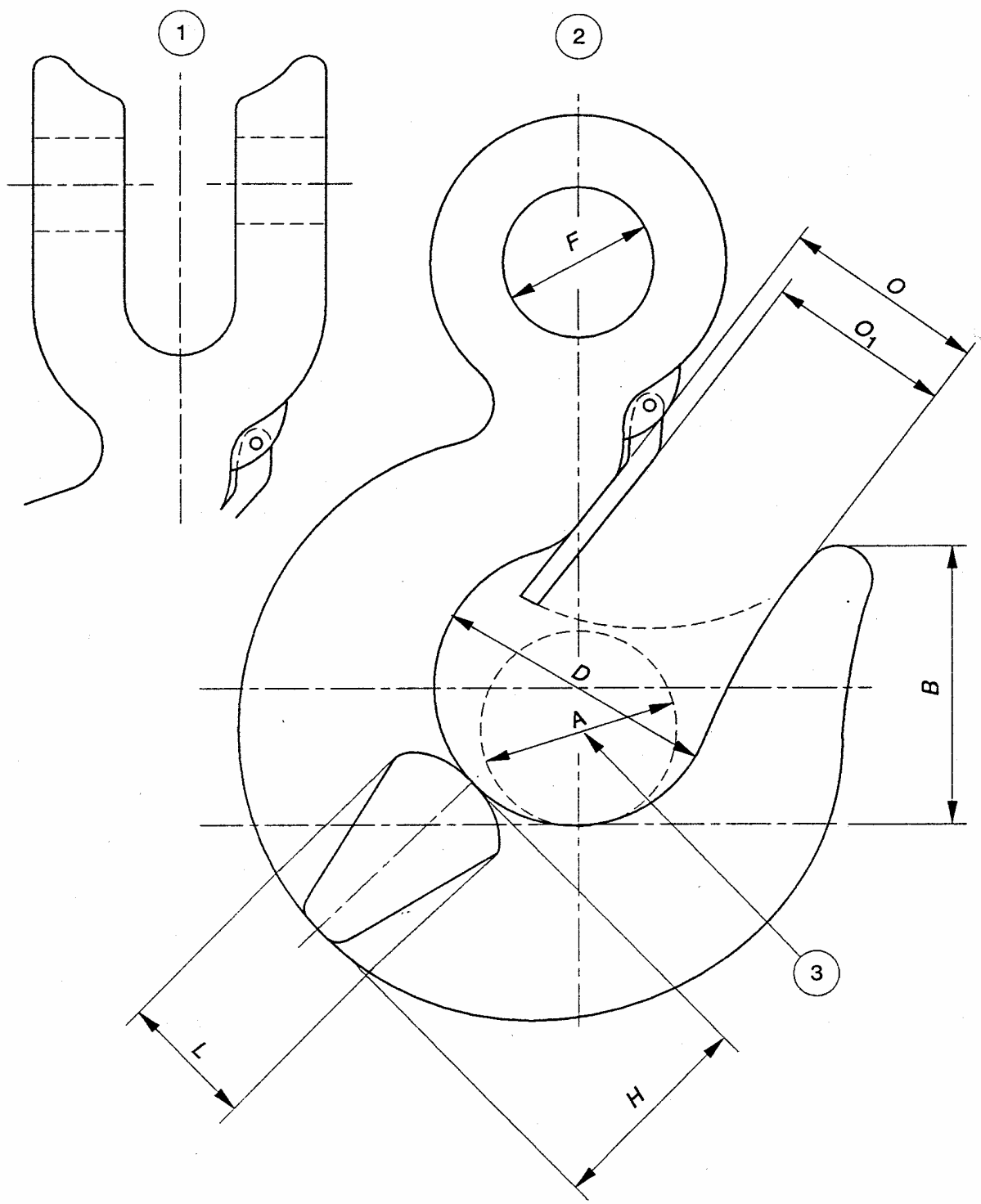

- 1 Clevis type
- 2 Eye type
- 3 Maximum diameter of bar

Figure 1 — Dimensions of hooks

Table 3 — Dimensions of hooks (see figure 1)

Code Number	Working load limit (WLL) t	D min. mm	O min. mm	O ₁ min. mm	F min. mm	H max. mm	L max. mm
3	0,25	11	8	8	6	12	8
4	0,5	15	11	11	8	17	11
5	0,8	19	14	14	10	21	14
6	1,12	22	17	16	12	25	17
7	1,5	26	20	18	14	29	20
8	2	30	23	21	16	34	23
9	2,5	34	26	24	18	38	26
10	3,15	38	29	27	20	43	29
11	4	42	32	30	23	48	32
13	5,3	49	37	35	26	55	37
14	6	52	40	37	28	59	40
16	8	60	46	43	32	68	46
18	10	67	51	48	36	76	51
19	11,2	71	54	51	38	80	54
20	12,5	75	57	53	40	85	57
22	15	82	63	58	44	93	63
23	16	85	65	60	46	96	65
25	20	95	72	68	51	107	72
26	21,2	98	75	70	52	111	75
28	25	106	81	76	57	120	81
32	31,5	119	91	85	64	135	91
36	40	134	102	96	72	152	102
40	50	150	115	107	81	170	115
45	63	168	129	120	90	190	129

5.3 Materials and heat treatment

Materials and heat treatment shall be in accordance with 5.2 of \square_{A1} EN 1677-1:2000+A1:2008 \square_{A1} .

5.4 Manufacturing methods and workmanship

Manufacturing methods and workmanship shall in accordance with 5.3 of \square_{A1} EN 1677-1:2000+A1:2008 \square_{A1} .

5.5 Mechanical properties

The mechanical properties shall conform to 5.4 of \square_{A1} EN 1677-1:2000+A1:2008 \square_{A1} .

5.6 Hook latches

The latch shall engage in the point of the hook to form a complete closure of mating surfaces. With the hook in any orientation the spring shall ensure that the latch is held positively in the closed position. Latches operated solely by gravity shall not be used.

NOTE The force required to fully open the latch should not exceed that which can be applied manually. Table 4 contains guidance on the minimum initial torque and maximum torque during latch opening necessary to fulfil these requirements.

Table 4 — Torque values for latches – guidance

Code number		Minimum initial torque	Maximum torque during opening
from	up to and including		
		Nm	Nm
3	5	0,05	0,1
6	7	0,1	0,2
8	10	0,2	0,4
11	14	0,3	0,6
16	18	0,75	1,5
19	23	1	2
25	28	2	4
32	45	3,5	7

The spring shall be constructed from corrosion protected material and shall be able to withstand at least 10 000 complete openings of the latch without fracture.

The latch shall be able to withstand force f_1 , applied across the width of the latch, equidistant between the point of the hook and the centre of rotation of the latch, and force f_2 which shall be applied across the thickness of the latch laterally to f_1 (see figure 2). Both f_1 and f_2 shall be equivalent to 300 kg or 10 % of the working load limit of the hook, whichever is the greater, but f_2 shall not exceed 20 kN.

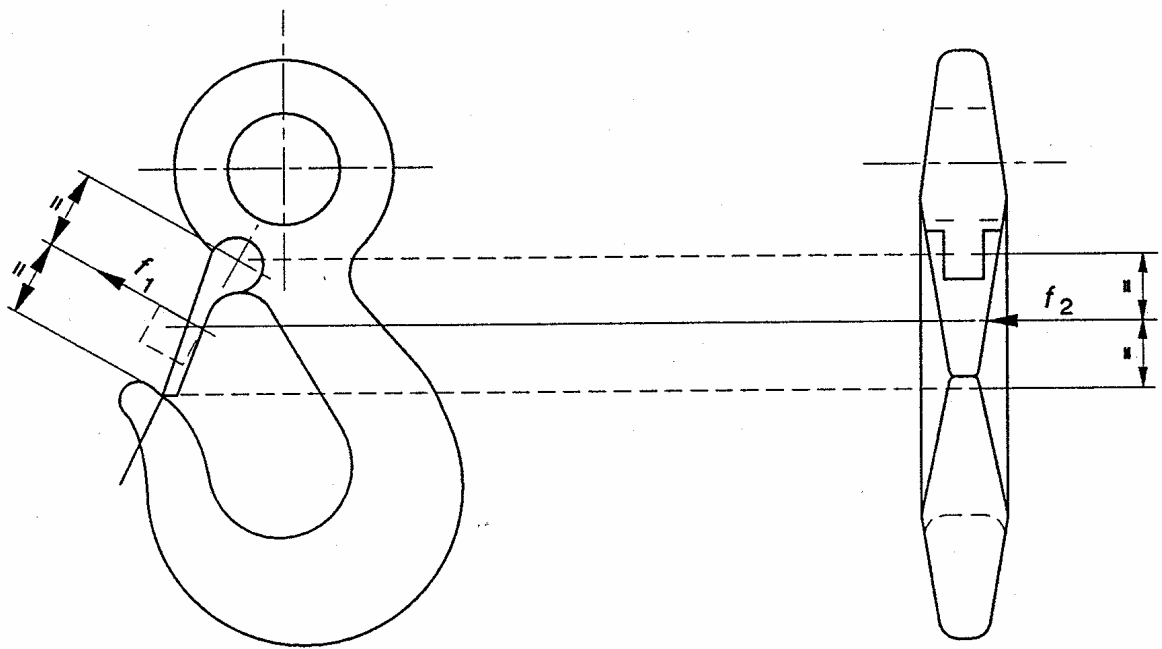

Figure 2 — Application of forces for type testing of the latch

6 Verification of safety requirements

6.1 Qualification of personnel

All testing and examination shall be carried out by a competent person.

6.2 Type tests

Type tests and acceptance criteria shall be in accordance with 6.2 of [EN 1677-1:2000+A1:2008](#).



In the tests specified in 6.2.3 to 6.2.5 of [EN 1677-1:2000+A1:2008](#) the force shall be applied to the hook axially, without shock, using a test fixture of diameter not greater than 60 % of the seat diameter, D , of the hook.

6.3 Manufacturing test regime and acceptance criteria



The manufacturing test regime and acceptance criteria shall be in accordance with [6.5](#) of [EN 1677-1:2000+A1:2008](#).

6.4 Hook latches



A type test (see 6.2 of [EN 1677-1:2000+A1:2008](#)) to verify conformity to 5.6 shall be carried out on 3 sample latches for each size of hook. The test shall be carried out with the latches in situ or in a test fixture that accurately simulates the location of the latch and hook point. Forces f_1 and f_2 shall be separately applied as indicated in figure 2. The latch shall show no permanent deformation following removal of the forces.

If any of the three samples fails the test, the latch of the size submitted for type testing shall be deemed not to conform to this Part of  EN 1677:2000+A1:2008 .



7 Marking

Marking shall be in accordance with clause 7 of  EN 1677-1:2000+A1:2008 .

8 Manufacturer's certificate

The manufacturer's certificate shall conform to clause 8 of  EN 1677-1:2000+A1:2008 .

9 Instructions for use

Instructions for use shall accompany the hooks and shall conform to the relevant clauses of  EN 818-6:2000+A1:2008 . Advice shall be given on how to assemble and disassemble forged steel clevis hooks and how to ensure the correct fit of the pin.

Annex A (informative)

Bases for the calculation of hook dimensions

The dimensions given in table 3 are derived from the following formulae:

$$D = 21,2 \sqrt{WLL}$$

$$O = 16,2 \sqrt{WLL}$$

$$O_1 = 15,1 \sqrt{WLL}$$

$$F = 11,4 \sqrt{WLL}$$

$$H = 24 \sqrt{WLL}$$

$$L = 16,2 \sqrt{WLL}$$

The dimensions (in millimetres) have been calculated using the WLL given in table 3 and rounded to the nearest whole number.

Annex B (informative)

Designation system for hooks - Grade 8

B.1 Designation

Designation of hooks should be in accordance with the general format given in B.2. The denomination of a hook should be determined by the manufacturer.

B.2 General format

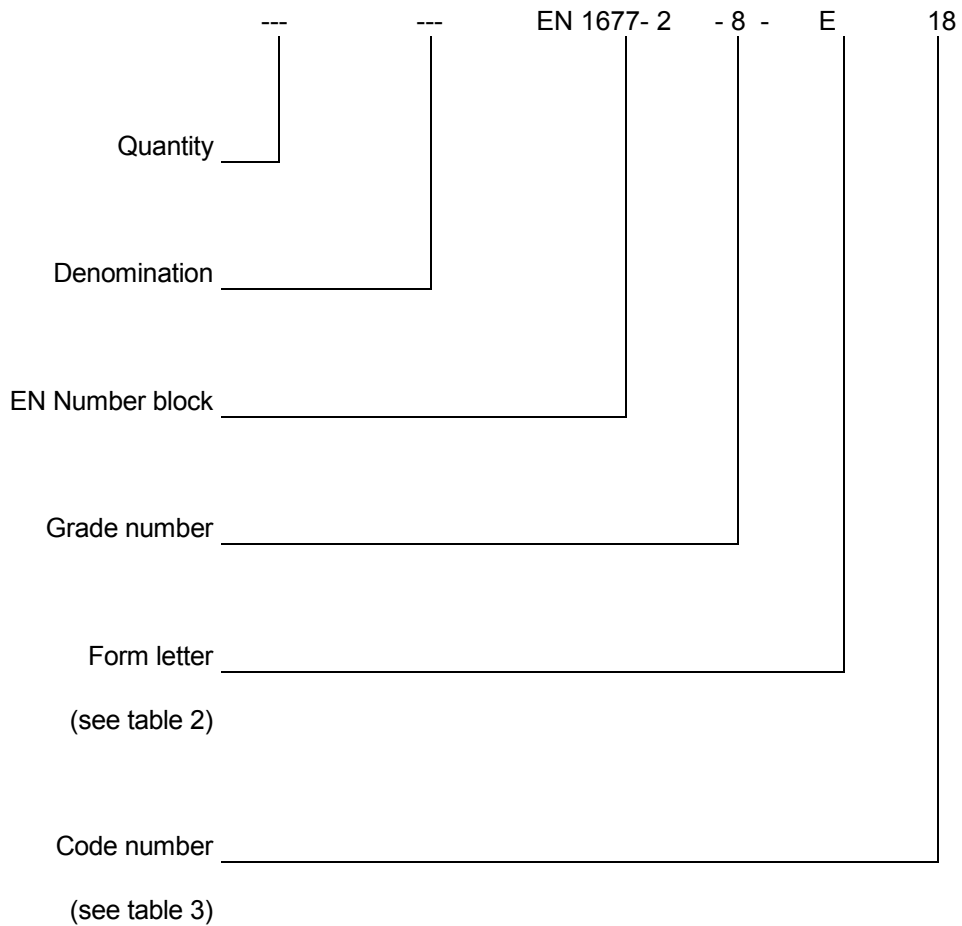

Annex ZA (informative)

A1 Relationship between this European Standard and the Essential Requirements of EU Directive 98/37/EC

This European Standard has been prepared under a mandate given to CEN by the European Commission and the European Free Trade Association to provide a means of conforming to Essential Requirements of the New Approach Directive 98/37/EC, amended by 98/79/CE on machinery.

Once this standard is cited in the Official Journal of the European Communities under that Directive and has been implemented as a national standard in at least one Member State, compliance with the normative clauses of this standard confers, within the limits of the scope of this standard, a presumption of conformity with the relevant Essential Requirements of that Directive and associated EFTA regulations.

WARNING - Other requirements and other EU Directives may be applicable to the product(s) falling within the scope of this standard. **A1**

Annex ZB (informative)

Relationship between this European Standard and the Essential Requirements of EU Directive 2006/42/EC

This European Standard has been prepared under a mandate given to CEN by the European Commission and the European Free Trade Association to provide a means of conforming to Essential Requirements of the New Approach Directive 2006/42/EC on machinery.

Once this standard is cited in the Official Journal of the European Communities under that Directive and has been implemented as a national standard in at least one Member State, compliance with the normative clauses of this standard confers, within the limits of the scope of this standard, a presumption of conformity with the relevant Essential Requirements of that Directive and associated EFTA regulations.

WARNING - Other requirements and other EU Directives may be applicable to the product(s) falling within the scope of this standard. 

BSI - British Standards Institution

BSI is the independent national body responsible for preparing British Standards. It presents the UK view on standards in Europe and at the international level. It is incorporated by Royal Charter.

Revisions

British Standards are updated by amendment or revision. Users of British Standards should make sure that they possess the latest amendments or editions.

It is the constant aim of BSI to improve the quality of our products and services. We would be grateful if anyone finding an inaccuracy or ambiguity while using this British Standard would inform the Secretary of the technical committee responsible, the identity of which can be found on the inside front cover. Tel: +44 (0)20 8996 9000. Fax: +44 (0)20 8996 7400.

BSI offers members an individual updating service called PLUS which ensures that subscribers automatically receive the latest editions of standards.

Buying standards

Orders for all BSI, international and foreign standards publications should be addressed to Customer Services. Tel: +44 (0)20 8996 9001. Fax: +44 (0)20 8996 7001 Email: orders@bsigroup.com You may also buy directly using a debit/credit card from the BSI Shop on the Website <http://www.bsigroup.com/shop>

In response to orders for international standards, it is BSI policy to supply the BSI implementation of those that have been published as British Standards, unless otherwise requested.

Information on standards

BSI provides a wide range of information on national, European and international standards through its Library and its Technical Help to Exporters Service. Various BSI electronic information services are also available which give details on all its products and services. Contact Information Centre. Tel: +44 (0)20 8996 7111 Fax: +44 (0)20 8996 7048 Email: info@bsigroup.com

Subscribing members of BSI are kept up to date with standards developments and receive substantial discounts on the purchase price of standards. For details of these and other benefits contact Membership Administration. Tel: +44 (0)20 8996 7002 Fax: +44 (0)20 8996 7001 Email: membership@bsigroup.com

Information regarding online access to British Standards via British Standards Online can be found at <http://www.bsigroup.com/BSOL>

Further information about BSI is available on the BSI website at <http://www.bsigroup.com>

Copyright

Copyright subsists in all BSI publications. BSI also holds the copyright, in the UK, of the publications of the international standardization bodies. Except as permitted under the Copyright, Designs and Patents Act 1988 no extract may be reproduced, stored in a retrieval system or transmitted in any form or by any means – electronic, photocopying, recording or otherwise – without prior written permission from BSI.

This does not preclude the free use, in the course of implementing the standard, of necessary details such as symbols, and size, type or grade designations. If these details are to be used for any other purpose than implementation then the prior written permission of BSI must be obtained.

Details and advice can be obtained from the Copyright and Licensing Manager. Tel: +44 (0)20 8996 7070 Email: copyright@bsigroup.com