

BS EN ISO 16773-2:2016



BSI Standards Publication

Electrochemical impedance spectroscopy (EIS) on coated and uncoated metallic specimens

Part 2: Collection of data

National foreword

This British Standard is the UK implementation of EN ISO 16773-2:2016. It supersedes BS EN ISO 16773-2:2007 which is withdrawn.

The UK participation in its preparation was entrusted to Technical Committee STI/10, Test methods for paints.

A list of organizations represented on this committee can be obtained on request to its secretary.

This publication does not purport to include all the necessary provisions of a contract. Users are responsible for its correct application.

© The British Standards Institution 2016.
Published by BSI Standards Limited 2016

ISBN 978 0 580 85634 1

ICS 87.040

Compliance with a British Standard cannot confer immunity from legal obligations.

This British Standard was published under the authority of the Standards Policy and Strategy Committee on 30 April 2016.

Amendments/corrigenda issued since publication

| Date | Text affected |
|------|---------------|
|------|---------------|

EUROPEAN STANDARD

EN ISO 16773-2

NORME EUROPÉENNE

EUROPÄISCHE NORM

April 2016

ICS 87.040

Supersedes EN ISO 16773-2:2007

English Version

Electrochemical impedance spectroscopy (EIS) on coated and uncoated metallic specimens - Part 2: Collection of data (ISO 16773-2:2016)

Spectroscopie d'impédance électrochimique (SIE) sur des éprouvettes métalliques revêtues et non revêtues - Partie 2: Recueil des données (ISO 16773-2:2016)

Elektrochemische Impedanzspektroskopie (EIS) an beschichteten und unbeschichteten metallischen Proben - Teil 2: Datenerfassung (ISO 16773-2:2016)

This European Standard was approved by CEN on 11 March 2016.

CEN members are bound to comply with the CEN/CENELEC Internal Regulations which stipulate the conditions for giving this European Standard the status of a national standard without any alteration. Up-to-date lists and bibliographical references concerning such national standards may be obtained on application to the CEN-CENELEC Management Centre or to any CEN member.

This European Standard exists in three official versions (English, French, German). A version in any other language made by translation under the responsibility of a CEN member into its own language and notified to the CEN-CENELEC Management Centre has the same status as the official versions.

CEN members are the national standards bodies of Austria, Belgium, Bulgaria, Croatia, Cyprus, Czech Republic, Denmark, Estonia, Finland, Former Yugoslav Republic of Macedonia, France, Germany, Greece, Hungary, Iceland, Ireland, Italy, Latvia, Lithuania, Luxembourg, Malta, Netherlands, Norway, Poland, Portugal, Romania, Slovakia, Slovenia, Spain, Sweden, Switzerland, Turkey and United Kingdom.



EUROPEAN COMMITTEE FOR STANDARDIZATION
COMITÉ EUROPÉEN DE NORMALISATION
EUROPÄISCHES KOMITEE FÜR NORMUNG

CEN-CENELEC Management Centre: Avenue Marnix 17, B-1000 Brussels

European foreword

This document (EN ISO 16773-2:2016) has been prepared by Technical Committee ISO/TC 35 “Paints and varnishes” in collaboration with Technical Committee CEN/TC 139 “Paints and varnishes” the secretariat of which is held by DIN.

This European Standard shall be given the status of a national standard, either by publication of an identical text or by endorsement, at the latest by October 2016, and conflicting national standards shall be withdrawn at the latest by October 2016.

Attention is drawn to the possibility that some of the elements of this document may be the subject of patent rights. CEN [and/or CENELEC] shall not be held responsible for identifying any or all such patent rights.

This document supersedes EN ISO 16773-2:2007.

According to the CEN-CENELEC Internal Regulations, the national standards organizations of the following countries are bound to implement this European Standard: Austria, Belgium, Bulgaria, Croatia, Cyprus, Czech Republic, Denmark, Estonia, Finland, Former Yugoslav Republic of Macedonia, France, Germany, Greece, Hungary, Iceland, Ireland, Italy, Latvia, Lithuania, Luxembourg, Malta, Netherlands, Norway, Poland, Portugal, Romania, Slovakia, Slovenia, Spain, Sweden, Switzerland, Turkey and the United Kingdom.

Endorsement notice

The text of ISO 16773-2:2016 has been approved by CEN as EN ISO 16773-2:2016 without any modification.

Contents

Page

| | |
|--|-----------|
| Foreword | iv |
| 1 Scope | 1 |
| 2 Normative references | 1 |
| 3 Terms and definitions | 1 |
| 4 Principle | 1 |
| 5 Electrochemical cell | 2 |
| 5.1 General..... | 2 |
| 5.2 Electrodes..... | 3 |
| 5.3 Exposed area..... | 3 |
| 5.4 Electrolyte..... | 3 |
| 6 Procedure | 4 |
| 6.1 Grounding..... | 4 |
| 6.2 Shielding..... | 4 |
| 6.3 Cell cable ground contacts..... | 4 |
| 6.4 Local conditions..... | 4 |
| 6.5 Measurement equipment characteristics..... | 5 |
| 6.6 Confidence test..... | 5 |
| 6.6.1 General..... | 5 |
| 6.6.2 Use of interlaboratory test cells for confidence test..... | 6 |
| 6.6.3 Error estimate and accuracy..... | 6 |
| 6.7 Specimens..... | 6 |
| 6.7.1 Preconditioning of specimens..... | 6 |
| 6.7.2 Environmental control..... | 6 |
| 6.8 Evaluation of laboratory and field coating specimens..... | 6 |
| 6.9 Number of specimens and repeatability of results..... | 7 |
| 7 Instrumental parameters | 7 |
| 7.1 General..... | 7 |
| 7.2 Conditioning potential and conditioning time..... | 8 |
| 7.3 Frequency spectrum..... | 8 |
| 7.4 Data point spacing and points per decade..... | 8 |
| 7.5 D.C. potential control..... | 8 |
| 7.6 Amplitude of perturbation..... | 9 |
| 7.7 Current range settings..... | 9 |
| 7.8 Data averaging settings..... | 9 |
| 8 Data presentation | 9 |
| 8.1 General..... | 9 |
| 8.2 Bode plot..... | 9 |
| 8.3 Nyquist plot..... | 10 |
| 9 Exchange file format | 11 |
| 10 Test report | 11 |
| Annex A (informative) Determination of maximum measurable impedance with the open-lead test | 13 |
| Annex B (normative) Data exchange file format | 15 |
| Annex C (informative) Considerations about the precise determination of the exposed area | 19 |
| Bibliography | 24 |

Foreword

ISO (the International Organization for Standardization) is a worldwide federation of national standards bodies (ISO member bodies). The work of preparing International Standards is normally carried out through ISO technical committees. Each member body interested in a subject for which a technical committee has been established has the right to be represented on that committee. International organizations, governmental and non-governmental, in liaison with ISO, also take part in the work. ISO collaborates closely with the International Electrotechnical Commission (IEC) on all matters of electrotechnical standardization.

The procedures used to develop this document and those intended for its further maintenance are described in the ISO/IEC Directives, Part 1. In particular the different approval criteria needed for the different types of ISO documents should be noted. This document was drafted in accordance with the editorial rules of the ISO/IEC Directives, Part 2 (see www.iso.org/directives).

Attention is drawn to the possibility that some of the elements of this document may be the subject of patent rights. ISO shall not be held responsible for identifying any or all such patent rights. Details of any patent rights identified during the development of the document will be in the Introduction and/or on the ISO list of patent declarations received (see www.iso.org/patents).

Any trade name used in this document is information given for the convenience of users and does not constitute an endorsement.

For an explanation on the meaning of ISO specific terms and expressions related to conformity assessment, as well as information about ISO's adherence to the WTO principles in the Technical Barriers to Trade (TBT) see the following URL: [Foreword - Supplementary information](#)

The committee responsible for this document is ISO/TC 35, *Paints and varnishes*, Subcommittee SC 9, *General test methods for paints and varnishes*.

This second edition cancels and replaces the first edition (ISO 16773-2:2007), which has been technically revised. The main changes are the following:

- a) the introductory element of the title, *Paints and varnishes*, has been omitted, because the scope is broadened to include metals and alloys and the main element of the title has been changed to: *Electrochemical impedance spectroscopy (EIS) on coated and uncoated metallic specimens*;
- b) a reference to ISO/TR 16208 has been added;
- c) considerations about the precise determination of the exposed area have been added as an informative annex;
- d) a test report has been added.

ISO 16773 consists of the following parts, under the general title *Electrochemical impedance spectroscopy (EIS) on coated and uncoated metallic specimens*:

- *Part 1: Terms and definitions*
- *Part 2: Collection of data*
- *Part 3: Processing and analysis of data from dummy cells*
- *Part 4: Examples of spectra of polymer-coated and uncoated specimens*

Electrochemical impedance spectroscopy (EIS) on coated and uncoated metallic specimens —

Part 2: Collection of data

1 Scope

This part of ISO 16773 gives guidelines for optimizing the collection of EIS data with focus on high-impedance systems. High impedance in the context of intact coatings refers to systems with an impedance greater than $10^9 \Omega \cdot \text{cm}^2$. This does not preclude measurements on systems with lower impedance. For uncoated samples extra information can be found in ISO/TR 16208.

This part of ISO 16773 deals with the following:

- instrumental set-up: requirements and pit-falls;
- data validation: checking the measurement range and the accuracy of the data;
- performing an EIS measurement: specimen considerations and instrumental parameters;
- the experimental results: different methods of presenting EIS data.

These guidelines are intended to ensure the acquisition of EIS data that can be used to study the performance of the specimen. This part of ISO 16773 does not give guidelines for the interpretation of the data.

2 Normative references

The following documents, in whole or in part, are normatively referenced in this document and are indispensable for its application. For dated references, only the edition cited applies. For undated references, the latest edition of the referenced document (including any amendments) applies.

ISO 16773-1, *Electrochemical impedance spectroscopy (EIS) on coated and uncoated metallic specimens — Part 1: Terms and definitions*

3 Terms and definitions

For the purposes of this document, the terms and definitions given in ISO 16773-1 apply.

4 Principle

A so-called “confidence” test is described in order to check the suitability of the entire set-up and recommendations are given as to how to perform EIS experiments. For convenience, only potentiostatically controlled EIS measurements are described, although it is also possible to make EIS measurements under galvanostatic control.

A potentiostat is connected either to a dummy cell or to an electrochemical cell (with working, counter- and reference electrodes). A single-sinusoidal- or multi-sinusoidal-waveform potential, either in conjunction with a d.c. offset or not, is applied by the potentiostat to the dummy cell or to the electrochemical cell, and the resulting a.c. current is measured. Both potential and a.c. current data are collected and analysed for amplitude and phase shift. This can be done in a variety of ways, depending

on the type of equipment used. All data are presented and compared graphically or computed for equivalent circuits. In the case of the dummy cell, the values of these equivalent components are compared to the actual cell components connected to the potentiostat and evaluated for coherence.

5 Electrochemical cell

5.1 General

NOTE 1 Various types of measurement cell exist which are suitable for use with this part of ISO 16773. Most commonly used are two-electrode and three-electrode arrangements for measurements in an aqueous electrolyte.

The cell shall be constructed of materials that will not corrode, otherwise deteriorate or contaminate the solution (e.g. PMMA, PTFE or glass). A material compatibility test should be carried out.

The cell shall be leak-proof to ensure that the geometrical surface of the specimen does not change with time. Use an electrically insulating gasket material (O-ring, etc.) for the seal, i.e. with a through-thickness resistance much greater than that of the coating.

The cell should preferably be designed to allow the following items to be inserted into the electrolyte chamber: the working electrode, the reference electrode, the counter-electrode, a thermometer (for temperature control) and gas inlet/outlet tubes to modify the oxygen content of the electrolyte. When using an inert gas, a gas scrubber should be used.

An example of an electrochemical cell is shown in [Figure 1](#).

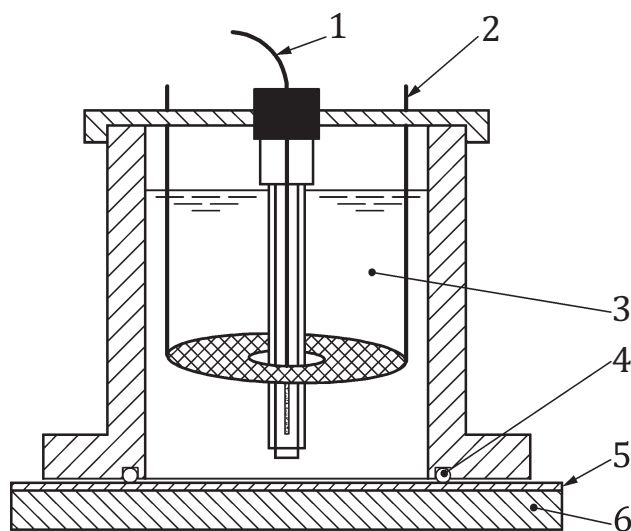

Key

- 1 reference electrode
- 2 counter electrode
- 3 electrolyte
- 4 O-ring
- 5 coating
- 6 working electrode

Figure 1 — Example of an electrochemical cell

NOTE 2 Other designs can be suitable.

For uncoated metallic specimens, IR drop should be considered.

The components shown in [Figure 1](#) are described in [5.2](#) to [5.4](#).

5.2 Electrodes

To perform EIS in aqueous solution, the more conventional set-up is composed of a three-electrode arrangement: a working electrode, a reference electrode and a counter-electrode.

Working electrode: A conductive substrate covered by the coating to be investigated. A large surface area is preferred to better take into account any defects and to decrease the impedance of the system to give a better signal-to-noise ratio.

Counter electrode: Inert material such as platinum with a large surface area oriented parallel to the working electrode in order to ensure a homogeneous current distribution.

Reference electrode: A low-impedance and low-noise reference electrode is recommended, according to supplier's user manual [when testing organic coatings, a salt bridge (e.g. Luggin capillary) is not required]. The potential of the reference electrode should be checked periodically to control the accuracy of the electrode and its stability with time. At very high frequencies, the presence of the reference electrode can induce some spurious effects.

NOTE 1 To improve the quality of the high-frequency signal, a platinum wire with a capacitor may be placed in parallel with the reference electrode. The capacitor ensures that the d.c. potential is coming from the reference electrode and a.c. potential from the platinum wire.

NOTE 2 For specific applications, it can be acceptable to use a pseudo-reference electrode consisting of an inert material such as a high-nickel alloy or a chloridized silver wire. Pseudo-reference electrodes are useful for measurements in the field, where a reference electrode can be easily broken.

5.3 Exposed area

The exposed area should be known, constant with time, and should be adequate for the investigation. The larger the exposed area the more sensitive the measurement is to single defects (pores) and the better the signal-to-noise ratio.

If an O-ring is used, the precise exposed area shall be determined under compression (see [Annex C](#) for a recommended technique).

NOTE For example, when using an O-ring with a diameter of 1,2 cm and an approximate exposed area of 1,13 cm², an error of up 37 % can occur. When using an O-ring with a diameter of 4,7 cm and an approximate exposed area of 18 cm², an error of up 8 % can occur.

It is recommended that the user selects the largest possible area without defects. A typical area is in the order of magnitude of 10 cm².

5.4 Electrolyte

The resistance of the solution should be low in comparison to the impedance of the investigated system. Different types of electrolyte can be used. Non-aggressive electrolytes can be employed to characterize the properties of the system without introducing corrosion. An aggressive solution may be selected to characterize the corrosion resistance of the system. The electrolyte should be chosen with the end use in mind.

NOTE 1 For the desired end-use, the pH value, the concentration and the composition of the electrolyte might be important parameters.

When the oxygen content is influencing the corrosion, the preconditioning has to be chosen in a way that a steady state is established.

NOTE 2 Purging with oxygen or an inert gas could be necessary to obtain steady state condition.

6 Procedure

6.1 Grounding

An EIS instrument consists of a potentiostat, a computer and a module or instrument specifically required for the impedance measurement.

Electrical grounding considerations between the instruments, the specimen and the environment are important, both for the safety of the operator and the acquisition of as accurate and noise-free EIS data as possible.

- a) The safety of the operator is important. The chassis of the EIS instrument should be connected to ground to avoid a potentially lethal electrical shock if the instrument malfunctions. The chassis is normally grounded through the connection to the a.c. mains. Under no circumstances should this connection to ground be bypassed.
- b) In most cases, the coated specimen is tested in the laboratory in an electrochemical cell such as that described in [5.1](#) in which the specimen is electrically isolated from ground, or “floating”. This is the simplest case with no special consideration needed for connection of the instrument to the specimen.
- c) If, however, the coated specimen is grounded, then the grounding considerations become more complex. This could happen if EIS is used to test coated structures in a field, such as vessels or pipelines. If the coated specimen is grounded, then the EIS instrument should be electrically isolated from ground to obtain accurate EIS data. This is not a trivial consideration and is generally taken into account during the design of the EIS system. Floating the EIS system by bypassing the protective ground connection to the mains is a safety hazard and is not acceptable.
- d) When connecting up the various instruments and computers, it is possible to inadvertently ground a floating instrument through the connection to a grounded instrument. This can give rise to noise through “ground loops” or even result in improper operation.

6.2 Shielding

Shielding is very important for noise considerations in EIS measurements of high-impedance specimens. Proper shielding will ensure that the cell electrodes and cables will not pick up electromagnetic radiation from the surroundings. The electrochemical cell should be placed inside a Faraday cage and the Faraday cage connected to an appropriate ground connection of the potentiostat. If the potentiostat has an externally mounted electrometer, the electrometer should also be put inside the Faraday cage. The manufacturer’s manual should be consulted to ensure proper wiring.

6.3 Cell cable ground contacts

The connections between the cell cables and the cell should be clean and the length of the cables should be as short as possible to minimize stray capacitance.

6.4 Local conditions

The following conditions in the vicinity of the EIS experiment can affect the quality of the measurement.

- a) The incoming a.c. power to the EIS instrument can be noisy or exhibit large voltage transients, both of which can result in noise in the electrochemical data. If severe, the user may install an a.c. line conditioner. The raw potential and current data are usually averaged by the EIS instrument and are not as susceptible to line noise as d.c. experiments.
- b) Electromagnetic noise from electrical devices (e.g. computer monitors) in the local vicinity of the EIS experiment can also contribute to noise in the experiment. Again, data processing will discriminate against this noise. Instruments or appliances that operate intermittently (e.g. freezers, ovens, ultrasonic cleaners, magnetic stirrers, water baths) are particularly troublesome because

they can introduce noise in the electrical circuit when they are activated. These devices should be operated on a different circuit, if possible. Because of the low current levels which are typically observed in EIS experiments on coated specimens, the specimen should always be contained in a Faraday cage that is connected to the appropriate instrument ground.

- c) The relative humidity in the environment can also be of concern. If the relative humidity is high, then micro-condensation can occur in the electronics of the EIS instrument, providing a low-impedance leakage path. At the low current levels typically encountered in EIS experiments on coated specimens, this can result in errors in the current measurement.

6.5 Measurement equipment characteristics

An electrochemical cell has impedance values that can range from 1 m Ω to more than 1 T Ω (10^{12} Ω). The measured impedance of coated specimens can range up to 10^{12} Ω .

A specimen with high impedance will exhibit very low current flow during the EIS experiment. Therefore, the instrument used to measure the EIS of coated specimens needs to be capable of measuring these low currents. The test described in 6.6 is useful to make sure an EIS instrument is capable of measuring coated specimens.

All equipment should be able to measure the dummy cell described in 6.6.1.

Sometimes, it might be desirable to perform an open-lead test in order to find the limits of the entire set-up under the given conditions. A method of estimating the maximum measurable impedance with the open-lead test is given in Annex A.

NOTE EIS measurements on high-impedance coatings are not limited to the above-mentioned cell designs.

6.6 Confidence test

6.6.1 General

In order to obtain confidence in the entire experimental set-up, it is recommended that a confidence test be carried out prior to measurements of real specimens. Confidence can be obtained by carrying out reference tests using hard-wired dummy circuits with known values for capacitance and resistance. These values should be in the order of magnitude which can be expected for the actual coated specimen under investigation. As high-impedance coatings easily reach values of several gigaohms, combined with low capacitance of about 100 pF, it is recommended that the circuit in Figure 2 be used as a reference.

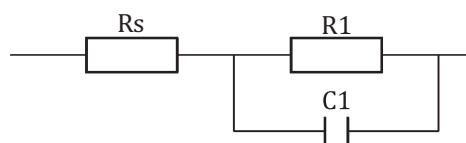

Key

- R1 50 G Ω
 C1 150 pF
 Rs 50 Ω

Figure 2 — Dummy cell for confidence test

6.6.2 Use of interlaboratory test cells for confidence test

Because significant knowledge has been gathered during the performance of a related interlaboratory test, similar circuits with similar values, as used in the interlaboratory test, could be used for the confidence test.

NOTE Details are given in ISO 16773-3.

6.6.3 Error estimate and accuracy

Data for error estimate, accuracy, reproducibility and repeatability are not currently available. They will be provided after the completion of an interlaboratory test.

6.7 Specimens

6.7.1 Preconditioning of specimens

Proper preparation and preconditioning of coated specimens is critical for successful and reliable EIS data.

6.7.2 Environmental control

The coating should be applied and cured in accordance with the manufacturer's recommendation unless otherwise agreed upon between the participating parties.

The film thickness should be as uniform as possible. The exact film thickness should be measured and reported (e.g. in accordance with ISO 2808).

Temperature and humidity control during the application, curing, conditioning and impedance measurement of organic coatings is crucial for a proper determination of the coating resistance.

NOTE The standard temperature and relative humidity for application, conditioning and testing of organic coatings is specified in ISO 3270, i.e. (23 ± 2) °C and a relative humidity of (50 ± 5) %.

The temperature of the specimens during the impedance measurements should be held constant to within ± 2 °C, preferably within ± 1 °C. Relative values for comparison between specimens outside these guidelines are acceptable if all the specimens are run under the same conditions.

When the coating capacitance is the main parameter of interest, control of relative humidity during specimen conditioning is very important.

For reliable measurements, temperature control should be equal to or better than ± 1 °C. For conditioning prior to measurement, an accuracy of ± 2 °C is sufficient for most cases. Each specimen should be kept under controlled conditions in order to prevent post-curing, degradation or any unintended irreversible modification of the coating.

6.8 Evaluation of laboratory and field coating specimens

Impedance measurements can be used to further characterize coating degradation during a weathering test. Impedance is measured on separate specimens after different elapsed times during the test and on completion of the test. Such weathering tests can be salt spray exposure in accordance with ISO 9227, exposure in a humidity chamber in accordance with ISO 6270-1, or cyclic tests such as those described in ISO 20340:2009, Annex A. Other test methods are also used.

When the coated panels are removed from the test chamber for impedance measurements, they typically go through a change in temperature and humidity. Some drying-out can occur if they are removed for more than a few minutes. Further, the coating is exposed to an electrolyte in the electrochemical cell, which can be different from the fluid in the test chamber. Therefore, special attention should be given to the precise procedure and timing when changing, removing and replacing specimens for measurement. The procedural details should be reported with the results.

If the impedance measurement is done in an aggressive electrolyte (e.g. an organic solvent), the exposure of the coating to the electrolyte can be considered as an additional component of the weathering test.

In the case of cyclic weathering tests, impedance measurements will depend upon the specific cycle the test panels are in. To allow comparison of impedance measurements to reveal trends and changes, sequential impedance measurements should be taken at the same time and in the same part of the cycle.

Stray currents can occur when impedance is measured on a wet surface, even when the measured area is some distance from a scribe or other artificial holidays. These stray currents can simulate a damaged coating, even if the coating is in excellent condition. Therefore, it is recommended that preventive measures, such as drying the non-measured area as completely as possible, be taken to avoid stray currents or other potential sources of error.

6.9 Number of specimens and repeatability of results

Coatings are materials with certain inherent properties: holidays, inhomogeneous film thickness, and non-uniform distribution of pigments, fillers and other constituents. It is therefore necessary to test more than one panel. In most cases, a minimum of three replicate specimens is necessary for reliable results. It should be checked if the uniformity between the different specimen plates is sufficient. It is quite common to find repeatability better than 10 % between the capacitance of replicate specimens, but this depends on the type of coating and the conditions of measurement. More replicates might be necessary to overcome uniformity problems.

NOTE The accuracy of the determination of the exposed area might have a significant impact on the repeatability of coating parameters determined by EIS.

Such checks should be the responsibility of the operator and should also be agreed between the parties involved.

Specimens undergoing a rapid change, caused by weathering or other effects producing degradation, can show a larger fluctuation and therefore a lower repeatability.

Most measurement cells contain an electrolyte that is the medium between the coating and the counter-electrode. This means that the dominant process in the first 24 h is the absorption of electrolyte by the coating. To follow this process, the impedance of the coating should be measured more frequently at the beginning, the exact frequency depending on the system.

The accuracy, reliability and repeatability of the experimental set-up should be determined on the dummy cell.

7 Instrumental parameters

7.1 General

Before running an impedance experiment, enter those parameters necessary to set up the instrument for the measurement. Most computer-controlled instruments have software that provides the set-up of these parameters. At this point, assume these parameters have been set correctly and the signals applied to the electrode are consistent with the required set-up. Although different manufacturers each have their specific way(s) of setting these parameters, this part of ISO 16773 focuses only on those parameters that are relevant to the test and need to be specifically controlled.

This part of ISO 16773 describes only the standard method based on single-sine techniques. It does not apply to other ways of collecting EIS spectra, such as multi-sine-waveform techniques. In addition, it is limited to impedance spectra produced in the potentiostatic operating mode. This means that the potential will be controlled at the working electrode and the current measured as a function of the perturbation in the potential.

7.2 Conditioning potential and conditioning time

If the test is performed on a dummy cell, the conditioning potential and conditioning time need not be entered. They provide electrochemical treatment to the specimen before the actual measurement is started. They are sometimes also referred to as delay timing or equilibration timing.

7.3 Frequency spectrum

Most of the coating information will be found between 100 kHz and 0,01 Hz.

The frequency spectrum is the range of frequencies that is applied to the cell. In most high-impedance coating applications, high frequencies (above 10 kHz) will not be used, since most of the characteristic information of the coating will be found below this frequency. Therefore, the recommended high-frequency limit is 100 kHz.

The low-frequency limit will vary with the application. As a general comment, the minimum frequency should be low enough so that the impedance assumes a constant value. Precise work on high-impedance coatings might require frequencies as low as 0,000 1 Hz for determination of the limiting resistance and other characteristics. For screening work, low-impedance coatings, or other specialized applications, a low-frequency limit of 0,01 Hz or higher might be adequate.

If the equipment allows the selection of the direction of the frequency scan, preference should be given to scanning from high frequency to low frequency for coating measurements. The spectrum obtained from a dummy cell should be completely independent of scan direction.

7.4 Data point spacing and points per decade

The standard procedure in electrochemical impedance spectroscopy is to take the frequency spectrum with logarithmic data point spacing. Therefore, it is also necessary to apply the number of data points within each decade of frequency points. At least 5 points should be taken per decade to provide a minimum data point resolution. This resolution is needed to allow accurate equivalent-circuit modelling with the data after the experiment.

7.5 D.C. potential control

D.C. potential control is always used with impedance measurements to control the electrochemical reactions at the surface of an electrode while performing the impedance measurement. Most EIS instruments allow the d.c. potential to be specified with respect to the open-circuit potential or as an absolute voltage versus the reference electrode. In most cases, the d.c. potential applied during an EIS measurement on a coating is the open-circuit potential.

The dummy cell does not require this potential to be controlled at a specific offset value. It should be fixed at 0 V. Since the open-circuit potential (U_{oc}) of a dummy cell is 0 V, the d.c. voltage can also be specified as "0 V vs. U_{oc} ".

For a coated metal specimen that is in excellent condition, it is difficult to obtain a stable value of the open-circuit potential. The non-electroactive nature of the coating causes the specimen to behave like a capacitor, for which an open-circuit potential is undefined. This capacitance, combined with instrumental effects, can lead to drift in the value of the open-circuit potential.

For coatings in good condition, the EIS experiment should be performed at the open-circuit voltage of the bare, uncoated substrate in the electrolyte. The open-circuit voltage of the substrate should be measured in the electrolyte as a separate experiment. The value of the open-circuit potential is then used during the EIS measurement and specified "vs. the reference electrode".

As the coating deteriorates upon exposure to the electrolyte, the specimen will assume more resistive characteristics. This condition can be recognized by a more stable value for the open-circuit potential. When this occurs, the d.c. potential during the EIS measurement can be defined with respect to the stable open-circuit potential for convenience.

7.6 Amplitude of perturbation

The perturbation amplitude is the potential sine wave that is applied through the potentiostat as a polarization voltage to the working electrode. Its amplitude is defined mostly in millivolts and should be as small as possible. In this way, perturbation of the electrode is minimal. This is necessary to prevent the electrode surface from being permanently changed by too high polarization during the measurement. It should be applied within the linear response window of the electrode. Due to this small polarization, the resulting currents will also be very small. Depending on the impedance of the coating, which can be up to 1 G Ω or higher, currents can become so low they cannot be measured by the potentiostat any more, or will disappear in the electrical noise. As a result, the measurement system will approach its limits.

For the purposes of this test, the standard value of 20 mV rms (= 56,6 mV peak-to-peak) will be used. However, the choice can be made to use a higher amplitude when the system is found to be incapable of measuring these high-impedance values.

NOTE Depending on the equipment and the coating, the amplitude can be less than 20 mV rms.

To verify that the measurement is done within the linear response window, it should be made at several amplitudes. The same spectrum should be obtained at each amplitude.

7.7 Current range settings

The choice of a specific current range, or set of ranges, is of great importance for the dynamic range of the impedance measurement. Since the methods described in this part of ISO 16773 cover a wide range of frequencies, a broad dynamic current range of the instrumentation is needed.

All instrument manufacturers have specific and different ways of adjusting these settings. For the purposes of this test, the choice of settings should be made depending on the type of equipment, and it should be ensured that the broadest dynamic range for the tests is chosen. There are no recommended settings for this parameter because they are manufacturer specific.

7.8 Data averaging settings

Data averaging is used to smooth the resulting data from noise, thus leading to better results and more reliable equivalent circuit modelling. Again, the different manufacturers have specific ways to perform this task. In general, it can be said that the more data averaging is used, the better data quality will be reached, but also the total experiment duration will be increased. Data averaging, as well as filtering on the electronic signals, is instrument specific, and therefore not part of the parameter settings for this test. Optimum conditions should be established for any given experimental set-up.

8 Data presentation

8.1 General

In order to visualize the measured data, two different types of graphs are used. Each of them has advantages and disadvantages. For example, the entire dynamic range of the spectra of intact barrier coatings (several orders of magnitude of impedance and frequency) is only visible by using a Bode plot. Minor differences in the low-frequency part of the spectra, however, become more obvious by using Nyquist plots. For intact coatings, the Bode plot is preferred, but in the case of damaged coatings, the Nyquist plot gives important information as well.

8.2 Bode plot

The Bode plot is a double logarithmic graph of the modulus of impedance $|Z|$, in ohms, against frequency, f , in hertz. Usually, the absolute value of the phase angle φ is plotted linearly on the vertical axis, generally from 0° to 90°. It is common practice to refer the impedance to the area, so the unit of Z becomes ohms times square centimetres.

In some cases, especially when more than one spectrum is plotted, it is recommended that phase angle and impedance be plotted separately, as shown in [Figure 3](#).

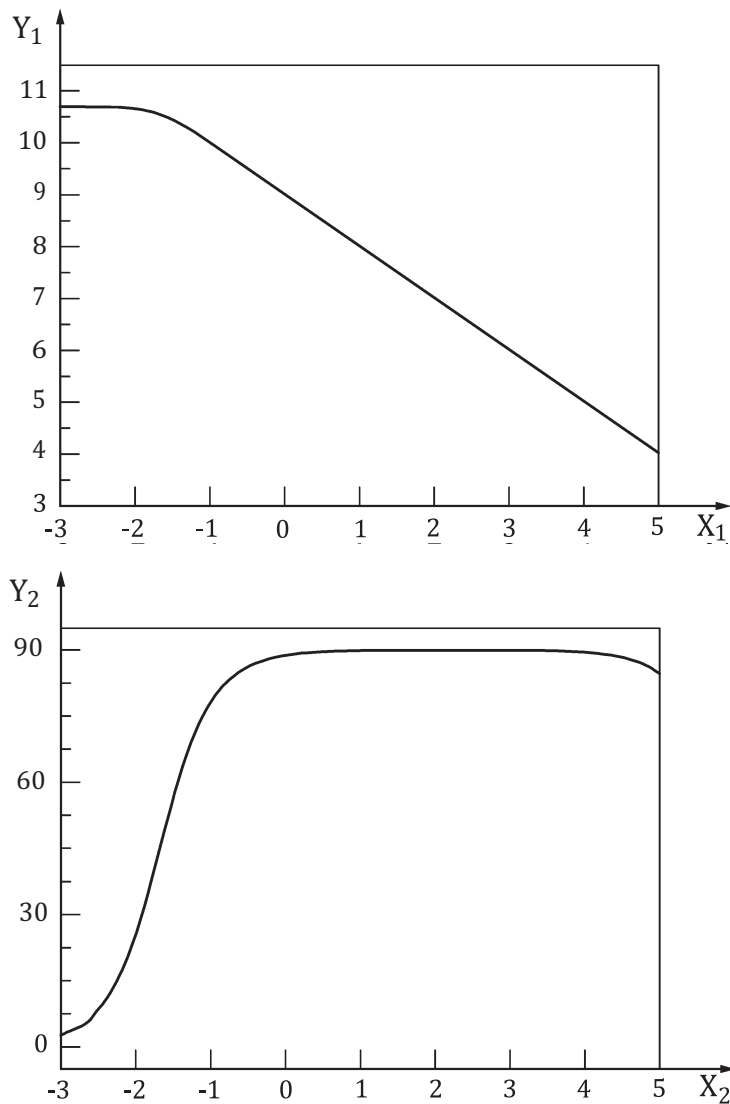

Key

- X_1 $\log f$ (f in Hz)
- Y_1 $\log|Z|$ (Z in $\Omega \cdot \text{cm}^2$)
- X_2 $\log f$ (f in Hz)
- Y_2 $|\varphi|$ (degrees)

Figure 3 — Bode plot

8.3 Nyquist plot

The Nyquist plot is a linear graph of the negative imaginary part z'' of the impedance versus the real part of the impedance z' (see [Figure 4](#)). It is common practice to refer the impedance to the area, so the units of z' and z'' become ohms times square centimetres.

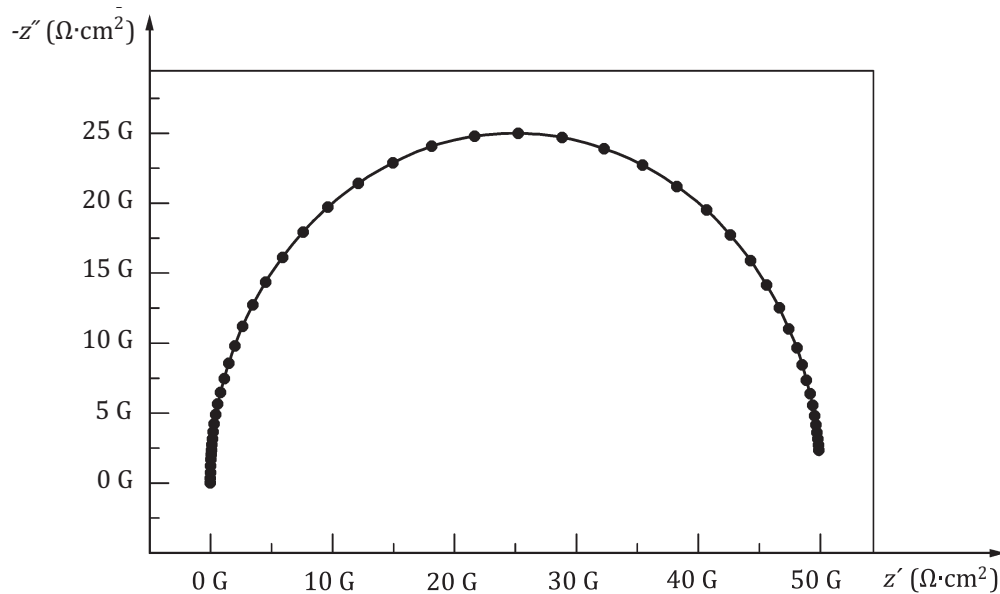

Figure 4 — Nyquist plot

For better interpretation of the measured data, markers for frequencies should be used. These markers should highlight to which frequency the distinct data point belongs. For better readability, only one marker per decade should be used.

9 Exchange file format

The details of the exchange file format are given in [Annex B](#).

10 Test report

The test report shall contain at least the following information:

- a) all details necessary to identify the product tested;
- b) a reference to this part of ISO 16773, i.e. ISO 16773-2;
- c) the details on preparation of the test specimen, including the following:
 - 1) the material (including thickness) and surface preparation of the substrate,
 - 2) the method of application of the tested coating to the substrate, including the duration and conditions of drying between coats in the case of a multi-coat system,
 - 3) the duration and conditions of drying (or stoving) the coat, and conditions of ageing, if applicable, before testing,
 - 4) the thickness, in micrometres, of the dry coating and method of measurement in accordance with ISO 2808, and whether it is a single coating or a multi-coat system;
- d) the temperature and relative humidity during the conditioning and test, if different from those specified in [6.7.2](#);
- e) the electrolyte details, i.e. type of salt, concentration and additives;

- f) the test method used including excitation conditions, waiting times and test duration, in particular:
 - 1) frequency range,
 - 2) amplitude;
- g) the results of the test, as indicated in [Clause 8](#);
- h) any deviations from the procedure specified;
- i) any unusual features (anomalies) observed during the test;
- j) the date of the test.

Annex A (informative)

Determination of maximum measurable impedance with the open-lead test

Every instrument used for EIS experiments has a maximum measurable impedance that is a function of frequency. Most coatings on metals have a high impedance ($1 \times 10^6 \Omega$ or greater) and it is important to know that the impedance of the coated specimen does not exceed that of the measurement instrument. This upper limit is due to stray capacitance and impedance in the electronics in the EIS measurement system.

To obtain the impedance limit of the measurement instrument, conduct the following procedure in accordance with the manufacturer's instructions. Connect the counter-electrode and reference-electrode leads together. Place the pair of leads in a Faraday cage, ensuring that they do not touch each other or the conductive surface of the Faraday cage.

Run an electrochemical impedance spectroscopy measurement to cover the frequency range of interest for the coated specimen. Typical parameters might be 100 kHz to 10 mHz at a d.c. offset of zero volts versus the reference electrode potential and an applied a.c. waveform of 20 mV. Obtain five points per decade.

The Bode plot shown in [Figure A.1](#) gives an example of the data that the user should expect to obtain. In this Bode plot, the internal impedance of the instrument behaves as a capacitor (constant slope of -1) at high frequencies, but eventually levels out at low frequencies to a constant value.

The open-lead plot can be used as a guide to the error introduced into EIS measurements of coatings which approach the limit of the instrument. If the impedance of the coated specimen at any frequency is within one decade of the open-lead value at that frequency, then the measured impedance at that frequency is likely to be in error by 10 % or more. For example, the open-lead value in [Figure A.1](#) at 0,1 Hz (antilog of -1) is about $1,6 \times 10^9 \Omega$ (antilog of 9,2). If the impedance of a specimen at 0,1 Hz exceeds $1,6 \times 10^8 \Omega$ (antilog of 8,2), the measurement is likely to contain significant error (>10 %).

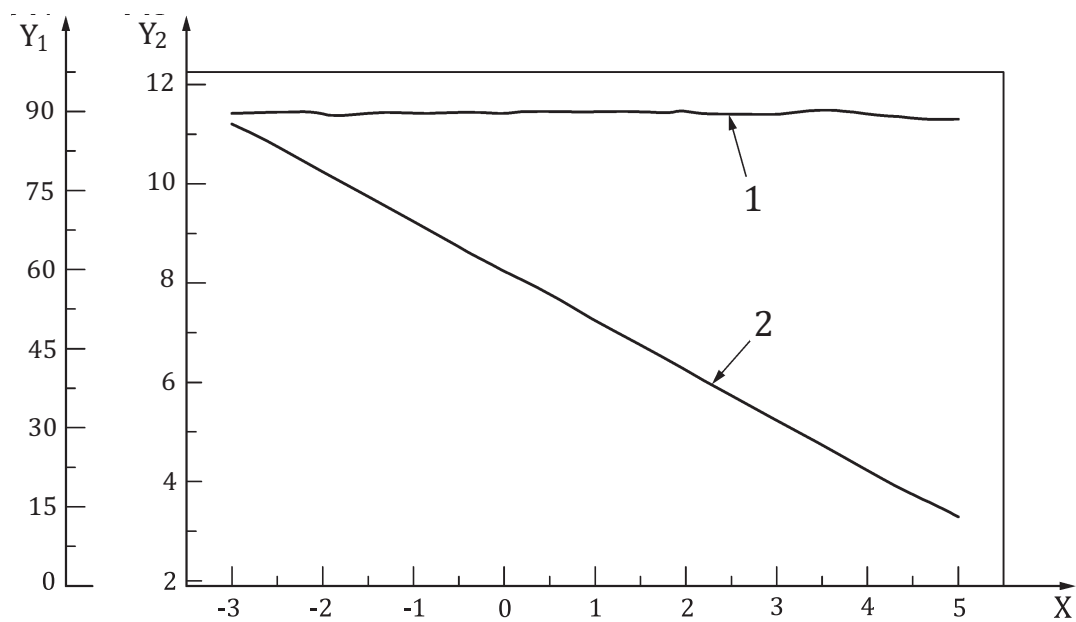

Key

X $\log f$ (f in Hz)

Y₁ $|\varphi|$ (degrees)

Y₂ $\log|Z|$ (Z in $\Omega \cdot \text{cm}^2$)

1 $|\varphi|$ vs $\log f$

2 $\log|Z|$ vs $\log f$

Figure A.1 — Maximum measurable impedance with the open-lead test

All equipment should be able to measure the dummy cell described in [6.6.1](#).

Annex B (normative)

Data exchange file format

B.1 General

This Annex defines a data interchange format for impedance data obtained from different measurement systems made by different manufacturers. Besides the definition of the exchange data format, rules are given for the software tools which may be employed to export and import the data file.

In the following, the software which *exports* a set of impedance data is denoted as the “export software” and abbreviated as ES. The software which *imports* the data file and handles and/or evaluates the corresponding impedance spectrum is denoted as the “import software” and abbreviated as IS.

A text file created by the ES may contain sections of comments and should contain at least one section of impedance data.

Correspondingly, the IS should be able to separate sections of comments and sections of data.

B.2 General considerations for the file format for ES and IS

- a) The general file format is ASCII (i.e. a pure text-file) to enable the reading of the file without the need of a special word processing software.
- b) No text-formatting code (e.g. bold, italic, etc.) is allowed within the file.
- c) The number of characters within a single line of the text-file is restricted to 250 characters.
- d) Each line of the file should end with a CRLF sequence (see below).
- e) No difference should be made between upper-case and lower-case letters by the ES. Every line of the file should be converted into lower-case letters (or upper-case letters respectively) during the analysis of the file by the IS according to the demands of the software which evaluates the data.
- f) For the ES, there is no restriction for inserting “Blanks” or “Blank lines” anywhere in the text to improve the overall readability of the file. Correspondingly, the IS should be able to eliminate blanks or blank lines within a section of impedance data.
- g) Each text-file should contain one section of data.

B.3 Definition of special characters or character-sequences and figure-format

- | | |
|---|---|
| 1) “Blank” | ASCII(32) |
| 2) “CRLF” (carriage return & line feed) | Sequence of ASCII(13) and ASCII(10) |
| 3) “Blank Line” | “CRLF” or sequence of “Blanks” followed by a “CRLF” |
| 4) TAB | ASCII(9), the “tabulator” |
| 5) Figure format | 1.0e5 = 1.0E5 = 1.0e+5 = 1.0E+5 are allowed; the character “.” is the decimal separator. 10 ⁵ is not allowed, because it contains a text-formatting feature (superscript; see below) |

NOTE Only the “e” or “E”-characters are allowed to denote an exponential figure (i.e. “D” is not allowed).

B.4 Keywords

Keywords are enclosed between the characters “<” and “>” (denoted as brackets). Provided a value is assigned to the keyword, the value is given within the brackets separated by a “=” character from the keyword. Insertion of “Blanks” is allowed as well as no distinction is made between uppercase and lowercase letters by ES and IS.

B.4.1 List of keywords

| | |
|---|---------------------|
| <EIS-ISO-ASTM-DATA> | |
| <Date = 2003-01-27> | |
| <Time= 18:55:01> | |
| <Columnseparator = ; > | {Default = TAB} |
| <Name = testdata > | {‘name’ of dataset} |
| <Rows = 12> | {number of rows} |
| <Header = number;frequency;real;imaginary;time> | {optional header} |
| <EndOfData> | |

B.4.2 Meaning of keywords

B.4.2.1 <EIS-ISO-ASTM-DATA>

Defines the start of a section which contains information of the impedance measurement. After the <EIS-ISO-ASTM-DATA> keyword, the data-file should contain the impedance data themselves and should not contain any comments, except additional settings defined by other keywords.

B.4.2.2 <EndOfData>

Defines the end of a section which contains information on the impedance measurement.

NOTE Any part of the text file outside a <EIS-ISO-ASTM-DATA> and <EndOfData> section is considered as a comment.

B.4.2.3 <Date>

Denotes the date when the measurement was performed. The date-format is given in accordance with ISO 8601, i.e. YYYY-MM-DD.

B.4.2.4 <Time>

Denotes the time when the measurement was started. The format is *hh:mm:ss*, using the 24-h clock.

B.4.2.5 <Columnseparator> (optional; Default = TAB)

Defines the character which separates the columns (in a row) of impedance data.

To improve the readability, the handling of the “Blank” as the column separator by the IS is slightly different from that of other possible separators: consecutive “Blanks” will be reduced to a single one and are NOT interpreted as “empty” entries separated by “Blanks”.

NOTE 1 Provided “Blank” is not the column separator.

NOTE 2 Consecutive separators (except the “Blank”) are not allowed in the rows of a data section.

NOTE 3 Instead of denoting the column separator directly after the “=”-character, the following alternative exists to define this separator: <Columnseparator=#9>

In this case, the “#”-character instructs the IS to interpret the following partial-string as a (decimal) number which represents directly the ASCII-code of the separator.

B.4.2.6 <Name>

Defines the title of the Dataset.

B.4.2.7 <Rows>

Defines the number of entries in the list of impedance data

B.4.2.8 <Header> (Default = “number; frequency; real; imaginary; time”)

Defines the column-headings of the data. Provided a **<Header>**-command is inserted in the file, the IS should be able to cut the header into the correct column-headings. If the **<Header>**-command is not present, the number of columns as well as the column-headers are automatically the standard number of (indispensable) columns and the corresponding standard headings respectively.

B.4.3 Structure of the impedance data set

The first five columns are mandatory and defined as follows. The columns have to appear exactly in this order.

| | | |
|---------------|---|---|
| First column | = | number of the entry |
| Second column | = | frequency |
| Third column | = | real part of the complex number |
| Fourth column | = | imaginary part of the complex number |
| Fifth column | = | time (in seconds) when this data point was measured (the first data point is measured at time zero) |

The ES may export more columns but the IS has only to handle the columns defined above.

NOTE 1 If not supported/used by the ES, set to a constant value like “0” or “1”.

NOTE 2 Time is defined as the elapsed time starting from $t = 0$ at the instance the first frequency is applied to the cell. For the following points, time is defined as the start time, with respect to $t = 0$, of the applied frequency.

B.4.4 Example

| | | |
|--|------------------------|-----------------------------|
| File | : or179c - 20.MAE.2000 | |
| System | : 5530DS rot | |
| Potential | : 1.3e-2V | |
| Current | : 21.976pA | |
| Temperature | : 318.9 +- 7.7K | |
| Time | : 16:05:03 - 16:43:22 | |
| Comment | : 24 degrees Celsius | |
| <EIS-ISO-ASTM-DATA> | | {Start of Data section} |
| <Columnseparator = ; > | | {Default = ; (a semicolon)} |
| | | {blank line(s) allowed} |
| <Name = test> | | {‘name’ of dataset} |
| <Rows = 12> | | {number of rows} |
| <Header = number;frequency;real;imaginary;time> | | {optional header} |
| | | {blank line(s) allowed} |
| 1; 1.0000e-02; 4.4523e+09; -2.0312e+09; 1 | | |

2; 1.1342e-02; 4.2774e+09; -2.1462e+09; 1
3; 1.2864e-02; 4.0838e+09; -2.2444e+09; 1
4; 1.4590e-02; 3.8742e+09; -2.3242e+09; 1
5; 1.6548e-02; 3.6517e+09; -2.3842e+09; 1

{blank line(s) allowed}

6; 1.8769e-02; 3.4197e+09; -2.4235e+09; 1
7; 2.1288e-02; 3.1817e+09; -2.4419e+09; 1
8; 2.4144e-02; 2.9411e+09; -2.4393e+09; 1
9; 2.7384e-02; 2.7015e+09; -2.4166e+09; 1
10; 3.1059e-02; 2.4661e+09; -2.3748e+09; 1
11; 3.5227e-02; 2.2379e+09; -2.3156e+09; 1
12; 3.9954e-02; 2.0196e+09; -2.2411e+09; 1

{blank line(s) allowed}

<EndOfData>

Annex C (informative)

Considerations about the precise determination of the exposed area

If an O-ring is used to seal the cell (see [Figure 1](#), position 4), the precise exposed area is smaller than the theoretically assumed area because the O-ring will be compressed, and therefore, the exposed area will be reduced (see [Figure C.1](#)).

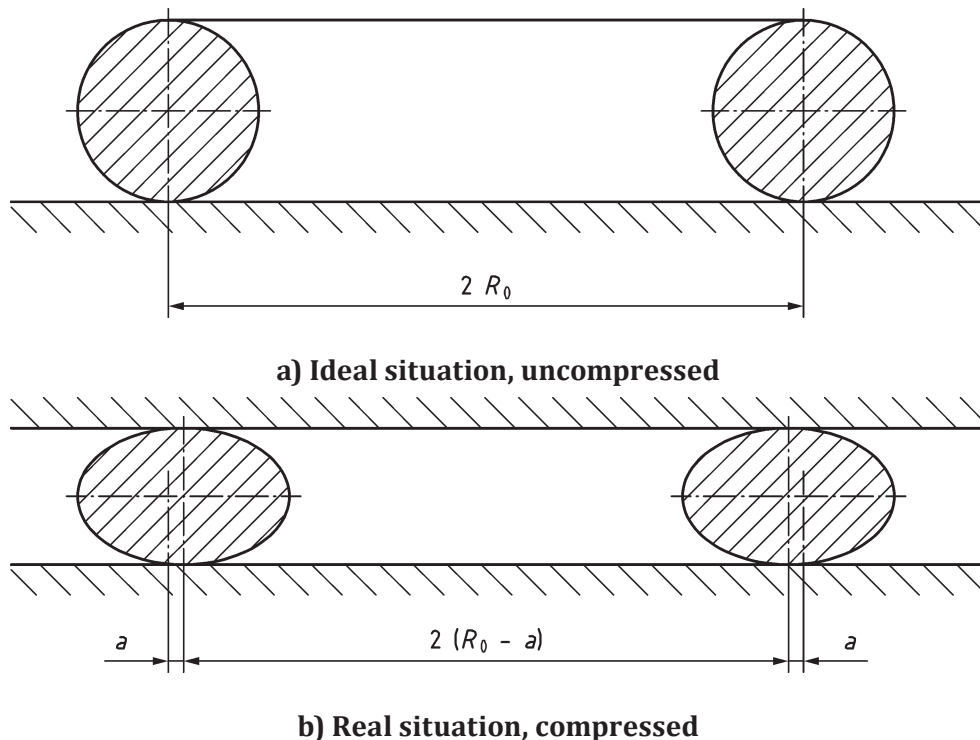

Key

- R_0 radius of the uncompressed O-ring
- a difference of the radius of the O-ring due to compression

Figure C.1 — Uncompressed and compressed O-ring

This behaviour can be visualized easily when using two transparent PMMA (poly methylene methacrylate) plates which were compressed with 4 screws. The screws were gently tightened only by hand and without any tools.

[Figure C.2](#) shows the principle setup and [Figures C.3](#) and [C.4](#) show the compressed O-ring of 1,2 cm and 5 cm diameter, respectively.



Figure C.2 — compression of O-ring using 4 screws

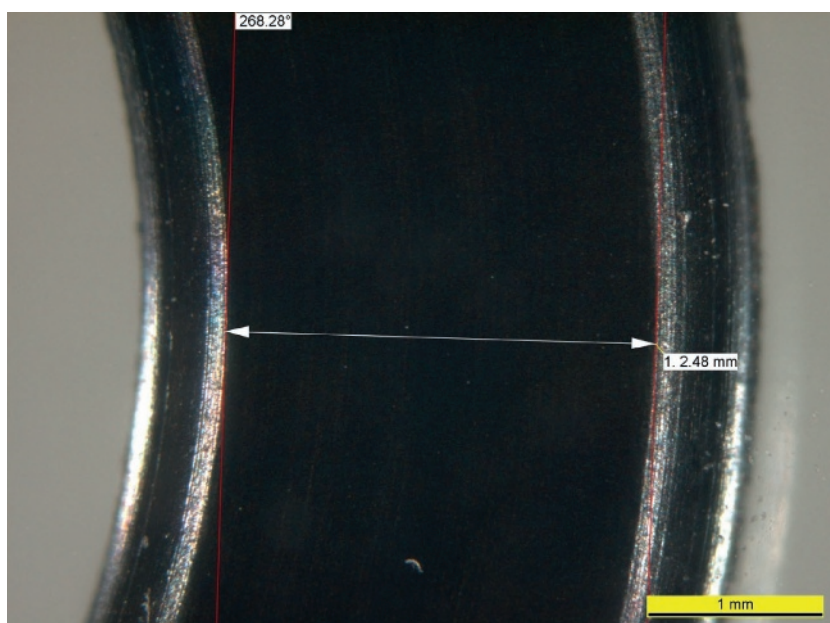

Figure C.3 — Compressed O-ring of 1,2 cm diameter

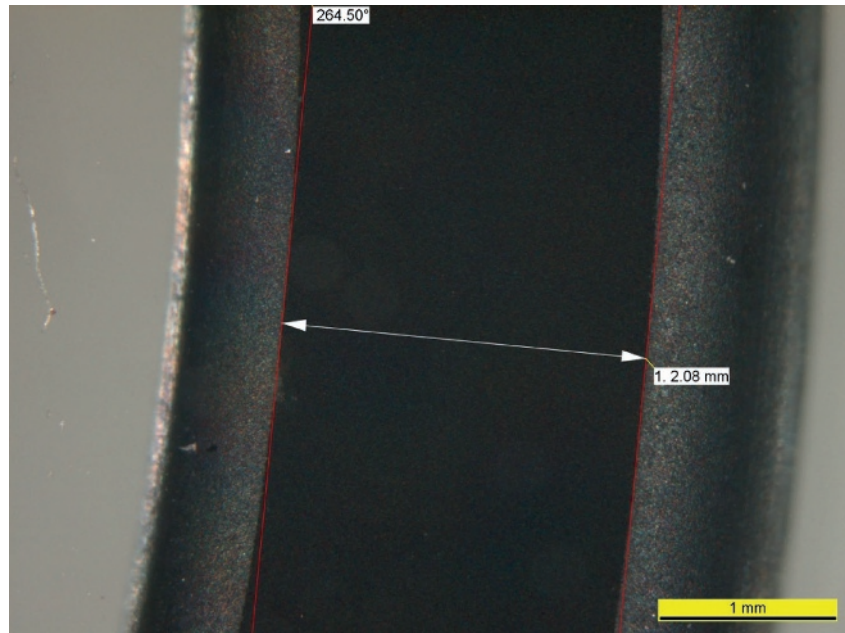
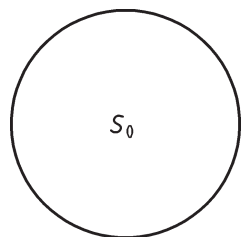

Figure C.4 — Compressed O-ring of 5 cm diameter

The correct exposed area can be calculated as illustrated in [Figure C.5](#).



$$S_0 = \pi \cdot R_0^2$$

a) O-Ring not compressed — Contact surface of the specimen with testing solution

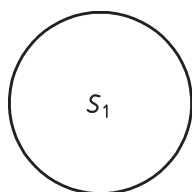

$$S_1 = \pi \cdot (R_0 - a)^2$$

b) O-Ring compressed — Contact surface of the specimen with testing solution

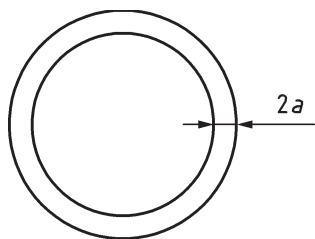

$$\Delta S = S_0 - S_1 = \pi \cdot R_0^2 - \pi \cdot (R_0 - a)^2$$

c) Reduction of contact surface of specimen due to O-Ring compression

Key

- S_0 geometric area with the O-ring uncompressed
- S_1 exposed area with the O-ring compressed
- ΔS difference $S_0 - S_1$
- R_0 radius of the uncompressed O-ring
- a difference of the radius of the O-ring due to compression

Figure C.5 — Calculation of the exposed area

The error dS between exposed area S_1 and geometric area S_0 can be approximated depending on the O-ring radius, R_0 , and the measured contact, $2a$, using Formula (C.1):

$$dS = \frac{\Delta S}{S_0} \cdot 100 = \frac{2 \cdot a \cdot R_0 \cdot a^2}{R_0^2} \cdot 100 \tag{C.1}$$

Some examples for calculation of the error of the exposed area are shown in [Table C.1](#).

Table C.1 — Approximate error estimation of contact surface of specimens in corrosion cells

| Radius of the uncompressed O-ring | Difference of the radius of the O-ring due to compression | | Geometric area with the O-ring uncompressed (theoretical surface) | Exposed area with the O-ring compressed (real surface) | Error of the exposed area |
|--|--|-----------------|--|---|----------------------------------|
| R_0 mm | a mm | $R_0 - a$ mm | S_0 mm ² | S_1 mm ² | dS % |
| 6 | 0,8 | 5,2 | 113 | 85 | 25 |
| 12 | 0,8 | 11,2 | 452 | 394 | 13 |
| 24 | 0,8 | 23,2 | 1 809 | 1 690 | 7 |
| 30 | 0,8 | 29,2 | 2 826 | 2 677 | 5 |
| 6 | 1 | 5 | 113 | 79 | 31 |
| 12 | 1 | 11 | 452 | 380 | 16 |
| 24 | 1 | 23 | 1 809 | 1 661 | 8 |
| 30 | 1 | 29 | 2 826 | 2 641 | 7 |
| 6 | 1,25 | 4,75 | 113 | 71 | 37 |
| 12 | 1,25 | 10,75 | 452 | 363 | 20 |
| 24 | 1,25 | 22,75 | 1 809 | 1 625 | 10 |
| 30 | 1,25 | 28,75 | 2 826 | 2 595 | 8 |

Bibliography

- [1] ISO 2808, *Paints and varnishes — Determination of film thickness*
- [2] ISO 3270, *Paints and varnishes and their raw materials — Temperatures and humidities for conditioning and testing*
- [3] ISO 6270-1, *Paints and varnishes — Determination of resistance to humidity — Part 1: Continuous condensation*
- [4] ISO 8601, *Data elements and interchange formats — Information interchange — Representation of dates and times*
- [5] ISO 9227, *Corrosion tests in artificial atmospheres — Salt spray tests*
- [6] ISO/TR 16208, *Corrosion of metals and alloys — Test method for corrosion of materials by electrochemical impedance measurements*
- [7] ISO 20340:2009, *Paints and varnishes — Performance requirements for protective paint systems for offshore and related structures*

British Standards Institution (BSI)

BSI is the national body responsible for preparing British Standards and other standards-related publications, information and services.

BSI is incorporated by Royal Charter. British Standards and other standardization products are published by BSI Standards Limited.

About us

We bring together business, industry, government, consumers, innovators and others to shape their combined experience and expertise into standards-based solutions.

The knowledge embodied in our standards has been carefully assembled in a dependable format and refined through our open consultation process. Organizations of all sizes and across all sectors choose standards to help them achieve their goals.

Information on standards

We can provide you with the knowledge that your organization needs to succeed. Find out more about British Standards by visiting our website at bsigroup.com/standards or contacting our Customer Services team or Knowledge Centre.

Buying standards

You can buy and download PDF versions of BSI publications, including British and adopted European and international standards, through our website at bsigroup.com/shop, where hard copies can also be purchased.

If you need international and foreign standards from other Standards Development Organizations, hard copies can be ordered from our Customer Services team.

Subscriptions

Our range of subscription services are designed to make using standards easier for you. For further information on our subscription products go to bsigroup.com/subscriptions.

With **British Standards Online (BSOL)** you'll have instant access to over 55,000 British and adopted European and international standards from your desktop. It's available 24/7 and is refreshed daily so you'll always be up to date.

You can keep in touch with standards developments and receive substantial discounts on the purchase price of standards, both in single copy and subscription format, by becoming a **BSI Subscribing Member**.

PLUS is an updating service exclusive to BSI Subscribing Members. You will automatically receive the latest hard copy of your standards when they're revised or replaced.

To find out more about becoming a BSI Subscribing Member and the benefits of membership, please visit bsigroup.com/shop.

With a **Multi-User Network Licence (MUNL)** you are able to host standards publications on your intranet. Licences can cover as few or as many users as you wish. With updates supplied as soon as they're available, you can be sure your documentation is current. For further information, email bsmusales@bsigroup.com.

Revisions

Our British Standards and other publications are updated by amendment or revision.

We continually improve the quality of our products and services to benefit your business. If you find an inaccuracy or ambiguity within a British Standard or other BSI publication please inform the Knowledge Centre.

Copyright

All the data, software and documentation set out in all British Standards and other BSI publications are the property of and copyrighted by BSI, or some person or entity that owns copyright in the information used (such as the international standardization bodies) and has formally licensed such information to BSI for commercial publication and use. Except as permitted under the Copyright, Designs and Patents Act 1988 no extract may be reproduced, stored in a retrieval system or transmitted in any form or by any means – electronic, photocopying, recording or otherwise – without prior written permission from BSI. Details and advice can be obtained from the Copyright & Licensing Department.

Useful Contacts:

Customer Services

Tel: +44 845 086 9001

Email (orders): orders@bsigroup.com

Email (enquiries): cservices@bsigroup.com

Subscriptions

Tel: +44 845 086 9001

Email: subscriptions@bsigroup.com

Knowledge Centre

Tel: +44 20 8996 7004

Email: knowledgecentre@bsigroup.com

Copyright & Licensing

Tel: +44 20 8996 7070

Email: copyright@bsigroup.com

BSI Group Headquarters

389 Chiswick High Road London W4 4AL UK

