

**BS EN ISO 16283-1:2014**

*Incorporating corrigendum June 2014*



**BSI Standards Publication**

# **Acoustics — Field measurement of sound insulation in buildings and of building elements**

Part 1: Airborne sound insulation

**bsi.**

...making excellence a habit.™

### National foreword

This British Standard is the UK implementation of EN ISO 16283-1:2014. It supersedes BS EN ISO 140-4:1998 which is withdrawn. Together with BS EN ISO 16283-2, it supersedes BS EN ISO 140-7:1998 which will be withdrawn upon publication of BS EN ISO 16283-2. Together with BS EN ISO 16283-3, it supersedes BS EN ISO 140-5:1998 which will be withdrawn upon publication of BS EN ISO 16283-3. Together with BS EN ISO 16283-2 and BS EN ISO 16283-3, it supersedes BS EN ISO 140-14:2004 which will be withdrawn upon publication of BS EN ISO 16283-2 and BS EN ISO 16283-3.

The UK participation in its preparation was entrusted by Technical Committee EH/1, Acoustics, to Subcommittee EH/1/6, Building acoustics.

A list of organizations represented on this subcommittee can be obtained on request to its secretary.

This publication does not purport to include all the necessary provisions of a contract. Users are responsible for its correct application.

© The British Standards Institution 2014.  
Published by BSI Standards Limited 2014

ISBN 978 0 580 86598 5

ICS 91.120.20

### **Compliance with a British Standard cannot confer immunity from legal obligations.**

This British Standard was published under the authority of the Standards Policy and Strategy Committee on 28 February 2014.

### **Amendments/corrigenda issued since publication**

Date	Text affected
30 June 2014	Correction to supersession information in National Foreword

EUROPEAN STANDARD

**EN ISO 16283-1**

NORME EUROPÉENNE

EUROPÄISCHE NORM

February 2014

---

ICS 91.120.20

English Version

**Acoustics - Field measurement of sound insulation in buildings  
and of building elements - Part 1: Airborne sound insulation (ISO  
16283-1:2014)**

Acoustique - Mesurage in situ de l'isolation acoustique des  
bâtiments et des éléments de construction - Partie 1:  
Isolation des bruits aériens (ISO 16283-1:2014)

Akustik - Messung der Schalldämmung in Gebäuden und  
von Bauteilen am Bau - Teil 1: Luftschalldämmung (ISO  
16283-1:2014)

This European Standard was approved by CEN on 4 January 2014.

CEN members are bound to comply with the CEN/CENELEC Internal Regulations which stipulate the conditions for giving this European Standard the status of a national standard without any alteration. Up-to-date lists and bibliographical references concerning such national standards may be obtained on application to the CEN-CENELEC Management Centre or to any CEN member.

This European Standard exists in three official versions (English, French, German). A version in any other language made by translation under the responsibility of a CEN member into its own language and notified to the CEN-CENELEC Management Centre has the same status as the official versions.

CEN members are the national standards bodies of Austria, Belgium, Bulgaria, Croatia, Cyprus, Czech Republic, Denmark, Estonia, Finland, Former Yugoslav Republic of Macedonia, France, Germany, Greece, Hungary, Iceland, Ireland, Italy, Latvia, Lithuania, Luxembourg, Malta, Netherlands, Norway, Poland, Portugal, Romania, Slovakia, Slovenia, Spain, Sweden, Switzerland, Turkey and United Kingdom.



EUROPEAN COMMITTEE FOR STANDARDIZATION  
COMITÉ EUROPÉEN DE NORMALISATION  
EUROPÄISCHES KOMITEE FÜR NORMUNG

**CEN-CENELEC Management Centre: Avenue Marnix 17, B-1000 Brussels**

## **Foreword**

This document (EN ISO 16283-1:2014) has been prepared by Technical Committee ISO/TC 43 "Acoustics" in collaboration with the Technical Committee CEN/TC 126 "Acoustic properties of building elements and of buildings" the secretariat of which is held by AFNOR.

This European Standard shall be given the status of a national standard, either by publication of an identical text or by endorsement, at the latest by August 2014, and conflicting national standards shall be withdrawn at the latest by August 2014.

Attention is drawn to the possibility that some of the elements of this document may be the subject of patent rights. CEN [and/or CENELEC] shall not be held responsible for identifying any or all such patent rights.

This document supersedes EN ISO 140-7:1998, EN ISO 140-5:1998, EN ISO 140-4:1998, EN ISO 140-14:2004.

According to the CEN-CENELEC Internal Regulations, the national standards organizations of the following countries are bound to implement this European Standard: Austria, Belgium, Bulgaria, Croatia, Cyprus, Czech Republic, Denmark, Estonia, Finland, Former Yugoslav Republic of Macedonia, France, Germany, Greece, Hungary, Iceland, Ireland, Italy, Latvia, Lithuania, Luxembourg, Malta, Netherlands, Norway, Poland, Portugal, Romania, Slovakia, Slovenia, Spain, Sweden, Switzerland, Turkey and the United Kingdom.

### **Endorsement notice**

The text of ISO 16283-1:2014 has been approved by CEN as EN ISO 16283-1:2014 without any modification.

# Contents

Page

<b>Foreword</b> .....	<b>v</b>
<b>Introduction</b> .....	<b>vi</b>
<b>1 Scope</b> .....	<b>1</b>
<b>2 Normative references</b> .....	<b>1</b>
<b>3 Terms and definitions</b> .....	<b>1</b>
<b>4 Instrumentation</b> .....	<b>5</b>
4.1 General.....	5
4.2 Calibration.....	5
4.3 Verification.....	5
<b>5 Frequency range</b> .....	<b>5</b>
<b>6 General</b> .....	<b>6</b>
<b>7 Default procedure for sound pressure level measurement</b> .....	<b>7</b>
7.1 General.....	7
7.2 Generation of sound field.....	7
7.3 Fixed microphone positions.....	8
7.4 Mechanized continuously-moving microphone.....	9
7.5 Manually-scanned microphone.....	10
7.6 Minimum distances for microphone positions.....	12
7.7 Averaging times.....	12
7.8 Calculation of energy-average sound pressure levels.....	13
<b>8 Low-frequency procedure for sound pressure level measurement</b> .....	<b>14</b>
8.1 General.....	14
8.2 Generation of sound field.....	14
8.3 Microphone positions.....	14
8.4 Averaging time.....	15
8.5 Calculation of low-frequency energy-average sound pressure levels.....	15
<b>9 Background noise (default and low-frequency procedure)</b> .....	<b>16</b>
9.1 General.....	16
9.2 Correction to the signal level for background noise.....	17
<b>10 Reverberation time in the receiving room (default and low-frequency procedure)</b> .....	<b>17</b>
10.1 General.....	17
10.2 Generation of sound field.....	18
10.3 Default procedure.....	18
10.4 Low-frequency procedure.....	18
10.5 Interrupted noise method.....	18
10.6 Integrated impulse response method.....	18
<b>11 Conversion to octave bands</b> .....	<b>19</b>
<b>12 Recording results</b> .....	<b>19</b>
<b>13 Uncertainty</b> .....	<b>19</b>
<b>14 Test report</b> .....	<b>19</b>
<b>Annex A (normative) Requirements for loudspeakers</b> .....	<b>21</b>
<b>Annex B (informative) Forms for recording results</b> .....	<b>22</b>
<b>Annex C (informative) Additional guidance</b> .....	<b>25</b>
<b>Annex D (informative) Horizontal measurements — Examples of suitable loudspeaker and microphone positions</b> .....	<b>30</b>
<b>Annex E (informative) Vertical measurements — Examples of suitable loudspeaker and</b>	

<b>microphone positions</b> .....	<b>37</b>
<b>Bibliography</b> .....	<b>43</b>

## Foreword

ISO (the International Organization for Standardization) is a worldwide federation of national standards bodies (ISO member bodies). The work of preparing International Standards is normally carried out through ISO technical committees. Each member body interested in a subject for which a technical committee has been established has the right to be represented on that committee. International organizations, governmental and non-governmental, in liaison with ISO, also take part in the work. ISO collaborates closely with the International Electrotechnical Commission (IEC) on all matters of electrotechnical standardization.

The procedures used to develop this document and those intended for its further maintenance are described in the ISO/IEC Directives, Part 1. In particular the different approval criteria needed for the different types of ISO documents should be noted. This document was drafted in accordance with the editorial rules of the ISO/IEC Directives, Part 2 (see [www.iso.org/directives](http://www.iso.org/directives)).

Attention is drawn to the possibility that some of the elements of this document may be the subject of patent rights. ISO shall not be held responsible for identifying any or all such patent rights. Details of any patent rights identified during the development of the document will be in the Introduction and/or on the ISO list of patent declarations received (see [www.iso.org/patents](http://www.iso.org/patents)).

Any trade name used in this document is information given for the convenience of users and does not constitute an endorsement.

For an explanation on the meaning of ISO specific terms and expressions related to conformity assessment, as well as information about ISO's adherence to the WTO principles in the Technical Barriers to Trade (TBT) see the following URL: Foreword - Supplementary information

The committee responsible for this document is ISO/TC 43, *Acoustics*, Subcommittee SC 2, *Building acoustics*.

This first edition of ISO 16283-1 cancels and replaces ISO 140-4:1998, ISO 140-5:1998, ISO 140-7:1998, and ISO 140-14:2004, which have been technically revised.

ISO 16283 consists of the following parts, under the general title *Acoustics — Field measurement of sound insulation in buildings and of building elements*:

- *Part 1: Airborne sound insulation*
- *Part 2: Impact sound insulation*<sup>1)</sup>
- *Part 3: Façade sound insulation*<sup>2)</sup>

---

1) To be published.

2) Under development.

## Introduction

ISO 16283 (all parts) describes procedures for field measurements of sound insulation in buildings. Airborne, impact and façade sound insulation are described in ISO 16283-1, ISO 16283-2<sup>3)</sup> and ISO 16283-3<sup>4)</sup>, respectively.

Field sound insulation measurements that were described previously in ISO 140-4, -5, and -7 were (a) primarily intended for measurements where the sound field could be considered to be diffuse, and (b) not explicit as to whether operators could be present in the rooms during the measurement. ISO 16283 differs from ISO 140-4, -5, and -7 in that (a) it applies to rooms in which the sound field may or may not approximate to a diffuse field, (b) it clarifies how operators can measure the sound field using a hand-held microphone or sound level meter and (c) it includes additional guidance that was previously contained in ISO 140-14.

NOTE Survey test methods for field measurements of airborne and impact sound insulation are dealt with in ISO 10052.

---

3) To be published.

4) Under development.



# Acoustics — Field measurement of sound insulation in buildings and of building elements —

## Part 1: Airborne sound insulation

### 1 Scope

This part of ISO 16283 specifies procedures to determine the airborne sound insulation between two rooms in a building using sound pressure measurements. These procedures are intended for room volumes in the range from 10 m<sup>3</sup> to 250 m<sup>3</sup> in the frequency range from 50 Hz to 5 000 Hz. The test results can be used to quantify, assess and compare the airborne sound insulation in unfurnished or furnished rooms where the sound field may or may not approximate to a diffuse field. The measured airborne sound insulation is frequency-dependent and can be converted into a single number quantity to characterize the acoustic performance using the rating procedures in ISO 717-1.

### 2 Normative references

The following documents, in whole or in part, are normatively referenced in this document and are indispensable for its application. For dated references, only the edition cited applies. For undated references, the latest edition of the referenced document (including any amendments) applies.

ISO 717-1, *Acoustics — Rating of sound insulation in buildings and of building elements — Part 1: Airborne sound insulation*

ISO 3382-2, *Acoustics — Measurement of room acoustic parameters — Part 2: Reverberation time in ordinary rooms*

ISO 12999-1, *Acoustics — Determination and application of measurement uncertainties in building acoustics — Part 1: Sound insulation*<sup>1)</sup>

ISO 18233, *Acoustics — Application of new measurement methods in building and room acoustics*

IEC 60942, *Electroacoustics — Sound calibrators*

IEC 61183, *Electroacoustics — Random-incidence and diffuse-field calibration of sound level meters*

IEC 61260, *Electroacoustics — Octave-band and fractional-octave-band filters*

IEC 61672-1, *Electroacoustics — Sound level meters — Part 1: Specifications*

### 3 Terms and definitions

For the purposes of this document, the following terms and definitions apply.

---

1) To be published.

### 3.1 energy-average sound pressure level in a room

$L$

ten times the common logarithm of the ratio of the space and time average of the squared sound pressure to the square of the reference sound pressure, with the space average taken over the central zone of the room where the direct radiation from any loudspeaker or the nearfield radiation from the room boundaries has negligible influence

Note 1 to entry:  $L$  is expressed in decibels.

### 3.2 corner sound pressure level in a room

$L_{\text{Corner}}$

ten times the common logarithm of the ratio of the highest time average squared sound pressure from the set of corner measurements to the square of the reference sound pressure, for the low-frequency range (50, 63, and 80 Hz one-third octave bands)

Note 1 to entry:  $L_{\text{Corner}}$  is expressed in decibels.

### 3.3 low-frequency energy-average sound pressure level in a room

$L_{\text{LF}}$

ten times the common logarithm of the ratio of the space and time average of the squared sound pressure to the square of the reference sound pressure in the low-frequency range (50, 63, and 80 Hz one-third octave bands) where the space average is a weighted average that is calculated using the room corners where the sound pressure levels are highest and the central zone of the room where the direct radiation from any loudspeaker or the nearfield radiation from the room boundaries has negligible influence

Note 1 to entry:  $L_{\text{LF}}$  is expressed in decibels.

Note 2 to entry:  $L_{\text{LF}}$  is an estimate of the energy-average sound pressure level for the entire room volume.

### 3.4 reverberation time

$T$

time required for the sound pressure level in a room to decrease by 60 dB after the sound source has stopped

Note 1 to entry:  $T$  is expressed in seconds.

### 3.5 background noise level

measured sound pressure level in the receiving room from all sources except the loudspeaker in the source room

### 3.6 fixed microphone

microphone that is fixed in space by using a device such as a tripod so that it is stationary

### 3.7 mechanized continuously-moving microphone

microphone that is mechanically moved with approximately constant angular speed in a circle, or is mechanically swept along a circular path where the angle of rotation about a fixed axis is between 270° and 360°

### 3.8 manually-scanned microphone

microphone attached to a hand-held sound level meter or an extension rod that is moved by a human operator along a prescribed path

**3.9**  
**manually-held microphone**

microphone attached to a hand-held sound level meter or a rod that is hand-held at a fixed position by a human operator at a distance at least an arm's length from the trunk of the operator's body

**3.10**  
**partition**

total surface of the separating partition between the source and receiving rooms

Note 1 to entry: For two rooms which are staggered vertically or horizontally, the total surface of the separating partition is not visible from both sides of the partition; hence it is necessary to define the partition as the total surface.

**3.11**  
**common partition**

part of the partition that is common to both the source and receiving rooms

**3.12**  
**level difference**

*D*

difference in the energy-average sound pressure levels between the source and receiving rooms with one or more loudspeakers in the source room which is calculated using Formula (1)

$$D = L_1 - L_2 \quad (1)$$

where

*L*<sub>1</sub> is the energy-average sound pressure level in the source room when its volume is larger than or equal to 25 m<sup>3</sup> or the low-frequency energy-average sound pressure level (50 Hz, 63 Hz and 80 Hz bands only) in the source room when its volume is smaller than 25 m<sup>3</sup>;

*L*<sub>2</sub> is the energy-average sound pressure level in the receiving room when its volume is larger than or equal to 25 m<sup>3</sup> or the low-frequency energy-average sound pressure level (50 Hz, 63 Hz and 80 Hz bands only) in the receiving room when its volume is smaller than 25 m<sup>3</sup>

Note 1 to entry: *D* is expressed in decibels.

**3.13**  
**standardized level difference**

*D*<sub>nT</sub>

level difference that is standardized to a reference value of the reverberation time in the receiving room and calculated using Formula (2)

$$D_{nT} = D + 10 \lg \frac{T}{T_0} \quad (2)$$

where

*T* is the reverberation time in the receiving room;

*T*<sub>0</sub> is the reference reverberation time; for dwellings, *T*<sub>0</sub> = 0,5 s.

Note 1 to entry: *D*<sub>nT</sub> is expressed in decibels.

Note 2 to entry: The level difference is referenced to a reverberation time of 0,5 s because in dwellings with furniture the reverberation time has been found to be reasonably independent of volume and frequency and to be approximately equal to 0,5 s. With this standardization,  $D_{nT}$  is dependent on the direction of the sound transmission if the source and receiving rooms have different volumes;  $D_{nT}$  will be higher when the test is carried out from a smaller source room to a larger receiving room compared to the reverse situation. For this reason, regulations that require testing to show compliance with a minimum standard of airborne sound insulation usually require that the smaller room is used as the receiving room so that the lowest  $D_{nT}$  values are measured.

Note 3 to entry:  $D_{nT}$  provides a straightforward link to the subjective impression of airborne sound insulation.

### 3.14 apparent sound reduction index

$R'$   
ten times the common logarithm of the ratio of the sound power,  $W_1$ , which is incident on a test element to the total sound power radiated into the receiving room if, in addition to the sound power,  $W_2$ , radiated by the test element, the sound power,  $W_3$ , radiated by flanking elements or by other components, is significant

$$R' = 10 \lg \frac{W_1}{W_2 + W_3} \quad (3)$$

and the apparent sound reduction index is evaluated using Formula (4)

$$R' = D + 10 \lg \frac{S}{A} \quad (4)$$

where

$S$  is the area of the common partition, in square metres;

$A$  is the equivalent absorption area of the receiving room, in square metres.

Note 1 to entry:  $R'$  is expressed in decibels.

Note 2 to entry: In general, the sound power transmitted into the receiving room consists of the sum of several components from different elements (walls, floor, ceiling etc.).

Note 3 to entry:  $R'$  can be used to compare field measurements with laboratory measurements of the sound reduction index,  $R$ . In comparison to  $D_{nT}$  it has a weaker link to the subjective impression of airborne sound insulation.

Note 4 to entry: When  $R'$  is determined in the 50 Hz, 63 Hz and 80 Hz bands using the low-frequency procedure the link to sound power in Formula (3) is not exact.

### 3.15 equivalent absorption area

$A$   
sound absorption area which is calculated using Sabine's formula in Formula (5)

$$A = \frac{0,16V}{T} \quad (5)$$

where

$V$  is the receiving room volume, in cubic metres;

$T$  is the reverberation time in the receiving room.

Note 1 to entry:  $A$  is expressed in square metres.

## 4 Instrumentation

### 4.1 General

The instruments for measuring sound pressure levels, including microphone(s) as well as cable(s), windscreen(s), recording devices and other accessories, if used, shall meet the requirements for a class 0 or 1 instrument according to IEC 61672-1 for random incidence application.

Filters shall meet the requirements for a class 0 or 1 instrument according to IEC 61260.

The reverberation time measurement equipment shall comply with the requirements defined in ISO 3382-2.

### 4.2 Calibration

At the beginning and at the end of every measurement session and at least at the beginning and the end of each measurement day, the entire sound pressure level measuring system shall be checked at one or more frequencies by means of a sound calibrator meeting the requirements for a class 0 or 1 instrument according to IEC 60942. Each time the calibrator is used, the sound pressure level measured with the calibrator should be noted in the field documentation of the operator. Without any further adjustment, the difference between the readings of two consecutive checks shall be less or equal to 0,5 dB. If this value is exceeded, the results of measurements obtained after the previous satisfactory check shall be discarded.

### 4.3 Verification

Compliance of the sound pressure level measuring instrument, the filters and the sound calibrator with the relevant requirements shall be verified by the existence of a valid certificate of compliance. If applicable, random incidence response of the microphone shall be verified by a procedure from IEC 61183. All compliance testing shall be conducted by a laboratory being accredited or otherwise nationally authorized to perform the relevant tests and calibrations and ensuring metrological traceability to the appropriate measurement standards.

Unless national regulations dictate otherwise, it is recommended that the sound calibrator should be calibrated at intervals not exceeding 1 year, the compliance of the instrumentation system with the requirements of IEC 61672-1 should be verified at intervals not exceeding two years, and the compliance of the filter set with the requirements of IEC 61260 should be verified at intervals not exceeding two years.

## 5 Frequency range

All quantities shall be measured using one-third octave band filters having at least the following centre frequencies, in hertz:

100, 125, 160, 200, 250, 315, 400, 500, 630, 800, 1 000, 1 250, 1 600, 2 000, 2 500, 3 150

If additional information in the low-frequency range is required, use one-third octave band filters with the following centre frequencies, in hertz:

50, 63, 80

If additional information in the high-frequency range is required, use one-third octave band filters with the following centre frequencies, in hertz:

4 000, 5 000

NOTE Measurement of additional information in the low- and high-frequency ranges is optional.

## 6 General

Determination of the airborne sound insulation according to this part of ISO 16283 requires that one room is chosen as the source room which will contain the loudspeaker(s), and another is chosen as the receiving room. The measurements that are required include the sound pressure levels in both rooms with the source(s) operating, the background noise in the receiving room when all sources are switched off and the reverberation times in the receiving room.

Two measurement procedures are described that shall be used for the sound pressure level, the reverberation time and the background noise; a default procedure and an additional low-frequency procedure.

For the sound pressure level and the background noise, the default procedure for all frequencies is to use a fixed microphone or a manually-held microphone moved from one position to another, an array of fixed microphones, a mechanized continuously-moving microphone or a manually-scanned microphone. These measurements are taken in the central zone of a room at positions away from the room boundaries. Different approaches are described to sample the sound pressure so that the operator can choose the most suitable approach for the source room and receiving room. The main consideration for the source room concerns the hearing protection to be used by the human operator. For the receiving room the aim is to minimize the effect of background noise for which the operator has to decide whether it is advantageous to be present in the room in order to listen for intermittent background noise or to be outside the room to ensure that the background noise is unaffected by the operator.

For the sound pressure level and the background noise, the low-frequency procedure shall be used for the 50 Hz, 63 Hz, and 80 Hz one-third octave bands in the source and/or receiving room when its volume is smaller than 25 m<sup>3</sup> (calculated to the nearest cubic metre). This procedure is carried out in addition to the default procedure and requires additional measurements of the sound pressure level in the corners of the source and/or receiving room using either a fixed microphone or a manually-held microphone.

NOTE 1 The low-frequency procedure is necessary in small rooms due to large spatial variations in the sound pressure level of the modal sound field. In these situations, corner measurements are used to improve the repeatability, reproducibility and relevance to room occupants.

If necessary to avoid hearing damage, hearing protection should be worn by the operator when measuring the sound pressure level in the source room and, if necessary, when measuring reverberation times in the receiving room. When measuring sound pressure levels in the receiving room that will not cause hearing damage it is advisable to remove any hearing protection so that the operator is aware of short external noise events that could invalidate the measurement as well as helping the operator to minimize self-generated noise.

For the reverberation time, the low-frequency procedure shall be used for the 50 Hz, 63 Hz, and 80 Hz one-third octave bands in the source and/or receiving room when its volume is smaller than 25 m<sup>3</sup> (calculated to the nearest cubic metre).

If using methods of signal processing described in ISO 18233 the measurements shall be carried out using fixed microphones and shall not use a mechanized continuously-moving microphone, manually-held microphone or a manually-scanned microphone.

The sound fields in typical rooms (furnished or unfurnished) will rarely approximate to a diffuse sound field over the entire frequency range from 50 Hz to 5000 Hz. The default and low-frequency procedures allow for measurements to be taken without any knowledge as to whether the sound field can be considered as diffuse or non-diffuse. For this reason, the sound field should not be modified for the purpose of the test by temporarily introducing additional furniture or diffusers into one or both rooms (furnished or unfurnished).

NOTE 2 If measurements with additional diffusion are required, for example due to regulatory requirements or because the test result is to be compared with a laboratory measurement on a similar test element, then the introduction of three diffusers will usually be sufficient each with an area of at least 1,0 m<sup>2</sup>.

All measurement methods for the default procedure or the low-frequency procedure are equivalent. In case of dispute, the airborne sound insulation determined using measurement methods without an operator inside the source and/or receiving room shall be taken to be the reference result.

NOTE 3 A reference result is defined for two reasons. Firstly, because an operator will introduce additional absorption in the source room that is not present when the operator is taking measurements in the receiving room. This potentially changes the sound field that is measured in both rooms, although in many situations the effect will be negligible. Secondly, the background noise level with manual scanning is prone to variation in the self-generated noise from the operator that does not tend to occur with fixed microphones or a mechanized continuously-moving microphone.

## 7 Default procedure for sound pressure level measurement

### 7.1 General

Sound pressure level measurements are used to determine the average level in the central zone of the source and receiving rooms with the loudspeaker(s) in operation, and the background noise level in the receiving room when the loudspeaker is switched off.

Sound shall be generated in the source room using loudspeakers operated simultaneously in at least two positions, or a single loudspeaker moved to at least two positions.

The sound power of the loudspeaker(s) should be sufficiently high for the sound pressure level in the receiving room to be significantly above the background noise level as described in [Clause 9](#).

Additional guidance on measurement procedures is given in [Annexes C, D](#) and [E](#).

### 7.2 Generation of sound field

#### 7.2.1 General

Use a single loudspeaker or multiple loudspeakers operating simultaneously provided that they are of the same type and are driven at the same level by similar, but uncorrelated, signals. The loudspeaker(s) shall be stationary during the measurement. Each loudspeaker shall comply with the directivity requirements in [Annex A](#).

The sound generated in the source room shall be steady and have a continuous spectrum over the frequency range that is measured. Parallel measurements over the required range of one-third octave bands can be taken using a broadband noise signal. If filtering of the source signal is used for each frequency band under test, use a filter with a corresponding centre-band frequency that has a bandwidth of at least one-third octave.

The energy-average sound pressure level in the source room shall not have a difference in level of more than 8 dB between adjacent one-third octave bands, at least above 100 Hz. In situations where this cannot be achieved with a broadband noise source, serial measurements in one-third octave bands shall be used with band-limited noise.

White or pink noise is recommended as a broadband noise signal. However, the spectrum might need to be shaped to ensure an adequate signal-to-noise ratio at high frequencies in the receiving room.

NOTE 1 A graphic equaliser is often essential as there may be situations where the 8 dB requirement cannot be met without shaping the source signal. If the 8 dB requirement is not satisfied at low-frequencies it may be possible to satisfy the requirement by changing the loudspeaker position as well as equalising the source signal.

#### 7.2.2 Loudspeaker positions

The distance between the room boundaries and the loudspeaker shall be at least 0,5 m and should be at least 1,0 m when the boundary is the separating partition. This distance shall be measured from the boundary to the centre of the speaker unit that is closest to this boundary.



Different loudspeaker positions shall not be located within planes parallel to the room boundaries that are less than 0,7 m apart. The distance between different positions shall be at least 0,7 m. At least two positions shall be at least 1,4 m apart.

When measuring the airborne sound insulation of a floor with the loudspeaker(s) in the upper room, the base of the loudspeaker(s) shall be at least 1,0 m above the floor.

### 7.3 Fixed microphone positions

#### 7.3.1 General

Fixed microphones may be used without an operator in the room by using a microphone fixed on a tripod. Alternatively the operator can be present in the room with the microphone fixed on a tripod, or with the operator using a manually-held microphone at a fixed position; in both cases the trunk of the operator's body shall remain at a distance at least an arm's length from the microphone. Averaging times shall satisfy the requirements in [7.7.1](#).

#### 7.3.2 Number of measurements

- a) When multiple loudspeakers are operated simultaneously, a minimum of five microphone positions shall be used in each room. These shall be distributed within the maximum permitted space throughout each room. No two microphone positions shall lie in the same plane relative to the room boundaries and the positions shall not be in a regular grid.
- b) When using a single loudspeaker, a minimum of five microphone positions shall be used in each room for each loudspeaker position (additional sets of microphone positions may be different from the first set of positions). Each set of microphone positions shall be distributed within the maximum permitted space throughout each room. No two microphone positions shall lie in the same plane relative to the room boundaries and the positions shall not be in a regular grid.

#### 7.3.3 Multiple loudspeakers operating simultaneously

Measure the sound pressure levels in both the source and receiving rooms. Calculate the energy-average sound pressure level in both the source and receiving rooms according to [7.8](#) then make any required correction for background noise according to [9.2](#). Calculate the standardized level difference using Formula (1) and Formula (2) or the apparent sound reduction index using Formula (1) and Formula (4).

#### 7.3.4 Single loudspeaker operated at more than one position

Measure the sound pressure level in both the source and receiving rooms for the first loudspeaker position. Calculate the energy-average sound pressure level in both the source and receiving rooms according to [7.8](#) then make any required correction for background noise according to [9.2](#). For this loudspeaker position, calculate the standardized level difference using Formula (1) and Formula (2) or the apparent sound reduction index using Formula (1) and Formula (4). Both source and receiving room levels shall be measured before the loudspeaker is moved. Repeat this process for the other loudspeaker position(s). Calculate the standardized level difference using Formula (6) or the apparent sound reduction index using Formula (7):

$$D_{nT} = -10 \lg \frac{1}{m} \sum_{j=1}^m 10^{-D_{nT,j}/10} \quad (6)$$



$$R' = -10 \lg \frac{1}{m} \sum_{j=1}^m 10^{-R_j'/10} \quad (7)$$

where

- $m$  is the number of loudspeaker positions;
- $D_{nT,j}$  is the standardized level difference for loudspeaker position  $j$ ;
- $R_j'$  is the apparent sound reduction index for loudspeaker position  $j$ .

## 7.4 Mechanized continuously-moving microphone

### 7.4.1 General

The microphone shall be mechanically moved with approximately constant angular speed in a circle, or shall be mechanically swept along a circular path where the angle of rotation about a fixed axis is between 270° and 360°. The sweep radius for the circular traverse shall be at least 0,7 m. The plane of the traverse shall be inclined in order to cover a large proportion of the permitted room space and shall not lie in any plane that is less than 10° from any room surface (wall, floor or ceiling).

The duration of a single traverse shall be at least 15 s. Each complete traverse may need to be repeated to satisfy the requirements on the averaging time in [7.7.2](#).

### 7.4.2 Number of measurements

- a) When multiple loudspeakers are operated simultaneously, at least one measurement shall be carried out using the continuously-moving microphone. The location of the fixed point about which the continuously-moving microphone moves shall be changed for each different set of loudspeaker positions. The same number of measurements shall be taken at each location.
- b) When using a single loudspeaker, a minimum of one measurement using the continuously-moving microphone shall be carried out for each loudspeaker position. The location of the fixed point about which the continuously-moving microphone moves may be changed for each loudspeaker position. The same number of measurements shall be taken at each location.

### 7.4.3 Multiple loudspeakers operating simultaneously

Measure the sound pressure level in both the source and receiving rooms. Calculate the energy-average sound pressure level in both the source and receiving rooms according to [7.8](#) then make any required correction for background noise according to [9.2](#). Calculate the standardized level difference using Formula (1) and Formula (2) or the apparent sound reduction index using Formula (1) and Formula (4).

### 7.4.4 Single loudspeaker operated at more than one position

Measure the sound pressure level in both the source and receiving rooms for the first loudspeaker position. Calculate the energy-average sound pressure level in both the source and receiving rooms according to [7.8](#) for the first loudspeaker position then make any required correction for background noise according to [9.2](#). For this loudspeaker position, calculate a standardized level difference using Formula (1) and Formula (2) or an apparent sound reduction index using Formula (1) and Formula (4). Both source and receiving room levels shall be measured before the loudspeaker is moved. Repeat this process for the other loudspeaker positions. Calculate the standardized level difference using Formula (6) or the apparent sound reduction index using Formula (7).

## 7.5 Manually-scanned microphone

### 7.5.1 General

The manual-scanning path shall be a circle, a helix, a cylindrical-type path or three semicircles as shown in [Figure 1](#). A circle, helix or cylindrical-type path shall be used in unfurnished or furnished rooms. If there is insufficient space in the room for the operator to use these paths, the path consisting of three semicircles shall be used. Each complete path may need to be repeated to satisfy the requirements on the averaging time in [7.7.3](#).

NOTE The type of manual-scanning path can be different in the source and the receiving room.

### 7.5.2 Circle

The circular path is indicated in [Figure 1](#). The operator shall stand holding the microphone or sound level meter with outstretched arm while rotating the body through an angle of  $270^\circ$  to  $360^\circ$ . The plane of the circle shall be inclined in order to cover a large proportion of the permitted room space and shall not lie in any plane that is less than  $10^\circ$  from any room surface (wall, floor or ceiling). If required, the knees can be bent to reduce the overall height of the microphone; this should always be done when the path is repeated at another position in the room. To minimize operator noise it can be beneficial to pause the measurement mid-way along the path so the operator can change the position of the body before continuing the scan.

The operator shall aim to achieve a constant angular speed during the scan. The maximum angular speed shall be approximately  $20^\circ$  per second.

### 7.5.3 Helix

The helical path is indicated in [Figure 1](#). The operator holds the microphone or sound level meter with outstretched arm at a starting position that is 0,5 m above the floor then rotates the body at least twice through  $360^\circ$  from a crouched to a standing position, finishing with the microphone at a position that is no more than 0,5 m from the ceiling. To minimize operator noise it can be beneficial to pause the measurement mid-way along the path so the operator can change the position of the body before continuing the scan.

The operator shall aim to achieve a constant angular speed during the scan. The maximum angular speed shall be approximately  $20^\circ$  per second.

### 7.5.4 Cylindrical-type

The cylindrical-type path is indicated in [Figure 1](#). The operator shall use a 0,3 m to 0,9 m extension rod to hold the microphone. For a right-handed operator, the path starts 0,5 m above the floor from a position approximately  $90^\circ$  to the left side, the rod is then swept in a circular path parallel to the ground to cover an angle of approximately  $220^\circ$ . The sweep continues vertically upwards along a straight line until the microphone is 0,5 m from the ceiling, after which another circular sweep covers approximately  $220^\circ$  in the opposite direction, before descending to the starting point along a vertical straight line. For a left-handed operator the directions are reversed.

During the circular sections of the path the operator shall aim to achieve a constant angular speed. The maximum angular speed shall be approximately  $20^\circ$  per second, with a maximum speed of approximately 0,25 m/s over the straight sections of the path.

### 7.5.5 Three semicircles

The path comprising three semicircles is indicated in [Figure 1](#). The operator shall stand holding the microphone or sound level meter with outstretched arm, and trace out three semicircles with approximately  $45^\circ$  to  $60^\circ$  separations. The plane of each semi-circle shall not lie in any plane that is less than  $10^\circ$  from any room surface (wall, floor or ceiling). If required, the knees can be bent to reduce the

overall height of the microphone; this should be done when the path is repeated at another position in the room.

For each of the three semicircles the operator shall aim to achieve a constant angular speed. The maximum angular speed shall be approximately 20° per second.

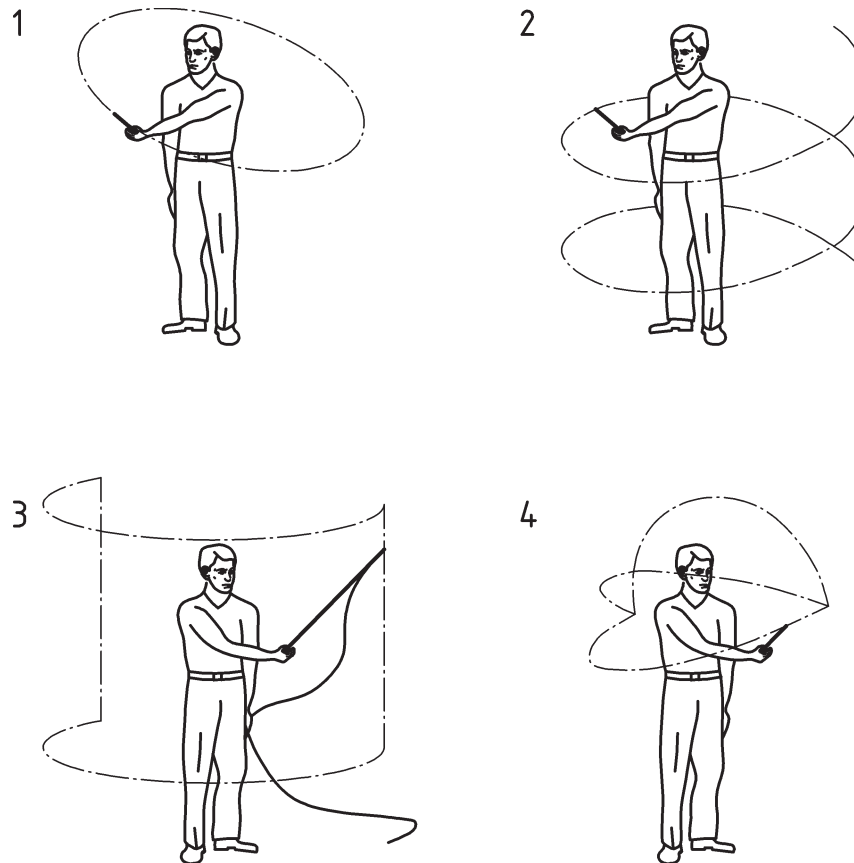

**Key**

- 1 circle
- 2 helix
- 3 cylindrical-type
- 4 three semicircles

**Figure 1 — Manual-scanning paths**

**7.5.6 Number of measurements**

- a) When multiple loudspeakers are operated simultaneously, at least one measurement shall be carried out with a manually-scanned microphone. The location of the operator shall be changed for each different set of loudspeaker positions. The same number of measurements shall be taken at each location.
- b) When using a single loudspeaker, a minimum of one measurement using a manually-scanned microphone shall be carried out for each loudspeaker position. The location of the operator shall be changed for each loudspeaker position. The same number of measurements shall be taken at each location.

### 7.5.7 Multiple loudspeakers operating simultaneously

Measure the sound pressure level in both the source and receiving rooms. Calculate the energy-average sound pressure level in both the source and receiving rooms according to 7.8 then make any required correction for background noise according to 9.2. Calculate the standardized level difference using Formula (1) and Formula (2) or the apparent sound reduction index using Formula (1) and Formula (4).

If a manually-scanned microphone is used with the operator at one fixed point in the receiving room, the measured level corrected for background noise is the energy-average sound pressure level in the receiving room.

### 7.5.8 Single loudspeaker operated at more than one position

Measure the sound pressure level in both the source and receiving rooms for the first loudspeaker position. Calculate the energy-average sound pressure level in both the source and receiving rooms according to 7.8 for the first loudspeaker position then make any required correction for background noise according to 9.2. For this loudspeaker position, calculate the standardized level difference using Formula (1) and Formula (2) or the apparent sound reduction index using Formulae (1) and Formula (4). Both source and receiving room levels shall be measured before the loudspeaker is moved. Repeat this process for the other loudspeaker positions. Calculate the standardized level difference using Formula (6) or the apparent sound reduction index using Formula (7).

## 7.6 Minimum distances for microphone positions

For the default procedure, the following separation distances are minimum values and shall be exceeded where possible:

- a) 0,7 m between fixed microphone positions;
- b) 0,5 m between any microphone position and the room boundaries;
- c) 1,0 m between any microphone position and the loudspeaker.

## 7.7 Averaging times

### 7.7.1 Fixed microphone positions

The averaging time at each individual microphone position shall be at least 6 s in the frequency range of 100 Hz to 400 Hz. For 500 Hz to 5 000 Hz, it is permissible to decrease the time to not less than 4 s. For 50 Hz to 80 Hz, the averaging time at each individual microphone position shall be at least 15 s.

### 7.7.2 Mechanized continuously-moving microphone

The averaging time shall cover a whole number of complete traverses and shall be at least 30 s for 100 Hz to 5 000 Hz, and at least 60 s for 50 Hz to 80 Hz.

### 7.7.3 Manually-scanned microphone

The averaging time shall cover a whole number of complete paths and shall be at least 30 s for 100 Hz to 5 000 Hz, and at least 60 s for 50 Hz to 80 Hz.

## 7.8 Calculation of energy-average sound pressure levels

### 7.8.1 Fixed microphone positions

For measurements where loudspeakers are operated simultaneously or a single loudspeaker is operated at one position, the energy-average sound pressure level in the source or receiving room is determined using Formula (8).

$$L = 10 \lg \left( \frac{p_1^2 + p_2^2 + \dots + p_n^2}{np_0^2} \right) \quad (8)$$

where

$p_1^2, p_2^2, \dots, p_n^2$  are the mean-square sound pressures at  $n$  different microphone positions in the room;

$p_0$  is the reference sound pressure and is equal to 20  $\mu\text{Pa}$ .

In practice, the sound pressure levels are usually measured and the energy-average sound pressure level shall be determined using Formula (9).

$$L = 10 \lg \left( \frac{1}{n} \sum_{i=1}^n 10^{L_i/10} \right) \quad (9)$$

where  $L_1, L_2, \dots, L_n$  are the sound pressure levels at  $n$  different microphone positions in the room.

### 7.8.2 Mechanized continuously-moving microphone and manually-scanned microphone

For each measurement where loudspeakers are operated simultaneously or a single loudspeaker is operated at one position, the energy-average sound pressure level in the source or receiving room is determined using Formula (10).

$$L = 10 \lg \left( \frac{\frac{1}{T_m} \int_0^{T_m} p^2(t) dt}{p_0^2} \right) \quad (10)$$

where

$p$  is the sound pressure, in Pascals;

$T_m$  is the averaging time, in seconds.

When more than one traverse or scan is carried out in the same room, the energy-average sound pressure level in that room is determined using Formula (11).

$$L = 10 \lg \left( \frac{10^{L_1/10} + 10^{L_2/10} + \dots + 10^{L_n/10}}{n} \right) \quad (11)$$

where  $L_1, L_2, \dots, L_n$  are energy-average sound pressure levels from  $n$  different traverses/scans in the room.

## 8 Low-frequency procedure for sound pressure level measurement

### 8.1 General

The low-frequency procedure shall be used for the 50 Hz, 63 Hz, and 80 Hz one-third octave bands in the source and/or receiving room when its volume is smaller than 25 m<sup>3</sup> (calculated to the nearest cubic metre). Sound pressure level measurements are taken close to the corners of the room to identify the corner with the highest level in each band. This is carried out in (a) the source and/or receiving room with the loudspeaker(s) in operation to determine the corner sound pressure level, and (b) in the receiving room when the loudspeaker is switched off to determine the background noise level.

Sound shall be generated in the source room using loudspeakers operated simultaneously in at least two positions, or a single loudspeaker moved to at least two positions.

The sound power of the loudspeaker(s) should be sufficiently high for the sound pressure level in the receiving room to be significantly above the background noise level as described in [Clause 9](#).

### 8.2 Generation of sound field

#### 8.2.1 General

Use a single loudspeaker or multiple loudspeakers operating simultaneously provided that they are of the same type and are driven at the same level by similar, but uncorrelated, signals. The loudspeaker(s) shall be stationary during the measurement. Each loudspeaker shall comply with the directivity requirements in [Annex A](#).

The sound generated in the source room shall be steady and have a continuous spectrum over the frequency range that is measured. Parallel measurements over the required range of one-third octave bands can be taken using a broadband noise signal. If filtering of the source signal is used for each frequency band under test, use a filter with a corresponding centre-band frequency that has a bandwidth of at least one-third octave.

NOTE White or pink noise is recommended as a broadband noise signal. However, the spectrum might need to be shaped to ensure an adequate signal-to-noise ratio at high frequencies in the receiving room.

#### 8.2.2 Loudspeaker positions

The loudspeaker positions that are used for the low-frequency procedure shall be the same positions that are used for the default procedure that satisfy the requirements given in [7.2.2](#).

### 8.3 Microphone positions

For the low-frequency procedure a fixed microphone shall be positioned in room corners at a distance of 0,3 m to 0,4 m from each room boundary that forms the corner (see example in [Figure 2](#)).

NOTE The distance from each boundary that forms the corner does not have to be identical. For example, it could be positioned at a distance of 0,3 m from one boundary, 0,35 m from another boundary and 0,4 m from the remaining boundary.

The minimum distance between any microphone position and the loudspeaker shall be 1,0 m.

As loudspeakers are often positioned near a corner this requirement means that measurements cannot be carried out in any corner where a loudspeaker is positioned.

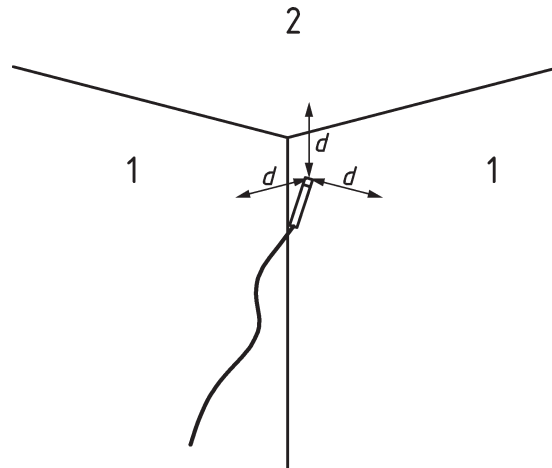

**Key**

- 1 wall
- 2 ceiling

**Figure 2 — An example of a corner microphone position where the distance,  $d$ , shall be between 0,3 to 0,4m. Note that this is an illustrative example of only one possible corner position in a room**

When multiple loudspeakers are operated simultaneously, a minimum of four corners shall be measured using a fixed or manually-held microphone.

When using a single loudspeaker, a minimum of four corners shall be measured using a fixed or manually-held microphone for each loudspeaker position.

For each set of four corner measurements, two corners should be at ground level and two corners should be at ceiling level. These corners may or may not be adjacent to the partition. Corners shall be used which are formed by three intersecting surfaces (such as walls, doors, windows, floor, or ceiling) each having an area of at least 0,5 m<sup>2</sup>, that are perpendicular to each other, with no objects such as furniture within 0,5 m of the corner. Where this is not possible, corners can be used where the three intersecting surfaces have angles between pairs of the surfaces between 45° and 135°, and/or where there are objects close to the three intersecting surfaces, and/or where an object such as a cupboard forms one of the intersecting surfaces.

For the 50 Hz, 63 Hz and 80 Hz one-third octave bands calculate the low-frequency energy average sound pressure level for the source and/or receiving room according to 8.5 then calculate the standardized level difference using Formula (1) and Formula (2) or the apparent sound reduction index using Formula (1) and Formula (4).

**8.4 Averaging time**

For the low-frequency procedure, the averaging time at each individual microphone position shall be at least 15 s.

**8.5 Calculation of low-frequency energy-average sound pressure levels**

When multiple loudspeakers are operated simultaneously the corner sound pressure level is the highest sound pressure level from the set of measured corners for each of the 50 Hz, 63 Hz and 80 Hz one-third octave bands.

When a single loudspeaker is operated at one position (and then further measurements are taken with the loudspeaker in different positions), determine the highest sound pressure level from the set of



measured corners for each of the 50 Hz, 63 Hz and 80 Hz bands. For each frequency band the corner sound pressure level is then calculated from Formula (12).

$$L_{\text{Corner}} = 10 \lg \left( \frac{p_{\text{Corner,LS1}}^2 + p_{\text{Corner,LS2}}^2 + \dots + p_{\text{Corner,LSq}}^2}{q p_0^2} \right) \quad (12)$$

where  $p_{\text{Corner,LS1}}^2, p_{\text{Corner,LS2}}^2, \dots, p_{\text{Corner,LSq}}^2$  are the highest mean-square sound pressures from corner measurements corresponding to the  $q^{\text{th}}$  loudspeaker position.

NOTE For each of the 50 Hz, 63 Hz and 80 Hz bands, the values for  $L_{\text{Corner}}$  may be associated with different corners in the room.

The low-frequency energy-average sound pressure level in the 50 Hz, 63 Hz and 80 Hz bands is calculated by combining  $L$  from the default procedure and  $L_{\text{Corner}}$  from the low-frequency procedure using Formula (13).

$$L_{\text{LF}} = 10 \lg \left[ \frac{10^{0,1L_{\text{Corner}}} + (2 \cdot 10^{0,1L})}{3} \right] \quad (13)$$

## 9 Background noise (default and low-frequency procedure)

### 9.1 General

Measurements of background noise levels shall be made to ensure that the signal level in the receiving room is not affected by the background noise and to allow a correction as described in 9.2. Extraneous sound, such as noise from outside the test room, electrical noise in the receiving system, electrical cross-talk between the source and the receiving systems, mechanical devices used for the continuously-moving microphone and operators inside the test room all contribute to the background noise level.

It is recommended to check that the sound level meter does not introduce spurious signals when pressing buttons which start, pause or stop the measurement.

Operators are a potential source of background noise when using (a) fixed microphone positions where the operator remains inside the receiving room, (b) manually-held microphones or (c) manually-scanned microphones. Self-generated noise from the operator can result from sources such as clothing, shoes, or arm/knee joints. For (a), (b) and (c), the operator shall use at least one of the following three methods to try and identify self-generated noise in the receiving room: (1) the time history of the A-weighted sound pressure level (Fast time weighting) to look for unusual transient events, (2) the difference between the maximum sound pressure level with Fast time weighting and the equivalent continuous sound pressure level in frequency bands to indicate unusual transient events, and (3) their own hearing, but only when hearing protection is not required and not used. Using one or more of these methods the operator shall ensure that self-generated noise due to their movement and activity during the sound pressure level measurement of the signal level is similar to that during the background noise measurements.

For manually-scanned microphones, the operator shall carry out the background noise measurement using the same type of manual-scanning path that is used for the signal level measurement.

For the low-frequency procedure, a background noise measurement shall be carried out in each corner that is used to calculate the corner sound pressure levels.

NOTE For each of the 50 Hz, 63 Hz and 80 Hz bands, the values for  $L_{\text{Corner}}$  can be associated with different corners in the room; hence each band can require an individual correction to the signal level for background noise.

The minimum averaging times for the background noise measurement shall satisfy the requirements in 7.7. Using an averaging time that exactly equals these minimum time periods is only appropriate when the background noise is steady and continuous, otherwise longer averaging times shall be used.



To check the electrical noise in the receiving system or electrical cross-talk between the source and the receiving systems, replace the microphone by a dummy microphone or replace the loudspeaker by an equivalent impedance.

## 9.2 Correction to the signal level for background noise

For the default and the low-frequency procedures, the background noise level shall be at least 6 dB (and preferably more than 10 dB) below the level of signal and background noise combined at each frequency band. If the difference in levels is smaller than 10 dB but greater than 6 dB, calculate corrections to the energy-average sound pressure level and the corner sound pressure level using Formula (14).

$$L = 10 \lg(10^{L_{sb}/10} - 10^{L_b/10}) \quad (14)$$

where

- $L$  is the adjusted signal level, in decibels;
- $L_{sb}$  is the level of signal and background noise combined, in decibels;
- $L_b$  is the background noise level, in decibels.

The values for  $L_{sb}$  and  $L_b$  shall be reduced to one decimal place before use in Formula (14). This is done by taking the value in tenths of a dB closest to the reported values such that XX,XYZZZ... is rounded to XX,X if Y is less than 5 and to XX,X + 0,1 if Y is equal to or greater than 5.

If the difference in levels is less than or equal to 6 dB in any of the frequency bands, use the 1,3 dB correction. For each frequency band where this is the case for the default procedure and/or the low-frequency procedure, it shall be clearly indicated in the report that a 1,3 dB correction has been made and that the values are at the limit of the measurement.

## 10 Reverberation time in the receiving room (default and low-frequency procedure)

### 10.1 General

This clause describes the default procedure that shall be used in the receiving room for all reverberation time measurements, and a low-frequency procedure that shall be used when the receiving room volume is smaller than 25 m<sup>3</sup> (calculated to the nearest cubic metre).

The reverberation times shall be measured using the interrupted noise method or the integrated impulse response method as described in ISO 3382-2 and ISO 18233. The engineering method is preferred although the precision method may be used.

Evaluation of the reverberation time from the decay curve shall start at 5 dB below the initial sound pressure level. The preferred evaluation range is 20 dB. The bottom of the evaluation range shall be at least 10 dB above the overall background noise level.

Any operator that was in the receiving room during the sound pressure level measurement shall also be in the receiving room for reverberation time measurements. The operator may be present in the room with the microphone fixed on a tripod, or with the operator using a manually-held microphone at a fixed position; in both cases the trunk of the operator's body shall remain at a distance at least an arm's length from the microphone. To determine the apparent sound reduction index, calculate the equivalent sound absorption area from the reverberation time using Formula (5).

## 10.2 Generation of sound field

Use loudspeaker(s) at fixed positions that comply with the directivity requirements in [Annex A](#). Loudspeakers can be used simultaneously provided that they are of the same type and are driven at the same level by similar, but uncorrelated, signals.

For the default procedure, the sound generated in the room shall be steady and have a continuous spectrum over the frequency range considered. Parallel measurements over the required range of one-third octave bands can be taken using a broadband noise signal. If filtering of the source signal is used for each frequency band under test, use a filter with a corresponding centre-band frequency with a bandwidth of at least one-third octave.

For the low-frequency procedure, the sound generated in the room shall be steady and have a continuous spectrum at least over the frequency range covered by the 63 Hz octave band.

## 10.3 Default procedure

The default procedure shall use the interrupted noise method described in [10.5](#) or the integrated impulse response method described in [10.6](#) for all one-third octave bands between 50 Hz and 5 000 Hz when the receiving room has a volume larger than or equal to 25 m<sup>3</sup> (calculated to the nearest cubic metre), and between 100 Hz and 5 000 Hz when the receiving room has a volume smaller than 25 m<sup>3</sup> (calculated to the nearest cubic metre).

## 10.4 Low-frequency procedure

The low-frequency procedure shall use the interrupted noise method described in [10.5](#) or the integrated impulse response method described in [10.6](#) when the receiving room volume is smaller than 25 m<sup>3</sup> (calculated to the nearest cubic metre). This procedure requires that the reverberation time is measured in the 63 Hz octave band instead of the 50 Hz, 63 Hz, and 80 Hz one-third octave bands and that this single measured value is used to represent the 50 Hz, 63 Hz and 80 Hz bands in the calculation of  $D_{nT}$  and/or  $R'$ .

NOTE 1 In small room volumes there are relatively few room modes that determine the decay curve in the 50 Hz, 63 Hz and 80 Hz bands. Hence the use of 20 dB or 30 dB evaluation ranges on the decay curves from one-third octave bands are prone to error because single-slope decay curves usually only occur when there are many modes in each frequency band. This issue can partly be resolved through use of the 63 Hz octave band filter.

NOTE 2 In timber or steel frame buildings with gypsum or timber board linings the reverberation times in the 50 Hz, 63 Hz and 80 Hz bands can be sufficiently short that the decay curve is affected by the decay time of the one-third octave band filters in the analyser. This can be avoided by using a 63 Hz octave band filter due to its wider bandwidth which allows the measurement of shorter reverberation times.

## 10.5 Interrupted noise method

For fixed or manually-held microphone positions, the minimum number of measurements required for each frequency band is six. At least one loudspeaker position shall be used with three fixed microphone positions and two measurements at each position, or six fixed microphone positions and one measurement at each position.

For a mechanized continuously-moving microphone, the minimum number of measurements required for each frequency band is six. At least one loudspeaker position shall be used with six measurements carried out along the microphone traverse.

## 10.6 Integrated impulse response method

For the integrated impulse response method, measurement of the reverberation time shall use fixed microphone positions.

Using an impulse source, the minimum number of measurements required for each frequency band is six. At least one source position and six fixed microphone positions shall be used.

The reverberation time shall be calculated by reverse-time integration of the squared impulse response.

## 11 Conversion to octave bands

If the standardized level difference or the apparent sound reduction index are needed in octave bands, these values shall be calculated from the three one-third octave band values in each octave band using Formula (15) or (16) respectively.

$$D_{nT,\text{oct}} = -10 \lg \left( \frac{\sum_{n=1}^3 10^{-D_{nT,1/3\text{oct},n}/10}}{3} \right) \quad (15)$$

$$R'_{\text{oct}} = -10 \lg \left( \frac{\sum_{n=1}^3 10^{-R'_{1/3\text{oct},n}/10}}{3} \right) \quad (16)$$

The one-third octave band values shall be reduced to one decimal place before use in Formulae (15) and (16). This is done by taking the value in tenths of a dB closest to the reported values such that XX,XYZZZ... is rounded to XX,X if Y is less than 5 and to XX,X + 0,1 if Y is equal to or greater than 5. Present the final results with no higher precision than to the nearest 0,1 dB.

## 12 Recording results

For the statement of the airborne sound insulation of the test element, the measurement results,  $D_{nT}$  or  $R'$ , shall be given in decibels at all measurement frequencies in one-third octave bands to one decimal place, both in tabular form and in the form of a curve.

Graphs in the test report shall show the value in decibels plotted against frequency on a logarithmic scale; the following dimensions shall be used:

- a) 5 mm for a one-third octave band;
- b) 20 mm for 10 dB.

The preferred format for the graphs is given [Annex B](#) with the accompanying text stating all relevant information concerning the test site, construction, procedure and results.

## 13 Uncertainty

The uncertainty of the measurement result shall be determined in accordance with the method given in ISO 12999-1.

## 14 Test report

The test report shall include at least the following information:

- a) reference to this part of this International Standard (i.e. ISO 16283-1:2014), and any amendments;
- b) name of the organization that has performed the measurements;
- c) name and address of the organization or person who commissioned the test (client);
- d) date of the test;
- e) description and identification of the building construction (address or other unambiguous identifier) and test arrangement (including any temporary modification of the room contents for the test, e.g. the introduction of diffusers – see [Clause 6](#));

- f) volumes of the source and receiving rooms (calculated to the nearest cubic metre) and the area of any separating element  $S$ ;
- g) standardized level difference  $D_{nT}$  between the rooms or the apparent sound reduction index  $R'$  of the separating element as a function of frequency;
- h) brief description of the test procedure, brief details of the equipment, and indicate which rooms used the low-frequency procedures for sound pressure level and reverberation time in the 50 Hz, 63 Hz and 80 Hz one-third octave bands;
- i) indications of results which are to be taken as limits of measurement. They shall be given as  $D_{nT}$  or  $R' \geq \dots$ dB. This shall be applied if the sound pressure level in any band is not measurable on account of background noise (see [Clause 9](#));

For the evaluation of single-number ratings from the curves, see ISO 717-1. It shall be clearly stated that the evaluation has been based on a result obtained by a field method. The test report should also include the uncertainty in the single-number rating.

The recommended form for recording results is given in [Annex B](#).

## Annex A (normative)

### Requirements for loudspeakers

#### A.1 General

A loudspeaker shall be a closed cabinet containing one or more individual speaker units. All speaker units in the same cabinet shall radiate in phase.

The positions and directivity of the loudspeaker(s) shall permit microphone positions to be used outside the direct field and shall ensure that the direct radiation is not dominant on the common partition, and wherever possible, on the flanking elements.

The directivity of loudspeakers shall have approximately uniform, omnidirectional radiation. The qualification procedure for loudspeaker directivity that is described in [A.2](#) shall be used to confirm that the loudspeaker is suitable for measurements.

**NOTE** In choosing a suitable loudspeaker, it is common to find that loudspeakers mounted on the surfaces of a polyhedron, preferably a dodecahedron, will give uniform, omnidirectional radiation. This is also achievable with a hemisphere polyhedron loudspeaker that is mounted directly on the floor although this will preclude vertical measurements where the upper room is the source room due to the requirement in [7.2.2](#).

#### A.2 Qualification procedure for directivity

To test the directional radiation of a loudspeaker, measure the sound pressure levels around the source at a distance of 1,5 m from the centre of the loudspeaker in a free-field environment. The loudspeaker should be rotated using a turntable or by taking discrete measurements at 5° intervals. The loudspeaker shall be driven with a broadband noise signal, and measurements made in one-third octave bands.

Measure  $L_{360^\circ}$  which is the energy-average level for the complete arc of 360°. Measure  $L_{30,i}$  values for each angle step  $i$  (typically chosen as 1° or 5° intervals) which correspond to the energy-average value over an arc of 30° that is centred around the angle step (i.e. ± 15°). The directivity indices shall be calculated using Formula (A.1).

$$DI_i = L_{360^\circ} - L_{30,i} \tag{A.1}$$

For one-third octave bands, the loudspeaker(s) can be considered to have uniform omnidirectional radiation if the  $DI$  values are within ± 2 dB for the frequency range from 100 Hz to 630 Hz, ± 5 dB for 800 Hz and ± 8 dB for the frequency range from 1 000 Hz to 5 000 Hz.

Carry out the test in different planes to ensure inclusion of the “worst case” condition. For a polyhedron source, testing in one plane is sufficient.

This qualification procedure shall be carried out at intervals not exceeding two years to ensure conformance.

## **Annex B** (informative)

### **Forms for recording results**

This annex gives examples of forms for recording results for the field measurements of airborne sound insulation between rooms for one-third octave bands. The curves of reference values shown in the forms are taken from ISO 717-1. The latest version of that standard is applied. The reference curves should be supplemented or at least replaced by the shifted reference curves according to the procedure described in ISO 717-1.

<b>Standardized level difference measured in accordance with ISO 16283-1</b>																																													
<b>Field measurements of airborne sound insulation between rooms</b>																																													
Client:	Date of test:																																												
Description and identification of the building construction and test arrangement, direction of measurement etc.																																													
Area of common partition:	m <sup>2</sup>																																												
Source room volume	m <sup>3</sup>																																												
Receiving room volume:	m <sup>3</sup>																																												
— — frequency range according to the _____ curve of reference values (ISO 717-1)																																													
<table border="1" style="width: 100%; border-collapse: collapse;"> <thead> <tr> <th style="text-align: center;">Frequency <i>f</i> Hz</th> <th style="text-align: center;"><i>D<sub>nT</sub></i> one-third octave dB</th> </tr> </thead> <tbody> <tr><td style="text-align: center;">50</td><td></td></tr> <tr><td style="text-align: center;">63</td><td></td></tr> <tr><td style="text-align: center;">80</td><td></td></tr> <tr><td style="text-align: center;">100</td><td></td></tr> <tr><td style="text-align: center;">125</td><td></td></tr> <tr><td style="text-align: center;">160</td><td></td></tr> <tr><td style="text-align: center;">200</td><td></td></tr> <tr><td style="text-align: center;">250</td><td></td></tr> <tr><td style="text-align: center;">315</td><td></td></tr> <tr><td style="text-align: center;">400</td><td></td></tr> <tr><td style="text-align: center;">500</td><td></td></tr> <tr><td style="text-align: center;">630</td><td></td></tr> <tr><td style="text-align: center;">800</td><td></td></tr> <tr><td style="text-align: center;">1 000</td><td></td></tr> <tr><td style="text-align: center;">1 250</td><td></td></tr> <tr><td style="text-align: center;">1 600</td><td></td></tr> <tr><td style="text-align: center;">2 000</td><td></td></tr> <tr><td style="text-align: center;">2 500</td><td></td></tr> <tr><td style="text-align: center;">3 150</td><td></td></tr> <tr><td style="text-align: center;">4 000</td><td></td></tr> <tr><td style="text-align: center;">5 000</td><td></td></tr> </tbody> </table>	Frequency <i>f</i> Hz	<i>D<sub>nT</sub></i> one-third octave dB	50		63		80		100		125		160		200		250		315		400		500		630		800		1 000		1 250		1 600		2 000		2 500		3 150		4 000		5 000		
Frequency <i>f</i> Hz	<i>D<sub>nT</sub></i> one-third octave dB																																												
50																																													
63																																													
80																																													
100																																													
125																																													
160																																													
200																																													
250																																													
315																																													
400																																													
500																																													
630																																													
800																																													
1 000																																													
1 250																																													
1 600																																													
2 000																																													
2 500																																													
3 150																																													
4 000																																													
5 000																																													
Rating in accordance with ISO 717-1:																																													
$D_{nT,w} (C; C_{tr}) = ( \quad ; \quad )$ dB																																													
$C_{50-3150} =$ dB;	$C_{50-5000} =$ dB;																																												
$C_{100-5000} =$ dB																																													
Evaluation based on field measurement using $C_{tr,50-3150} =$ dB;																																													
$C_{tr, 50-5000} =$ dB;																																													
$C_{tr, 100-5000} =$ dB																																													
results obtained by an engineering method:																																													
No. of test report:	Name of test institute:																																												
Date:	Signature:																																												

Figure B.1 — Example of a form for recording results

<b>Apparent sound reduction index measured in accordance with ISO 16283-1</b> <b>Field measurements of airborne sound insulation between rooms</b>																																													
Client:	Date of test:																																												
Description and identification of the building construction and test arrangement, direction of measurement etc.																																													
Area of common partition:	m <sup>2</sup>																																												
Source room volume:	m <sup>3</sup>																																												
Receiving room volume:	m <sup>3</sup>																																												
--- frequency range according to the _____ curve of reference values (ISO 717-1)																																													
<table border="1" style="width: 100%; border-collapse: collapse;"> <thead> <tr> <th style="padding: 5px;">Frequency <i>f</i> Hz</th> <th style="padding: 5px;"><i>R'</i> one-third octave dB</th> </tr> </thead> <tbody> <tr><td style="padding: 5px;">50</td><td style="padding: 5px;"></td></tr> <tr><td style="padding: 5px;">63</td><td style="padding: 5px;"></td></tr> <tr><td style="padding: 5px;">80</td><td style="padding: 5px;"></td></tr> <tr><td style="padding: 5px;">100</td><td style="padding: 5px;"></td></tr> <tr><td style="padding: 5px;">125</td><td style="padding: 5px;"></td></tr> <tr><td style="padding: 5px;">160</td><td style="padding: 5px;"></td></tr> <tr><td style="padding: 5px;">200</td><td style="padding: 5px;"></td></tr> <tr><td style="padding: 5px;">250</td><td style="padding: 5px;"></td></tr> <tr><td style="padding: 5px;">315</td><td style="padding: 5px;"></td></tr> <tr><td style="padding: 5px;">400</td><td style="padding: 5px;"></td></tr> <tr><td style="padding: 5px;">500</td><td style="padding: 5px;"></td></tr> <tr><td style="padding: 5px;">630</td><td style="padding: 5px;"></td></tr> <tr><td style="padding: 5px;">800</td><td style="padding: 5px;"></td></tr> <tr><td style="padding: 5px;">1 000</td><td style="padding: 5px;"></td></tr> <tr><td style="padding: 5px;">1 250</td><td style="padding: 5px;"></td></tr> <tr><td style="padding: 5px;">1 600</td><td style="padding: 5px;"></td></tr> <tr><td style="padding: 5px;">2 000</td><td style="padding: 5px;"></td></tr> <tr><td style="padding: 5px;">2 500</td><td style="padding: 5px;"></td></tr> <tr><td style="padding: 5px;">3 150</td><td style="padding: 5px;"></td></tr> <tr><td style="padding: 5px;">4 000</td><td style="padding: 5px;"></td></tr> <tr><td style="padding: 5px;">5 000</td><td style="padding: 5px;"></td></tr> </tbody> </table>	Frequency <i>f</i> Hz	<i>R'</i> one-third octave dB	50		63		80		100		125		160		200		250		315		400		500		630		800		1 000		1 250		1 600		2 000		2 500		3 150		4 000		5 000		
Frequency <i>f</i> Hz	<i>R'</i> one-third octave dB																																												
50																																													
63																																													
80																																													
100																																													
125																																													
160																																													
200																																													
250																																													
315																																													
400																																													
500																																													
630																																													
800																																													
1 000																																													
1 250																																													
1 600																																													
2 000																																													
2 500																																													
3 150																																													
4 000																																													
5 000																																													
Rating in accordance with ISO 717-1: $R'_W (C; C_{tr}) = ( \quad ; \quad )$ dB																																													
Evaluation based on field measurement using $C_{tr, 50-3150} =$ dB; $C_{50-5000} =$ dB; $C_{100-5000} =$ dB results obtained by an engineering method: $C_{tr, 50-5000} =$ dB; $C_{tr, 100-5000} =$ dB																																													
No. of test report:	Name of test institute:																																												
Date:	Signature:																																												

**Figure B.2 — Example of a form for recording results**



## Annex C (informative)

### Additional guidance

#### C.1 General

This annex contains additional measurement guidelines for room volumes in the range  $10 \text{ m}^3 \leq V \leq 250 \text{ m}^3$  in the frequency range 100 Hz to 3 150 Hz. However, the basic principles may also be used for measurements in the frequency range 50 Hz to 80 Hz (when the room volumes are equal to, or larger than  $25 \text{ m}^3$  calculated to the nearest cubic metre) and in the frequency range 4 000 Hz to 5 000 Hz.

#### C.2 Principles

##### C.2.1 Choice of source and receiving room

If the rooms are of different volumes, the larger room should be chosen as source room when the standardized level difference is to be evaluated apart from exceptions a) and b) described below.

- a) For horizontal measurements where one of the rooms has a well-defined simple volume (i.e. a box-shaped room) while the other has a more complicated geometry, the former should be used as the receiving room, even if it is the larger of the two rooms.
- b) The upper room may only be used as the source room when an omnidirectional loudspeaker is positioned at a sufficient distance above the floor to prevent significant excitation of the floor by the direct sound. The stand supporting the loudspeaker should be placed on a resilient material to prevent structure-borne sound power input into the floor.

##### C.2.2 Calculation of room volumes

When calculating the room volume, the volumes of objects in the receiving room with closed non-absorbing surfaces, such as wardrobes, cabinets and installation shafts, should not be included in the total volume of the receiving room.

##### C.2.3 Calculation of common partition area

When calculating the area of the common partition, the area should not be reduced by objects such as fixed cabinets or wardrobes that cover part of the common partition.

##### C.2.4 Number of microphone and loudspeaker positions

The recommended number of microphone and loudspeaker positions are given in [Table C.1](#).

**Table C.1 — Number of microphone and loudspeaker positions determined from the floor area of the source and receiving rooms**

Measurement set-up	Floor area m <sup>2</sup>	Number of positions			
		Loudspeakers (source room)	Fixed or manually-held microphone positions	Mechanized continuously-moving microphone positions	Manually-scanned microphone positions
A	< 50	2	5 <sup>a</sup> (10)	1 <sup>a</sup> (2)	1 <sup>a</sup> (2)
B	50 to 100	2	10 <sup>b</sup> (10)	2 <sup>b</sup> (2)	2 <sup>b</sup> (2)

<sup>a</sup> The same five microphone positions, microphone traverse or manual-scanning path may be used for both loudspeaker positions.

<sup>b</sup> The same microphone positions, microphone traverse or manual-scanning path should not be used for both loudspeakers.

NOTE The numbers in parentheses for the microphone positions are the total numbers of sound pressure level measurements to be carried out in the room.

### C.2.5 Horizontal measurements

Examples of suitable loudspeaker and microphone positions for horizontal measurements are shown in [Annex D](#).

The loudspeaker positions should normally be chosen to be at the two corners near the back wall of the source room that are opposite the common partition.

For source rooms with a floor area exceeding 50 m<sup>2</sup>, the loudspeakers should not be placed at a distance from the common partition exceeding 10 m, or 2,5 times the width of the partition in the source room; use the criterion giving the shortest distance. See [Annex D](#), Examples 1, 2 and 3. If the source room floor area is limited (see Example 2 in [Annex D](#)), the limited area is used when selecting the number of loudspeaker and microphone positions from [Table C.1](#).

If sound transmission is dominated by transmission through a flanking wall, flanking floor or flanking façade, the loudspeaker should not be placed close to that flanking element.

### C.2.6 Vertical measurements

Examples of suitable loudspeaker and microphone positions for vertical measurements are shown in [Annex E](#).

The loudspeaker positions should normally be chosen to be as close as possible to the corners of the room.

If sound transmission is dominated by transmission through a flanking wall, flanking floor or a flanking façade, the loudspeaker should not be placed close to that flanking element.

If the receiving room is smaller than the source room, the loudspeakers should be situated in that part of the source room closest to the common partition if the floor area of the source room exceeds 50 m<sup>2</sup>. See [Annex E](#), Examples 21, 23 and 25.

## C.3 Specific room types

### C.3.1 Partly-divided rooms

Partly-divided rooms can be found in (a) finished buildings (example, an open-plan kitchen / living room which is partly divided by a wall) or (b) unfinished buildings under construction.

For horizontal transmission between partly-divided rooms in a finished building, the room can be considered as two individual rooms if the area of the opening is equal to or less than one-third of the

total area of the vertical section of the room in the plane containing the dividing wall. If the room is considered as one room volume, measurement set-up B in [Table C.1](#) should be used where appropriate. The loudspeaker positions are situated to “cover” the entire area of the common partition as completely as possible. Where possible, the entire common partition should be visible from both loudspeaker positions. The same principles are applicable to room-dividing walls with a height less than the height of the room. Examples of horizontal measurements between partly-divided rooms are shown in [Annex D](#), Examples 9, 10, 11, 12 and 13. For vertical transmission where one or both rooms are partly divided by a wall, the same principles as for horizontal transmission should be used. See [Annex E](#), Examples 26, 27, and 28.

For an unfinished building under construction where two rooms are coupled by a large opening, the opening should be covered by sheet material such as plywood or gypsum board to achieve well-defined rooms for the measurement.

### C.3.2 Highly-damped rooms

In large, or long room rooms which are highly-damped (i.e. have a short reverberation time), the sound pressure level can decrease considerably with distance from the loudspeaker. A common example is a long corridor with a highly absorbing ceiling and carpet on an access floor.

In highly-damped receiving rooms, it may be necessary to limit the part of the receiving room volume in which the sound pressure level is sampled. Parts of the receiving room where the sound pressure level is 6 dB or more below the level in the part of the room closest to the common partition should be excluded. For horizontal measurements, a reference measurement position is chosen 0,5 m from the middle of the common partition and 1,5 m above floor level. For vertical measurements, a reference measurement position is chosen 1,5 m above the middle of the common partition.

With the loudspeaker in the source room switched on, the sound pressure level decay may be estimated by measuring the A-weighted sound pressure level in the reference position and in positions with increasing distance to this. A hand-held sound level meter may be used. The limited receiving room volume is used for the measurement as well as for the calculation of the sound reduction index.

In highly-damped source rooms, the decay in the sound pressure level from a position 1 m in front of the loudspeaker to a position 0,5 m in front of common partition should not exceed 6 dB. If this is the case, the loudspeaker should be moved closer to the common partition.

### C.3.3 Staggered rooms

If the rooms are staggered and the floor area of the source room exceeds 50 m<sup>2</sup>, the loudspeakers should be situated in that part of the source room that is closest to the common partition. For vertical measurements, the loudspeakers should not be placed at a distance from the back wall of the source room exceeding 2,5 times the width of the source room, or 10 m; use the criterion giving the shortest distance. See [Annex E](#), Examples 17, 21 and 23.

If the width of the common partition for horizontal measurements is less than half the width of the partition in the source room, the distance between the loudspeaker positions should be reduced to approximately 2,5 times the width of the common partition (this is relevant if the receiving room is much smaller than the source room, or if the rooms are staggered). The positions are chosen in that part of the room closest to the common partition. The distance should not be reduced to less than 5 m. See [Annex D](#), Examples 4 and 5.

Loudspeaker positions on the symmetrical lines of the room should be avoided. If the rooms are completely staggered (no common partition), the distance between the loudspeakers should not be reduced. See [Annex D](#), Example 6.

Examples of vertical measurements are shown in [Annex E](#), Examples 17, 18 and 19.

### C.3.4 Complicated room geometry

No general guidelines can be given for measurements between rooms with unusually complicated room geometries. One example could be open-plan, split-level dwellings, each consisting of several coupled spaces. In such situations, it is not always possible to state the volume of the receiving room and the area of the common partition. Furthermore, selection of loudspeaker and microphone positions can be very difficult. The principal rule in such situations is that the loudspeakers should be placed in that part of the dwelling closest to what has been defined as the common partition and often three or four loudspeaker positions will be required.

## C.4 Measurements where doors form the common partition

### C.4.1 Loudspeaker and microphone positions

Normally, one side of the door can be regarded as the outside (e.g. the side of the door facing a corridor or a stairwell). In these situations the corridor or stairway should be used as source room. Two loudspeaker positions should be used. The loudspeaker should be placed on the floor in a corner of the room opposite the door. It should be placed neither close to the door nor close to the wall in which the door is mounted. When using fixed microphones, five positions should be used both in the source room and in the receiving room. When a rotating microphone is applied, one position is used in both the source room and the receiving room.

NOTE For doors mounted between two regular rooms (e.g. hotel rooms or classrooms), where an indoor and outdoor side cannot be defined, the principles stated above can also be used.

### C.4.2 Doors between a corridor and a room

An example of doors between a corridor and a room occurs with an entrance hall. In the corridor, loudspeaker positions should be placed approximately 6 m apart. To avoid symmetry, the positions should be displaced so one position is situated, for example, 2,5 m to the right of the door and the other 3,5 m to the left (see [Annex D](#), Example 14.)

### C.4.3 Doors between a stairwell and a room

In narrow stairwells without suitable corners, the two loudspeakers should be placed half a storey up and half a storey down, either on the stairs or on a landing.

### C.4.4 Determination of the apparent sound reduction index of a door in a building

The apparent sound reduction index of the door is determined by Formula (C.1). By using this formula, it is assumed that all the sound is transmitted through the area  $S_{\text{door}}$ . If this assumption is correct, then  $R'_{\text{door}}$  is a correct value for the sound reduction index of the door.

$$R'_{\text{door}} = L_1 - L_2 + 10 \lg \left( \frac{S_{\text{door}}}{A} \right) \quad (\text{C.1})$$

where

- $R'_{\text{door}}$  is the apparent sound reduction index of the door, in decibels;
- $L_1$  is the average sound pressure level in the source room, in decibels;
- $L_2$  is the average sound pressure level in the receiving room, in decibels;
- $A$  is the equivalent absorption area in the receiving room, in square metres;
- $S_{\text{door}}$  is the area of the free opening in which the door, including its frame, is mounted, in square metres.

A second measurement is required in order to check the flanking transmission by fitting the door with additional sound insulation. The apparent sound reduction index for the insulated door is determined by Formula (C.2).

$$R'_{\text{door\_ins}} = L_{1\_\text{ins}} - L_{2\_ \text{ins}} + 10 \lg \frac{S_{\text{door}}}{A} \quad (\text{C.2})$$

where  $L_{1\_ \text{ins}}$  and  $L_{2\_ \text{ins}}$  are the source and receiving room levels, respectively.

NOTE 1 It is assumed that the additional sound insulation works is sufficient to ensure that the sound transmission through the insulated door is negligible compared with the transmission through the surrounding wall and other flanking paths.

By comparing the results obtained from Formulae (C.1) and (C.2), the following three situations can occur.

$$R'_{\text{door\_ins}} - R'_{\text{door}} \geq 15 \text{ dB} \quad (\text{C.3})$$

Without making any significant error, Formula (C.1) gives the required sound reduction index of the door.

$$6 \text{ dB} < R'_{\text{door\_ins}} - R'_{\text{door}} < 15 \text{ dB} \quad (\text{C.4})$$

Sound transmission through the door is affected by transmission through the surrounding construction. This is true under the assumption that the additional insulation works as intended, i.e. that the transmission through the additionally insulated door is negligible in comparison with the transmission through the surrounding wall. The approximate sound reduction index of the door,  $R'_{\text{door\_app}}$  should be evaluated using Formula (C.5).

$$R'_{\text{door\_app}} = -10 \lg \left( \frac{10^{-R'_{\text{door}}}}{10} - \frac{10^{-R'_{\text{door\_ins}}}}{10} \right) \quad (\text{C.5})$$

$$R'_{\text{door\_ins}} - R'_{\text{door}} \leq 6 \text{ dB} \quad (\text{C.6})$$

The sound reduction of the surrounding wall is too low to enable an accurate determination of the sound reduction index of the door. As for (b), this statement presupposes that the additional sound insulation is sufficiently high. A lower limit of the sound reduction of the door can be evaluated using Formula (C.7).

$$R'_{\text{door\_app}} > R'_{\text{door}} + 1,3 \text{ dB} \quad (\text{C.7})$$

If the only purpose of the test is to check whether the door fulfils a certain sound insulation requirement and this is fulfilled already by the apparent sound reduction index  $R'_{\text{door}}$ , then it is not necessary to perform the second measurement with the additional insulation and to determine  $R'_{\text{door\_app}}$  because the following inequality Formula (C.8) always applies:

$$R'_{\text{door\_app}} \geq R'_{\text{door}} \quad (\text{C.8})$$

The different notations introduced in this clause for the sound reduction index should not be used when reporting measurements on doors. They are only used in this Annex to clarify the procedure.

NOTE 2 In certain situations it may be possible to determine the transmission through the surrounding wall by performing measurements in another adjacent receiving room with the same type of wall, but without a door present. In such cases the inconvenience of using the additional insulation can be avoided. Alternatively, the sound insulation of the door can be determined using the sound intensity technique (see ISO 15186-2 for details).

## Annex D (informative)

### Horizontal measurements — Examples of suitable loudspeaker and microphone positions

This annex contains examples of suitable loudspeaker and microphone positions for horizontal measurements of airborne sound insulation.

All examples are horizontal sections.

Room dimensions in metres are only indicated on the sketches to illustrate the example.

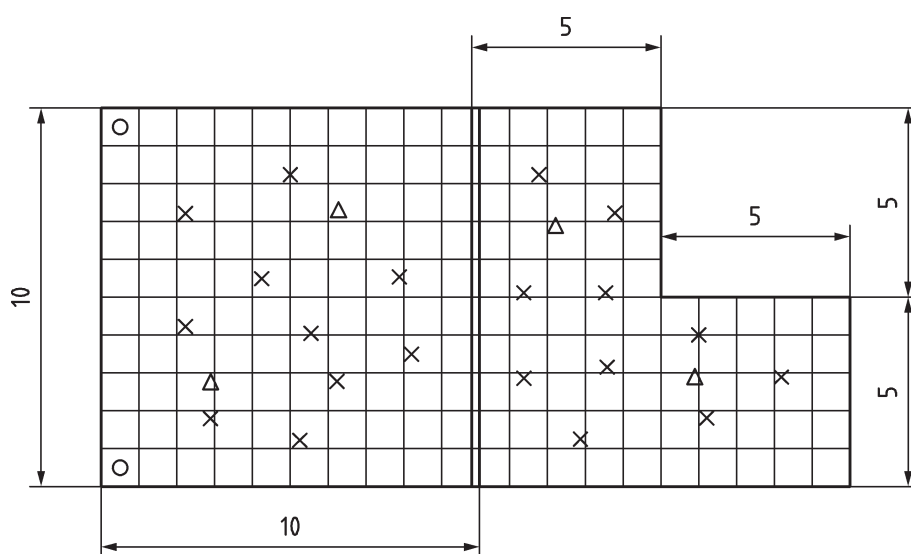

a) Example 1

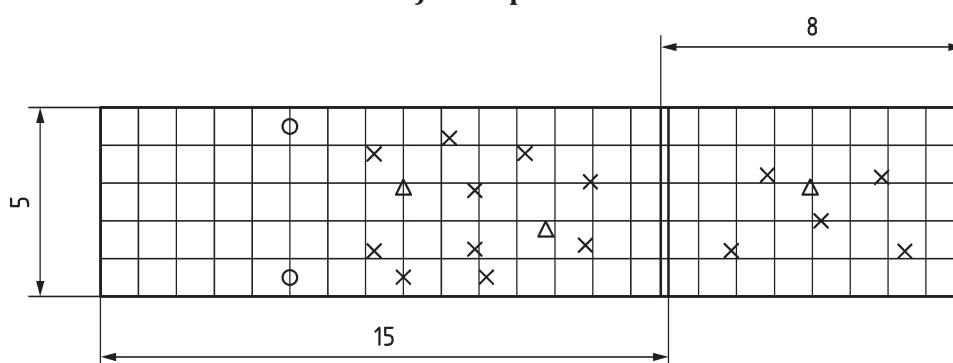

b) Example 2

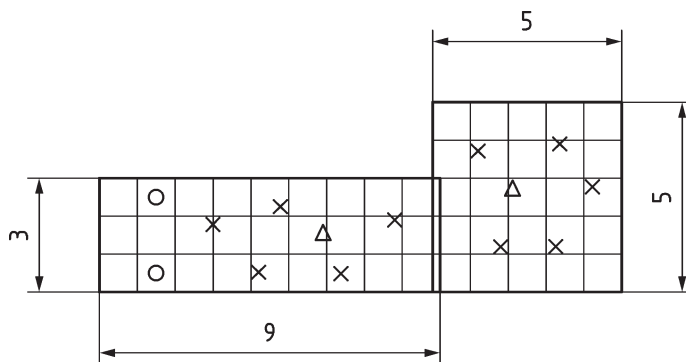

c) Example 3

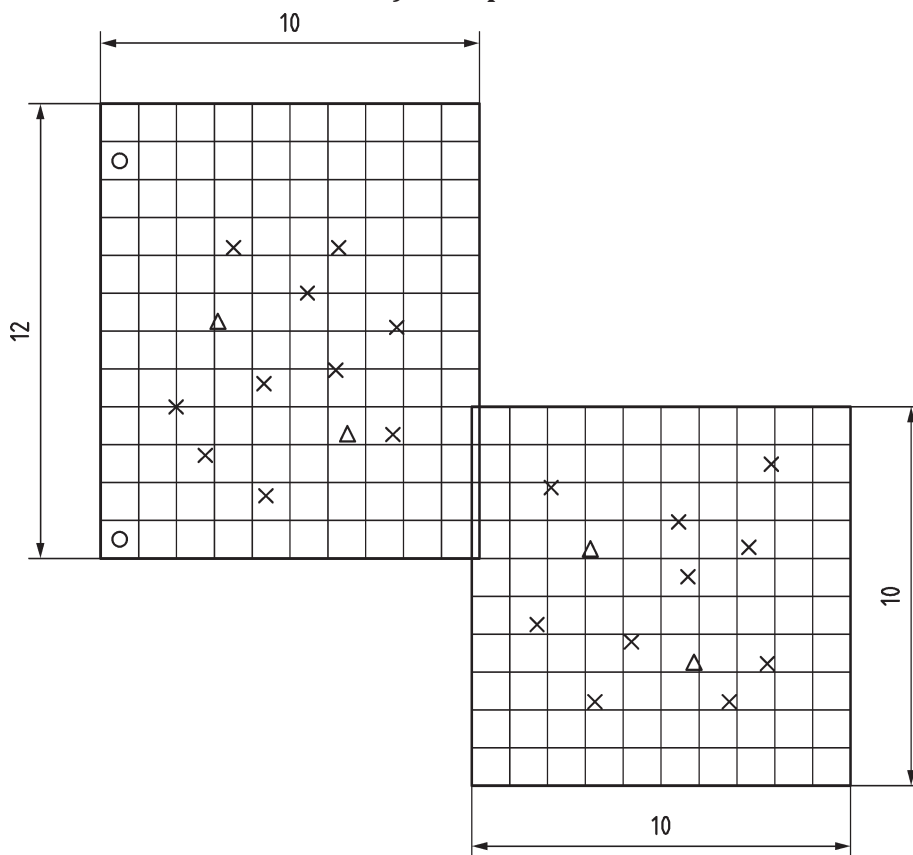

d) Example 4

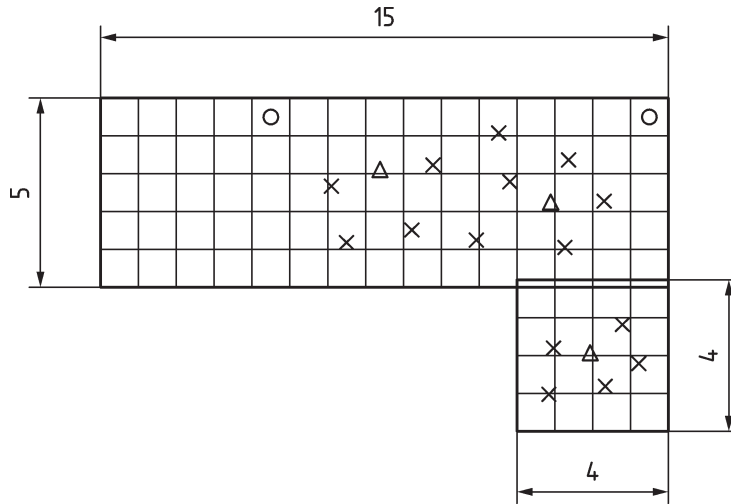

e) Example 5

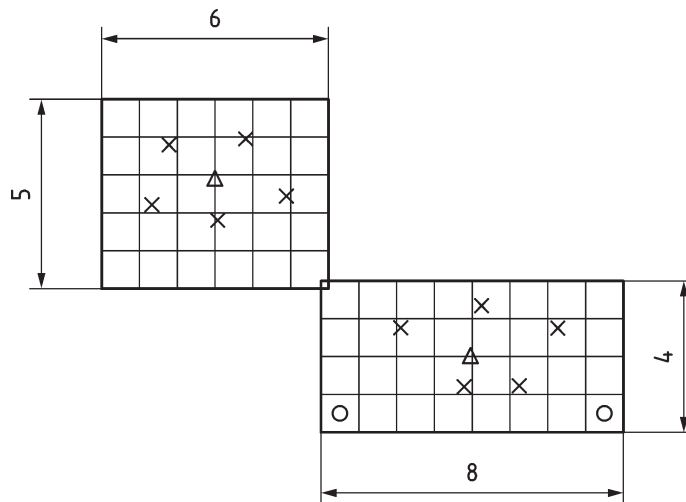

f) Example 6

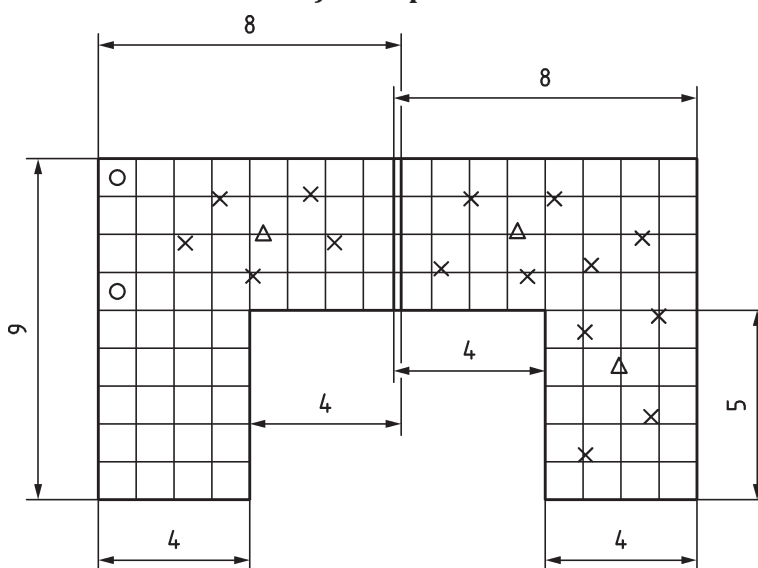

g) Example 7



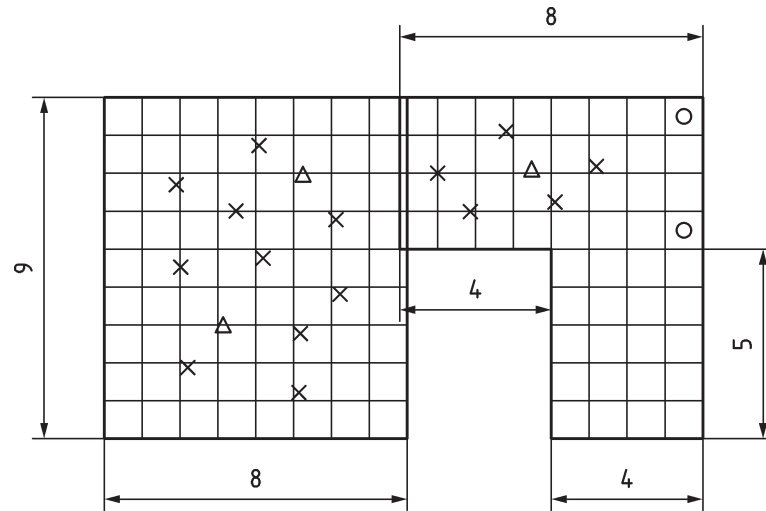

**h) Example 8**

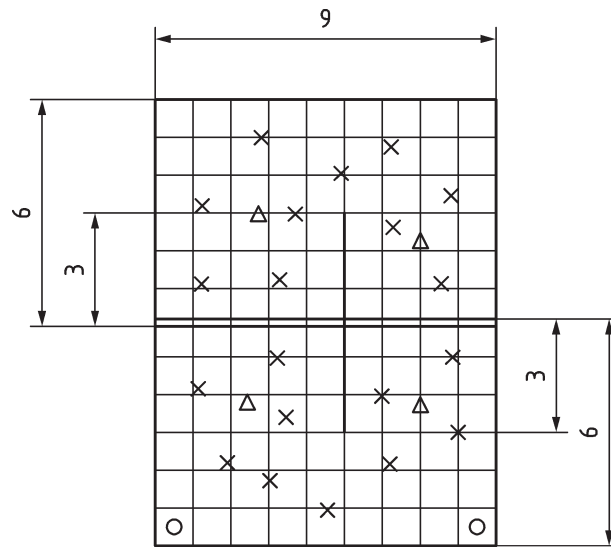

**i) Example 9**

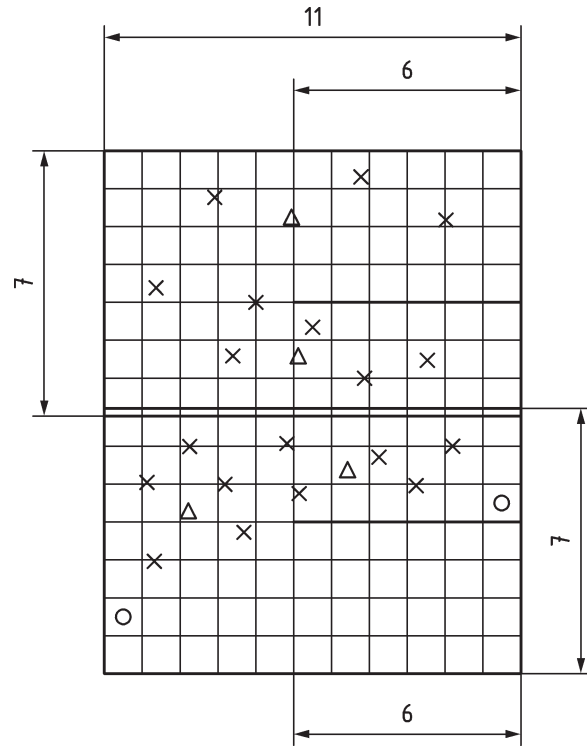

j) Example 10

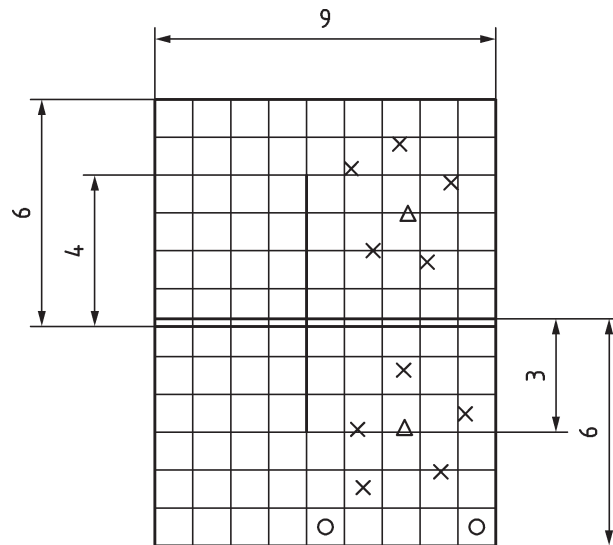

k) Example 11

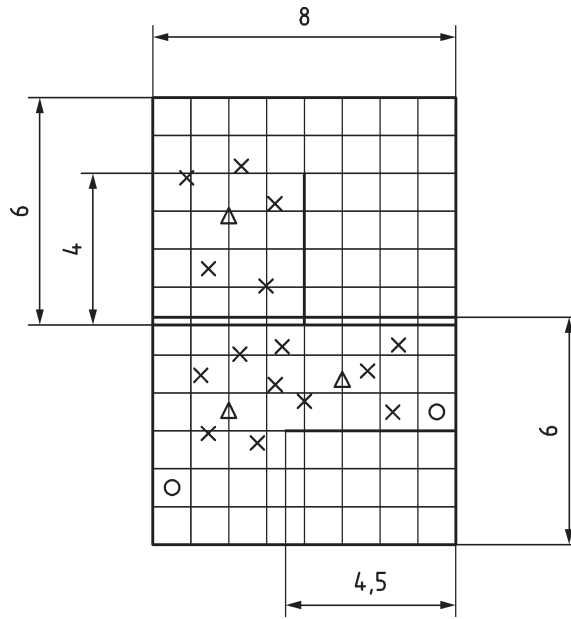

**l) Example 12**

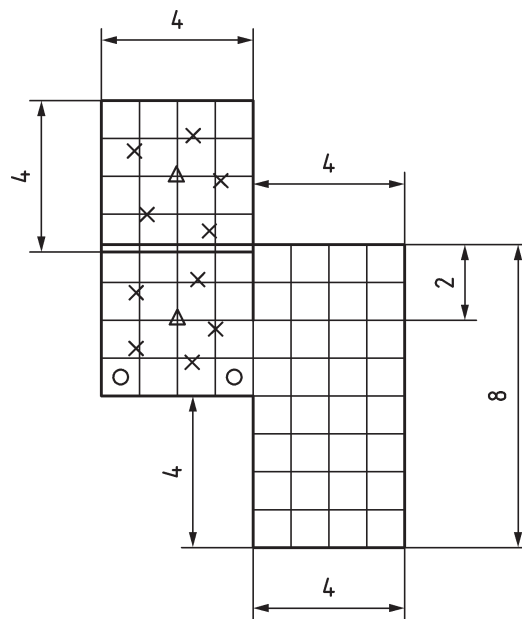

**m) Example 13**

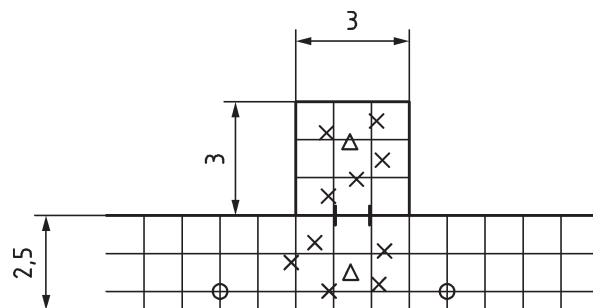

n) Example 14

**Key**

- loudspeaker
- × fixed microphone position
- Δ fixed point about which a mechanized continuously-moving microphone moves or the position of the operator for a manually-scanned microphone
- room boundaries
- = common partition

**Figure D.1 — Horizontal measurements — Scale 1:200, Examples 1 to 14**

## Annex E (informative)

### Vertical measurements — Examples of suitable loudspeaker and microphone positions

This annex contains examples of suitable loudspeaker and microphone positions for vertical measurements of airborne sound insulation.

All examples are horizontal sections.

Room dimensions in metres are only indicated on the sketches to illustrate the example.

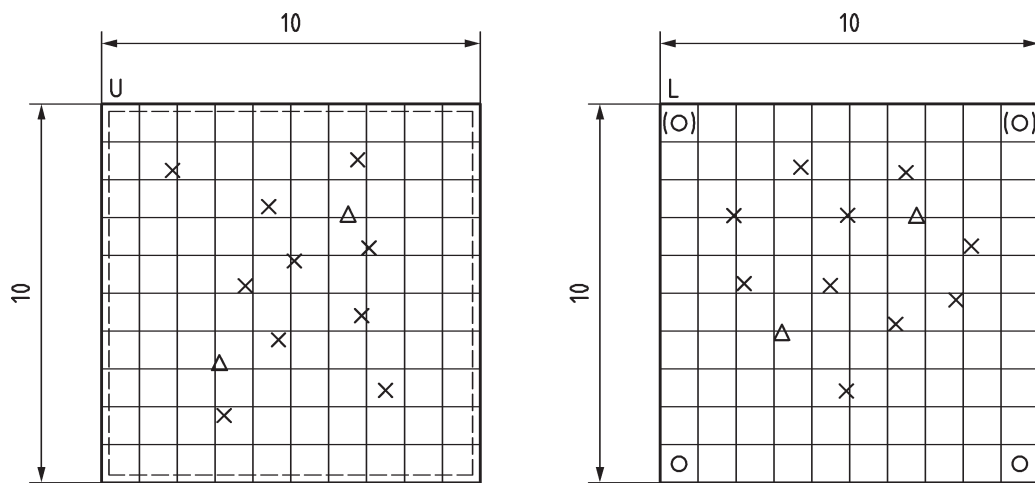

**a) Example 15**

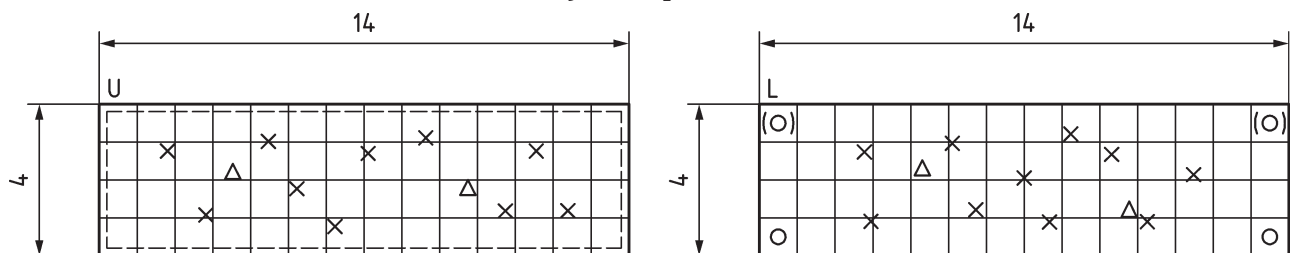

**b) Example 16**

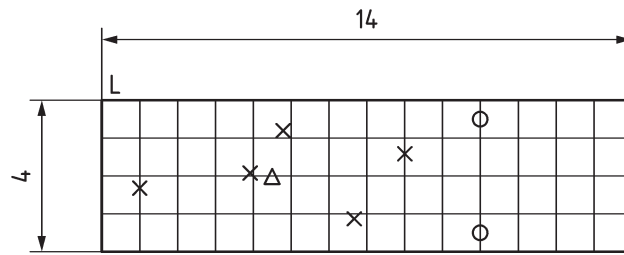
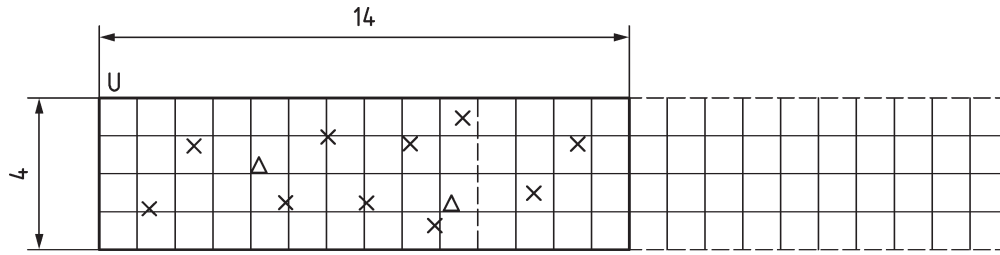

**c) Example 17**

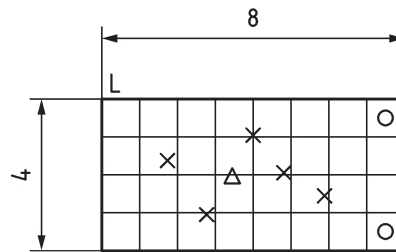
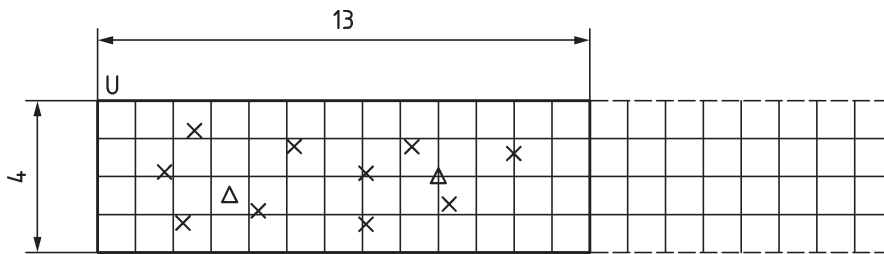

**d) Example 18**

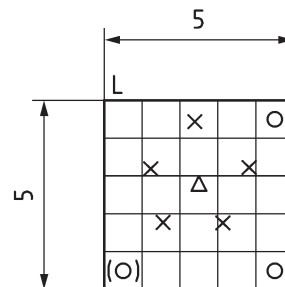
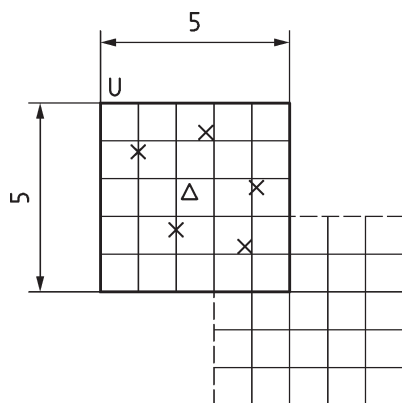

**e) Example 19**

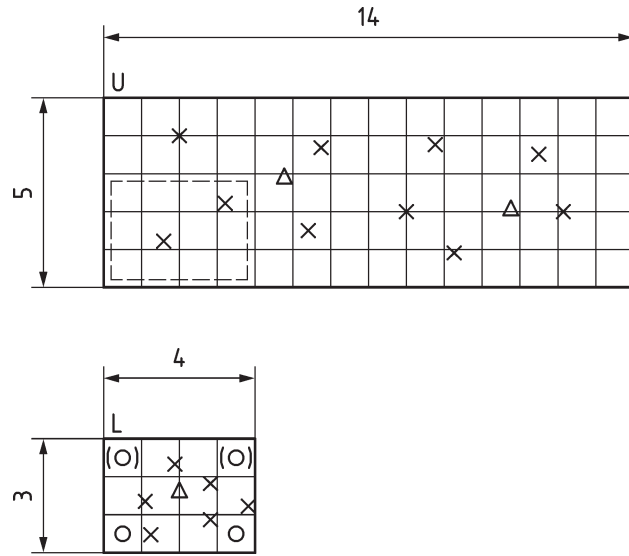

f) Example 20

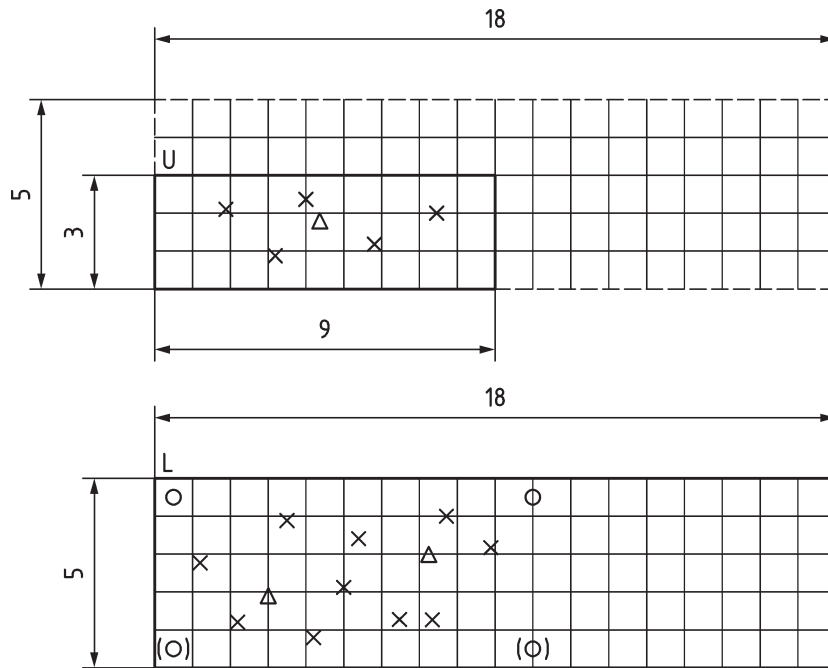

g) Example 21

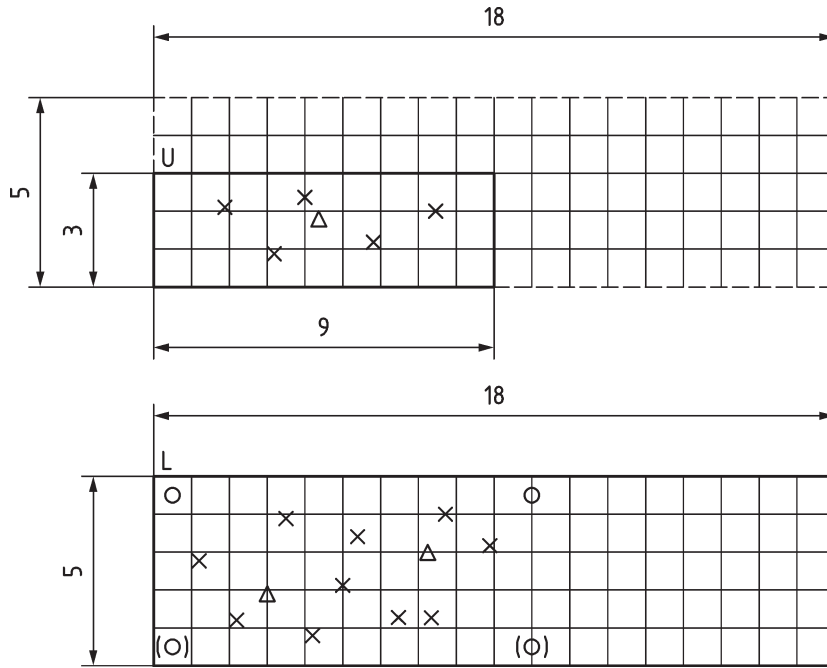

**h) Example 22**

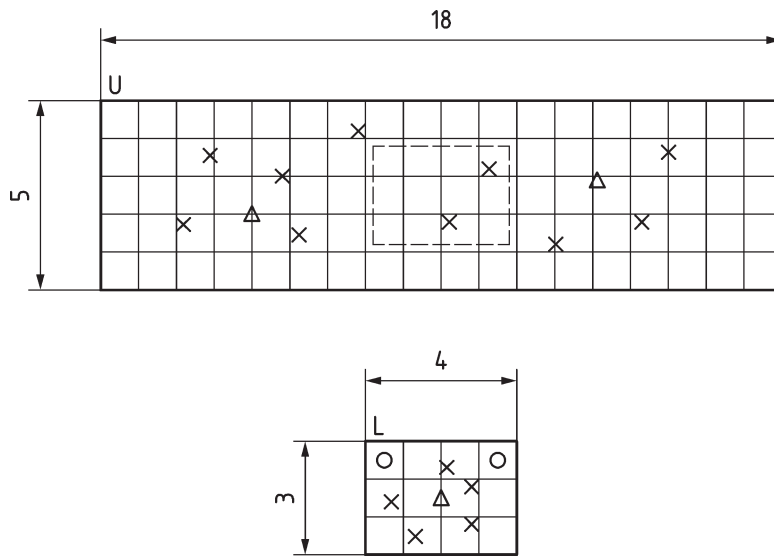

**i) Example 23**



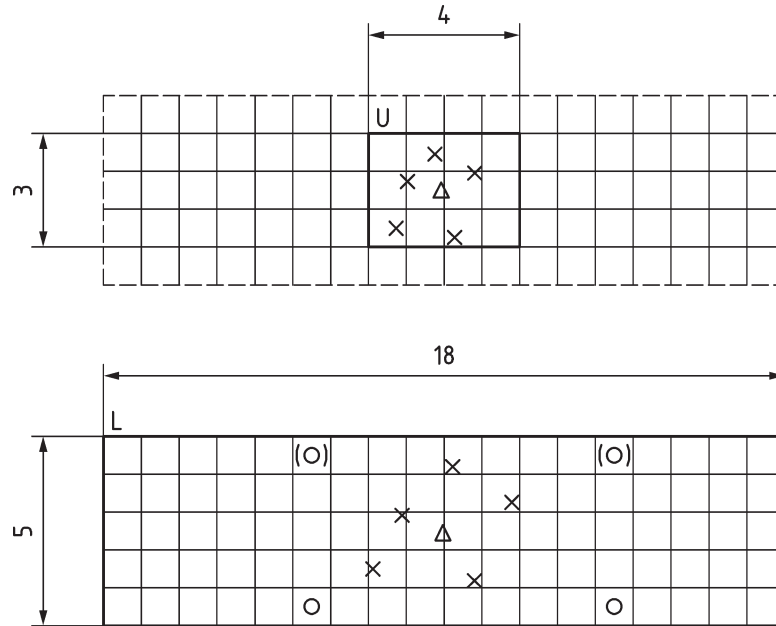

j) Example 24

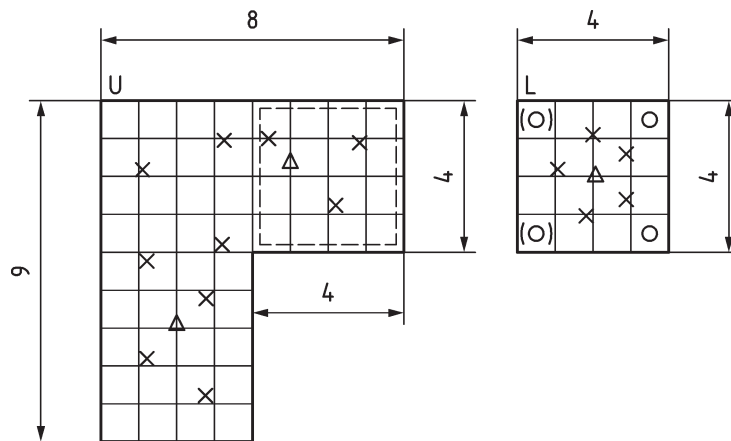

k) Example 25

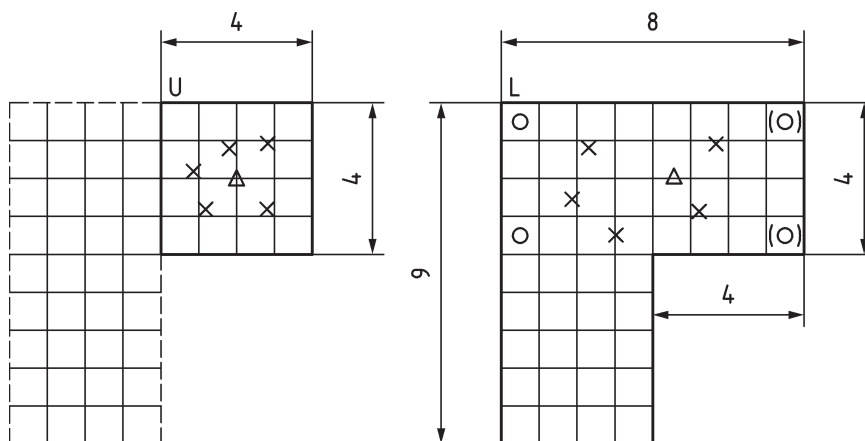

l) Example 26

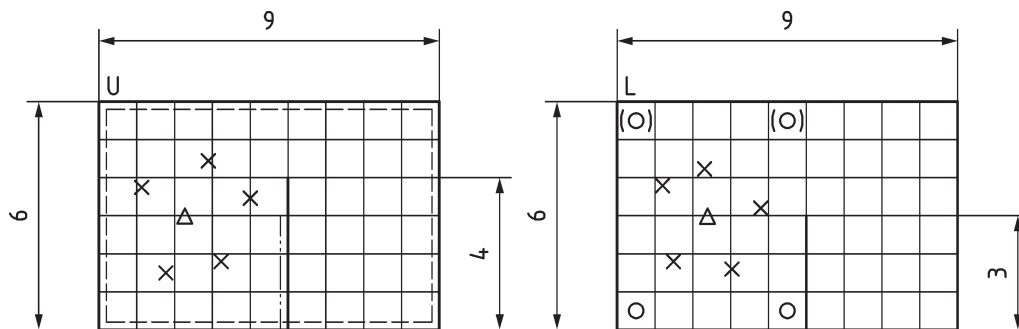

m) Example 27

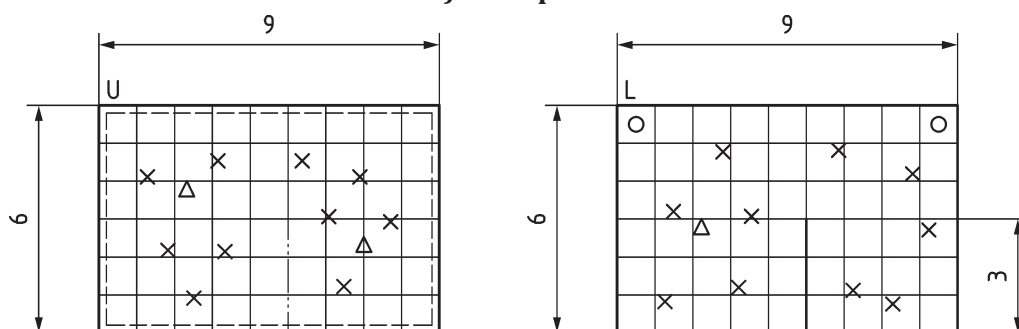

n) Example 28

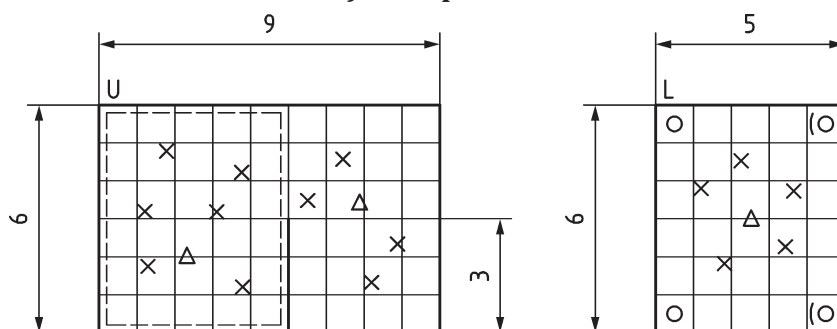

o) Example 29

**Key**

- O loudspeaker
- (O) alternative loudspeaker position
- x fixed microphone position
- Δ fixed point about which a mechanized continuously-moving microphone moves or the position of the operator for a manually-scanned microphone
- U upper room
- L lower room
- room boundaries
- lower room boundaries relative to the upper room
- = common partition
- - - limitation of floor area

**Figure E.1 — Vertical measurements — Scale 1:200, Examples 15 to 29**

## Bibliography

- [1] IEC 61672-2, *Electroacoustics — Sound level meters — Part 2: Pattern evaluation tests*
- [2] IEC 61672-3, *Electroacoustics — Sound level meters — Part 3: Periodic tests*
- [3] OIML Recommendations R 58, *Sound level meters*, 1998<sup>2)</sup>
- [4] OIML Recommendations R 88, *Integrating-averaging sound level meters*, 1998<sup>3)</sup>
- [5] OLESEN H.S. Measurement of the acoustical properties of buildings (additional guidance). Espoo 1992. Nordtest. NT Technical Report 203. NT Project No. 963-91
- [6] SIMMONS C. Measurement of sound pressure levels at low frequencies in rooms. Comparison of available methods and standards with respect to microphone positions. *Acta Acustica united with Acustica*, 1999, **85**, pp. 88-100
- [7] HOPKINS C, & TURNER P Field measurement of airborne sound insulation between rooms with non-diffuse sound fields at low frequencies. *Appl. Acoust.* 2005, **66** pp. 1339–1382
- [8] HOPKINS C On the efficacy of spatial sampling using manual scanning paths to determine the spatial average sound pressure level in rooms. *J. Acoust. Soc. Am.* 2011, **129** (5) pp. 3027–3034
- [9] YOSHIMURA J, ANDOW K., TOGA K. Short time methods for field measurement of sound insulation between rooms. Proceedings of Internoise 96, Liverpool, UK, pp. 2737-2742
- [10] HOPKINS. C. *Sound insulation*. Elsevier/Butterworth-Heinemann, Amsterdam, 2007, 622 p.
- [11] ISO 10052, *Acoustics — Field measurements of airborne and impact sound insulation and of service equipment sound — Survey method*

---

2) Organisation Internationale de Métrologie Légale, 11 rue Turgot, 75009 Paris, France.

3) Organisation Internationale de Métrologie Légale, 11 rue Turgot, 75009 Paris, France.





# British Standards Institution (BSI)

BSI is the national body responsible for preparing British Standards and other standards-related publications, information and services.

BSI is incorporated by Royal Charter. British Standards and other standardization products are published by BSI Standards Limited.

## About us

We bring together business, industry, government, consumers, innovators and others to shape their combined experience and expertise into standards-based solutions.

The knowledge embodied in our standards has been carefully assembled in a dependable format and refined through our open consultation process. Organizations of all sizes and across all sectors choose standards to help them achieve their goals.

## Information on standards

We can provide you with the knowledge that your organization needs to succeed. Find out more about British Standards by visiting our website at [bsigroup.com/standards](http://bsigroup.com/standards) or contacting our Customer Services team or Knowledge Centre.

## Buying standards

You can buy and download PDF versions of BSI publications, including British and adopted European and international standards, through our website at [bsigroup.com/shop](http://bsigroup.com/shop), where hard copies can also be purchased.

If you need international and foreign standards from other Standards Development Organizations, hard copies can be ordered from our Customer Services team.

## Subscriptions

Our range of subscription services are designed to make using standards easier for you. For further information on our subscription products go to [bsigroup.com/subscriptions](http://bsigroup.com/subscriptions).

With **British Standards Online (BSOL)** you'll have instant access to over 55,000 British and adopted European and international standards from your desktop. It's available 24/7 and is refreshed daily so you'll always be up to date.

You can keep in touch with standards developments and receive substantial discounts on the purchase price of standards, both in single copy and subscription format, by becoming a **BSI Subscribing Member**.

**PLUS** is an updating service exclusive to BSI Subscribing Members. You will automatically receive the latest hard copy of your standards when they're revised or replaced.

To find out more about becoming a BSI Subscribing Member and the benefits of membership, please visit [bsigroup.com/shop](http://bsigroup.com/shop).

With a **Multi-User Network Licence (MUNL)** you are able to host standards publications on your intranet. Licences can cover as few or as many users as you wish. With updates supplied as soon as they're available, you can be sure your documentation is current. For further information, email [bsmusales@bsigroup.com](mailto:bsmusales@bsigroup.com).

## Revisions

Our British Standards and other publications are updated by amendment or revision.

We continually improve the quality of our products and services to benefit your business. If you find an inaccuracy or ambiguity within a British Standard or other BSI publication please inform the Knowledge Centre.

## Copyright

All the data, software and documentation set out in all British Standards and other BSI publications are the property of and copyrighted by BSI, or some person or entity that owns copyright in the information used (such as the international standardization bodies) and has formally licensed such information to BSI for commercial publication and use. Except as permitted under the Copyright, Designs and Patents Act 1988 no extract may be reproduced, stored in a retrieval system or transmitted in any form or by any means – electronic, photocopying, recording or otherwise – without prior written permission from BSI. Details and advice can be obtained from the Copyright & Licensing Department.

## Useful Contacts:

### Customer Services

**Tel:** +44 845 086 9001

**Email (orders):** [orders@bsigroup.com](mailto:orders@bsigroup.com)

**Email (enquiries):** [cservices@bsigroup.com](mailto:cservices@bsigroup.com)

### Subscriptions

**Tel:** +44 845 086 9001

**Email:** [subscriptions@bsigroup.com](mailto:subscriptions@bsigroup.com)

### Knowledge Centre

**Tel:** +44 20 8996 7004

**Email:** [knowledgecentre@bsigroup.com](mailto:knowledgecentre@bsigroup.com)

### Copyright & Licensing

**Tel:** +44 20 8996 7070

**Email:** [copyright@bsigroup.com](mailto:copyright@bsigroup.com)

## BSI Group Headquarters

389 Chiswick High Road London W4 4AL UK



...making excellence a habit.™