

BS EN ISO 14825:2011



BSI Standards Publication

Intelligent transport systems — Geographic Data Files (GDF) — GDF5.0 (ISO 14825:2011)

NO COPYING WITHOUT BSI PERMISSION EXCEPT AS PERMITTED BY COPYRIGHT LAW

raising standards worldwide™



National foreword

This British Standard is the UK implementation of EN ISO 14825:2011. It supersedes BS EN ISO 14825:2004 which is withdrawn.

The UK participation in its preparation was entrusted to Technical Committee EPL/278, Road transport informatics.

A list of organizations represented on this committee can be obtained on request to its secretary.

This publication does not purport to include all the necessary provisions of a contract. Users are responsible for its correct application.

© BSI 2011

ISBN 978 0 580 68305 3

ICS 03.220.01; 35.240.70

Compliance with a British Standard cannot confer immunity from legal obligations.

This British Standard was published under the authority of the Standards Policy and Strategy Committee on 30 September 2011.

Amendments issued since publication

Date	Text affected
------	---------------

EUROPEAN STANDARD

EN ISO 14825

NORME EUROPÉENNE

EUROPÄISCHE NORM

July 2011

ICS 03.220.01; 35.240.60

Supersedes EN ISO 14825:2004

English Version

Intelligent transport systems - Geographic Data Files (GDF) - GDF5.0 (ISO 14825:2011)

Systèmes intelligents de transport - Fichiers de données
géographiques (GDF) - GDF5.0 (ISO 14825:2011)

Intelligente Transportsysteme - Geographische Dateien
(GDF) - Gesamtdatenspezifikation (ISO/FDIS 14825:2011)

This European Standard was approved by CEN on 14 July 2011.

CEN members are bound to comply with the CEN/CENELEC Internal Regulations which stipulate the conditions for giving this European Standard the status of a national standard without any alteration. Up-to-date lists and bibliographical references concerning such national standards may be obtained on application to the CEN-CENELEC Management Centre or to any CEN member.

This European Standard exists in three official versions (English, French, German). A version in any other language made by translation under the responsibility of a CEN member into its own language and notified to the CEN-CENELEC Management Centre has the same status as the official versions.

CEN members are the national standards bodies of Austria, Belgium, Bulgaria, Croatia, Cyprus, Czech Republic, Denmark, Estonia, Finland, France, Germany, Greece, Hungary, Iceland, Ireland, Italy, Latvia, Lithuania, Luxembourg, Malta, Netherlands, Norway, Poland, Portugal, Romania, Slovakia, Slovenia, Spain, Sweden, Switzerland and United Kingdom.



EUROPEAN COMMITTEE FOR STANDARDIZATION
COMITÉ EUROPÉEN DE NORMALISATION
EUROPÄISCHES KOMITEE FÜR NORMUNG

Management Centre: Avenue Marnix 17, B-1000 Brussels

Foreword

This document (EN ISO 14825:2011) has been prepared by Technical Committee ISO/TC 204 "Intelligent transport systems" in collaboration with Technical Committee CEN/TC 278 "Road transport and traffic telematics" the secretariat of which is held by NEN.

This European Standard shall be given the status of a national standard, either by publication of an identical text or by endorsement, at the latest by January 2012, and conflicting national standards shall be withdrawn at the latest by January 2012.

Attention is drawn to the possibility that some of the elements of this document may be the subject of patent rights. CEN [and/or CENELEC] shall not be held responsible for identifying any or all such patent rights.

This document supersedes EN ISO 14825:2004.

According to the CEN/CENELEC Internal Regulations, the national standards organizations of the following countries are bound to implement this European Standard: Austria, Belgium, Bulgaria, Croatia, Cyprus, Czech Republic, Denmark, Estonia, Finland, France, Germany, Greece, Hungary, Iceland, Ireland, Italy, Latvia, Lithuania, Luxembourg, Malta, Netherlands, Norway, Poland, Portugal, Romania, Slovakia, Slovenia, Spain, Sweden, Switzerland and the United Kingdom.

Endorsement notice

The text of ISO 14825:2011 has been approved by CEN as a EN ISO 14825:2011 without any modification.

Contents

Page

Foreword	vi
Introduction.....	vii
1 Scope	1
2 Normative references	1
3 Terms and definitions.....	2
3.1 General terms	2
3.2 Mathematical terms	3
3.3 Geodetical terms	4
3.4 GDF terms	6
4 Symbolization and notation elements	9
4.1 GDF symbolizations	9
4.2 UML notation	9
5 Overall conceptual data model.....	15
5.1 Conceptual data models in GDF.....	15
5.2 The general data model of GDF.....	15
5.3 The Attribute model	24
5.4 The Relationship model	27
5.5 Linear referencing.....	27
5.6 The Feature representation scheme	28
5.7 Time modelling.....	28
5.8 Data management: organisation of Feature data into Layers and Sections	29
6 Feature Catalogue.....	33
6.1 Generic specifications.....	33
6.2 Roads and Ferries.....	34
6.3 Administrative Areas	51
6.4 Named Areas	59
6.5 Land Cover And Use.....	63
6.6 Terrain Elevation	93
6.7 Structures	98
6.8 Railways.....	99
6.9 Waterways	100
6.10 Road Furniture	104
6.11 Services	107
6.12 Public Transport.....	108
6.13 Linear Referencing Features	112
6.14 Linear Datum Features	114
6.15 General Features.....	116
7 Attribute Catalogue.....	118
7.1 Generic specifications.....	118
7.2 Attributes	166
8 Relationship Catalogue	314
8.1 Generic Specifications	314
8.2 Relationship Types	342
9 Feature representation rules	387
9.1 Generic specifications.....	387
9.2 Roads and Ferries.....	403
9.3 Administrative Areas	406

9.4	Named Areas	408
9.5	Land Cover And Use	409
9.6	Terrain Elevation	410
9.7	Structures.....	410
9.8	Railways	413
9.9	Waterways.....	414
9.10	Road Furniture.....	415
9.11	Services.....	415
9.12	Public Transport.....	415
9.13	Linear Referencing Features.....	416
9.14	Linear Datum Features	416
9.15	General Features	417
10	Metadata Catalogue	418
10.1	Generic specification	418
10.2	Headers and terminators	420
10.3	Data Dictionary	436
10.4	Table of Contents	448
10.5	Source Material.....	453
10.6	Geodetic Parameters	459
10.7	Update Information	468
10.8	General Comment	468
11	Logical Data Structures	469
11.1	Introduction.....	469
11.2	Logical GDF Album	474
11.3	Datasets.....	476
11.4	Layers	500
11.5	Sections.....	501
11.6	Time Domain Syntax	519
11.7	Update Information	530
11.8	Common Data Types.....	532
12	Media Record Specifications	541
12.1	General specifications	541
12.2	Field specifications	555
12.3	Additional Constraints for Topological Features.....	598
12.4	Additional Constraints for Non-Explicit Topological Features: Order of Coordinate triplets in Feature Records.....	599
12.5	Mandatory Records.....	599
12.6	Record Format Specifications: Global Records	599
12.7	Record Format Specifications: Data Records.....	650
12.8	Record Format Specifications: Update Information Records	684
13	XML schema specifications	687
13.1	Introduction.....	687
13.2	Data content.....	691
13.3	GDF XML schema.....	693
13.4	Schema GDF_Main.xsd.....	694
13.5	Schema GDF_data_dict.xsd	758
13.6	Schema GDF_userDefined.xsd	945
14	SQL encoding specifications	950
14.1	SQL design.....	950
14.2	Data content.....	953
14.3	Topology Type	978
14.4	Data partitioning	980
14.5	General GDF data	1018
14.6	Features.....	1022
14.7	Relationships	1059
14.8	Attributes.....	1063
14.9	Object Referencing	1071

14.10	Update registry	1074
14.11	Abbreviation	1080
14.12	Entity/Table indexes	1081
14.13	Entity Relationship diagram conventions	1086
14.14	SQL/MM base tables for Topology and Network	1095
Annex A (normative) Semantic codes		1099
Annex B (informative) Metadata codes		1127
Annex C (informative) Services		1165
Annex D (normative) Syntax for Time Domains		1173
Annex E (normative) Sectioning GDF Datasets		1195
Annex F (informative) Rules for the formation of Level 2 Features from Roads and Ferries		1198
Annex G (informative) Geopolitical Structure examples.....		1208
Annex H (informative) Specification of possible use of notation and phonetic Attributes for character strings		1226
Bibliography.....		1229

Foreword

ISO (the International Organization for Standardization) is a worldwide federation of national standards bodies (ISO member bodies). The work of preparing International Standards is normally carried out through ISO technical committees. Each member body interested in a subject for which a technical committee has been established has the right to be represented on that committee. International organizations, governmental and non-governmental, in liaison with ISO, also take part in the work. ISO collaborates closely with the International Electrotechnical Commission (IEC) on all matters of electrotechnical standardization.

International Standards are drafted in accordance with the rules given in the ISO/IEC Directives, Part 2.

The main task of technical committees is to prepare International Standards. Draft International Standards adopted by the technical committees are circulated to the member bodies for voting. Publication as an International Standard requires approval by at least 75 % of the member bodies casting a vote.

Attention is drawn to the possibility that some of the elements of this document may be the subject of patent rights. ISO shall not be held responsible for identifying any or all such patent rights.

ISO 14825 was prepared by Technical Committee ISO/TC 204, *Intelligent transport systems*.

This second edition cancels and replaces the first edition (ISO 14825:2004), which has been technically revised.

Introduction

By the late 1980s, producers and users of digital road map data became increasingly aware of the need for a common data interchange standard. Lack of such a standard was seen as an impediment to the commercial growth and success of industries using such data. Before the advent of the Intelligent Transport Systems (ITS) industry, development of spatial data interchange standards was done mostly on a regional basis and not designed for the specialised requirements of road-transport-related applications. The establishment of ISO/TC 204 in 1993 sought to remedy the lack of international standards for ITS. The technical committee is divided into 16 working groups. Working Group 3 (WG 3) was charged with the responsibility of developing standards to promote interchangeability of map data and interoperability of systems using map databases.

The work of WG 3 started in 1994 with a review of the available regional standards documents, including standards developed by the Japan Digital Road Map Association (JDRMA) and developments in the US that resulted in the Spatial Data Transfer Standard (SDTS). European standardization efforts resulted in a standard called GDF3.0 (Geographic Data Files), which eventually was adopted as the basis for internationalized developments, leading to the publication of GDF4.0 in 2004.

In the 1990s, the GDF standard was instrumental in enabling the European business-to-business (B2B) market for in-vehicle navigation in that it provided interoperability for exchanging digital map data between map manufacturers and navigation system integrators. The GDF specifications provided a base for both the capturing of geographic content and the exchanging of it. Its original design foresaw a powerful, application-independent model, while its initial rendition as a standard specifically addressed the requirements for the richness of navigable map databases. Since then, GDF has evolved in terms of boosted data modelling capabilities, broadened international applicability, expanded geographic domains, and diversified exchange formats. As a result, GDF covers a wide range of application domains and has been adapted to many geospatial technologies

The current document presents the specification for GDF5.0, resulting from approximately 30 rounds of meetings held between 2001 and 2008 and involving experts from Australia, Canada, the Czech Republic, France, Germany, Japan, the Republic of Korea, the Netherlands, and the United States of America. Extensive activities towards harmonization with ISO/TC 211 standards were undertaken. Major GDF5.0 enhancements include UML model migration and refinements, harmonization with linear referencing and geospatial web standards, support for 3-D content and time coordinates, comprehensive character set and phonetic representations, and new XML- and SQL-based delivery formats.

The specification of this International Standard is divided into several parts.

After the introductory clauses, the overall conceptual data model is specified. In it, the basic building blocks of GDF and their interrelations are explained. It contains a specification of the different types of topology supported by this International Standard. It furthermore describes how database representations of real world objects, referred to as Features, are defined. It describes the characteristics of Features, called Attributes, and the topological and non-topological interrelations between Features. Finally, it describes the organization of the Features in GDF. Semantically, Features are organized in different Feature Themes. Logically and physically, Features are organized in Sections by area or in Layers by contents.

In the Feature Catalogue, the different Features supported by this International Standard are defined. A special case is the Features from the Services Feature Theme. Because the requirements for this Feature Theme are highly market-oriented, the Services Feature Theme does not contain any normative Features, but contains an annex comprising an informative list of service definitions to assist users of this International Standard (see Annex C).

In the Attribute Catalogue, the different characteristics of Features, called Attributes, are defined. A usage matrix outlines applicability of Attributes per Feature Theme and per Relationship.

In the Relationship Catalogue, the different non-topological (i.e. semantic) Relationships which Features can have are defined. Relationships can relate Features of different Feature Themes, or those from the same or different Section and/or Layer.

In the Feature representation rules, the possible geometrical ways in which the individual Features can be represented are specified for each topology type. This International Standard supports zero-, one- and two-dimensional primitives and up to four-dimensional coordinates.

The specification of Features, Attributes and Relationships by no means dictates mandatory inclusion. The actual contents of GDF, apart from a minimum set of metadata elements as specified in the delivery formats, is not specified by this International Standard since this is considered to be an issue between clients and vendors. This International Standard allows the introduction of user-defined Features, Attributes and Relationships.

In certain cases, different alternative ways of modelling and representation are offered. Representing Features in different geographical areas also may require the use of different basic representation mechanisms such as character sets, projection systems, etc. It is important that all these individual choices associated with GDF are specified. Furthermore, GDF should essentially be self-contained and be readable without any external specification. In order to make this possible, this International Standard specifies ways of describing GDF by means of metadata, captured by the Metadata Catalogue.

Apart from providing a standard for the definition of geographic road databases, this International Standard also specifies mechanisms for data exchange and delivery. In order to facilitate the definition and exchange of data, a logical view of the data organization is important. This logical view is presented in the Logical Data Structures. The data structures are specified using the data description language ESN.

Three physical realisations for data exchange and delivery are specified; the Media Record Specifications (ASCII flat file), the XML schema specifications, and the SQL encoding specifications. These specifications support the explicit registration of updated information, thereby allowing map databases to continue to reflect ground truth over time.

Features, Attributes and Relationships appear in the physical GDF as codes. These codes are specified in Annex A. Codes used in the metadata are given in Annex B, which is an informative part of this International Standard. In order to access the most up-to-date information, the user is referred to the original source organization. Annex C contains the specification of Features of the theme Services as an informative part of this International Standard. In Annex D, the syntax for specifying temporal aspects of geographic information is described. The specific rules for organizing GDF in different spatial subdivisions (Sections) is described in Annex E. As informative parts of this International Standard, guidelines for the formation of Level 2 Features from the Feature Theme Roads and Ferries are given in Annex F. A list of local Administrative Area names in different countries is provided in Annex G, as well as illustrative examples for the description of the (non-hierarchical) geopolitical structures and their components in a number of countries. Finally, the use of notation and phonetic Attributes for character strings are illustrated in the informative Annex H. Annex H provides a range of examples showing how the different notation- and phoneme-related Attribute properties can be used to qualify name strings, in both their written and their pronounced form.

Intelligent transport systems — Geographic Data Files (GDF) — GDF5.0

IMPORTANT — The colours represented in the electronic file of this document can be neither viewed on screen nor printed as true representations. For the purposes of colour matching, see ISO 3864-1 which provides colorimetric and photometric properties together with, as a guideline, references from colour order systems.

1 Scope

This International Standard specifies the conceptual and logical data model and physical encoding formats for geographic databases for Intelligent Transport Systems (ITS) applications and services. It includes a specification of potential contents of such databases (data dictionaries for Features, Attributes and Relationships), a specification of how these contents shall be represented, and of how relevant information about the database itself can be specified (metadata).

The focus of this International Standard is on ITS applications and services and it emphasizes road and road-related information. ITS applications and services, however, also require information in addition to road and road-related information.

EXAMPLE 1 ITS applications and services need information about addressing systems in order to specify locations and/or destinations. Consequently, information about the administrative and postal subdivisions of an area is essential.

EXAMPLE 2 Map display is an important component of ITS applications and services. For proper map display, the inclusion of contextual information such as land and water cover is essential.

EXAMPLE 3 Point-of-Interest (POI) or service information is a key feature of traveller information. It adds value to end-user ITS applications and services.

Typical ITS applications and services targeted by this International Standard are in-vehicle or portable navigation systems, traffic management centres, or services linked with road management systems, including the public transport systems.

The Conceptual Data Model has a broader focus than ITS applications and services. It is application independent, allowing for future harmonization of this International Standard with other geographic database standards.

2 Normative references

The following referenced documents are indispensable for the application of this document. For dated references, only the edition cited applies. For undated references, the latest edition of the referenced document (including any amendments) applies.

ISO 690, *Information and documentation — Guidelines for bibliographic references and citations to information resources*

ISO 3166-1, *Codes for the representation of names of countries and their subdivisions — Part 1: Country codes*. Codes are available at <http://unstats.un.org/unsd/methods/m49/m49alpha.htm>

3 Terms and definitions

For the purposes of this document, the following terms and definitions apply.

3.1 General terms

3.1.1

cartographic primitive

atomic construction element in a cartographic representation, i.e. Node, Edge and Face

3.1.2

data file

collection of related data records having a homogeneous structure

NOTE See Reference [34].

3.1.3

data record

record containing Feature-related data

3.1.4

global record

record that logically precedes the data records and contains control parameters, data definition and documentation necessary to interpret companion data records

NOTE See Reference [25].

3.1.5

Medium Unit

object for data storage that can be considered as a physically undivided whole

EXAMPLE One floppy disk, one magnetic tape, a CD, or a DVD.

3.1.6

multi-media

any kind of data other than conventional data

EXAMPLE Graphic, audio or visual data.

3.1.7

Multi-media Object

piece of multi-media to be processed by an application

EXAMPLE A picture, a text, a movie, or a sound.

3.1.8

repeating Attribute Type

Attribute Type that may have multiple values associated to one and the same instance of a particular Feature Class

3.1.9

Spatial Domain

description of the limits of a geographical area to which a particular set of data belongs spatially

3.1.10

source material

origin of data in analogue or digital representation, stored on any kind of data medium

3.1.11

topology

field of mathematics that deals with characteristics of geometric structures that are preserved after continual variation

NOTE See Reference [43].

3.1.12

transcription

rendering of geographic names from a non-alphabetic script into an alphabetic one or vice versa

NOTE 1 See Reference [40].

NOTE 2 The term is also applied to initial recording in script of hitherto unwritten names.

3.2 Mathematical terms

3.2.1

Area Feature

two-dimensional Feature, defined by one or more Faces

3.2.2

Edge

directed sequence of non-intersecting Line Segments with Nodes at each end

NOTE See Reference [34].

3.2.3

enclave

small part of an area enclosed by another area, seen from the area to which that part belongs

3.2.4

exclave

small part of an area enclosed by another area, seen from the enclosing area

3.2.5

Face

two-dimensional element bounded by a closed sequence of Edges and by zero or more sets of non-intersecting closed sequences of Edges within the first sequence of Edges

NOTE The Face is the atomic two-dimensional element.

3.2.6

graph

set of points and a set of arrows, with each arrow joining one point to another, whereby the points are called Nodes of the graph, and the arrows are called the Edges of the graph

NOTE See Reference [34].

3.2.7

Intermediate Point

point, other than a Node, that defines the shape of an Edge

3.2.8

Line Feature

one-dimensional Feature defined as a sequence of one or more Edges

3.2.9

Node

zero-dimensional element that is a topological junction of two or more Edges, or an end point of an Edge

NOTE See Reference [34].

3.2.10

non-planar graph

graph which cannot be embedded in a plane

3.2.11

planar graph

graph which can be embedded in a plane, meaning that it can be drawn on the plane so that Edges intersect only at a Node mutually incident with them

3.2.12

point

zero-dimensional element that specifies geometric location specified by one coordinate pair or triplet

NOTE See Reference [34].

3.2.13

Line Segment

Segment

direct connection between two Intermediate Points, two Nodes or a Node and an Intermediate Point

3.2.14

valency

degree

number of Edges which are incident with a particular Node

3.3 Geodetical terms

3.3.1

control point

point having known coordinates in the real world and identifiable with a corresponding point in a map or an aerial photograph or satellite image

3.3.2

ellipsoidal height

distance between a point and the reference ellipsoid, measured along the ellipsoidal normal

3.3.3

geodetic datum

mathematical surface that approximates a portion of the earth's surface

3.3.4

geoid

model of the figure of the earth, that coincides with the mean sea level over the oceans and continues in continental areas as an imaginary sea level surface, defined by spirit level

NOTE At every place, geoid level/surface is perpendicular to the pull of gravity. The shape is irregular but can, for most purposes, be approximated by an oblate ellipsoid.

3.3.5

Geoid Undulation

difference between the orthometric height and the ellipsoidal height, measured along the ellipsoid normal

3.3.6
height
elevation

(vertical) distance between a point and the reference height level or the reference ellipsoid

NOTE On land maps, the reference level is commonly the mean sea level.

3.3.7
horizontal reference system
reference system for positions

3.3.8
magnetic declination
angle between Magnetic North and True North

NOTE See Reference [40].

3.3.9
map projection
transformation method used to represent the curved earth surface on a plane

3.3.10
offset
pair of values subtracted from all coordinate values in order to shorten these coordinate values

3.3.11
orthometric height
distance between a point and the geoid, measured along the perpendicular line

3.3.12
reference ellipsoid
oblate ellipsoid of revolution that is used to approximate the figure of the geoid

NOTE It is specified by two parameters: a semi-major axis a (equatorial radius of the earth) and a semi-minor axis b (polar radius). The flattening f is defined as: $f = (a - b)/a$.

3.3.13
reference height level
level to which all terrestrial heights are referred

NOTE It changes from country to country and it forms part of the national coordinate system for surveying and mapping.

3.3.14
reference system
coordinate system on which a national survey is based

NOTE See Reference [40].

3.3.15
vertical reference system
reference system for elevations

3.3.16
world geodetic system
WGS
set of standard reference ellipsoids that define latitude, longitude and height for every point on the earth

3.4 GDF terms

NOTE All Feature Classes mentioned below are defined in the Feature Catalogue.

3.4.1

Album

collection of related Datasets (logical sub-division) and, if applicable, Volumes (physical sub-division)

3.4.2

Attribute

characteristic of a Feature which is independent of other Features

NOTE See Reference [34].

3.4.3

Attribute Code

alphanumeric identifier for an Attribute Type

NOTE See Reference [57].

3.4.4

Attribute Name

name associated to an Attribute Type

NOTE See Reference [57].

3.4.5

Attribute Type

defined characteristic of a Feature, which is independent of the other Features

3.4.6

Attribute Value

specific quality or quantity assigned to an Attribute

NOTE See Reference [34].

3.4.7

Dataset

sub-division of Album, which in turn can be sub-divided into Sections

NOTE A large set of data covering a particular geographic area can be considered a Dataset.

3.4.8

District

area regarded as a geographical unit, which is defined by the delivery of a specific public or private sector service

3.4.9

Feature

database representation of a real world object

3.4.10

Feature Category

type of representation of a Feature, including Point, Line, Area and Complex Feature

3.4.11

Feature Class

categorization of a Feature

3.4.12

Feature Class Code

alphanumeric identifier for a Feature Class

NOTE See Reference [57].

3.4.13

Feature Name

name associated with a Feature Class

NOTE See Reference [34].

3.4.14

Feature Theme

specified group of related Features

3.4.15

field

set of characters representing one unit of data

3.4.16

Layer

certain subset of a Dataset based upon information contents

3.4.17

Manoeuvre

ordered sequence of a Road Element, a Junction and one or more Road Elements, and optionally associated with a Traffic Sign

3.4.18

Place

administrative area of the types: Order-i Area, Country, Supra-National Area, Administrative Place A-Z or Named Area Feature of the types: Built-up Area, Named Area, District

3.4.19

Property

combination of Attribute and Relationship values which pertain to a Feature and which together define a certain characteristic of the Feature

3.4.20

Relationship Code

alphanumerical identifier for a Relationship

3.4.21

Relationship name

name associated with a Relationship Type

NOTE See Reference [34].

3.4.22

Relationship Type

defined characteristic of a Feature which is dependent on other Features

3.4.23

Semantic Relationship

Relationship

characteristic of a Feature involving other Features

3.4.24

Section

spatial subset of a Dataset

NOTE The coverage area of a map sheet, confined by geographic coordinates, can be considered a Section.

3.4.25

Transportation Element

Road Element, Pathway, Railway Element, Path, Ferry Connection, Water Body, Water Boundary Element, Junction, Railway Element Junction or Water Boundary Junction

3.4.26

turn

ordered sequence of a Road Element, a Junction and a Road Element

NOTE A turn is a special case of a Manoeuvre, relating exactly two Road Elements.

3.4.27

Volume

smallest physical unit of a medium

NOTE A single Volume can contain one or more GDF Datasets depending on Dataset size.

EXAMPLE A magnetic tape, a floppy disk, etc.

4 Symbolization and notation elements

4.1 GDF symbolizations

Many of the basic concepts of GDF are best expressed diagrammatically in data models. The Unified Modeling Language (UML) [31] has been adopted as the conceptual modeling language for GDF.

4.2 UML notation

4.2.1 Introduction

This subclause provides a summary of the UML Class Diagram notation conventions used in this International Standard. It is consistent with the use of UML in the ISO 191xx series of geographic information standards of ISO/TC 211 (see [27], ISO 19107:2003, 5.1, Presentation and notation).

4.2.2 UML classes

4.2.2.1 General

A UML class is a description of a set of objects (instances) that share the same attributes, operations, relationships¹, and semantics. A class is represented in a UML Class Diagram as in Figure 1.

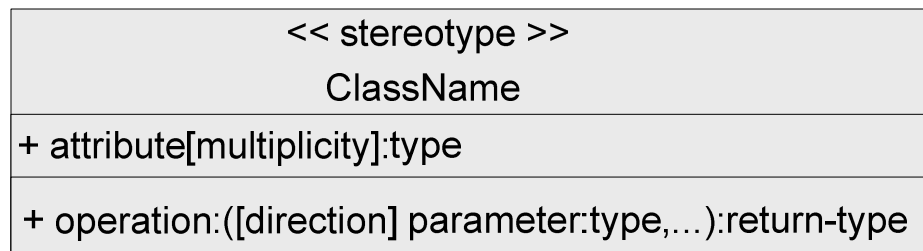

Figure 1 — Class with attributes and operations

The rectangular box representing a class has three parts: class, attributes, and operations. The full class content is usually only presented in one figure. If the class is repeated on another figure, attributes and operations are not shown and the box is a single rectangle containing only the class name and stereotype as in Figure 2:

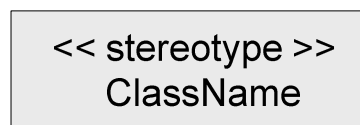

Figure 2 — Class with attributes and operations suppressed

4.2.2.2 Class name and stereotype

The mandatory top part of the class rectangle contains the name of the class in UpperCamelCase. If the class is abstract (it cannot have any instances), then the name is shown in *italics*.

¹ GDF has its own definition of relationship. Here, the UML definition is used. It includes both associations and generalizations between classes. Associations can be ordinary, aggregate, or composite.

Stereotype can take any of the following values:

Feature: (consistent with ISO 191xx) – classes that have identifiers can have geospatial location; primary features in mapping; corresponds to GDF Feature classes.

Enumeration: (consistent with ISO 191xx) – class provides a fixed list of alternative values.

CodeList: (consistent with ISO 191xx) – similar to an enumeration, in that one of a number of values is possible, but differs in intent, in that a code list may be expanded over time.

Data Type: (consistent with ISO 191xx) – have no identity of their own; can be associated with other classes but are not enumerations or code lists.

Union: (consistent with ISO 191xx) – a type consisting of one and only one of several alternatives (listed as member attributes) representing a discriminating union of these alternatives.

Relationship: (special for GDF) – have identifiers; correspond to the Relationships between Features or Attributes.

Attribute: (special for GDF) – correspond to GDF Composite Attributes.

Association: (special for GDF) – used to identify an Association Class (consistent with ISO 191xx) which adds attributes to an association which exists between two classes.

4.2.2.3 UML class attributes

The middle part of the rectangular box representing a class optionally contains a set of attributes (properties) for the class. Each attribute is specified by the following:

“attribute” is the name of an attribute² of the class in lowerCamelCase. It is prefixed by a visibility indicator with a value of public (+), private (-) or protected (#), indicating the visibility of this attribute from outside the objects in this class. Most attributes in GDF have public visibility.

“[multiplicity]” indicates the number of values that this attribute can have for any instance of the class, assumed to be organized as a set unless otherwise specified. Multiplicity is specified as a range with a format of “begin-value..end-value”. Begin-value is any positive integer or zero. End-value is an integer greater than begin-value. If only a begin-value is specified, then exactly that number of values must exist for this attribute. For example, a multiplicity of ‘1’ specifies that the attribute must have a single value for each instance of the class. A multiplicity of ‘0..1’ specifies that the attribute is optional, but if it exists, it has a single value for that instance of the class. A multiplicity of ‘0..*’ specifies that the attribute is also optional, but if it exists, it can have one or more values for that instance of the class. A multiplicity of ‘1..*’ specifies that the attribute is mandatory, and it must have one or more values for each instance of the class. The absence of [multiplicity] is the same as a multiplicity equal to ‘1’, i.e., exactly one value must exist for this attribute for each instance of the class.

“type” is the type of the attribute in UpperCamelCase. It may be either a value type, such as Number, or the name of a class.

NOTE Specific to GDF, a type of “PositiveInteger” has been introduced for object IDs, including those for Feature, Relationship, Attribute, Node, Face, Edge, Album, Dataset, Layer, and Section. It is defined to be an Integer with attribute >0 = True.

² GDF Simple Attributes are shown in this manner. GDF composite attributes are modeled as a separate class.

4.2.2.4 Class operations

The lower part of the rectangular box representing a class contains an optional set of operations³ for the class. Each operation shall have a list of zero or more parameters. An operation is specified by the following:

“operation” is the name of an operation of the class. It is prefixed by a visibility indicator with a value of public (+), private (-) or protected (#), indicating the visibility of this operation from outside the objects in this class.

“[direction]” is the optional indicator of direction flow for a parameter being either “in” (the value is set before invocation and affects the operation), “out” (the value is set during the operation and its value is accessible by the invoker upon completion of the operation), or “inout” (the value is set before the invocation, affects the operations, and is reset by the operation to a value accessible by the invoker upon completion of the operation). The default direction of any parameter is “in”.

“parameter” specifies the name of the parameter.

“type” is the type of the parameter. It may be either a value type, such as integer, or the name of a class.

“return-type” is the type of the return value or object for the operation. It may be either a value type, such as integer, or the name of a class.

4.2.3 UML class relationships

4.2.3.1 Generalization/specialization relationship

Classes can be “subclassed” into more specific classes. Figure 3 specifies a subclass relationship in a Class Diagram. Classes Type1A and Type1B are subclasses of Type1. As such, they inherit all of the methods, operations, relationships, and semantics of Type1 and instances of classes Type1A and Type1B can be substituted for a Type1 instance wherever a Type1 instance is specified. They typically extend Type1 with additional attributes and/or additional or overriding operations. Only these additional attributes and/or operations will appear in the subclass boxes.

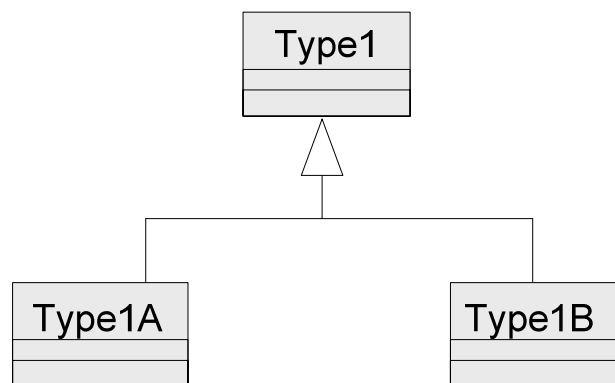

Figure 3 — Subclass hierarchy

³ Operations are not specified in this version of GDF.

4.2.3.2 Other class relationships: associations

4.2.3.2.1 General

In addition to the subclass relationship, Classes may be associated with other classes.

4.2.3.2.2 Regular associations

Associations are represented in a UML Class Diagram using the syntax shown in Figure 4.

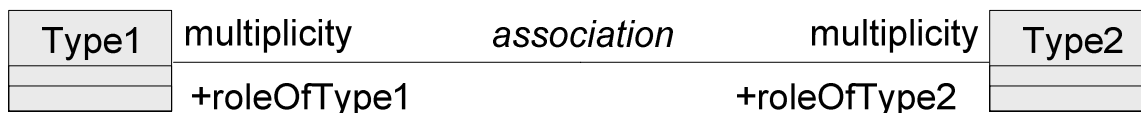

Figure 4 — Class associations

The association link between the two classes may be adorned with the following information:

“*association*” is the name of the association between the two classes. Association names are rarely included; their use is suggested in order to differentiate multiple associations between the same two classes.

“*role*” is the name of the role, in lowerCamelCase, which the class nearest the adornment plays in the association. It is prefixed by a visibility indicator with a value of public (+), private (-) or protected (#), indicating the visibility of this role from outside the objects in this class. Most roles in GDF have public visibility. The role can be interpreted as follows: *roleOfType2* can be read as a property of Type1 whose value is the instance of Type2. Consequently, if Type1 is involved in multiple associations, the *roleOfType2* role names must be different.

“*multiplicity*” indicates the number of instances of the class nearest the adornment that can participate in each instance of the association. Multiplicity is specified as a range with a format of “begin-value..end-value”. Begin-value is any positive integer or zero. End-value is an integer greater than begin-value. If only a begin-value is specified, then exactly that number of instances of the class must exist for this association. For example, a multiplicity of ‘1’ at the Type1 side of the association specifies that every instance of Type2 must have this association with one and only one instance of Type1. A multiplicity of ‘0..1’ specifies that every instance of Type2 must have this association with zero or one instances of Type1. A multiplicity of ‘0..*’ specifies that every instance of Type2 must have this association with zero or more instances of Type1. A multiplicity of ‘1..*’ specifies that every instance of Type2 must have this association with one or more instances of Type1.

An arrowhead on one side of the association line indicates that navigation is only required in the direction of the arrowhead. For example, an arrowhead on the Type2 side in Figure 4 would indicate that, given an instance of Type1, it is possible to obtain all of the associated instances of Type2. No arrowhead means, e.g., “backward pointers”, are required to get all Type1 instances associated with each Type2 instance. If a role is shown on the Type1 side of the association and an implementation chooses to include navigation in the optional direction, then that implementation shall use the role name shown. If no arrowheads appear, then the association is assumed to be navigable in both directions.

4.2.3.2.3 Aggregation/composition associations

If each instance of Type2 is made up of instances of Type2A or Type2B, an aggregation or composition association is represented in the Class Diagram as in Figure 5 by adding a diamond to the “container” side of the association line. An open diamond specifies an aggregation: an instance of Type1 is comprised of

instances of Type2A but the instances of Type2A can exist in their own right. A shaded diamond indicates the stronger, composition association: instances of Type2B are dependent on the existence of an instance of Type2. Type2B instances cannot be created unless they are associated with a Type2 instance. If the Type2 instance is deleted, the associated instances of Type2B are also deleted.

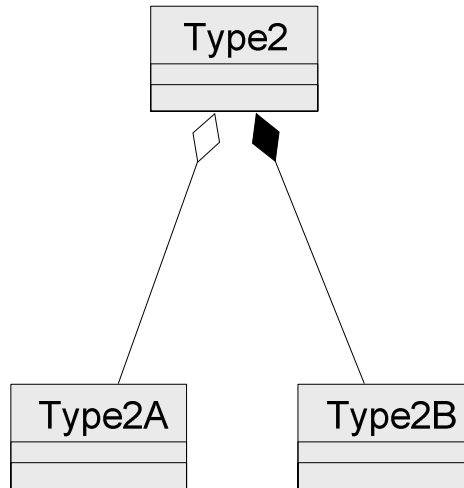

Figure 5 — Aggregation/composition associations

4.2.3.2.4 Association class

In order to specify attributes about the association between two classes, an Association Class is used. The attributes of this class are the attributes of the association. Association Classes are represented in a UML Class Diagram using the syntax shown in Figure 6.

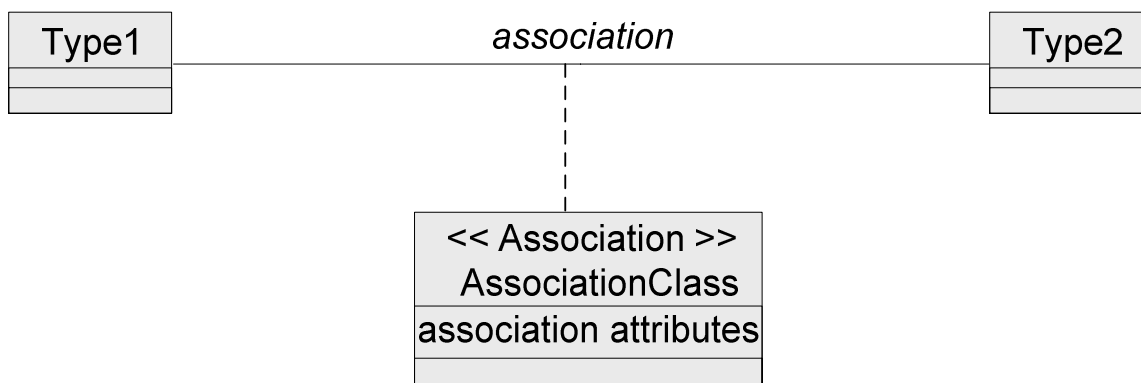

Figure 6 — Association Class

4.2.3.2.5 Qualified association

A special case of association attribute is a qualifier. The qualifier qualifies the association. An instance of the source class in the association plus a qualifier value maps to a specific instance of the target class in the association. An example of how a qualified association is represented in a UML Class Diagram is shown in Figure 7.

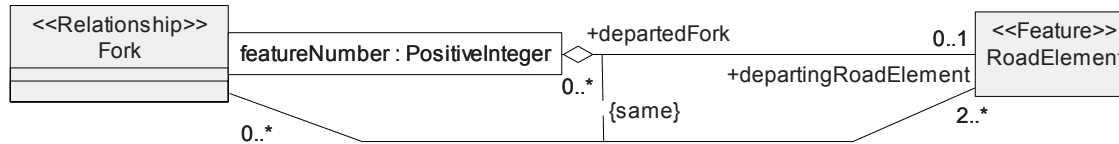

Figure 7 — Qualified association example

Fork is the source class of the departing association; RoadElement is the target class. For a specific instance of a Fork, the departing Road Element instances are distinguished by the positive integer, featureNumber qualifier. The aggregation association is adorned with a rectangular box on the source end containing the association attribute(s) which help qualify the association.

The cardinality on the source side is 0..* since any Road Element instance may be associated with any number of fork instances by playing the role of departing Road Element in the qualified association. The cardinality on the target side is 0..1 because for each combination of a fork instance and a positive integer, there is either none or one Road Element playing the role of departing Road Element.

In the figure, the second (unqualified) association specifies that in total, there are 2..* departing Road Element instances for each fork instance. Since this unqualified association is in reality the same association as the qualified one, the “same” constraint links the two. The (same) applicable role names are not repeated for the second association.

4.2.4 Constraints

When additional restrictions are mandated on the syntax or semantics, a Class Diagram can be further adorned with constraints. These are supplied as text inside of {curly braces}. There is no prescribed syntax for the constraint text. An example from GDF is {ordered}, which specifies that the set of supplied values must be in a specific order. Another example is the exclusivity constraint in the Fork Relationship:

{notEqual(approachingRoadElement,departingRoadElements)},

which states that the approaching Road Element and all of the departing Road Elements must be different Road Elements.

Constraints which adorn an association at either end are typically part of the UML model. Constraints which appear in an annotation text box are typically only part of the figure in which they appear.

5 Overall conceptual data model

5.1 Conceptual data models in GDF

The general data model of GDF is presented in Figure 8 and Figure 9, Figure 11 through Figure 15, and Figure 17 through Figure 25. See Figure 1 through Figure 7 for the UML notation used. Detailed sub-schemas are presented in the respective clauses. The data model diagrams convey a range of dedicated terms describing concepts of the GDF model; according to UML practise, these terms are spelled using "CamelCase" notation. Textual descriptions complementing the graphical descriptions use initial capitals for each constituent word of a given GDF term.

The general data model—serving as meta-model for the respective semantic models of the individual Feature classes (see Feature Catalogue), of the individual Attribute types (see Attribute Catalogue), and of the individual Relationship Types (see Relationship Catalogue)—are presented and explained in detail in the remainder of this clause. Each Feature class, Attribute type, and Relationship Type can be considered an instance of the generic UML classes for Feature class, Attribute type, and Relationship Type, respectively, in the meta-model. This two-level notion is implemented using UML class sub-typing.

While ID's are usually not part of a conceptual model, it has been decided to explicitly include them here due to their conceptual relevance. This refers to the fact that they provide a means of unique identification of elements regardless of a particular physical realization of the GDF conceptual model. This, despite the fact that certain physical realizations may not require the use of physical ID's. Consequently transition between different physical realizations will not result in loss of information.

5.2 The general data model of GDF

5.2.1 The Feature model

In the centre of the model in Figure 8 resides the "Feature" which is a database representation of a real world geographic object. Examples of real world geographic objects are roads or buildings. Note that in this diagram "Feature" has the meaning of Feature instance, i.e. an individual occurrence of a geographic object, such as the Eiffel Tower in Paris.

Figure 8 shows that each Feature must belong to exactly one Feature Class and exactly one Feature Theme. The diagram also shows that Feature Classes and Feature Themes are uniquely referenced by a name and a code.

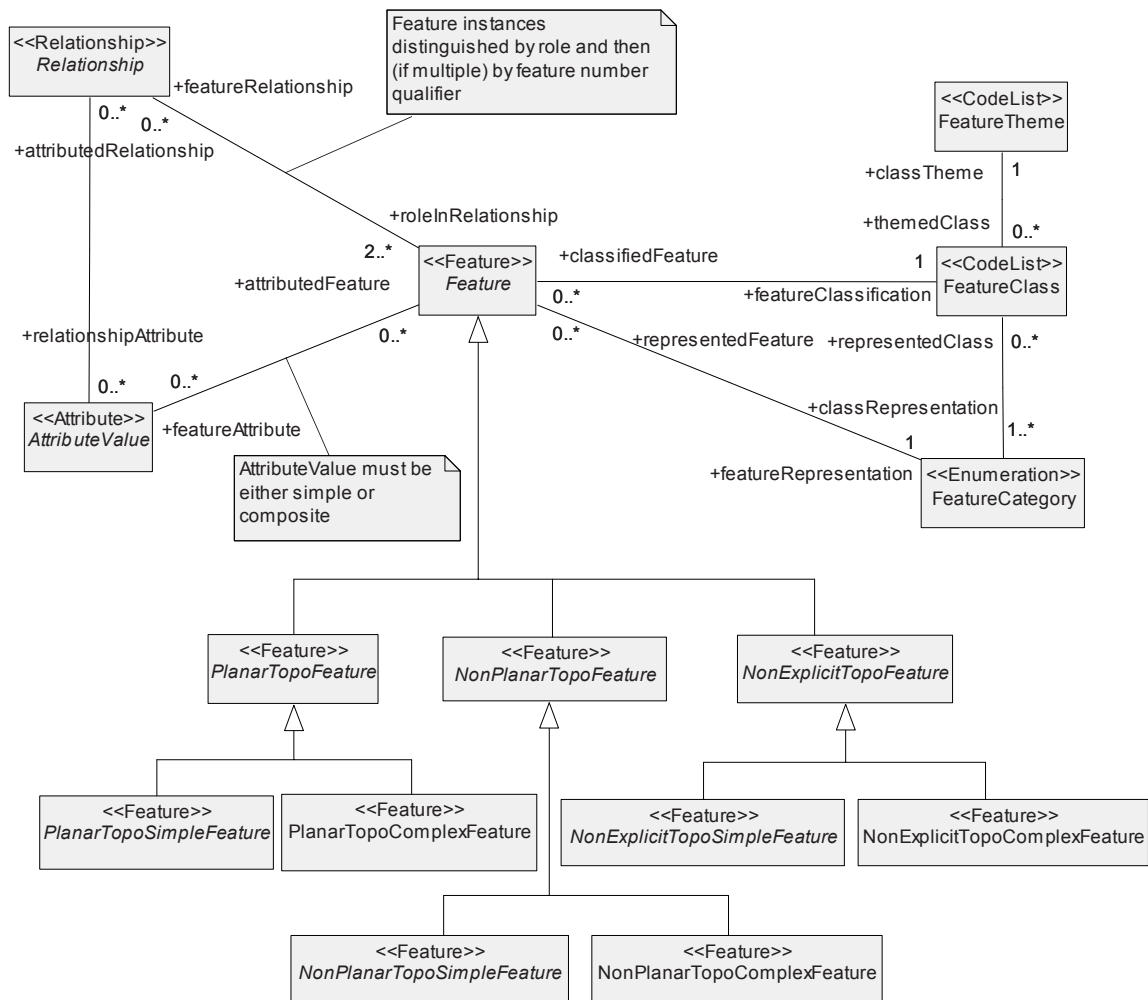

Figure 8 — The overall Conceptual Data Model

Each Feature belongs to exactly one Feature Class. This constraint is indicated in diagram 2a by the depiction of Feature Class with a multiplicity of 1 in the association between classes Feature and Feature Class. Thus neither classless Features (Features belonging to no Feature Class) nor hybrid Features (Features belonging to multiple Feature Classes) are allowed in a GDF.

A Feature may have zero or more Attributes. Attributes serve to represent characteristics of a Feature that are independent of other Features.

A Relationship is used to associate two or more Features together. However a Feature is not required to participate in a Relationship. A Relationship may have zero or more Attributes.

Each Feature is of exactly one Feature Category. A Feature Category is uniquely referenced by a Name and a Code. GDF defines four Feature Categories – Point, Line, Area and Complex. Collectively, Point, Line, and Area Features are referred to as Simple Features. Complex Features are aggregations of other Features, either Simple, Complex or in combination.

5.2.2 Graph topology

The first subdivision of Features relates to the topology of the underlying graph with which the Features are defined. The GDF supports three different types of graph topologies: Planar topology, Non-planar topology and Non-explicit topology:

- Non-explicit topology: No topological relations between objects are explicitly defined. That is, topological relations are only defined via coordinate values.
- Non-planar topology: Topological relations are explicitly defined; objects may fully or partially coincide, or intersect or overlap each other.
- Planar topology: Topological relations are explicitly defined; objects must not fully or partially coincide, and must not intersect or overlap each other. Intersecting objects or overlapping objects are broken-up into object fragments, whereby common parts (such as a street co-inciding with a boundary) are present only once.

In exceptional cases the standard also supports the explicit definition of topology on the Feature level⁴.

Non-explicit topology gives the possibility to define and process data, for which topological relations are less relevant (e.g. map display data) in a very efficient way. Non-planar topology gives the possibility to perform network operations efficiently. Planar topology gives also the possibility to efficiently integrate area information in network operations.

In the GDF model, the rendering method chosen for planar topology is the full integration method, and for non-planar topology the connectivity method. Both methods are further described below.

Obviously since planar topology is a special case of non-planar topology it is quite possible to have utilized the "connectivity" approach to render the planar topology case. However, it is even conceivable (although less likely) to make use of the full integration method to render non-planar topology. It is important not to confuse the rendering choice with the topology choice.

In planar topology, the zero- and one-dimensional basic building blocks, Nodes and Edges, form a graph. In special cases where in reality two Point Features are located above each other, a single Node is being defined (possibly connected by a vertical Edge (of "length" zero) representing a Line Feature, e.g. an elevator between different building levels). Furthermore, in the GDF model of topological planarity, a fully topologically integrated representation is provided for Area Features. Area Features are defined by referencing the two-dimensional building blocks, Faces, which make up that Area Feature (Figure 9).

⁴ The standard allows the following additional explicit definitions of topology:

- The start and end Point Feature of a Line Feature
- The start and end Complex Feature of a Complex Feature.
- Through the use of Relationships (See below: The Relationship Model).

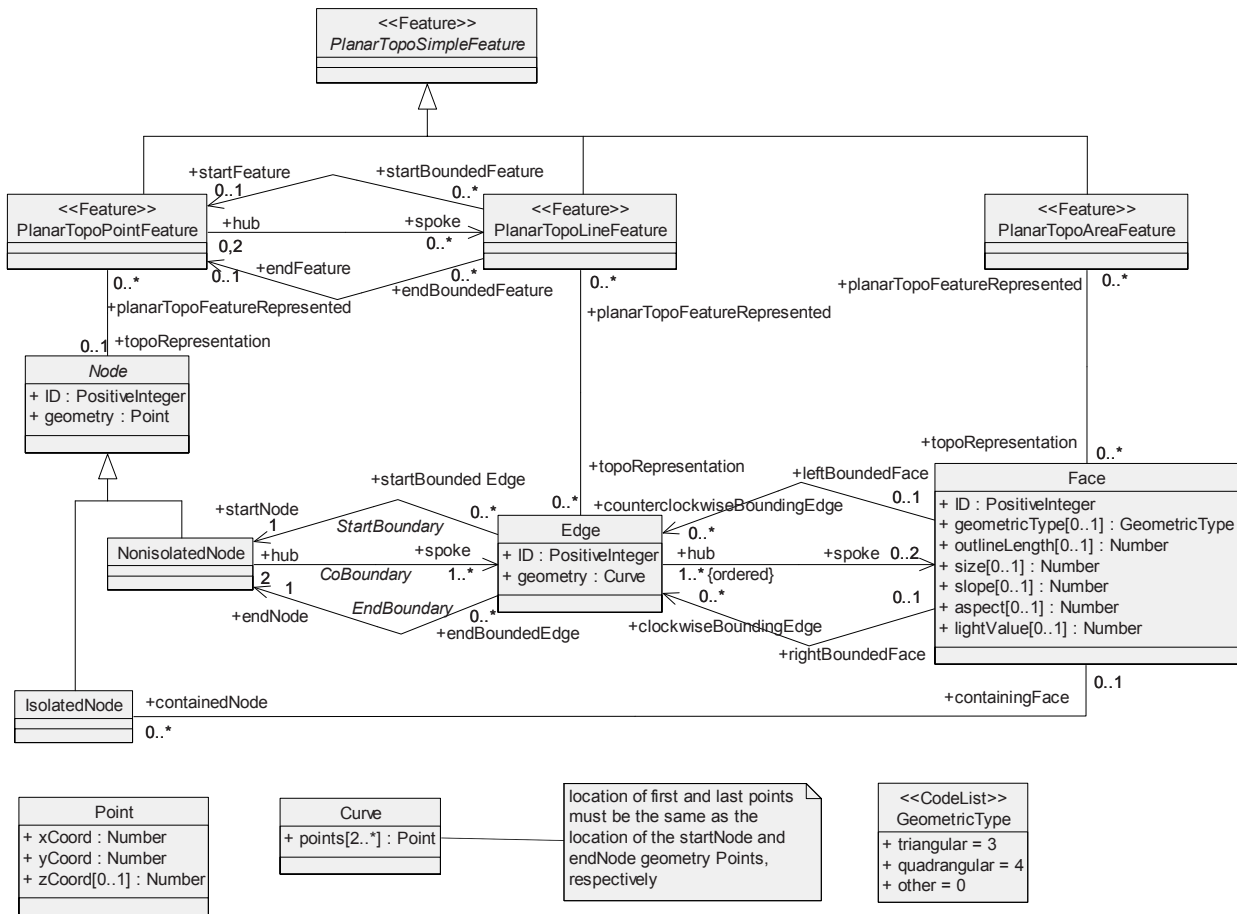

Figure 9 — The conceptual data model of Planar Topological Simple Features

Here, an Area Feature must have at least one Face and a Face at least one Edge. This constraint is depicted in Figure 9 by the hub and spoke association between Face and Edge. The relation between a Face and its composing Edges is determined by the location of the Face relative to the Edge (left or right) relative to the direction of an Edge or, when approached from the Face, by the orientation of the Edge (clockwise or counter clockwise) when seen from the inside or the outside of the Face. This means that an Edge which bounds two Faces will have a clockwise orientation in the definition of one Face and a counter-clockwise orientation in the definition of the other Face (See Figure 10).

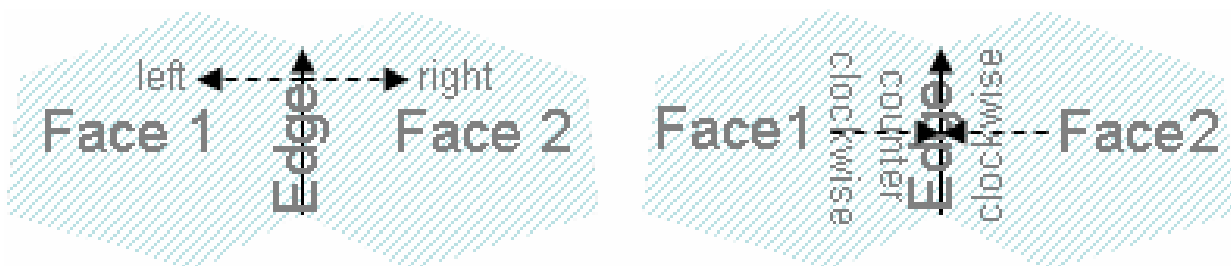

Figure 10 — Relation between Faces and bounding Edges

In non planar topology the Nodes and Edges together form a non-planar graph. That is, where in reality two Line Features cross at different levels (e.g. two roads crossing via a bridge), the Edges which represent these Line Features cross without forming a Node on the point of crossing. Also, in special cases where in reality

In the remainder of this chapter, the planar topology and the non-planar topology will be both referred to as “topology” and the corresponding Features as topological Features, while the non-explicit topological way will be referred to as the non-explicit topology or NET way and its corresponding Features as “non-explicit topological or NET Features”.

In topology, Features are defined by the basic building blocks Nodes, Edges and Faces. Figure 9 and Figure 11 show that a topological Point Feature is always represented by exactly one Node, a topological Line Feature by one or more Edges and a topological Area Feature either by one or more Faces or by one or more Edges forming one or more closed boundaries. The lowest part of each Figure illustrates how the basic building blocks Node, Edge and Face (Face in planar topology only) are mutually related in each of the supported topologies. Within the conceptual model Nodes can be broken down into two types. Isolated Nodes are Nodes which do not coincide with other geometry. Otherwise a Node is considered a non-isolated Node which means it is connected to one or more Edges.

In non-explicit topology, Features are defined by the basic building blocks Dots, Polylines and Polygons. Figure 12 shows that a NET Point Feature is always represented by exactly one Dot, a NET Line Feature by exactly one Polyline and a NET Area Feature by exactly one Polygon. As can be seen, no relations are defined between these basic building blocks, thus signifying their non-explicit topological nature. An important distinction here is that in contrast with topology there is no reuse within the building blocks--neither a Polyline reuses (references) Dots, nor a Polygon reuses Polylines. Thus shared geometry never occurs and overlapping Features need to have their building blocks replicated. In non-explicit topology reuse can occur in the definition of Complex Features.

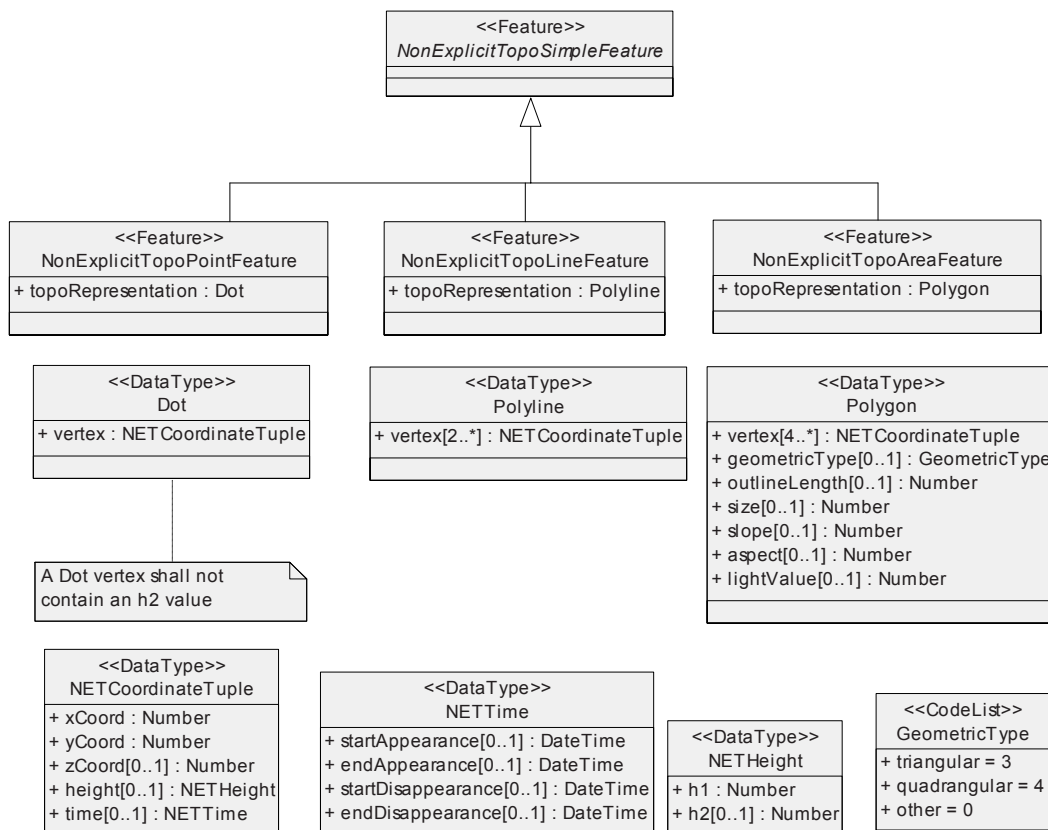

Figure 12 — The conceptual data model of NET Simple Features

It is not allowed to mix the use of topologies, i.e. a GDF Layer can only contain data from one type of topology (See Figure 21 and Figure 22).

One should note that the multiplicity of classes representing the basic geometric building blocks (Nodes, Edges and Faces) in the associations with the classes representing Features with the different Feature Categories (Point, Line and Area) in planar and non-planar topology have zero as begin value.. This indicates that geometry-less Features are allowed. I.e. the standard allows the definition of Features for which the geometry is not defined.

“multiplicity” indicates the number of instances of the class nearest the adornment that can participate in each instance of the association. Multiplicity is specified as a range with a format of “begin-value..end-value”. Begin-value is any positive integer. End-value is an integer greater than begin-value. If only a begin-value is specified, then exactly that number of instances of the class must exist for this association. For example, a multiplicity of ‘1’ at the Type1 side of the association specifies that every instance of Type2 must have this association with one and only one instance of Type1. A multiplicity of ‘0..1’ specifies that every instance of Type2 must have this association with zero or one instances of Type1. A multiplicity of ‘0..*’ specifies that every instance of Type2 must have this association with zero or more instances of Type1. A multiplicity of ‘1..*’ specifies that every instance of Type2 must have this association with one or more instances of Type1.

5.2.3 Levels in GDF

The different objects together making up a GDF are conceptually divided over three different levels, Level-0, Level-1 and Level-2. The topological primitive building blocks, Node, Edge, and Face, reside on Level-0. The Simple Features, as referred to in the previous paragraph and in the data models there together make up Level-1. Simple Features can form aggregated Features which are called Complex Features. Complex Features comprise Level-2. Figure 13, Figure 14 and Figure 15 give the data model of Complex Features for the three different types of topologies. As can be seen in these figures, Complex Features can only consist of Features defined with the same topology.

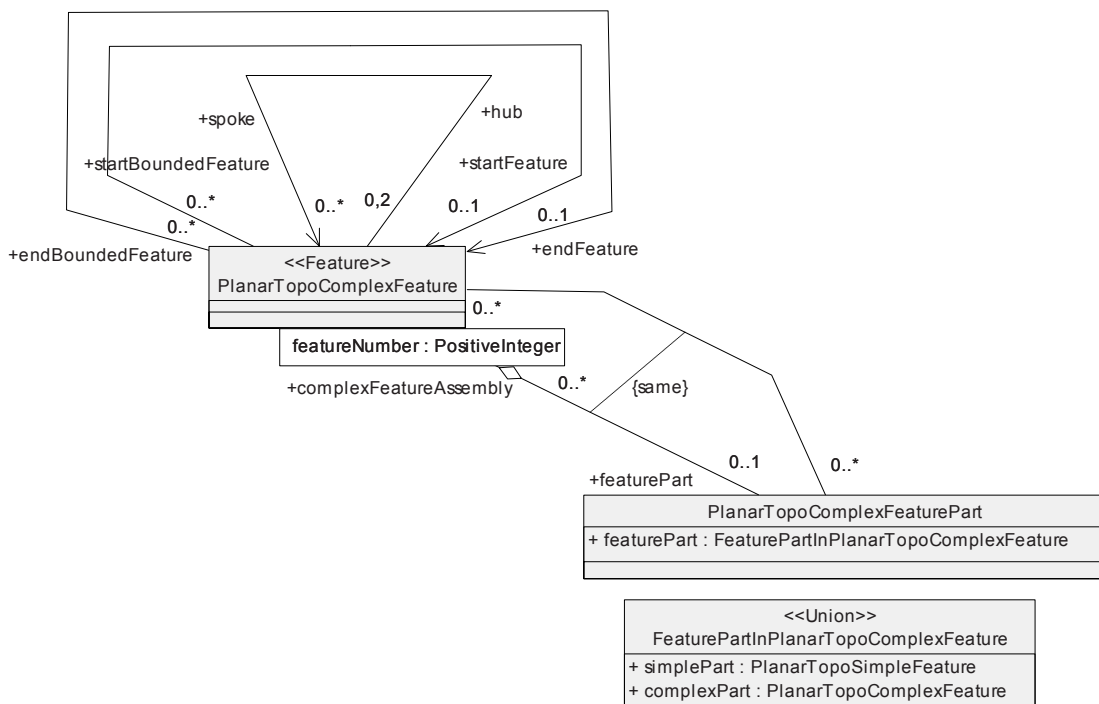

Figure 13 — The conceptual data model of Planar Topology Complex Features

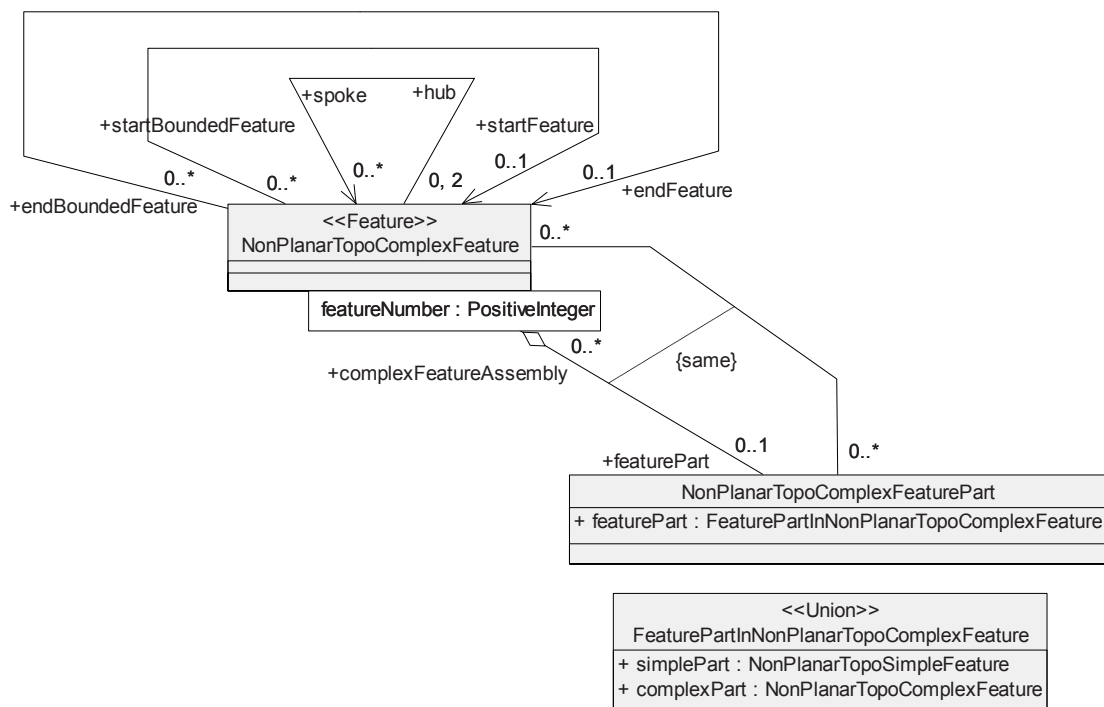

Figure 14 — The conceptual data model of Non-planar Topology Complex Features

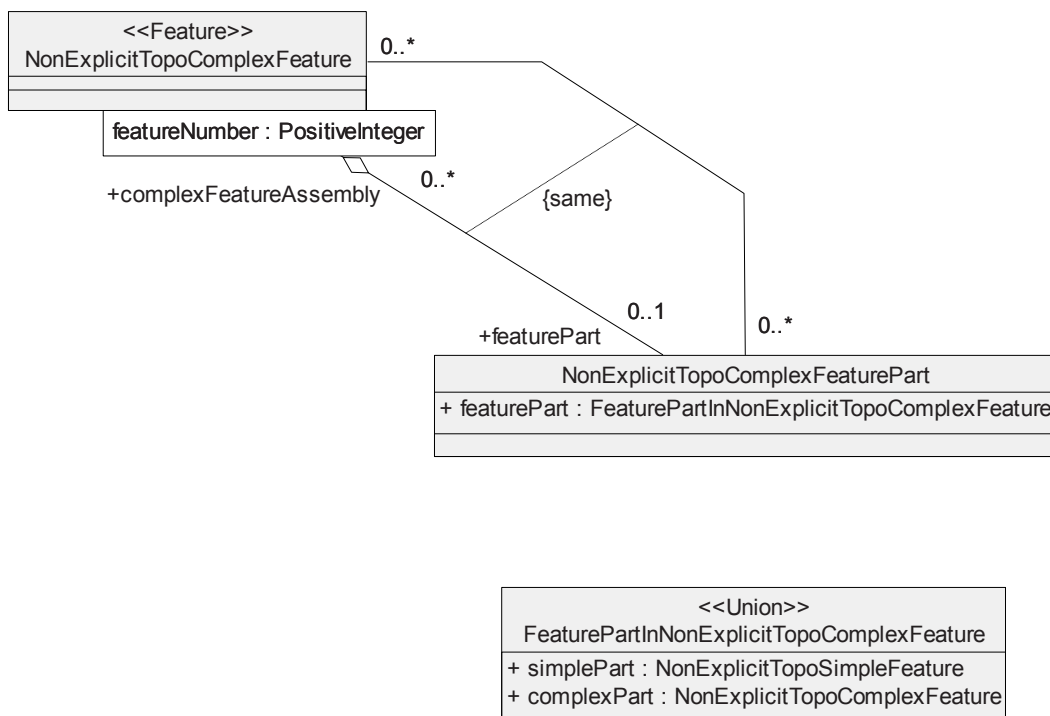

Figure 15 — The conceptual data model of Non-Explicit Topology Complex Features.

5.2.4 Height modelling and time modelling

So far, the different types of topology have been described in terms of their ability to define two dimensional objects. The standard however supports various levels of 3 dimensional modelling and also includes the possibility to model objects in a space-time continuum.

All different types of topology assume a two-dimensional plane to which the different Features are referred to. The standard also supports the definition of elevation above this plane in the sense that all geometries defined (by Nodes, Edges, Faces, Dots, Polylines or Polygons) can be given an elevation value representing terrain height.

In addition to this, non-explicit topology supports the 3-dimensional representation of Features. Next to their horizontal and elevation geometrical definition, Features are represented 3 dimensionally by a specification for each horizontal position of their minimum height and their maximum height above the terrain. In most cases the minimum height will be zero representing a Feature which extends from the ground a certain height vertically. This refers for instance to the case in which a normal building, located on the terrain with a certain height is represented. In certain cases however a Feature will extend from a certain height above the ground a certain height vertically. This refers for instance to arch shaped buildings which have a certain part starting a certain height above the ground and extending further upward (See Figure 16).

In non-planar and planar topology 3-dimensional aspects can be modelled via an Attribute solution. If a given Non-Explicit Topology Feature is subject to both 3-dimensional representation models (namely 3-dimensional characteristics on Feature level as well as 3-dimensional characteristics of Attributes of the Feature in question), the 3-dimensional characteristics on Feature level shall be given priority over the 3-dimensional characteristics on Attribute level.

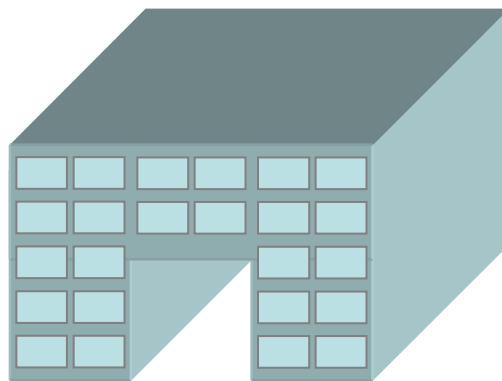

Figure 16 — Example of an arch shaped building

The standard also supports terrain modelling in which a 3-dimensional representation of the terrain may be defined. Four different methods are offered for this which include support for Triangular Irregular Networks (TIN's), contour lines and point grids. For the TIN support Faces and Polygons have been extended with enhanced geometric properties such as triangle size and slope. Contour Lines and Point Grids are modelled as Features and Attributes.

The standard also supports the representation of temporal characteristics of Features. This is supported for Non-Explicit Topology Features. This is done by extending each horizontal position of a Feature with four temporal definitions. These definitions stand for the moment of start of appearance (construction start), the moment of end appearance (opening), the moment of start of disappearance (closure) and the end of disappearance (demolition end). In this way the existence of a Feature over time can be represented. In non-planar and planar topology temporal aspects can be modelled via an Attribute solution. Here the Time Domain Model of GDF (See also 5.7) is applied whereby the start time and the duration of a certain construction status may be defined.

If a given Non-Explicit Topology Feature is subject to both time models (namely temporal characteristics on Feature level as well as temporal characteristics of Attributes of the Feature in question), the temporal characteristics on Feature level shall be given priority over the temporal characteristics on Attribute level.

5.3 The Attribute model

Characteristics of Features which are independent of other Features are modelled as Attributes. Attributes are of a certain Attribute Type identified by a name and code. The value of an Attribute instance is called an Attribute Value. Attribute data types include among others a code, text, an ID or number. This International Standard defines Attributes relevant for ITS applications and specifies which Attributes may be used in combination with which Features. For Complex Features, Attributes may be defined for a Complex Feature as a whole (assembly) or for a particular Feature part on an instance by instance basis.

In certain cases Attribute Values are defined within the GDF itself. In other cases only the domain of the Attribute Value is specified. This is the case when the Attribute Value is a measure (e.g. Average Speed) or is defined by a string of characters (e.g. Official Street Name Text). Another case relates to user-defined Attributes. User-defined Attributes are defined by the user within the context of a particular GDF. Certain Attributes that have been defined in the GDF do not have their Attribute Values defined. For example, the Attribute Value of Multimedia File Attachment is the reference to external files rendered in binary, XML, or other physical encodings.

The Attribute Catalogue defines a set of Attribute Types and corresponding reference names and codes. It also defines the Feature Class and/or the Relationship Type to which a particular Attribute Type may be attached. Figure 17 and Figure 18 give the conceptual data model for this. The diagram shows that an Attribute may be an aggregation of other Attributes. Such an Attribute is called a Composite Attribute, as opposed to a normal (non-aggregated) or Simple Attribute. A Composite Attribute consists of a number of Sub-Attributes. Semantically, a Composite Attribute specifies an aggregated value, which is composed of a number of values, specified by the value of the respective Sub-Attribute. Their appearance in a Composite Attribute specifies the fact that they represent partial information and that the complete information can be found in the other Sub-Attributes of the Composite Attribute.

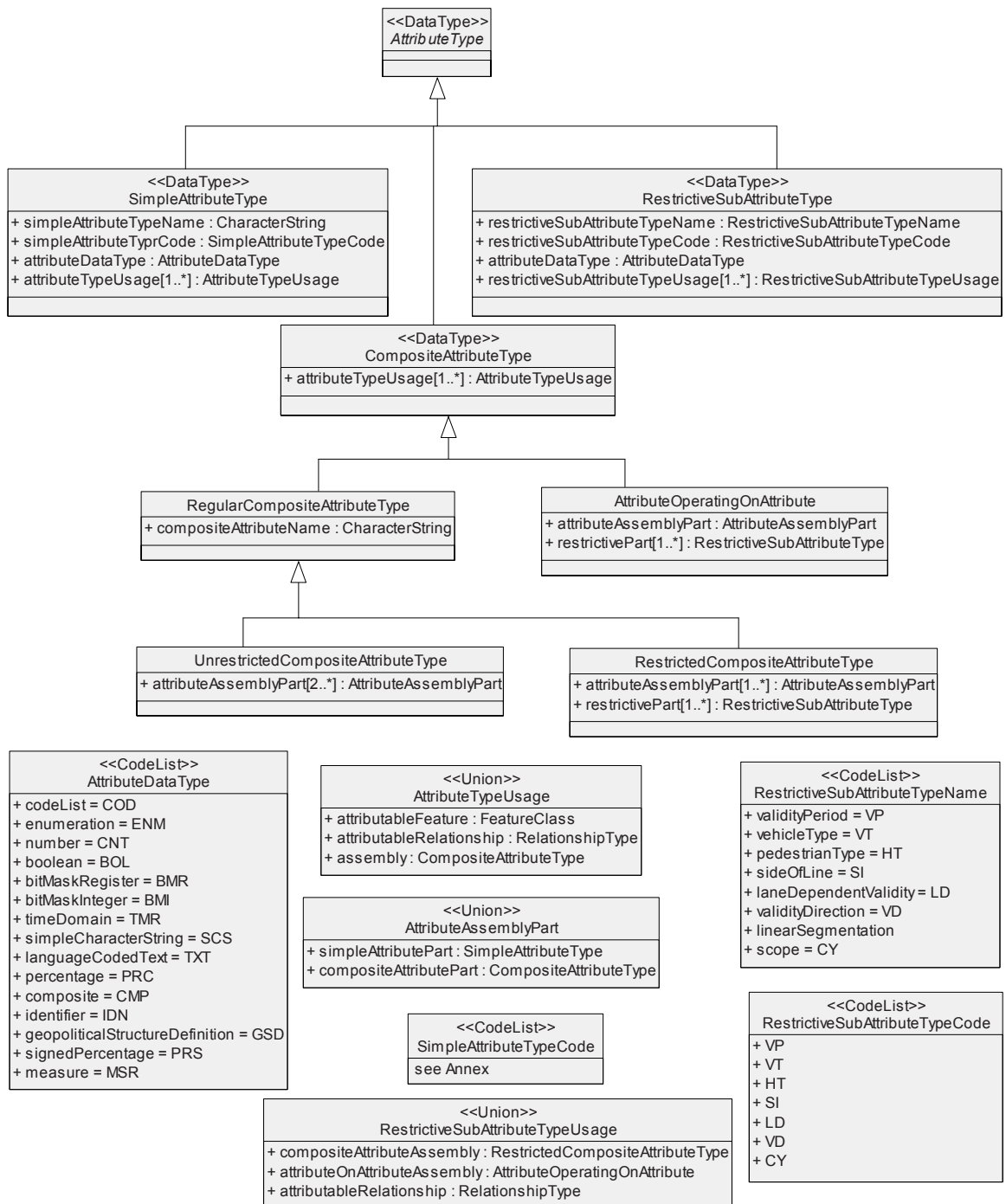

Figure 17 — The conceptual data model for Attribute Types

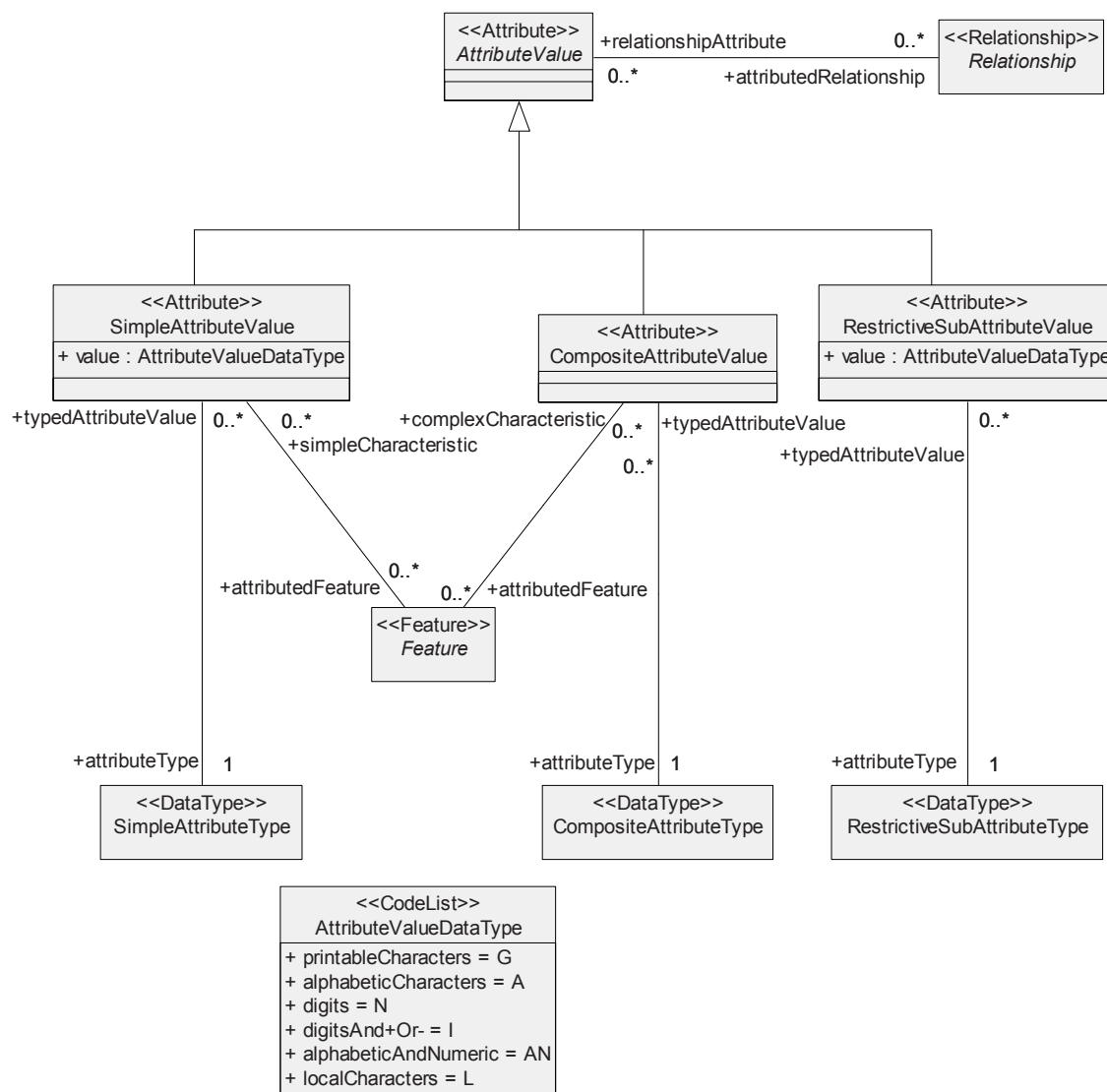

Figure 18 — The conceptual data model for Attribute Values

In most cases, like values of normal Attributes, Sub-Attributes values are independent. Cases where Sub-Attribute Values are not independent are cases where an Attribute (Simple or Composite) are combined with a so-called Restrictive Sub-Attribute operating in said Attribute. In these cases, the validity of the Attribute is restricted to the value specified in the Restrictive Sub-Attribute. Restrictive Sub-Attributes values may never be attached to a Feature individually. They shall always appear in combination with the Attribute they restrict. Restrictive Sub-Attribute Values may be attached individually to Relationship. In these cases they restrict validity of the Relationship.

Each Sub-Attribute of a Composite Attribute is either a Simple Attribute, a Composite Attribute, or a Restrictive Sub-Attribute. Any Sub-Attribute being a Composite Attribute recursively builds a hierarchical tree of Sub-Attribute sets at different hierarchical scope level. In case a Restrictive Sub-Attribute operates on a (Simple or Composite) Attribute, it implies representing a different scope level then said Attribute.

5.4 The Relationship model

A Semantic Relationship specifies a meaningful relation between two or more Features, which are not necessarily of different classes. Furthermore, the Features in a Semantic Relationship can be in the same or in different Sections or Layers.

Semantic Relationships with a common structure (e.g. linking Feature A to Feature B, where the instances of A are always of the same class and where the instances of B are always of the same class) and with a common meaning, are grouped into a Relationship Type. A particular Relationship Type is uniquely referred to by a Name and Code (see Figure 19).

Relationships are in many cases binary, i.e. involving two Features. However there are instances when three or more Features are involved in a Relationship. For example, the Relationship Prohibited Manoeuvre requires a Road Element, a Junction and at least one other Road Element, each playing a pre-defined and recognizable role.

A Relationship may be further qualified by means of Attributes. Similar to Attributes attachable to Complex Features assemblies and attachable to their parts, Attributes of a Relationship may be attached to a Relationship as a whole or to a particular Feature partner (per role). The set of attached Attributes may or may not be an ordered set. Whether the Attributes of a particular Relationship need to be an ordered sequence is explicitly specified.

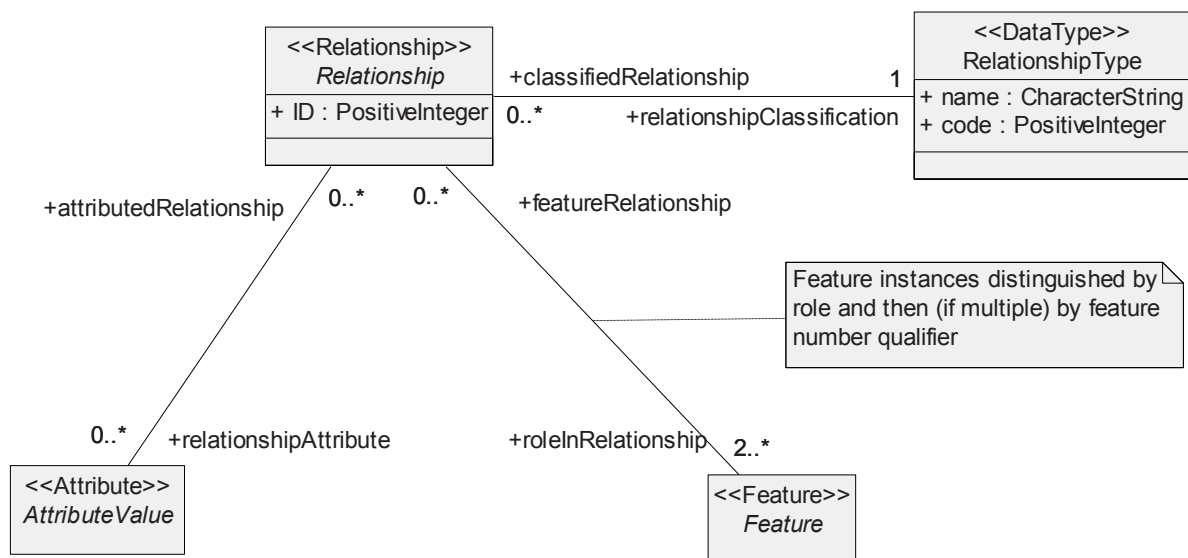

Figure 19 — The conceptual data model for Relationships

5.5 Linear referencing

GDF supports an ISO 19148-compatible mechanism of linearly referencing positions along Line Features. This allows to map different sets of corresponding Line Features to each other (such as Road Elements on one hand and Anchor Sections embodying a Linear Datum on the other hand) by means of linear assignments, to position Point Features along Line Features by means of point assignments, and to designate the validity of Attribute properties to a confined linear extent along a Line Feature in terms of linear segmentation.

5.6 The Feature representation scheme

The Feature Model, the Attribute Model and the Relationship Model can be considered as being valid for a wide range of applications. The Feature Representation Scheme is application specific in the sense that it specifies the representation needs of applications that share the same representation needs. The Feature Representation Scheme contained in the current standard specifies the needs of ITS applications. From these needs it follows for instance that a Road Element shall always be represented by a Line Feature. Another Feature Representation Scheme (not contained) may specify that a Road Element shall be represented by an Area Feature.

The most important role of the Feature Representation Scheme is to specify to which Feature Category or categories a particular Feature Class must or may belong. Seven different categories are distinguished: Topological Point, Line and Area Features, Complex Features and non-explicit Topological Point, Line and Area Features.

In Figure 20, two different possibilities are conceivable for a particular Feature Class:

- a) all instances must be of one and the same category.
- b) some instances may be of one category, other instances of another one.

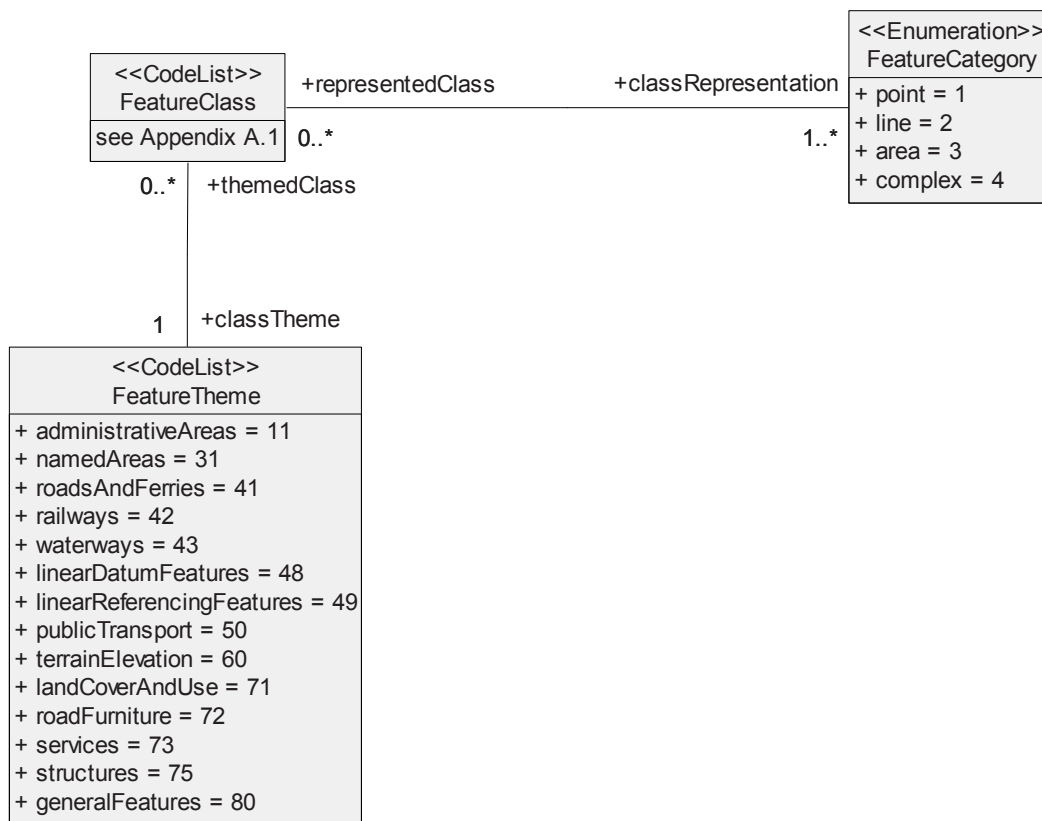

Figure 20 — The conceptual data model for Feature Representation

5.7 Time modelling

GDF supports the definition of temporal aspects. These can relate to Features, Attributes or Relationships. Temporal aspects of Features already have been conceptually described in section 5.2.4. In this paragraph reference was made to the GDF Time Domain Model. The GDF Time Domain Model also is used to define temporal aspects of Attributes and Relationships. The model uses starting time, ending time and duration as

basic elements to describe a specific period. Time expressions can either be modelled as a starting time and an ending time, or as a starting time and a duration. In special cases Time expressions may consist of a starting time alone or a duration alone. In addition to sharply defined time components (e.g. January 1, 2009 at 0h:00) the standard also supports the definition of more fuzzy time components (e.g. after sunrise). The time domain model is applied in certain “time-relevant” Attributes. Through this mechanism the time during which a certain Attribute or Relationship is valid may be modelled.

5.8 Data management: organisation of Feature data into Layers and Sections

The contents of a digital road map can be thought of as being structured spatially and according to the Feature content. This International Standard identifies the need to define a GDF as a set of different independent chunks of data. For this, the following conceptual model is provided.

Figure 21 through Figure 25 depict the overall structure under which Features are organised within a GDF. Figure 21 shows that one complete GDF is contained in an Album. An Album must be composed of one or more Datasets, whereby each Dataset contains a certain aerial subset of the total area covered by the GDF. Each Dataset must be composed of one or more Layers (see 10.1.3 for more on Albums and Datasets). Generally, the area covered by a Dataset and a Layer coincides. A Layer represents a division according to the Feature contents. It contains Feature data of one or more Feature Themes, of a uniform topology. Thus a Layer may contain exclusively Features represented under planar topology, non-planar topology, or non-explicit topology, but not a mixture (see Figure 22). This also means, that Planar Topo Section comprises Nodes, Edges and Faces as its primitives, whereas Non Planar Topo Section comprises only Nodes and Edges (See Figure 23).

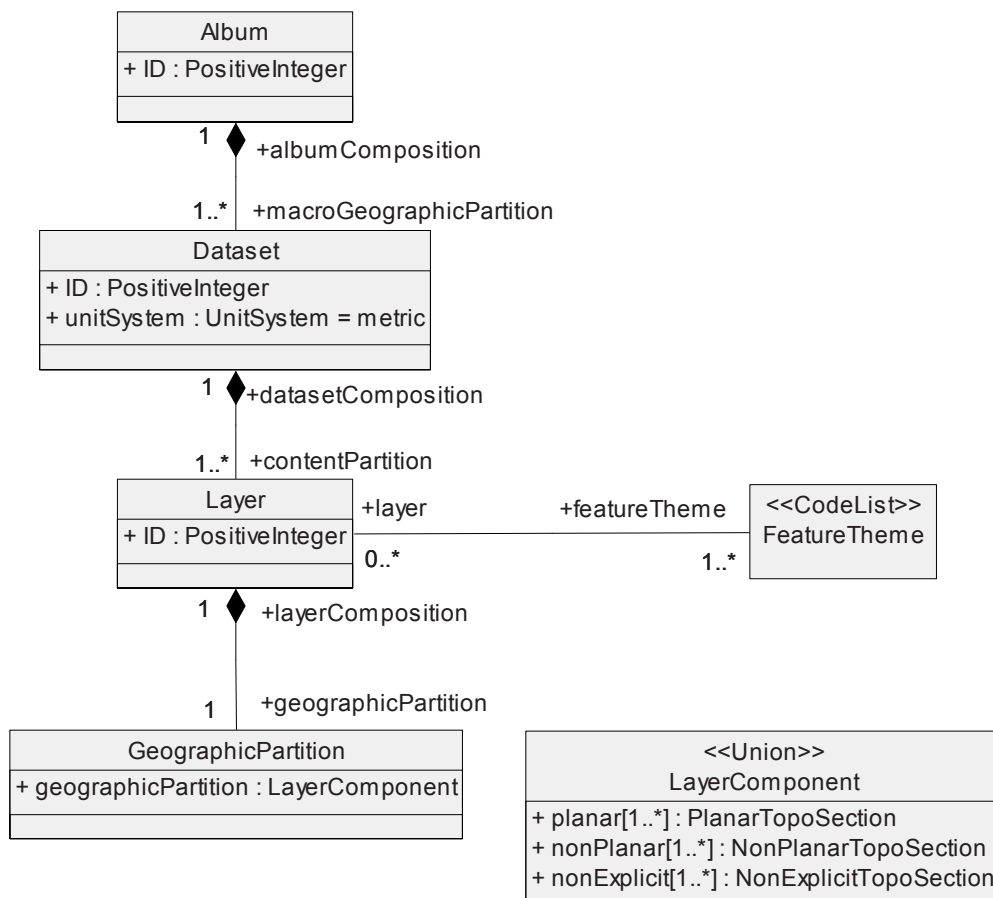

Figure 21 — The organization of data in Albums, Datasets, Layers and Sections

A Layer must be composed of one or more Sections, each of which represents a different geographic area. Figure 22 shows that the topology-based Sections of Figure 21 are composed of Features of their corresponding topologies. Thus a Planar Topo Section must be composed of one or more Planar Topo Features and so on. Sections can take the form of rectangular meshes or more natural areas like Administrative Areas. All Layers in a Dataset may have Sections with the same spatial extend or Sections with a Layer specific spatial subdivision may be defined.

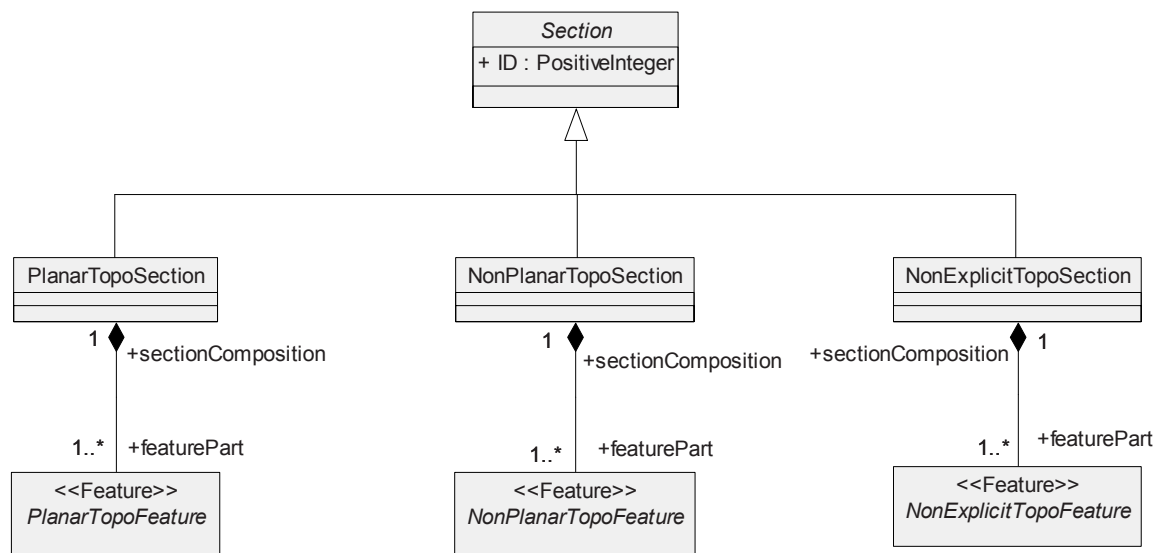

Figure 22 — Composition of Sections

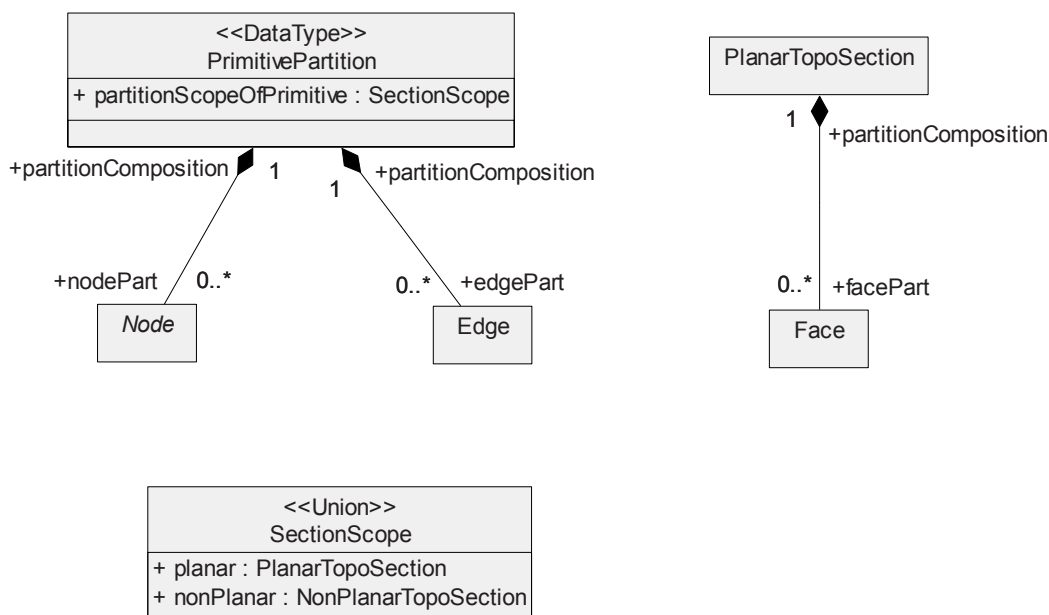

Figure 23 — Section Primitives

Each instance of an Attribute or a Relationship, respectively, can exist locally (partition scope is the Section), semi-globally (partition scope is the Layer), or globally (partition scope is the Dataset). This is depicted in Figure 24.

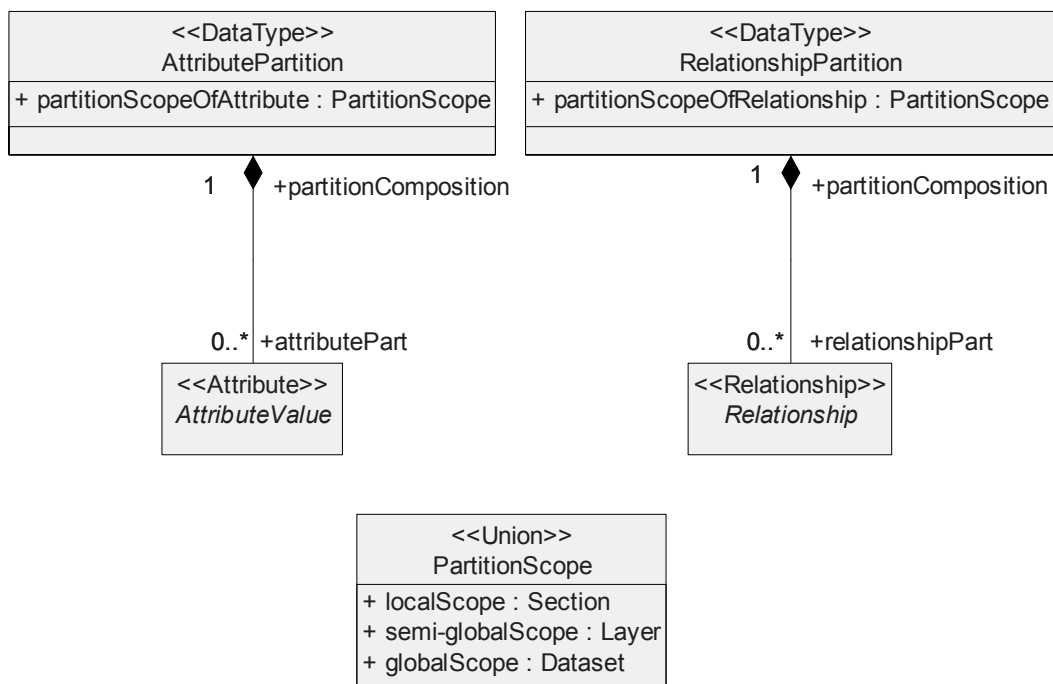

Figure 24 — Attribute and Relationship Partinoning Scope

At Section borders and Dataset borders (i.e. where a Section borders coincides with the Dataset border), Feature continuity is given by conversion information in terms of “translation” of Feature IDs (see Figure 25). The local instance of a Feature is logically connected to a foreign instance of the Feature that resides in an adjacent Section or Dataset. Annex A provides further details about this principle of GDF segmentation.

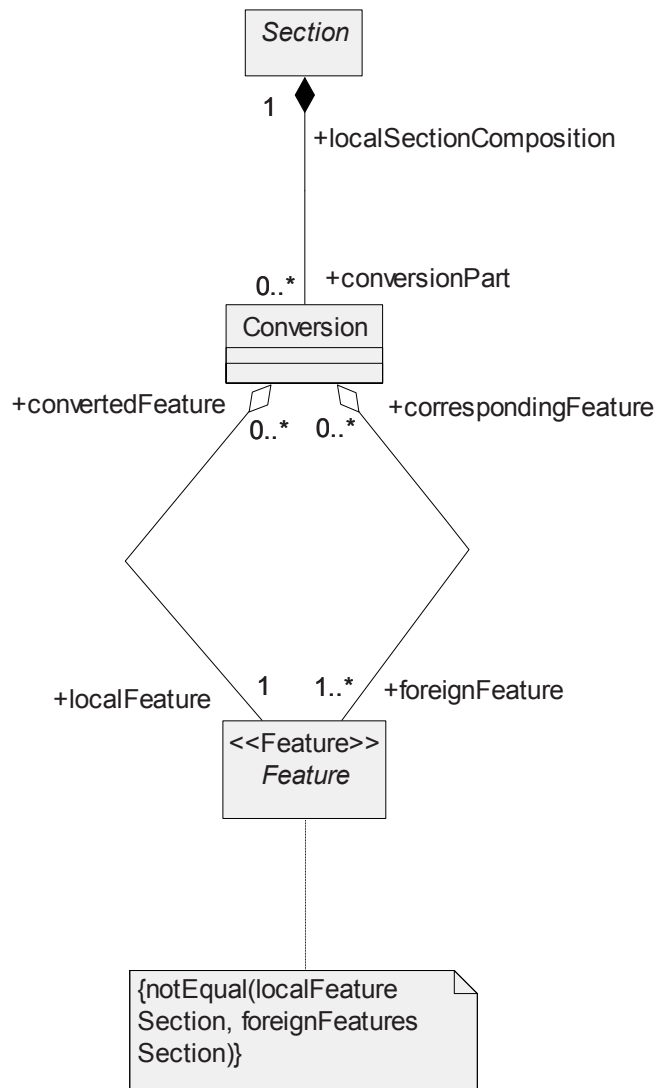

Figure 25 — Feature Conversion

6 Feature Catalogue

6.1 Generic specifications

6.1.1 Features and Feature Themes

In GDF real world objects or activities at a certain location are represented by “Features”. Examples of real world objects are roads and buildings. Examples of activities at a certain location are the services. Features such as “Roads” and “Ferries” may be grouped together into “Feature Themes” (for instance “Roads and Ferries”).

All Features and Feature Themes in the GDF are referenced throughout the manual by a Feature name or Feature Theme Name. Most of these names are derived from terms commonly used in daily life (for instance road, building). In order to distinguish a GDF Feature Name from these commonly used terms, the names of the Features and Feature Themes are written with an uppercase character at the beginning of each word (for instance “Road Element” versus “road element”).

6.1.2 Feature Class Codes

For data exchange the Features and Feature Themes are not referenced by their names but by a numeric code. A four-digit code is used for Features and a two-digit code for Feature Themes. A strict 1:1 relationship exists between Feature names and Feature Class Codes and between Feature Theme Names and Feature Theme Codes. A full list of codes is given in A.1.

6.1.3 Simple and Complex Features

GDF makes a distinction between Simple Features and Complex Features. A Simple Feature is a Feature not composed of other Features.

A Complex Feature is composed of Simple Features and/or other Complex Features. For example, an Intersection is a Complex Feature, made up of a set of Features such as Road Elements and Junctions. An example of a Complex Feature made up of other Complex Features is a Country made up of Order-1 (complex) Administrative Areas.

In case complex aggregations are subject to constraints (identifiable parts, ordered parts), this is explicitly specified.

6.1.4 Feature hierarchy

This International Standard supports the need to define a Feature hierarchy. In a Feature hierarchy definition, a certain Feature Class can be defined as a sub-type of a more generically defined super type. In this way, an instance of a sub-type can be considered on its own generalisation level as an instance of that sub-type while at a higher generalisation level as an instance of its super type. As an example, one can consider a Hotel which has as a super type Lodging Facilities which in turn can have as a super type Tourist Facility.

6.1.5 Data model for the Feature Catalogue

Figure 26 shows that part of the data model that is relevant for the Feature Catalogue. It shows that Features are organised into different Feature Themes.

6.1.6 User-defined Features

This International Standard supports the ability for a user to define Features that are not already defined. For these, special Feature Class Codes have been reserved. (See A.1.)

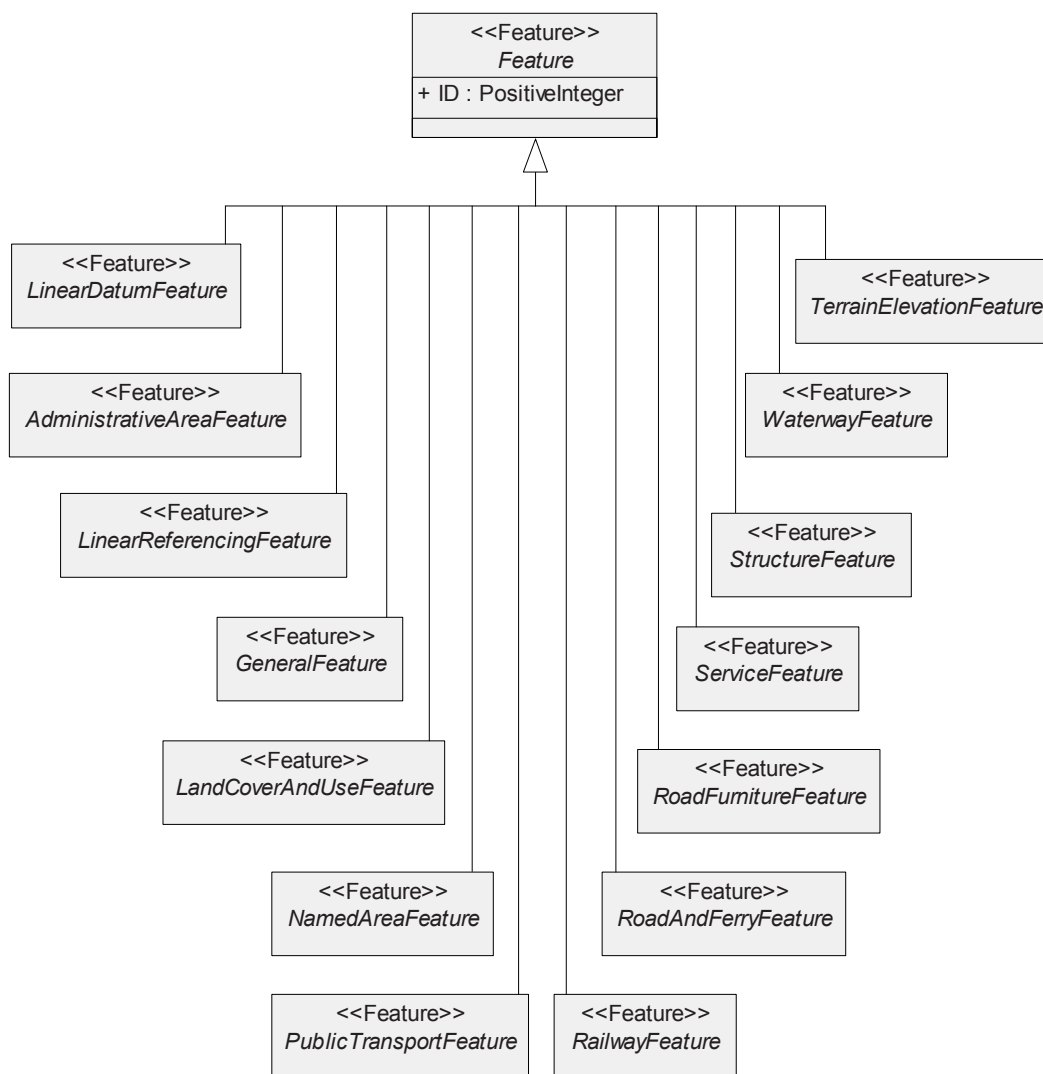

Figure 26 — The Conceptual Data Model of the Feature Catalogue

Features from the different Feature Themes are discussed in the following sub-clauses.

6.2 Roads and Ferries

6.2.1 General overview

The road network is seen here primarily from the viewpoint of transportation and traffic. Ferry connections are therefore placed together with road network elements in one theme.

The road network can be represented at two different levels, Level 1 and Level 2. Level 1 describes the Simple Features such as Road Element, Junction, Ferry Connection, Enclosed Traffic Area, Address area Boundary Element and Address Area, whereas Level 2 describes the Complex Features such as Road, Intersection, Ferry and Aggregated Way.

The Data Model for Roads and Ferries is given in Figure 27, Figure 28 and Figure 29 which describes Relationships between Features within and between Level 1 and Level 2.

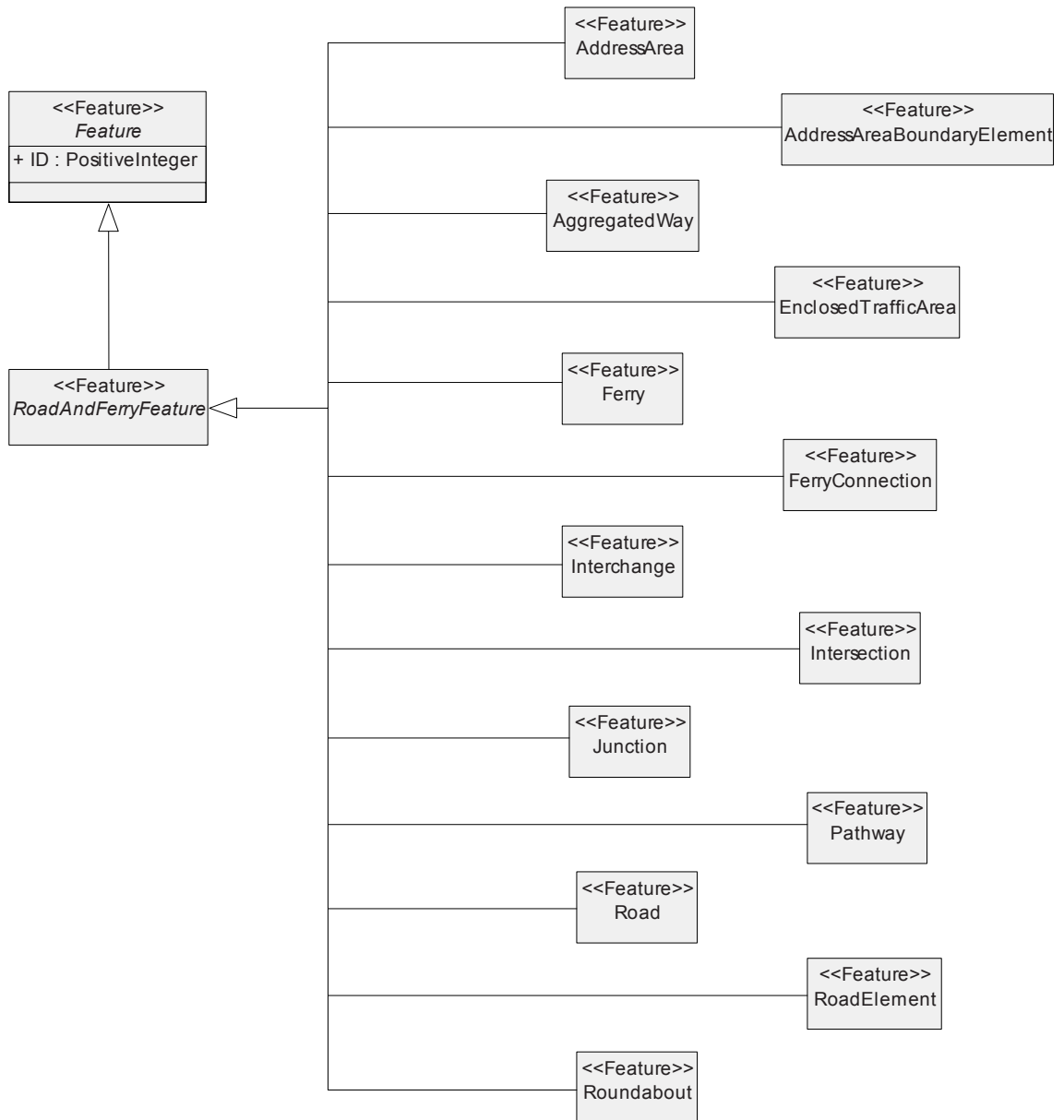

Figure 27 — The Conceptual Data Model for Roads and Ferries

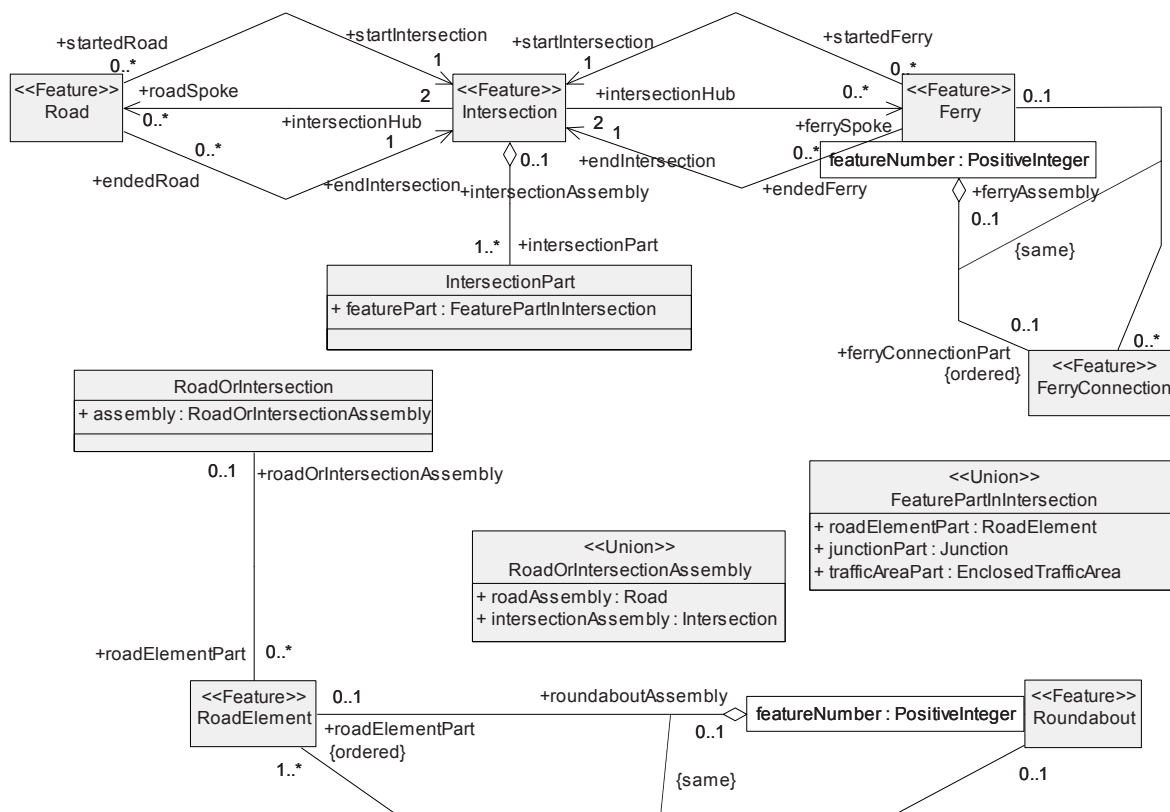

Figure 28 — The Conceptual Data Model for Roads and Ferries (continued)

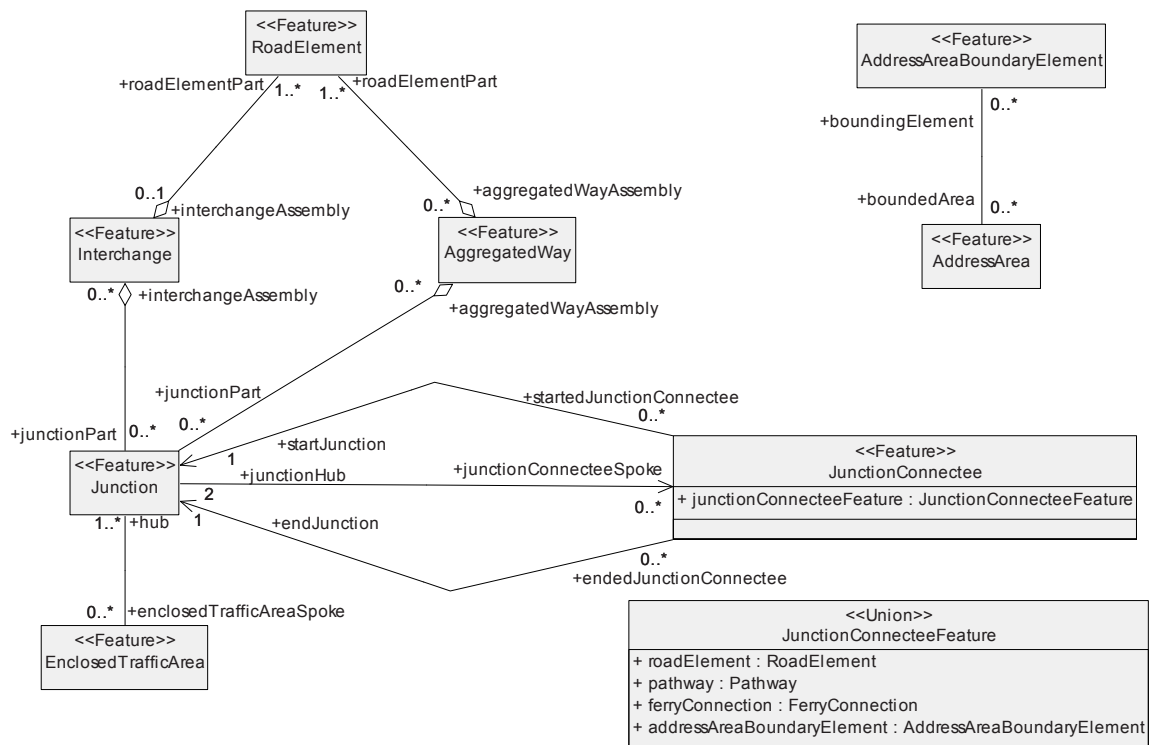

Figure 29 — The Conceptual Data Model for Roads and Ferries (continued)

6.2.2 Address Area

6.2.2.1 Definition

An area containing addresses which cannot be related to one or more Road Element.

6.2.2.2 Description

In certain situations addresses are defined in such a way that the information cannot be related to one or more Road Element. Two different situations can be identified:

- The addresses are located in a square, which has a name that is different from the name of the Road Element(s) representing the road network on that square.
- The addresses are defined according to building blocks. In these cases a building block has a name which differs from the name of an adjacent building block and of the Road Element which possibly divides the two building blocks.

An Address Area should always have a connection with the road network.

6.2.3 Address Area Boundary Element

6.2.3.1 Definition

A representation of the boundary of an Address Area.

6.2.3.2 Description

An Address Area Boundary Element describes the outer confinement of an Address Area. An Address Area Boundary Element is start and end bounded by a Junction that is defined where the Address Area intersects with the road network.

6.2.4 Aggregated Way

6.2.4.1 Definition

A set of associated Road Elements and, optionally, Junctions which share a common function or characteristic.

6.2.4.2 Description

An Aggregated Way is a Feature which has been defined by a user, for example a road authority, for the purpose of identifying and relating Features in their user-specified model to level 1 Features in the GDF.

A Road Element or Junction can belong to more than one Aggregated Way. Aggregated Ways do not have an implied topology; that is, they are not necessarily connected to other Aggregated Ways, and do not necessarily form a complete network.

6.2.5 Enclosed Traffic Area

6.2.5.1 Definition

Any confined area within which unstructured traffic movements are allowed.

6.2.5.2 Description

EXAMPLE Industrial Site, Car Park, Harbour area, Camp Site, Military Area or Unstructured Traffic Square.

6.2.6 Ferry

6.2.6.1 Definition

A set of Ferry Connections that describe a passage of a particular ferry line.

6.2.6.2 Description

A Ferry plays the same role in the ferry network as a Road in a road network.

6.2.6.3 Aggregation constraints

A Ferry is composed of an ordered sequence of concatenated Ferry Connections.

6.2.7 Ferry Connection

6.2.7.1 Definition

A vehicle transport path between two fixed locations on the road network which uses a prescribed mode of transport.

EXAMPLE boat ferry connection or rail ferry connection.

6.2.7.2 Description

Ferry Connection is the smallest independent unit of the transportation network operated by a ferry that is represented at Level 1.

Many situations look like the situation depicted in Figure 30. This is interpreted as one single Ferry Connection. But situations exist where one ferry service joins more than two locations as shown in Figure 31. This situation has to be interpreted as three different Ferry Connections: AB, BC and CA.

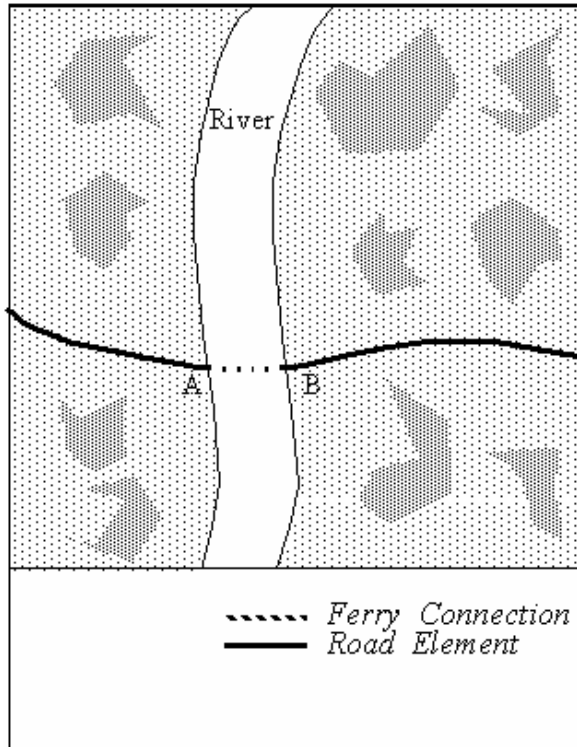

Figure 30 — Example of Ferry Connection joining two terminals

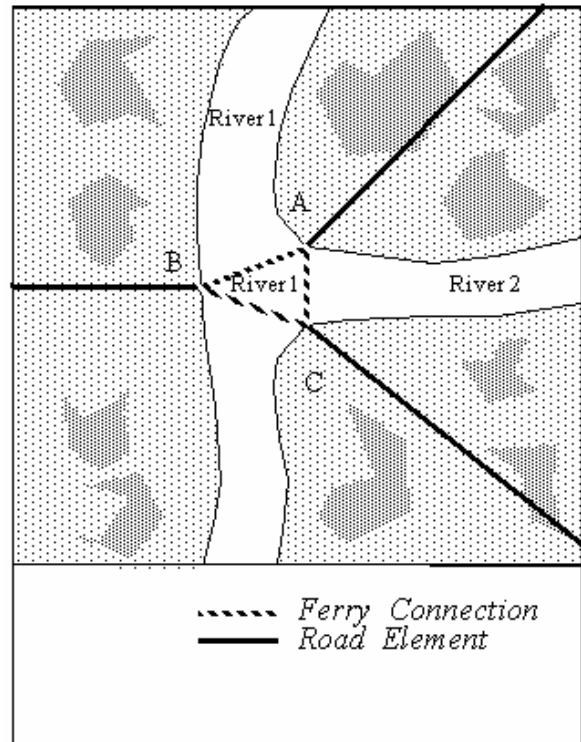

Figure 31 — Example of Ferry Connections joining three terminals

6.2.8 Interchange

6.2.8.1 Definition

An Interchange is a collection of road sections, slip roads and/or carriageways dedicated to facilitating the movement of traffic through a crossing between two or more road ways.

6.2.8.2 Description

An Interchange is a Complex Feature composed of all the Road Elements and Junctions forming a crossing.

EXAMPLE 1 Interchanges between Motorways or Freeways, composed of a collection of slip roads and the carriageways which connect these.

EXAMPLE 2 Interchanges between Motorways or Freeways and non-Freeways composed of a collection of slip roads and the carriageways which connect these.

EXAMPLE 3 Interchanges between multi- or single carriageways at grade. These can have the form of a simple crossing without slip roads, a crossing containing slip roads and a crossing in the form of a roundabout.

Distinct Interchanges may not share Road Elements but they may share Junctions. Thus an Interchange may cover more than two crossing roads when one of its slip roads leads to more than one road.

Two interchanges close together may share carriageways. In such a case, the two interchanges should be combined into one Interchange so that a single carriageway belongs to at most one interchange.

6.2.9 Intersection

6.2.9.1 Definition

The Level 2 representation of a crossing. An Intersection can be part of a Level-2 network by bounding Roads and/or Ferries. It is a Complex Feature composed of one or more Level 1 Junctions, Road Elements and Enclosed Traffic Areas.

6.2.9.2 Similarities and differences between Intersection and Junction

At Level 2, the Feature Intersection plays a similar role as the Feature Junction does at Level 1. Generally, it bounds Roads and Ferries and joins them to other ones. The difference between an Intersection and a Junction lies in the degree of generalisation; where a multi-element crossing will be described at Level 1 by many Road Elements and Junctions; it may be represented at Level 2 by one single Intersection.

Rules for formation of Intersections may be found in Annex F.

6.2.10 Junction

6.2.10.1 Definition

A Feature that bounds a Road Element, a Pathway, an Address Area Boundary Element, or a Ferry Connection.

6.2.10.2 Description

A Road Element, a Pathway, an Address Area Boundary Element, or Ferry Connection always forms a connection between two Junctions, and a Road Element, a Pathway, an Address Area Boundary Element, or Ferry Connection is always bounded by exactly two Junctions. A Junction Feature represents the physical connection between its adjoining Road Elements, Pathways, Address Area Boundary Elements, and Ferry Connections.

6.2.10.3 Valency of a Junction

The number of Road Elements, Pathways, Address Area Boundary Elements, and/or Ferry Connections joining at a Junction is termed the Valency of a Junction.

EXAMPLE A Junction that connects a total of two Road Elements is called a two valent Junction.

The occurrence of Junctions that bound only two Features classes from Road Elements, Pathways, Address Area Boundary Elements, and Ferry Connections is generally restricted to the following situations:

- An extra Junction must be defined at the end of a dead end road which further continues as a Ferry Connection.
- An extra Junction may be used if two Road Elements or two Pathways have at least one different Attribute Value or participate in at least one different Relationship. Figure 32 uses the example of traffic restrictions.
- An extra Junction must be used to avoid a Road Element or a Pathway having the same Junction at the start and at the end, as shown in Figure 33.

- An extra Junction may be used to form independent complex Road Features. Figure 34, a Junction may be introduced to allow a complex Road Feature to be formed.

Junctions that bound only two Road Elements, bound only two Pathways, bound only two Address Area Boundary Elements, or bound only two Ferry Connections should not exist in the road network if none of the above conditions is fulfilled.

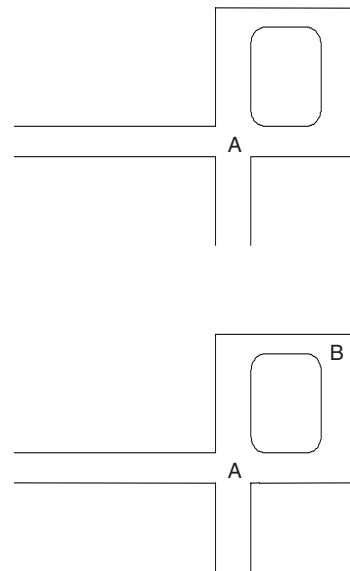
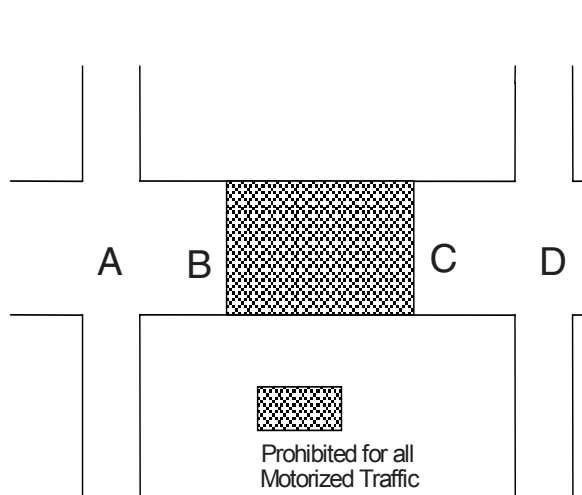

Figure 32 — A bivalent Junction (B,C) may be used to differentiate between Road Elements with different Attributes

Figure 33 — A Road Element forming a loop must be split by an extra bivalent Junction (B) to allow for describing Direction of Traffic Flow

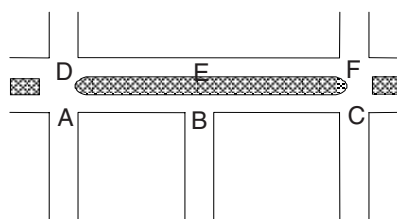

Figure 34 — Formation of Level 2 Road. Junction E may be inserted to allow for the representation of the Level 2 Intersection

6.2.11 Pathway

6.2.11.1 Definition

A linear section of the earth which is exclusively designed for or the result of the movement of pedestrian and non-motorised/non-road vehicles.

6.2.11.2 Description

A Pathway serves as the smallest unit of the pedestrian and non-motorised vehicle transportation network that is independent and having a Junction at each end.

Similar network composition rules apply for Pathways as for Road Element. Pathways and Road Elements, as well as Address Areas and Ferry Connections, are topologically connected via Junctions.

Pathways represent a complementary extension to the transportation network to specifically serve pedestrians and non-motorised/non-road vehicles. It typically has physical characteristics which prevent road vehicles from entering and includes surface and non-surface access such as out-door and in-door passage ways, subways, stairs, elevators, and escalators. Roads which are blocked to prevent road vehicles from entering except for a certain period (e.g. a certain time of day, a certain day of week) or without a special permit shall be considered as Road Elements and not as Pathways. Where pedestrians or non-motorised/non-road vehicles use the network represented by Road Elements (or sidewalks/dedicated lanes along Road Elements, or pedestrian zones represented by Road Elements), no supplementary Pathway representation is required.

Pathways may carry a name, however often do not carry full addresses except in special cases such as shopping malls.

Within the context of this definition, pedestrian usage includes transportation aided by basic devices such as wheel chairs and scooters.

6.2.12 Road

6.2.12.1 Definition

A Level 2 Feature composed of one, many or no Road Elements and joining two Intersections. It serves as the smallest independent unit of a road network at Level 2.

6.2.12.2 Relation between Road, Road Element and Intersection

6.2.12.2.1 Construction Rules

A Road always forms a connection between two Intersections. Roads are defined in terms of the Road Elements that they contain. Below some basic construction rules are given. For a more elaborated description see Annex F.

6.2.12.2.2 A road containing one Road Element

This is the most common case and is illustrated by Figure 35. At Level 1 this road can be seen as consisting of one Road Element. At Level 2 the same road can be seen as one Road. Road CL 573 is bounded by the Intersections CS 203 and CS 204, and contains Road Element L 203.

6.2.12.2.3 A road containing two Road Elements

Figure 36 shows a dual carriageway. Both carriageways are physically separated and can be consequently interpreted as individual Road Elements.

At Level 2 however, both carriageways are considered as making up one single Road. Road CL 583 contains Road Elements L 452 and L 854 and is bounded by the Intersections CS 723 and CS 721.

In order to consider two Road Elements as forming a multi-carriageway, the following requirements must be met.

- Each Road Element must be a “one way road”, as drawn in Figure 39.
- It must be possible to see the Road as one single functional unit. This is often indicated by the fact that the different Road Elements have the same road name or road number. Figure 41 shows a situation of a street having a service road at its side. The Road Element that represents the service road has a different road class to the Road Element representing the main road. Consequently, these two Road Elements do not form a multi-carriageway.

A Road may not be formed from Road Elements separated by a Road Element belonging to a different Road. This condition is illustrated in Figure 40. A main road is shown having service roads at both sides. Though they fulfil all the other requirements, Road Elements representing the service roads may not be considered as forming a Road because they are separated by the Road Element representing the main road.

Another situation where a Road consists of two Road Elements, is where the Road Elements are joined by two-valent Junctions.

6.2.12.2.4 A road containing more than two Road Elements

In occasional cases a Road may contain more than two Road Elements. Figure 37 shows an example: a road has two parts having a single carriageway and one part with separated carriageways. At Level 1, this road can be interpreted as four Road Elements. At Level 2 however, the road should be interpreted as one Road. Road CL 599 is built up by Road Elements L 258, L 259, L 260 and L 261.

Another situation where a Road consists of more than two Road Elements, is where the Road Elements are joined by two-valent Junctions.

6.2.12.2.5 A road containing no Road Elements

In rare cases a Road may contain no Road Elements at all. Figure 38 shows two sequential crossings between a dual carriageway and two single carriageways.

In the example, Level 2 is constructed from Level 1 by:

- The Road Elements L217, L218, L219, L220, L401, L402, L403, L501, L502, L503 and L504 and their connecting Junctions are mapped onto the Intersection CS754.
- The Road Elements L221, L222, L223, L224, L404, L405, L406, L505, L506, L507 and L508 and their connecting Junctions are mapped onto the Intersection CS755.

Consequently no Road Elements remain that are mapped onto Road CL 891. This Road contains no Road Elements and is bounded by the Intersections CS 754 and CS 755.

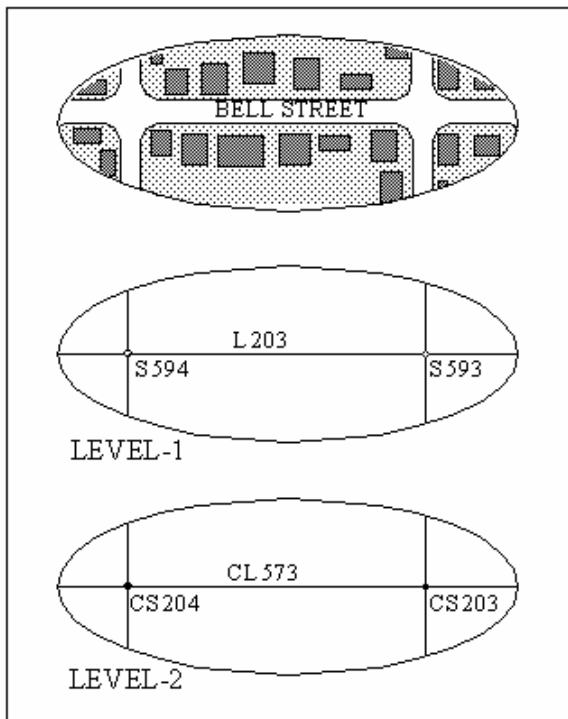

Figure 35 — A Road containing one Road Element

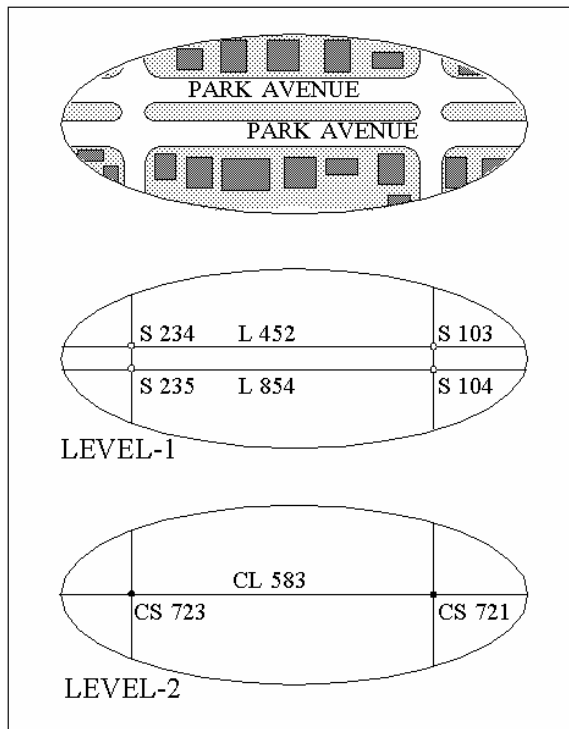

Figure 36 — A Road containing two Road Elements

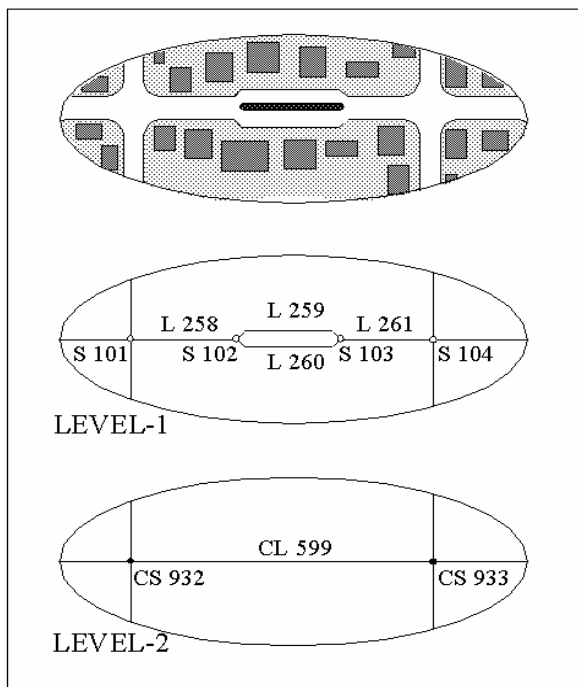

Figure 37 — A Road containing more than 2 Road Elements

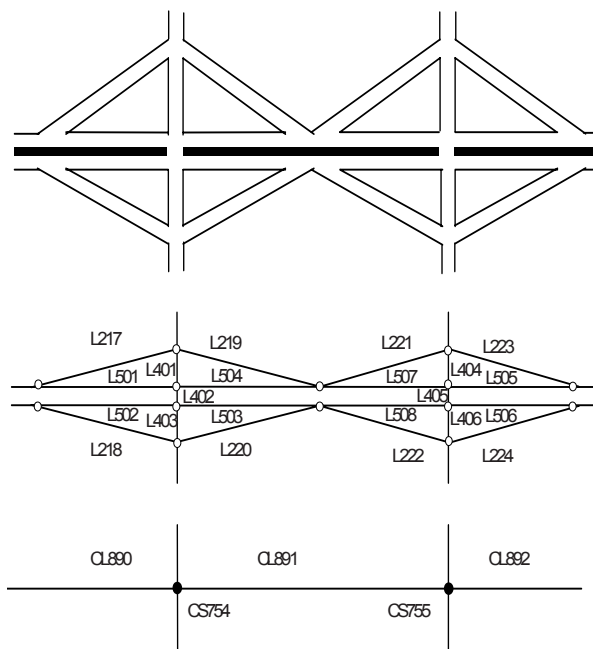
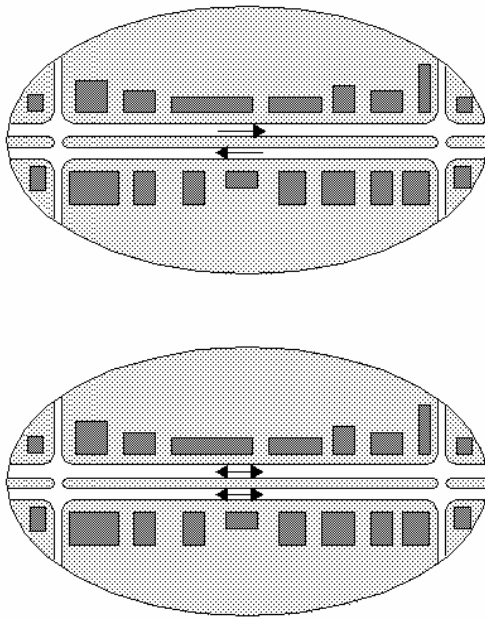
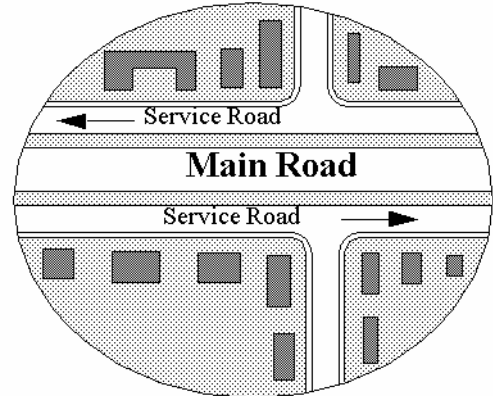

Figure 38 — Road CL891 contains no Road Elements



NOTE For a road to be considered as a multi-carriageway each Road Element must be “one-way”.

Figure 39 — Guidelines for formation of Road



NOTE A Road may not be formed from Road Elements separated by a different road.

Figure 40 — Guidelines for formation of Road

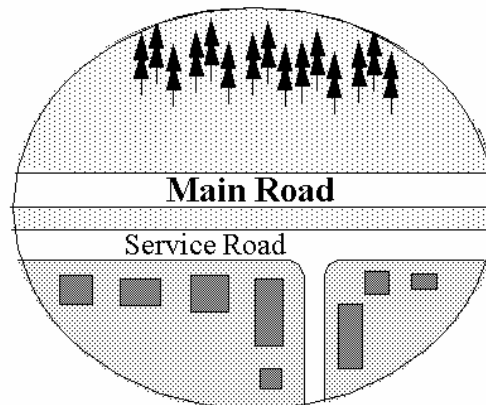

NOTE A main road and a parallel service road are not to be considered as multi-carriageways. For a road to be considered as a multi-carriageway and declared as a Road, each Road Element usually has similar functional and physical characteristics.

Figure 41 — Guidelines for formation of Road

6.2.13 Road Element

6.2.13.1 Definition

A linear section of the earth which is designed for or the result of vehicular movement. It serves as the smallest unit of the road network at Level 1 that is independent and having a Junction at each end.

6.2.13.2 Independence of Road Elements

Individual Road Elements must be independent of one another. A change in the status of one Road Element must not affect a change in another. In Figure 42 for example, AB, BE, ED, DC and CA are all Road Elements. Their independence is illustrated by the fact that a barrier placed on Road Element CD creates a no through road CD, but does not affect the status of the other Road Elements.

Road Elements may also have a distinguishing set of Attributes. For example, in Figure 43, Road Elements AF, FB have different names. AD, DE and EC have different restrictions. Within the context of the Attributes Official Name and Direction of Traffic Flow, the elements AF, FB, AD, DE, EC and BC may be considered as being the smallest independent units and can consequently be considered as individual Road Elements. Alternatively, changes in Attributes along a single road element can be described by stating the starting and ending positions along the road element for which the Attribute is valid. This procedure is further described in the Attribute Catalogue (see Clause 8, Relation between Attributes and Features: Segmented Attributes)

6.2.13.3 Aggregation rules

Any additions to the Attributes of a Road Element, such as a restriction, or another name, may require it to be split into two or more separate Road Elements. In the example of Figure 23, the addition of a width restriction can cause the Road Element BC to be split into three new elements in order to be able to distinguish the influence of the narrow bridge from the other parts of the road. Alternatively, the limits for which Attributes are valid along a road element may be described together with the Attribute Value.

In Figure 44 carriageways are considered as being independent and consequently are treated as two individual Road Elements. A road with a physical separation between two parts of a road can be represented by two different Road Elements. Alternatively, the physical separation can be indicated by Attributes.

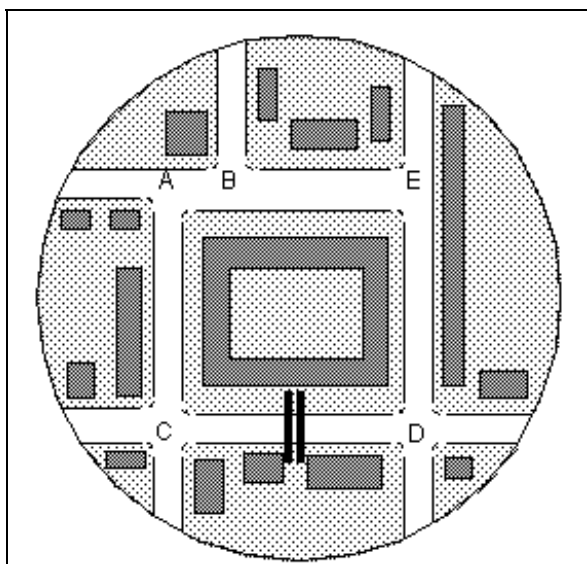

NOTE Road Element CD is independent of other Road Elements. When CD is blocked, traffic can still flow on other elements.

Figure 42 — Independence of Road Elements by function

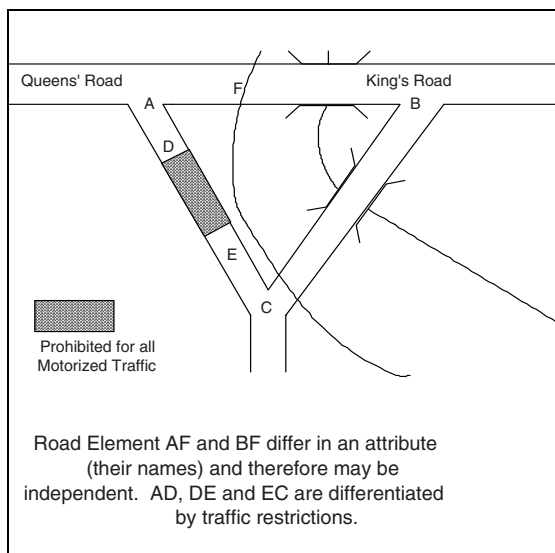

Figure 43 — Independence of Road Elements by Attribute

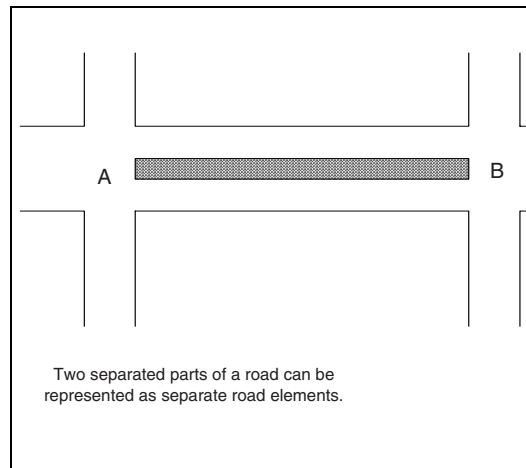

Figure 44 — Road Elements as separated Carriageways

6.2.14 Roundabout

6.2.14.1 Definition

A Roundabout is a simple closed one way loop in the road network that regulates traffic flow at the meeting of roads at grade.

6.2.14.2 Description

A Roundabout is a Complex Feature composed of all the Road Elements and Junctions forming the closed loop plus all the Road Elements and Junctions belonging to each Intersection along the loop (See Figure 45).

A Roundabout is differentiated from other traffic control Features by requiring special real time driving instructions of the form "take the third exit from the roundabout". Alternate terms for roundabout are traffic circle and rotary.

6.2.14.3 Aggregation constraints

A Roundabout is composed of an ordered sequence of concatenated Road Elements.

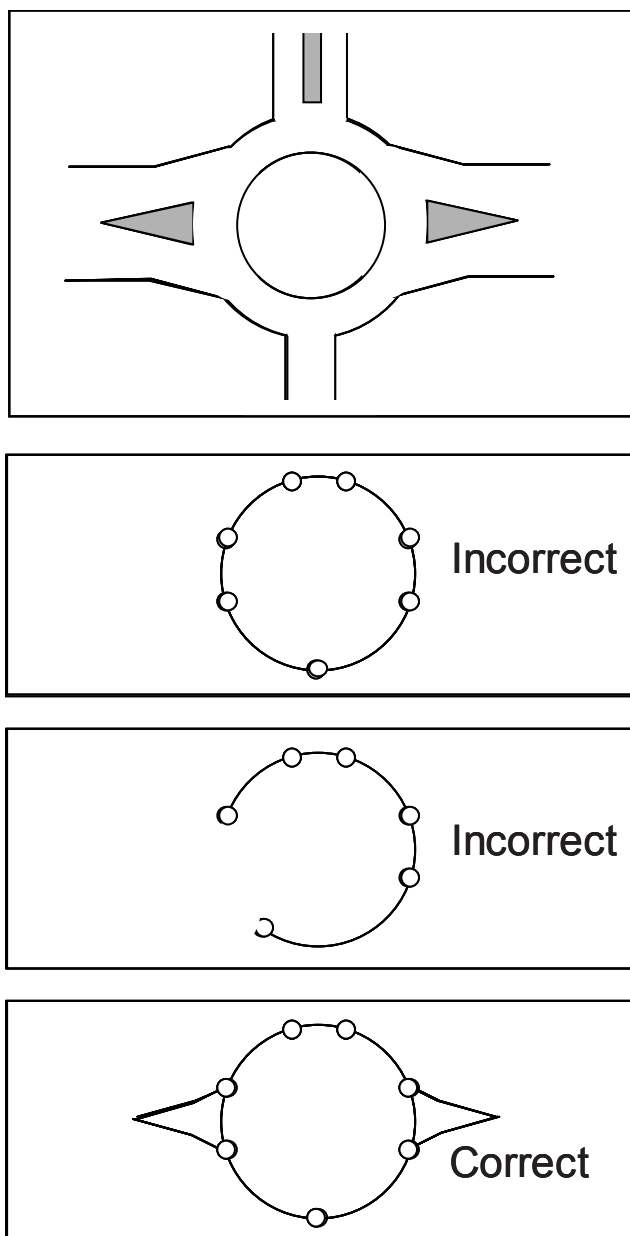

Figure 45 — Guidelines for the definition of a Roundabout

6.2.15 Topological relations between Junctions, Road Elements, Pathways, Enclosed Traffic Areas, Ferry Connections and Address Areas Boundary Elements

6.2.15.1 Introduction

Road Elements, Ferry Connections, Pathways, Address Area Boundary Elements, and Junctions are mutually dependent: a change in the first set will cause a change in the second one and vice versa.

A Junction is defined at the intersection of two or more road centrelines.

A Junction is also defined at the end of a dead end road, at the intersection of a Road Element and a Pathway, of a Pathway and a Pathway, a Road Element (or Pathway) and an Enclosed Traffic Area, of a Road Element (or Pathway) and a Ferry Connection or of a Road Element (or Pathway) and an Address Area Boundary Element.

6.2.15.2 General

The set of Junctions, Road Elements, Pathways, Enclosed Traffic Areas, Address Area Boundary Elements and Ferry Connections has to be constructed in such a way that it represents the topological relations in the road transportation network correctly.

This important requirement is illustrated in Figure 46. This figure shows a T-junction. The correct interpretation is to see it as consisting of three Road Elements AB, BC and BD joining at Junction B.

6.2.15.3 Grade separated crossings

Grade separated crossings between Transportation Elements involve objects such as bridges, viaducts, aqueducts and tunnels

Road Elements and/or Pathway at Grade separated crossings do not share a Junction. If a Junction is present at the location of the Grade separation, it either is connected to the lower set of Transportation Elements or to the higher but never to both.

6.2.15.4 Squares

Traffic squares, which are not completely unstructured, but which have some legally defined traffic flow or internal structure which prescribe a traffic flow, have to be considered as being composed of different Road Elements.

EXAMPLE A fountain, flower beds, and/or painted lines on the road surface.

Figure 47 shows a traffic square with a grass bed in its centre. The traffic square is composed of the sequence of Road Elements AB, BC, CD and DA which together form a closed ring.

Figure 48 shows an area where traffic movements are not regulated in a strict geometrical sense. These are considered Enclosed Traffic Areas. These Features are represented as an area at which the incoming Road Elements end in a Junction. The Enclosed Traffic Area itself forms the topological connection between these Road Elements. Inside the area, Road Elements may be defined which have only topological, and not a geometrical, significance.

Squares that are exclusively designated for pedestrian movement, traversal and sojourn are always modelled via Enclosed Traffic Areas as certain characteristics for motorised traffic (e.g. prescribed traffic flow) do not apply. These Features are represented as an area at which the incoming Pathways (as well as potential Road Elements) ends in a Junction. The Enclosed Traffic Area itself forms the topological connection between these Pathways (and Road Elements). Next to open spaces in urban environments, Pedestrian Squares may include courtyards and in-door halls.

6.2.15.5 Parking areas

Parking areas are to be considered Enclosed Traffic Areas (see Sub-clause 6.2.5), or in case of representation of a Point Feature as a Service.

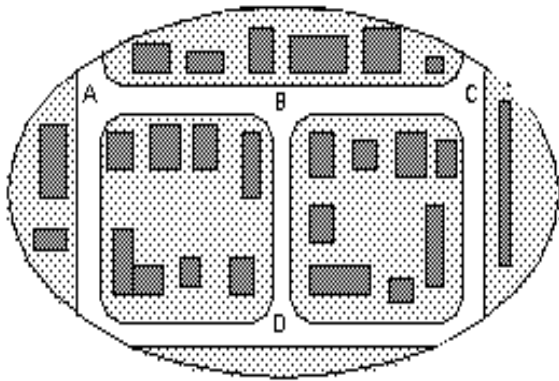

NOTE Junctions and Road Elements are constructed such that they represent the road network correctly.

Figure 46 — Topological Requirements

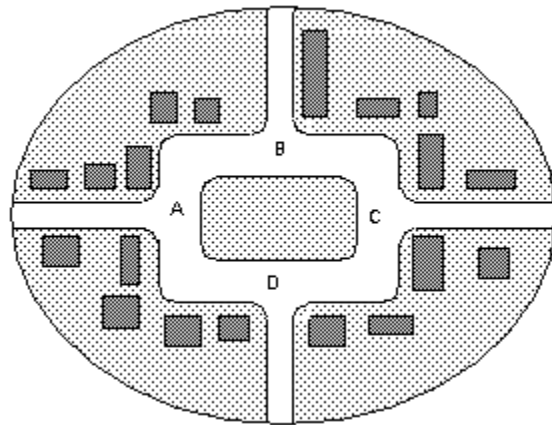

NOTE Traffic Squares which have some internal structure are represented by different Road Elements.

Figure 47 — Topological Requirements for Structured Squares

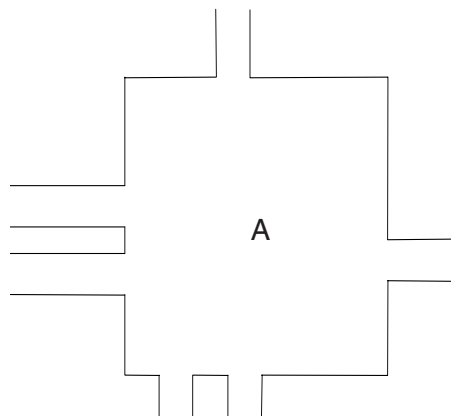

Unstructured Traffic Squares are represented as enclosed traffic areas.

Figure 48 — An Unstructured Traffic Area

6.3 Administrative Areas

6.3.1 General overview

For administrative purposes, the territory of a country may be divided into regions that have further subdivisions, forming a hierarchy of administrative units. Some countries may have Administrative Areas that are not part of such a hierarchy.

NOTE Hierarchies are meant in a narrow mathematical-spatial sense, in terms of subsequent topological inclusions.

The highest order of hierarchical Administrative Areas (within a national context) is called the Country. The subdivisions of a Country are called Order-*i* Areas where *i* ranges from 1 to 8. The number of Administrative Area orders is, with rare exceptions, fixed for a country. Some Order-8 Areas may be subdivided by Order-9 Areas in case the represented Administrative Areas are not present countrywide.

The Standard identifies the need to model administrative units which cover multiple countries. These are called Supra-National Administrative Areas.

An Administrative Area outside a hierarchical scheme is called an Administrative Place *n*, where *n* represents an upper-case letter. The exact relation to other Administrative Areas is recorded by the Place within Place Relationship.

The Data Model for Administrative Areas is shown in Figure 49, Figure 50, Figure 51 and Figure 52.

Annex G.1 shows for a number of countries how the generic Features Order-*i* Area can be substituted by native terms and languages. To specify how this may be done in a particular GDF the standard provides Metadata structures.

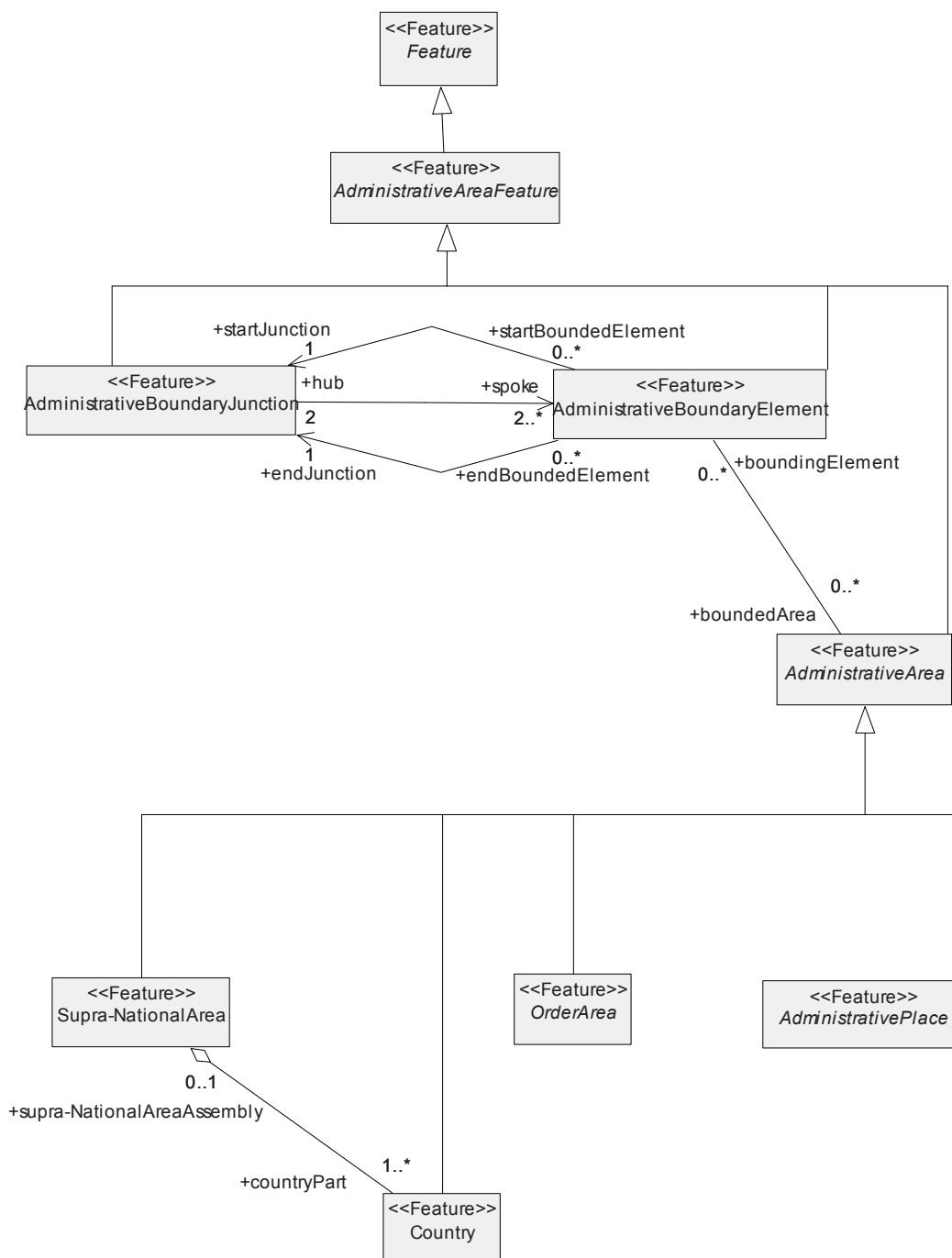

Figure 49 — The Conceptual Data Model for Administrative Areas

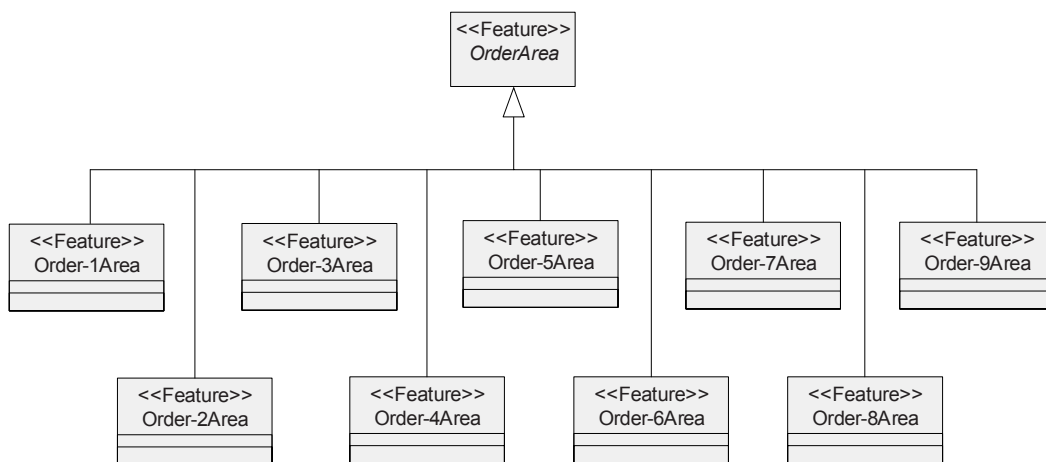

Figure 50 — The Conceptual Data Model for Administrative Areas (Order Areas)

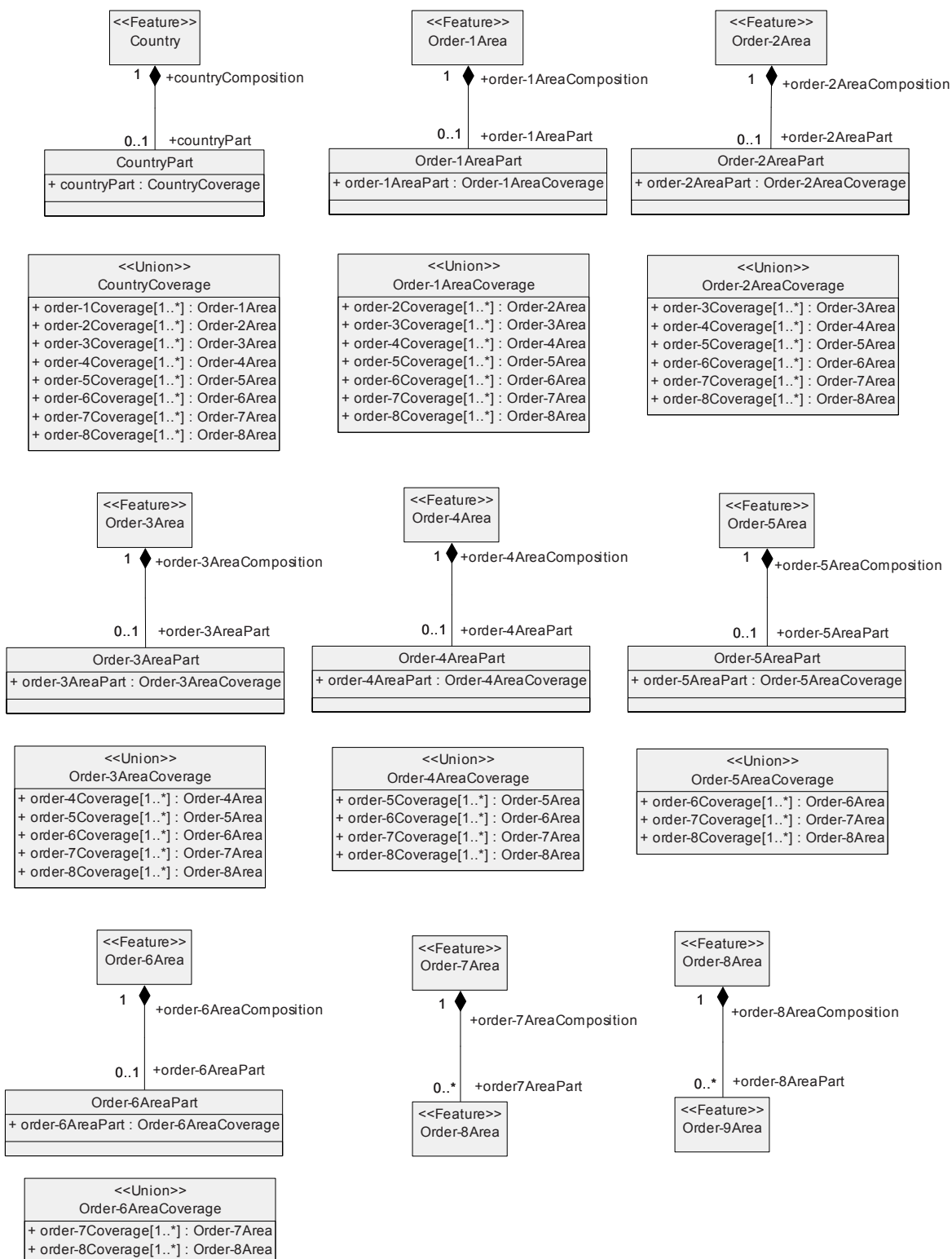

Figure 51 — The Conceptual Data Model for Administrative Areas (Order Area Coverage)

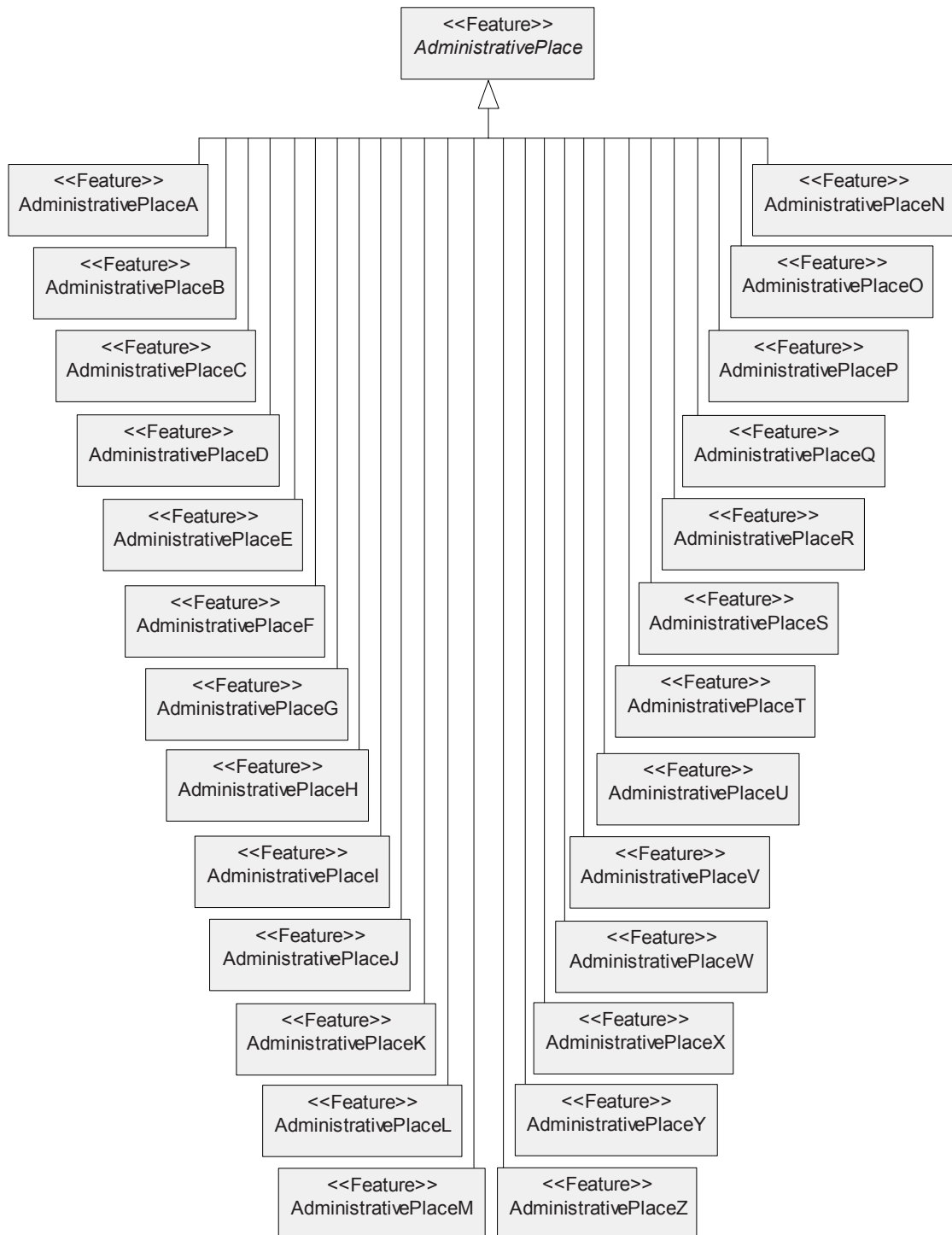

Figure 52 — The Conceptual Data Model for Administrative Areas (Administrative Places)

6.3.2 Administrative Area (abstract)

6.3.2.1 Definition

Administrative Area is abstract class of Administrative Place, Country, Order Area and Supra-National Area Feature.

6.3.2.2 Description

See Figure 49. As an abstract class, Administrative Area cannot be instantiated.

6.3.3 Administrative Boundary Element

6.3.3.1 Definition

The smallest unit of a boundary of an Administrative Area.

6.3.3.2 Description

The same Administrative Boundary Element may be used to bound several Administrative Areas.

6.3.3.3 Constraints

An Administrative Boundary Element is bounded by exactly two Administrative Boundary Junctions. These need not necessarily be different Nodes (see Figure 53). An Administrative Boundary Element may never bound the same Administrative Area twice (see Figure 54).

6.3.4 Administrative Boundary Junction

6.3.4.1 Definition

The location where Administrative Boundary Elements join.

6.3.4.2 Constraints

An Administrative Boundary Junction connects one or more Administrative Boundary Elements. It will typically bound three but in exceptional cases just two. A Bivalent junction is only permitted as a result of omitting a boundary of a lower order area. Figure 55 illustrates the case when an Administrative Boundary Junction connects one single Administrative Boundary Element.

6.3.5 Administrative Place (abstract)

6.3.5.1 Definition

Administrative Place is abstract class of Feature Administrative Place A to Z.

6.3.5.2 Description

See Figure 52. As an abstract class, Administrative Place cannot be instantiated.

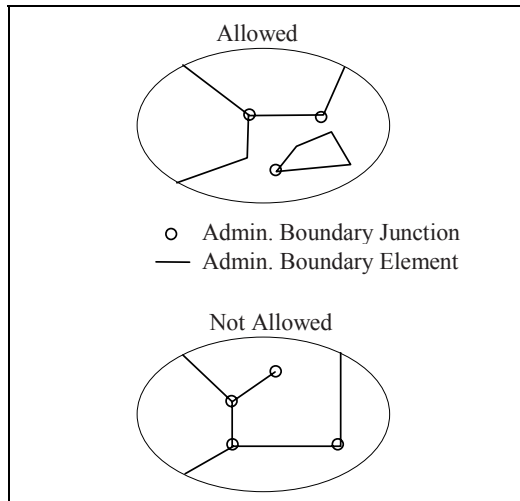

Figure 53 — Administrative Boundary Elements and Administrative Boundary Junctions (case 1)

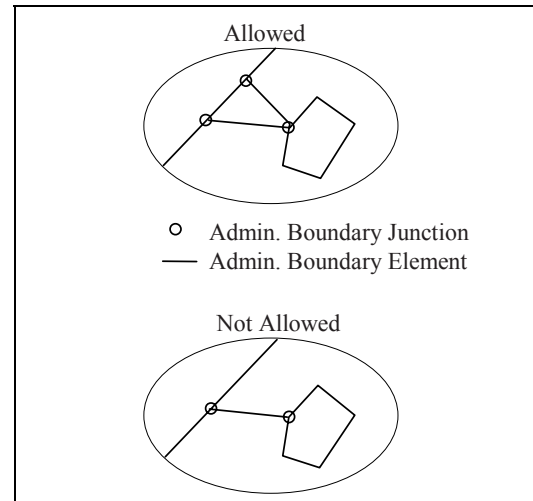

Figure 54 — Administrative Boundary Elements and Administrative Boundary Junctions (case 2)

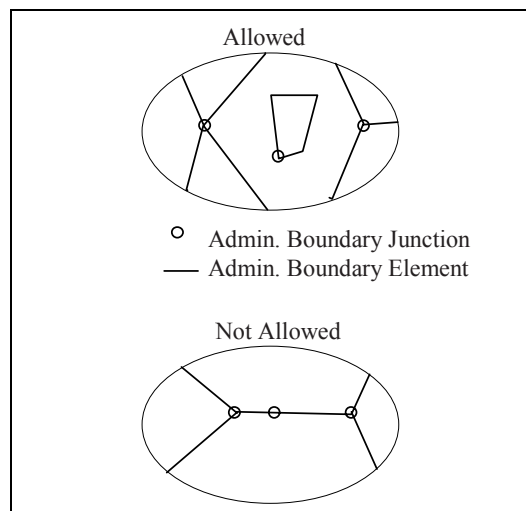

Figure 55 — Administrative Boundary Elements and Administrative Boundary Junctions (case 3)

6.3.6 Administrative Place A to Z

6.3.6.1 Definition

An area defined for administrative purposes outside an hierarchical structure.

6.3.6.2 Description

An Administrative Place fails to be part of the hierarchy by either:

- Not forming a complete subdivision of an Order-i Area or Country, or
- lying in more than one Order-i Area.

26 Administrative Place Feature Classes have been defined. They are named “Administrative Place n”, where $n \in \{A,B,\dots\}$. These are 26 placeholders for Places defined by Metadata. No order is implied among the members of the set.

6.3.7 Country

6.3.7.1 Definition

A country as defined by national boundaries.

6.3.7.2 Description

A Country must be subdivided into Order-*i* Areas in a uniform manner. A Country having no subdivisions should be composed of a single Order-8 Area.

6.3.8 Order Area (abstract)

6.3.8.1 Definition

Order Area is abstract class of Order-1 Area, Order-2 Area, Order-3 Area, Order-4 Area, Order-5 Area, Order-6 Area, Order-7 Area, Order-8 Area, and Order-9 Area Feature .

6.3.8.2 Description

See Figure 50. As an abstract class, Order Area cannot be instantiated.

6.3.9 Order-1 to 7 Areas

6.3.9.1 Definition

An Order-*i* Area, where $i \in \{1,2,\dots,7\}$, is part of an intermediate level of the administrative hierarchy of a country.

6.3.9.2 Description

In some Countries, these intermediate levels may not exist. Annex G lists some examples.

6.3.10 Order-8 Area

6.3.10.1 Definition

An Order-8 Area is part of the lowest order of the administrative hierarchy in the country that is present countrywide.

6.3.10.2 Description

In a country with no administrative divisions, there is only one Order-8 Area and it is coextensive with the country. Annex G lists some examples by country of Order-8 Area names.

6.3.11 Order-9 Area

6.3.11.1 Definition

The Administrative Area level that is a subdivision of Order-8 Area.

6.3.11.2 Description

Some Order-8 Areas may be split into smaller units. This may be the case for one single Order-8 Area or for all Order-8 Areas in a particular region.

EXAMPLE 1 Rotterdam.

EXAMPLE 2 All municipalities in Bavaria.

These smaller units are classed as Order-9 Areas.

6.3.12 Supra-National Area

6.3.12.1 Definition

An area comprised of whole Countries that have established common supra-national administrative functions.

6.3.12.2 Description

EXAMPLE 1 The European Union.

6.4 Named Areas

6.4.1 General overview

Named areas are areas that have a distinguishing functional or physical purpose. These may include areas with a concentration of homes and buildings that designate residential areas, areas with a commonly known name, or areas that are serviced by the same service provider, such as police precincts, or school districts.

The Data Model for Named Areas is shown in Figure 56.

6.4.2 Boundaries (abstract)

6.4.2.1 Definition

Boundaries is abstract class of Boundary Element and Boundary Junction.

6.4.2.2 Description

See Figure 56. As an abstract class, Boundaries cannot be instantiated.

6.4.3 Boundary Element

6.4.3.1 Definition

The smallest unit of a boundary which delimits Features of the theme Named Areas.

6.4.3.2 Description

A boundary is formed between two adjacent Bounded Areas of similar type. A Boundary Element of a Bounded Area may coincide with an Administrative Boundary Element of an Administrative Area.

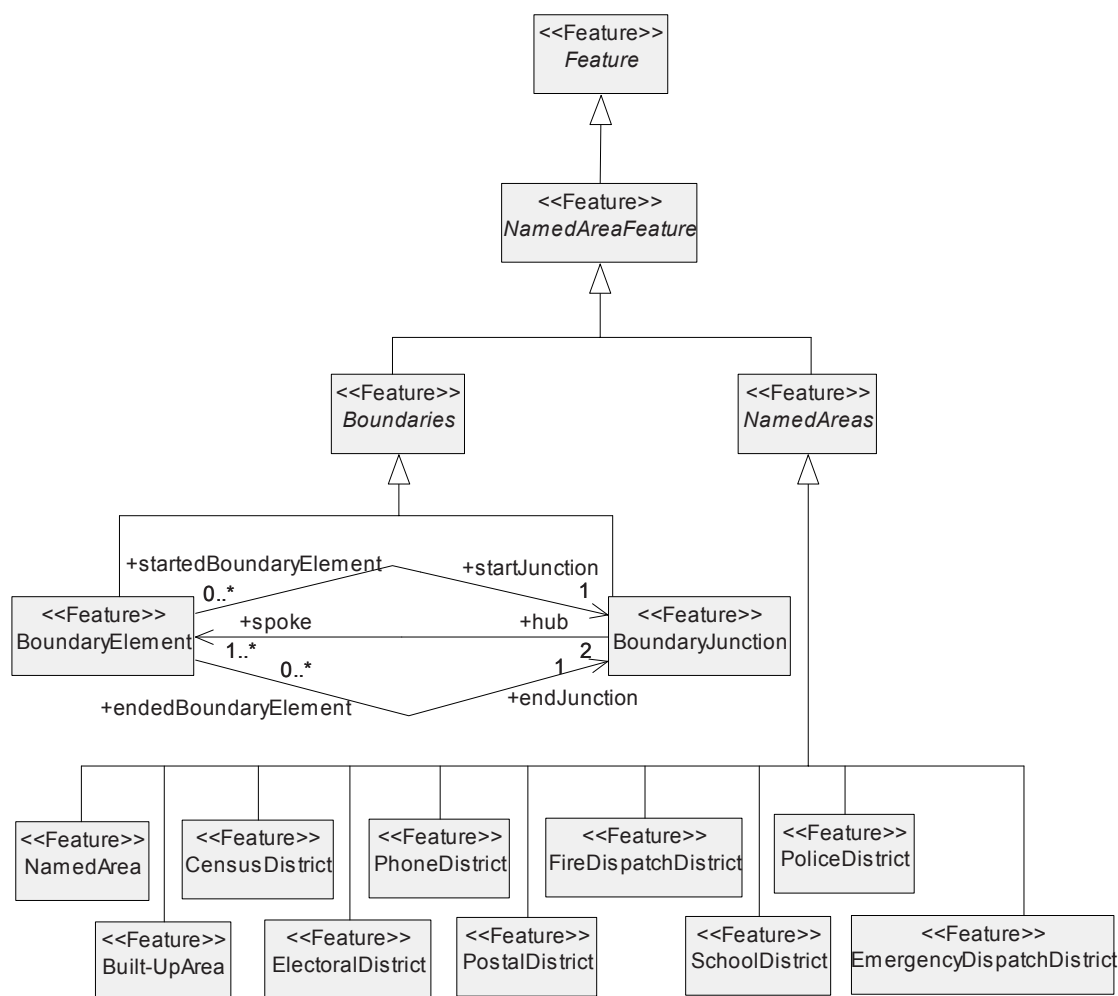

Figure 56 — The Conceptual Data Model for Named Areas

6.4.3.3 Constraints

A Boundary Element is bounded by exactly two Boundary Junctions. These need not necessarily be different Nodes. A Boundary Element may never bound the same Bounded Area twice. See Figure 54.

6.4.4 Boundary Junction

6.4.4.1 Definition

The location where Boundary Elements join.

6.4.4.2 Constraints

A Boundary Junction joins/connects one, three or more Boundary Elements. It will typically bound three but never two. The Administrative Areas equivalent Boundary Junction has several illustrations to elucidate these constraints (see Figure 53, Figure 54 and Figure 55).

6.4.5 Bounded Area (abstract)

6.4.5.1 Definition

Bounded Area is abstract class of Named Area, Built-Up Area, and District Feature.

6.4.5.2 Description

See Figure 56. As an abstract class, Bounded Area cannot be instantiated.

6.4.6 Built-up Area

6.4.6.1 Definition

An area with a concentration of buildings. In these areas, an inner city speed limit generally applies.

6.4.6.2 Description

No exact Relationship exists between a Built-up Area and a municipality. In some cases a Built-up Area relates to exactly one municipality having the same name. However, in rural areas in particular, one municipality can contain several small Built-up Areas. Also situations exist (Paris, Brussels) in which a Built-up Area, referenced by most people by one single name, is spread over several municipalities or other kinds of Administrative Areas.

6.4.7 Census District

6.4.7.1 Definition

Area that defines a unit that exists to collect and generate statistical information.

6.4.8 District (abstract)

6.4.8.1 Definition

District is abstract class of Census District, Elective District, Emergency Medical Dispatch District, Fire Dispatch District, Phone District, Police District, Postal District and School District Feature.

6.4.8.2 Description

See Figure 56. As an abstract class, District cannot be instantiated.

6.4.9 Electoral District

6.4.9.1 Definition

Area that defines a unit that exists to report the results on the vote and manage political activities.

6.4.10 Emergency Medical Dispatch District

6.4.10.1 Definition

Area defined for managing the dispatch of emergency medical personnel.

6.4.11 Fire Dispatch District

6.4.11.1 Definition

Area defined for managing the dispatch of fire fighters.

6.4.12 Named Area

6.4.12.1 Definition

A clearly or fuzzy bounded area, covering a region having its own commonly used name to identify this particular region.

6.4.12.2 Description

EXAMPLE The Black Forest, The Alps, or The Riviera.

6.4.13 Named Areas (abstract)

6.4.13.1 Definition

Named Areas is abstract class of Elective District, Census District, Fire Dispatch District, Emergency Medical Dispatch District, Built-up Area, Named Area, School District, Phone District, Police District, and Postal District.

6.4.13.2 Description

See Figure 56. As an abstract class, Named Areas cannot be instantiated.

6.4.14 Phone District

6.4.14.1 Definition

Area that defines a unit responsible for the delivery of telephone services usually associated with one area code.

6.4.15 Police District

6.4.15.1 Definition

Area defined for managing the dispatch of police officers.

6.4.16 Postal District

6.4.16.1 Definition

Area defined as a unit for postal services expressed by a name.

6.4.17 School District

6.4.17.1 Definition

Area that defines which educational institution services are provided for its residents.

6.5 Land Cover And Use

6.5.1 General overview

Land Cover And Use provide contextual information about the coverage or usage of the earth's surface. Many of the Land Cover And Use types are hierarchical in structure, being further subdivided into subtypes [32]. Land Cover And Use contains on the highest level the following Features:

- Land Cover Objects (abstract)
- Artificial Surface
- Agricultural Area
- Forest and Semi-Natural Area
- Wetlands
- Island

In the specification below, specification of super-type is given in combination with the data model containing it's direct sub-type. See Figure 57 for the highest level. Specification of a sub-type contains a specification of it's direct super-type.

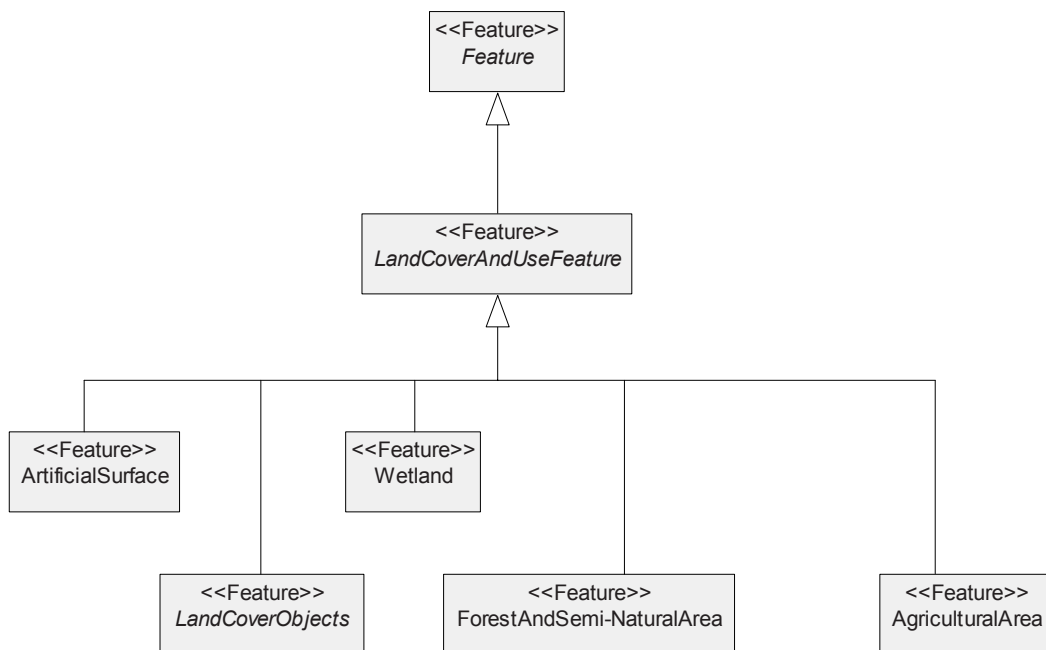

Figure 57 — Generic Conceptual Data Model for Land Cover And Use

6.5.2 Land Cover Objects (abstract)

6.5.2.1 Definition

Land Cover Objects is abstract class of Building, Building Detail, Building Façade, Building Unit, Schematic Building, Block Detail, Town Block, Island, Sidewalk. Land Cover Objects may be complemented by Road And Rail Network And Associated Land Features to represent the areas covered by road or rail objects such as (elevated) freeways, slip roads, or flyovers.

6.5.2.2 Description

See Figure 58. As an abstract class, Land Cover Objects cannot be instantiated.

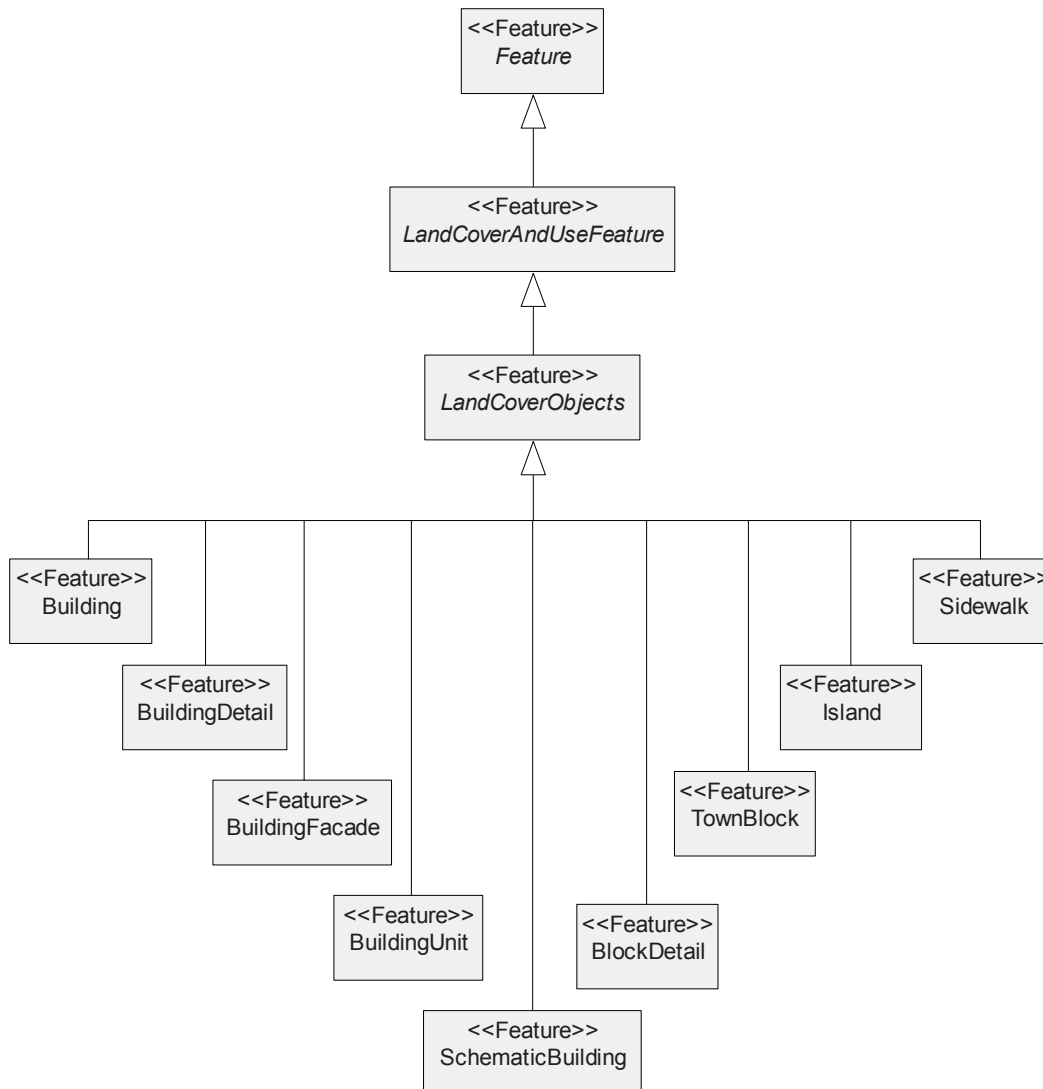

Figure 58 — The Conceptual Data Model for Land Cover And Use: Subtype Land Cover Objects

6.5.3 Building

6.5.3.1 Definition

Man made structure or structures aboveground occupied by people or goods.

6.5.3.2 Description

Building is included to represent the physical presence of these structures. Neighbouring buildings can be grouped into a single Building Feature.

Different Buildings may be linked to each other by means of the Relationships Building linked to Building.

6.5.4 Schematic Building

6.5.4.1 Definition

Simplified or representative building footprint for the normalisation of graphical depiction of certain types of Buildings.

6.5.4.2 Description

Stylised representation to aid visual recognition of (re-)occurrences of a certain type of structure. Schematic Buildings may be aboveground or underground, such as underground train stations without a visual footprint.

6.5.5 Building Unit

6.5.5.1 Definition

A single house or other sub-division of a Building or Schematic Building that has unique characteristics compared to neighbouring Building Units in regards to architectural style and/or addressing.

6.5.5.2 Description

Criteria for the determination of individual, identifiable Building Units include

- the embedding of 2- or 3-dimensional object models associated with (landmark) buildings or structures;
- the sub-division of composite buildings into units with each a uniform architectural style;
- the association with a single address unit (such as a particular house number).

For example, two neighbouring houses with different house numbers will always form two Building Units. Likewise different building structures attached to each other, such as a modern glass office building attached to a medieval brick building, could represent individual Building Units (even if they share the same house number).

6.5.6 Building Detail

6.5.6.1 Definition

The representation of linear shapes that depict prominent construction characteristics of a Building

6.5.6.2 Description

A means to model details of Buildings that are easily recognised as a representative line pattern of the visual (two-dimensional) appearance.

6.5.7 Town Block

6.5.7.1 Definition

The representation of a mesh in the transportation network.

6.5.7.2 Description

A means to model the areas circumscribed by Transportation Elements or other bounding Features. The outline depicts the casements of roadways, traffic islands, railway tracks, shore lines, to name a few examples.

In the case of the road network, the area covered by sidewalks may be part of a Town Block.

Water systems shall be represented by Water Body Features.

6.5.8 Block Detail

6.5.8.1 Definition

The representation of linear shapes that depict prominent characteristics of a Town Block or Water Body.

6.5.8.2 Description

A means to model supporting details of Town Blocks or Water Bodies that aid recognition of representative line pattern of the visual (two-dimensional) appearance, such as accentuation of elevation differences or structural sub-divisions.

6.5.9 Building Façade

6.5.9.1 Definition

The part of the outer surface of a Building that is facing the same direction.

6.5.9.2 Description

The Building Façade is the projection of a perpendicular side view onto a base line. A simple example is a building with a rectangular footprint; this building would have four Building Façades corresponding to each of the four base lines of the rectangle.

6.5.10 Sidewalk

6.5.10.1 Definition

The representation of an area that is dedicated to pedestrians and is located adjacent to the core roadway.

6.5.10.2 Description

Sidewalks are often elevated relative to the roadway, representing the kerbs as delineation, or otherwise delineated by markings or change in surface fabric. Bicycle lanes may be included in the sidewalk representation if their construction or marking more clearly separates it from the core roadway than from the core sidewalk.

6.5.11 Island

6.5.11.1 Definition

An area surrounded by water, possibly connected to other land by means of a bridge or tunnel or accessible by ferry.

6.5.12 Artificial Surface

6.5.12.1 Definition

Surface modified by humans, usually resulting from construction activities, and created to serve dedicated purposes.

6.5.12.2 Description

See figure for the conceptual data model.

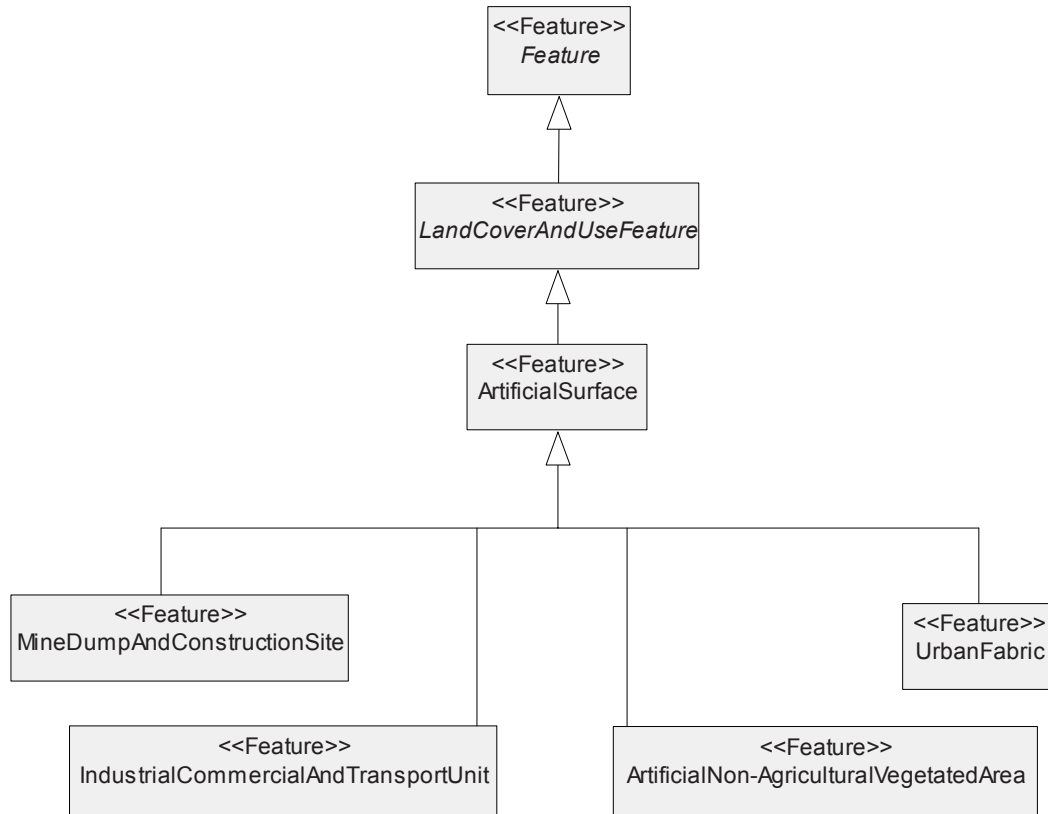

Figure 59 — The Conceptual Data Model for Land Cover And Use: Subtype Artificial Surface

6.5.13 Urban Fabric

6.5.13.1 Definition

Area where most of the land is covered by buildings, roads and artificially surfaced areas. See figure for the conceptual data model.

6.5.13.2 Description

Urban Fabric is a subtype of Artificial Surface. See figure for the conceptual data model.

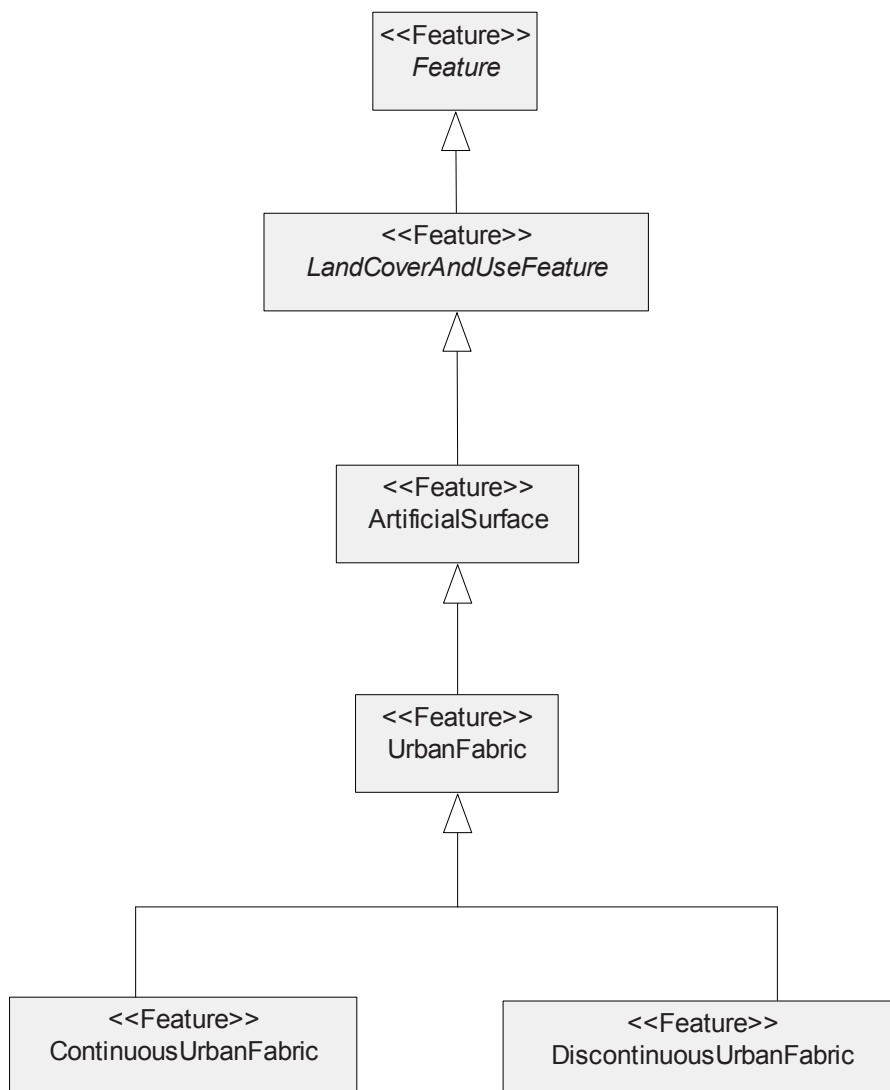

Figure 60 — The Conceptual Data Model for Land Cover And Use: Subtype Urban Fabric

6.5.14 Continuous Urban Fabric

6.5.14.1 Definition

Area where most of the land is covered by structures. Buildings, roads and artificially surfaced areas cover almost all the ground. Non-linear areas of vegetation and bare soil are exceptional.

6.5.14.2 Description

Continuous Urban Fabric is a subtype of Urban Fabric.

6.5.15 Discontinuous Urban Fabric

6.5.15.1 Definition

Area where most of the land is covered by structures. Buildings, roads and artificially surfaced areas associated with vegetated areas and bare soil, which occupy discontinuous but significant surfaces.

6.5.15.2 Description

Discontinuous Urban Fabric is a subtype of Urban Fabric.

6.5.16 Industrial, Commercial And Transport Unit

6.5.16.1 Definition

Artificial surface and infrastructure associated with transportation and/or an industrial activity.

6.5.16.2 Description

Industrial, Commercial And Transport Unit is a subtype of Artificial Surface. See figure for the conceptual data model.

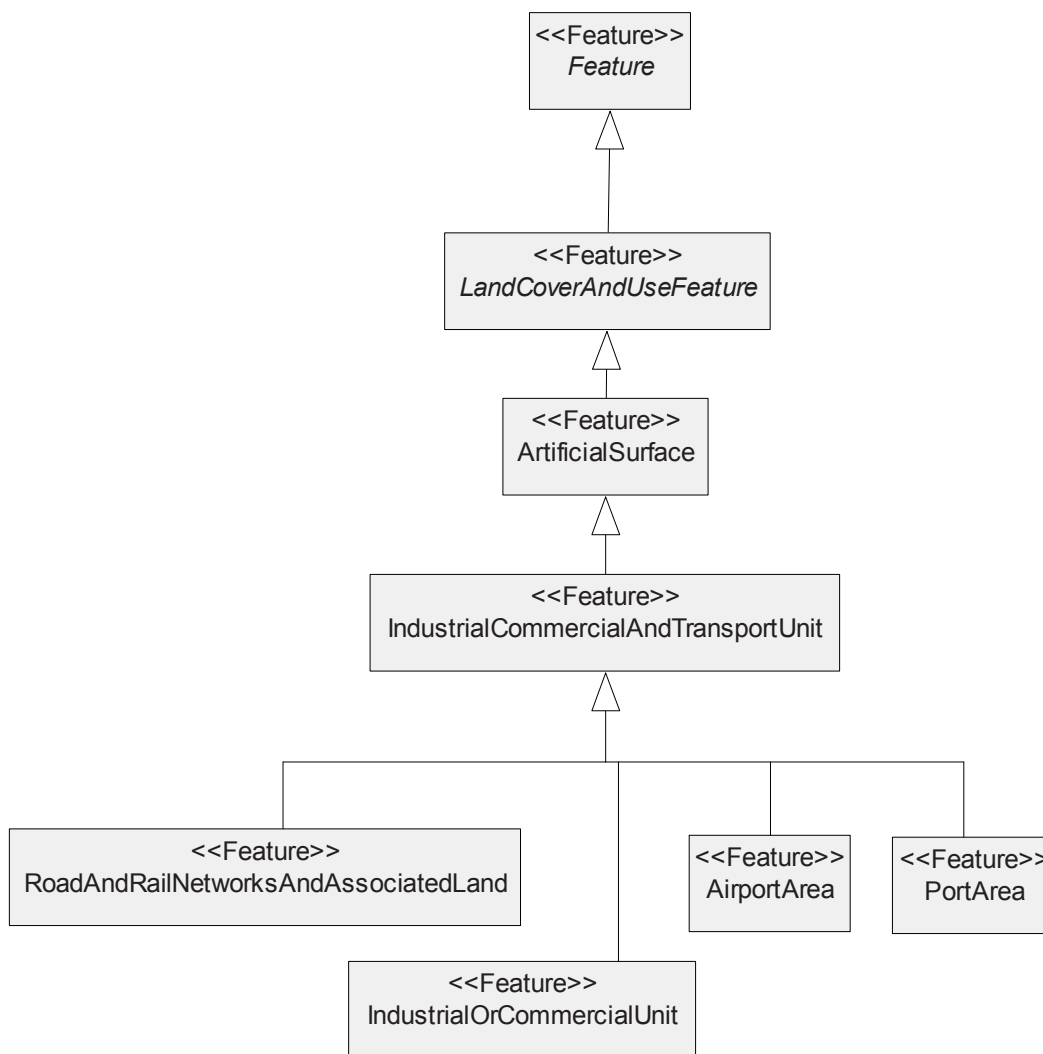

**Figure 61 — The Conceptual Data Model for Land Cover And Use:
 Subtype Industrial, Commercial And Transport Units**

6.5.17 Industrial Or Commercial Unit

6.5.17.1 Definition

Artificially surfaced areas (with concrete, asphalt, tarmacadam, or stabilised, e.g. beaten earth) devoid of vegetation, occupy most of the area in question, which also contains buildings and/or vegetated areas.

6.5.17.2 Description

Industrial Or Commercial Units is a subtype of Industrial, Commercial And Transport Units.

6.5.18 Road And Rail Network And Associated Land

6.5.18.1 Definition

Areas covered with motorways, railways, including associated installations (stations, platforms, embankments).

6.5.18.2 Description

Road And Rail Network And Associated Land is a subtype of Industrial, Commercial And Transport Units.

6.5.19 Port Area

6.5.19.1 Definition

Area covered with infrastructure of port area, including quays, dockyards and marinas.

6.5.19.2 Description

Port Area is a subtype of Industrial, Commercial And Transport Units.

6.5.20 Airport Area

6.5.20.1 Definition

Areas covered with airport installations: runways, buildings and associated land.

6.5.20.2 Description

Airport Area is a subtype of Industrial, Commercial And Transport Units.

6.5.21 Mine, Dump And Construction Site

6.5.21.1 Definition

Surface resulting from excavation, mine dump or landfill.

6.5.21.2 Description

Mine, Dump And Construction Site is a subtype of Artificial Surface. See figure for the conceptual data model.

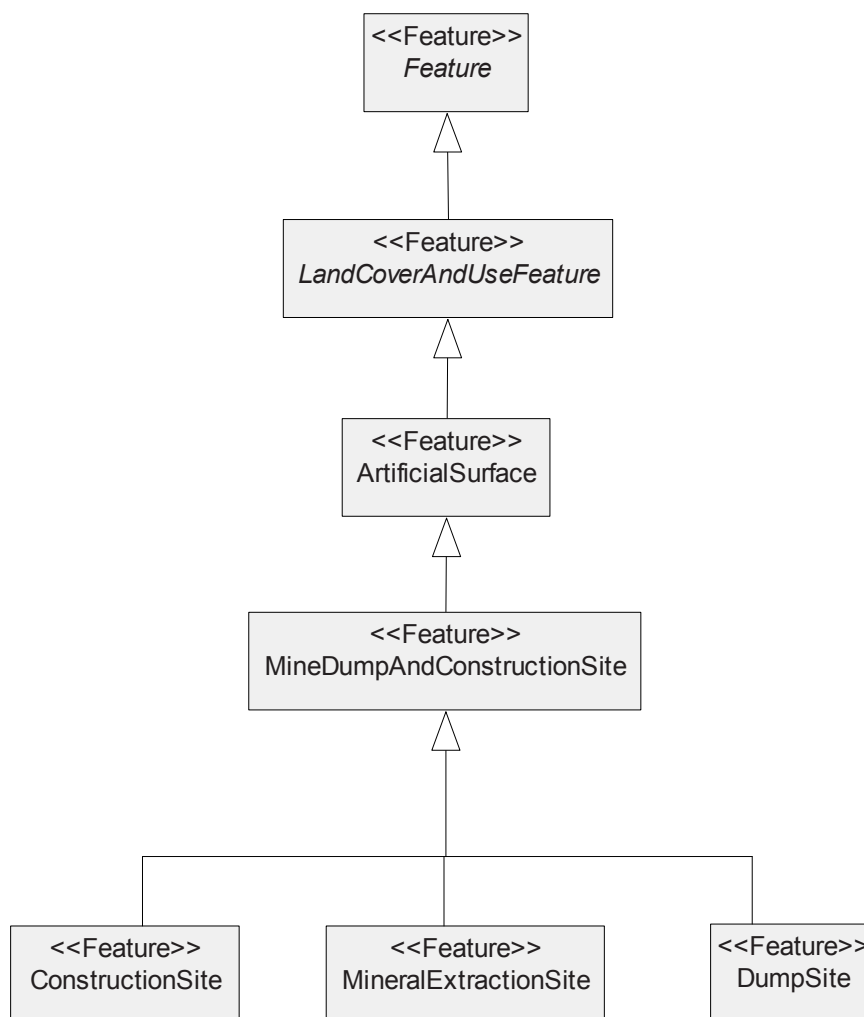

**Figure 62 — The Conceptual Data Model for Land Cover And Use:
Subtype Mine, Dump And Construction Site**

6.5.22 Mineral Extraction Site

6.5.22.1 Definition

Areas with open-pit extraction of industrial minerals (sandpits, quarries) or other minerals (open cast mines). Includes flooded gravel pits, except for river-bed extraction.

6.5.22.2 Description

Mineral Extraction Site is a subtype of Mine, Dump And Construction Site.

6.5.23 Dump Site

6.5.23.1 Definition

Area covered with landfill or mine dump sites, industrial or public.

6.5.23.2 Description

Dump Site is a subtype of Mine, Dump And Construction Site.

6.5.24 Construction Site

6.5.24.1 Definition

Spaces under construction development, soil or bedrock excavations, earthworks.

6.5.24.2 Description

Construction Site is a subtype of Mine, Dump And Construction Site.

6.5.25 Artificial, Non-Agricultural Vegetated Area

6.5.25.1 Definition

Cultivated area with vegetation dedicated to leisure, sports and recreation activities or used as cemetery.

6.5.25.2 Description

Artificial, Non-Agricultural Vegetated Area is a subtype of Artificial Surface. See figure for the conceptual data model.

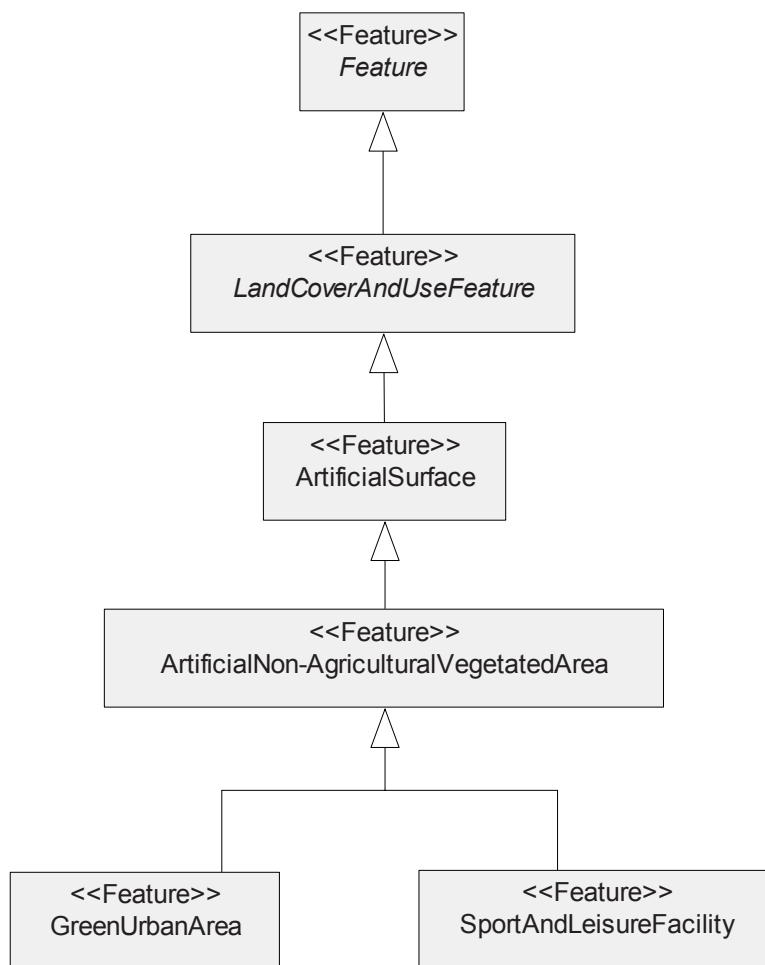

**Figure 63 — The Conceptual Data Model for Land Cover And Use:
Subtype Artificial Non-Agricultural Vegetated Areas**

6.5.26 Green Urban Area

6.5.26.1 Definition

Area with vegetation within urban fabric. Includes parks and cemeteries with vegetation.

6.5.26.2 Description

Green Urban Area is a subtype of Artificial, Non-Agricultural Vegetated Area

6.5.27 Sport And Leisure Facility

6.5.27.1 Definition

Area with camping ground, sports ground, leisure park, golf course, racecourse.

6.5.27.2 Description

Sport And Leisure Facility is a subtype of Artificial, Non-Agricultural Vegetated Area

6.5.28 Agricultural Area

6.5.28.1 Definition

Vegetated area that is cultivated to grow crops or fruits, or used for grazing.

6.5.28.2 Description

See figure for the conceptual data model.

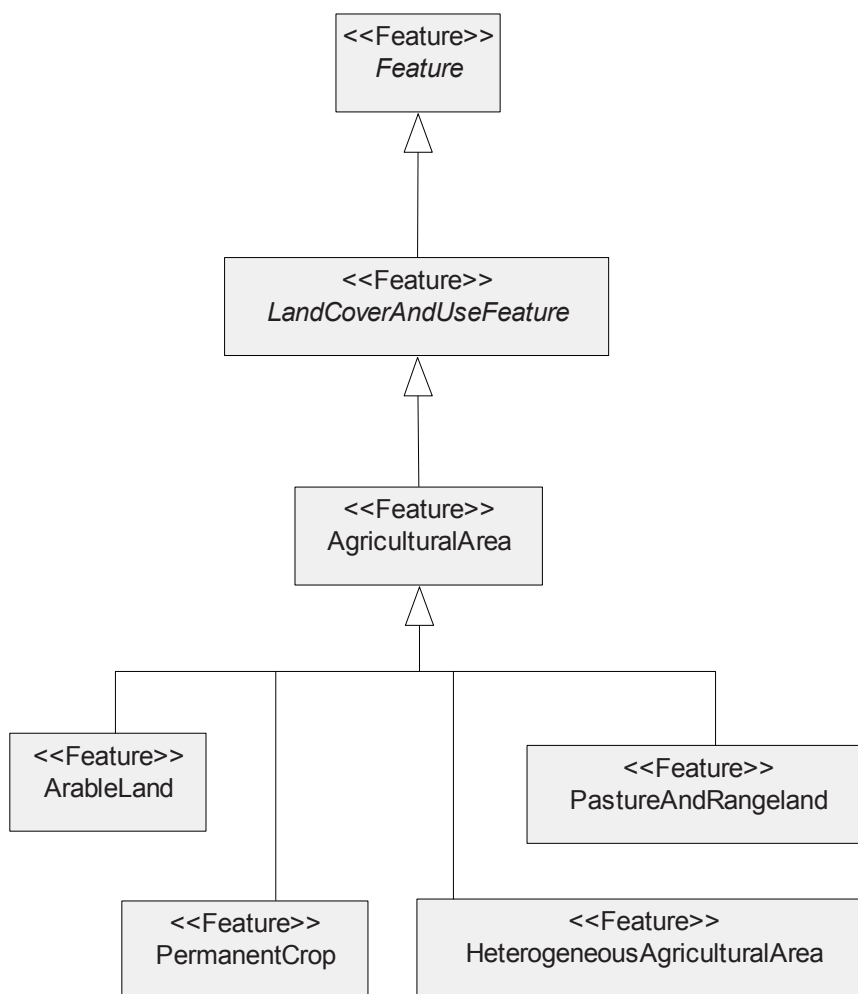

Figure 64 — The Conceptual Data Model for Land Cover And Use: Subtype Agricultural Area

6.5.29 Arable Land

6.5.29.1 Definition

Cultivated area regularly ploughed and generally under a rotation system.

6.5.29.2 Description

Arable Land is a subtype of Agricultural Area. See figure for the conceptual data model.

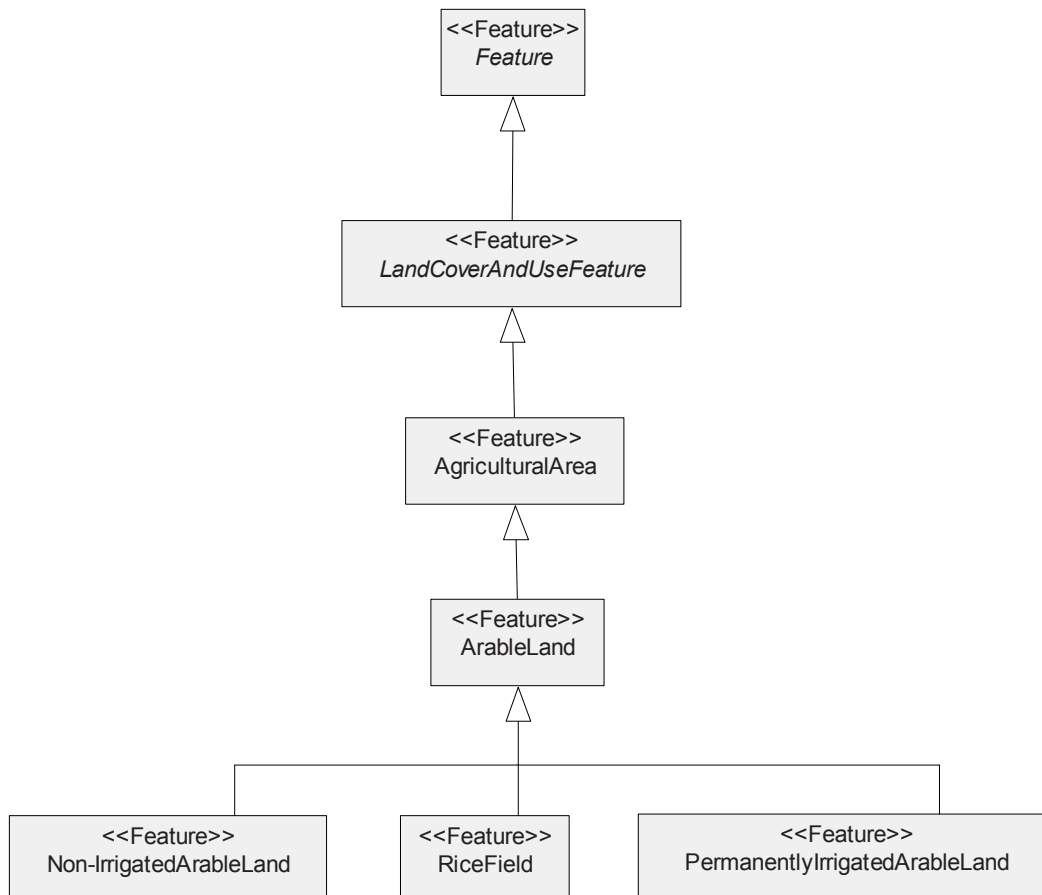

Figure 65 — The Conceptual Data Model for Land Cover And Use: Subtype Arable Land

6.5.30 Non-Irrigated Arable Land

6.5.30.1 Definition

Cereals, legumes, fodder crops, root crops and fallow land. Includes flower and tree (nurseries) cultivation and vegetables, whether open field, under plastic or glass (includes market gardening). Includes aromatic, medicinal and culinary plants. Excludes permanent pastures.

6.5.30.2 Description

Non-Irrigated Arable Land is a subtype of Arable Land.

6.5.31 Permanently Irrigated Land

6.5.31.1 Definition

Crops irrigated permanently and periodically, using a permanent infrastructure (irrigation channels, drainage network). Most of these crops could not be cultivated without an artificial water supply. Does not include sporadically irrigated land.

6.5.31.2 Description

Permanently Irrigated Land is a subtype of Arable Land.

6.5.32 Rice Field

6.5.32.1 Definition

Land developed for rice cultivation. Flat surfaces with irrigation channels. Surfaces regularly flooded.

6.5.32.2 Description

Rice field is a subtype of Arable land.

6.5.33 Permanent Crop

6.5.33.1 Definition

Crops not under a rotation system which provide repeated harvests and occupy the land for a long period before it is ploughed and replanted: mainly plantations of woody crops. Excludes pastures, grazing lands and forests.

6.5.33.2 Description

Permanent Crop is a subtype of Agricultural Area. See figure for the conceptual data model.

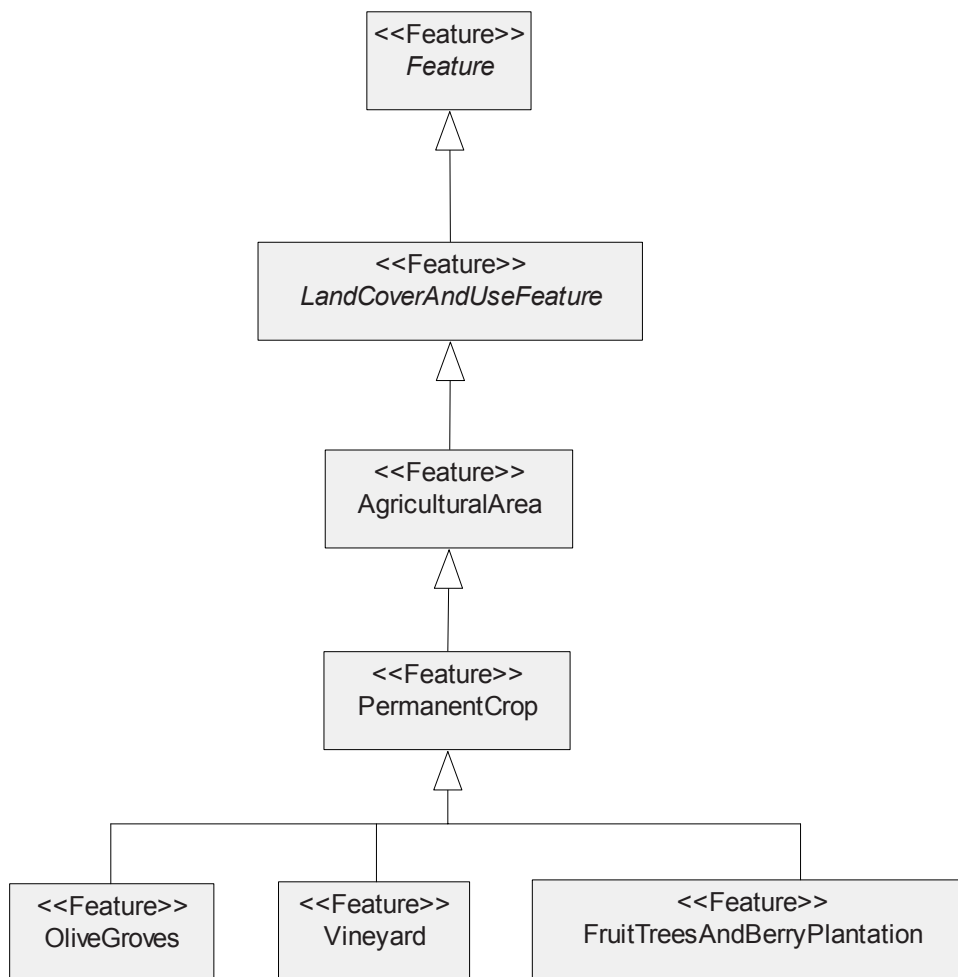

Figure 66 — The Conceptual Data Model for Land Cover And Use: Subtype Permanent Crop

6.5.34 Vineyard

6.5.34.1 Definition

Area planted with vines.

6.5.34.2 Description

Vineyard is a subtype of Permanent Crop.

6.5.35 Fruit Trees And Berry Plantation

6.5.35.1 Definition

Parcels planted with fruit trees or shrubs: single or mixed fruit species, fruit trees associated with permanently grassed surfaces. Includes chestnut and walnut groves.

6.5.35.2 Description

Fruit Trees And Berry Plantations is a subtype of Permanent crops.

6.5.36 Olive Grove

6.5.36.1 Definition

Areas planted with olive trees, including mixed occurrence of olive trees and vines on the same parcel.

6.5.36.2 Description

Olive Grove is a subtype of Permanent Crop.

6.5.37 Pasture And Rangeland

6.5.37.1 Definition

Grassland area, usually used for grazing.

6.5.37.2 Description

Pasture And Rangeland is a subtype of Agricultural Area. See figure for the conceptual data model.

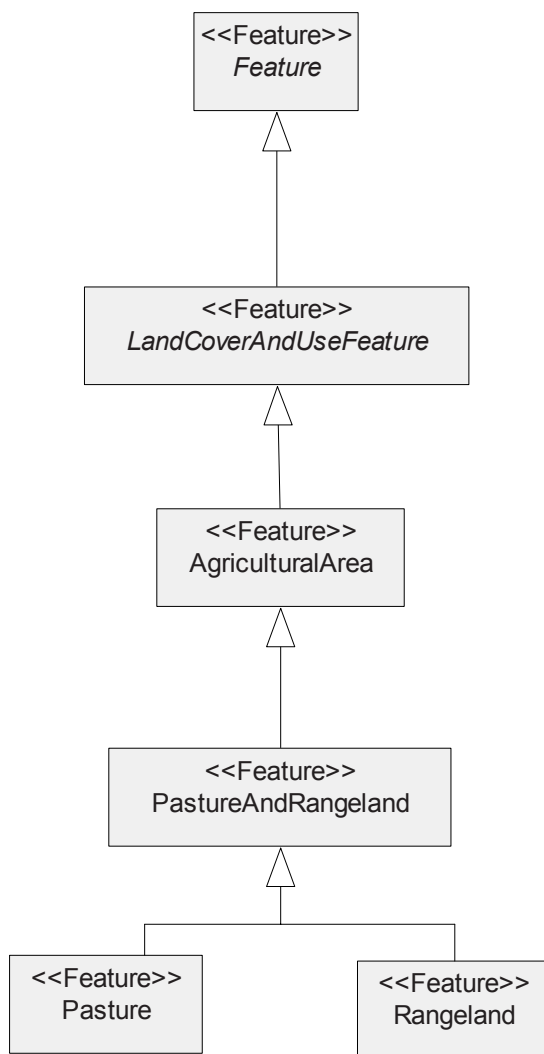

Figure 67 — The Conceptual Data Model for Land Cover And Use: Subtype Pasture And Rangeland

6.5.38 Pasture

6.5.38.1 Definition

Dense, predominantly graminoid grass cover, of floral composition, not under a rotation system. Mainly used for grazing, but the fodder may be harvested mechanically. Includes areas with hedges (bocage).

6.5.38.2 Description

Pasture is a subtype of Pasture And Rangeland.

6.5.39 Rangeland

6.5.39.1 Definition

Spatially extensive area of natural grass cover, usually short grass in semi-arid climates, on which ruminants are allowed to graze freely.

6.5.39.2 Description

Rangeland is a subtype of Pastures And Rangeland.

6.5.40 Heterogeneous Agricultural Area

6.5.40.1 Definition

Partly or fully cultivated area with crops or pastures next to other vegetation such as trees.

6.5.40.2 Description

Heterogeneous Agricultural Area is a subtype of Agricultural area. See figure for the conceptual data model.

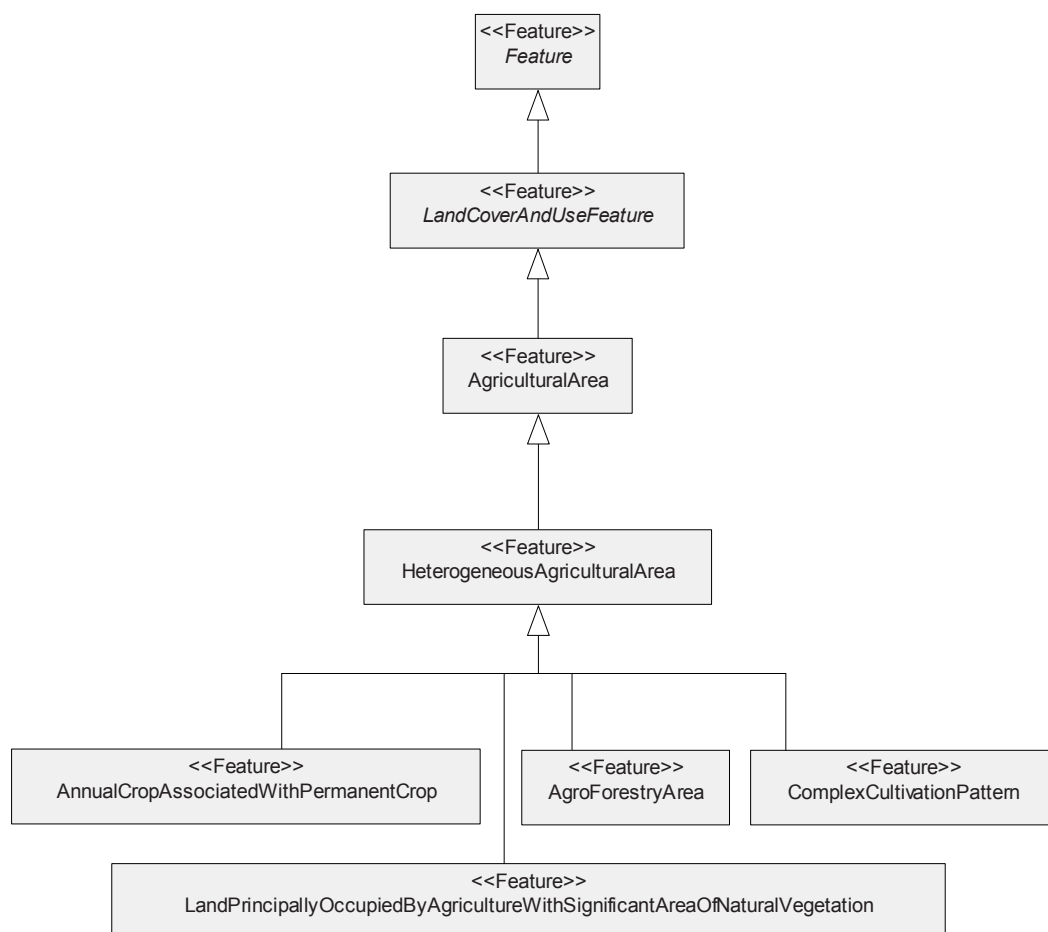

Figure 68 — The Conceptual Data Model for Land Cover And Use: Subtype Heterogeneous Agricultural Area

6.5.41 Annual Crop Associated With Permanent Crop

6.5.41.1 Definition

Non-Permanent Crop (Arable Land or Pasture) associated with Permanent Crop on the same parcel.

6.5.41.2 Description

Annual Crop associated with Permanent Crop is a subtype of Heterogeneous Agricultural Area.

6.5.42 Complex Cultivation Pattern

6.5.42.1 Definition

Juxtaposition of small parcels of diverse annual crops, pasture and/or permanent crops.

6.5.42.2 Description

Complex Cultivation Pattern is a subtype of Heterogeneous Agricultural Area.

6.5.43 Land Principally Occupied By Agriculture With Significant Area Of Natural Vegetation

6.5.43.1 Definition

Areas principally occupied by agriculture, interspersed with significant natural areas.

6.5.43.2 Description

Land Principally Occupied By Agriculture With Significant Area Of Natural Vegetation is a subtype of Heterogeneous Agricultural Area.

6.5.44 Agro-Forestry area

6.5.44.1 Definition

Annual crops of grazing land under the wooded cover of forestry species.

6.5.44.2 Description

Agro-Forestry Area is a subtype of Heterogeneous Agricultural Area.

6.5.45 Forest And Semi-Natural Area

6.5.45.1 Definition

Vegetated area covered with trees and/or bushy vegetation.

6.5.45.2 Description

See figure for the conceptual data model.

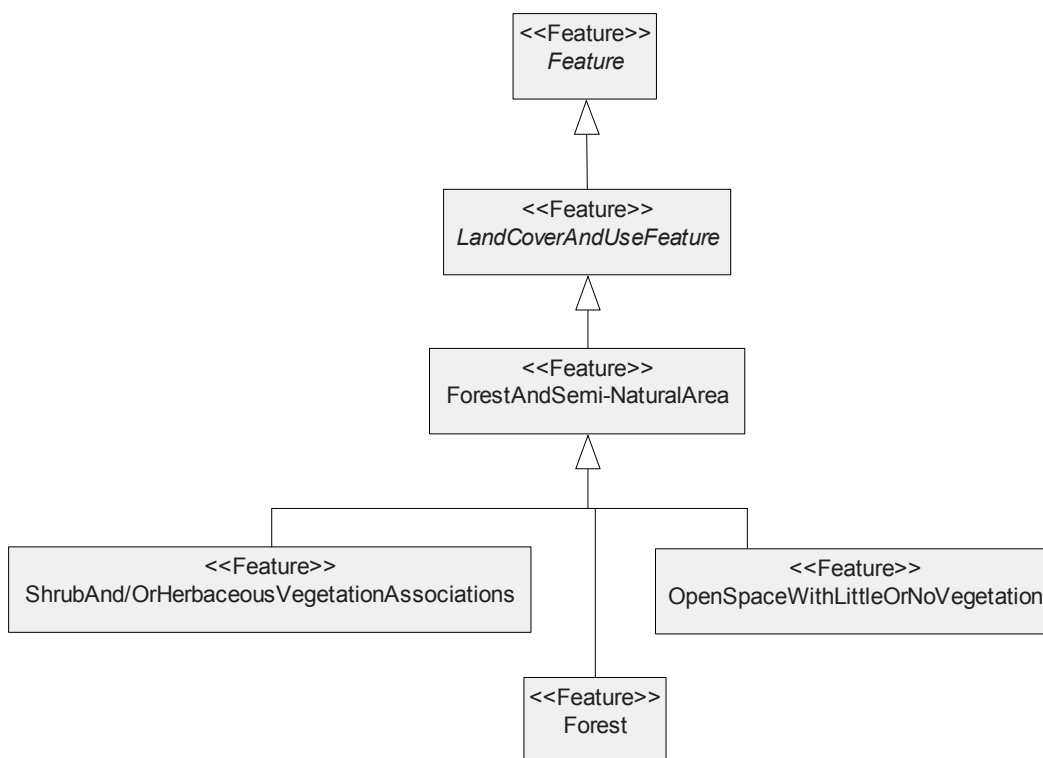

**Figure 69 — The Conceptual Data Model for Land Cover And Use:
 Subtype Forest And Semi-Natural Area**

6.5.46 Forest

6.5.46.1 Definition

Vegetation formation composed principally of trees, including shrub and bush understories.

6.5.46.2 Description

Forest is a subtype of Forest And Semi-Natural Area. See figure for the conceptual data model.

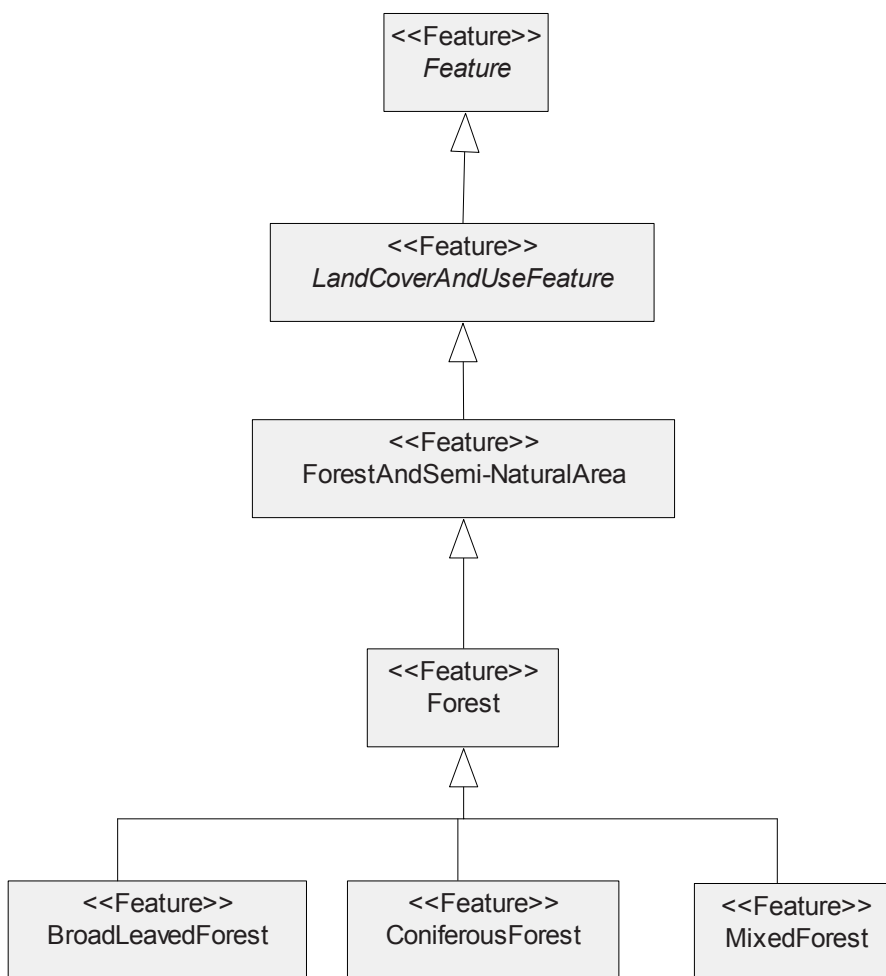

**Figure 70 — The Conceptual Data Model for Land Cover And Use:
Subtype Forest**

6.5.47 Broad-Leaved Forest

6.5.47.1 Definition

Vegetation formation composed principally of trees, including shrub and bush understories, where broad-leaved species predominate.

6.5.47.2 Description

Broad-Leaved Forest is a subtype of Forest.

6.5.48 Coniferous Forest

6.5.48.1 Definition

Vegetation formation composed principally of trees, including shrub and bush understories, where coniferous species predominate.

6.5.48.2 Description

Coniferous Forest is a subtype of Forest.

6.5.49 Mixed Forest

6.5.49.1 Definition

Vegetation formation composed principally of trees, including shrub and bush understories, where broad-leaved and coniferous species co-dominate.

6.5.49.2 Description

Mixed Forest is a subtype of Forest.

6.5.50 Scrub And/Or Herbaceous Vegetation Association

6.5.50.1 Definition

Bushy vegetation, generally with low cover and with no or scattered trees.

6.5.50.2 Description

Scrub And/Or Herbaceous Vegetation Association is a sub-type of Forest And Semi-Natural Area. See figure for the conceptual data model.

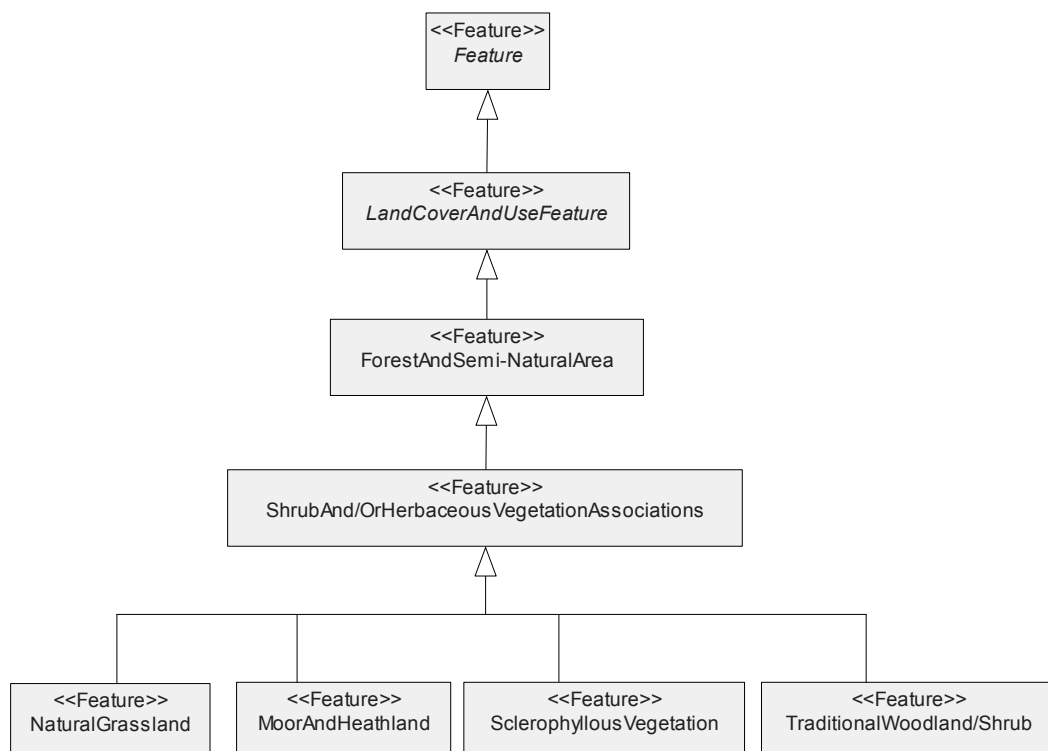

**Figure 71 — The Conceptual Data Model for Land Cover And Use:
Subtype Scrub And/Or Herbaceous Vegetation Association**

6.5.51 Natural Grassland

6.5.51.1 Definition

Low productivity grassland. Often situated in areas of rough uneven ground. Frequently includes rocky areas, briars and heathland.

6.5.51.2 Description

Natural Grassland is a sub-type of Scrub And/Or Herbaceous Vegetation Association.

6.5.52 Moor And Heathland

6.5.52.1 Definition

Vegetation with low and closed cover, dominated by bushes, shrubs and herbaceous plants (heath, briars, broom, gorse, laburnum, etc.).

6.5.52.2 Description

Moor And Heathland is a sub-type of Scrub And/Or Herbaceous Vegetation Association.

6.5.53 Sclerophyllous vegetation

6.5.53.1 Definition

Bushy sclerophyllous vegetation. Includes maquis and garrigue.

Maquis: a dense vegetation composed of numerous shrubs associated with siliceous soils in the Mediterranean environment.

Garrigue: discontinuous bushy associations of Mediterranean calcareous plateaus. Generally composed of kermes oaks, arbutus, lavender, thyme, cistus, etc. May include a few isolated trees.

6.5.53.2 Description

Sclerophyllous Vegetation is a sub-type of Scrub And/Or Herbaceous Vegetation Association.

6.5.54 Transitional Woodland/Scrub

6.5.54.1 Definition

Bushy or herbaceous vegetation with scattered trees. Can represent either woodland degradation or forest regeneration/colonization.

6.5.54.2 Description

Transitional Woodland/Scrub is a sub-type of Scrub And/Or Herbaceous Vegetation Association.

6.5.55 Open Space With Little Or No Vegetation

6.5.55.1 Definition

Area with little or no vegetation, such as sandy or rocky areas, permanent ice or snow, or sparsely vegetated high altitude areas.

6.5.55.2 Description

Open Space With Little Or No Vegetation is a sub-type of Forest And Semi-Natural Area. See figure for the conceptual data model.

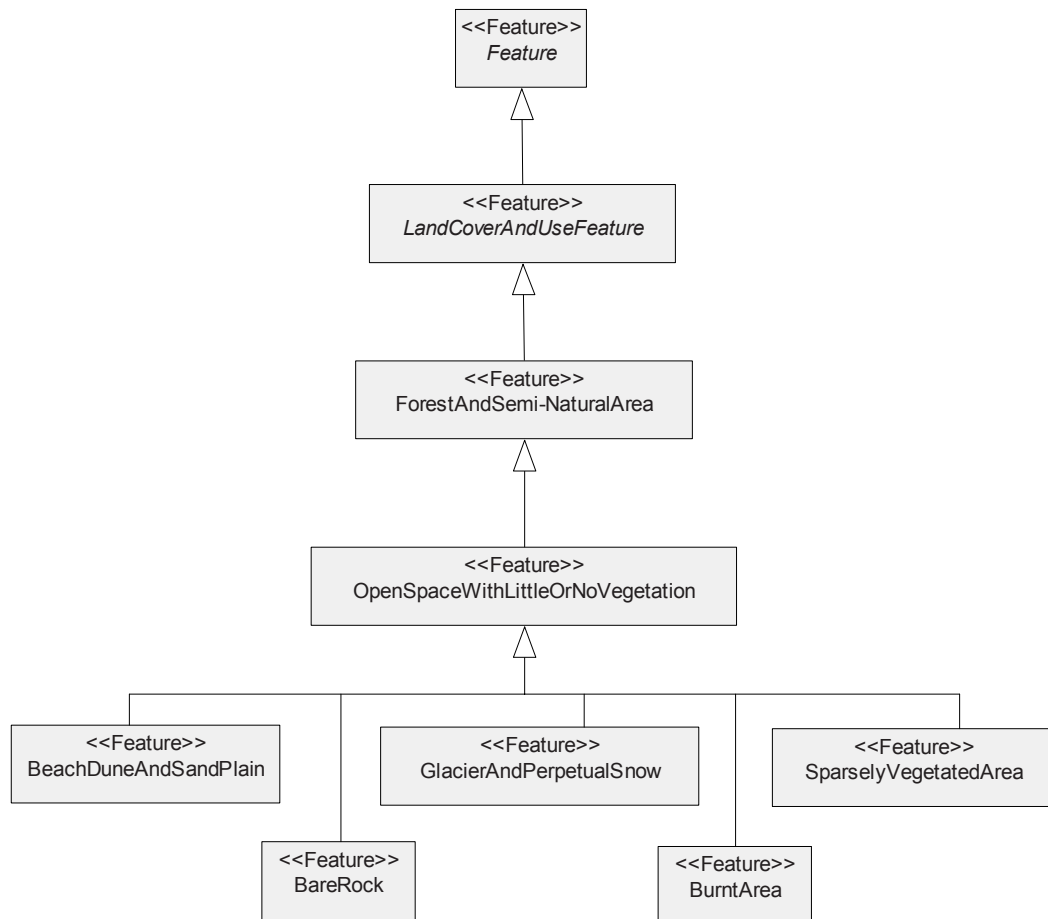

**Figure 72 — The Conceptual Data Model for Land Cover And Use:
 Subtype Open Space With Little Or No Vegetation**

6.5.56 Beach, Dune And Sand Plain

6.5.56.1 Definition

Beaches, dunes and expanses of sand or pebbles in coastal or continental locations, including beds of stream channels with torrential regime.

6.5.56.2 Description

Beach, Dune And Sand Plain is a sub-type of Open Space With Little Or No Vegetation.

6.5.57 Bare Rock

6.5.57.1 Definition

Scree, cliffs, rocks and outcrops.

6.5.57.2 Description

Bare Rock is a sub-type of Open Space With Little Or No Vegetation.

6.5.58 Sparsely Vegetated Area

6.5.58.1 Definition

Includes steppes, tundra and badlands. Scattered high-altitude vegetation.

6.5.58.2 Description

Sparsely Vegetated Area is a sub-type of Open Space With Little Or No Vegetation.

6.5.59 Burnt Area

6.5.59.1 Definition

Areas affected by recent fires, still mainly black.

6.5.59.2 Description

Burnt Area is a sub-type of Open Space With Little Or No Vegetation.

6.5.60 Glacier And Perpetual Snow

6.5.60.1 Definition

Land covered by glaciers or permanent snowfields.

6.5.60.2 Description

Glacier And Perpetual Snow is a sub-type of Open Space With Little Or No Vegetation.

6.5.61 Wetland

6.5.61.1 Definition

Inland or coastal area seasonally, tidally or permanently waterlogged.

6.5.61.2 Description

See figure for the conceptual data model.

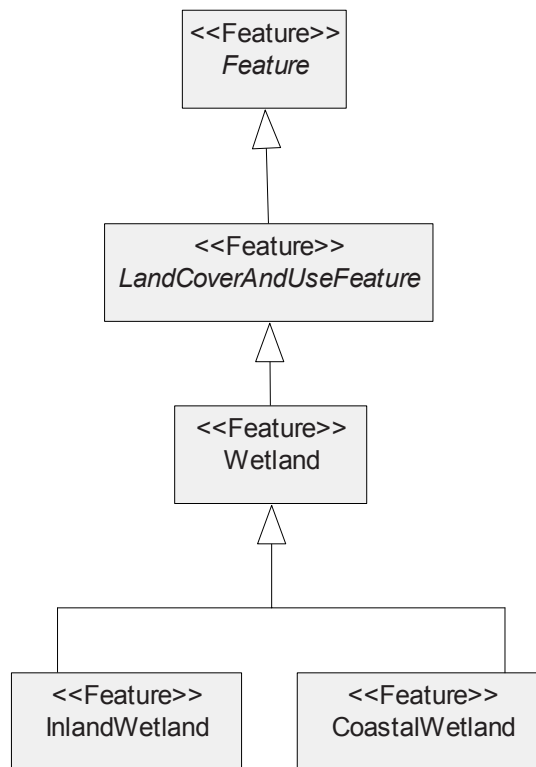

Figure 73 — The Conceptual Data Model for Land Cover And Use: Subtype Wetland

6.5.62 Inland Wetland

6.5.62.1 Definition

Forested or non-forested areas either partially, seasonally or permanently waterlogged. The water may be stagnant or circulating.

6.5.62.2 Description

Inland Wetland is a sub-type of Wetland. See figure for the conceptual data model.

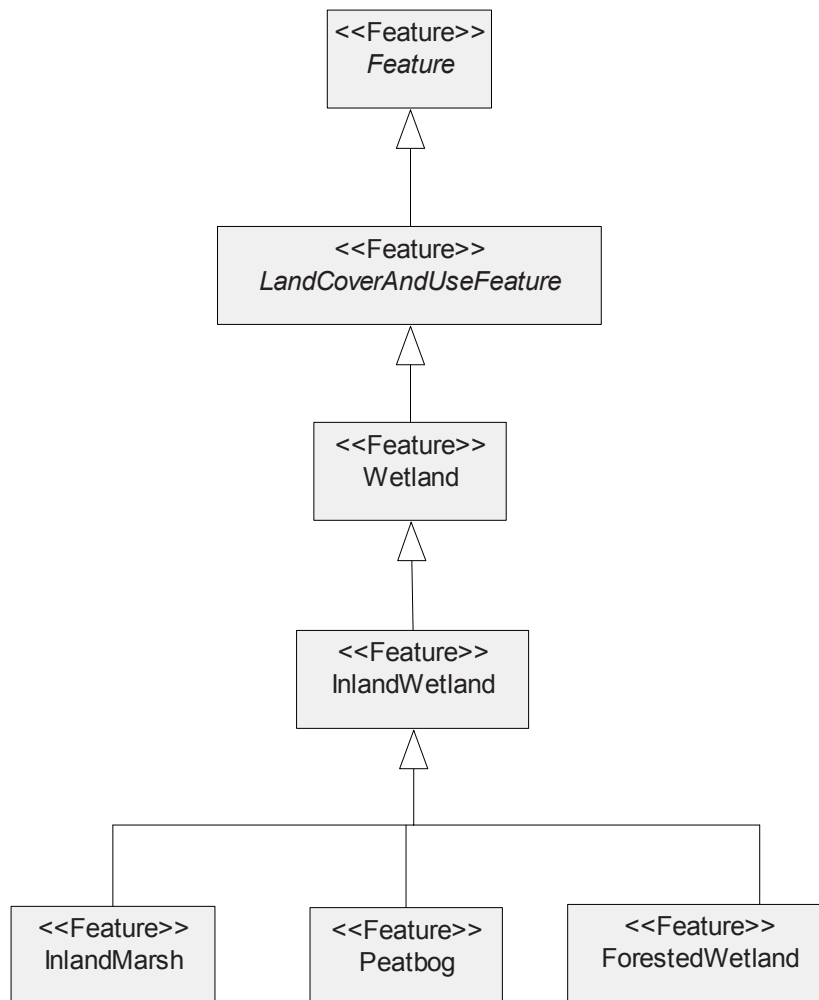

Figure 74 — The Conceptual Data Model for Land Cover And Use: Subtype Inland Wetland

6.5.63 Inland Marsh

6.5.63.1 Definition

Low-lying land usually flooded in winter, and more or less saturated by water all year round.

6.5.63.2 Description

Inland Marsh is a sub-type of Inland Wetland.

6.5.64 Peatbog

6.5.64.1 Definition

Peatland consisting mainly of decomposed moss and vegetable matter. May or may not be exploited.

6.5.64.2 Description

Peatbog is a sub-type of Inland Wetland.

6.5.65 Forested Wetland

6.5.65.1 Definition

Low-lying forested or partially forested land often flooded, and with stagnant or circulating water most of the year.

6.5.65.2 Description

Forested Wetland is a sub-type of Inland Wetland.

6.5.66 Coastal Wetland

6.5.66.1 Definition

Non-wooded areas either tidally, seasonally or permanently waterlogged with brackish or saline water.

6.5.66.2 Description

Coastal Wetland is a sub-type of Wetlands. See figure for the conceptual data model.

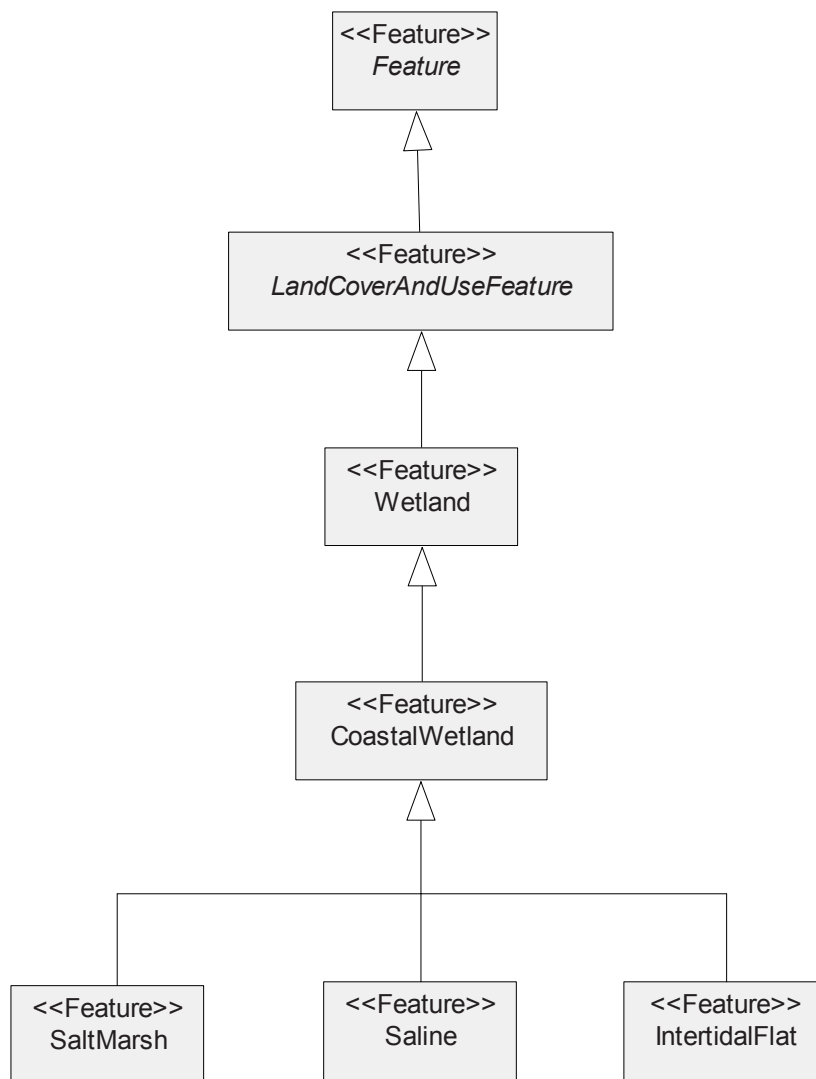

Figure 75 — The Conceptual Data Model for Land Cover And Use: Subtype Coastal Wetland

6.5.67 Salt marsh

6.5.67.1 Definition

Vegetated low-lying areas, above the high-tide line, susceptible to flooding by sea water. Often in the process of filling in, gradually being colonized by halophilic plants.

6.5.67.2 Description

Salt Marsh is a sub-type of Coastal Wetland.

6.5.68 Saline

6.5.68.1 Definition

Salt-plants, active or in process of abandonment. Sections of salt marsh exploited for the production of salt by evaporation. They are clearly distinguishable from the rest of the marsh by their segmentation and embankment system.

6.5.68.2 Description

Saline is a sub-type of Coastal Wetland.

6.5.69 Intertidal flat

6.5.69.1 Definition

Generally unvegetated expanses of mud, sand or rock lying between high and low water-marks.

6.5.69.2 Description

Intertidal flat is a sub-type of Coastal Wetland.

6.6 Terrain Elevation

6.6.1 General overview

Terrain elevation is represented by means of discrete terrain height measurements, either measured or calculated, in-between which a whole coverage of terrain heights can be interpolated and approximated in order to model the morphology of the earth's surface.

See Figure 76 for the data model for Terrain Elevation Features.

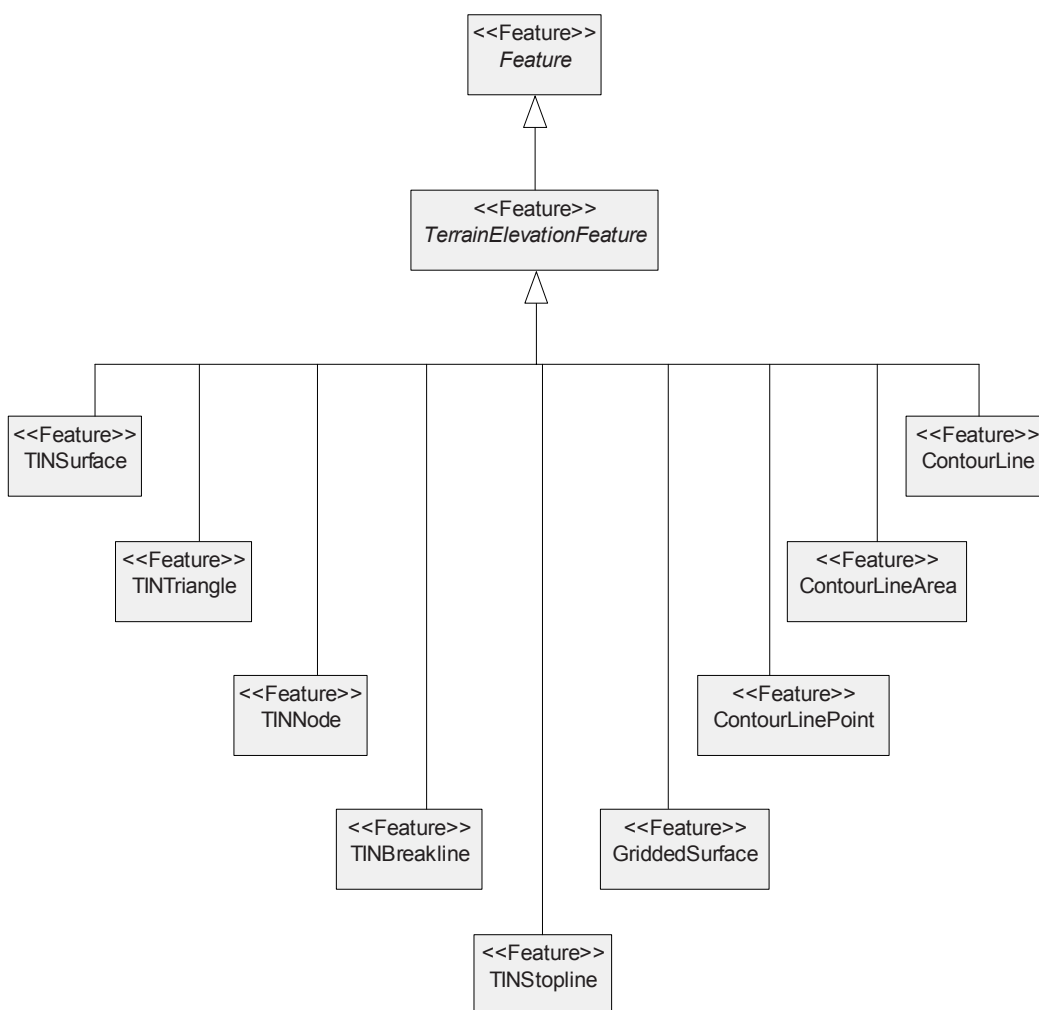

Figure 76 — The Conceptual Data Model for Terrain Elevation Features

Alternative modelling approaches are supported (see figures Figure 77, Figure 78, Figure 79 and Figure 80 for examples):

1. (full) TIN (Triangular Irregular Network): tessellation of the terrain's surface into triangular areas, each with constant slope approximating the terrain

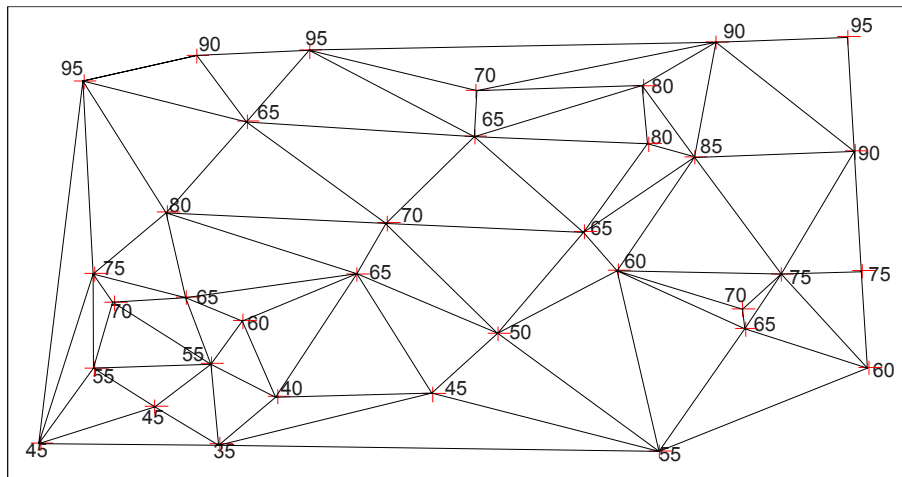

Figure 77 – Example of (full) TIN terrain elevation representation

2. (reduced) TIN: representation of topographic surface essentials (Nodes/Breaklines/Stoplines)

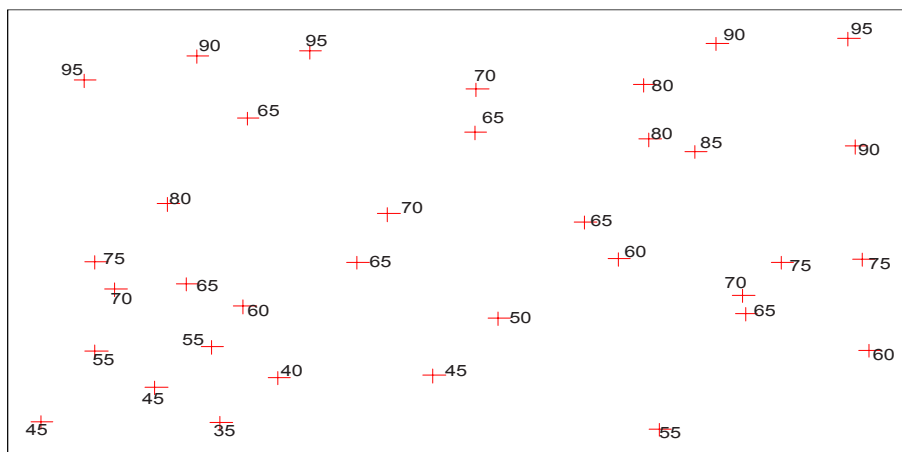

Figure 78 – Example of reduced TIN representation in terms of TIN Nodes

3. Contour lines: a virtual path across the terrain following a constant terrain height

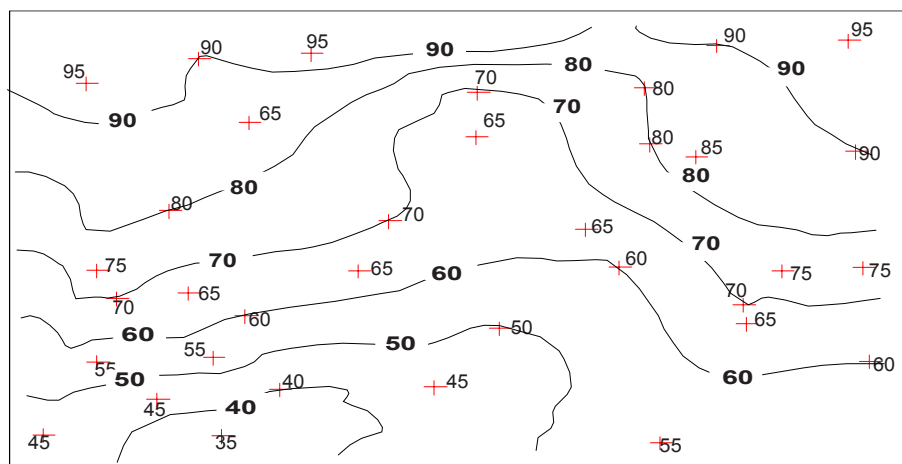

Figure 79 – Example of contour line representation

4. Grid: array of height points (raster data of coordinate triplets)

9 5	9 0	9 5	9 0	8 5	8 2	8 8	9 3
9 0	8 8	8 0	7 0	6 7	7 5	8 4	9 0
8 4	8 2	7 8	7 0	6 5	7 2	8 1	8 5
7 8	7 3	7 0	6 5	6 1	6 4	7 0	7 7
6 9	6 4	6 0	5 8	5 4	5 6	6 6	6 9
5 2	5 0	4 5	4 4	4 8	5 3	6 0	5 9
4 3	3 7	3 7	4 2	4 7	5 2	5 5	5 5

Figure 80 – Example of gridded terrain elevation representation

6.6.2 TIN Surface

6.6.2.1 Definition

Triangular Irregular Network (TIN) representation of the earth's surface which is composed of triangular areas approximating the slope of the terrain.

6.6.2.2 Description

A TIN is derived from TIN Nodes, taking into account TIN Breaklines and TIN Stoplines (using Delauney algorithm or a similar algorithm). TIN Triangles are implicit components of a TIN Surface.

6.6.3 TIN Triangle

6.6.3.1 Definition

A single triangular area with constant slope approximating the terrain.

6.6.3.2 Description

A TIN Triangle is (implicitly) determined by three TIN Nodes. (Part of) the outline of a triangle composing the TIN may coincide with a TIN Breakline.

6.6.4 TIN Node

6.6.4.1 Definition

Representative terrain point associated with a terrain height.

6.6.4.2 Description

A TIN Node represents a location at which the terrain's slope is changing.

6.6.5 TIN Breakline

6.6.5.1 Definition

Representation of a local ridge or depression in the terrain across which interpolation between TIN Nodes is not applicable.

6.6.5.2 Description

A TIN Breakline is included in the TIN composition in terms of triangle borders.

6.6.6 TIN Stopleveline

6.6.6.1 Definition

A line where the local continuity or regularity of the surface is questionable und across which interpolation between TIN Nodes is not applicable.

6.6.6.2 Description

A TIN Stopleveline may lead to holes in a TIN by locally breaking its triangular nature.

6.6.7 Contour Line

6.6.7.1 Definition

A virtual path across the terrain following a constant terrain height.

6.6.7.2 Description

By their nature, Contour Lines do not cross each other.

If they form a loop (such as surrounding a mountain), they are modelled as a Contour Line Area.

6.6.8 Contour Line Area

6.6.8.1 Definition

A Contour Line forming a loop.

6.6.8.2 Description

A Contour Line Area may be represented by a Contour Line Point is its spatial extent is minimal.

6.6.9 Contour Line Point

6.6.9.1 Definition

A point representing the terrain height.

6.6.9.2 Description

A Contour Line Point is a Contour Line (Area) collapsed into a single point.

6.6.10 Gridded Surface

6.6.10.1 Definition

An array of height points organized as a spatial grid.

6.6.10.2 Description

The Gridded Surface Feature represents the quadrangular bounding box of the grid array. The actual height data is attached using the Multi-Media File Attachment Attribute and dedicated file formats, such as GeoTIFF.

6.7 Structures

6.7.1 General overview

Structures are used to describe significant constructions that are part of a transportation network. Structures may relate to just one Transportation Element, or may form a grade separated crossing between two Transportation Elements. This aspect of a structure is expressed in the Relationship in which it takes part.

EXAMPLE Bridges, viaducts, tunnels, aquaducts, cuttings, galleries or retaining walls.

Figure 81 illustrates the Data Model for Structures.

6.7.2 Structure

6.7.2.1 Definition

A Structure is a significant construction that is part of a transportation network, such as a bridge, a tunnel or a retaining wall.

6.7.2.2 Types of Structures

A Structure Feature can be classified with the Structure Type Attribute.

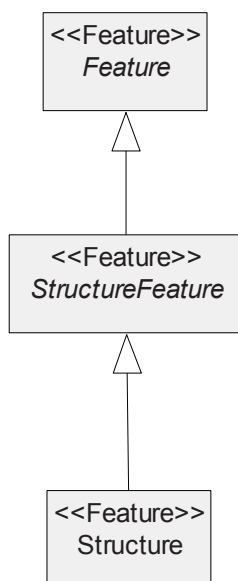

Figure 81 — The Conceptual Data Model for Structures

6.8 Railways

6.8.1 General overview

Railways are similar to roads in that their constituent elements together form a network. A railway network may therefore be considered to be made up of a number of Railway Elements that are connected by means of Railway Element Junctions. Figure 82 illustrates the Data Model for Railways

6.8.2 Railway Element

6.8.2.1 Definition

A permanent way having one or more tracks that are or can be used for trains.

6.8.2.2 Description

A Railway Element is the smallest independent part of the railway network, and is bounded by two Railway Element Junctions.

6.8.3 Railway Element Junction

6.8.3.1 Definition

The location where three or more Railway Elements meet or where a Railway Element ends.

6.8.3.2 Description

Railway Element Junctions are located where three or more Railway Elements join or where one Railway Element ends.

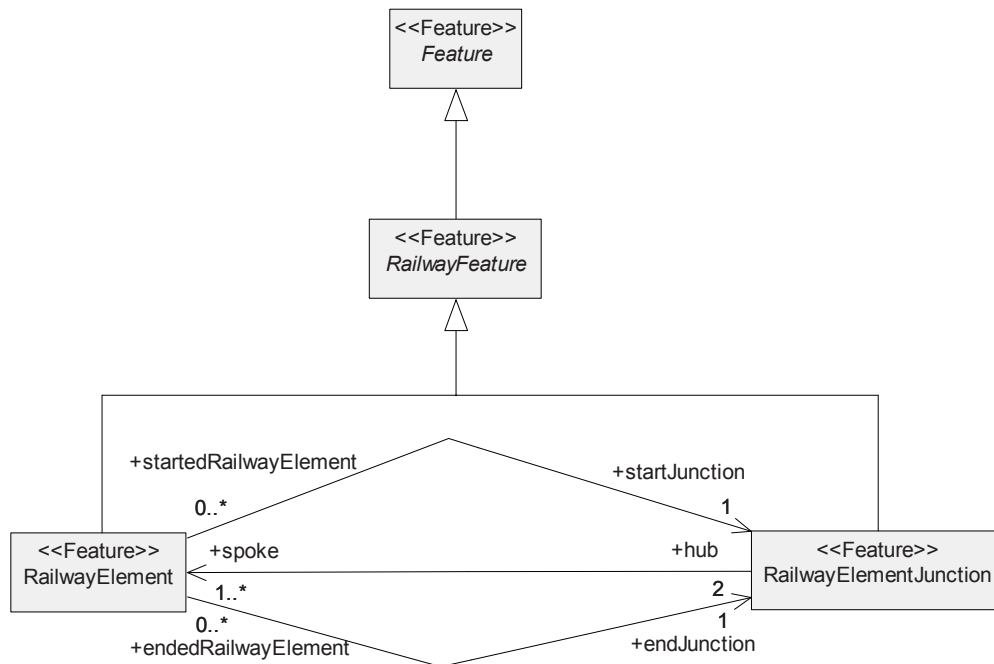

Figure 82 — The Conceptual Data Model for Railways

6.9 Waterways

6.9.1 General overview

The Waterway Feature Theme contains the representation of Water Bodies. Waterway Features are composed of Water Bodies and water boundaries. Water Bodies may be connected to other Water Bodies or they may be isolated Water Bodies have an hierarchical structure. Water boundaries are represented by Water Boundary Elements and Water Boundary Junctions. A Water Boundary Element describes the outline of the water surface and connects two Water Boundary Junctions.

Figure 83 illustrates the Conceptual Data Model for Waterways.

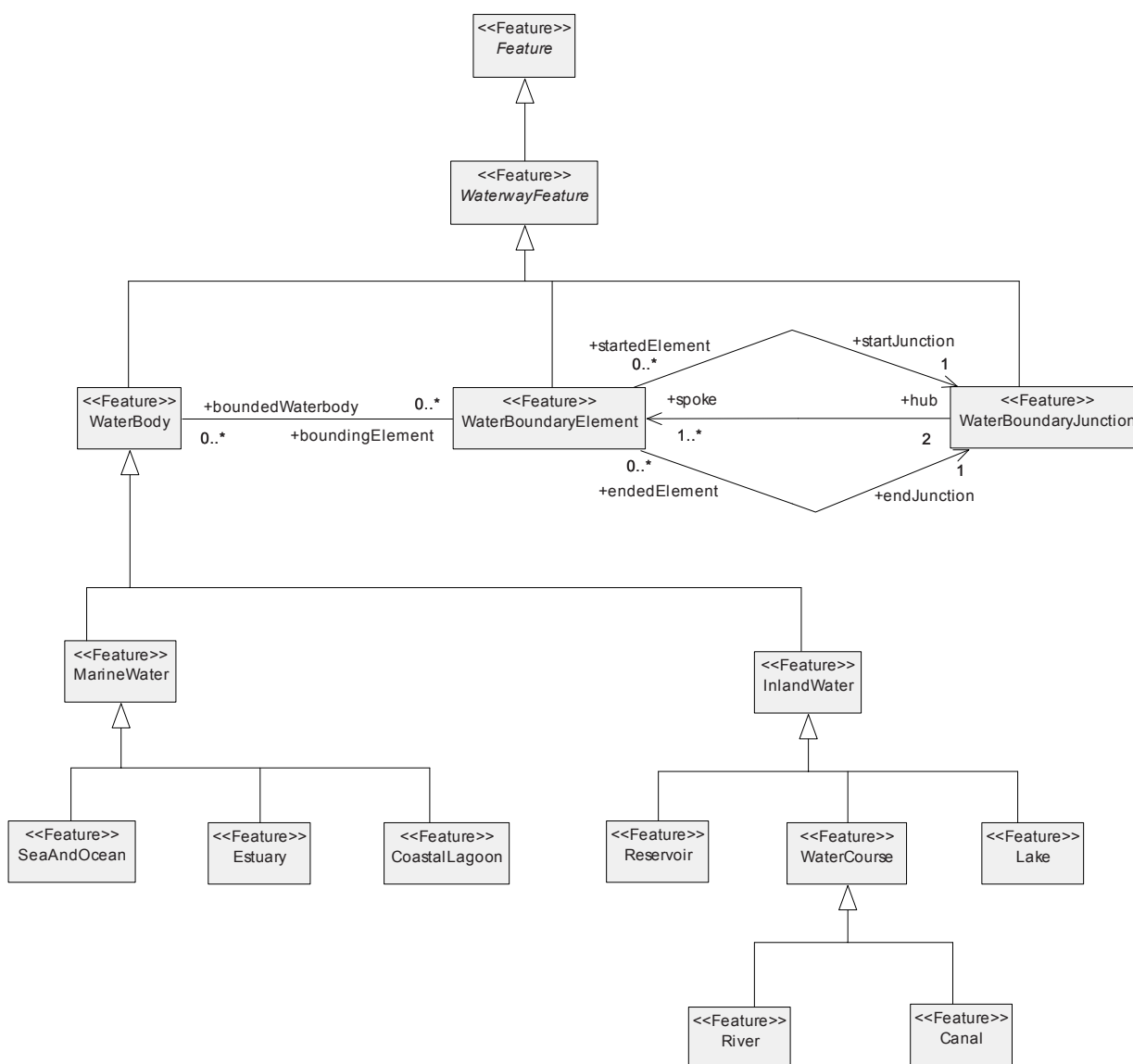

Figure 83 — The Conceptual Data Model for Waterways

6.9.2 Canal

6.9.2.1 Definition

An artificially constructed linear water body.

6.9.2.2 Description

Canal is a sub-type of Water Course.

6.9.3 Coastal Lagoon

6.9.3.1 Definition

Unvegetated stretch of salt or brackish water separated from the sea by a tongue of land or other similar topography. These water bodies can be connected with the sea at limited points, either permanently or for parts of the year only.

6.9.3.2 Description

Coastal Lagoon is a sub-type of Marine Water.

6.9.4 Estuary

6.9.4.1 Definition

The mouth of a river within which the tide ebbs and flows.

6.9.4.2 Description

Estuary is a sub-type of Marine Water.

6.9.5 Inland Water

6.9.5.1 Definition

Water body with no or only limited connection to the sea or ocean.

6.9.5.2 Description

Inland Water is a sub-type of Water Body

6.9.6 Lake

6.9.6.1 Definition

Natural or artificial stretch of water, excluding reservoirs.

6.9.6.2 Description

Lake is a sub-type of Inland Water.

6.9.7 Marine Water

6.9.7.1 Definition

Sea, ocean or other saline water body connected to them.

6.9.7.2 Description

Marine Water is a sub-type of Water Body

6.9.8 Reservoir

6.9.8.1 Definition

Constructed stretch of water, or artificially contained natural stretch of water, used primarily as a water source for human populations and for agricultural purposes.

6.9.8.2 Description

Reservoir is a sub-type of Inland Water.

6.9.9 River

6.9.9.1 Definition

A linear body of inland water of natural or semi-natural origin.

6.9.9.2 Description

River is a sub-type of Water Course.

6.9.10 Sea And Ocean

6.9.10.1 Definition

Zone seaward of the lowest tide limit.

6.9.10.2 Description

Sea And Ocean is a sub-type of Marine Water.

6.9.11 Water Body

6.9.11.1 Definition

A way or course through which water flows, or an area covered by water.

6.9.12 Water Boundary Element

6.9.12.1 Definition

The smallest unit of a boundary that describes the edge of a Water Body.

6.9.12.2 Description

A Water Boundary Element is a continuous boundary formed between the edge of a Water Body and the surrounding area.

6.9.12.3 Constraints

A Water Boundary Element is bounded by exactly two or in case of a (Water) island by one (see Figure 84) Water Boundary Junction(s). A Water Boundary Element may never bound the same Waterways Feature twice.

6.9.13 Water Boundary Junction

6.9.13.1 Definition

The location where Water Boundary Elements join.

6.9.13.2 Constraints

A Water Boundary Junction joins/connects one or more Water Boundary Elements. Figure 84 illustrates the case when it joins one single Water Boundary Element.

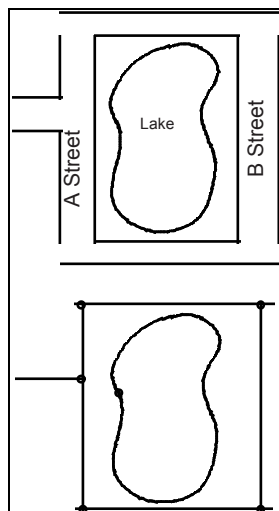

Figure 84 — An example of Water Boundary Element bounded by one Water Boundary Junction

6.9.14 Water Course

6.9.14.1 Definition

Natural or artificial water-course serving as a water drainage channel. Includes canals.

6.9.14.2 Description

Water Course is a sub-type of Inland Water.

6.10 Road Furniture

6.10.1 General overview

Road Furniture denotes items of road inventory which are categorised by having a fixed location along a Road Element (either on the carriageway or the pavement) or Path.

EXAMPLE Traffic Lights, Traffic Sign or Measurement Device.

Figure 86 illustrates the Data Model for Road Furniture.

6.10.2 Environmental Equipment

6.10.2.1 Definition

Item for protecting the environment along or adjacent to the road.

6.10.2.2 Description

EXAMPLE Noise protection wall, or a set of hedges.

6.10.3 Signpost

6.10.3.1 Definition

A collection of boards and plates that are physically attached and which contain directional information.

6.10.3.2 Description

An illustration is given in Figure 85. A Signpost may represent a set of signposts referring to the same situation.

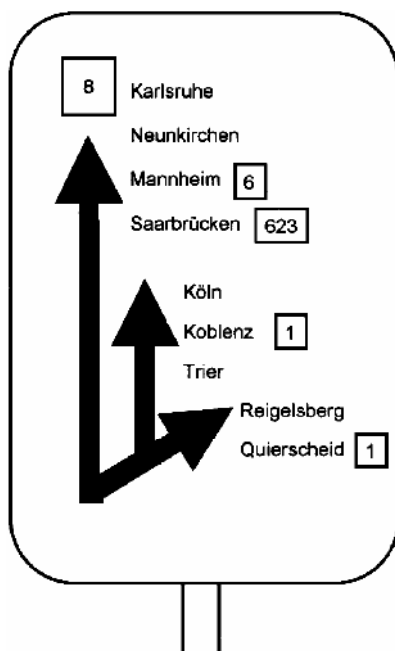

Figure 85 — Example of a Signpost

6.10.4 Traffic Light

6.10.4.1 Definition

A multi coloured light governing the traffic flow.

6.10.5 Traffic Sign

6.10.5.1 Definition

A board containing symbols and (possibly) some additional text, expressing a traffic restriction, recommendation or information.

6.10.6 Lighting

6.10.6.1 Definition

Item for lighting a road.

6.10.6.2 Description

EXAMPLE A lamppost.

6.10.7 Measurement Device

6.10.7.1 Definition

Device for measurements or monitoring of traffic.

6.10.7.2 Description

EXAMPLE Video camera, induction loop or radar.

6.10.8 Road Markings

6.10.8.1 Definition

The occurrence of markings on a road.

6.10.8.2 Description

EXAMPLE Solid lines or dashed lines for limiting the driving lanes.

6.10.9 Safety Equipment

6.10.9.1 Definition

Equipment on a road for safety purposes.

6.10.9.2 Description

EXAMPLE Safety barrier.

6.10.10 Pedestrian Crossing

6.10.10.1 Definition

A specially marked location of a Road Element where pedestrians are privileged to cross the street.

6.10.10.2 Description

A Pedestrian Crossing can have the form of a street level crossing, or be an overpass or underpass. The former may or may not include signalling by means of signs, traffic lights and pavement markings; the latter may or may not have complementary Pedestrian Crossing Entry/Exit locations.

Multiple underpasses, as well as overpasses, may be connected to form a pedestrian crossing network underneath, or above respectively, a road intersection.

6.10.11 Complex Pedestrian Crossing

6.10.11.1 Definition

The collection of Pedestrian Crossings that together form one (logical) unity, possibly including associated Entry Points.

6.10.11.2 Description

A Complex Pedestrian Crossing aggregates distributed Pedestrian Crossing locations (as well as their Entry Point locations), such as the representation of an underpass pedestrian crossing network or a pair of street-level crossings across a dual carriageway.

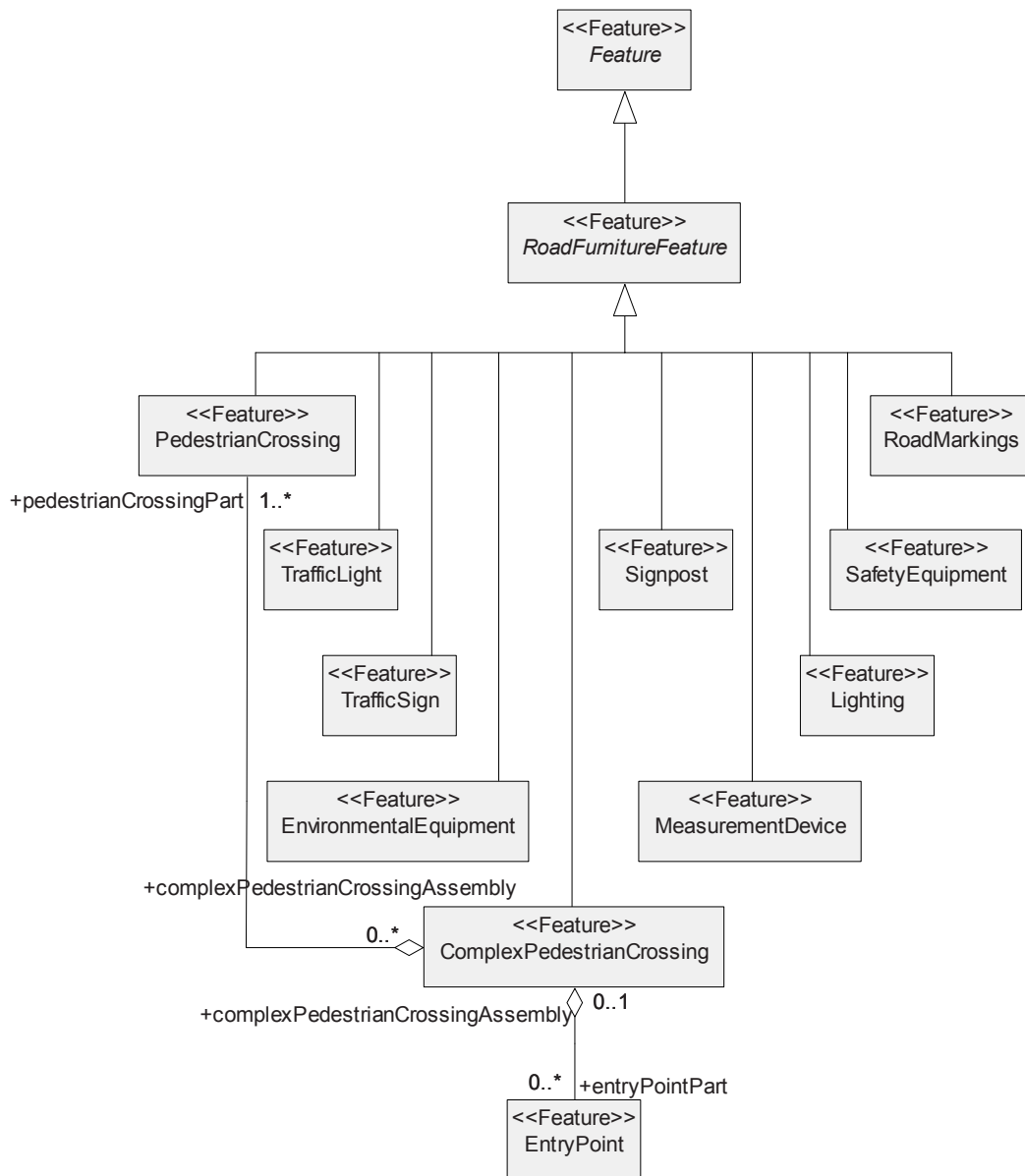

Figure 86 — The Conceptual Data Model for Road Furniture

6.11 Services

6.11.1 General overview

Service is a generic term for an activity at a specific location. It is important to notice that a Service represents an activity and not the building in which this activity (possibly) takes place.

Many services are particularly relevant to the road environment, such as recreation, vehicle maintenance, emergency services or cargo, customs and retail services. Services also can be related to a Road Element or Junction to describe information needed for vehicle access. Services can be further characterised by Attributes. Service definitions and classification of Services tend to be an interpretation of reality rather than a representation thereof. Service definitions are therefore not part of the normative part of the standard. For

illustrative purpose some definitions have been included in the informative part of the standard. They can be found in Clause C.1.

Figure 87 represents a sample conceptual data model in which some services are contained.

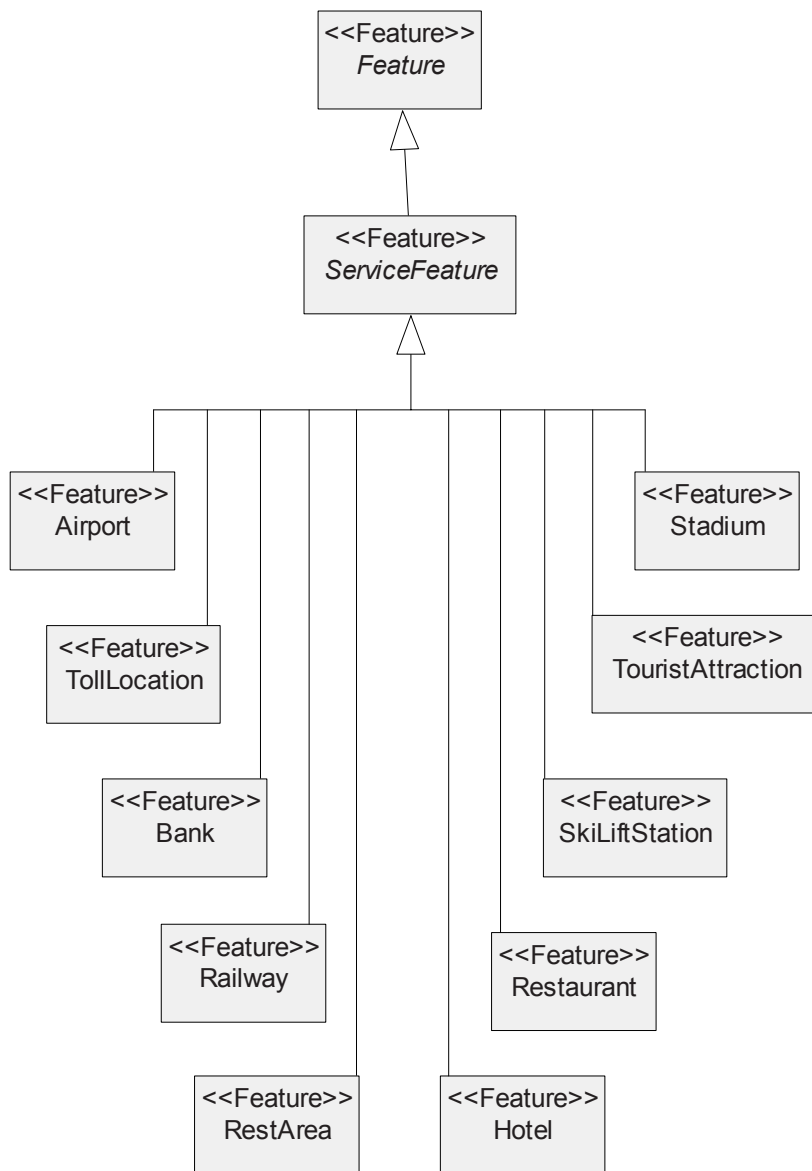

Figure 87 — Sample Conceptual Data Model for Services

6.12 Public Transport

6.12.1 General overview

6.12.1.1 Description

All elements regarding the public transport network are grouped in a Feature Theme called Public Transport. The semantics of Features and associated Attributes and Relationships in this Feature Theme corresponds to

TRANSMODEL [32]. However, Public Transport is used in a broader sense than scheduled network services only, it also includes a basic model for taxi services.

This theme contains all the public transport basic Features that can be related with a geometrical position.

6.12.1.2 Features of Public Transport

The Features included as Public Transport are:

- Route Link
- Route Point
- Stop Point
- Public Transport Point
- Stop Area
- Route
- Line
- Taxi Stand

The conceptual data model for Public Transport is shown in Figure 88.

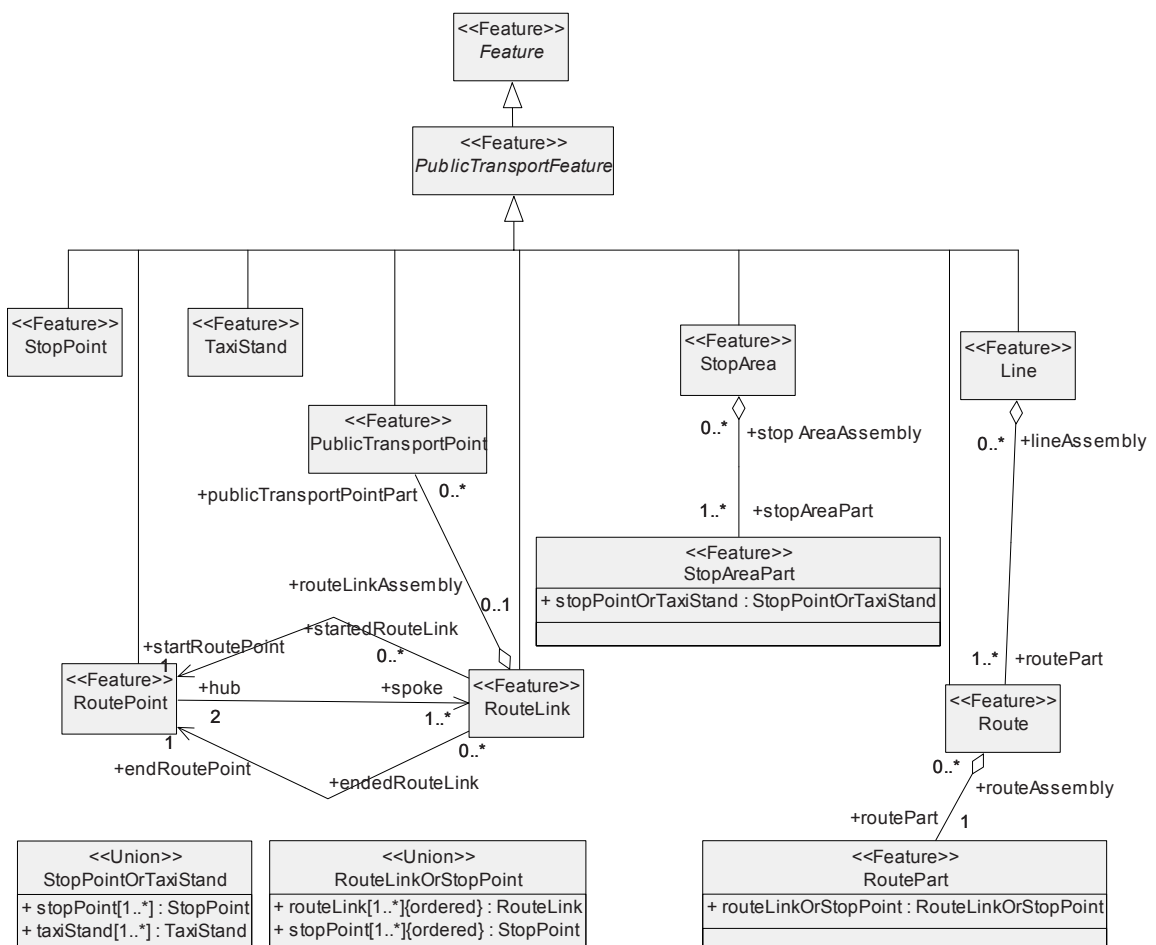

Figure 88 — The Conceptual Data Model for Public Transport

6.12.2 Line

6.12.2.1 Definition

A group of Routes that is generally known to the public by a similar name or number.

6.12.2.2 Description

In most cases, the Complex Feature Line consists of two Routes, one for each direction on the Line. If alternative routes are defined, a Line can have more than two Routes.

6.12.3 Route Point

6.12.3.1 Definition

A Feature that bounds a Route Link.

6.12.3.2 Description

A Route Point is located at the intersection of two or more Route Links, or at the end of a dead end Route Link. A Route Point should be introduced at the location where three or more Route Links meet. This happens when e.g. two Routes branch off. Figure 89 shows the example where two Routes are intersecting. At the common section there has been a bus stop defined. The two Routes share a single Route Link where they run together and Route Points will be introduced where two Routes meet. The Route will be broken up in Route Links. Route A will consist of Route Links {RL3, RL2, RL5}. Route B will consist of Route Links {RL1, RL2, RL4}. The stop can be related to either Route A, Route B, or both.

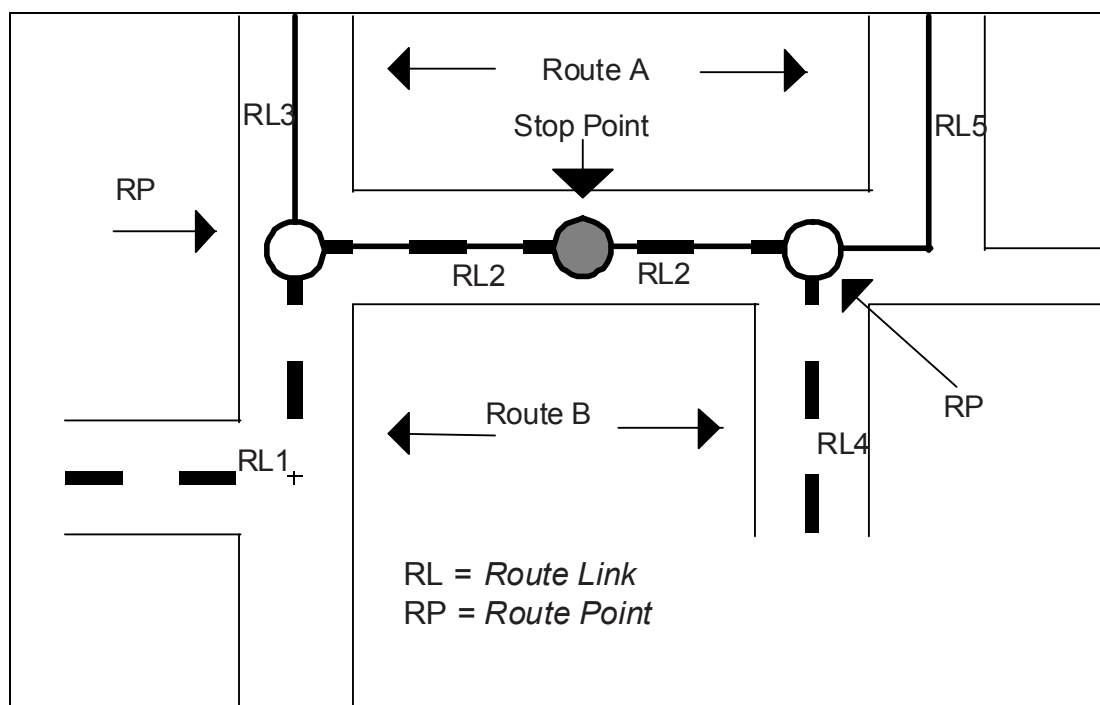

Figure 89 — An example of Public Transport Features

6.12.4 Public Transport Point

6.12.4.1 Definition

A Public Transport Point is an addressable location in a public transport network possessing its own identifier.

6.12.4.2 Description

All public transport point locations can be described by Public Transport Points. This point can have a clear physical meaning, like an activation point or a measuring point, but this is not required. The Attribute Public Transport Point Type will indicate the point type.

6.12.5 Route

6.12.5.1 Definition

A Route is an ordered list of Route Links, or of Stop Points respectively, defining a single path through the public transport network, with a direction.

6.12.5.2 Description

The route is a grouping of Route Links, or of Stop Points respectively, in order to form the physical path that a public transport vehicle can follow. A Route may pass through the same point more than once. In the case of enumerated Stop Points, it is implied that the first and last Stop Point represent a Terminus of the Route. If first and last Stop Point are identical, this indicates a circular Route (with or without an existing Route in reverse order).

A public transport line will normally have one Route in each direction. Alternative routes could be defined for the exceptional circumstances (e.g. one day a week when the bus follows a different path).

6.12.6 Route Link

6.12.6.1 Definition

An oriented link between two Route Points defining a unique path through the public transport network.

6.12.6.2 Description

A Route Link can be part of several public transport routes. A Route Link has one Route Point at each end. Since Route Links are the smallest divisible unit of the Public Transport network, they may not overlap with other Route Links. In the case where two or more routes share the same physical path, only one Route Link should be defined. This Route Link will be shared by multiple Routes.

6.12.7 Stop Area

6.12.7.1 Definition

A group of Stop Points close to each other.

6.12.7.2 Description

Stop Areas are defined as a collection of stop points where passengers can change lines at walking distance. Typically stop areas are bus stations or several bus stops at a single intersection.

6.12.8 Stop Point

6.12.8.1 Definition

A point where passengers can board or alight from (public transport) vehicles.

6.12.8.2 Description

Stop Points are modelled differently than Public Transport Points because of their relation to Road Elements and Services. This will be the typical place where one can change transport mode in a multi-modal environment.

6.12.9 Taxi Stand

6.12.9.1 Definition

Designated place for taxi vehicles that serves as interim destination for picking-up new passengers.

6.12.9.2 Description

Taxi Stands are usually indicated by according signs and/or markings on the ground. Typical examples are Taxi Stands at airports or railway stations.

6.13 Linear Referencing Features

6.13.1 General overview

The Features defined in this part of the document have in common that they all have to do with a special view on linear shaped geographical objects such as roads, railways and waterways. This view is different to Roads and Ferries, Railways and Waterways where these object domains are modelled as “networks”, i.e. as set of objects that have topological Relationships that together define a “network space”.

However, these object domains may also be conceptualised as a set of independent long (linear) entities, called Paths, which do not have explicit mutual topological Relationships. One-dimensional linear referencing methods specify how to measure along a linear entity. Properties of a linear entity are referenced by means of positions along the entity. These positions are expressed by Distance expressions corresponding to curvilinear measurements, in accordance with an applicable linear referencing method. Positions expressed in this manner are referred to as linearly referenced locations [30].

Such a linear-based referencing method is often bench-marked in the Field by a number of “reference points” or Referents. Because these Referents are often used to collect and to represent data, they play a crucial role in the information systems of road, railway and waterway authorities.

Linear Referencing Features and the associated set of linear referencing Attributes adopt the concept of ISO 19148 Linear Referencing [30].

The conceptual data model for Linear Referencing Features is shown in Figure 90.

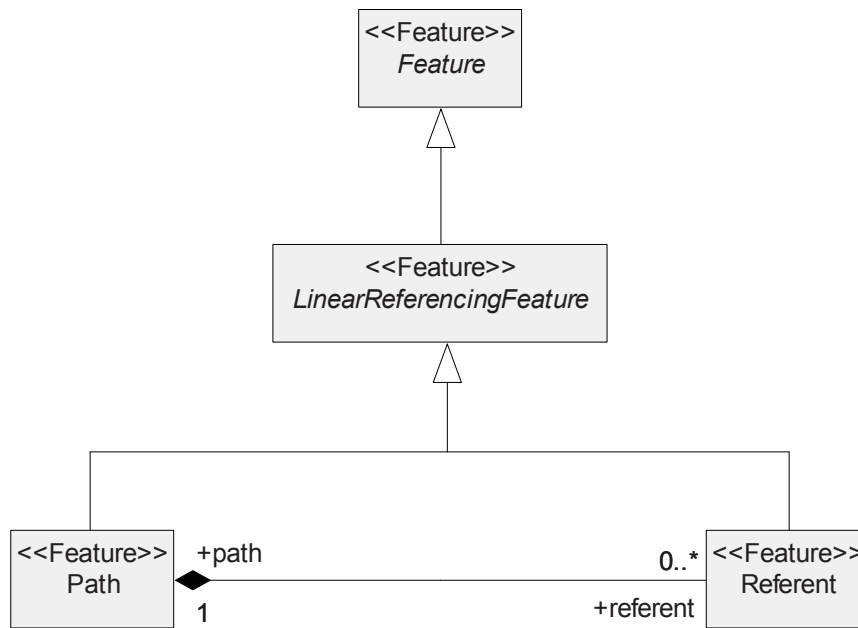

Figure 90 — The Conceptual Data Model for Linear Referencing Features

6.13.2 Path

6.13.2.1 Definition

A piece of the road, railway or waterway network which is considered as one single entity by an appropriate organisation or which is a user-defined designation of a linear extent.

6.13.2.2 Description

A Path represents a linear corridor. For instance, in the case of road entities in road databases of Public Road Authorities, the length may be several hundred kilometres and the width would only exceptionally exceed 100 meters. A Path may have one unique name or number assigned to it which distinguishes it from another Path.

A Path may have its own centre line representation, or it may be associated with the linear shape of (an)other Line Feature(s) and/or of a Linear Datum, to which it is tied by means of Linear Assignment Relationship(s).

A Path may have an associated set of Referents, which are linked to a Path by using the Exclusive Multi-Point Assignment Relationship. Some Linear Referencing Methods require such Referents for rendering actual Distance Expressions along a Path.

6.13.3 Referent

6.13.3.1 Definition

A known position along a Path from which relative measurements can be made.

6.13.3.2 Description

6.13.3.2.1 General

Some Linear Referencing Methods require Referents to be specified for rendering actual Distance Expressions along a Path. The set of Referents associated with a Path are linked to it by using the Exclusive Multi-Point Assignment Relationship.

The physical location of a Referent can relate to an intersection along the path, a boundary crossing the path, a landmark situated along the path, or a reference marker indicated by a benchmark (tally) placed in the verge or axis of the Path.

6.13.3.2.2 Referents embodied by reference markers

The concept of Reference marker corresponds to the physical marker that one will find in the verge or on the shoulders of roads, railways or waterways. It is an abstraction which may be an amalgam of the physical marker itself and the (usually not materialised) theoretical location on the axis of the Path that it embodies.

A Reference marker can be considered as an individual object, but in many other aspects (position, lay-out, value) it is linked with its neighbours, showing that they together form one reference system. For that reason, a Reference marker may exist even when there is no corresponding physical marker. This could be the case when one of the markers incidentally is missing (e.g. no place due to the presence of an exit or due to an accident etc.). Such location is still considered as a Reference marker, because it intentionally should have been there. This intention is indicated by the physical presence of the neighbouring points.

6.14 Linear Datum Features

6.14.1 General overview

A Linear Datum is a reference network of nodes and links, called Anchor Points and Anchor Sections, established based on locatable phenomena on the roadways. Its purpose is to provide for a common basis for assimilating road related data expressed in terms of different location and referencing methods. See Figure 91 for the conceptual data model for Linear Datum Features.

Translations between locations from different methods, such as a topological network of Roads & Ferries Features or a linear referencing model of Linear Referencing Features, are enabled by a Linear Datum linked to either of the location methods.

The linear datum can also provide a means of linking the GDF map database to the real world. Anchor Points represent locations which, through their description, are easily and unambiguously locatable in the field. Anchor Sections are then connected to these points of recoverable location.

By linking GDF data to the Linear Datum, it will be possible to integrate GDF data with other information which is similarly tied to the datum.

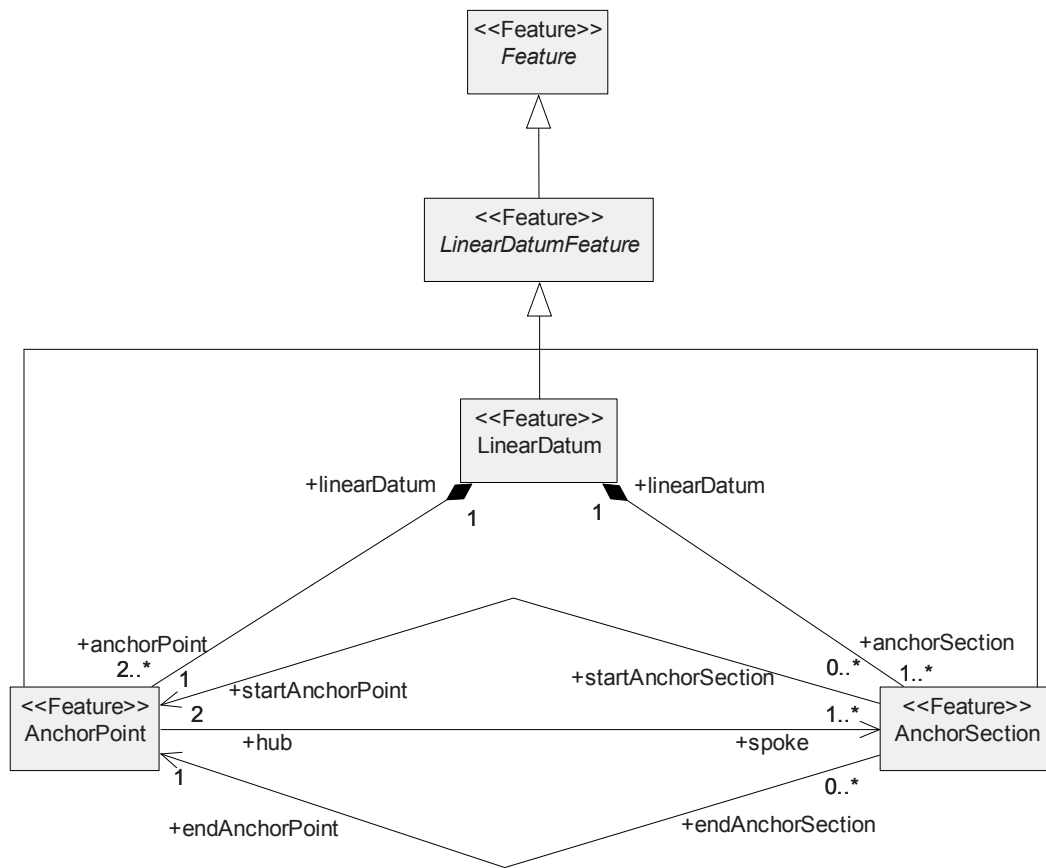

Figure 91 — The Conceptual Data Model for Linear Datum Features

6.14.2 Linear Datum

6.14.2.1 Definition

Linear datum is the reference framework for relating linear elements to each other or to their real world locations.

6.14.2.2 Description

The collection of connected Anchor Points and Anchor Sections which allow different classes of GDF Line Features to be related to each other or to linear elements outside of GDF.

6.14.3 Anchor Point

6.14.3.1 Definition

Linear Datum point representing a physical location in the field that can be unambiguously described so that it can be clearly located in the real world using its description.

6.14.3.2 Description

An Anchor Point provides a link between the digital model representation of a road system in GDF and the real world.

6.14.4 Anchor Section

6.14.4.1 Definition

Linear Datum linear element representing a section of road between two Anchor Points.

6.14.4.2 Description

Anchor Sections embody the official surface length of a road segment.

Anchor Sections can be used as the reference linear element (target Line Feature) to which other types of linear elements (source Line Features) can be assigned. These include GDF linear elements (e.g., Road Elements) as well as linear elements from other data sources. Linear Assignments can be to one or more, whole or partial Anchor Sections.

6.15 General Features

6.15.1 General overview

General Features are Features that have properties, Attributes or Relationships that can apply to all Feature Themes. These Features are defined separately to ease the representation of the common Attributes and Relationships.

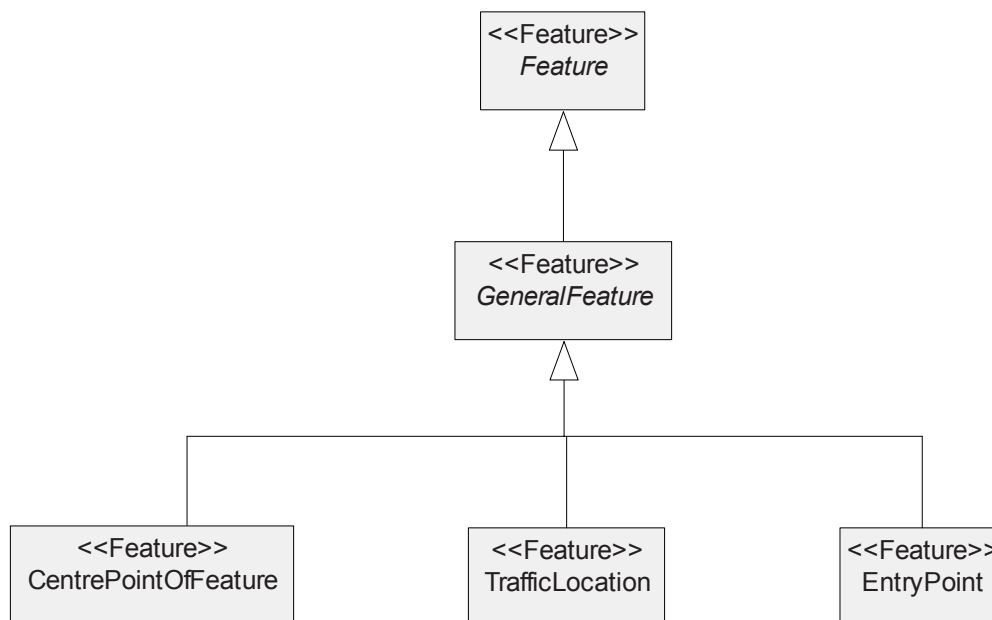

Figure 92 — The Conceptual Data Model for General Features

6.15.2 Centre Point of Feature

6.15.2.1 Definition

A point which describes an approximate or exact centre of a Simple or Complex Feature.

6.15.2.2 Description

This Feature forms a geographical reference point of another (Simple or Complex) Feature. The Centre Point of Feature is linked to the corresponding Feature of which it represents the centre by means of the Relationship Type Centre Point of Feature belonging to Feature.

The Centre Point of Feature can refer to an isolated Node or a Node of the Feature to which it belongs.

6.15.3 Traffic Location

6.15.3.1 Definition

A set of one or more Features which as a whole represents a location that is identified for and used in traffic information services.

6.15.3.2 Description

A Feature can belong to more than one Traffic Location. Traffic Locations do not have an implied topology. A Traffic Location Feature may belong to another Traffic Location.

6.15.4 Entry Point

6.15.4.1 Definition

A location representing the entrance of Feature.

6.15.4.2 Description

An entry point represents an entrance of one or more Features, or a combination of an entrance and an exit of one or more Features. It shall not represent only an exit.

7 Attribute Catalogue

7.1 Generic specifications

7.1.1 Attribute Types

Properties of real world objects are represented as Attributes. Attributes are classified in the form of Attribute Types. Each Attribute Type corresponds to a well defined Property of a real world object (e.g. colour).

7.1.2 Attribute Values

To each Attribute Type are assigned one or more Attribute Values, which can be seen as a particular instance of an Attribute Type (e.g. the colour “green”). Some Attribute Types may have an infinite number of different Attribute Values (e.g. the values of the Attribute Type “width”), whereas other Attribute Types may have only a fixed number of values (e.g. gender, “male” and “female”). The list of permissible values that the Attribute can take is called the domain of an Attribute. The paragraph “Domain/Unit of Measurement” in the description of the individual Attributes in the following sub-clauses specifies the domain for each Attribute.

See Annex A.2 for the codes defined for Attribute Values.

7.1.3 Attribute Type Name

Each Attribute Type is referenced in this document by an Attribute Type Name. These names are written with initial capitals in order to distinguish them from the daily life terms from which they have been derived (e.g. “Maximum Height Allowed” versus “maximum height allowed”).

See Annex A.2 for the codes defined for Attribute Types.

7.1.4 Simple Attributes, Composite Attributes and Sub-Attributes

7.1.4.1 Introduction

Two kinds of Attributes can be distinguished: simple and composite. A Simple Attribute has only one component, whereas a Composite Attribute has more than one component. The individual components are called Sub-Attributes.

The Sub-Attributes of a Composite Attribute can in their turn be simple or composite. In this way, a Composite Attribute can be viewed as a hierarchical Attribute tree with only Simple Attributes as leaves.

Certain Sub-Attributes of a Composite Attribute may be absent or contain null values. For others this is not allowed. In the description this is indicated by the word “mandatory”. Certain Sub-Attributes can appear more than one time within the context of the Composite Attribute. An example can be found in sub-clause 12.2.5.6.2.

7.1.4.2 Restrictive Sub-Attributes

Some Attribute Types can be used in combination with more than one Attribute to form a Composite Attribute, each time playing the same role, restricting the validity of the associated Sub-Attribute. Because of this they are called Restrictive Sub-Attributes.

If attached to Features, Restrictive Sub-Attributes always appear in combination with the Sub-Attribute they restrict. They can never appear alone. In case they are attached to Relationships, they can appear alone. In this case they restrict the Relationship itself and as such play conceptually the same role as a normal Attribute attached to a Relationship. The Attribute Validity Direction will never be attached to a Relationship because Relationships are, unlike Attributes, directed.

Restrictive Sub-Attributes can relate to Simple, Composite or Sub-Attributes of Composite Attributes. To allow for this, it is possible to define logical groups of Sub-Attributes that are subject to the Restrictive Sub-Attribute.

It is also possible that more than one Restrictive Sub-Attribute restrict an Attribute (simple or composite). In this respect a distinction needs to be made between two different cases:

1. The Restrictive Sub-Attributes simultaneously restrict the logical group
2. The Restrictive Sub-Attributes sequentially restrict the logical group, each instance forming a separate logical group (in terms of each instance constituting a new scope level), restricted by the next Restrictive Sub-Attribute, etc.

The result of the first situation shall be interpreted as the Attribute Value restricted by the first Restrictive Sub-Attribute extended with the same Attribute Value restricted by the second Restrictive Sub-Attribute extended with the same Attribute Value restricted by the third Restrictive Sub-Attribute etc. In set theory terms this comes down to a Union or application of an OR operator.

The result of the second situation shall be interpreted as the result of a number of subsequent restrictions. The first Restrictive Sub-Attribute restricts the Attribute Value of the logical group, together forming a new logical group, which subsequently is restricted by a second Restrictive Sub-Attribute, together forming a third logical group, which subsequently....etc. In set theory terms this comes down to an Intersection or application of an AND operator.

Other rules apply for Restrictive Sub-Attributes in the context of Default Attributes than for normal Attributes. For Restrictive Sub-Attributes the default Attribute value does not have to be specified explicitly. It is defined as "No restriction".

The Restrictive Sub-Attributes defined so far are Lane Dependent Validity, Linear Segmentation, Pedestrian Type, Scope, Side of Line, Validity Direction, Validity Period and Vehicle Type. Because they can in principle be combined with any other Attribute they are dealt with here instead of specifying each different combination under its respective Feature Theme.

7.1.5 Composite Attributes combined with the Restrictive Sub-Attribute Lane Dependent Validity

7.1.5.1 General

The Attribute Lane Dependent Validity can in principle be combined with any other Attribute of a Road Element. The Lane Dependent Validity specifies for which traffic lanes of the associated Road Element the associated Sub-Attribute holds. Combined with any Attribute XXXX this combination forms the Composite Attribute XXXX for lane (where XXXX may be any Simple or Composite Attribute).

7.1.5.2 Definition

An Attribute which is only valid for a restricted number of traffic lanes of the associated Road Element.

7.1.5.3 Domain/unit of measure

Composite.

7.1.5.4 Sub-Attributes

This Composite Attribute can consist of the following Sub-Attributes:

- Any Attribute Type from Roads and Ferries — Mandatory
- Lane Dependent Validity

7.1.6 Composite Attributes combined with the Restrictive Sub-Attribute Linear Segmentation

7.1.6.1 General

The Attribute Linear Segmentation can in principle be combined with any other Attribute. It expresses the linear extent for which the Attribute with which the Linear Segmentation together forms the Composite Attribute is valid. Combined with any arbitrary Attribute XXXX this combination forms the Composite Attribute XXXX with Linear Segmentation --- (where XXXX may be any Simple or Composite Attribute).

7.1.6.2 Definition

An Attribute which is valid for a restricted linear sub-section of a Line Feature.

7.1.6.3 Domain/unit of measure

Composite

7.1.6.4 Sub-Attributes

This Composite Attribute can consist of the following Sub-Attributes :

- Any Attribute Type - Mandatory
- Linear Segmentation

7.1.7 Composite Attributes combined with the Restrictive Sub-Attribute Pedestrian Type

7.1.7.1 General

The Pedestrian Type can in principle be combined with any other Attribute. It defines the types of pedestrians to which accessibility restrictions apply and for which the information contained in the associated Attribute is valid. Combined with an arbitrary Attribute XXXX, this combination forms the Composite Attribute XXXX for Pedestrian Type.

7.1.7.2 Definition

An Attribute which is only valid for a restricted number of accessibility restriction types.

7.1.7.3 Domain/unit of measure

Composite.

7.1.7.4 Sub-Attributes

This Composite Attribute can consist of the following Sub-Attributes:

- Any Attribute Type from Roads and Ferries — Mandatory
- Pedestrian Type [.]..[.]

NOTE [.]..[.] indicates that the Sub-Attribute can have multiple instances in the framework of the Composite Attribute.

7.1.8 Composite Attributes combined with the Restrictive Sub-Attribute Scope

7.1.8.1 General

The Attribute Scope can in principle be combined with any other Attribute. It expresses the fact whether or not the semantic scope of an Attribute value is entirely applicable. Combined with any arbitrary Attribute XXXX this combination forms the Composite Attribute XXXX with Scope (where XXXX may be any Simple or Composite Attribute). However, not all combinations may be meaningful, as the notion of partial Scope may not always be relevant or suitable for an Attribute at hand.

7.1.8.2 Definition

An Attribute whose semantic scope is partially applicable only.

7.1.8.3 Domain/unit of measure

Composite

7.1.8.4 Sub-Attributes

This Composite Attribute can consist of the following Sub-Attributes :

- Any Attribute Type - Mandatory
- Scope

7.1.9 Composite Attributes combined with the Restrictive Sub-Attribute Side of Line

7.1.9.1 General

The Attribute Side of Line can in principle be combined with any other Attribute of a Line Feature. The Side of Line specifies for which side of the associated Line Feature the associated Sub-Attribute holds. Combined with any Attribute XX this combination forms the Composite Attribute XX for the Side of the Line Feature (where XX may be any Simple or Composite Attribute applicable to the Line Feature in question).

7.1.9.2 Definition

An Attribute which is only valid for the indicated side of the associated Line Feature.

7.1.9.3 Domain/unit of measure

Composite.

7.1.9.4 Sub-Attributes

This Composite Attribute can consist of the following Sub-Attributes:

- Any Attribute Type — Mandatory
- Side of Line

7.1.10 Composite Attributes combined with the Restrictive Sub-Attribute Validity Direction

7.1.10.1 General

The Attribute Validity Direction can in principle be combined with any other Attribute of a Line Feature. Validity Direction specifies for which direction relative to the direction of the Line Feature the associated Sub-Attribute holds. Combined with any Attribute XX this combination forms the Composite Attribute XX for the positive or negative direction of the Line Feature (where XX may be any Simple or Composite Attribute).

7.1.10.2 Definition

An Attribute which is only valid for (a) specific direction(s) of the associated Line Feature.

7.1.10.3 Domain/unit of measure

Composite.

7.1.10.4 Sub-Attributes

This Composite Attribute can consist of the following Sub-Attributes:

- Any Attribute Type — Mandatory
- Validity Direction

7.1.11 Composite Attributes combined with the Restrictive Sub-Attribute Validity Period

7.1.11.1 General

The Attribute Validity Period can in principle be combined with any other Attribute. It expresses the time period for which the Attribute with which the Validity Period together forms the Composite Attribute Composite Attribute is valid. Combined with any arbitrary Attribute XXXX this combination forms the Composite Attribute XXXX with Validity Period (where XXXX may be any Simple or Composite Attribute).

7.1.11.2 Definition

An Attribute which is valid for a restricted period of time.

7.1.11.3 Domain/unit of measure

Composite.

7.1.11.4 Sub-Attributes

This Composite Attribute can consist of the following Sub-Attributes:

- Any Attribute Type — Mandatory
- Validity Period [..][.]

NOTE [..][.] indicates that the Sub-Attribute can have multiple instances in the framework of the Composite Attribute.

7.1.12 Composite Attributes combined with the Restrictive Sub-Attribute Vehicle Type

7.1.12.1 General

The Attribute Vehicle Type can in principle be combined with any other Attribute. It defines the kind of vehicle for which the information contained in the associated Attribute is valid. Combined with an arbitrary Attribute XXXX, this combination forms the Composite Attribute XXXX for Vehicle Type.

7.1.12.2 Definition

An Attribute which is only valid for a restricted number of vehicle types.

7.1.12.3 Domain/unit of measure

Composite.

7.1.12.4 Sub-Attributes

This Composite Attribute can consist of the following Sub-Attributes:

- Any Attribute Type from Roads and Ferries — Mandatory
- Vehicle Type [.]..[.]

NOTE [.]..[.] indicates that the Sub-Attribute can have multiple instances in the framework of the Composite Attribute.

7.1.13 Names in combination with a Language Code

The Attributes in which a name is specified are language dependent. To specify this dependency, a Language Code value should be used in combination with the Name. The Language Code specifies in which language the Name has been defined. Language Codes are defined in ISO 639-2 [1]. Annex B.1 contains a current informative listing of the Language Codes which should be applied.

7.1.14 Default Attribute Values

In case a certain, appropriate Attribute Type is not related to a particular Feature, this means that that particular Attribute has not been collected for that particular Feature. However, it is also possible to specify that the absence of a certain Attribute Type at a particular Feature indicates that a certain default value of that Attribute holds. If this is the case, the value “not collected” no longer is applicable for that Attribute.

7.1.15 Default Attribute units for measures

For Attributes with units of some form of measure, listed in the table below, units can be specified at either a Dataset level, or for an individual Attribute type. At the Dataset level, a default of Metric or English units can be specified for an entire Dataset via the Attribute Unit System in the Dataset Header (refer to the Metadata Catalogue sub-clause 10.2.3.5). Unit System specifies which of two code lists apply for all possible default values for the Unit System.

The Dataset-level default can be over-riden for any Attribute type. Each existing GDF Attribute listed in Figure 97, with the exception of Value On Traffic Sign and Distance Measure, has two defining elements which together declare each Attribute's respective measure: (1) a numerical value and (2) a Union of English, Metric, or user-defined Unit Of Measure (UOM). In the case of Value On Traffic Sign, only the user-defined Unit Of Measure is allowed. In the case of Distance Measure, the Unit Of Measure is designated by the applicable Linear Referencing Method, and the numerical value is supplemented by a unit exponent (scaling factor). If a unit other than the default is to be used, this should be specified at the Attribute level, with a conversion (scaling factor) from Base Units. Base Units are: metre, minute, kilogram, kilometre per hour, or degree.

The Data Model for default Attribute units is given in Figure 97 and Figure 98.

Attribute Type	Metric Default Unit Of Measure	English Default Unit Of Measure
Average Vehicle Speed	Kilometre per hour	Mile per hour
Distance Measure	N/A (Unit Of Measure designated by Linear Reference Method)	
Divider Height	Centimetre	Inch
Divider Width	Centimetre	Inch
Height of Pass	Metre	Foot
Length of a Road Element	Metre	Foot
Lower Building Elevation	Foot	Foot
Maximum Height Allowed	Centimetre	Inch
Maximum Length Allowed	Centimetre	Inch
Maximum Total Weight Allowed	Tenth of a Metric Ton	Pound
Maximum Weight per Axle Allowed	Tenth of a Metric Ton	Pound
Maximum Width Allowed	Centimetre	Inch
Measured Length	Metre	Foot
Positional Accuracy	Metre	Foot
Speed Restrictions	Kilometre per hour	Mile per hour
Summer Time	Minute	Minute
Upper Building Elevation	Metre	Foot
Value on Traffic Sign	N/A (user-defined Unit Of Measure only)	
Width	Centimetre	Inch

7.1.16 Attribute Type Codes

In sub-clause 7.1.3 it is described how Attributes are referenced by Attribute Type Names. This kind of referencing is applied in this document. In the physical data structure, however, Simple Attributes are referenced by an Attribute Type Code. Composite Attributes are not referenced in the physical structure since they merely form logical constructs. Annex A.2 contains a survey of the defined Attribute Type Codes.

7.1.17 User-defined Attributes

The standard supports the ability for a user to define Attributes which are not already defined. For these, special Attribute Type Codes have been reserved. (See Annex A.2).

7.1.18 Attribute mapping to Feature Themes and Relationships

7.1.18.1 General

Usually, Attributes are associated with one Feature Theme. Some types of Attributes can be applied to more than one Feature Theme. Some are truly general. In order to illustrate which Attributes may apply to which Feature Themes, tables that map Attribute types to Feature Themes are given in sub-clauses 7.1.18.2 through 7.1.18.16.

Check marks (√) indicate that an Attribute type is thought to be applicable, representing the superset of indicative Attribute usages including specific Attribute usages depicted in the conceptual data models for Attributes of the respective Feature Themes (see 7.1.19) and Relationship Types (see 8.1.2).

For information, signalisation of extended Attribute usage is provided by using a plus (+), going beyond the Attribute scope depicted in the respective conceptual data models.

7.1.18.2 Mapping of Attributes generally applied across Feature Themes and specifically for Relationships

Attribute Name	Roads & Ferries	Admin Areas	Named Areas	Land Cover & Use	Terrain Elevation	Structures	Railways	Waterways	Road Furniture	Services	Public Transport	Linear Referencing	Linear Datum	General Features	Relationships
Accessibility	√								√	√	√			√	√
Accessibility Limitation	√								√	√	√			√	√
Alternate Name	√	√	√	√		√	√	√		√	√			√	
Alternate Name Body	√	√	√	√		√	√	√		√	√			√	
Alternate Name Text	√	√	√	√		√	√	√		√	√			√	
Alternate Pronunciation	√	√	√	√		√	√	√	√	√	√	√		√	√
Association Type															√
Composite Alternate Pronunciation	√	√	√	√		√	√	√	√	√	√	√		√	√
Composite Pronunciation	√	√	√	√		√	√	√	√	√	√	√		√	√
Continuation Type															√
Currency	√					√						+			√
Display Class	√	√	√	√		√	√	√	√	√	√			√	
Distance Expression	√	√	√	√	√	√	√	√	√	√	√	√	√	√	√
Distance Measure	√	√	√	√	√	√	√	√	√	√	√	√	√	√	√
Distance Measure Referent	√	√	√	√	√	√	√	√	√	√	√	√	√	√	√
External Identifier	√	√	√	√		√	√	√	√	√	√	√	√	√	√
Give Way Type															√
Hearing Limitation	√								√	√	√			√	√
Height Label	√			√	√	√	√	√		√		+			
Infrastructure Accessibility Aids	√								√	√	√			√	√
Lateral Offset	√	√	√	√	√	√	√	√	√	√	√	√	√	√	√
Linear Referencing Method	√	√	√	√	√	√	√	√	√	√	√	√	√	√	√
Linear Segmentation*	√	√	√	√	√	√	√	√	√	√	√	√	√	√	√
Location Description	√	√	√	√	√	√	√	√	√	√	√	√	√	√	√
Location Reference	√	√	√	√		√	√	√	√	√	√	+		√	√
Location Reference Code	√	√	√	√		√	√	√	√	√	√	+		√	√
Location Reference Type	√	√	√	√		√	√	√	√	√	√	+		√	√
Multi Media Action	√	√	√	√	√	√	√	√	√	√	√	√		√	√
Multi Media Description	√	√	√	√	√	√	√	√	√	√	√	√		√	√
Multi Media File Attachment	√	√	√	√	√	√	√	√	√	√	√	√		√	√
Multi Media File Attachment Context	√	√	√	√	√	√	√	√	√	√	√	√		√	√
Multi Media File Attachment Name	√	√	√	√	√	√	√	√	√	√	√	√		√	√
Multi Media File Attachment Type	√	√	√	√	√	√	√	√	√	√	√	√		√	√
Multi Media Time Domain	√	√	√	√	√	√	√	√	√	√	√	√		√	√
Name Component	√	√	√	√		√	√	√		√	√			√	√
Name Component Length	√	√	√	√		√	√	√		√	√			√	√
Name Component Offset	√	√	√	√		√	√	√		√	√			√	√
Name Component Type	√	√	√	√		√	√	√		√	√			√	√
Name Prefix	√	√	√	√		√	√	√		√	√			√	
Notation	√	√	√	√		√	√	√	√	√	√	√		√	√
Notation Alphabet	√	√	√	√		√	√	√	√	√	√	√		√	√
Notation Anomaly	√	√	√	√		√	√	√	√	√	√	√		√	√

Attribute Name	Roads & Ferries	Admin Areas	Named Areas	Land Cover & Use	Terrain Elevation	Structures	Railways	Waterways	Road Furniture	Services	Public Transport	Linear Referencing	Linear Datum	General Features	Relationships
Notation Variant	√	√	√	√		√	√	√	√	√	√	√		√	√
Notation Version	√	√	√	√		√	√	√	√	√	√	√		√	√
Official Code	√	√	√			√	√	√	√	√	√	√			
Official Name	√	√	√	√		√	√	√		√	√			√	
Official Name Body	√	√	√	√		√	√	√		√	√			√	
Official Name Text	√	√	√	√		√	√	√		√	√			√	
Opening Period	√									√				√	
Pedestrian Type*	√					√			√	√	√	√		√	√
Phonetic Alphabet	√	√	√	√		√	√	√	√	√	√	√		√	√
Positional Accuracy	√	√	√	√		√	√	√	√	√	√				
Postal Code	√	√	√							√	√				
Pronunciation	√	√	√	√		√	√	√	√	√	√	√		√	√
Pronunciation Language	√	√	√	√		√	√	√	√	√	√	√		√	√
Pronunciation Variant	√	√	√	√		√	√	√	√	√	√	√		√	√
Scope*	√	√	√	√	√	√	√	√	√	√	√	√	√	√	√
Side of Line*	√	√	√	√	√	√	√	√	√	√	√	√	√	√	√
Slow Walker Limitation	√								√	√	√			√	√
Spoken Language	√	√	√	√	√	√	√	√	√	√	√	√	√	√	√
Suitable for Disabled Or Challenged	√								√	√	√			√	√
Summer Time	√	√	√				√	√		√	√				
Time Zone	√	√	√				√	√		√	√				√
Toll	√					√						+			√
Toll Charge	√					√						+			√
Transcription Description	√	√	√	√		√	√	√	√	√	√	√		√	√
Validity Direction*	√					√	√	√	√		√	√		√	√
Validity Period*	√	√	√	√		√	√	√	√	√	√	√		√	√
Vision Limitation	√								√	√	√			√	√
Wheelchair Limitation	√								√	√	√			√	√

NOTE The * symbol indicates that the Attribute is a Restrictive Sub-Attribute which can be applied generically. Restrictive Sub-Attributes are not called out in the UML diagrams since they operate on Attributes, not Features.

7.1.18.3 Attribute mapping for Roads & Ferries Feature Theme

Attribute Name	Roads & Ferries	Admin Areas	Named Areas	Land Cover & Use	Terrain Elevation	Structures	Railways	Waterways	Road Furniture	Services	Public Transport	Linear Referencing	Linear Datum	General Features	Relationships
Accident	√											+			+
Accident Date	√														+
Accident Identifier	√														+

Attribute Name	Roads & Ferries	Admin Areas	Named Areas	Land Cover & Use	Terrain Elevation	Structures	Railways	Waterways	Road Furniture	Services	Public Transport	Linear Referencing	Linear Datum	General Features	Relationships
Address Information	√														
Alternate Street Name	√														+
Alternate Street Name Body	√														+
Alternate Street Name Text	√														+
Average Vehicle Speed	√														
Blocked Passage	√														
Blocked Passage Location	√														
Blocked Passage Type	√														
Composite Exit Number	√								√						√
Composite Form of Way	√														
Conditional Traffic Flow	√											√			+
Construction Status	√														+
Direction Category	√								√						√
Directional Prefix	√											+			√
Directional Suffix	√											+			√
Divided Road Element	√														
Divider	√														
Divider Colour	√														
Divider Height	√														
Divider Impact	√														
Divider Marking	√														
Divider Type	√														
Divider Width	√														
Enclosed Traffic Area Type	√														
Exit Number	√								√						√
Ferry Type	√														
First House Number	√														
Form of Way	√														
Freeway	√														
Frequency of a Traffic Connection	√														
Functional Road Class	√														
High Occupancy Vehicle	√														
House Number Range	√														
House Number Structure	√														
Interchange Type	√														
Intermediate House Number	√														
Junction Type	√														
Lane Dependent Validity*	√											+			√
Lane Info	√														
Lane Type	√														
Last House Number	√														
Length of a Road Element	√														
Magnetic Anomalies	√														
Maximum Height Allowed	√					√						+			+
Maximum Length Allowed	√					√						+			+
Maximum Number of Lanes	√											+			+

Attribute Name	Roads & Ferries	Admin Areas	Named Areas	Land Cover & Use	Terrain Elevation	Structures	Railways	Waterways	Road Furniture	Services	Public Transport	Linear Referencing	Linear Datum	General Features	Relationships
Maximum Total Weight Allowed	√					√						+			+
Maximum Weight per Axle Allowed	√					√						+			+
Maximum Width Allowed	√					√						+			+
Measured Length	√											+	√		+
Minimum Number of Lanes	√														+
Minimum Number of Occupants	√														
Mountain Pass	√														
National Road Class	√														+
Not Crossable by Pedestrians	√														
Number of Lanes	√											+			+
Official Street Name	√														+
Official Street Name Body	√														+
Official Street Name Text	√														+
One-way	√											√			
Ownership	√											+			
Pass	√														
Passing Restrictions	√											+			
Pathway Safety Indicator	√														
Pathway Type	√														
Paved Road Surface Type	√											+			+
Pavement Status	√											+			+
Percentage of International Traffic	√											+		√	+
Publicly Accessible	√														
Removable Blockage	√														
Road Gradient	√											+			
Road Inclination	√											+			
Road Surface	√											+			+
Road Surface Condition	√											+			+
Road Under Structure	√														
Road with Bicycle Lane	√														
Road with Parking Lane	√														
Road with Sidewalk	√														
Route Number	√											+			√
Route Number Body	√											+			√
Route Type Prefix	√											+			√
Route Type Suffix	√											+			√
Routing Identifier	√											+			+
Routing Sequence Number	√											+			+
Routing Type	√											+			+
Scenic Value	√														
Separator	√											+			√
Slip Road Type	√														
Special Routing	√											+			+
Speed Restrictions	√														
Street Lighted	√														
Street Type Prefix	√														

Attribute Name	Roads & Ferries	Admin Areas	Named Areas	Land Cover & Use	Terrain Elevation	Structures	Railways	Waterways	Road Furniture	Services	Public Transport	Linear Referencing	Linear Datum	General Features	Relationships
Street Type Suffix	√														
Structure Abutment	√														
Structure Abutment Info	√														
Toll Road	√											+			
Traffic Flow	√											+		√	+
Traffic Flow Measurement	√											+		√	+
Traffic Flow Measurement Type	√											+		√	+
Traffic Flow Measurement Unit	√											+		√	+
Traffic Jam Sensitivity	√														
Trailing Spaces	√														
Transition	√														
Travel Time	√										√				√
Unpaved Road Surface Type	√											+			+
Vehicle Type*	√											+			+
Width	√											+			+

NOTE The * symbol indicates that the Attribute is a Restrictive Sub-Attribute which can be applied generically. Restrictive Sub-Attributes are not called out in the UML diagrams since they operate on Attributes, not Features.

7.1.18.4 Attribute mapping for Administrative Areas Feature Theme

Attribute Name	Roads & Ferries	Admin Areas	Named Areas	Land Cover & Use	Terrain Elevation	Structures	Railways	Waterways	Road Furniture	Services	Public Transport	Linear Referencing	Linear Datum	General Features	Relationships
Administrative Boundary Type		√													
Common Language		√	√												
Geopolitical Structure Containment		√	√												
ISO Country Code		√													
Official Language		√	√												
Place within Place Classification															√
Population		√	√							√					
Population Class		√	√							√					
Region Code		√													

7.1.18.5 Attribute mapping for Named Areas Feature Theme

Attribute Name	Roads & Ferries	Admin Areas	Named Areas	Land Cover & Use	Terrain Elevation	Structures	Railways	Waterways	Road Furniture	Services	Public Transport	Linear Referencing	Linear Datum	General Features	Relationships
Boundary Type			√												
Settlement Type			√												

7.1.18.6 Attribute mapping for Land Cover and Use Feature Theme

Attribute Name	Roads & Ferries	Admin Areas	Named Areas	Land Cover & Use	Terrain Elevation	Structures	Railways	Waterways	Road Furniture	Services	Public Transport	Linear Referencing	Linear Datum	General Features	Relationships
Building Class Name				√											
Block Class Name				√											
Block Grouping				√											
Block Type				√											
Building Detail Type				√											
Building Storey				√											
Building Storey Count				√											
Complex Building Elevation				√											
Façade Colour				√											
Façade Component				√											
Façade Component Placement				√											
Façade Fabric				√											
Façade Fabric Type				√											
Façade Information				√											
Lower Building Elevation				√											
Road and Rail Network and Associated Land Type				√											
Sand Area Type				√											
Underground Flag				√			√				√				
Upper Building Elevation				√											

7.1.18.7 Attribute mapping for Terrain Elevation Feature Theme

Attribute Name	Roads & Ferries	Admin Areas	Named Areas	Land Cover & Use	Terrain Elevation	Structures	Railways	Waterways	Road Furniture	Services	Public Transport	Linear Referencing	Linear Datum	General Features	Relationships
No Terrain Elevation-specific Attributes defined															

7.1.18.8 Attribute mapping for Structures Feature Theme

Attribute Name	Roads & Ferries	Admin Areas	Named Areas	Land Cover & Use	Terrain Elevation	Structures	Railways	Waterways	Road Furniture	Services	Public Transport	Linear Referencing	Linear Datum	General Features	Relationships
Structure Category						√									√
Structure Identifier						√									
Structure Type						√									

7.1.18.9 Attribute mapping for Railways Feature Theme

Attribute Name	Roads & Ferries	Admin Areas	Named Areas	Land Cover & Use	Terrain Elevation	Structures	Railways	Waterways	Road Furniture	Services	Public Transport	Linear Referencing	Linear Datum	General Features	Relationships
No Railway-specific Attributes defined															

7.1.18.10 Attribute mapping for Waterways Feature Theme

Attribute Name	Roads & Ferries	Admin Areas	Named Areas	Land Cover & Use	Terrain Elevation	Structures	Railways	Waterways	Road Furniture	Services	Public Transport	Linear Referencing	Linear Datum	General Features	Relationships
Water Boundary Element Type								√							
Water Body Type								√							

7.1.18.11 Attribute mapping for Road Furniture Feature Theme

	Roads & Ferries	Admin Areas	Named Areas	Land Cover & Use	Terrain Elevation	Structures	Railways	Waterways	Road Furniture	Services	Public Transport	Linear Referencing	Linear Datum	General Features	Relationships
Attribute Name															
Destination Info on Traffic Sign									✓						✓
Destination Location									✓						✓
Equipment Identifier									✓						
Other Textual Content on a Traffic Sign									✓						
Pedestrian Crossing Level									✓						
Pedestrian Crossing Priority									✓						
Pedestrian Crossing Signage									✓						
Pedestrian Crossing Type									✓						
Road Furniture Position									✓						✓
Route Number on Sign									✓						✓
Sign Text									✓						
Symbol on Traffic Sign									✓						
Traffic Light Info									✓						
Traffic Sign Class									✓						
Traffic Sign Information									✓						
Value on Traffic Sign									✓						

7.1.18.12 Attribute mapping for Services Feature Theme

	Roads & Ferries	Admin Areas	Named Areas	Land Cover & Use	Terrain Elevation	Structures	Railways	Waterways	Road Furniture	Services	Public Transport	Linear Referencing	Linear Datum	General Features	Relationships
Attribute Name															
Accepted Credit Cards										✓					
Airport Code										✓					
Brand Name										✓					
Breakfast Available										✓					
Business Lunch										✓					
Car Dealer Type										✓					
City Center Administrative Class										✓					
Commercial Airline Service										✓					
Commuter/Regional Railway Station										✓					
Departure/Arrival										✓					
Destination of Flight Connection										✓					
Domestic/International										✓					
Facilities en Suite										✓					
Flight Info										✓					

Attribute Name	Roads & Ferries	Admin Areas	Named Areas	Land Cover & Use	Terrain Elevation	Structures	Railways	Waterways	Road Furniture	Services	Public Transport	Linear Referencing	Linear Datum	General Features	Relationships
General Aviation										√					
Government Type										√					
House Number										√					
ID of Flight Connection										√					
Importance										√					
International Railway Station										√					
Main Railway Station										√					
Military Airport										√					
Number of Rooms										√					
Park and Ride Facility										√					
Park Type				√						√					
Parking Facilities Available										√					
Parking Type Charged										√					
Place Name										√					
Post Office Type										√					
Priceband										√					
Railway Type				√			√			√					
Rating										√					
Restaurant Facilities Available										√					
Service Address										√					
Snack Served										√					
Street Name										√					
Telefax Number										√					
Telephone Number										√					
Time Difference of Flight Connection										√					
Time of Arrival of Flight Connection										√					
Time of Departure of Flight Connection										√					
Toll Point Type										√					
Urban Railway Station										√					

7.1.18.13 Attribute mapping for Public Transport Feature Theme

Attribute Name	Roads & Ferries	Admin Areas	Named Areas	Land Cover & Use	Terrain Elevation	Structures	Railways	Waterways	Road Furniture	Services	Public Transport	Linear Referencing	Linear Datum	General Features	Relationships
Public Transport Mode											√				
Route Direction											√				
Type of Public Transport Point											√				

7.1.18.14 Attribute mapping for Linear Referencing Feature Theme

Attribute Name	Roads & Ferries	Admin Areas	Named Areas	Land Cover & Use	Terrain Elevation	Structures	Railways	Waterways	Road Furniture	Services	Public Transport	Linear Referencing	Linear Datum	General Features	Relationships
Assignment Order															√
Correspondence															√
Correspondence Order															√
Linear Position															√
Point Assignment															√
Start End Flag															√
Value on Referent												√			

7.1.18.15 Attribute mapping for Linear Datum Feature Theme

Attribute Name	Roads & Ferries	Admin Areas	Named Areas	Land Cover & Use	Terrain Elevation	Structures	Railways	Waterways	Road Furniture	Services	Public Transport	Linear Referencing	Linear Datum	General Features	Relationships
No Linear Datum-specific Attributes defined															

7.1.18.16 Attribute mapping for Feature Theme for General Features

Attribute Name	Roads & Ferries	Admin Areas	Named Areas	Land Cover & Use	Terrain Elevation	Structures	Railways	Waterways	Road Furniture	Services	Public Transport	Linear Referencing	Linear Datum	General Features	Relationships
Entry Point Type														√	

7.1.19 The data model for Attributes

The conceptual data model for Attributes is shown in Figure 100, Figure 101, Figure 102, Figure 103, Figure 104, Figure 105, Figure 106, Figure 107, Figure 108, Figure 109, Figure 110, Figure 111, Figure 112, Figure 113, Figure 114, Figure 115, Figure 116, Figure 117, Figure 118, Figure 119, Figure 120, Figure 121, Figure 122, Figure 123, Figure 124 and Figure 125. These Data Models show the applicable Attributes specific for the Feature Theme to which the Feature belongs. General Attributes specific to more than one Feature Theme are shown in Figure 93, Figure 94, Figure 95 and Figure 96. It should furthermore be noted that the use of Restrictive Sub-Attributes is a generic capability, for instance the restriction of any Attribute by a Validity Period. This generic mechanism is reflected in the overall conceptual model for Attributes in Figure 17. Related to linear referencing, the corresponding Feature Theme (see 6.13 and 0) and Linear Segmentation capabilities, a default Linear Referencing Method can be defined for Line Features (see Figure 99).

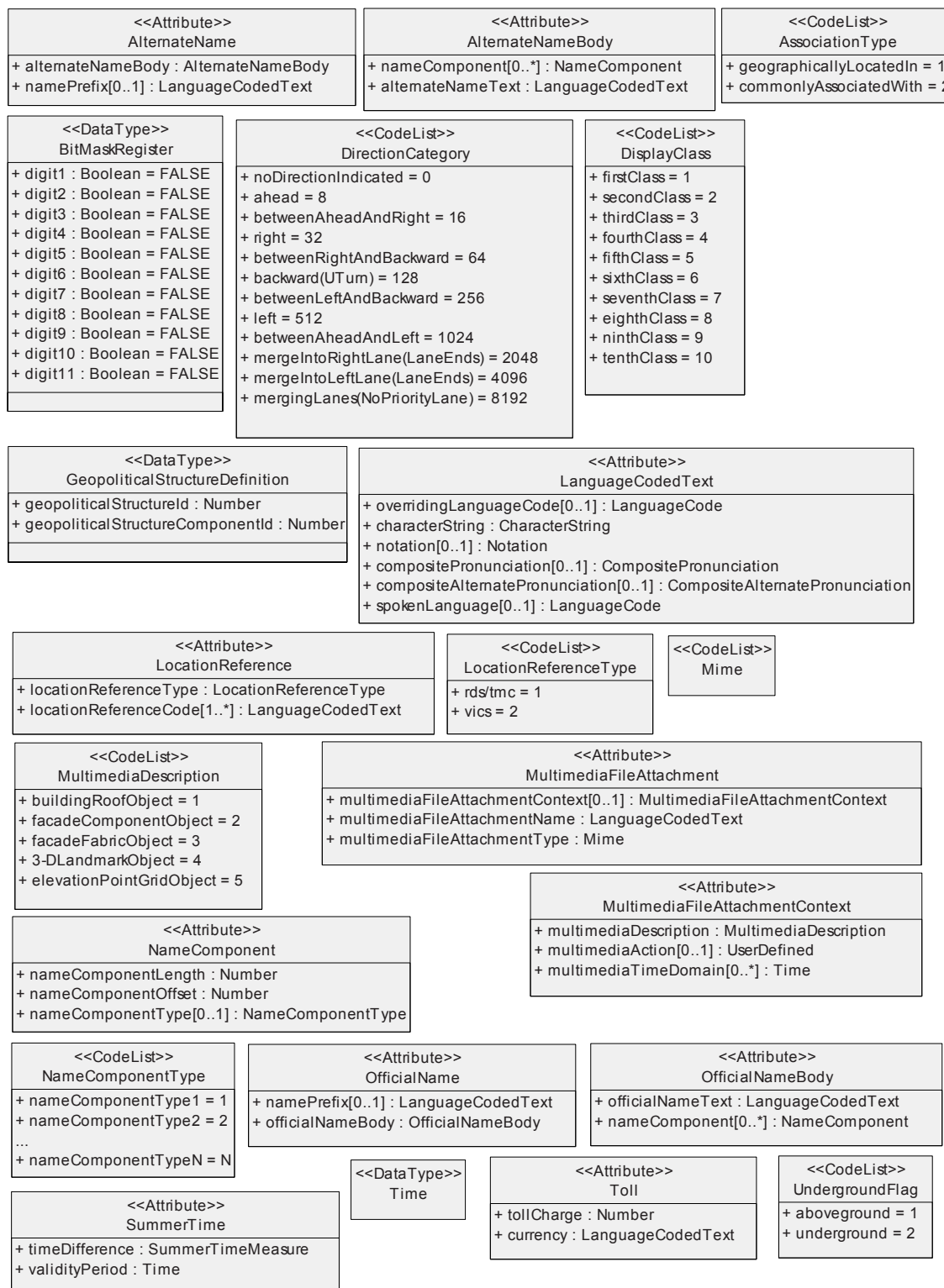

Figure 93 — The Conceptual Data Model for General Attributes

<<Attribute>> Accessibility
+ suitableForDisabledOrChallenged[0..1] : Boolean + infrastructureAccessibilityAids[0..1] : InfrastructureAccessibilityAids + accessibilityLimitation : AccessibilityLimitation

<<Attribute>> AccessibilityLimitation
+ wheelchairLimitation[0..1] : Boolean + slowWalkerLimitation[0..1] : Boolean + visionLimitation[0..1] : Boolean + hearingLimitation[0..1] : Boolean

<<CodeList>> InfrastructureAccessibilityAids
+ texturedSurfaceAvailable = 1 + audibleSignalAvailable = 2 + visualSignalAvailable = 3 + careProviderAvailable = 4

Figure 94 — The Conceptual Data Model for General Attributes (Accessibility)

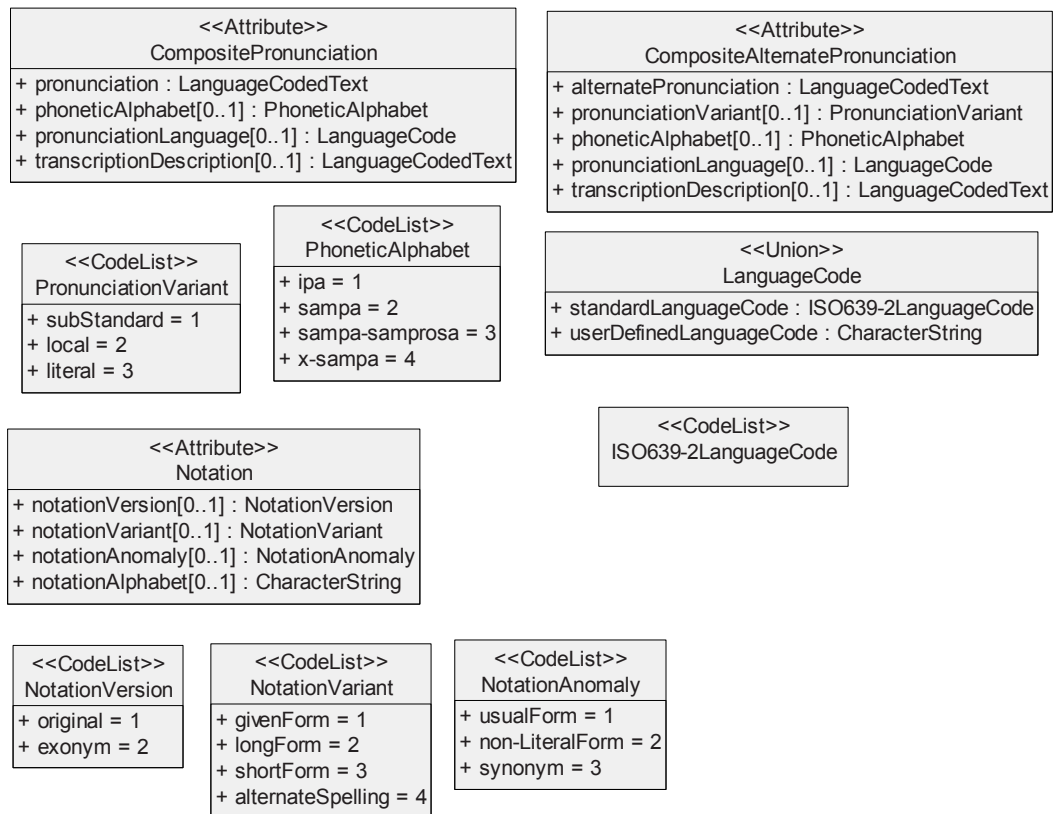

Figure 95 — The Conceptual Data Model for General Attributes (Phonetic Attributes)

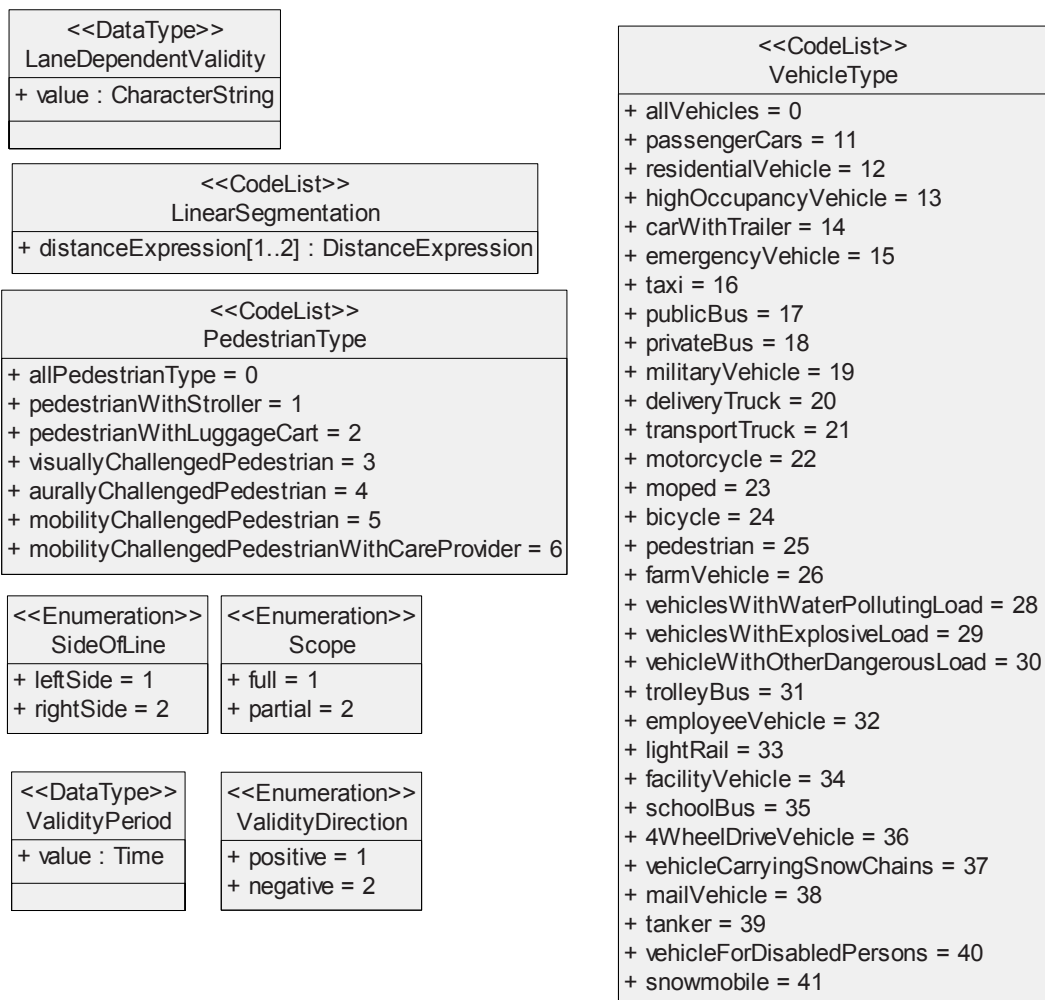

Figure 96 — The Conceptual Data Model for General Attributes (Restrictive Sub-Attributes)

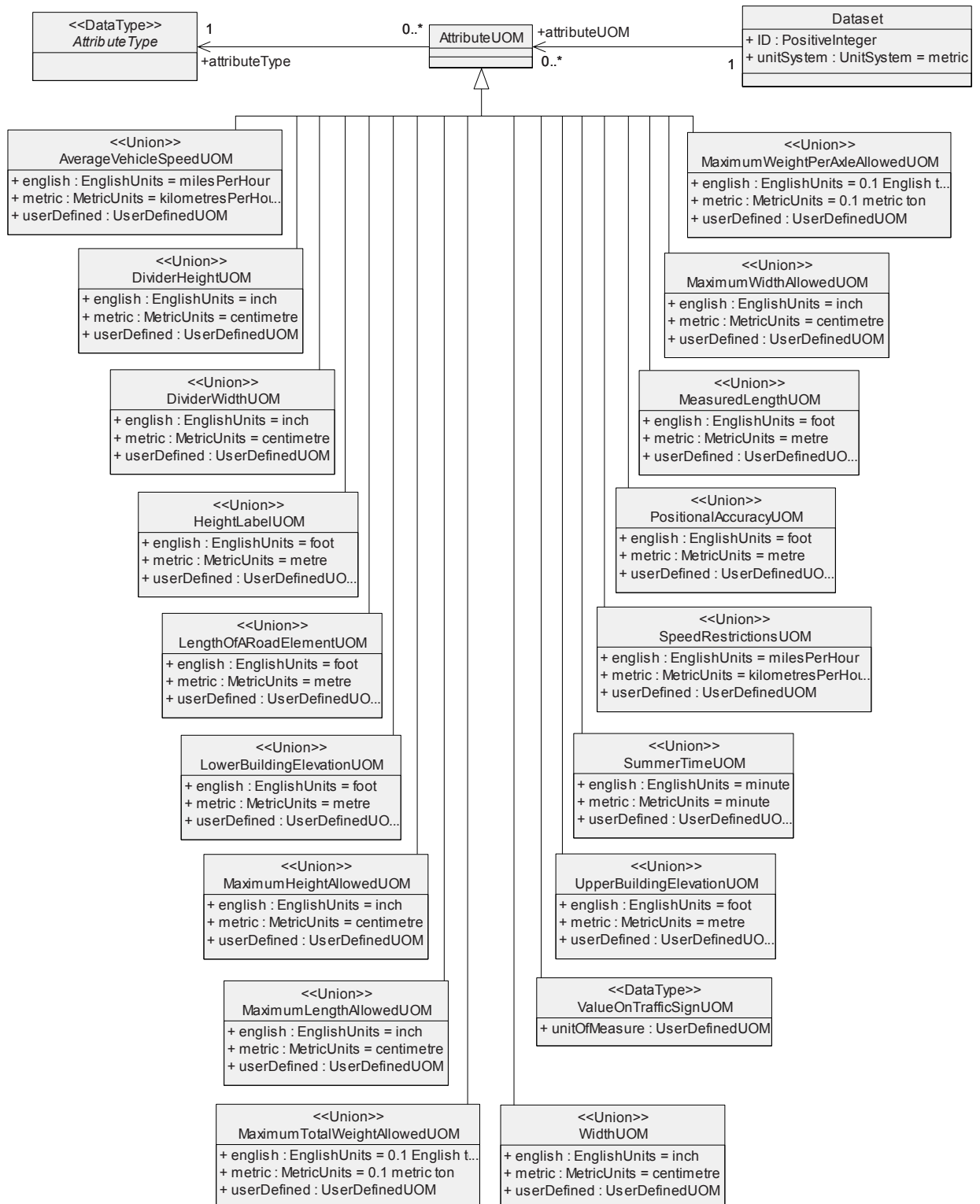

Figure 97 — The Conceptual Data Model for Default Attribute Units

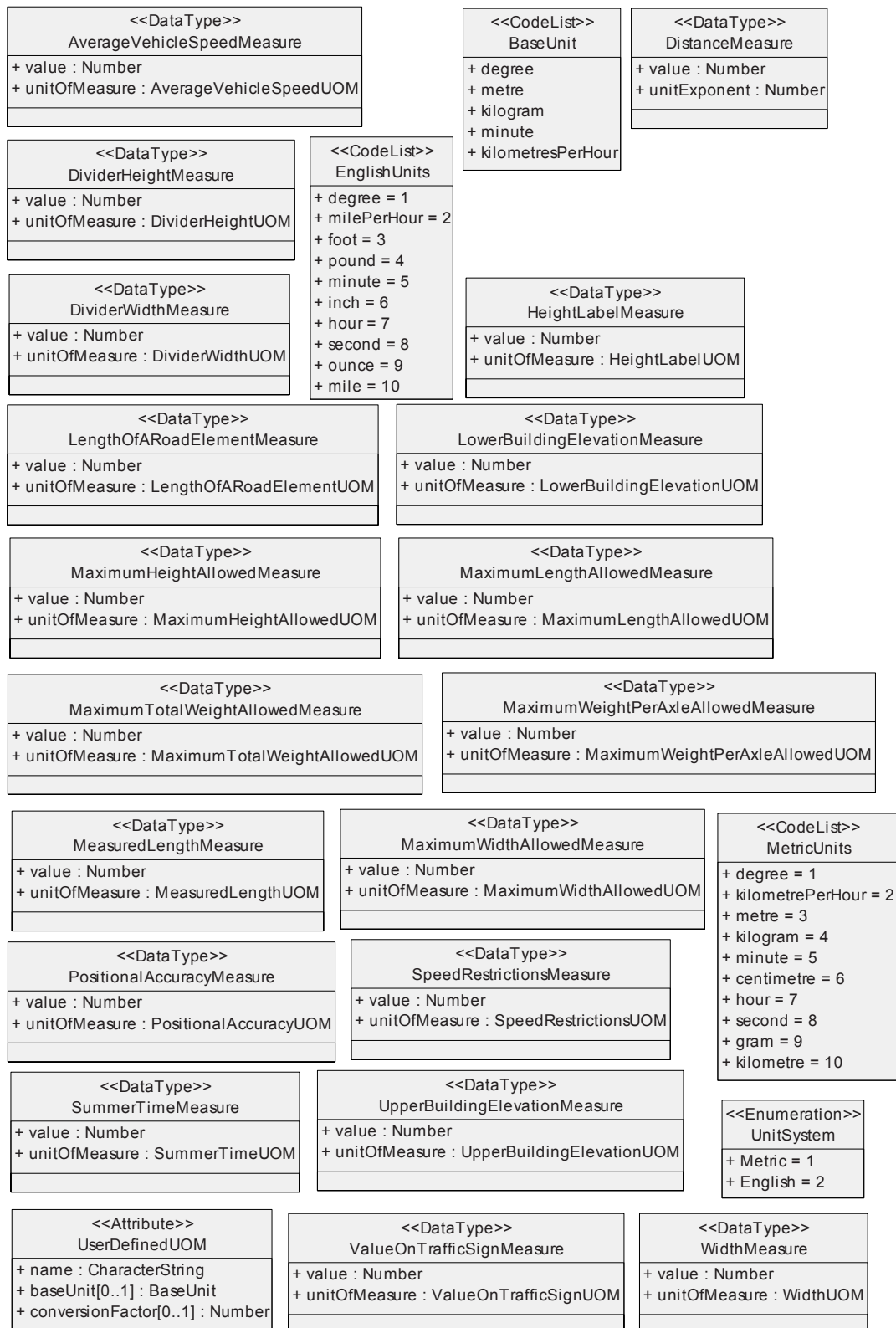

Figure 98 — The Conceptual Data Model for Type Classes for Default Attribute Units

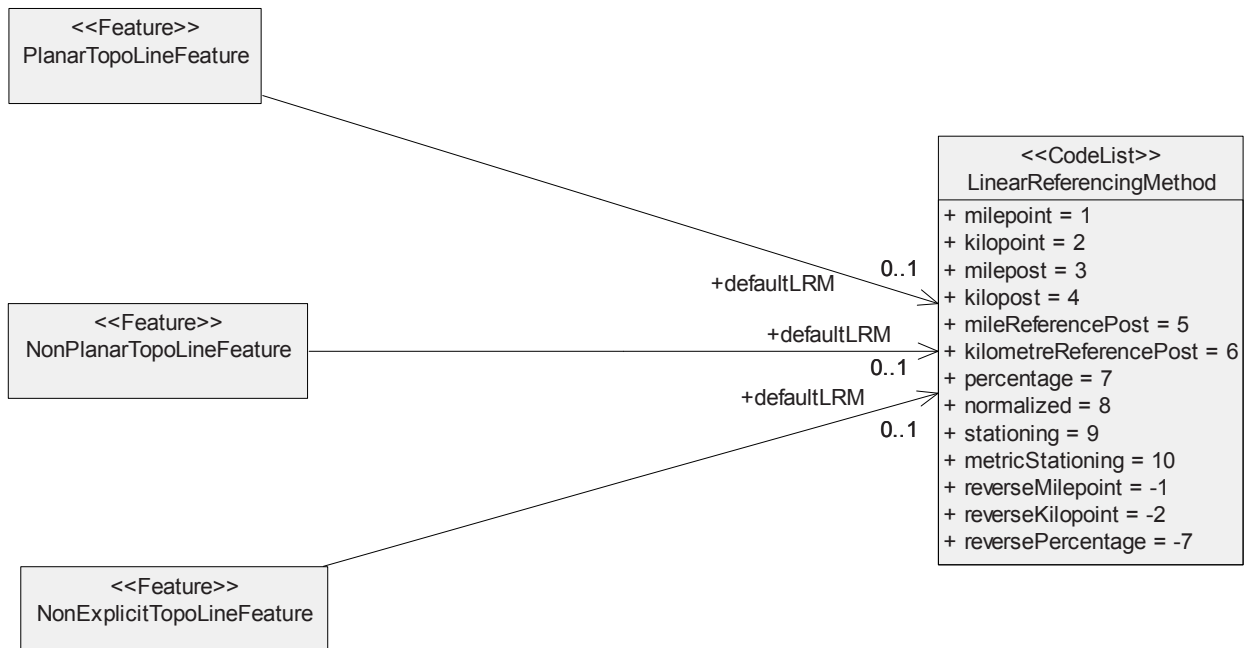

Figure 99 — The Conceptual Data Model for Default Linear Referencing Method of Line Features

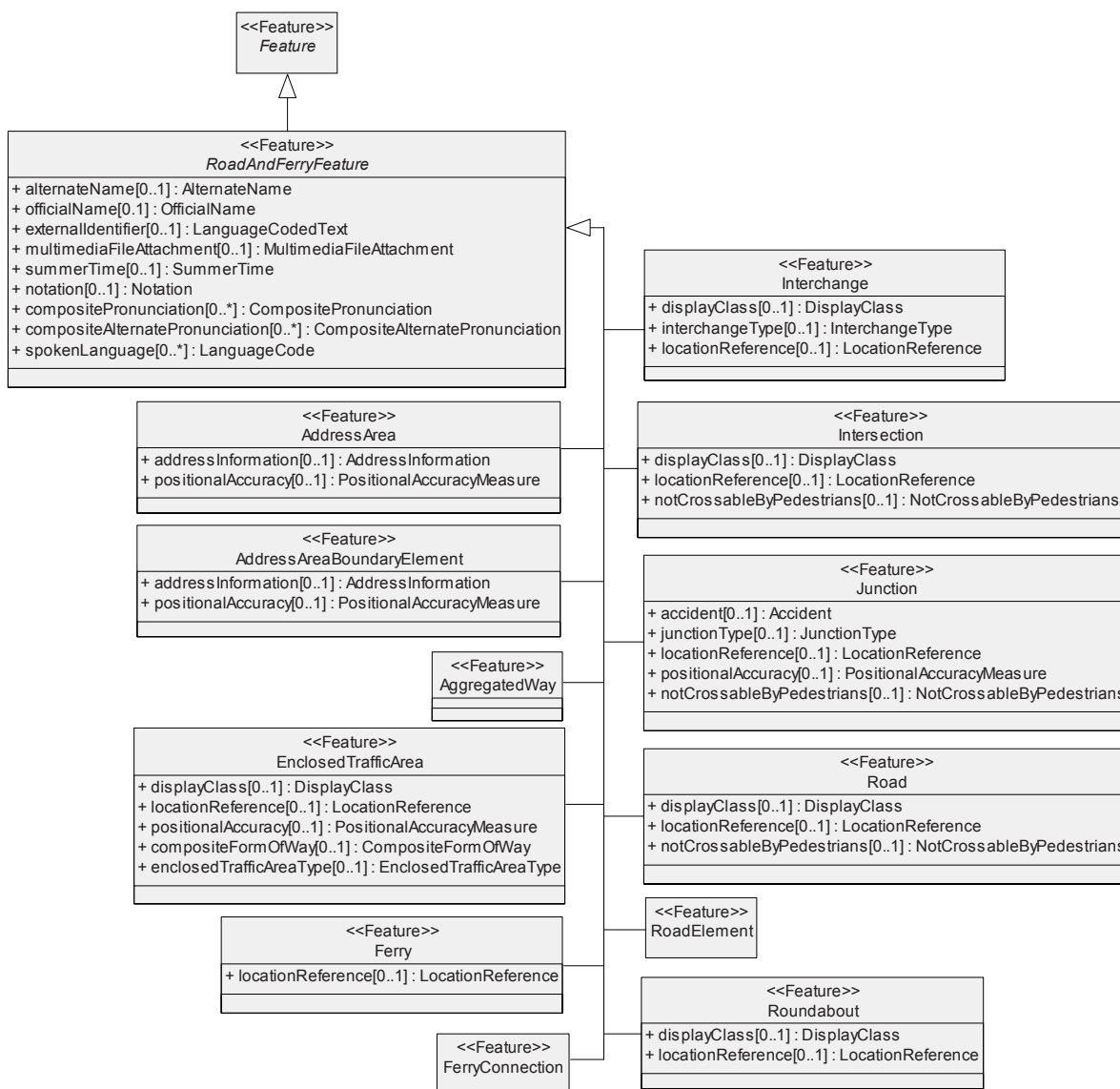

Figure 100 — The Conceptual Data Model for Attributes of Roads and Ferries

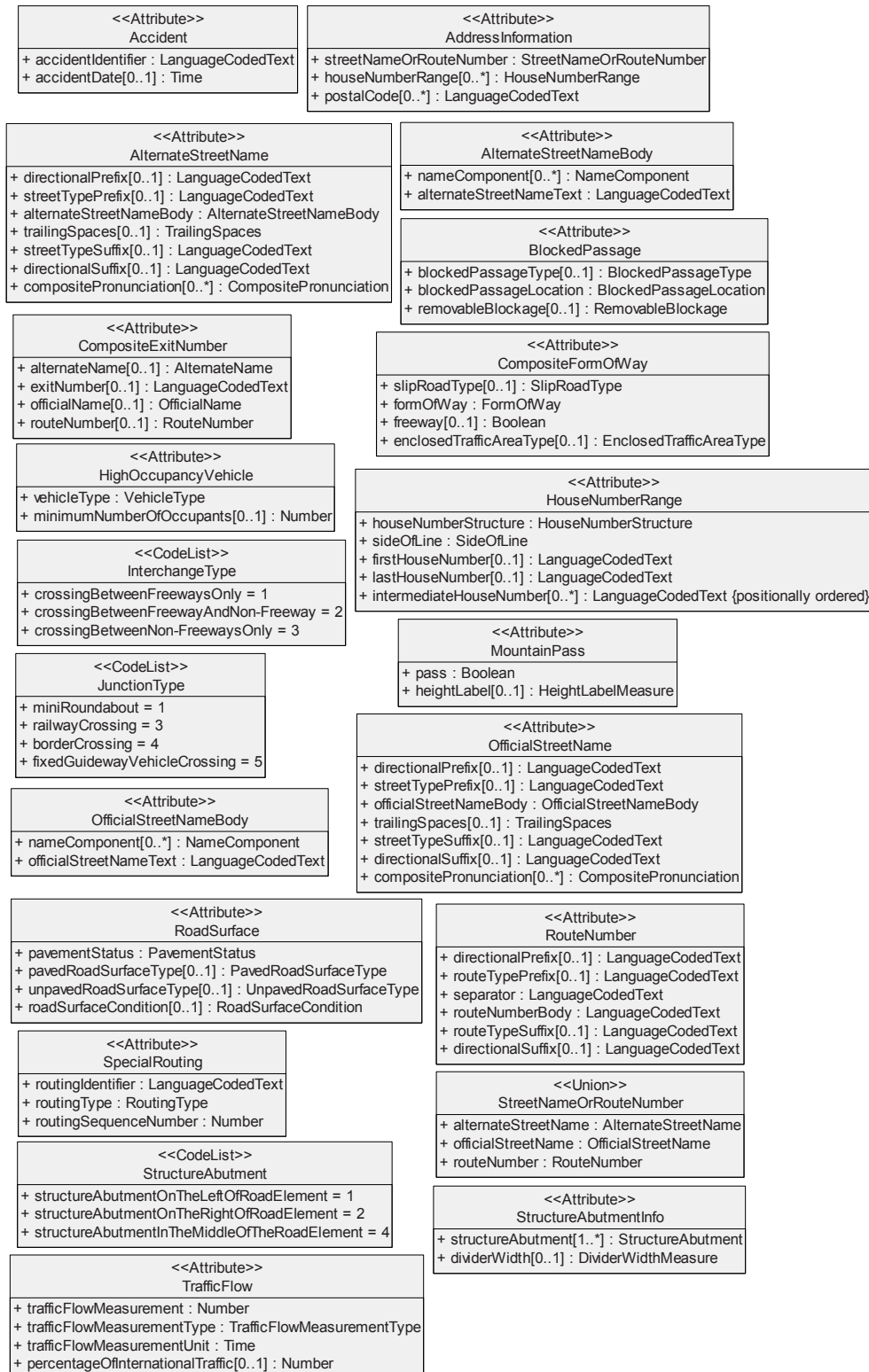

Figure 101 — The Conceptual Data Model for Attributes of Road and Ferries (Continued)

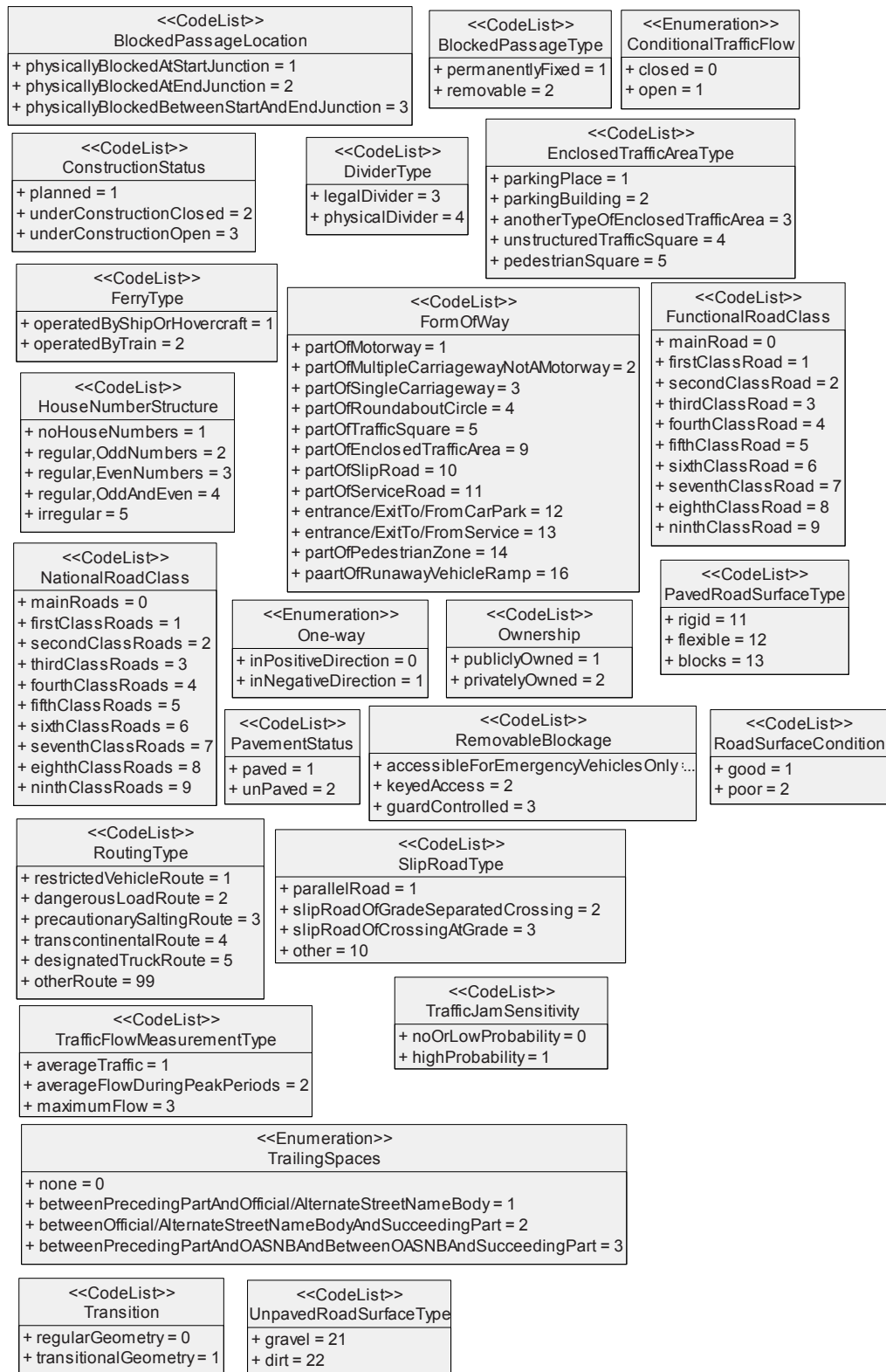

Figure 102 — The Conceptual Data Model for Attributes of Road and Ferries (Continued)



Figure 103 — The Conceptual Data Model for Attributes of Road Element Features

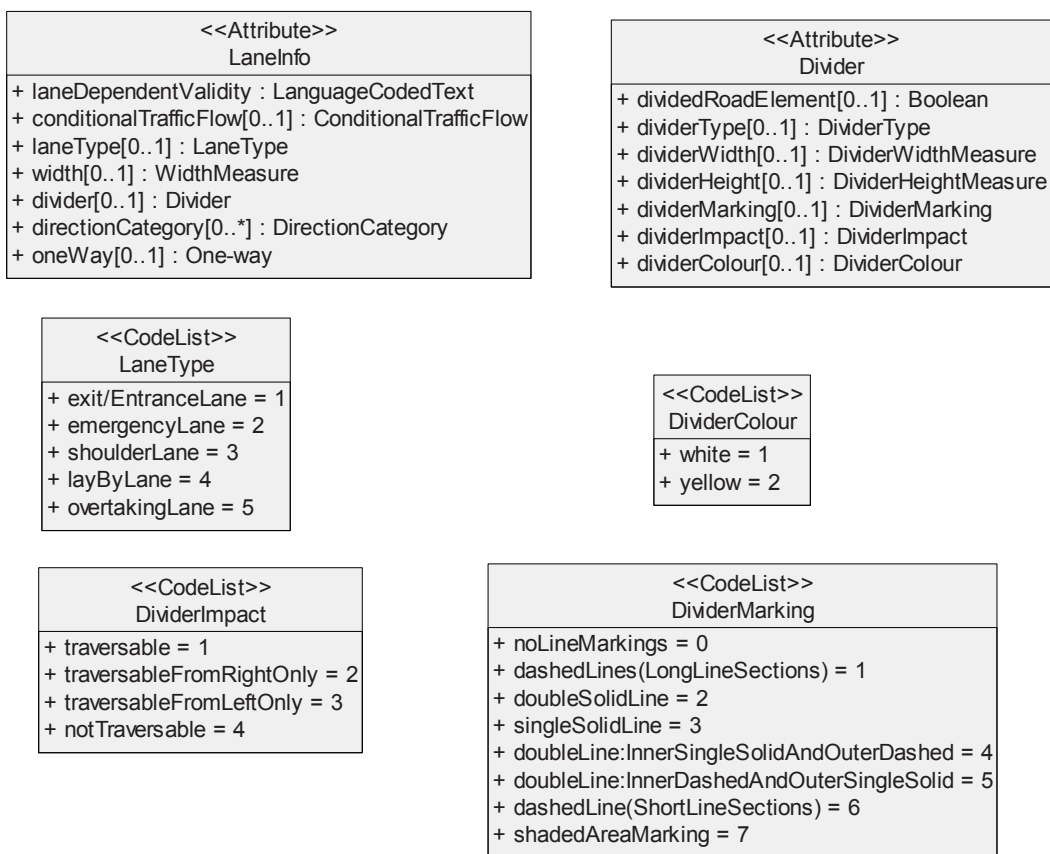

Figure 104— The Conceptual Data Model for Attributes of Road Element Features (Lane Attributes)

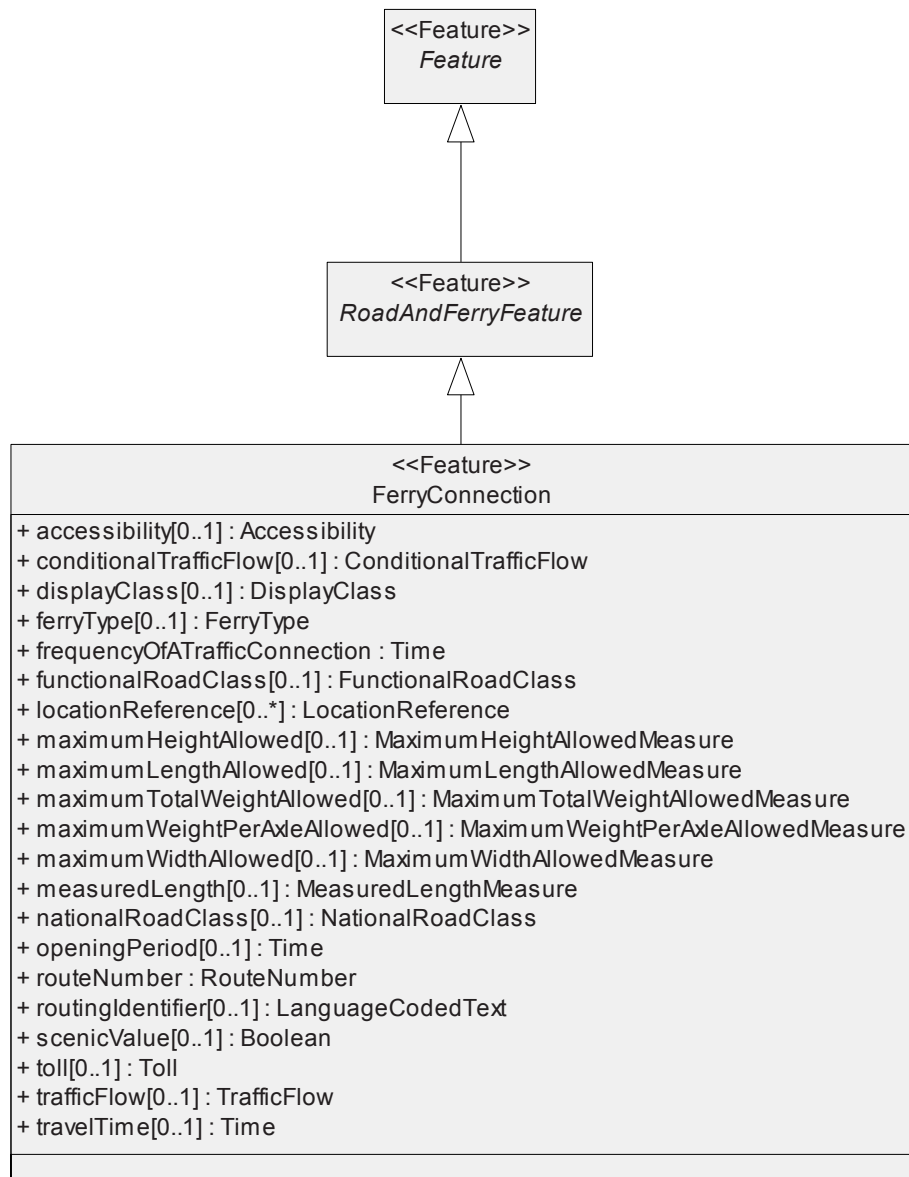

Figure 105 — The Conceptual Data Model for Attributes of Ferry Connection Features

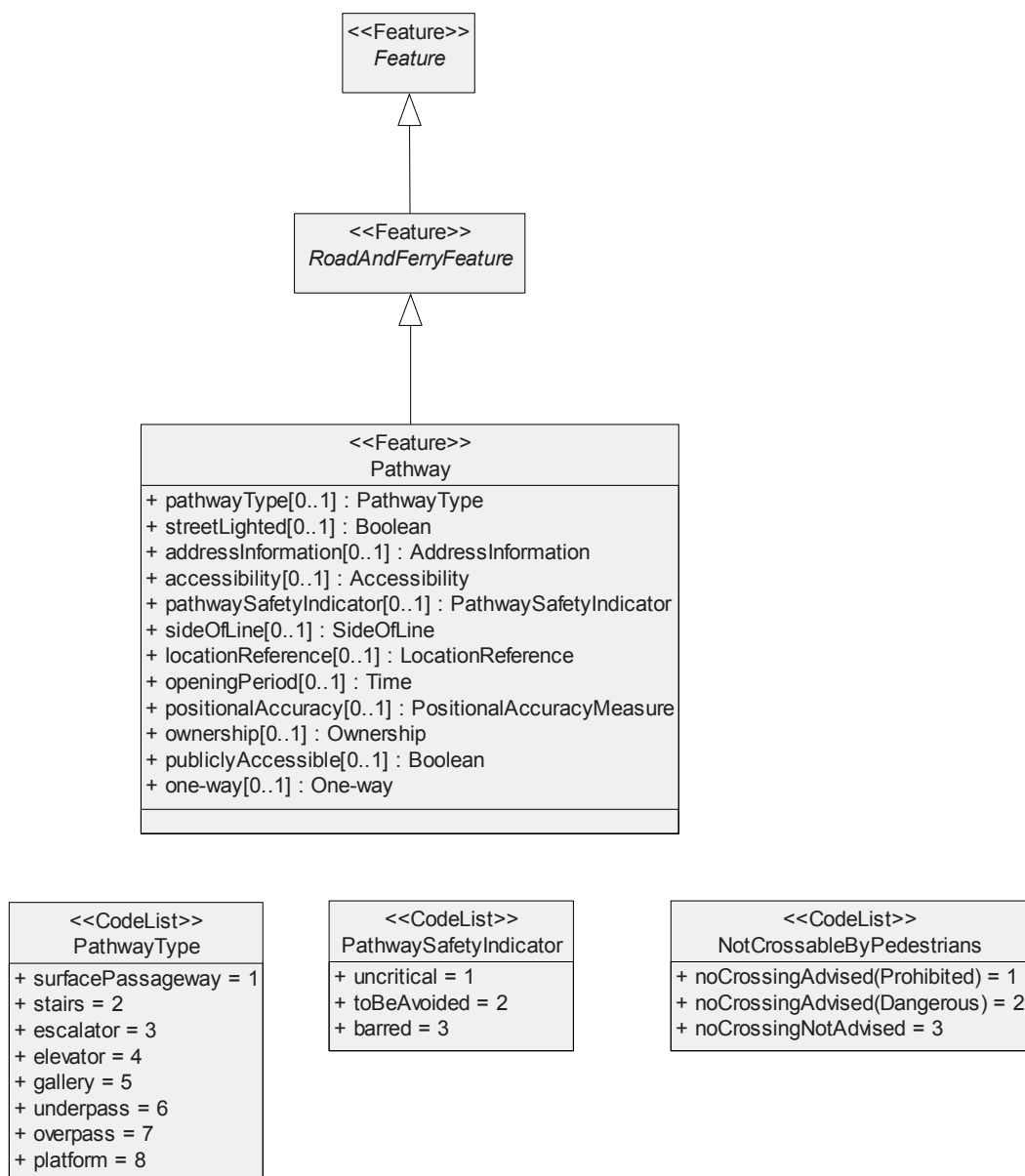

Figure 106 — The Conceptual Data Model for Attributes of Pathways

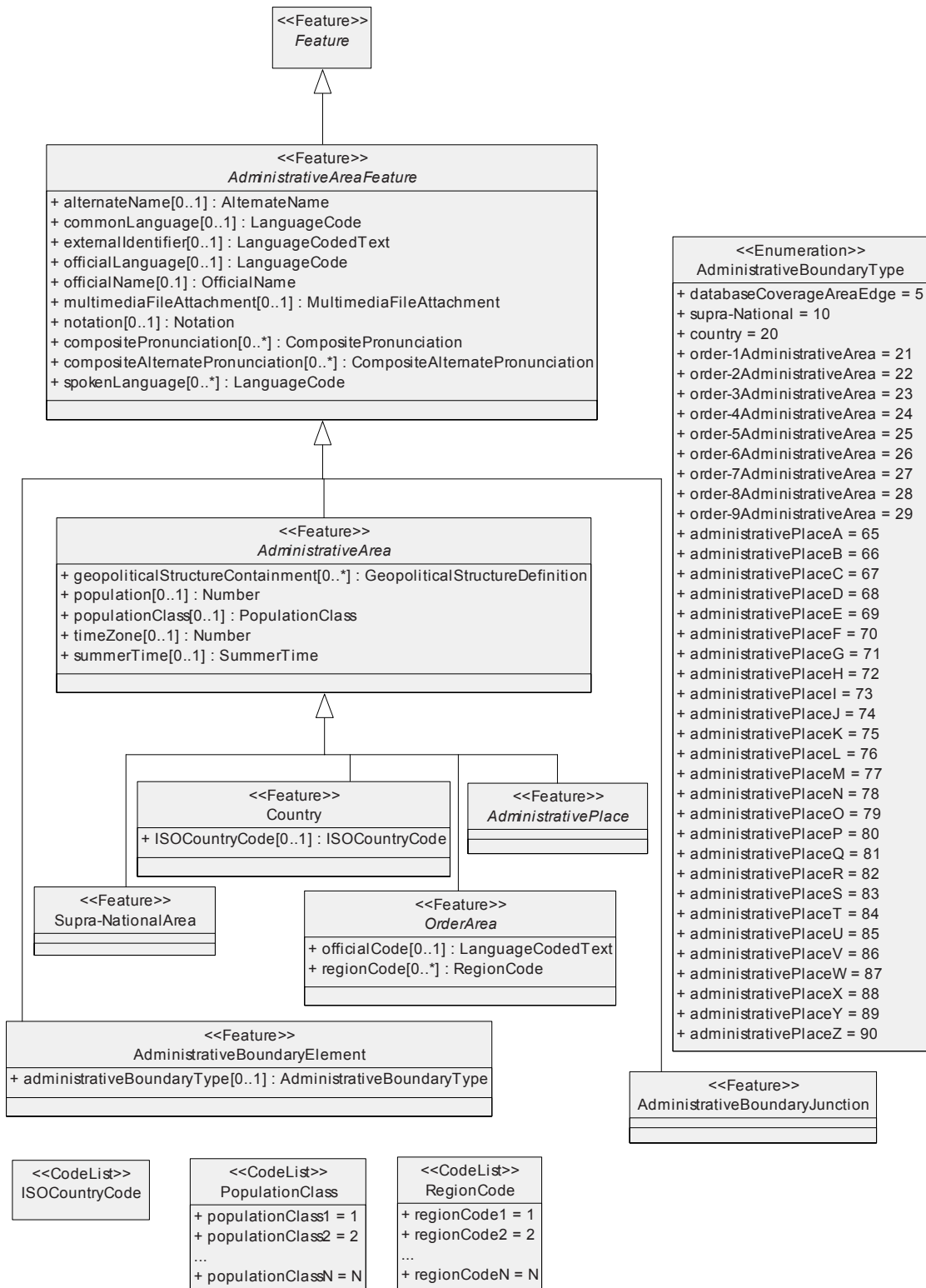

Figure 107 — The Conceptual Data Model for Attributes of Administrative Areas

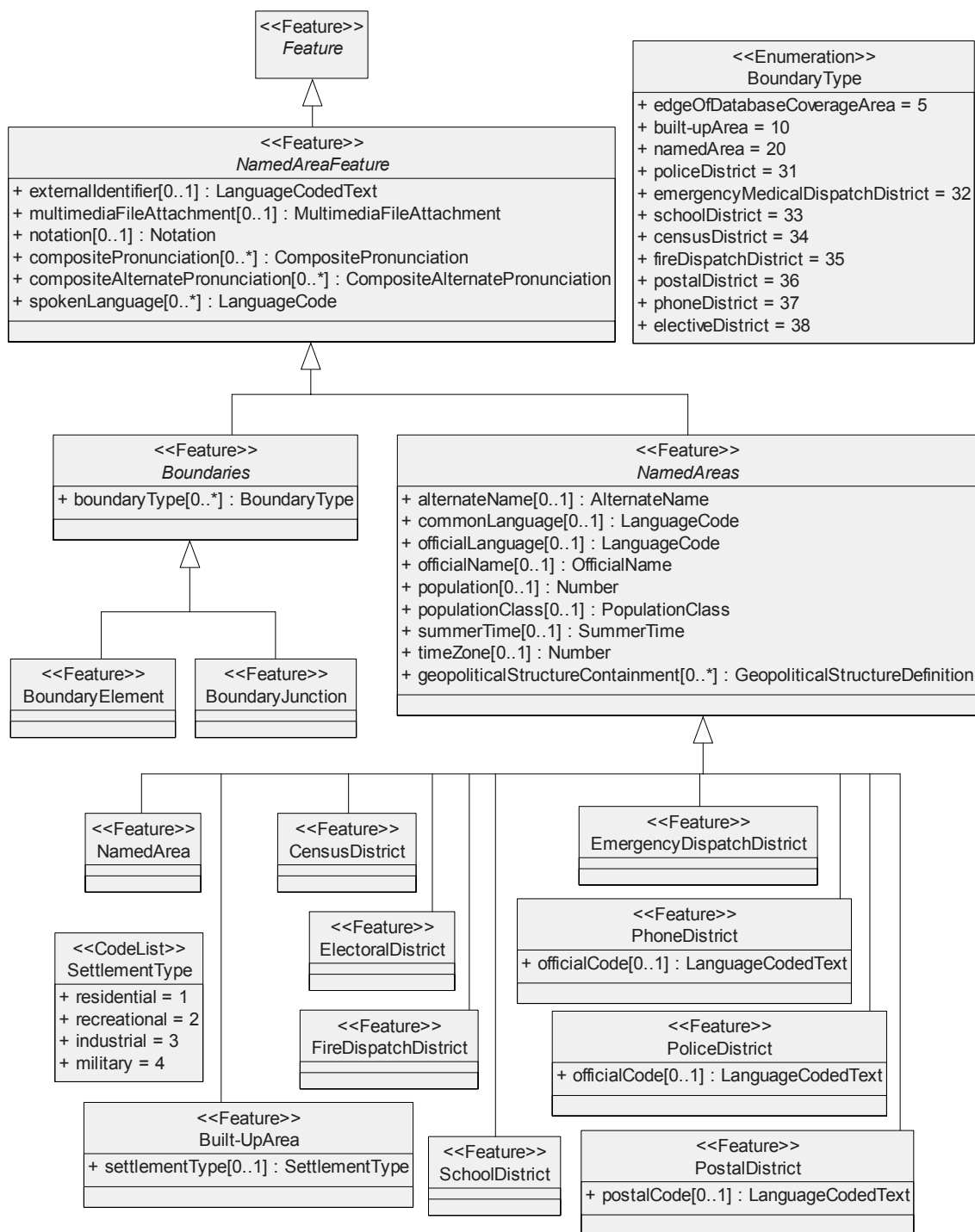

Figure 108 — The Conceptual Data Model for Attributes of Named Areas

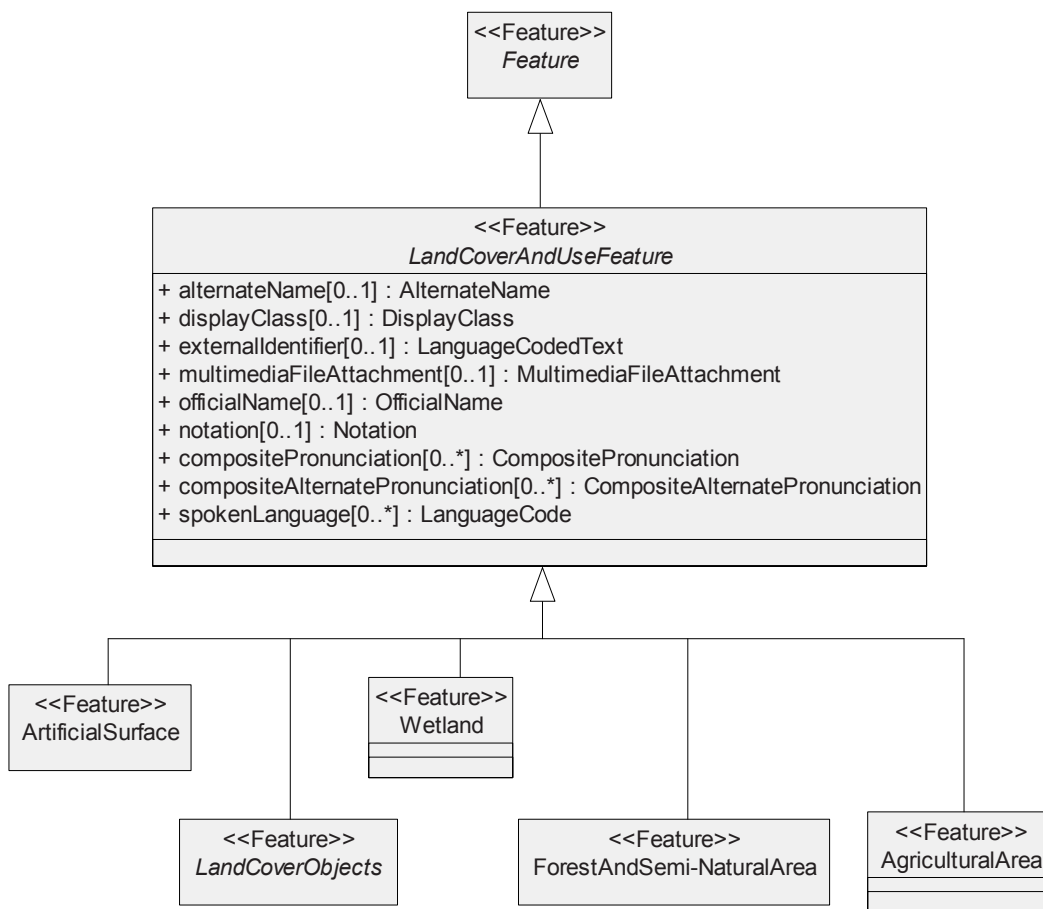

Figure 109 — The Conceptual Data Model for Attributes of Land Cover and Use

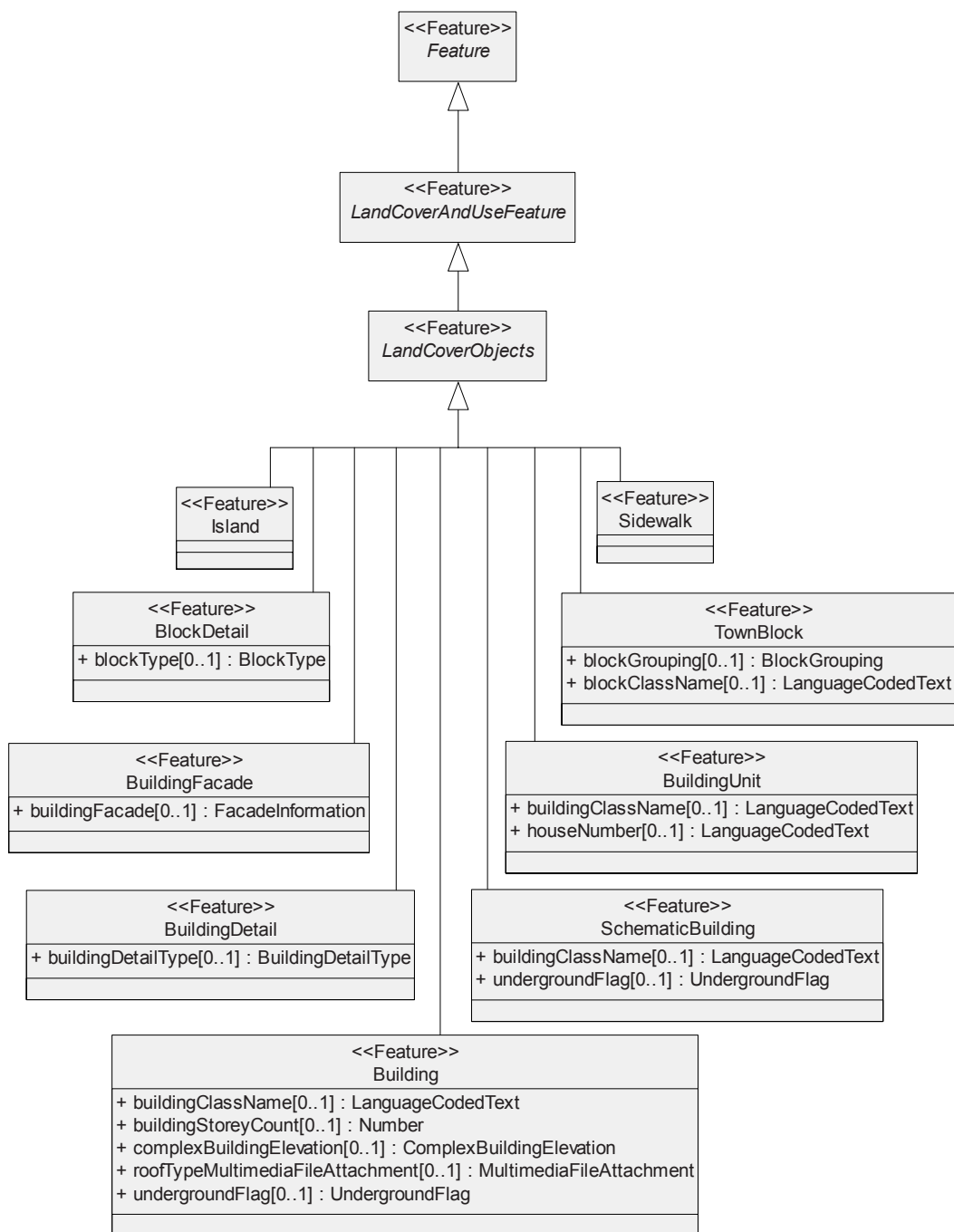

Figure 110 — The Conceptual Data Model for Attributes of Land Cover and Use: Subtype Land Cover Objects

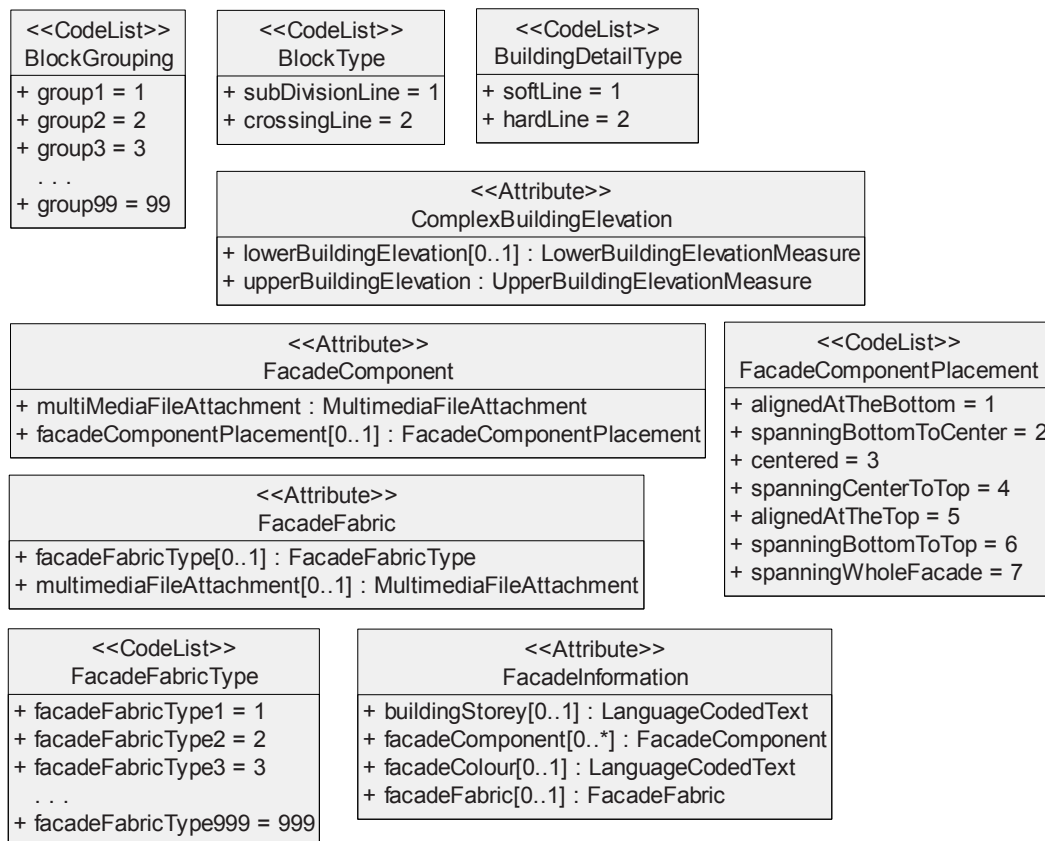

Figure 111 — The Conceptual Data Model for Support Classes for Land Cover Object Attributes

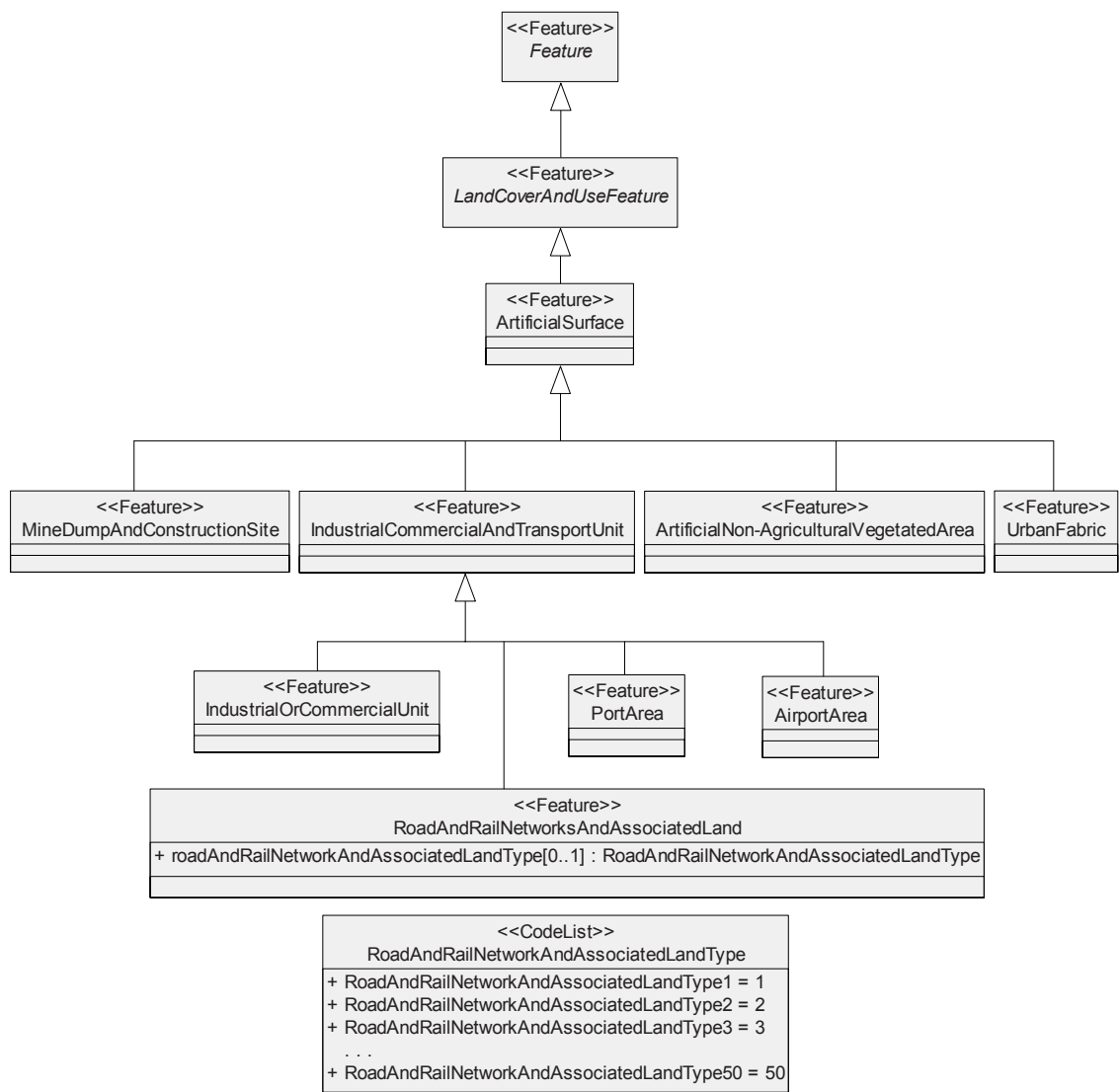
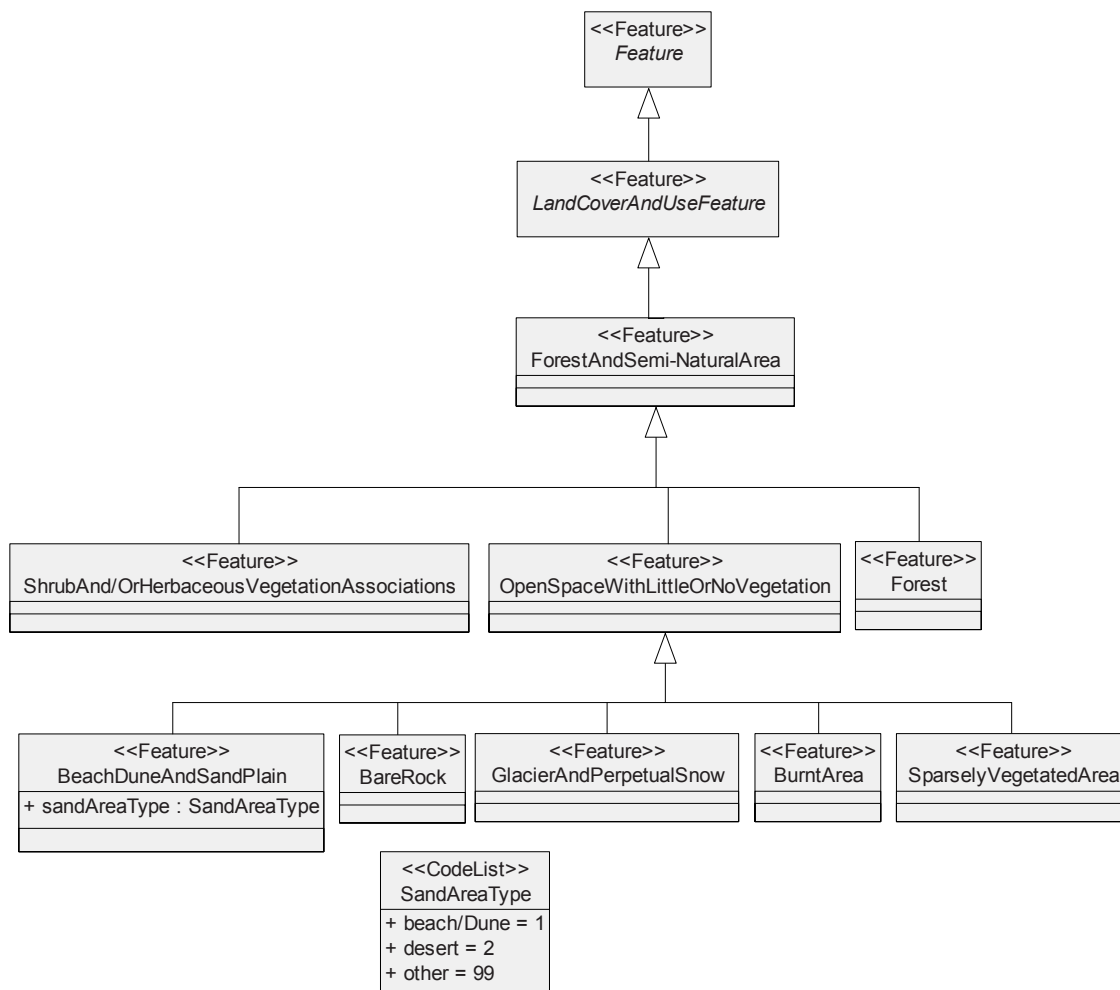

Figure 112 — The Conceptual Data Model for Attributes of Land Cover and Use:
 Subtype Artificial Surfaces



**Figure 113 — The Conceptual Data Model for Attributes of Land Cover and Use:
 Subtype Forest And Semi-Natural Areas**

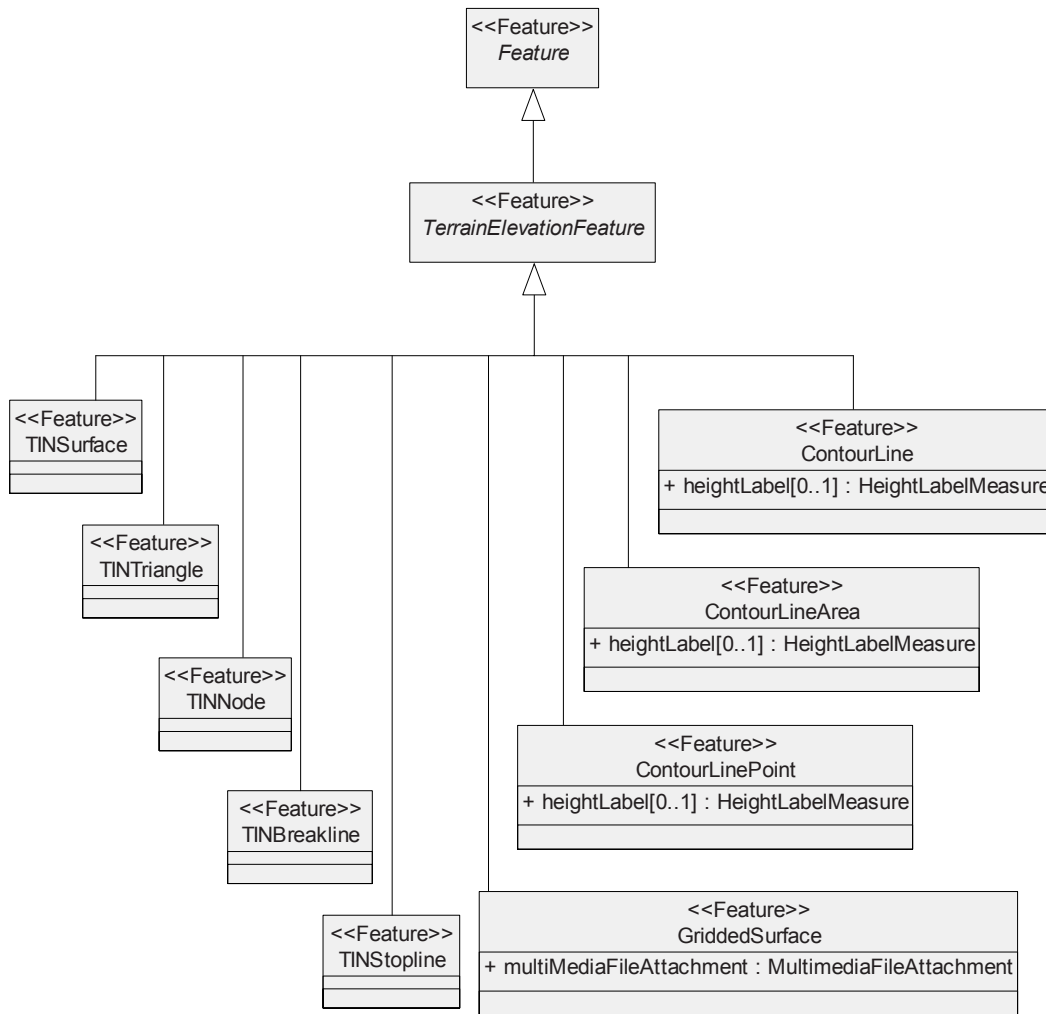

Figure 114 — The Conceptual Data Model for Attributes of Terrain Elevation Features

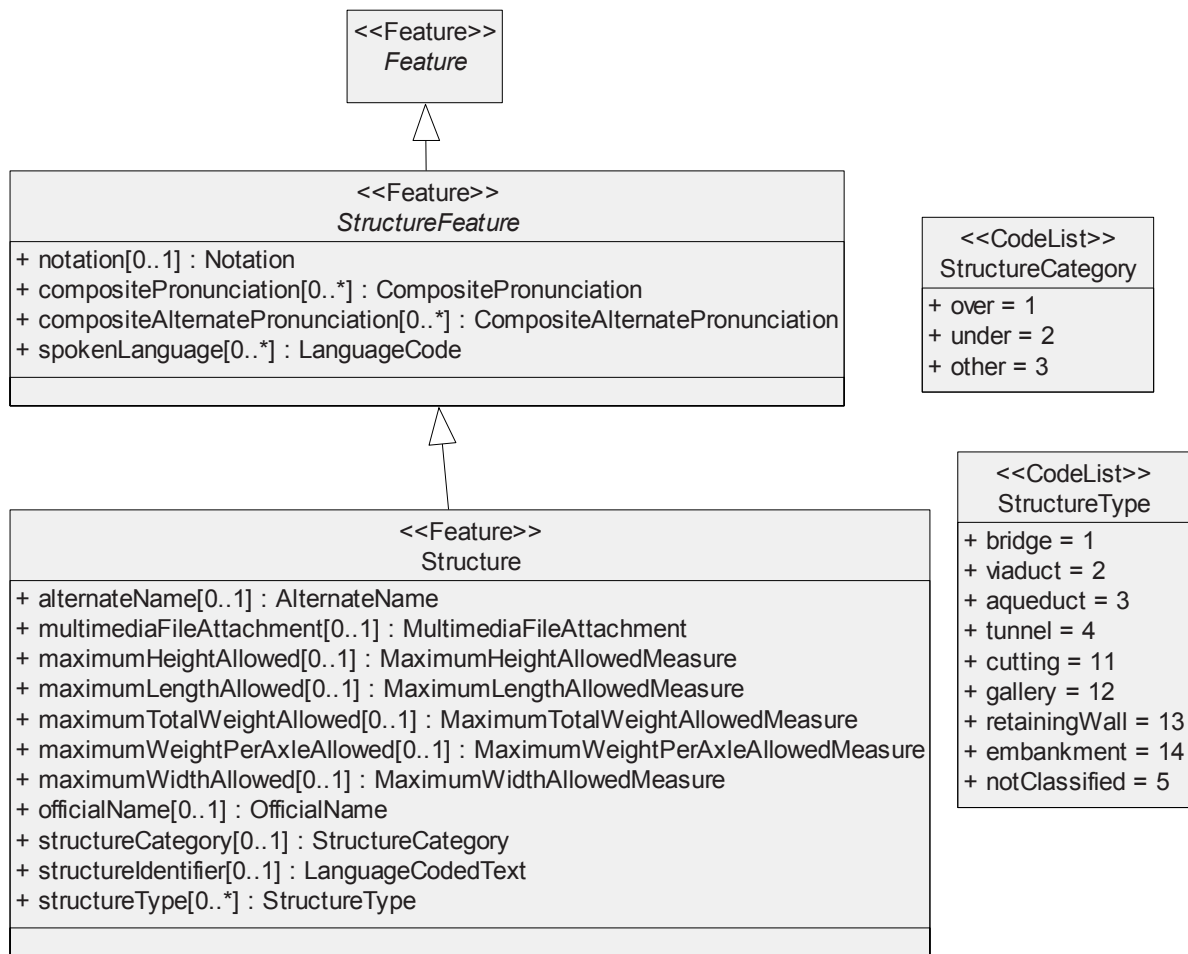

Figure 115 — The Conceptual Data Model for Attributes of Structures

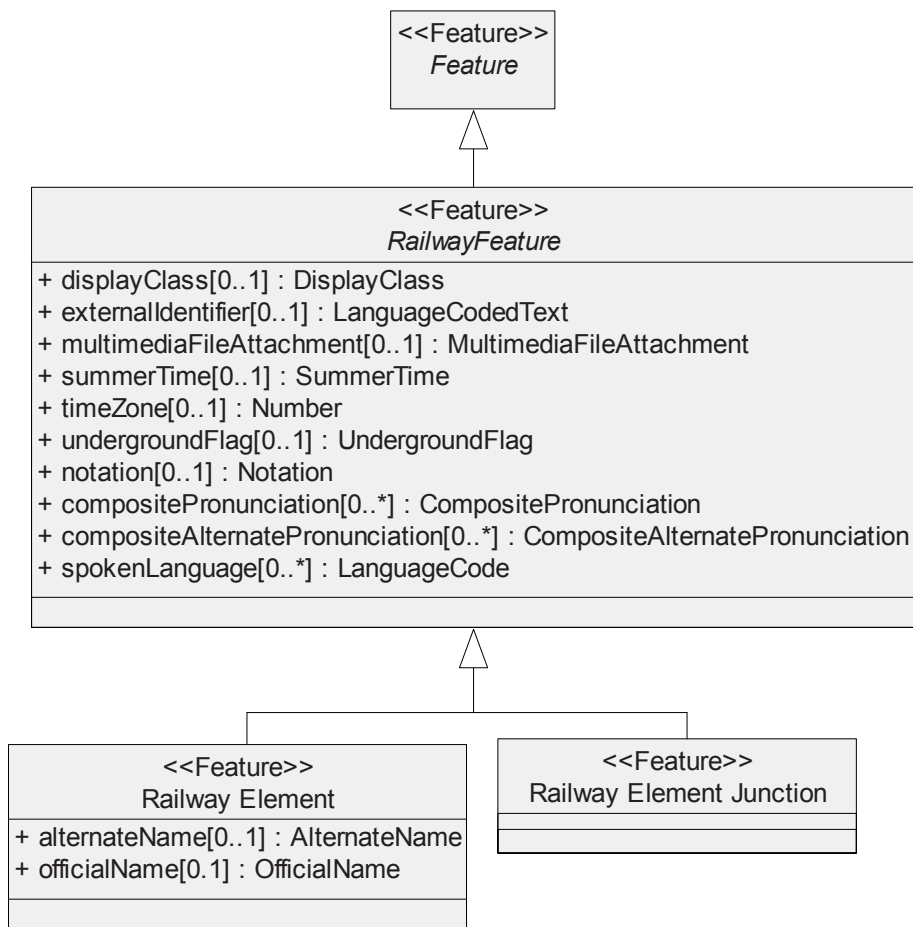

Figure 116 — The Conceptual Data Model for Attributes of Railway Features

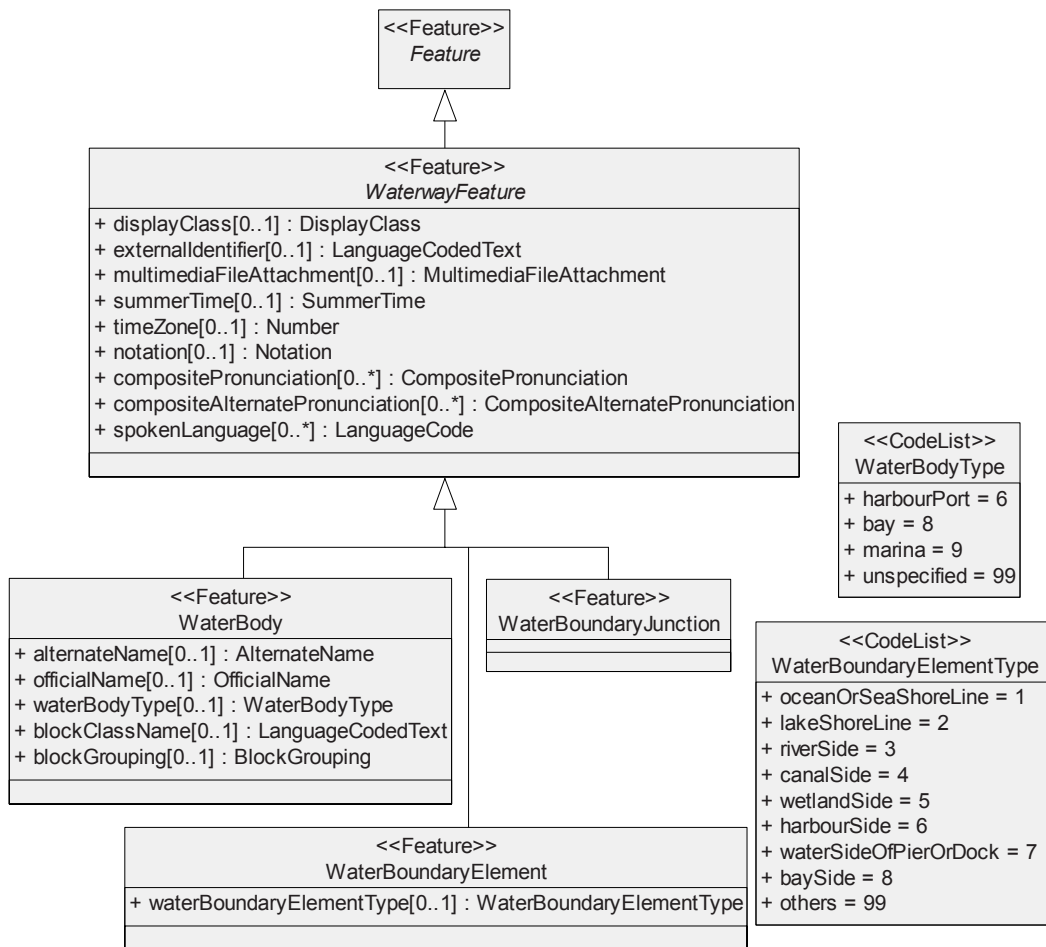

Figure 117 — The Conceptual Data Model for Attributes of Waterways

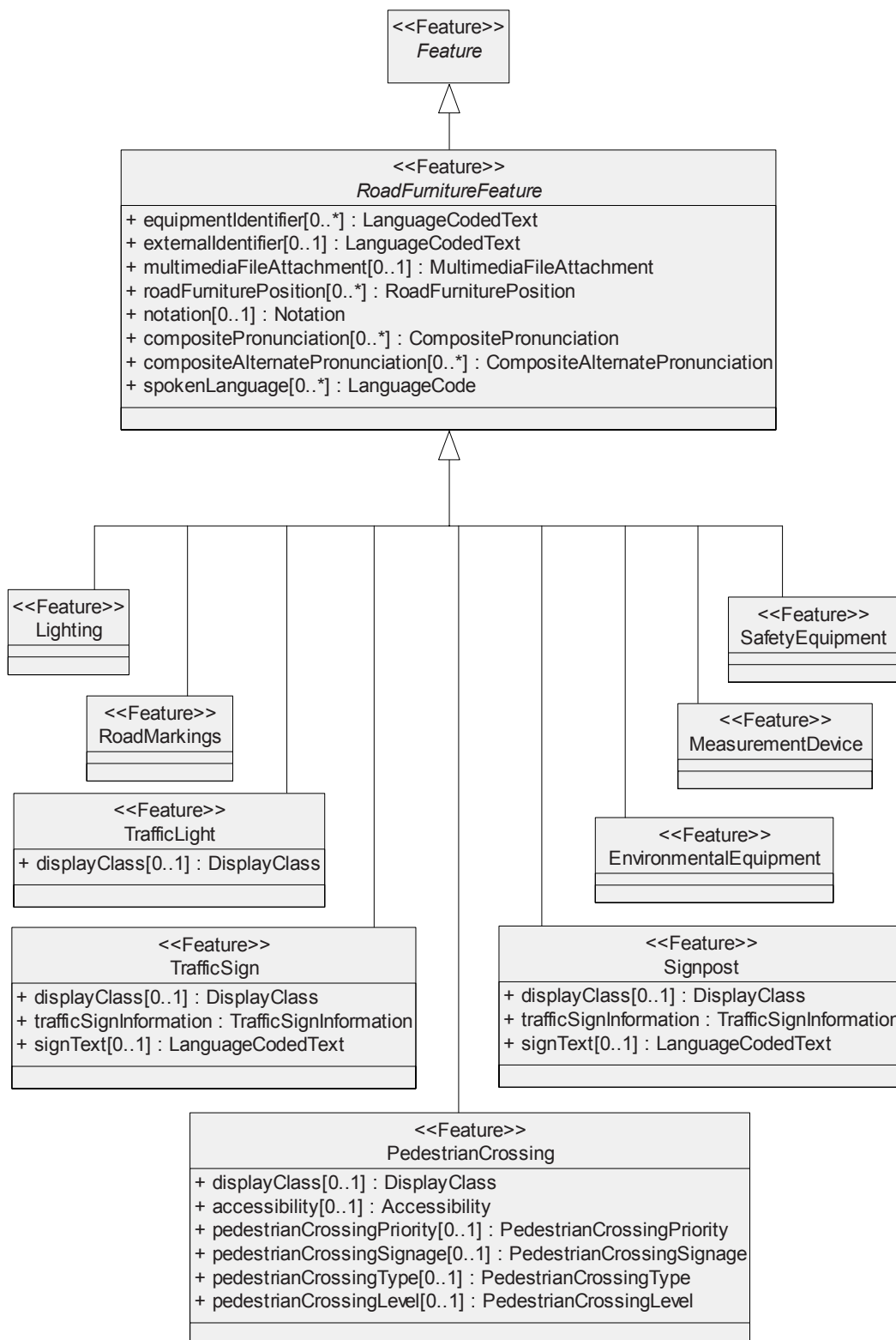

Figure 118 — The Conceptual Data Model for Attributes of Road Furniture

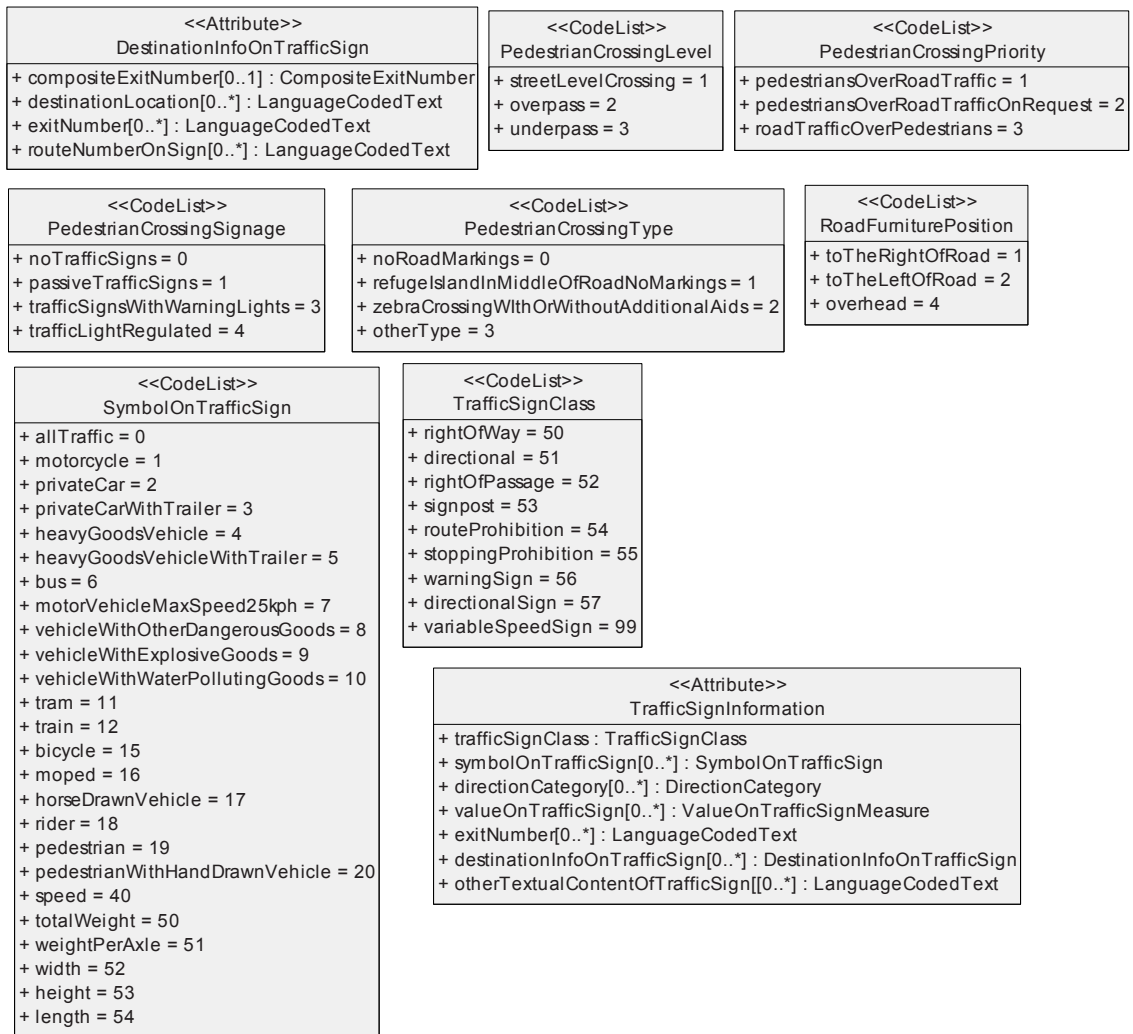

Figure 119 — The Conceptual Data Model for Support Classes for Road Furniture Attributes

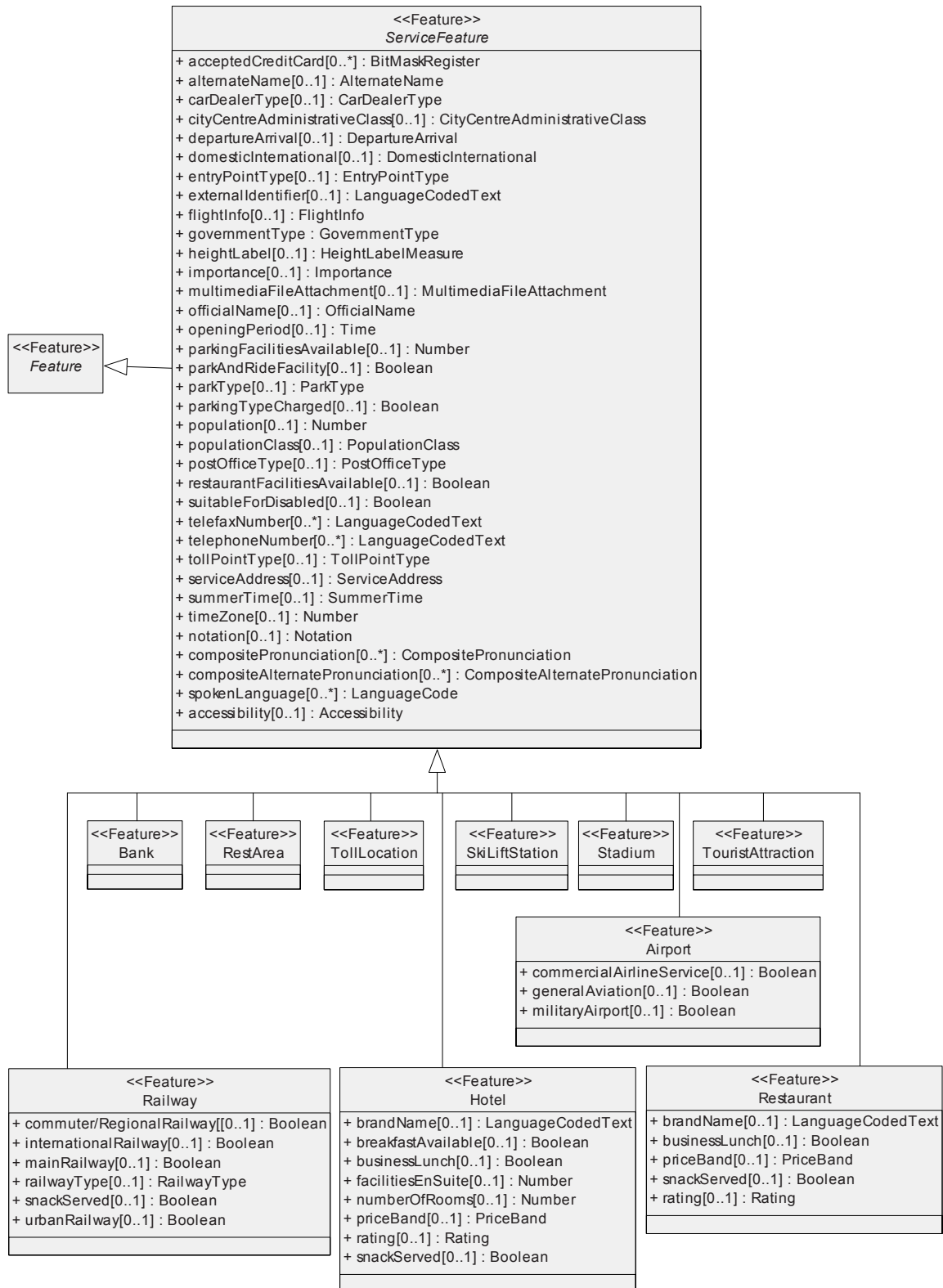

Figure 120 — The Conceptual Data Model for Attributes of Services

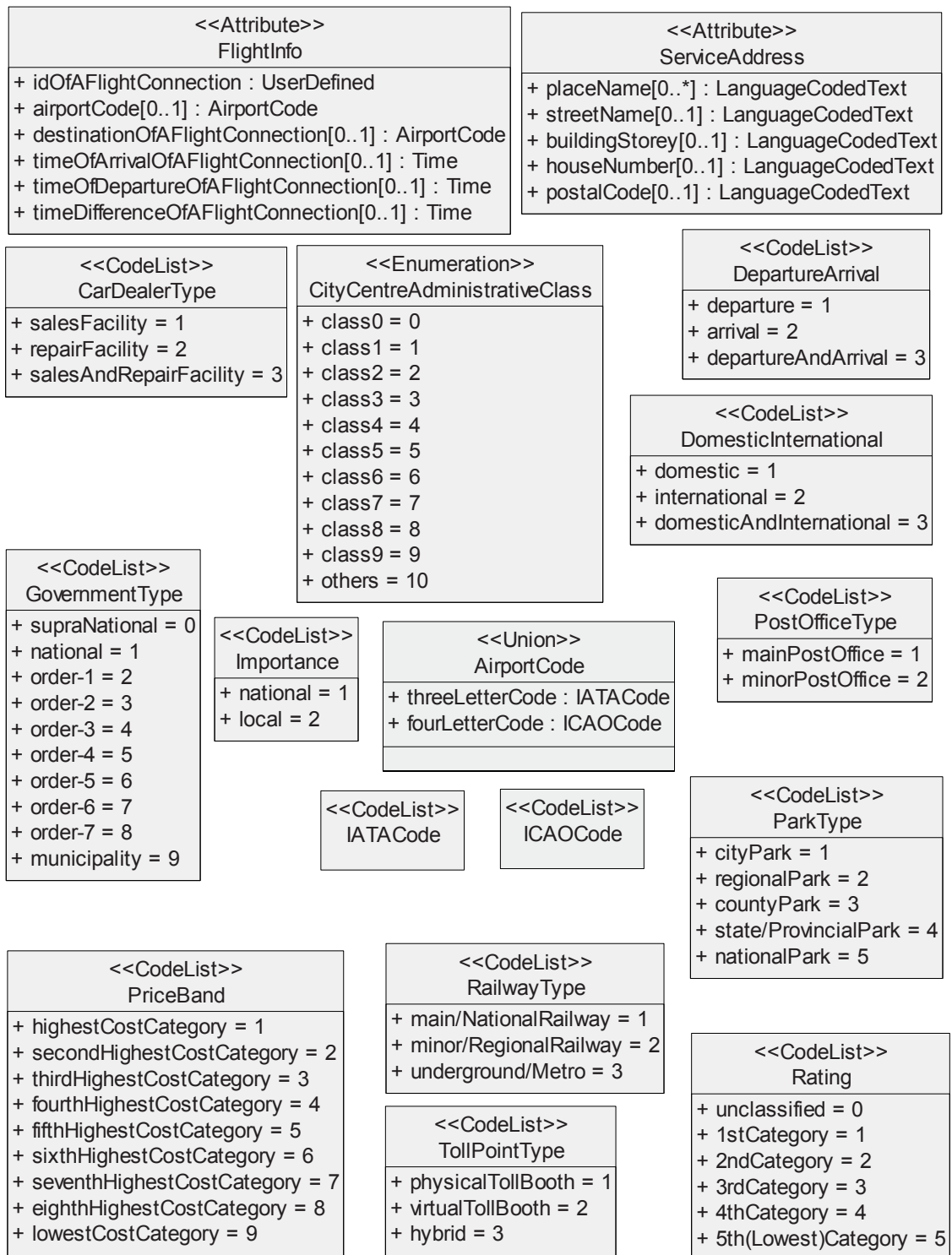

Figure 121 — The Conceptual Data Model for Attributes of Services (Continued)

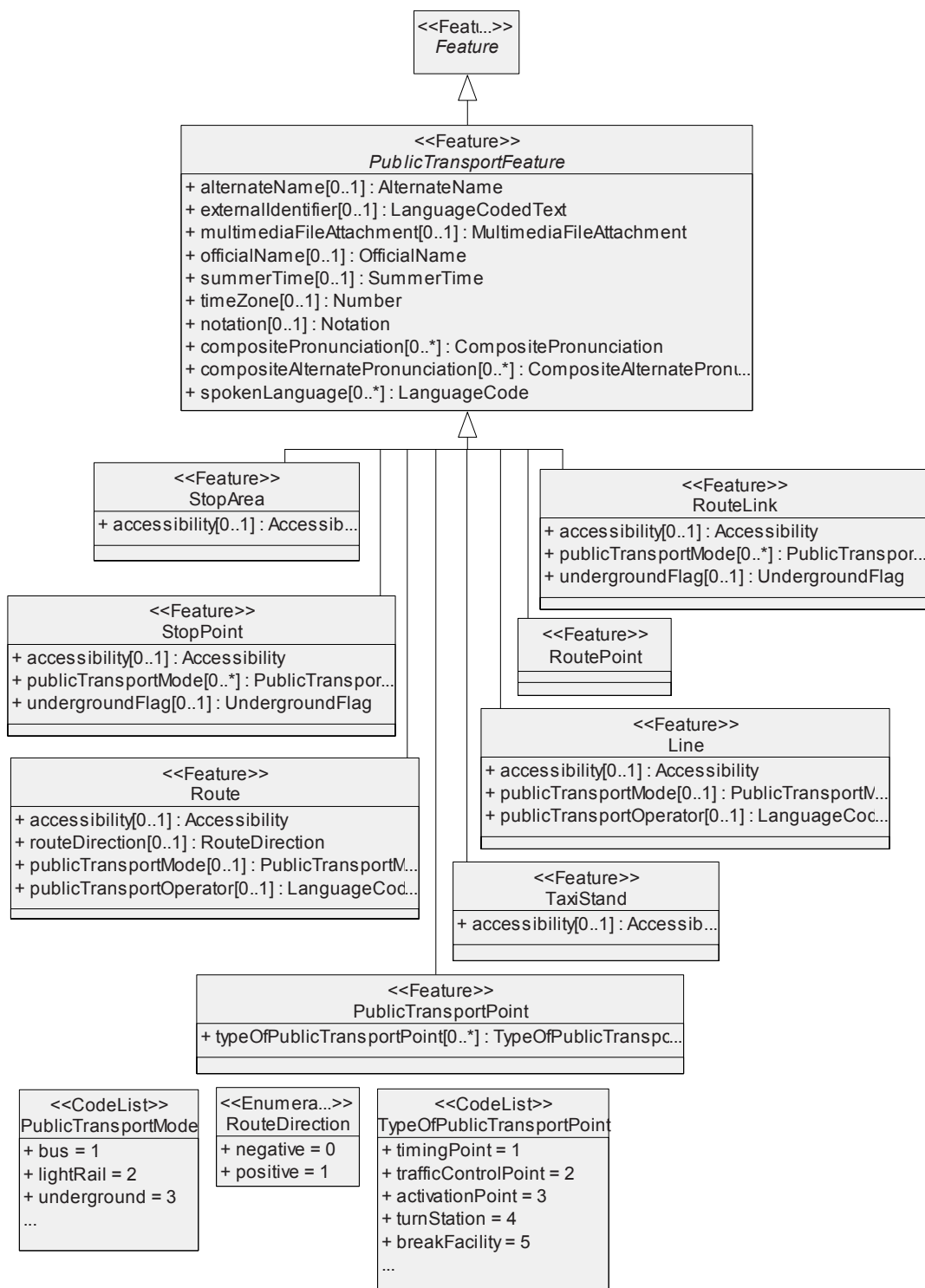

Figure 122 — The Conceptual Data Model for Attributes of Public Transport Features

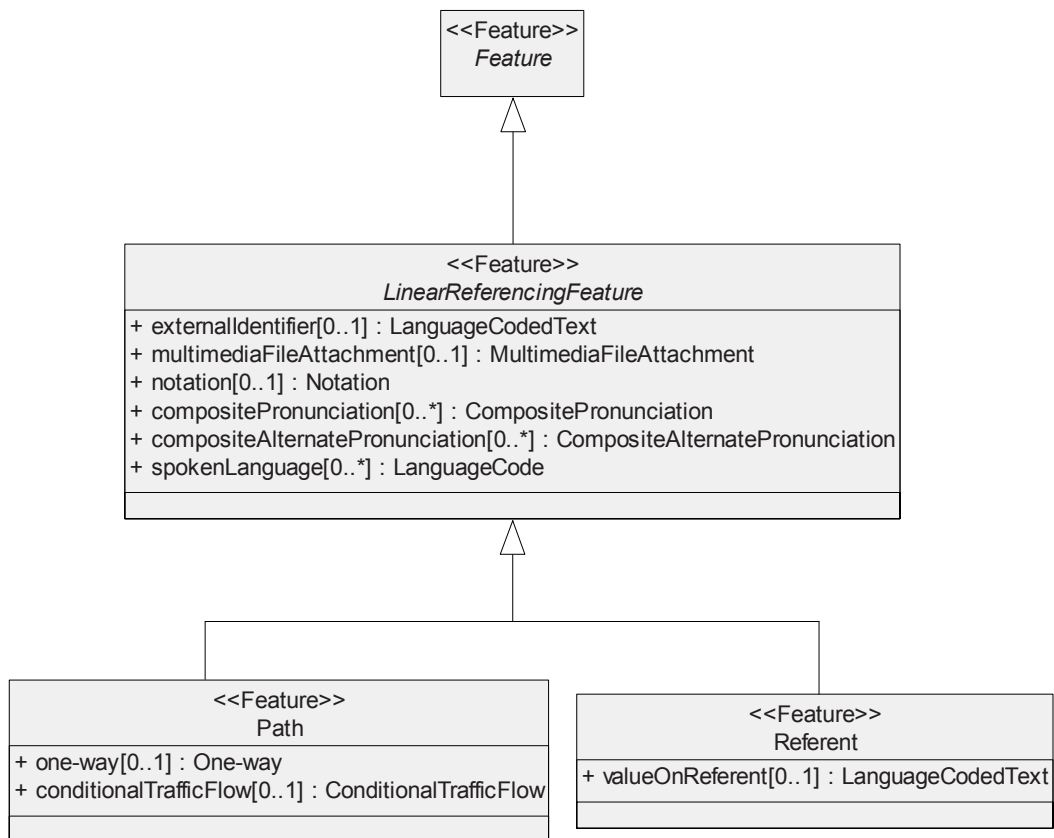

Figure 123 — The Conceptual Data Model for Attributes of Linear Referencing Features

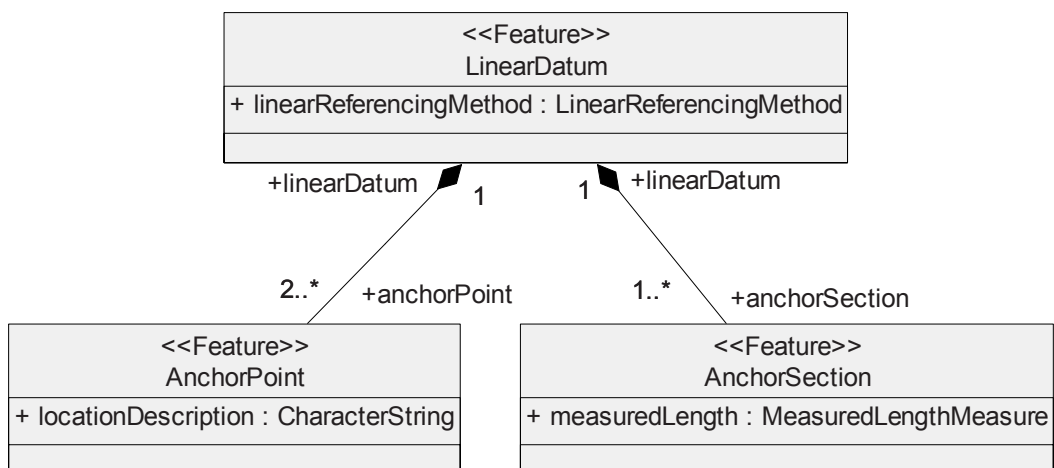

Figure 124 — The Conceptual Data Model for Attributes of Linear Datum Features

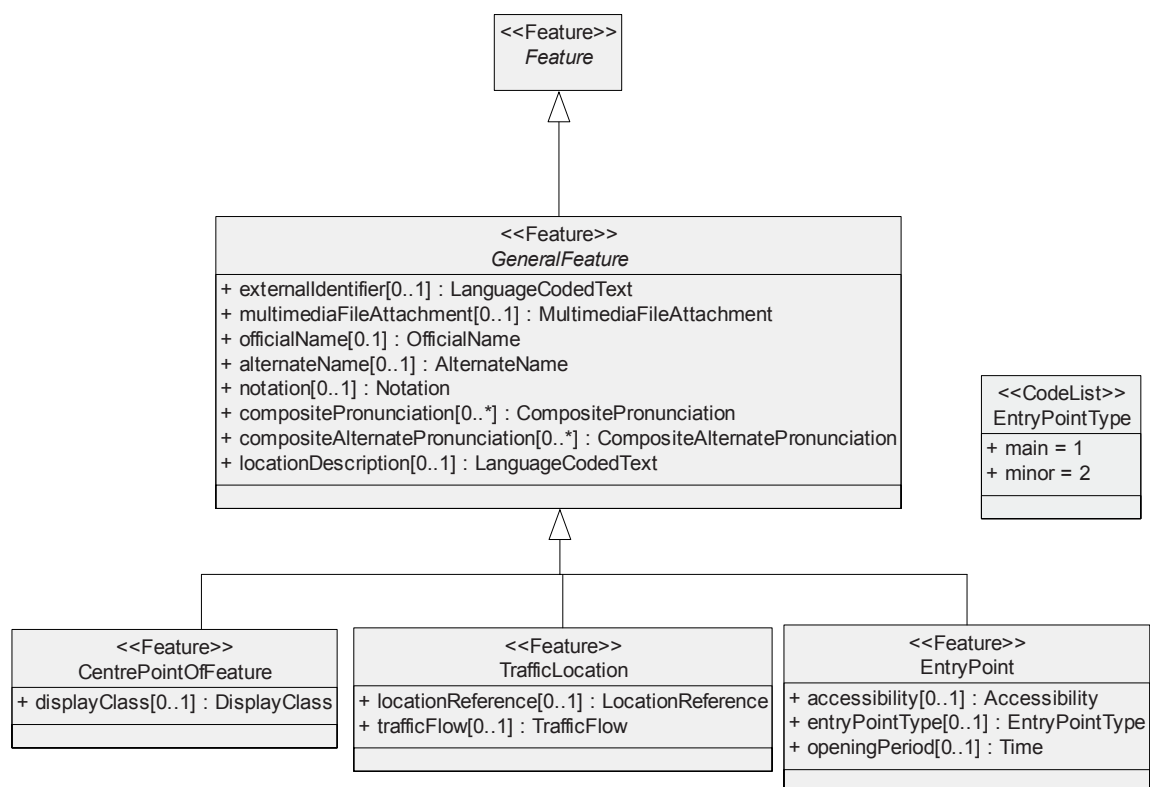

Figure 125 — The Conceptual Data Model for Attributes of General Feature

7.2 Attributes

7.2.1 Accepted Credit Cards

7.2.1.1 Definition

A list of recognized credit cards accepted by a Service.

7.2.1.2 Domain/unit of measure

For each of the recognized credit cards a value is given as follows:

- Accepted
- Not Accepted

What is considered as a recognized credit card is not specified by the standard.

7.2.2 Accessibility

7.2.2.1 Definition

Accessibility of road elements to people with accessibility limitations.

7.2.2.2 Domain/unit of measure

Composite.

7.2.2.3 Sub-Attributes

- Suitable for Disabled or Challenged
- Accessibility Limitation
- Infrastructure Accessibility Aids — [].[.]

NOTE [].[.] indicates that the Sub-Attribute can have multiple instances in the framework of the Composite Attribute.

7.2.2.4 Description

Accessibility refers to a Road Element, Ferry Crossings, or a Pathway, or to Public Transport Features, or Pedestrian Crossings, or possibly some Services. The Composite Attribute is composed of the Sub-Attribute Suitable for Disabled or Challenged, the composite Sub-Attribute Accessibility Limitation, and the Sub-Attribute Infrastructure Accessibility Aids, which defines classes of aids for accessibility.

7.2.3 Accessibility Limitation

7.2.3.1 Definition

Classes of limitations on accessibility.

7.2.3.2 Domain/unit of measure

Composite.

7.2.3.3 Sub-Attributes

- Wheelchair Limitation
- Slow Walker Limitation
- Vision Limitation
- Hearing Limitation

7.2.3.4 Description

Accessibility Limitation is used in conjunction with the Sub-Attributes Suitable for Disabled or Challenged and Infrastructure Accessibility Aids. Together they form the Composite Attribute Accessibility.

Each limitation class can be restricted by the Restrictive Sub-Attribute Pedestrian Type, which details the kinds of pedestrians to which the restrictions apply, and the Restrictive Sub-attribute Validity Period, which expresses temporality associated with accessibility limitations.

7.2.4 Accident

7.2.4.1 Definition

Information about an accident registered by an appropriate organization.

7.2.4.2 Domain/unit of measure

Composite.

7.2.4.3 Sub-Attributes

This Composite Attribute can consist of the following Sub-Attributes:

- Accident Identifier — Mandatory
- Accident Date

7.2.5 Accident Date

7.2.5.1 Definition

The date of an accident.

7.2.5.2 Domain/unit of measure

The value shall be expressed as a single starting date according to the Time Domain Syntax.

7.2.5.3 Description

This Sub-Attribute is used in conjunction with the Sub-Attribute Accident Identifier.

7.2.6 Accident Identifier

7.2.6.1 Definition

A unique alphanumeric identifier, ascribed to an Accident, which may provide a key to an external database.

7.2.6.2 Domain/unit of measure

As specified by the administrating body.

7.2.6.3 Description

This Sub-Attribute can be used in conjunction with the Sub-Attribute Accident Date.

7.2.7 Address Information

7.2.7.1 Definition

The essential components of a street address.

7.2.7.2 Domain/unit of measure

Composite.

7.2.7.3 Sub-Attributes

Address Information can refer to official street addresses, to alternate street addresses or to address information in which a route number is used instead of a street name.

When it refers to official street addresses, this Composite Attribute can consist of the following Sub-Attributes:

- Official Street Name — Mandatory
- House Number Range — [..[]]
- Postal Code — [..[]]

When it refers to alternate street addresses, this Composite Attribute can consist of the following Sub-Attributes:

- Alternate Street Name — Mandatory
- House Number Range — [..[]]
- Postal Code — [..[]]

When it refers to route numbers, this Composite Attribute can consist of the following Sub-Attributes:

- Route Number — Mandatory
- House Number Range — [..[]]
- Postal Code — [..[]]

NOTE [..[]] indicates that the Sub-Attribute can have multiple instances in the framework of the Composite Attribute.

7.2.7.4 Description

Address Information refers to both sides of the Road Element or Pathway.. If Attributes are contained which refer to one side only (e.g. House Number Range) the Restrictive Sub-Attribute Side of Line shall be used. This Sub-Attribute shall also be used in case the Address Information refers to an Address Area Boundary Element.

7.2.8 Administrative Boundary Type

7.2.8.1 Definition

An indication of the Administrative Area which is bounded by the Administrative Boundary Element.

7.2.8.2 Domain/unit of measure

- Country
- Order-1-7 Administrative Area
- Order-8 Administrative Area
- Order-9 Administrative Area
- Supra-National Area
- Administrative Place A-Z (26 entries)
- Edge of the database coverage area

7.2.8.3 Description

For hierarchical Administrative Areas the value shall always indicate the highest-order Administrative Area which is bounded by the Administrative Boundary Element whereby the following order shall be taken into account:

- | | |
|------|---|
| High | <ul style="list-style-type: none">• Supra-National Area• Country• Order-1-7 Administrative Area• Order-8 Administrative Area |
| Low | <ul style="list-style-type: none">• Order-9 Administrative Area |

A boundary of an Administrative Place shall get the according type:

- Boundary of Administrative Place A
- Boundary of Administrative Place B
- Boundary of Administrative Place C
- .
- .
- Boundary of Administrative Place Y
- Boundary of Administrative Place Z

7.2.9 Airport Code

7.2.9.1 Definition

Designated international airport code of an Airport.

7.2.9.2 Domain/unit of measure

The value should be expressed in the international standard IATA three letter airport code [42] or the international standard ICAO four letter airport code [44], respectively. Optionally this may be followed by a one position indication for a possible terminal. If the airport only has one terminal the last character should be a zero or left out.

7.2.10 Alternate Name

7.2.10.1 Definition

The name of a Feature that has no official status but is used or known by the general public.

7.2.10.2 Domain/unit of measure

Composite.

7.2.10.3 Sub-Attributes

This Composite Attribute can consist of the following Sub-Attributes:

- Name Prefix
- Alternate Name Body – Mandatory

7.2.10.4 Description

Alternate Names can include abbreviations or commonly used nicknames. A single Feature may have more than one Alternate Name, often associated with a bilingual situation. A language code shall be used to specify the applied language.

The use of prefixes is not obligatory, even if they make up part of the alternate names. If prefixes are not applied but are part of the official name, they shall be part of the Alternate Name Body.

Spaces are assumed to exist in between the components of the alternate name. They are not explicitly added.

7.2.11 Alternate Name Body

7.2.11.1 Definition

The part of the alternate name which has, compared to the prefix, most identifying power.

7.2.11.2 Domain/unit of measure

Composite.

7.2.11.3 Sub-Attributes

This Composite Attribute can consist of the following Sub-Attributes:

- Name Component [.] . [.]
- Alternate Name Text – Mandatory

NOTE [.] . [.] indicates that the Sub-Attribute can have multiple instances in the framework of the Composite Attribute.

This Attribute is used as a Sub-Attribute, possibly in conjunction with the Sub-Attribute Name Prefix. Together these form the Composite Attribute Alternate Name.

7.2.11.4 Description

In most cases it will be sufficient to sub-divide the official name on name body level. In these cases Alternate Name Body will consist of one instance of Alternate Name Text and zero instances of Name Component. In

certain cases a need may exist to be able to further sub-divide the Alternate Name Body. In these cases, Alternate Name Body consists of one instance of Alternate Name Text and two or more Name Components.

7.2.12 Alternate Name Text

7.2.12.1 Definition

(A part of) an alternate name.

7.2.12.2 Domain/unit of measure

Any combination of characters and punctuation.

7.2.12.3 Description

This Attribute is used as a Sub-Attribute, possibly in conjunction with the Sub-Attribute Name Component to form the Composite Attribute Alternate Name Body.

7.2.13 Alternate Pronunciation

7.2.13.1 Definition

The phonetic transcription of an alternative pronunciation of a name.

7.2.13.2 Domain/unit of measure

A phonetic string.

7.2.13.3 Description

The Attribute Alternate Pronunciation is used as a Sub-Attribute in conjunction with the Sub-Attributes Pronunciation Variant, Phonetic Alphabet, Pronunciation System, and Transcription Description. Together these Sub-Attributes form the Composite Attribute Composite Alternate Pronunciation.

7.2.14 Alternate Street Name

7.2.14.1 Definition

The name of a Road Element, Pathway or Address Area which has no official status but is used or known by the general public.

7.2.14.2 Domain/unit of measure

Composite.

7.2.14.3 Sub-Attributes

This Composite Attribute can consist of the following Sub-Attributes:

- Directional Prefix
- Street Type Prefix
- Alternate Street Name Body — Mandatory
- Trailing Spaces
- Street Type Suffix
- Directional Suffix
- Composite Pronunciation [.]..[.]

NOTE [.]..[.] indicates that the Sub-Attribute can have multiple instances in the framework of the Composite Attribute.

This Attribute is used as a Sub-Attribute possibly in conjunction with the Sub-Attribute House Number Range and Postal Code. Together these form the Composite Attribute Address Information.

7.2.14.4 Description

The use of pre- or suffixes is not obligatory, even if they make up part of the street names. If pre- or suffixes are not applied but are part of the street name, they shall be part of the Alternate Street Name Body. Also combinations are allowed. E.g. a Street Type Prefix might be separately defined in a Street Type Prefix while the Street Type Suffix is defined as part of the Alternate Street Name Body.

Spaces are assumed to exist in between the different components of the street name. They are not explicitly added. One exception exists on this point: spaces preceding and/or succeeding the Alternate Street Name Body are not assumed. These should be explicitly defined. For this, the Sub-Attribute Trailing Spaces has been defined.

A single Road Element or Pathway may have more than one Alternate Street Name. This often is associated with a bilingual situation. A language code shall be used to specify the applied language.

How the application of the different Sub-Attributes in a particular GDF has been done can be specified through meta information.

The fact that Alternate Street Name instead of an Official Street Name has been defined can not be concluded from every Sub-Attribute which make up the Street Name. This conclusion can only be drawn from the Sub-Attribute Alternate Street Name Body or Official Street Name Body. The rest of the Sub-Attributes are identical for both types of Street Names.

7.2.15 Alternate Street Name Body

7.2.15.1 Definition

The part of the alternate street name which has, compared to the other parts the most identifying power.

7.2.15.2 Domain/unit of measure

Composite.

7.2.15.3 Sub-Attributes

This Composite Attribute can consist of the following Sub-Attribute:

- Name Component [..][.]
- Alternate Street Name Text — Mandatory

NOTE [..][.] indicates that the Sub-Attribute can have multiple instances in the framework of the Composite Attribute.

This Attribute is used as a Sub-Attribute possibly in conjunction with the Sub-Attributes Directional Prefix, Street Type Prefix, Trailing Spaces, Street Type Suffix, Directional Suffix and Composite Pronunciation. Together these form the Composite Attribute Alternate Street Name.

7.2.15.4 Description

In most cases it will be sufficient to sub-divide the Street Name on Street Name Body level. In these cases Alternate Street Name Body will consist of one instance of Alternate Street Name Text and zero instances of Name Component. In certain cases a need may exist to be able to further sub-divide the street name body. In these cases, the Alternate Street Name Body consists of one instance of Alternate Street Name Text and two or more Name Components.

7.2.16 Alternate Street Name Text

7.2.16.1 Definition

(A part of) an alternate street name.

7.2.16.2 Domain/unit of measure

Any combination of characters, numbers or punctuation.

7.2.16.3 Description

This Attribute is used as a Sub-Attribute, possibly in conjunction with the Sub-Attribute Name Component to form the Composite Attribute Alternate Street Name Body.

7.2.17 Assignment Order

7.2.17.1 Definition

The position of the source Point Feature in the list of source Point Features of a Multi-Point Assignment or of an Exclusive Multi-Point Assignment.

7.2.17.2 Domain/unit of measure

A positive integer.

7.2.17.3 Description

A Multi-Point Assignment or Exclusive Multi-Point Assignment has one or more source Point Features for a target Line Feature in the assignment. The Assignment Order puts them in consecutive order, being assigned in the increasing direction of the target Line Feature.

This Attribute is used as a Sub-Attribute in conjunction with Distance Expression. Together these Sub-Attributes form the Composite Attribute Point Assignment.

7.2.18 Association Type

7.2.18.1 Definition

The type of association between two Features for which an association has been defined.

7.2.18.2 Domain/unit of measure

- Geographically located in
- Commonly associated with

7.2.18.3 Description

Geographically located in refers to the case in which factual information is represented. Commonly associated with refers to the situation whereby the information represented is in contradiction with the geographical information but represents what is believed to be true by the general public.

7.2.19 Average Vehicle Speed

7.2.19.1 Definition

The average speed of vehicles travelling along a Road Element.

7.2.19.2 Domain/unit of measure

7.2.19.2.1 Value domain

The value should be expressed in either Metric or English default units, or in user-defined units. Metric default unit is kilometre per hour; English default unit is mile per hour.

7.2.19.2.2 Measure

A measure of Average Vehicle Speed is composed of a value and a unit of measure.

7.2.19.2.3 Unit of measure

The unit of measure of Average Vehicle Speed is a Union of three: a Metric default unit, an English default unit, or a user-defined unit. User-defined units allow overriding of the default.

7.2.20 Block Class Name

7.2.20.1 Definition

The functional or usage description of a Town Block or Water Body.

7.2.20.2 Domain/unit of measure

Any combination of letters, numbers or punctuation which forms a valid name.

7.2.20.3 Description

A group of blocks sharing an Attribute value may be displayed in the same colour.

7.2.21 Block Grouping

7.2.21.1 Definition

Grouping of Town Block or Waterways based on the same Attribute value.

7.2.21.2 Domain/unit of measure

- Group 1
- Group 2
- ...
- Group 99

7.2.21.3 Description

A group of blocks sharing an Attribute value may be displayed in the same style, such as Town Blocks belonging to one city or suburb, or a campus.

7.2.22 Block Type

7.2.22.1 Definition

Type of characteristic represented by Block Detail.

7.2.22.2 Domain/unit of measure

- Sub-division Line
- Crossing Line

7.2.22.3 Description

7.2.22.3.1 Definition of Sub-division Line

Line to identify adjacent areas divided by a real or virtual border, such as a sluice gate. For visualisation this allows to depict representative sub-structures within areas of the same display colour or texture.

7.2.22.3.2 Definition of Crossing Line

Line to identify a division between different elevation levels.

7.2.23 Blocked Passage

7.2.23.1 Definition

Indication of a physical barrier on a Road Element.

7.2.23.2 Domain/unit of measure

Composite.

7.2.23.3 Sub-Attributes

This Composite Attribute can consist of the following Sub-Attributes:

- Blocked Passage Location — Mandatory
- Blocked Passage Type
- Removable Blockage

7.2.24 Blocked Passage Location

7.2.24.1 Definition

Indication of a physical obstruction on a Road Element.

7.2.24.2 Domain/unit of measure

- Physically blocked at Start Junction
- Physically blocked at End Junction
- Physically blocked between Start and End Junction

7.2.24.3 Description

The blockage at the Start or End Junction should be interpreted in such a way that in these situations it is not possible to enter the Road Element at that point. When the blockage is near one of these locations but it is possible to actually enter the Road Element, the value “Physically blocked between Start and End Junction” should be applied.

The Attribute Blocked Passage Location is used as a Sub-Attribute in conjunction with the Sub-Attributes Removable Blockage and Blocked Passage Type. Together these Sub-Attributes form the Composite Attribute Blocked Passage.

7.2.25 Blocked Passage Type

7.2.25.1 Definition

The type of blocked passage as an indication of the fact whether it is removable.

7.2.25.2 Domain/unit of measure

- Permanently fixed
- Removable

7.2.25.3 Description

A barrier is considered permanently fixed if the barrier can not be removed without destroying it. It is considered removable if it is designed to free the entrance to the (other side of the) road element that it is blocking.

The Attribute Blocked Passage Type is used as a Sub-Attribute in conjunction with the Sub-Attributes Removable Blockage and Blocked Passage Location. Together these Sub-Attributes form the Composite Attribute Blocked Passage.

7.2.26 Boundary Type

7.2.26.1 Definition

Defines the type of boundary separating Built-up Areas, Named Areas and Districts.

7.2.26.2 Domain/unit of measure

- Edge of Database Coverage Area
- Police District
- Emergency Medical Dispatch District
- School District
- Census District
- Fire Dispatch District
- Postal District
- Phone District
- Elective District
- Named Area
- Built-up Area

7.2.27 Brand Name

7.2.27.1 Definition

The brand name of a Service.

7.2.27.2 Domain/unit of measure

Any combination of letters, numbers or punctuation which forms a valid name.

7.2.27.3 Description

EXAMPLE Renault, Texaco, Q8, or Hilton.

7.2.28 Breakfast Available

7.2.28.1 Definition

This Attribute when True indicates whether breakfast is available as part of the Service.

7.2.28.2 Domain/unit of measure

- True
- False

7.2.29 Building Class Name

7.2.29.1 Definition

The functional or architectural description of the Building.

EXAMPLE Church, or Tower.

7.2.29.2 Domain/unit of measure

Any combination of letters, numbers or punctuation which forms a valid name.

7.2.29.3 Description

Building Class Name only applies to the Feature Building, Schematic Building or Building Unit within the Feature Theme Land Cover And Use.

7.2.30 Building Detail Type

7.2.30.1 Definition

Type of characteristic represented by Building Detail.

7.2.30.2 Domain/unit of measure

- Soft Line
- Hard Line

7.2.30.3 Description

7.2.30.3.1 Definition of Soft Line

Line depicting prominent decorative characteristics, such as painted or imprinted line patterns of a (landmark) building.

7.2.30.3.2 Definition of Hard Line

Line depicting representative edges of the building, such as sub-shapes of a Building having a different elevation.

7.2.31 Building Storey

7.2.31.1 Definition

One or multiple storey(s) of a Building or Building Façade.

7.2.31.2 Domain/unit of measure

A Building Storey is identified by an alphanumeric character or set of characters, possibly including a minus sign. A range of Building Storeys is separated by a tilde ('~'). The enumeration of Building Storeys or Building Storey ranges are listed comma-separated (',').

7.2.31.3 Description

The Attribute Building Storey may be used in conjunction with the Sub-Attributes Façade Component, Façade Colour and Façade Fabric. Together they make up the Composite Attribute Façade Information. In this case the Building Storey numbers must not be negative.

The Attribute Building Storey may be used in conjunction with the Sub-Attributes Place Name, Street Name, House Number, Postal Code. Together they make up the Composite Attribute Service Address.

Numbering conventions depend on the usage within the context of the respective Composite Attributes.

7.2.32 Building Storey Count

7.2.32.1 Definition

The total number of full storeys of a Building above ground.

7.2.32.2 Domain/unit of measure

An integer number.

7.2.32.3 Description

The lowest storey representing the ground level is numbered 1, regardless whether a Lower Building Elevation is specified or not. In case it is specified, the Building Storey Count represents the number of virtual storeys plus the number of real storeys (as if the building structure would not be elevated).

The roof shall not be taken into account in the count.

7.2.33 Business Lunch

7.2.33.1 Definition

This Attribute when True indicates whether business lunch is available.

7.2.33.2 Domain/unit of measure

- True
- False

7.2.34 Car Dealer Type

7.2.34.1 Definition

Whether a Car Dealer offers sales facilities, repair facilities or a combination of both.

7.2.34.2 Domain/unit of measure

- Sales Facility
- Repair Facility
- Sales and Repair Facility

7.2.35 City Centre Administrative Class

7.2.35.1 Definition

An indication of the administrative importance of a City Centre.

7.2.35.2 Domain/unit of measure

- Class 0: Capital of Country
- Class 1: Capital of the Order-1 Area
- Class 2: Capital of the Order-2 Area
- Class 3: Capital of the Order-3 Area
- Class 4: Capital of the Order-4 Area
- Class 5: Capital of the Order-5 Area
- Class 6: Capital of the Order-6 Area
- Class 7: Capital of the Order-7 Area
- Class 8: Main settlement of Order-8 Area
- Class 9: Main settlement of Order-9 Area
- Others: Remaining City Centres (e.g. hamlet, town quarters)

7.2.35.3 Description

Class 1 to 7 are country dependent and may not all be present. However, a general rule is that Class *i* is always more important than Class *i*+1.

7.2.36 Commercial Airline Service

7.2.36.1 Definition

This Attribute when True indicates whether an airport offers scheduled flight services.

7.2.36.2 Domain/unit of measure

- True
- False

7.2.37 Common Language

7.2.37.1 Definition

A language in common use in an Administrative or Named Area which is not officially recognized by the government.

7.2.37.2 Domain/unit of measure

An ISO 639-2 language code [1]

7.2.37.3 Description

A given area may have multiple common languages.

7.2.38 Commuter/Regional Railway Station

7.2.38.1 Definition

This Attribute when True indicates a facility established to provide inter-city and commuter rail transportation.

7.2.38.2 Domain/unit of measure

- True
- False

7.2.39 Complex Building Elevation

7.2.39.1 Definition

The description of lower and upper elevation of a Building above the (projected) building footprint.

7.2.39.2 Domain/unit of measure

Composite

7.2.39.3 Sub-Attributes

This Composite Attribute consists of the following Sub-Attributes:

- Upper Building Elevation - Mandatory
- Lower Building Elevation

7.2.39.4 Description

The use of both, Lower Building Elevation and Upper Building Elevation allows specifying elevated buildings (building parts) such as a skyway between two towers. In such a case, the Building (footprint) associated with the skyway is its projection on the ground.

Most common will be the specification of Upper Building Elevation only.

7.2.40 Composite Alternate Pronunciation

7.2.40.1 Definition

Attribute group for alternate pronunciation(s).

7.2.40.2 Domain/unit of measure

Composite.

7.2.40.3 Sub-Attributes

- Alternate Pronunciation — Mandatory
- Pronunciation Variant
- Phonetic Alphabet
- Pronunciation Language
- Transcription Description

7.2.40.4 Description

The Composite Alternate Pronunciation Attribute is associated with name strings, i.e. with the actual values of name Attributes.

For information about standard pronunciation of names, the Attribute Composite Pronunciation is provided.

7.2.41 Composite Exit Number

7.2.41.1 Definition

Information about numbers and names of an individual exit along a freeway.

7.2.41.2 Domain/unit of measures

Composite.

7.2.41.3 Sub-Attributes

- Exit Number
- Official Name
- Alternate Name
- Route number

7.2.42 Composite Form of Way

7.2.42.1 Definition

Certain aspects of the physical form that a Road Element takes. It is based on a number of certain physical and traffic properties.

7.2.42.2 Domain/unit of measure

Composite.

7.2.42.3 Sub-Attributes

This Composite Attribute can consist of the following Sub-Attributes:

- Form of Way — Mandatory
- Slip Road Type
- Freeway
- Enclosed Traffic Area Type

7.2.43 Composite Pronunciation

7.2.43.1 Definition

Attribute group for standard pronunciation.

7.2.43.2 Domain/unit of measure

Composite.

7.2.43.3 Sub-Attributes

- Pronunciation — Mandatory
- Phonetic Alphabet
- Pronunciation Language
- Transcription Description

7.2.43.4 Description

The Composite Pronunciation Attribute is associated with name strings, i.e. with the actual values of name Attributes.

For information about alternate (non-standard) pronunciation of names, the Attribute Composite Alternate Pronunciation is provided.

7.2.44 Conditional Traffic Flow

7.2.44.1 Definition

Is traffic allowed to flow on a Road Element, lane, Ferry Connection or Path.

7.2.44.2 Domain/unit of measure

- Open: Traffic is allowed.
- Closed: Traffic is not allowed.

7.2.44.3 Description

7.2.44.3.1 Definition of Traffic

The meaning of the term “Traffic” has to be interpreted as one of several values of the associated Sub-Attribute Vehicle Type or as a logical OR combination of these.

7.2.44.3.2 Conditional Traffic Flow as Sub-Attribute for lanes

This Attribute is can be attached to Road Elements as a Simple Attribute or as a Sub-Attribute in conjunction with Lane-Dependent Validity, Lane Type, Width, Divider, and Direction Category. In the latter case, these Sub-Attributes form the Composite Attribute Lane Info.

7.2.45 Construction Status

7.2.45.1 Definition

Whether a Feature such as a Road Element or Path is currently under construction or in the planning stage.

7.2.45.2 Domain/unit of measure

- Under Construction —Open
- Under Construction — Closed
- Planned

7.2.46 Correspondence

7.2.46.1 Definition

As part of a Linear Assignment, a Correspondence specifies the (simple) mapping between a whole source Line Feature and a target Line Feature.

7.2.46.2 Domain/unit of measure

Composite

7.2.46.3 Sub-Attributes

- Correspondence Order — Mandatory
- Validity Direction — Mandatory

7.2.46.4 Description

A Correspondence's Validity Direction Attribute indicates whether the source Line Feature is in the same or opposite direction as the target Line Feature.

Correspondences are ordered, based on their Correspondence Order Attribute. The Correspondence Order corresponds to the logical Feature number among the set of target Line Features.

7.2.47 Correspondence Order

7.2.47.1 Definition

The position of the Correspondence in the list of Correspondences of a Linear Assignment.

7.2.47.2 Domain/unit of measure

A positive integer.

7.2.47.3 Description

A Linear Assignment has one or more Correspondences, each for a single target Line Feature in the assignment. The Correspondence Order puts all Correspondences in consecutive order from the start of the source Line Feature, being assigned in the increasing direction of the source Line Feature.

This Attribute is used as a Sub-Attribute in conjunction with Validity Direction. Together these Sub-Attributes form the Composite Attribute Correspondence.

7.2.48 Continuation Type

7.2.48.1 Definition

Classification whether or not the Connectivity Relationship specified between incoming lane(s) and outgoing lane(s) represents natural continuations.

7.2.48.2 Domain/unit of measure

- Natural
- Other type of lane transition

7.2.49 Currency

7.2.49.1 Definition

The national currency in which a certain payment can be made.

7.2.49.2 Domain/unit of measure

Any combination of letters, numbers or punctuation which specifies a currency according to the internationally accepted abbreviation rules.

7.2.49.3 Description

This Sub-Attribute is to be used in combination with the Sub-Attribute Toll Charge to specify a certain Toll to be paid.

7.2.50 Departure/Arrival

7.2.50.1 Definition

Whether a traffic Service is only for departures or arrivals, or both.

7.2.50.2 Domain/unit of measure

- Departure
- Arrival
- Departure and Arrival

7.2.51 Destination of Flight Connection

7.2.51.1 Definition

The destination of the Flight Connection.

7.2.51.2 Domain/unit of measure

The value should be expressed in the international standard IATA three letter airport code [42] or the international standard ICAO four letter airport code [44], respectively. Optionally this may be followed by a one position indication for a possible terminal. If the airport only has one terminal the last character should be a zero or left out.

7.2.51.3 Description

This Attribute can be used as a Sub-Attribute of the Composite Attribute Flight Info.

7.2.52 Destination Info on Traffic Sign

7.2.52.1 Definition

Information present on Traffic Signs which relates to destinations.

7.2.52.2 Domain/unit of measure

Composite.

7.2.52.3 Sub-Attribute

- Destination Location [.]..[.]
- Route Number On Sign [.]..[.]
- Exit Number [.]..[.]

NOTE [.]..[.] indicates that the Sub-Attribute can have multiple instances in the framework of the Composite Attribute.

7.2.53 Destination Location

7.2.53.1 Definition

Information which relates to locations expressed on the traffic sign as destinations.

7.2.53.2 Domain/unit of measure

Any combination of characters and punctuation.

7.2.53.3 Description

EXAMPLE Settlement Name, Industrial Area Name, or Neighborhood Name.

This Attribute is a Sub-Attribute which together with Route Number On Sign and Exit Number forms the Composite Attribute Destination Info On Traffic Sign.

7.2.54 Direction Category

7.2.54.1 Definition

The directionality meaning of arrows or other symbols on the road (lane) surface or on a sign.

7.2.54.2 Domain/unit of measure

- No direction indicated
- Ahead
- Between ahead and right
- Right
- Between right and backward
- Backward (u-turn)
- Between backward and left
- Left
- Between Left and Ahead
- Merge into right lane (lane ends)
- Merge into left lane (lane ends)
- Merging lanes (no priority lane)

7.2.54.3 Description

This Attribute is used as a Sub-Attribute for either of the three Composite Attribute Traffic Sign Information, Traffic Light Info, and Lane Info. In the former case it is only meaningful if it is preceded by a Sub-Attribute Traffic Sign Class.

All references (such as Ahead, Right, etc.) are made in relation to the driving direction of the driver confronted with the road markings or sign. Figure 126 gives graphical examples for the defined direction values (except for those related to merge cases).

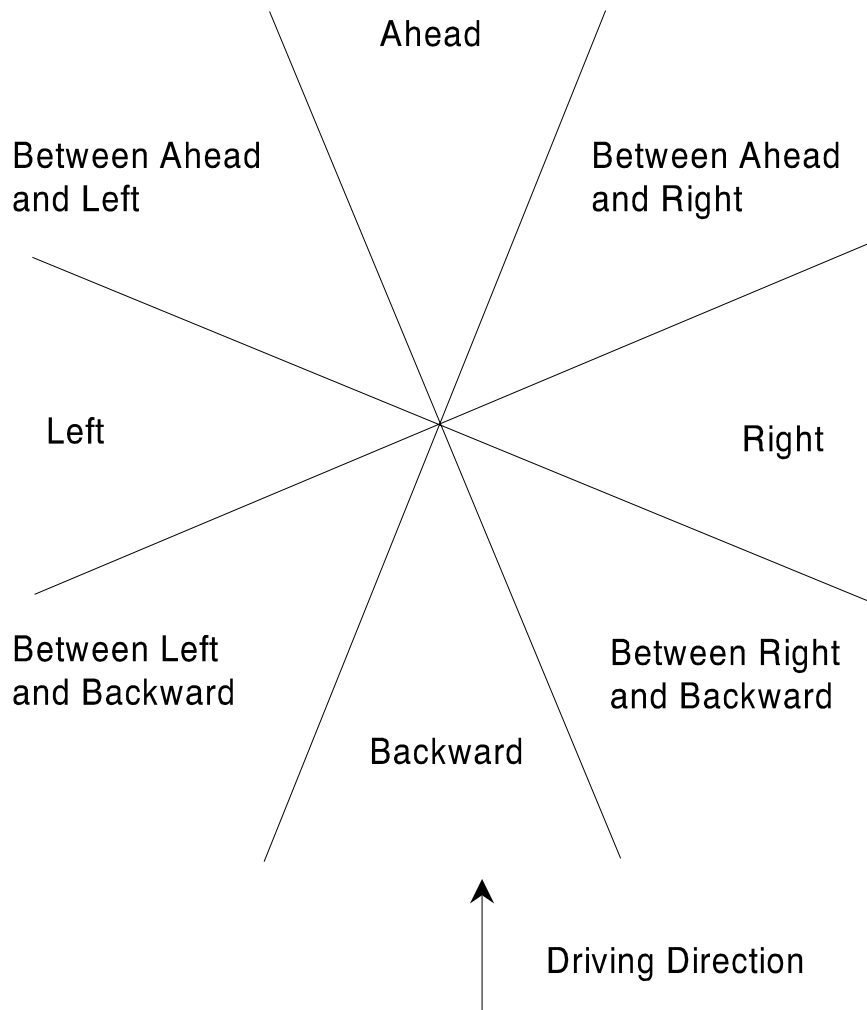

Figure 126 — Graphical representation of the defined direction values

7.2.55 Directional Prefix

7.2.55.1 Definition

A geographic direction which is part of the official/alternate street name or route number of a Road Element or Address Area Boundary Element and which precedes the

- Official/Alternate Street Name Body
- Route Number Body

or

- Street Type Prefix
- Route Type Prefix.

7.2.55.2 Domain/unit of measure

Any combination of letters, numbers or punctuation which forms a valid Directional Prefix.

7.2.55.3 Description

This Attribute is used as a Sub-Attribute to form the Composite Attribute Official/Alternate Street Name or the Composite Attribute Route Number. In the first case it is possibly combined with the Sub-Attributes Official/Alternate Street Name Body, Street Type Prefix, Trailing Spaces, Street Type Suffix, Directional Suffix and Composite Pronunciation. In the second case it is possibly combined with the Sub-Attributes Directional Prefix, Route Type Prefix, Separator, Route Number Body, Route Type Suffix, Directional Suffix, Composite Pronunciation.

7.2.56 Directional Suffix

7.2.56.1 Definition

A geographic direction which is part of the official/alternate street name or route number of a Road Element or Address Area Boundary Element and which succeeds the

- Official/Alternate Street Name Body
- Route Number Body

or

- Street Type Prefix
- Route Type Prefix

7.2.56.2 Domain/unit of measure

Any combination of letters, numbers or punctuation which forms a valid Directional Suffix.

7.2.56.3 Description

This Attribute is used as a Sub-Attribute to form the Composite Attribute Official/Alternate Street Name or the Composite Attribute Route Number. In the first case it is possibly combined with the Sub-Attributes Official/Alternate Street Name Body, Street Type Prefix, Trailing Spaces, Street Type Suffix, Directional Suffix and Composite Pronunciation. In the second case it is possibly combined with the Sub-Attributes Directional Prefix, Route Type Prefix, Separator, Route Number Body, Route Type Suffix, Directional Suffix.

7.2.57 Display Class

7.2.57.1 Definition

A classification of Features which enables a meaningful display of these Features.

7.2.57.2 Domain/unit of measure

- First Class
- Second Class
- Third Class
- Fourth Class
- Fifth Class
- Sixth Class
- Seventh Class
- Eighth Class
- Ninth Class
- Tenth Class

7.2.57.3 Description

Although the user is free to apply his own classification scheme, it is recommended that classification is assigned according to the importance of the associated Feature instances in such a way that the most important Feature instances are classified in the first class.

7.2.58 Distance Expression

7.2.58.1 Definition

A composite expression of a linearly referenced location according to the applicable Linear Referencing Method.

7.2.58.2 Domain/unit of measure

Composite

7.2.58.3 Sub-Attributes

- Distance Measure — Mandatory
- Distance Measure Referent
- Lateral Offset

7.2.58.4 Description

The Distance Expression comprises a Distance Measure, being an absolute, relative, or interpolative linear referencing distance, in accordance with the (default or local) Linear Referencing Method of the Line Feature it is measured against.

In case of a relative Linear Referencing Method, the Distance Measure Referent is to be specified for the relative Distance Measure.

The referenced location may have a Lateral Offset from the Line Feature, which is measured right or left of the Line Feature from the point defined by the Distance Measure.

This Attribute may be used as a Sub-Attribute in conjunction with Start End Flag. Together these Sub-Attributes form the Composite Attribute Linear Position.

Alternatively, this Attribute may be used as a Sub-Attribute within the scope of the Composite Attribute Linear Segmentation. In this case, its Sub-Attribute Lateral Offset is not applicable.

7.2.59 Distance Measure

7.2.59.1 Definition

A measured or calculated distance along a Line Feature as part of a Distance Expression for linear referencing.

7.2.59.2 Domain/unit of measure

7.2.59.3 Value domain

The value should be expressed according to the applicable Linear Referencing Method.

7.2.59.4 Measure

A measure of Distance Measure is composed of a value and a unit of measure.

7.2.59.5 Unit of measure

Deviating from the general unit of measure concept, the unit of measure of Distance Measure is limited to a unit exponent for the applicable Linear Referencing Method. The unit exponent is expressed as 10LOG of the multiplication factor with which the Distance Measure's value, in terms of the base unit of the Linear Referencing Method at hand, has to be multiplied.

Example 1: If the applicable Location Referencing Method is Kilopoint and the Unit Exponent is set to -3, a Distance Measure value of 25 actually represents a distance of 25 metres or 0.025 kilometres.

7.2.59.6 Description

It is determined by the applicable (default or local) Linear Referencing Method, whether the measure represents an absolute, relative, or interpolative linear referencing distance.

This Attribute is used as a Sub-Attribute in conjunction with Distance Measure Referent, and Lateral Offset. Together these Sub-Attributes form the Composite Attribute Distance Expression.

Alternatively, this Attribute is used as a Sub-Attribute in conjunction with Assignment Order. Together these Sub-Attributes form the Composite Attribute Point Assignment.

7.2.60 Distance Measure Referent

7.2.60.1 Definition

The Referent associated with a Line Feature, which is used for expressing the linearly referenced location in a relative Linear Referencing Method applicable for the Line Feature.

7.2.60.2 Domain/unit of measure

The number of a Referent as designated as Feature number in the Multi-Point Assignment Relationship or the Exclusive Multi-Point Assignment Relationship between the Referent and the Line Feature along which the Distance Measure is expressed.

7.2.60.3 Description

This Attribute is used as a Sub-Attribute in conjunction with Distance Measure, and Lateral Offset. Together these Sub-Attributes form the Composite Attribute Distance Expression.

7.2.61 Divided Road Element

7.2.61.1 Definition

An Indication of the presence of a physical or legal divider which separates opposing lanes of traffic.

7.2.61.2 Domain/unit of measure

- True
- False

7.2.61.3 Description

This Attribute when True indicates the existence of a physical or legal divider along the centre line of a single bi-directional Road Element. Depending on the geometrical accuracy requirements of the application, a physical divider or legal divider can either be represented by this Attribute or by the representation of each individual carriageway by a separate centre line.

This Attribute gives no information about the possibility to cross the divider at the start or end Junction.

This Attribute should be used as a Sub-Attribute possibly in conjunction with (one of) the Sub-Attributes Divider Type, Divider Width, Divider Height, Divider Marking, Divider Impact, and Divider Colour. Together they form the Composite Attribute Divider.

7.2.62 Divider

7.2.62.1 Definition

Information about the existence of a physical or legal divider along a Road Element, which is not expressed by individual Features, corresponding to a divider between opposite traffic flow directions of the Road Element as a whole or between individual lanes.

7.2.62.2 Domain/unit of measure

Composite.

7.2.62.3 Sub-Attributes

This Composite Attribute can consist of the following Sub-Attributes:

- Divided Road Element
- Divider Type
- Divider Width
- Divider Height
- Divider Marking
- Divider Impact
- Divider Colour

7.2.62.4 Description

The Attribute Divider can be used both for whole Road Elements (in which case it corresponds to the divider between the two opposite carriageways) or for dividers between individual lanes.

In the first case, the Sub-Attribute Divided Road Element is mandatory.

In the second case, divider information relates to the boundary between any given lane (expressed via the Restrictive Sub-Attribute Lane-dependent Validity) and the respective “next lane”, either to the left or right. Which neighbouring lane is considered the “next” lane follows from the lane counting convention that is adopted from the Lane-Dependent Validity Attribute. In this context, left and right are related to the “From → To” orientation of the Road Element.

7.2.63 Divider Colour

7.2.63.1 Definition

The colour of legal divider markings.

7.2.63.2 Domain/unit of measure

- White
- Yellow

7.2.63.3 Description

This Attribute should be used as a Sub-Attribute in conjunction with the Sub-Attributes Divided Road Element, Divider Type, Divider Width, Divider Height, Divider Marking, and Divider Impact. Together they form the Composite Attribute Divider.

Divider Colour specifically relates to the Divider Type “Legal Divider” and allow for further sub-typing.

7.2.64 Divider Height

7.2.64.1 Definition

The height of the divider along the Road Element or between individual lanes.

7.2.64.2 Domain/unit of measure

7.2.64.2.1 Value domain

The value shall be expressed in either Metric or English default units, or in user-defined units. Metric default unit is centimetre; English default unit is inch.

7.2.64.2.2 Measure

A measure of Divider Height is composed of a value and a unit of measure.

7.2.64.2.3 Unit of measure

The unit of measure of Divider Height is a Union of three: a Metric default unit, an English default unit, or a user-defined unit. User-defined units allow overriding of the default.

7.2.64.3 Description

This Attribute should be used as a Sub-Attribute in conjunction with the Sub-Attributes Divided Road Element, Divider Type, Divider Width, Diver Marking, Divider Impact, and Divider Colour. Together they form the Composite Attribute Divider.

7.2.65 Divider Impact

7.2.65.1 Definition

Identifies whether and under which conditions a divider can be crossed.

7.2.65.2 Domain/unit of measure

- Traversable
- Traversable from the right only
- Traversable from left only
- Not traversable

7.2.65.3 Description

This Attribute should be used as a Sub-Attribute in conjunction with the Sub-Attributes Divided Road Element, Divider Type, Diver Width, Divider Height, Divider Marking, and Divider Colour. Together they form the Composite Attribute Divider.

7.2.66 Divider Marking

7.2.66.1 Definition

The type of marking of a legal divider.

7.2.66.2 Domain/unit of measure

- No line markings
- Dashed Line (long line sections)
- Double solid line
- Single solid line
- Double line: combination of (inner) single solid line and (outer) dashed line
- Double line: combination of (inner) dashed line and (outer) single solid line
- Dashed line (short line sections)
- Shaded area marking

NOTE The “Outer” line of the double line of the lane boundary under consideration refers to the line which is closer to the “next” lane (in lane counting direction; see description of Composite Attribute Divider), “Inner” refers to the other line of the two. If no counting direction is specified (e.g. in case Divider Type and Divider Marking is not described for lanes but for whole Road Elements, right hand traffic/left hand traffic determines which lane is counted first.

7.2.66.3 Description

This Attribute should be used as a Sub-Attribute in conjunction with the Sub-Attributes Divided Road Element, Divider Type, Diver Width, Divider Height, Divider Impact, and Divider Colour. Together they form the Composite Attribute Divider.

Divider Marking specifically relates to the Divider Type “Legal Divider” and allow for further sub-typing.

7.2.67 Divider Type

7.2.67.1 Definition

Classification of the divider along the Road Element or between individual lanes.

7.2.67.2 Domain/unit of measure

- Legal Divider (not physical)
- Physical Divider

7.2.67.3 Description

This Attribute should be used as a Sub-Attribute in conjunction with the Sub-Attributes Divided Road Element, Divider Width, Divider Height, Diver Marking, Divider Impact, and Divider Colour. Together they form the Composite Attribute Divider.

The fact whether a particular divider is crossable for traffic or not can not be implied from its type or marking. It is for example a permitted to cross a continuous white line in Hong Kong, while this is not the case in Germany. Therefore explicit "crossability" information can be specified in the Sub-Attribute Divider Impact to allow the interpretation of lane divider types and markings with regards to their impact on traversing between lanes.

The Sub-Attributes Divider Marking and Divider Colour specifically relate to the Divider Type "Legal Divider" and allow for further sub-typing.

7.2.68 Divider Width

7.2.68.1 Definition

The width of the divider along the Road Element or between individual lanes.

7.2.68.2 Domain/unit of measure

7.2.68.2.1 Value domain

The value should be expressed in either Metric or English default units, or in user-defined units. Metric default unit is centimetre; English default unit is inch.

7.2.68.2.2 Measure

A measure of Divider Width is composed of a value and a unit of measure.

7.2.68.2.3 Unit of measure

The unit of measure of Divider Width is a Union of three: a Metric default unit, an English default unit, or a user-defined unit. User-defined units allow overriding of the default.

7.2.68.3 Description

This Attribute should be used as a Sub-Attribute in conjunction with the Sub-Attribute Divided Road Element, Divider Type, Divider Height, Divider Marking, Divider impact, and Divider Colour. Together they form the Composite Attribute Divider.

This Attribute can also be used in conjunction with Structure Abutment. In this case they together form the Composite Attribute Structure Abutment Info.

7.2.69 Domestic/International

7.2.69.1 Definition

Whether a traffic Service is for Domestic or International traffic, or both.

7.2.69.2 Domain/unit of measure

- Domestic
- International
- Domestic and International

7.2.70 Enclosed Traffic Area Type

7.2.70.1 Definition

The type of Enclosed Traffic Area.

7.2.70.2 Domain/unit of measure

- Parking Place
- Parking Building
- Unstructured Traffic Square
- Pedestrian Square
- Another Type of Enclosed Traffic Area

7.2.70.3 Description

7.2.70.3.1 Usage rule

This Attribute may be used for Features other than Enclosed Traffic Areas as a Sub-Attribute in conjunction with the Sub-Attributes Form of Way, Freeway and Slip Road Type. Together these form the Composite Attribute Composite Form of Way.

7.2.70.3.2 Definition of Parking Place

A ground level parking location for passenger cars and/or commercial vehicles.

7.2.70.3.3 Definition of Parking Building

A car park within a building which may be multi-storey and/or (partly) subterranean.

7.2.70.3.4 Definition of Unstructured Traffic Square

An unstructured traffic square is an area on the road network which allows for the confluence of traffic from different roads, for the purpose of moving from one road to another, which has no internal structure of legally defined driving directions.

7.2.70.3.5 Definition of Pedestrian Square

An open area designated for (unstructured) pedestrian movement and sojourn, separate from roadways and sidewalks. Pedestrian squares are usually paved and may be enclosed by buildings, roads, waterfronts, or other land cover; the squares may be furnished with structures such as flower beds, trees, benches, fountains, etc.

7.2.70.3.6 Definition of Other Type Of Enclosed Traffic Area

A form of Enclosed Traffic Area other than Parking Place, Parking Building or Unstructured Traffic Square.

7.2.71 Entry Point Type

7.2.71.1 Definition

The specification of the importance of an Entry Point.

7.2.71.2 Domain/unit of measure

- Main
- Minor

7.2.71.3 Description for Entry Points of a Service

A "Main" entrance is generally characterized by the following:

- It coincides with the address of the selected Service;
- It is provided with a reception/lobby for visitors;
- It is the entrance which attracts the most attention;
- It is the entrance to which road signs (if present) point.

At least one of the Entry Points (one or more) of a service shall be Attributed as "Main".

7.2.72 Equipment Identifier

7.2.72.1 Definition

A unique alphanumeric identifier ascribed to a particular Road Furniture Feature, which may provide a key to an external database.

7.2.72.2 Domain/unit of measure

As specified by the administrating body.

7.2.73 Exit Number

7.2.73.1 Definition

The number of an exit along a freeway which has been assigned by an administrating body.

7.2.73.2 Domain/unit of measures

Any valid number, including prefixes or suffixes which specify directional or sub-division information.

EXAMPLE Exit 2, Exit 34B, Junction 67, or Exit 48 North.

7.2.73.3 Description

This Attribute can be used as a Sub-Attribute in conjunction with the Sub-Attributes Route Number, Alternate Name and Official Name. Together they form the Composite Attribute Composite Exit Number.

This Attribute is a Sub-Attribute which together with Destination Location and Route Number On Sign forms the Composite Attribute Destination Info On Traffic Sign.

7.2.74 External Identifier

7.2.74.1 Definition

A unique alphanumeric identifier ascribed to a particular Feature.

7.2.74.2 Domain/unit of measure

Any combination of letters, numbers or punctuation which forms a valid external identifier.

7.2.75 Façade Colour

7.2.75.1 Definition

The colour of a Building Façade.

7.2.75.2 Domain/unit of measure

A comma-separated list of three RGB (red, green, blue) colour parameters.

7.2.75.3 Description

The Attribute Façade Colour is used in conjunction with the Sub-Attributes Building Storey, Façade Component and Façade Fabric. Together they make up the Composite Attribute Façade Information.

7.2.76 Façade Component

7.2.76.1 Definition

Characteristics of a Building Façade.

7.2.76.2 Domain/unit of measure

Composite.

7.2.76.3 Sub-Attributes

This Composite Attribute consists of the following Sub-Attributes:

- Multi Media File Attachment - Mandatory
- Façade Component Placement

7.2.76.4 Description

A façade may be composed of a single Façade Component Object (representing the whole façade area), of one Façade Component Object per (set of) building storeys, or of multiple details of a façade such as window and door objects.

The Attribute Façade Component is used in conjunction with the Sub-Attributes Building Storey, Façade Colour and Façade Fabric. Together they make up the Composite Attribute Façade Information.

7.2.77 Façade Component Placement

7.2.77.1 Definition

The relative vertical placement of a Façade Component within (a storey of) the Building Façade.

7.2.77.2 Domain/unit of measure

- Aligned at the Bottom
- Spanning Bottom to Center
- Centered
- Spanning Center to Top
- Aligned at the Top
- Spanning Bottom to Top
- Spanning whole facade

7.2.77.3 Description

The Attribute Façade Component Placement is used in conjunction with the Attribute Multi Media File Attachment. Together they make up the Composite Attribute Façade Component.

7.2.78 Façade Fabric

7.2.78.1 Definition

Description of the fabric a building façade is made of.

7.2.78.2 Domain/unit of measure

Composite.

7.2.78.3 Sub-Attributes

This Composite Attribute consists of the following Sub-Attributes:

- Façade Fabric Type
- Multi-media Attachment File

7.2.78.4 Description

The Façade Fabric can be specified either as an encoded type within a (user-defined) classification, and/or as a digital image type of Multi-Media File Attachment.

The Attribute Façade Fabric is used in conjunction with the Sub-Attributes Building Storey, Façade Component and Façade Colour. Together they make up the Composite Attribute Façade Information.

7.2.79 Façade Fabric Type

7.2.79.1 Definition

The classification of the physical material and structure of which a Building Façade is made of.

7.2.79.2 Domain/unit of measure

- Facade Fabric type 1
- Facade Fabric type 2
-
- Facade Fabric type 999

7.2.79.3 Description

EXAMPLE Brick walls, concrete, etc.

7.2.80 Façade Information

7.2.80.1 Definition

The description of the constructive composition of one or more storey(s) of a Building Façade.

7.2.80.2 Domain/unit of measure

Composite.

7.2.80.3 Sub-Attributes

This Composite Attribute consists of the following Sub-Attributes:

- Building Storey
- Façade Component [...]
- Façade Colour
- Façade Fabric

7.2.80.4 Description

In case of multiple Façade Components, their order is significant. The sequence corresponds to the linear orientation of the Building Façade Feature.

In case a Lower Building Elevation is specified, Façade Information corresponding to 'virtual' Building Storeys below the elevated building structure will not be provided. When specifying Building Storeys, the number of virtual storeys plus the number of real storeys (as if the building structure would not be elevated) is anticipated. This is in accordance with the way the Building Storey Count for the Building in question is determined.

The lowest storey representing the ground level is numbered 1.

7.2.81 Facilities En Suite

7.2.81.1 Definition

The number of rooms with en suite facilities.

7.2.81.2 Domain/unit of measure

Any positive integer within Field limits.

7.2.82 Ferry Type

7.2.82.1 Definition

The subclass of, or the type of, a Ferry Connection.

7.2.82.2 Domain/unit of measure

- Operated by a ship or a hovercraft
- Operated by a train

7.2.83 First House Number

7.2.83.1 Definition

The first house number along the Road Element or the Address Area Boundary Element.

7.2.83.2 Domain/unit of measure

The domain of values is only limited in a physical sense. The value has a maximum size of 10 characters. The characters may be of any kind or combination: digits, alphabetic characters or graphical characters.

EXAMPLE 223, 456, 57-a, or 435-II.

7.2.83.3 Description

This Attribute shall be left blank when there are no numbered houses along the Road Element or the Address Area Boundary Element.

This Attribute is used as a Sub-Attribute in conjunction with the Sub-Attributes House Number Structure, Last House Number and possibly Intermediate House Number. Together these Attributes form the Composite Attribute House Number Range.

7.2.84 Flight Info

7.2.84.1 Definition

Information concerning a certain flight connection.

7.2.84.2 Domain/unit of measure

Composite.

7.2.84.3 Sub-Attributes

The Composite Attribute Flight Info contains the following Sub-Attributes:

- ID of a Flight Connection — Mandatory
- Airport Code
- Destination of a Flight Connection
- Time of Departure of a Flight Connection
- Time of Arrival of a Flight Connection
- Time difference of a Flight Connection.

7.2.85 Form of Way

7.2.85.1 Definition

Certain aspects of the physical form that a Road Element takes. It is based on a number of certain physical and traffic properties.

7.2.85.2 Domain/unit of measure

- Part of a Motorway;
- Part of a Multiple Carriageway which is not a motorway;
- Part of a Single Carriageway;
- Part of a Roundabout Circle;
- Part of a Traffic Square;
- Part of an Enclosed Traffic Area;
- Part of a Slip Road;
- Part of a Service Road;
- Entrance to or exit of Car Park;
- Entrance to or exit to Service;
- Part of a Pedestrian Zone;
- Part of a Runaway Vehicle Ramp

7.2.85.3 Description

7.2.85.3.1 Usage rule

This Attribute is used as a Sub-Attribute possibly in conjunction with the Sub-Attributes Enclosed Traffic Area Type, Freeway and Slip Road Type. Together these Sub-Attributes form the Composite Attribute Composite Form of Way.

7.2.85.3.2 Definition of Motorway

A Motorway is defined as a road permitted for motorized vehicles only in combination with a prescribed minimum speed. It has two or more physically separated carriageways and no single-level crossings.

7.2.85.3.3 Definition of Multiple Carriageway

A multiple carriageway is defined as a road with physically separated carriageways regardless of the number of lanes. If a road is also a motorway, it should be coded as such and not as a multiple carriageway.

7.2.85.3.4 Definition of Single Carriageway

All roads without separate carriageways are considered as roads with a single carriageway.

7.2.85.3.5 Definition of a Roundabout Circle

A Roundabout Circle is a road which forms a ring on which traffic travelling in only one direction is allowed. A sign like the one shown in Figure 127 is an indication that the Road Element in question is part of a Roundabout Circle.

The Road Elements which make up a Roundabout Circle have to be connected to one another and they have to form exactly one ring. Figure 128 illustrates the formation of a Roundabout Circle from Road Elements.

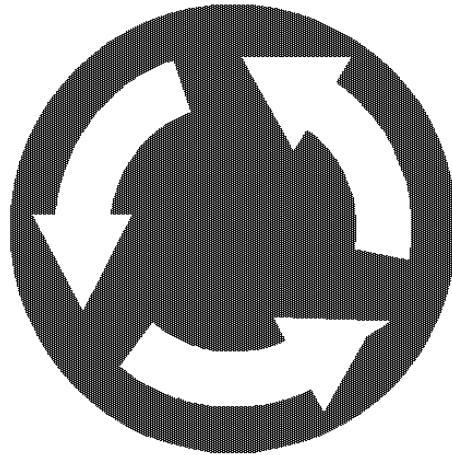

Figure 127 — Example of a roundabout sign used in continental Europe

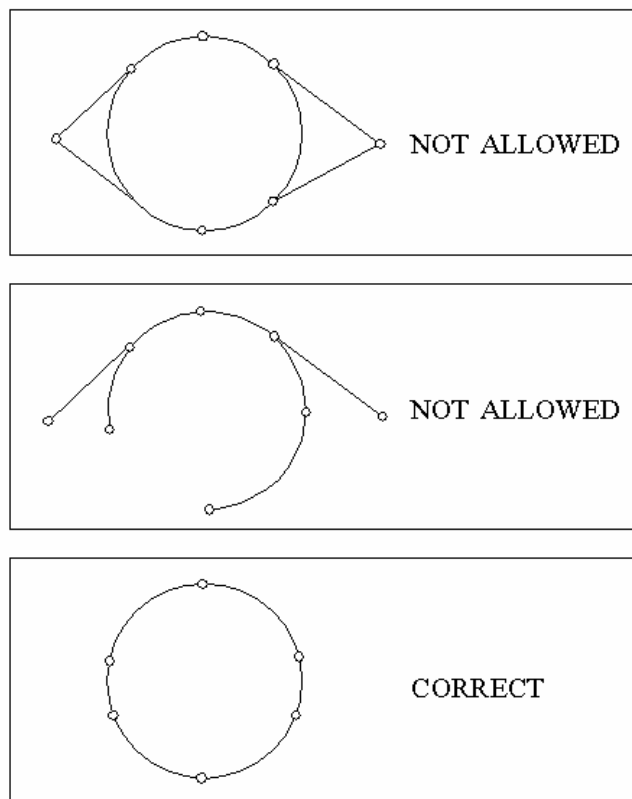

Figure 128 — Examples for the definition of Roundabout Circles

7.2.85.3.6 Definition of a Traffic Square

A Traffic Square is an open area (partly) enclosed or intersected by roads which is used for non-traffic purposes and which is not a Roundabout.

7.2.85.3.7 Definition of a Slip Road

A Slip Road is a road especially designed to enter or leave a Road Element.

7.2.85.3.8 Definition of a Service Road

A Service Road is a road, running parallel to and connecting to a Road with a relatively high connectivity function, which is especially designed to enable access from the connecting roads to roads with a low connectivity function in its vicinity.

Generally, service roads have the same name as the higher class road they run parallel to and are only divided from it by small constructions like walkways, traffic islands etc..

7.2.85.3.9 Definition of an Enclosed Traffic Area

A confined area within which unstructured traffic movements are allowed.

7.2.85.3.10 Definition of Entrance to or Exit of Car Park

An Entrance or Exit of a Car Park is a road specially designed to enter or to leave a Parking Area.

7.2.85.3.11 Definition of Entrance to or Exit of Service

An Entrance or Exit of a Service is a road used only to enter or to leave a Service.

7.2.85.3.12 Definition of Pedestrian Zone

A Pedestrian Zone is an area with a road network which is especially designed for use by pedestrians. Pedestrian Zones are usually located in urban areas. Except for emergency vehicles and for delivery vehicles during certain hours no traffic is allowed on the Road Elements which are located inside the Zone.

7.2.85.3.13 Definition of Runaway Vehicle Ramp

An emergency off-ramp designed to slow down a vehicle that is out of control on a downgrade.

7.2.86 Freeway

7.2.86.1 Definition

This Attribute when True indicates whether a Road Element is part of a Freeway.

7.2.86.2 Domain/unit of measure

- True
- False

7.2.86.3 Description

7.2.86.3.1 Usage rule

This Attribute is used as a Sub-Attribute possibly in conjunction with the Sub-Attributes Form of Way, Slip Road Type and Enclosed Traffic Area Type. Together these form the Composite Attribute Composite Form of Way.

7.2.86.3.2 Definition of a Freeway

A Freeway is defined as a road having no single-level crossings with other roads. This means that connections with other Road Elements only consist of Slip Roads and/or Parallel Roads.

7.2.87 Frequency of a Traffic Connection

7.2.87.1 Definition

The time interval between two departures of a Traffic Connection.

7.2.87.2 Domain/unit of measure

The value shall be expressed as a single time duration using the Time Domain syntax.

7.2.88 Functional Road Class

7.2.88.1 Definition

A classification based on the importance of the role that the Road Element or Ferry Connection performs in the connectivity of the total road network.

7.2.88.2 Domain/unit of measure

- Main roads: the most important roads in a given network.
- First class roads.
- Second class roads.
- Third class roads.
- Fourth class roads.
- Fifth class roads.
- Sixth class roads.
- Seventh class roads.
- Eighth class roads.
- Ninth class roads: the least important roads in a given network.

7.2.88.3 Description

7.2.88.3.1 Number of road classes

The number can vary from one country to another and depends on the (map) sources which are available.

7.2.88.3.2 Number of road class values

It is allowed in principle that a Road Element has more than one Functional Road Class value, based on different source documents. In such cases it is an absolute requirement that the source document on which a particular value is based is mentioned explicitly.

7.2.88.3.3 Classification of Ferry Connections

The classification of the Feature Ferry Connection shall be homogeneous with the road classification. Consequently, a Ferry Connection joining two Road Elements, each having the same Functional Road Class value, must also get that Functional Road Class value. A Ferry Connection, joining two Road Elements with different Functional Road Class values, shall get the lowest of these two values.

7.2.88.3.4 Classification rules

The following rules have to be taken into account for classifications.

- In general, each subset of all Road Elements belonging to a particular Functional Road Class or higher shall always form a connected graph.
- In each of these subsets the number of Road Elements that are dead end shall be kept to a minimum.

7.2.89 General Aviation

7.2.89.1 Definition

This Attribute when True indicates whether an airport offers General Aviation Services.

7.2.89.2 Domain/unit of measure

- True
- False

7.2.90 Give Way Type

7.2.90.1 Definition

The type of Give Way Regulation.

7.2.90.2 Domain/unit of measure

- Give Way (Yield)
- Stop
- All-Way stop (example: 4-Way Stop)
- Caution Sign “Unmarked Intersection Ahead” (i.e. general traffic regulations apply)

7.2.91 Geopolitical Structure Containment

7.2.91.1 Definition

The containing geopolitical structure of an administrative Area Feature or a named Area Feature.

7.2.91.2 Domain/unit of measure

Combined reference to the geopolitical structure ID and the geopolitical structure component ID, separated by a dot (‘.’).

7.2.91.3 Description

Geopolitical structures are composed of administrative areas and named areas, such as Country, Order-8 Area, School District, or Built-up Area, to form a graph of sub-divisions and containment which may be fully or partially hierarchical.

An instance of a Feature from the Feature Theme Administrative Area or Named Area uses this Attribute to designate which geopolitical structure it is a member of, as well as which specific component within that structure it corresponds to.

EXAMPLE The American town of Lexington plays the role of “CITY” (geopolitical structure component) in the “AMERICAN CCD ADMIN STRUCTURE” (geopolitical structure). A “CITY” is partially contained in a “COUNTY” (immediate parent) and fully contained in a “STATE” (lowest full parent), both also being geopolitical structure components of the “AMERICAN CCD ADMIN STRUCTURE”.

7.2.92 Government Type

7.2.92.1 Definition

The specification of the Government function which is executed in a certain Government Office.

7.2.92.2 Domain/unit of measure

The following types are recognized:

- Supra National
- National
- Order-1
- Order-2
- Order-3
- Order-4
- Order-5
- Order-6
- Order-7
- Municipality

7.2.92.3 Description

Order-1 to 7 represent Administrative Areas on a hierarchical level located between the country and the municipality and are equivalent with the Order-1 to 7 of Administrative Areas.

A Supra-National Government represents a group of more than one country (e.g. Europe, Benelux, UNO, etc.).

7.2.93 Hearing Limitation

7.2.93.1 Definition

This Attribute when True indicates accessibility limitation due to a limitation of hearing.

7.2.93.2 Domain/unit of measure

- True
- False

7.2.93.3 Description

Hearing limitation is a Sub-Attribute that limits access to road elements to people with hearing limitations. Together with Slow Walker Limitation, Vision Limitation, and Wheelchair Limitation, it forms the Composite Attribute Accessibility Limitation.

Hearing Limitation can be restricted by the Restrictive Sub-Attribute Validity Period, which expresses temporality associated with accessibility limitations.

7.2.94 Height Label

7.2.94.1 Definition

The designated altitude of a Feature.

7.2.94.2 Domain/unit of measure

7.2.94.2.1 Value domain

The value shall be expressed in either Metric or English default units, or in user-defined units. Metric default unit is metre; English default unit is foot.

7.2.94.2.2 Measure

A measure of Height Label is composed of a value and a unit of measure.

7.2.94.2.3 Unit of measure

The unit of measure of Height Label is a Union of three: a Metric default unit, an English default unit, or a user-defined unit. User-defined units allow overriding of the default.

7.2.94.3 Description

7.2.94.3.1 Usage for Road Elements

The Height Label expresses the maximum altitude along a given Road Element if it has been identified as a mountain pass. The Height Label can flexibly use a local or user-defined unit of measure, in contrast to the Z coordinate of the road geometry, which either is absent, or which is expressed according to the vertical coordinate system defined for the containing GDF Section. Furthermore, the Height Label may be deliberately rounded to represent discrete altitude plateaus and therefore differ from the (possibly more precise) Z coordinate.

This Attribute is used as a Sub-Attribute in conjunction with the Sub-Attribute Pass and possibly Opening Period. Together these Sub-Attributes form the Composite Attribute Mountain Pass.

7.2.94.3.2 Usage for Mountain Pass Summit

The Height Label expresses the terrain height associated with a Mountain Pass Summit. The Height Label can flexibly use a local or user-defined unit of measure, in contrast to the Z coordinate of the mountain pass geometry, which either is absent, or which is expressed according to the vertical coordinate system defined for the containing GDF Section. Furthermore, the Height Label may be deliberately rounded to represent discrete altitude plateaus and therefore differ from the (possibly more precise) Z coordinate.

7.2.94.3.3 Usage for Contour Lines

The Height Label expresses the terrain height associated with Contour Lines (including Contour Line Points or Areas). The Height Label can flexibly use a local or user-defined unit of measure, in contrast to the Z coordinate of the contour line geometry, which either is absent, or which is expressed according to the vertical coordinate system defined for the containing GDF Section. Furthermore, the Height Label may be deliberately rounded to represent discrete altitude plateaus and therefore differ from the (possibly more precise) Z coordinate.

7.2.95 High Occupancy Vehicle

7.2.95.1 Definition

The minimum number of occupants of a passenger car allowed on a certain Road Element or lane.

7.2.95.2 Domain/unit of measure

Composite.

7.2.95.3 Sub-Attributes

This Composite Attribute can consist of the following Sub-Attributes:

- Vehicle Type — Mandatory
- Minimum Number of Occupants

It can only be applied in the case when the Vehicle Type has the value “High Occupancy Vehicle”.

7.2.96 House Number

7.2.96.1 Definition

Any number or number range that specifies the house number(s) associated to a Service or building Unit.

7.2.96.2 Domain/unit of measure

Any combination of numbers, letters or punctuation which forms a valid house number within an address, e.g. 12, 39B, 2300-2360.

7.2.96.3 Description

This Sub-Attribute is also used in conjunction with the Sub-Attributes Street Name, Place Name and Postal Code. Together they form the Composite Attribute Service Address.

7.2.97 House Number Range

7.2.97.1 Definition

The set of house numbers that is related to one side of a particular road element or to a particular Address Area Boundary Element.

7.2.97.2 Domain/unit of measure

Composite.

7.2.97.3 Sub-Attributes

This Composite Attribute can consist of the following Sub-Attributes:

- House Number Structure — Mandatory
- Side of Line — Mandatory
- First House Number
- Last House Number
- Intermediate House Number [.]..[.]

NOTE 1 [.]..[.] indicates that the Sub-Attribute can have multiple instances in the framework of the Composite Attribute.

The number of Sub-Attributes required to define the house number range completely depends on the value given to the House Number Structure Sub-Attribute.

NOTE 2 House numbers on Address Area Boundary Elements appear, by definition, only on one side.

7.2.97.4 Description

This Sub-Attribute is used in conjunction with the Sub-Attributes Official Street Name or Alternate Street Name or Route Number and Postal Code. Together they form the Composite Attribute Address Information.

7.2.98 House Number Structure

7.2.98.1 Definition

The type of house numbering method that is applied to one side of a particular Road Element or to a particular Address Area Boundary Element.

7.2.98.2 Domain/unit of measure

- No house numbers at all
- Regular with odd numbers
- Regular with even numbers
- Regular with odd and even numbers
- Irregular

7.2.98.3 Description

7.2.98.3.1 Usage rule

This Attribute is used as a Sub-Attribute in conjunction with the Sub-Attributes First House Number, possibly Intermediate House Number and Last House Number. Together these Attributes form the Composite Attribute House Number Range.

7.2.98.3.2 Definition of different House Number Structures

- No house numbers at all: There are no houses along the road element side/Address Area Boundary Element or the houses along the road element side/Address Area Boundary Element are not numbered.
- Regular with odd and even numbers: Odd and even house numbers appear in a sequential sorted order (ascending or descending) when moving from one end of the Road Element/Address Area Boundary Element to the other. Numeric Completeness of the series is not a requirement. A house number series which has missing numbers, but which is sequentially sorted, is considered to be regular.

EXAMPLE 1 (5,6,7,9,10,13).

EXAMPLE 2 (24,27,30,33,34,36).

EXAMPLE 3 (35,36,48,69,71,74,86).

- Regular with odd numbers: The odd house numbers appear in a sequential sorted order (ascending or descending) when moving from one end of the Road Element/Address Area Boundary Element to the other. Numeric Completeness of the series is not a requirement. A house number series which has missing numbers, but which is sequentially sorted, is considered to be regular.

EXAMPLE 4 (5,7,9,11,13).

EXAMPLE 5 (35,39,43,69,71,73,85).

- Regular with even numbers: The even house numbers appear in a sequential sorted order (ascending or descending) when moving from one end of the Road Element/Address Area Boundary Element to the other. Numeric Completeness of the series is not a requirement. A house number series which has missing numbers, but which is sequentially sorted, is considered to be regular.

EXAMPLE 6 (2,4,8,18,22).

- Irregular: Irregular means that house numbers do not occur in any sorted order).

For examples see Figure 129, Figure 130 and Figure 131.

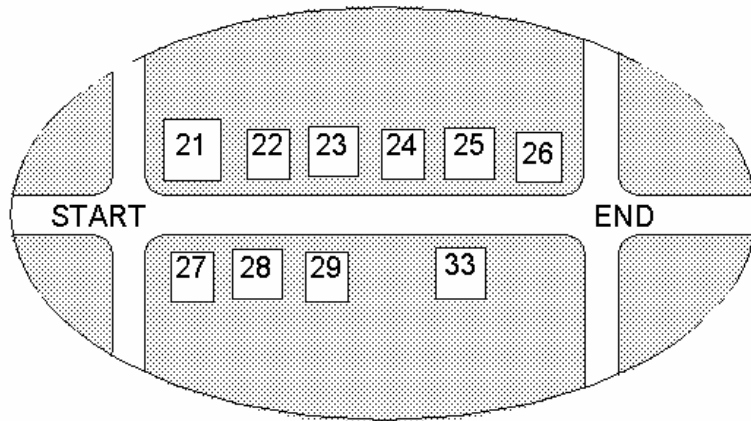

Figure 129 — Example of House numbering regular with odd and even at the same side

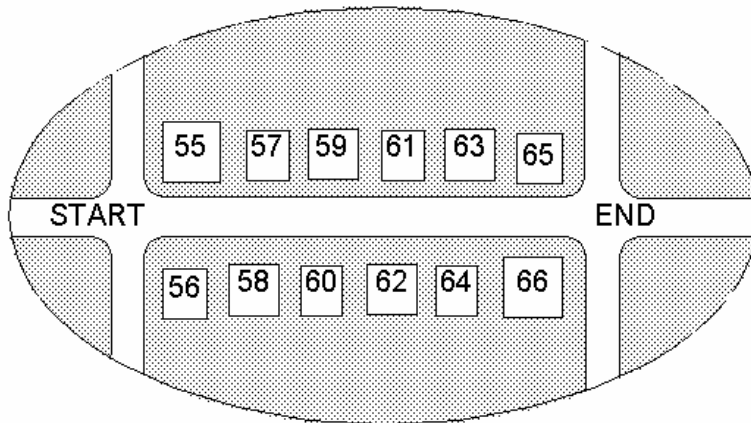

Figure 130 — Example of House numbering regular with odd and even at different sides

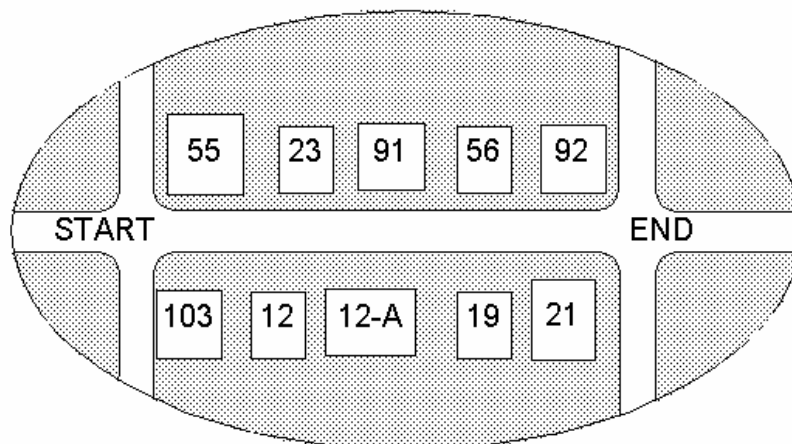

Figure 131 — Example of Irregular house numbering

7.2.99 ID of Flight Connection

7.2.99.1 Definition

The flight number of the flight connection.

7.2.99.2 Domain/unit of measure

The value should be expressed in the international airline standard format.

7.2.99.3 Description

This Attribute can be used as a Sub-Attribute of the Composite Attribute Flight Info.

7.2.100 Importance

7.2.100.1 Definition

The level of importance of a Service.

7.2.100.2 Domain/unit of measure

- Local
- National

7.2.100.3 Description

“Local” refers to town or municipality. Features of local importance include restaurants, hotels, cinemas, etc. Most towns will have one or more.

“National” refers to national or international importance.

EXAMPLE Stonehenge (monument), or EuroDisney (theme park).

7.2.101 Infrastructure Accessibility Aids

7.2.101.1 Definition

Classes of aids for accessibility.

7.2.101.2 Domain/unit of measure

- Textured surface available
- Audible signal available
- Visual signal available
- Care provider available
- User defined

7.2.101.3 Description

Infrastructure Accessibility Aids is a Sub-Attribute specifying access aids to handicapped by physical structure and/or by the presence of a care provider. Together with the Sub-Attributes Accessibility Limitation and Suitable for Disabled or Challenged, they form the Composite Attribute Accessibility.

Infrastructure Accessibility Aids can be restricted by the Restrictive Sub-Attribute Pedestrian Type, which details the kinds of pedestrians to which the aids apply, and the Restrictive Sub-Attribute Validity Period, which expresses temporality associated with the aids.

7.2.102 Interchange Type

7.2.102.1 Definition

A Classification of an Interchange.

7.2.102.2 Domain/unit of measure

- Crossing between Freeways only
- Crossing between a Freeway and a non-Freeway
- Crossing between non-Freeways only

7.2.103 Intermediate House Number

7.2.103.1 Definition

A house number along the Road Element or the Address Area Boundary Element, which is not the first or the last house number along that Road or Address Area Boundary Element.

7.2.103.2 Domain/unit of measure

The domain of values is only limited in a physical sense. The value has a maximum size of 10 characters. The characters may be of any kind: digits, alphabetic characters or graphical characters.

EXAMPLE 223, 456, 57-a, or 435-II.

7.2.103.3 Description

7.2.103.3.1 Usage rules

This Attribute is used as a Sub-Attribute in conjunction with the Sub-Attributes House Number Structure, First House Number, and Last House Number. Together these Attributes form the Composite Attribute House Number Range.

The main intention of Intermediate House Number is to add detail when the Sub-Attribute House Number Structure is irregular. It stores all of the numbers on one side of the Road Element/Address Area Boundary Element between the First and the Last House Number.

7.2.103.3.2 Sorting order

The house numbers need to be stored in the same order as they occur alongside the Road Element/Address Area Boundary Element from the First to the Last House Number.

7.2.104 International Railway Station

7.2.104.1 Definition

This Attribute when True indicates a facility established to provide international rail transportation.

7.2.104.2 Domain/unit of measure

- True
- False

7.2.105 ISO Country Code

7.2.105.1 Definition

The ISO 3166 alpha-3 code [7] of the country in question.

7.2.106 Junction Type

7.2.106.1 Definition

The classification of a Junction

7.2.106.2 Domain/unit of measure

- Mini roundabout
- Railway crossing
- Border crossing
- Fixed Guideway Vehicle Crossing

7.2.106.3 Description

7.2.106.3.1 Definition of a Mini Roundabout

A mini roundabout is a roundabout mainly designed to reduce the speed of the passing vehicles. When continuing in the same direction it only requires a small direction deviation. See Figure 132 for an example.

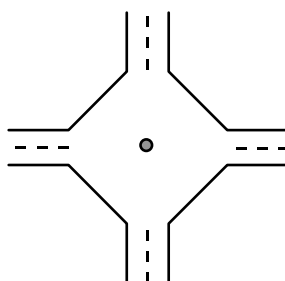

Figure 132 — Example of a mini-roundabout

7.2.106.3.2 Definition of a Railway Crossing

A railway crossing is a crossing at grade between a road and a railway.

7.2.106.3.3 Definition of a Border Crossing

A Border Crossing is the location where a road crosses a Country Border.

7.2.106.3.4 Definition of a Fixed Guideway Vehicle Crossing

A Fixed Guideway Vehicle crossing is a crossing at grade between a road and a dedicated pathway for vehicles such as trams, trains and busses. See Figure 133 for an example.

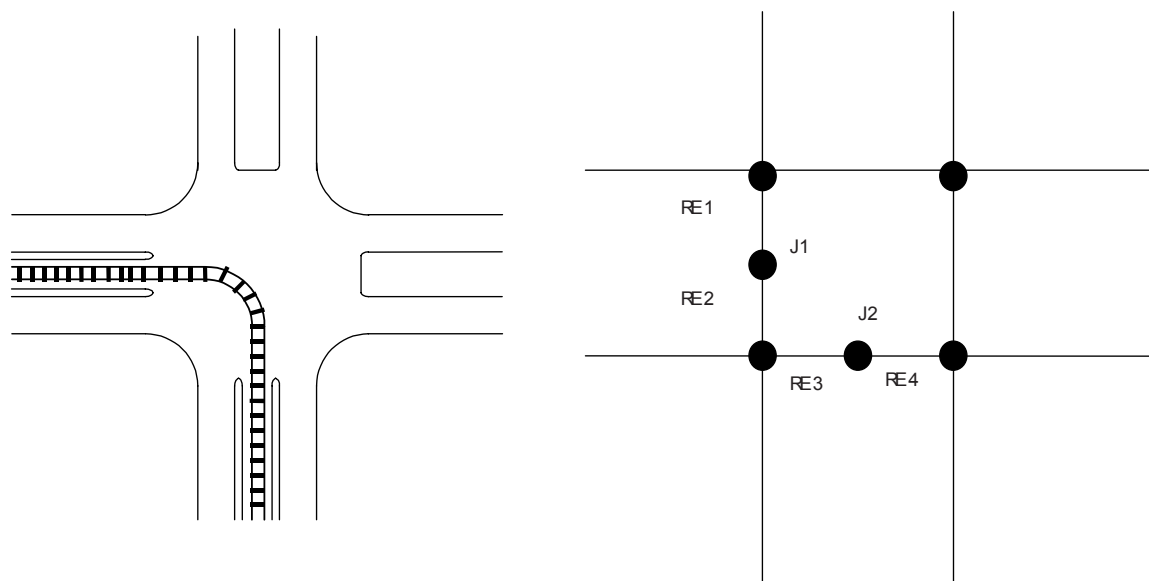

Tram Crossings: J 1 and J 2

Figure 133 — Example of a tram crossing

7.2.107 Lane Dependent Validity

7.2.107.1 Definition

For which of the lanes of an associated Road Element the associated Sub-Attribute or Relationship holds or does not hold.

7.2.107.2 Domain/unit of measure

A string with a length which at maximum equals the number of lanes present on the associated Road Element + 1, whereby the character on the $(n+1)^{\text{th}}$ position refers to the n^{th} lane. The allowed characters on the first position of the string are:

- L: Indicating that the lanes are counted from the left side of the Road Element.
- R: Indicating that the lanes are counted from the right side of the Road Element.

The allowed characters on the n^{th} ($n > 1$) position of the string are:

- 0: Indicating that the associated Sub-Attribute is not valid for that lane.
- 1: Indicating that the associated Sub-Attribute is valid for that lane.

7.2.107.3 Description

The left and right side of the Road Element are defined by considering the orientation of the Road Element as defined by the start and end bounding Point Feature.

The number of characters does not necessarily have to equal the number of lanes of the associated Road Element + 1. In this case the not represented lanes should be considered as not collected.

The Attribute should be used in conjunction with another Sub-Attribute which specifies the Property which is valid for the lanes specified by the Lane Validity Attribute.

7.2.108 Lane Info

7.2.108.1 Definition

Information associated with individual lane(s) of a Road Element.

7.2.108.2 Domain/unit of measure

Composite

7.2.108.3 Sub-Attributes

This Composite Attribute can consist of the following Sub-Attributes:

- Lane-Dependent Validity - Mandatory
- Conditional Traffic Flow
- Lane Type
- Width
- Divider
- Direction Category

7.2.108.4 Description

Information about lane connectivity along a road element can be derived particularly from the Sub-Attribute Divider Impact (within the Composite Attribute Divider) and the Sub-Attribute Conditional Traffic Flow.

7.2.109 Lane Type

7.2.109.1 Definition

Indicates whether the associated Road Element has a lane of the specified dedicated use.

7.2.109.2 Domain/unit of measure

- Normal Lane
- Exit/Entrance Lane
- Emergency Lane
- Shoulder Lane
- Lay-by Lane
- Overtaking Lane

7.2.109.3 Description

7.2.109.3.1 Definition of Normal Lane

A lane without special characteristics.

7.2.109.3.2 Definition of Exit/Entrance Lane

A lane that merges with or departs from leftmost or rightmost lane, serving as a connection from or to another road.

7.2.109.3.3 Definition of Emergency Lane

A lane, typically the leftmost or rightmost lane, exclusively reserved for emergency vehicles.

7.2.109.3.4 Definition of Shoulder Lane

Leftmost or rightmost lane that may be paved or unpaved and is not part of the designated roadway, serving as safety zone aside a road.

7.2.109.3.5 Definition of Lay-by Lane

A lane dedicated to the parking of vehicles (frequently found in the UK).

7.2.109.3.6 Definition of Overtaking Lane

A supplementary lane build besides (uphill) sections of ordinary lane(s) to facilitate safe over-taking (of slow vehicles).

7.2.109.4 Attribute Usage rule

This Attribute is can be attached to Road Elements as a Simple Attribute or as a Sub-Attribute in conjunction with Lane-Dependent Validity, Conditional Traffic Flow, Width, Divider, and Direction Category. In the latter case, these Sub-Attributes form the Composite Attribute Lane Info.

7.2.110 Last House Number

7.2.110.1 Definition

The last house number along the Road Element or the Address Area Boundary Element.

7.2.110.2 Domain/unit of measure

The domain of values is only limited in a physical sense. The value has a maximum size of 10 characters. The characters may be of any kind: digits, alphabetic characters or graphical characters.

EXAMPLE 223, 456, 57-a, or 435-II.

7.2.110.3 Description

This Attribute is used as a Sub-Attribute in conjunction with the Sub-Attributes House Number Structure, First House Number and possibly Intermediate House Number. Together these Attributes form the Composite Attribute House Number Range.

7.2.111 Lateral Offset

7.2.111.1 Definition

An indication of the lateral position of a Line Feature.

7.2.111.2 Domain/unit of measure

Any integer value.

7.2.111.3 Description

Positive values should be used to indicate positions on the right side of the Line Feature, negative values for positions on the left side. The value zero indicates a position on (or above) the Line Feature.

The values should be used in an ordinal sense whereby larger numbers (or in the case of negative numbers, smaller numbers) indicate a lateral position further from the Line Feature.

This Attribute is used as a Sub-Attribute in conjunction with Distance Measure and Distance Measure Referent. Together these Sub-Attributes form the Composite Attribute Distance Expression.

NOTE This model for Lateral Offsets deviates from ISO 19148 [30] which defines distance-based lateral offsets.

7.2.112 Length of a Road Element

7.2.112.1 Definition

The curvilinear two-dimensional length of a Road Element.

7.2.112.2 Domain/unit of measure

7.2.112.2.1 Value domain

The value should be expressed in either Metric or English default units, or in user-defined units. Metric default unit is metre; English default unit is foot.

7.2.112.2.2 Measure

A measure of Length of a Road Element is composed of a value and a unit of measure.

7.2.112.2.3 Unit of measure

The unit of measure of Length of a Road Element is a Union of three: a Metric default unit, an English default unit, or a user-defined unit. User-defined units allow overriding of the default.

7.2.112.3 Description

This Attribute should contain the curvilinear length of the horizontal projection of the Road Element.

7.2.113 Linear Position

7.2.113.1 Definition

The designation of a Distance Expression serving either as the start position or as the end position of a linearly referenced linear extent.

7.2.113.2 Domain/unit of measure

Composite

7.2.113.3 Sub-Attributes

- Start End Flag — Mandatory
- Distance Expression — Mandatory

7.2.113.4 Description

A linear extent along a Line Feature can be specified by two occurrences of the Linear Position Attribute, specifying the Distance Expression applicable to the start position and the Distance Expression applicable to the end position, respectively.

In the context of the Linear Assignments Relationship, a Linear Position may be specified for a start position only, for an end position only, for both, or not at all.

A single position along a Line Feature is specified by applying the Distance Expression Attribute directly as a Simple Attribute, i.e. without start/end designation.

7.2.114 Linear Referencing Method

7.2.114.1 Definition

The Linear Referencing Method applied for Distance Expressions along Line Feature(s).

7.2.114.2 Domain/unit of measure

- Milepoint
- Kilopoint
- Milepost
- Kilopost
- Mile Reference Post
- Kilometre Reference Post
- Percentage
- Normalized
- Stationing
- Metric Stationing
- Reverse Milepoint
- Reverse Kilopoint
- Reverse Percentage

7.2.114.3 Description

7.2.114.3.1 General

The Attribute can be applied to Line Features in general, to a Line Feature instance, or to an individual Linear Assignment involving a particular (set of) Line Feature(s).

The Attribute specifies how measured locations along Line Features are measured by default, unless overridden by an individually designated Linear Referencing Method.

7.2.114.3.2 Definition of Milepoint

Distances are measured in miles from the start of the Line Feature (absolute Linear Referencing Method).

7.2.114.3.3 Definition of Kilopoint

Distances are measured in kilometres from the start of the Line Feature (absolute Linear Referencing Method).

7.2.114.3.4 Definition of Milepost

Distances are measured in miles from the specified milepost along the Line Feature (relative Linear Referencing Method).

7.2.114.3.5 Definition of Kilopost

Distances are measured in kilometres from the specified kilopost along the Line Feature (relative Linear Referencing Method).

7.2.114.3.6 Definition of Mile Reference Post

Distances are measured in miles from the specified reference post along the Line Feature (relative Linear Referencing Method).

7.2.114.3.7 Definition of Kilometre Reference Post

Distances are measured in kilometres from the specified reference post along the Line Feature (relative Linear Referencing Method).

7.2.114.3.8 Definition of Percentage

Distances are expressed as a percentage of the total Line Feature length (interpolative Linear Referencing Method).

7.2.114.3.9 Definition of Normalized

Distances are expressed as a decimal ratio of the total Line Feature length (interpolative Linear Referencing Method).

7.2.114.3.10 Definition of Stationing

Distances are measured in feet based on stationing defined for the Line Feature (relative Linear Referencing Method).

7.2.114.3.11 Definition of Metric Stationing

Distances are measured in metres based on metric stationing defined for the Line Feature (relative Linear Referencing Method).

7.2.114.3.12 Definition of Reverse Milepoint

Distances are measured in miles from the end of the Line Feature in reverse direction (absolute Linear Referencing Method).

7.2.114.3.13 Definition of Reverse Kilopoint

Distances are measured in kilometres from the end of the Line Feature in reverse direction (absolute Linear Referencing Method).

7.2.114.3.14 Definition of Reverse Percentage

Distances are expressed as a percentage of the total Line Feature length, measured from the end towards the start of the Line Feature, i.e. in reverse direction (interpolative Linear Referencing Method).

7.2.115 Linear Segmentation

7.2.115.1 Definition

The linearly referenced position or linear extent along a Line Feature for which an Attribute is valid.

7.2.115.2 Domain/unit of measure

Composite.

7.2.115.3 Sub-Attributes

This Composite Attribute can consist of the following Sub-Attributes :

- Distance Expression — Mandatory
- Distance Expression

7.2.115.4 Description

This Attribute may be used in combination with any Simple or Composite Attribute Type. The concept of a segmented Attribute is illustrated in Figure 134.

Two Distance Expression Attribute values are used as linearly referenced positions delimiting the segmented Attribute's validity; the orientation sense of the two instances of the Distance Expression Attribute shall coincide with the Line Feature's orientation. This is, the linearly referenced position which is closer to the start of the Line Feature implies the start (or From position) of the linear segment, the linearly referenced position which is closer to the end of the Line Feature implies the end (or To position) of the linear segment. To indicate a single position in lieu of an interval, one Distance Expression Attribute value suffices.

Whether a linearly referenced position is measured from the start of a Line Feature or from the end of a Line Feature is determined by the applicable Location Referencing Method Attribute which is either set as default for said (class of) Line Features or defined individually as Sub-Attribute part of the Distance Expression Attribute, in which case it is overriding the default setting.

If a linearly referenced position equals the end of a Line Feature, or in case of reverse referencing orientation the start of a Line Feature, two possibilities exist to specify this. There is the normal way in which the Distance Expression Attribute in question specifies the total length of the Line Feature. Another way to do this is by storing the special value '-1'.

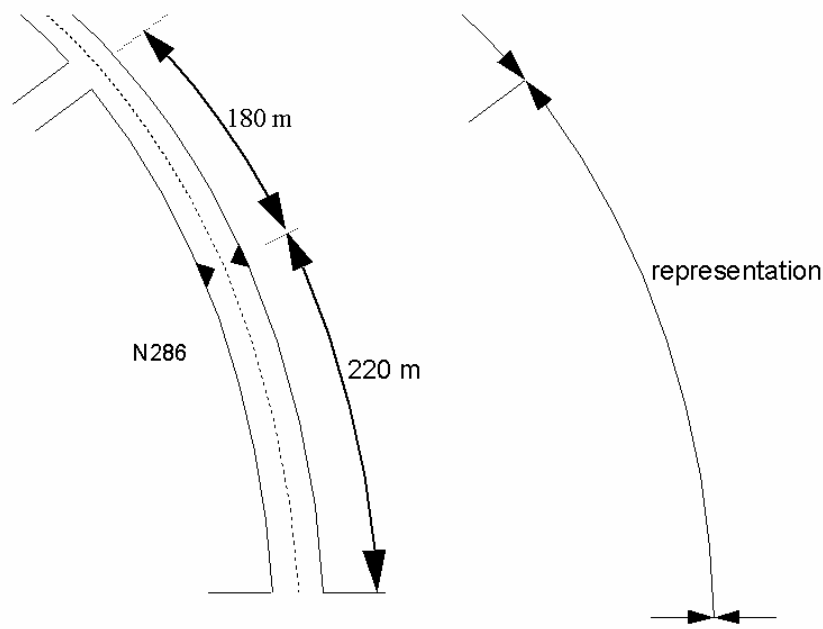

A road with a road number N286 and a road width of 15 m which narrows at a certain point to 8 m after which it gets its original width again.

Figure 134 (continued)

from pos: 0	from pos: 220	from pos: 220	from pos: 0 (or <S>)
to pos: 220	to pos: 220	to pos: 400 (or -1)	to pos: 400 (or <S>)
road width: 15	road width: 8	road width: 15	road number: N286

Associated segmented Attributes (<S>) indicate blanks.

Figure 134 — An example of the use of Linear Segmentation

7.2.116 Location Description

7.2.116.1 Definition

Textual description of the location of a Feature in the field.

7.2.116.2 Domain/unit of measure

Character string

7.2.116.3 Description

Describes the location of a Feature such that the Feature can be easily and unambiguously located in the field.

7.2.117 Location Reference

7.2.117.1 Definition

The location reference code of a certain location according to a certain location referencing system.

7.2.117.2 Domain/unit of measure

Composite.

7.2.117.3 Sub-Attributes

The Composite Attribute Location Reference consists of the following Sub-Attributes:

- Location Reference Code [.]..[.] — Mandatory
- Location Reference Type — Mandatory

NOTE [.]..[.] indicates that the Sub-Attribute can have multiple instances in the framework of the Composite Attribute.

7.2.118 Location Reference Code

7.2.118.1 Definition

The identification of a location according to a certain location referencing system.

7.2.118.2 Domain/unit of measure

Any value representing a valid location referencing code.

7.2.118.3 Description

This Attribute is used as a Sub-Attribute in conjunction with the Sub-Attribute Location Reference Type. Together these Sub-Attributes form the Composite Attribute Location Reference.

A location referencing code is used to identify a specific location or section of the road network for traffic messaging purposes.

7.2.119 Location Reference Type

7.2.119.1 Definition

The type of location referencing system employed for the associated Location Reference Code.

7.2.119.2 Domain/unit of measure

- RDS/TMC
- VICS
- User defined

7.2.119.3 Description

This Attribute is used as a Sub-Attribute in conjunction with the Sub-Attribute Location Reference Code. Together these Sub-Attributes form the Composite Attribute Location Reference.

7.2.120 Lower Building Elevation

7.2.120.1 Definition

The lower elevation of a Building, above which the building structure extends up to the upper building elevation.

7.2.120.2 Domain/unit of measure

7.2.120.2.1 Value domain

The value shall be expressed in either Metric or English default units, or in user-defined units. Metric default unit is metre; English default unit is foot.

7.2.120.2.2 Measure

A measure of Lower Building Elevation is composed of a value and a unit of measure.

7.2.120.2.3 Unit of measure

The unit of measure of Lower Building Elevation is a Union of three: a Metric default unit, an English default unit, or a user-defined unit. User-defined units allow overriding of the default.

7.2.120.3 Description

The Attribute Lower Building Elevation is used in conjunction with the Sub-Attribute Upper Building Elevation. Together they make up the Composite Attribute Complex Building Elevation.

7.2.121 Magnetic Anomalies

7.2.121.1 Definition

This Attribute when True indicates an apparent change in the earth's magnetic field due to the presence of a construction and within the local area of that construction.

7.2.121.2 Domain/unit of measure

- True
- False

7.2.121.3 Description

Constructions that may influence the earth's magnetic field include: bridges, tunnels, power lines, electric railways and tramways.

7.2.122 Main Railway Station

7.2.122.1 Definition

This Attribute when True indicates a facility which has a relatively high level of importance in the transportation network of an urban area. An urban area may have more than one main railway station.

7.2.122.2 Domain/unit of measure

- True
- False

7.2.123 Maximum Height Allowed

7.2.123.1 Definition

The maximum height limit of a vehicle that may use the Road Element, Ferry Connection or Path. The limit is normally set by a physical obstruction such as a bridge or tunnel, or a legal restriction.

7.2.123.2 Domain/unit of measure

7.2.123.2.1 Value domain

The value should be expressed in either Metric or English default units, or in user-defined units. Metric default unit is centimetre; English default unit is inch.

7.2.123.2.2 Measure

A measure of Maximum Height Allowed is composed of a value and a unit of measure.

7.2.123.2.3 Unit of measure

The unit of measure of Maximum Height Allowed is a Union of three: a Metric default unit, an English default unit, or a user-defined unit. User-defined units allow overriding of the default.

The value shall be expressed in centimetres.

7.2.124 Maximum Length Allowed

7.2.124.1 Definition

The legal maximum length of a vehicle that may use the Road Element, Ferry Connection or Path.

7.2.124.2 Domain/unit of measure

7.2.124.2.1 Value domain

The value should be expressed in either Metric or English default units, or in user-defined units. Metric default unit is centimetre; English default unit is inch.

7.2.124.2.2 Measure

A measure of Maximum Length Allowed is composed of a value and a unit of measure.

7.2.124.2.3 Unit of measure

The unit of measure of Maximum Length Allowed is a Union of three: a Metric default unit, an English default unit, or a user-defined unit. User-defined units allow overriding of the default.

7.2.125 Maximum Number of Lanes

7.2.125.1 Definition

The maximum number of lanes existing on a Road Element.

7.2.125.2 Domain/unit of measure

Any integer value.

7.2.125.3 Description

The Maximum Number of Lanes Attribute refers to the total number of lanes associated with one particular driving direction which are at least present on a certain Road Element. If this Attribute appears once with one Road Element without a side indication it indicates that both driving directions have the same maximum number of lanes or, in case there is only one driving direction, the total maximum number of lanes. In case two different driving directions on a Road Element have a different maximum number of lanes, each number can be specified by a different Attribute Value in combination with a side indication.

7.2.126 Maximum Total Weight Allowed

7.2.126.1 Definition

The legal maximum total weight of a vehicle that may use the Road Element, Ferry Connection or Path.

7.2.126.2 Domain/unit of measure

7.2.126.2.1 Value domain

The value should be expressed in either Metric or English default units, or in user-defined units. Metric default unit is tenth of a metric ton; English default unit is tenth of an English ton.

7.2.126.2.2 Measure

A measure of Maximum Total Weight Allowed is composed of a value and a unit of measure.

7.2.126.2.3 Unit of measure

The unit of measure of Maximum Total Weight is a Union of three: a Metric default unit, an English default unit, or a user-defined unit. User-defined units allow overriding of the default.

7.2.127 Maximum Weight per Axle Allowed

7.2.127.1 Definition

The legal maximum weight per axle of a vehicle that may use the Road Element, Ferry Connection or Path.

7.2.127.2 Domain/unit of measure

7.2.127.2.1 Value domain

The value should be expressed in either Metric or English default units, or in user-defined units. Metric default unit is tenth of a metric ton ; English default unit is tenth of an English ton.

7.2.127.2.2 Measure

A measure of Maximum Weight per Axle Allowed is composed of a value and a unit of measure.

7.2.127.2.3 Unit of measure

The unit of measure of Maximum Weight per Axle Allowed is a Union of three: a Metric default unit, an English default unit, or a user-defined unit. User-defined units allow overriding of the default.

7.2.128 Maximum Width Allowed

7.2.128.1 Definition

The maximum width limit of a vehicle that may use the Road Element, Ferry Connection or Path. The limit is normally set by a physical obstruction such as a bridge or a legal restriction.

7.2.128.2 Domain/unit of measure

7.2.128.2.1 Value domain

The value should be expressed in either Metric or English default units, or in user-defined units. Metric default unit is centimetre; English default unit is inch.

7.2.128.2.2 Measure

A measure of Maximum Width Allowed is composed of a value and a unit of measure.

7.2.128.2.3 Unit of measure

The unit of measure of Maximum Width Allowed is a Union of three: a Metric default unit, an English default unit, or a user-defined unit. User-defined units allow overriding of the default.

7.2.129 Measured Length

7.2.129.1 Definition

The three-dimensional length of a Road Element or path or Anchor Section.

7.2.129.2 Domain/unit of measure

7.2.129.2.1 Value domain

The value should be expressed in either Metric or English default units, or in user-defined units. Metric default unit is metre; English default unit is foot.

7.2.129.2.2 Measure

A measure of Measured Length is composed of a value and a unit of measure.

7.2.129.2.3 Unit of measure

The unit of measure of Measured Length is a Union of three: a Metric default unit, an English default unit, or a user-defined unit. User-defined units allow overriding of the default.

7.2.129.3 Description

The value represents the length as it can be measured in reality.

In the case of an Anchor Section, it defines the official length of the distance between the Anchor Points represented by the Anchor Section.

7.2.130 Military Airport

7.2.130.1 Definition

This Attribute when True indicates whether an airport is structurally used for Military Airport activities.

7.2.130.2 Domain/unit of measure

- True
- False

7.2.131 Minimum Number of Lanes

7.2.131.1 Definition

The minimum number of lanes existing on a Road Element.

7.2.131.2 Domain/unit of measure

Any integer value.

7.2.131.3 Description

The Minimum Number of Lanes Attribute refers to the total number of lanes associated with one particular driving direction which are at least present on a certain Road Element. If this Attribute appears once with one Road Element without a side indication it indicates that both driving directions have the same minimum number of lanes or, in case there is only one driving direction, the total minimum number of lanes. In case two different driving directions on a Road Element have a different minimum number of lanes, each number can be specified by a different Attribute Value in combination with a side indication.

7.2.132 Minimum Number of Occupants

7.2.132.1 Definition

The minimum number of occupants of a vehicle which are required by traffic restriction.

7.2.132.2 Domain/unit of measure

Any integer value.

7.2.132.3 Description

This Sub-Attribute should be used in conjunction with the Sub-Attribute Vehicle Type. This combination only has meaning if the Vehicle Type has the value "High Occupancy Vehicle". Together these Sub-Attributes form the Composite Attribute High Occupancy Vehicle.

7.2.133 Mountain Pass

7.2.133.1 Definition

The existence, height and opening period of a Road Element which is considered as a Mountain Pass.

7.2.133.2 Domain/unit of measure

Composite

7.2.133.3 Sub-Attributes

The Composite Attribute Mountain Pass consists of the following Sub-Attributes:

- Pass — Mandatory
- Height Label
- Opening Period [..][.]

NOTE [..][.] indicates that the Sub-Attribute can have multiple instances in the framework of the Composite Attribute.

7.2.134 Multi Media Action

7.2.134.1 Definition

A Specification of what to do with the Multi Media Object.

7.2.134.2 Domain/unit of measure

User Defined.

7.2.134.3 Description

The action to be performed with Multi Media Object shall be described by referring to a set of user defined descriptions.

7.2.135 Multi Media Description

7.2.135.1 Definition

A semantic classification of the Multi Media Object.

7.2.135.2 Domain/unit of measure

- Unknown
- Building Roof Object
- Façade Component Object
- Façade Fabric Object
- 3-D Landmark Object
- Elevation Point Grid Object
- User Defined

7.2.135.3 Description

The Multi-Media Object shall be described by referring to a set of predefined or user defined description classes. The predefined description classes each corresponds to the semantic context of a particular (set of) Feature(s) and Composite Attribute(s).

7.2.136 Multi-Media File Attachment

7.2.136.1 Definition

A Multi-Media File containing Multi-Media Objects “decorating” the associated Feature.

7.2.136.2 Domain/unit of measure

Composite.

7.2.136.3 Sub-Attributes

This Composite Attribute can consist of the following Sub-Attributes:

- Multi-Media File Attachment Context
- Multi-Media File Attachment Name — Mandatory
- Multi-Media File Attachment Type — Mandatory

7.2.136.4 Description

This Attribute does not specify what name a file should have nor any restriction on the format of the name of that file. However, in order to provide such naming flexibility, it is necessary to adhere to well defined means of designating a “file type” of the Multi-Media file. For instance, a JPEG Image, a Wave Audio file, a Quick Time Movie clip, an HTML complex file (which contains within it other more elementary components, such as sounds and images), or even a Word Processor document, are examples of Multi-Media files which may be attached to the GDF file as an Attribute to any Feature. It is assumed that the Multi-Media files are separated files, and not an internal part of the GDF file. Since Multi-Media file types come and go, it is deemed not an efficient usage of the standard to continually code file types. The standard therefore specifies the use of the industry standard MIME (Multipurpose Internet Mail Extensions). MIME is a standard used in mail applications, as well as in web browsers and many other internet applications. New MIME types are regularly published, after they get officially registered [49].

The goal of this Attribute is to designate a Multi-Media file in a standard way without succumbing to a platform dependent way of doing so.

7.2.137 Multi-Media File Attachment Context

7.2.137.1 Definition

The context of the Multi-Media file attached to the Feature.

7.2.137.2 Domain/unit of measure

Composite.

7.2.137.3 Sub-Attributes

This Composite Attribute can consist of the following Sub-Attributes:

- Multi Media Description — Mandatory
- Multi Media Action
- Multi Media Time Domain [.]..[.]

NOTE [.]..[.] indicates that the Sub-Attribute can have multiple instances in the framework of the Composite Attribute.

7.2.137.4 Description

A context for the Multi-Media attachment to the Feature is provided to make it easier for the application to decide what to do when with the Multi-Media attachment.

7.2.138 Multi Media File Attachment Name

7.2.138.1 Definition

Name of the Multi-Media file attached to the Feature.

7.2.138.2 Domain/unit of measure

Any combination of characters and punctuation.

7.2.138.3 Description

No particular constraints regarding file naming have been specified.

7.2.139 Multi Media File Attachment Type

7.2.139.1 Definition

The type of the Multi-Media file attached to the Feature.

7.2.139.2 Domain/unit of measure

Any combination of characters and punctuation.

7.2.139.3 Description

The goal of this Attribute is to designate a Multi-Media file type in a standard way without succumbing to a platform dependent way of doing so. By choosing an industry standard way of specifying file types, operating system dependency is removed. It is not necessary to guess the type from the filename (and its suffix). Furthermore, the burden of keeping an updated list of recognized file types is proxied out to another organisation whose charter it is to do so. Finally, it is not necessary to update this International Standard, each time a new Multi-Media file type is introduced. By allowing for a dynamic definition to be embedded into this International Standard the equivalent of an hyper-standard mark-up format is created.

This Multi-Media File attachment Type Attribute Value shall be in adherence with the MIME type specifications. These specify that a file type shall be of the format <genus> "I" <species>. For example, the file type "image/jpeg" has the genus image, and species jpeg. The terms, "genus" and "species" are not Mime standard terminology, but are useful for referencing (the actual Mime correct nomenclature is "type" and "subtype". At the time of completion of this International Standard, only the following 8 genera had been defined: application, audio, image, message, model, multipart, text and video. There are hundreds of official species and about as many unofficial ones. Unofficial species are delineated with a leading "x". The following may serve as an example of a commonly used, yet not officially registered species: "audio/x-wav". Recently, there has been an "IP-address" style name sub-grouping at the species level. The VND prefix with any number of levels following stands for vendor specific file types.

- EXAMPLE 1 Audio/vnd.xiff.
- EXAMPLE 2 Application/vnd.lotus-1-2-3.
- EXAMPLE 3 Application/vnd.ibm.modcap.
- EXAMPLE 4 Application/vnd.mitsubishi.misty-guard.trustweb.
- EXAMPLE 5 Video/vnd.motorola.video.

7.2.140 Multi Media Time Domain

7.2.140.1 Definition

A Specification when to perform the action indicated in the associated Sub-Attribute Multi Media Action.

7.2.140.2 Domain/unit of measure

The value shall be expressed as a (set of) starting date(s) or as a combination of starting date(s) & time duration(s), or starting date(s) / ending date(s), according to the Time Domain syntax.

7.2.141 Name Component

7.2.141.1 Definition

The specification of a portion of a name which has a specific meaning.

7.2.141.2 Domain/unit of measure

Composite.

7.2.141.3 Sub-Attributes

This Composite Attribute can consist of the following Sub-Attributes:

- Name Component Offset — Mandatory
- Name Component Length — Mandatory
- Name Component Type — Mandatory

7.2.141.4 Description

This Attribute is used as a Sub-Attribute in conjunction with the Sub-Attributes Alternate Street Name Text or Official Street Name Text to form the Composite Attribute Alternate Street Name Body or Official Street Name Body, or with the Sub-Attributes Alternate Name Text or Official Name Text to form the Composite Attribute Alternate Name Body or Official Name Body.

7.2.142 Name Component Length

7.2.142.1 Definition

The length of a Name Component.

7.2.142.2 Domain/unit of measure

Any positive number within the field limits.

7.2.142.3 Description

Name Component Length is specified in the number of characters (and not in number of bytes).

This Attribute is used as a Sub-Attribute in conjunction with the Sub-Attributes Name Component Offset and Name Component Type to form the composite Name Component.

7.2.143 Name Component Offset

7.2.143.1 Definition

The offset of a name that represents the beginning of a Name Component.

7.2.143.2 Domain/unit of measure

Any positive number within the field limits.

7.2.143.3 Description

Name Component Length is specified in the number of characters (and not in number of bytes) at which a Name Component starts. If the Name Component starts at the beginning of the name, the Name Component Offset will equal 1.

This Attribute is used as a Sub-Attribute in conjunction with the Sub-Attributes Name Component Length and Name Component Type to form the composite Name Component.

7.2.144 Name Component Type

7.2.144.1 Definition

The type of a name component.

7.2.144.2 Domain/unit of measure

- Name Component Type 1
- Name Component Type 2
- Name Component Type n

7.2.144.3 Description

This Attribute is used as a Sub-Attribute in conjunction with the Sub-Attributes Name Component Length and Name Component Offset to form the composite Name Component.

7.2.145 Name Prefix

7.2.145.1 Definition

A part of the official or alternate name not belonging to the Official/Alternate Name Body, usually indicating the type of object the name refers to and which comes prior to the Official/Alternate Name Body.

7.2.145.2 Domain/unit of measure

Any combination of characters and punctuation which forms a valid name.

7.2.145.3 Description

EXAMPLE Hotel American, or Luchthaven (Airport) Schiphol.

7.2.146 National Road Class

7.2.146.1 Definition

The numeric classification equivalencies to the order of the National Road Classification of a Road Element, Ferry Connection or Path, where 1 equals the highest class of road.

7.2.146.2 Domain/unit of measure

- Main roads: the most important roads.
- First class roads.
- Second class roads.
- Third class roads.
- Fourth class roads.
- Fifth class roads.
- Sixth class roads.
- Seventh class roads.
- Eighth class roads.
- Ninth class roads: The least important roads.

7.2.147 Not Crossable by Pedestrians

7.2.147.1 Definition

Indication that a Road Element, Junction, Road or Intersection is clearly not advised to be crossed by pedestrians, either as being prohibited or too dangerous.

7.2.147.2 Domain/unit of measure

- No crossing advised (prohibited)
- No crossing advised (dangerous)
- No crossing not advised

7.2.147.3 Description

The indication for pedestrians not to cross may take into account physical as well as legal provisions. Physical provisions, such as road markings, fences, barriers, or vegetation, may be placed on one or both sides of a roadway or on the median in case of dual carriageways.

7.2.148 Notation

7.2.148.1 Definition

Classification of the nature of the name notation.

7.2.148.2 Domain/unit of measure

Composite

7.2.148.3 Sub-Attributes

- Notation Version
- Notation Variant
- Notation Anomaly
- Notation Alphabet

7.2.148.4 Description

The Notation Attribute may be associated with name Attributes or with name strings, i.e. with the actual values of name Attributes.

Notation properties are meaningful for name parsing, matching, transcription, and presentation. Other properties for intelligent name processing are related to languages and to phonetic transcriptions (covered by other Attributes).

7.2.149 Notation Alphabet

7.2.149.1 Definition

The script used to represent a (written) name.

7.2.149.2 Domain/unit of measure

- user-defined

7.2.149.3 Description

This Attribute is used as a Sub-Attribute in conjunction with Notation Variant, Notation Version, and Notation Anomaly. Together they form the Composite Attribute Notation

7.2.150 Notation Anomaly

7.2.150.1 Definition

Representation anomaly of the name notation.

7.2.150.2 Domain/unit of measure

- usual form
- non-literal form
- synonym

7.2.150.3 Description

7.2.150.3.1 Definition of Usual Form

The usual form of a name (not an anomaly).

7.2.150.3.2 Definition of Non-literal Form

An alternate spelling of a name to represent how it is spoken. Typically used to extend (un-abbreviate) abbreviations or acronyms.

7.2.150.3.3 Definition of Synonym

Other name for an original name in the same (written) language.

7.2.150.3.4 Use as Sub-Attribute

This Attribute is used as a Sub-Attribute in conjunction with Notation Variant, Notation Version, and Notation Alphabet. Together they form the Composite Attribute Notation.

7.2.151 Notation Variant

7.2.151.1 Definition

The spelling form of the name notation.

7.2.151.2 Domain/unit of measure

- Given form
- Long form
- Short form
- Alternate spelling

7.2.151.3 Description

7.2.151.3.1 Definition of Given Form

The normal spelling of a name (e.g. as published in directories or official maps).

7.2.151.3.2 Definition of Long Form

A longer (e.g. fully spelled out) spelling representation of a name.

7.2.151.3.3 Definition of Short Form

A shorter (e.g. abbreviated) spelling representation of a name.

7.2.151.3.4 Definition of Alternate Spelling

An alternate spelling of a name (e.g. traditional/modern or common misspelling).

7.2.151.3.5 Use as Sub-Attribute

This Attribute is used as a Sub-Attribute in conjunction with Notation Version, Notation Anomaly, and Notation Alphabet. Together they form the Composite Attribute Notation.

7.2.152 Notation Version

7.2.152.1 Definition

The language-specific version of the name notation.

7.2.152.2 Domain/unit of measure

- Original
- Exonym

7.2.152.3 Description

7.2.152.3.1 Definition of Original

A name in the applicable local language.

7.2.152.3.2 Definition of Exonym

Alternate version of an original name in another (written) language.

7.2.152.3.3 Use as Sub-Attribute

This Attribute is used as a Sub-Attribute in conjunction with Notation Variant, Notation Anomaly, and Notation Alphabet. Together they form the Composite Attribute Notation.

7.2.153 Number of Lanes

7.2.153.1 Definition

The number of lanes existing on a Road Element or Path.

7.2.153.2 Domain/unit of measure

Any integer value.

7.2.153.3 Description

The Number of Lanes Attribute refers to the total number of lanes associated with one particular driving direction which are present on a certain Road Element. If this Attribute appears once with one Road Element without a side indication it indicates that both driving directions have the same number of lanes or, in case there is only one driving direction, the total number of lanes. In case two different driving directions on a Road Element have a different number of lanes, each number can be specified by a different Attribute Value in combination with a side indication.

7.2.154 Number of Rooms

7.2.154.1 Definition

The number of rooms available to the public.

7.2.154.2 Domain/unit of measure

Any positive integer within the Field limits.

7.2.155 Official Code

7.2.155.1 Definition

The official code of the Administrative Area or Named Area or District or Built-up Area employed by the relevant authorities.

7.2.155.2 Domain/unit of measure

Any combination of letters, numbers, punctuation which form a valid code.

7.2.156 Official Language

7.2.156.1 Definition

A language officially recognized by a government or in predominant use in an Administrative or Named Area.

7.2.156.2 Domain/unit of measure

An ISO 639-2 language code [1].

7.2.156.3 Description

A given area may have multiple official languages.

7.2.157 Official Name

7.2.157.1 Definition

The name assigned to any particular Feature by the official organisation responsible for the existence and the maintenance of the Feature.

7.2.157.2 Domain/unit of measure

Composite.

7.2.157.3 Sub-Attributes

This Composite Attribute can consist of the following Sub-Attributes:

- Name Prefix
- Official Name Body — Mandatory

7.2.157.4 Description

A single Feature may have more than one Official Name. This often is associated with a bilingual situation. A language code shall be used to specify the applied language.

The use of prefixes is not obligatory, even if they make up part of the official names. If prefixes are not applied but are part of the official name, they shall be part of the Official Name Body.

Spaces are assumed to exist in between the components of the official name. They are not explicitly added.

7.2.158 Official Name Body

7.2.158.1 Definition

The part of the official name which has, compared to the prefix, most identifying power.

7.2.158.2 Domain/unit of measure

Composite.

7.2.158.3 Sub-Attributes

This Composite Attribute can consist of the following Sub-Attributes :

- Name Component [..][.]
- Official Name Text – Mandatory

NOTE [..][.] indicates that the Sub-Attribute can have multiple instances in the framework of the Composite Attribute.

This Attribute is used as a Sub-Attribute, possibly in conjunction with the Sub-Attribute Name Prefix. Together these form the Composite Attribute Official Name.

7.2.158.4 Description

In most cases it will be sufficient to sub-divide the official name on name body level. In these cases Official Name Body will consist of one instance of Official Name Text and zero instances of Name Component. In certain cases a need may exist to be able to further sub-divide the Official Name Body. In these cases, Official Name Body consists of one instance of Official Name Text and two or more Name Components.

7.2.159 Official Name Text

7.2.159.1 Definition

(A part of) an official name.

7.2.159.2 Domain/unit of measure

Any combination of characters and punctuation.

7.2.159.3 Description

EXAMPLE Hotel American, or Luchthaven (Airport) Schiphol.

This Attribute is used as a Sub-Attribute, possibly in conjunction with the Sub-Attribute Name Component to form the Composite Attribute Official Name Body.

7.2.160 Official Street Name

7.2.160.1 Definition

The official name of Road Element, Pathway or Address Area Boundary Element.

7.2.160.2 Domain/unit of measure

Composite.

7.2.160.3 Sub-Attributes

This Composite Attribute can consist of the following Sub-Attributes:

- Directional Prefix
- Street Type Prefix
- Official Street Name Body— Mandatory
- Trailing Spaces
- Street Type Suffix
- Directional Suffix
- Composite Pronunciation

This Attribute is used as a Sub-Attribute possibly in conjunction with the Sub-Attribute House Number Range and Postal Code. Together these form the Composite Attribute Address Information.

7.2.160.4 Description

The use of pre- or suffixes is not obligatory, even if they make up part of the street names. If pre- or suffixes are not applied but are part of the street name, they shall be part of the Official Street Name Body. Also combinations are allowed. E.g. a Street Type Prefix might be separately defined in a Street Type Prefix while the Street Type Suffix is defined as part of the Official Street Name Body.

Spaces are assumed to exist in between the different components of the street name. They are not explicitly added. One exception exists on this point: spaces preceding and/or succeeding the Official Street Name Body are not assumed. These should be explicitly defined. For this, the Sub-Attribute Trailing Spaces has been defined.

A single Road Element or Pathway may have more than one Official Street Name. This often is associated with a bilingual situation. E.g. “Waterloolaan” and “Boulevard de Waterloo” are the official names of the same street in Brussels according to the Dutch and French language. A language code shall be used to specify the applied language.

How the application of the different Sub-Attributes in a particular GDF has been done can be specified through meta information.

The fact that Official Street Name instead of an Alternate Street Name has been defined can not be concluded from every Sub-Attribute which make up the Official Street Name. This conclusion can only be drawn from the Sub-Attribute Official Street Name Body or Alternate Street Name Body. The rest of the Sub-Attributes are identical for both types of Street Names.

7.2.161 Official Street Name Body

7.2.161.1 Definition

The part of the official street name which has, compared to the other parts, the most identifying power.

7.2.161.2 Domain/unit of measure

Composite.

7.2.161.3 Sub-Attributes

This Composite Attribute can consist of the following Sub-Attributes:

Name Component [.]..[.]

Official Street Name Text – Mandatory

This Attribute is used as a Sub-Attribute, possibly in conjunction with the Sub-Attributes Directional Prefix, Street Type Prefix, Trailing Spaces, Street Type Suffix, Directional Suffix and Composite Pronunciation. Together these form the Composite Attribute Official Street Name.

7.2.161.4 Description

In most cases it will be sufficient to sub-divide the street name on street name body level. In these cases Official Street Name Body will consist of one instance of Official Street Name Text and zero instances of Name Component. In certain cases a need may exist to be able to further sub-divide the Official Street Name Body. In these cases, Official Street Name Body consists of one instance of Official Street Name Text and two or more Name Components.

EXAMPLE 1 Embarcadero with Street Name Body Embarcadero.

EXAMPLE 2 Avenue George V with Street Name Body George V.

EXAMPLE 3 Place du General de Gaulle with Street Name Body General de Gaulle.

EXAMPLE 4 Via Appia with Street Name Body Appia.

7.2.162 Official Street Name Text

7.2.162.1 Definition

(A part of) an official street name.

7.2.162.2 Domain/unit of measure

Any combination of characters, numbers or punctuation.

7.2.162.3 Description

This Attribute is used as a Sub-Attribute, possibly in conjunction with the Sub-Attribute Name Component to form the Composite Attribute Official Street Name Body.

7.2.163 One-way

7.2.163.1 Definition

A Transportation Element is a one way street

7.2.163.2 Domain/unit of measure

- in positive direction
- in negative direction

7.2.163.3 Description

7.2.163.3.1 One-way streets

A Transportation Element for which the movement of motorised vehicles is administratively restricted to a single direction.

7.2.163.3.2 Definition of positive/negative

Positive/negative directions of One-way are expressed relative to a Road Element, Pathway or Path. The positive direction of the Road Element, Pathway or Path, respectively, as seen from the start bounding Point Feature.

7.2.164 Opening Period

7.2.164.1 Definition

The period in which the function of an associated Feature is available to the public.

7.2.164.2 Domain/unit of measure

The value shall be expressed as a combination of both starting date(s) and time duration(s) according to the Time Domain syntax.

7.2.165 Other Textual Content of a Traffic Sign

7.2.165.1 Definition

Information which cannot be represented by means of the Attributes Symbol on Traffic Sign and/or Validity Period and which does not represent textual destination information

7.2.165.2 Domain/unit of measure

Any combination of characters and punctuation.

7.2.165.3 Description

This Attribute is used as a Sub-Attribute for the Composite Attribute Traffic Sign Information. The use of this Attribute is only meaningful if it is used in conjunction with the Sub-Attribute Traffic Sign Class.

7.2.166 Ownership

7.2.166.1 Definition

Whether a Road Element is publicly or privately owned.

7.2.166.2 Domain/unit of measure

- Publicly owned
- Privately owned

7.2.167 Park and Ride Facility

7.2.167.1 Definition

This Attribute when True indicates whether a parking facility is provided with a Park and Ride facility.

7.2.167.2 Domain/unit of measure

- True
- False

7.2.167.3 Description

A parking facility such as Open Parking Area or Parking Garage with Park and Ride facility is a parking facility which offers direct access to the public transport. Usually, Park and Ride facilities are officially recognized as such and are indicated by traffic signs along the road network.

7.2.168 Park Type

7.2.168.1 Definition

An indication of the type of Land Cover and Use or Service Feature.

7.2.168.2 Domain/unit of measure

- City Park
- Regional Park
- County Park
- State/Provincial Park
- National Park

7.2.168.3 Description

There is an essential difference between City Parks and National or Regional Parks. City Parks are located in an urban environment, designed for recreational purposes and accessible free of charge. Regional or National Parks generally have a function as a nature reserve and are not always (completely) accessible by the public.

7.2.169 Parking Facilities Available

7.2.169.1 Definition

The number of parking places available.

7.2.169.2 Domain/unit of measure

Any positive integer within Field limits.

7.2.170 Parking Type Charged

7.2.170.1 Definition

This Attribute when True indicates whether a parking facility (Open Parking Area, Parking Garage) is charged.

7.2.170.2 Domain/unit of measure

- True
- False

7.2.171 Pass

7.2.171.1 Definition

This Attribute when True indicates a Road Element is regarded as a mountain pass.

7.2.171.2 Domain/unit of measure

- True
- False

7.2.171.3 Description

This Attribute is used as a Sub-Attribute in conjunction with the Sub-Attributes Height of a Pass and possibly Opening Period. Together these Sub-Attributes form the Composite Attribute Mountain Pass.

7.2.172 Passing Restrictions

7.2.172.1 Definition

This Attribute when True indicates that other cars is not allowed on the associated Road Element.

7.2.172.2 Domain/unit of measure

- True
- False

7.2.172.3 Description

This Attribute should be used as a Sub-Attribute in combination with the Attribute Vehicle Type.

7.2.173 Pathway Safety Indicator

7.2.173.1 Definition

The indication of a safety level of a Road Element or Pathway for use by pedestrians and non-motorised vehicles.

7.2.173.2 Domain/unit of measure

- Uncritical
- To be avoided
- Barred

7.2.173.3 Description

7.2.173.3.1 Definition of Uncritical

A Road Element or Pathway generally considered safe for pedestrians and non-motorised vehicles.

7.2.173.3.2 Definition of To be avoided

A Road Element or Pathway may not be safe or secure for pedestrians and non-motorised vehicles, for reasons such as dense motorised traffic or dangerous neighbourhoods.

7.2.173.3.3 Definition of Barred

A Road Element or Pathway declared barred for use by pedestrians and other non-motorists by means of safety risk related regulations.

7.2.174 Pathway Type

7.2.174.1 Definition

The physical type of Pathway.

7.2.174.2 Domain/unit of measure

- Surface Passageway
- Stairs
- Escalator
- Elevator
- Gallery
- Underpass
- Overpass
- Platform

7.2.174.3 Description

7.2.174.3.1 Definition of Surface Passageway

A paved or unpaved out-door passageway having a recognisable course via its physical appearance, markings and/or signage.

7.2.174.3.2 Definition of Stairs

Inclined passageway of steps between different building or surface levels.

7.2.174.3.3 Definition of Escalator

A one-directional Pathway of “moving stairs”, either as an included passageway between different building or surface levels or as a horizontal passageway within one level.

7.2.174.3.4 Definition of Elevator

Section of a (vertical) lift connecting two consecutive building or surface levels.

7.2.174.3.5 Definition of Gallery

An in-door passage way through a building, e.g. shopping mall or train station.

7.2.174.3.6 Definition of Underpass

A Pathway constructed as an underground passageway underneath other Transportation Elements (or other Features), such as a Road Element.

7.2.174.3.7 Definition of Overpass

A Pathway constructed as a bridge across other Transportation Elements (or other Features), such as a Road Element.

7.2.174.3.8 Definition of Platform

A designated location dedicated for access to public transportation networks.

7.2.175 Paved Road Surface Type

7.2.175.1 Definition

The type of surface a paved Road Element has.

7.2.175.2 Domain/unit of measure

- Rigid
- Flexible
- Blocks

7.2.175.3 Description

EXAMPLE 1 Concrete is a rigid surface.

EXAMPLE 2 Asphalt is a flexible surface.

EXAMPLE 3 Cobblestones is a block surface.

This Attribute is a Sub-Attribute which together with the Sub-Attributes Pavement Status, Unpaved Road Surface Type and Road Surface Condition forms the Composite Attribute Road Surface.

7.2.176 Pavement Status

7.2.176.1 Definition

An indication of improvement applied to a Road surface.

7.2.176.2 Domain/unit of measure

- Paved
- Unpaved

7.2.176.3 Description

Gravel covered roads are considered to be unpaved.

This Attribute is a Sub-Attribute which together with the Sub-Attributes Paved Road Surface Type, Unpaved Road Surface Type and Road Surface Condition forms the Composite Attribute Road Surface.

7.2.177 Pedestrian Crossing Level

7.2.177.1 Definition

The indication whether a Pedestrian Crossing is on street level, or above or below street level.

7.2.177.2 Domain/unit of measure

- Street level crossing
- Overpass
- Underpass

7.2.178 Pedestrian Crossing Priority

7.2.178.1 Definition

The priority of a Pedestrian Crossing in relation to cross traffic.

7.2.178.2 Domain/unit of measure

- Pedestrians over road traffic
- Pedestrians over road traffic on request (at pedestrian crossings with traffic lights)
- Road traffic over pedestrians

7.2.179 Pedestrian Crossing Signage

7.2.179.1 Definition

The signage present at a Pedestrian Crossing.

7.2.179.2 Domain/unit of measure

- No traffic signs
- (Passive) Traffic signs
- Traffic signs with warning lights
- Traffic light regulated

7.2.180 Pedestrian Crossing Type

7.2.180.1 Definition

The type of street-level Pedestrian Crossing with respect to its physical appearance.

7.2.180.2 Domain/unit of measure

- No road markings
- Refuge island in the middle of road, no markings
- Zebra crossing, with or without additional constructive aids
- Other type

7.2.181 Pedestrian Type

7.2.181.1 Definition

The type of pedestrian with accessibility limitations.

7.2.181.2 Domain/unit of measure

- All pedestrian type
- Pedestrian with Stroller
- Pedestrian with Luggage cart
- Visually challenged pedestrian
- Aurally challenged pedestrian
- Mobility challenged Pedestrian with Care provider
- User defined

7.2.181.3 Description

Pedestrian Type is a Restrictive Sub-Attribute for kinds of pedestrians to which accessibility limitations apply. Pedestrian Type may be applied to any Attribute or Relationship as appropriate.

7.2.182 Percentage of International Traffic

7.2.182.1 Definition

The fraction of traffic flow measurements which represents international traffic, i.e. vehicles from other countries.

7.2.182.2 Domain/unit of measure

The value should be specified by a percentage value.

7.2.182.3 Description

This Sub-Attribute is used in conjunction with the Sub-Attributes Traffic Flow Measurement, Traffic Flow Measurement Type and Traffic Flow Measurement Unit. Together these Attributes form the Composite Attribute Traffic Flow.

7.2.183 Phonetic Alphabet

7.2.183.1 Definition

Alphabet used for encoding the phonetic transcription.

7.2.183.2 Domain/unit of measure

- IPA.
- SAMPA
- SAMPA-SAMPROSA
- X-SAMPA

7.2.183.3 Description

7.2.183.3.1 Definition of IPA

Transcription encoded using the International Phonetic Alphabet [46].

7.2.183.3.2 Definition of SAMPA

Transcription encoded using SAMPA UCL [50].

7.2.183.3.3 Definition of SAMPA SAMPROSA

Transcription encoded using both SAMPA and SAMPROSA [51].

7.2.183.3.4 Definition of X-SAMPA

Transcription encoded using extended SAMPA.

7.2.183.3.5 Use as Sub-Attribute

This Attribute is used as a Sub-Attribute in conjunction with the Sub-Attributes Pronunciation, Pronunciation Language, and Transcription Description. Together these Sub-Attributes form the Composite Attribute Composite Pronunciation

7.2.184 Place Name

7.2.184.1 Definition

Name of an Administrative Area, District or other named area that is part of the (hierarchical) address description of a Service and which is required for uniqueness of the Street Name.

7.2.184.2 Domain/unit of measure

Any combination of letters, numbers or punctuation which forms a valid name.

7.2.184.3 Description

This Sub-Attribute is used in conjunction with the Sub-Attributes Street Name, Postal Code and House Number. Together they form the Composite Attribute Service Address.

7.2.185 Place within Place Classification

7.2.185.1 Definition

The type of Place within Place Relationship.

7.2.185.2 Description

Places (i.e., Named Areas, Administrative Areas, Built-Up Areas or Districts) may be related to each other using Place within Place Relationships. Places may be related in different ways, and application behaviour may differ accordingly. The Place within Place Classification Attribute provides the data necessary for such applications to determine how a Contained Place and a Containing Place are related.

7.2.185.3 Domain/unit of measure

- Administrative

Specifies that the Contained Place listed in the Relationship is an administrative subdivision of the Containing Place.

- Postal

Specifies that the post office considers the Contained Place listed in the Relationship to be within the Containing Place for the purpose of constructing postal addresses.

- Address-significant

Specifies that end-users commonly consider the Contained Place listed in the Relationship to be within the Containing Place for the purpose of identifying locations such as origins or destinations.

- Useful for reverse-geocoding

Specifies an upward traversal of the Place tree used by the application to provide a commonly-understood description of a Place to end-users.

7.2.186 Point Assignment

7.2.186.1 Definition

A Point Assignment positions a source Point Feature along a target Line Feature.

7.2.186.2 Domain/unit of measure

Composite

7.2.186.3 Sub-Attributes

- Assignment Order — Mandatory
- Distance Expression — Mandatory

7.2.186.4 Description

Point Assignments are ordered, based on their Assignment Order Attribute. The Assignment Order corresponds to the logical Feature number among the set of source Point Features.

7.2.187 Population

7.2.187.1 Definition

The population figure of an Administrative Area or Named Area, District or Built-up Area.

7.2.187.2 Domain/unit of measure

Any integer.

7.2.188 Population Class

7.2.188.1 Definition

A classified representation of a population figure.

7.2.188.2 Domain/unit of measure

- Population Class 1
- Population Class 2
- ...
- Population Class n

7.2.188.3 Description

The classification should be done according to a user defined class division.

This Attribute is applied to either an Administrative Area, a Built-up Area, Named Area or District.

7.2.189 Positional Accuracy

7.2.189.1 Definition

An indication of the accuracy of the associated Feature.

7.2.189.2 Domain/unit of measure

7.2.189.2.1 Value domain

The value should be expressed in either Metric or English default units, or in user-defined units. Metric default unit is metre; English default unit is foot.

7.2.189.2.2 Measure

A measure of Positional Accuracy is composed of a value and a unit of measure.

7.2.189.2.3 Unit of measure

The unit of measure of Positional Accuracy is a Union of three: a Metric default unit, an English default unit, or a user-defined unit. User-defined units allow overriding of the default.

7.2.190 Post Office Type

7.2.190.1 Definition

The importance of a Post Office.

7.2.190.2 Domain/unit of measure

- Main Post Office
- Minor Post Office

7.2.190.3 Description

Typically, there will be one main Post Office in a certain Postal District, generally considered as the head office, and several (0 to n) minor Post Offices.

7.2.191 Postal Code

7.2.191.1 Definition

The official code of a postal area as defined by the national postal organisation.

7.2.191.2 Domain/unit of measure

The domain of values is only limited in a physical sense. The characters making up the Postal Code may be of any kind: blanks, digits, alphabetic characters or graphical characters.

7.2.191.3 Description

This Sub-Attribute can be used in conjunction with the Sub-Attributes Official Street Name or Alternate Street Name or Route Number and House Number Range. Together they form the Composite Attribute Address Information.

This Sub-Attribute can also be used in conjunction with the Sub-Attributes Street Name, Place Name and House Number. Together they form the Composite Attribute Service Address.

7.2.192 Priceband

7.2.192.1 Definition

The cost category of a service.

7.2.192.2 Domain/unit of measure

- highest cost category
- second highest cost category
- third highest cost category
- fourth highest cost category
- fifth highest cost category
- sixth highest cost category
- seventh highest cost category
- eighth highest cost category
- lowest cost category

7.2.193 Pronunciation

7.2.193.1 Definition

The phonetic transcription of the standard pronunciation of a name considered official and/or preferred.

7.2.193.2 Domain/unit of measure

A phonetic string.

7.2.193.3 Description

The Attribute Pronunciation is used as a Sub-Attribute in conjunction with the Sub-Attributes Phonetic Alphabet, Pronunciation System, and Transcription Description. Together these Sub-Attributes form the Composite Attribute Composite Pronunciation.

7.2.194 Pronunciation Language

7.2.194.1 Definition

The spoken language (including dialect when applicable) of the phonetic transcription.

7.2.194.2 Domain/unit of measure

An ISO 639-2 language code [1]

7.2.194.3 Description

This Attribute is used as a Sub-Attribute in conjunction with the Sub-Attributes Pronunciation, Phonetic Alphabet, and Transcription Description. Together these Sub-Attributes form the Composite Attribute Composite Pronunciation.

Alternatively, this Attribute is used as a Sub-Attribute in conjunction with the Sub-Attributes Alternate Pronunciation, Pronunciation Variant, Phonetic Alphabet, and Transcription Description. Together these Sub-Attributes form the Composite Attribute Composite Alternate Pronunciation.

7.2.195 Pronunciation Variant

7.2.195.1 Definition

Classification of Alternate Pronunciation according to its transcription characteristics.

7.2.195.2 Sub-Attributes

- sub-standard
- local
- literal

7.2.195.3 Description

7.2.195.3.1 Definition of Sub-standard

A recognized pronunciation variant of a name different from standard pronunciation.

7.2.195.3.2 Definition of Local

A local pronunciation variant of a name.

7.2.195.3.3 Definition of Literal

The literal pronunciation of a name. Occurs for names which are subject to pronunciation anomalies or have abbreviations.

7.2.195.3.4 Use as Sub-Attribute

This Attribute is used as a Sub-Attribute in conjunction with the Sub-Attributes Alternate Pronunciation, Pronunciation Variant, Phonetic Alphabet, and Pronunciation Language. Together these Sub-Attributes form the Composite Attribute Composite Alternate Pronunciation.

7.2.196 Public Transport Mode

7.2.196.1 Definition

The type of public transport that is serving the Route Link, Route, Stop Point, Line or Public Transport Connection.

7.2.196.2 Domain/unit of measure

- Bus
- Light Rail
- Underground
- Rail
- Passenger Ferry

7.2.196.3 Description

A Route Link and Stop Point can be served by more than one Public Transport Mode.

7.2.197 Public Transport Operator

7.2.197.1 Definition

The (brand) name of the organisation that is running a particular public transport Line or Route.

7.2.197.2 Domain/unit of measure

Any combination of letters, numbers or punctuation which forms a valid name.

7.2.198 Publicly Accessible

7.2.198.1 Definition

This Attribute when True indicates that a Road Element is publicly accessible.

7.2.198.2 Domain/unit of measure

- True
- False

7.2.199 Railway Type

7.2.199.1 Definition

A classification reflecting the importance of a railway line or station.

7.2.199.2 Domain/unit of measure

- Main/national Railway
- Minor/regional Railway
- Underground/Metro

7.2.199.3 Description

The difference between Main/Minor Railway and Underground/Metro is whether

- the line or station represents part of the national (inter-urban) railway network (or of one of the networks making up the national network), or
- the line or station represents part of a (sub)urban network.

Whether it is located underground or on ground level is of no importance. Consequently a Main/Minor Railway Station can be located underground and an Underground Station on ground level or elevated.

The distinction between main/national railway and minor/regional railway may take into account the existence of dedicated tracks for high-speed trains, or stations serving as hubs for connecting national and regional train connections.

A Railway Station can have only one type:

- if a Railway Station gives access both to the national and to the regional railway network, it should be classified as main/national railway;
- if a Railway Station gives access both to the national/regional and to the urban railway network, it should be represented by two different Railway Stations.

7.2.200 Rating

7.2.200.1 Definition

The quality category of a Service. This may be based on any classification scheme such as the Automobile Association (UK), or Michelin (France) etc.

7.2.200.2 Domain/unit of measure

- Unclassified
- 5th (Lowest) category
- 4th category
- 3rd category
- 2nd category
- 1st (highest) category

7.2.200.3 Description

The number of classes, and therefore also the class which represents the highest quality, will vary from one classification scheme to another.

7.2.201 Region Code

7.2.201.1 Definition

The Region Code according to some regional coding scheme, chosen by the map publisher.

7.2.202 Removable Blockage

7.2.202.1 Definition

The way in which a removable barrier is to be removed.

7.2.202.2 Domain/unit of measure

- Accessible for Emergency Vehicles only
- Accessible via Keyed Access
- Guarded

7.2.202.3 Description

The Attribute Removable Blockage is used as a Sub-Attribute in conjunction with the Sub-Attributes Blocked Passage Location and Blocked Passage Type. Together these Sub-Attributes form the Composite Attribute Blocked Passage.

7.2.203 Restaurant Facilities Available

7.2.203.1 Definition

This Attribute when True indicates whether restaurant facilities are available.

7.2.203.2 Domain/unit of measure

- True
- False

7.2.204 Road And Rail Network And Associated Land Type

7.2.204.1 Definition

Type of Road And Rail Network And Associated Land

7.2.204.2 Domain/unit of measure

- Road And Rail Network And Associated Land Type 1
- Road And Rail Network And Associated Land Type 2
-
- Road And Rail Network And Associated Land Type 50

7.2.204.3 Description

An example of a Road And Rail Network And Associated Land Type is freeway road block.

7.2.205 Road Furniture Position

7.2.205.1 Definition

The position of a Road Furniture relative to a Road Element.

7.2.205.2 Domain/unit of measure

- To the right of road
- To the left of the road
- Overhead

In case of multiple sets of road furniture together forming one logical group with identical meaning, combinations (e.g. both right and above) can be represented by summing up the respective Attribute value codes into one (cumulated) value.

7.2.205.3 Description

This Attribute can form a Sub-Attribute in conjunction with the Sub-Attributes Direction Category. Together they form the Composite Attribute Traffic Light Info.

7.2.206 Road Gradient

7.2.206.1 Definition

The road gradient percentage value on the Road Element.

7.2.206.2 Domain/unit of measure

The gradient shall be expressed in the form of a percentage incline. Negative values describe downhill gradients, positive values describe uphill gradients.

Only the maximum gradient value at any position along the Road Element need be stored.

In case the gradient relates to the entire Road Element, only the maximum gradient value at any position along the Road Element need be stored.

7.2.206.3 Description

Uphill and downhill should be defined relative to the orientation of the Road Element when travelling from start to end point.

7.2.207 Road Inclination

7.2.207.1 Definition

The transverse gradient of a Road Element.

7.2.207.2 Domain/unit of measure

The inclination shall be expressed in the form of a permille incline. Negative values describe inclinations from the left to the right side of the road, positive values describe inclination in the reverse direction. The inclination is defined relative to the Road Element orientation from start to end Junction.

In case the inclination relates to the entire Road Element, only the maximum inclination value at any position along the Road Element need be stored.

The inclination should be rounded off to the nearest integer. The valid range is from -999 to +999.

7.2.208 Road Surface

7.2.208.1 Definition

The type and condition of the surface of a Road Element.

7.2.208.2 Domain/unit of measure

Composite.

7.2.208.3 Sub-Attributes

This Composite Attribute can consist of the following Sub-Attributes:

- Pavement Status – Mandatory
- Paved Road Surface Type
- Unpaved Road Surface Type
- Road Surface Condition

7.2.208.4 Description

The Sub-Attributes are independent. This implies that a dirt road can have a good Road Surface Condition while a Road paved with asphalt can have a poor Road Surface Condition.

7.2.209 Road Surface Condition

7.2.209.1 Definition

An indication of the quality for transportation purposes of the surface of a Road Element.

7.2.209.2 Domain/unit of measure

- Good
- Poor

7.2.209.3 Description

What is considered good and what poor shall be defined from the viewpoint of car transportation.

This Attribute is a Sub-Attribute which together with the Sub-Attributes Pavement Status, Paved Road Surface Type and Unpaved Road Surface Type forms the Composite Attribute Road Surface.

7.2.210 Road Under Structure

7.2.210.1 Definition

This Attribute when True indicates a Road Element that is entirely underneath or within a Structure whose dimensions are not negligible in regards to its coverage of the Road Element.

7.2.210.2 Domain/unit of measure

- True
- False

7.2.210.3 Description

Structure Types relevant to this Attribute include a multi-lane Bridge or Viaduct or a Gallery.

7.2.211 Road with Bicycle Lane

7.2.211.1 Definition

This Attribute when True indicates the existence of a bicycle lane along (both sides of) the core roadway represented by a Road Element.

7.2.211.2 Domain/unit of measure

- True
- False

7.2.211.3 Description

The validity of Road with Bicycle Lane can be specialised by means of the Restrictive Sub-Attribute Side of Line.

7.2.212 Road with Parking Lane

7.2.212.1 Definition

This Attribute when True indicates the existence of a parking lane (lay-by lane) along (both sides of) the core roadway represented by a Road Element.

7.2.212.2 Domain/unit of measure

- True
- False

7.2.212.3 Description

This Attribute aids map visualisation and orientation purposes.

The validity of Road with Parking Lane can be specialised by means of the Restrictive Sub-Attribute Side of Line.

7.2.213 Road with Sidewalk

7.2.213.1 Definition

This Attribute when True indicates the existence of a sidewalk for pedestrians adjacent to (both sides of) the core roadway represented by a Road Element.

7.2.213.2 Domain/unit of measure

- True
- False

7.2.213.3 Description

The validity of Road with Sidewalk can be specialised by means of the Restrictive Sub-Attribute Side of Line.

7.2.214 Route Direction

7.2.214.1 Definition

Indication of whether the Route is in the positive or negative direction of the Route Link.

7.2.214.2 Domain/unit of measure

- Negative
- Positive

7.2.214.3 Description

7.2.214.3.1 Usage rules

Route Direction is only necessary if the Route consists of one Route Link. If a Route consists of more than one Route Link the direction of the Route is already indicated by the order of the Route Links.

7.2.214.3.2 Indication of a particular direction

The direction of the Route Link should be defined as seen from the start bounding Point Feature.

7.2.215 Route Number

7.2.215.1 Definition

The route number of a Road Element, Ferry Element or Path. The Route Number is the ID-number of a particular route in a given road network as Attributed by a national, sub-national or international organization (e.g. the numbering of the departmental roads in France or the E-roads in Europe).

7.2.215.2 Domain/unit of measure

Composite.

7.2.215.3 Sub-Attributes

This Composite Attribute can consist of the following Sub-Attributes:

- Directional Prefix
- Route Type Prefix
- Separator
- Route Number Body — Mandatory
- Route Type Suffix
- Directional Suffix

7.2.215.4 Description

The use of pre- or suffixes is not obligatory, even if they make up part of the route numbers. If pre- or suffixes are not applied but are part of the route number, they shall be part of the Route Number Body. Also combinations are allowed. E.g. a route type prefix might be separately defined in a Route Type Prefix while the route type suffix is defined as part of the Route Number Body.

Spaces are assumed to exist in between the different components of the street name. They are not explicitly added. One exception exists on this point: spaces in between the Route Type Prefix and Route Number Body are not assumed. These are divided by a separator defined in Separator.

NOTE In the Theme Roads and Ferries, Route Number can be used as a Sub-Attribute in conjunction with the Sub-Attributes House Number Range and Postal Code. Together these Sub-Attributes form the Composite Attribute Address Information. Route Number can also be used as a Sub-Attribute in conjunction with the Sub-Attributes Exit Number, Official Name and Alternate Name. Together these Sub-Attributes form the Composite Attribute Composite Exit Number.

7.2.216 Route Number Body

7.2.216.1 Definition

The part of the Route Number which has, compared to the other parts, the most identifying power.

7.2.216.2 Domain/unit of measure

Any combination of letters, numbers or punctuation which forms a valid route number body.

7.2.216.3 Description

EXAMPLE 1, 25, 66, or 101.

7.2.217 Route Number On Sign

7.2.217.1 Definition

The route number expressed on a Traffic Sign as destination information. The Route Number On Sign is the ID-number of a particular route in a given road network as Attributed by a national, sub-national or international organization (e.g. the numbering of the departmental roads in France or the E-roads in Europe).

7.2.217.2 Domain/unit of measure

Any combination of characters, punctuation and/or numbers.

7.2.217.3 Description

A particular Destination can belong to more than one numbered route. In such cases a corresponding number of Route Number values can be recorded.

This Attribute is a Sub-Attribute which together with Destination Location and Exit Number forms the Composite Attribute Destination Info On Traffic Sign.

7.2.218 Route Type Prefix

7.2.218.1 Definition

A part of the route number of a Road Element, Ferry Element or Path identifying its route type. A prefix precedes the Route Number Body of a road.

7.2.218.2 Domain/unit of measure

Any combination of characters and punctuation which form a valid Route Type Prefix.

7.2.218.3 Description

Generally, the Route Type Prefixes which exist are dependent on the country in which the Road Element is located.

EXAMPLE 1 I, US, SR, RTE (USA).

EXAMPLE 2 E, A, M, B, R (Europe).

7.2.219 Route Type Suffix

7.2.219.1 Definition

A part of the route number of a Road Element, Ferry Element or Path identifying its route type. A suffix succeeds the Route Number Body of a road.

7.2.219.2 Domain/unit of measure

Any combination of letters and punctuation which forms a valid Route Type Suffix.

7.2.219.3 Description

The Route Type Suffixes which exist are dependent on the country in which the Road Element is located.

EXAMPLE Alt, Bus, Outer, or Inner (USA).

7.2.220 Routing Identifier

7.2.220.1 Definition

A unique alphanumeric identifier, ascribed to a special route, which may provide a key to an external database.

7.2.220.2 Domain/unit of measure

Any text.

7.2.220.3 Description

This Sub-Attribute is used in conjunction with the Sub-Attributes Routing Type and Routing Sequence Number. Together these form the Composite Attribute Special Routing.

7.2.221 Routing Sequence Number

7.2.221.1 Definition

The identification of the sequence number of a particular Road Element, Ferry Connection or Path within a special routing.

7.2.221.2 Domain/unit of measure

A positive numerical value.

7.2.221.3 Description

This Sub-Attribute is used in conjunction with the Sub-Attributes Routing Identifier and Routing Type. Together these form the Composite Attribute Special Routing.

7.2.222 Routing Type

7.2.222.1 Definition

The identification of the type of special routing to which a Road Element, Ferry Connection or Path belongs.

7.2.222.2 Domain/unit of measure

- Restricted Vehicle Route
- Dangerous Load Route
- Precautionary Salting Route
- Transcontinental Route
- Designated Truck Route
- Other Route

7.2.222.3 Description

7.2.222.3.1 Usage rules

This Sub-Attribute is used in conjunction with the Sub-Attributes Routing Identifier and Routing Sequence Number. Together these form the Composite Attribute Special Routing.

7.2.222.3.2 Definition of Restricted Vehicle Route

A pre-defined route with restrictions for the load, width or height of vehicles.

7.2.222.3.3 Definition of Dangerous Load Route

A pre-defined route selected for the transport of dangerous goods through an area.

7.2.222.3.4 Definition of Precautionary Salting Route

A route that is selected for precautionary salting for winter maintenance.

7.2.222.3.5 Definition of Transcontinental Route

A route that is part of a transcontinental route network, e.g. the Trans European Network.

7.2.222.3.6 Definition of Designated Truck Route

A route that is especially, but not exclusively, designated for the passage of trucks through, typically, an urban area.

7.2.222.3.7 Definition of Other Route

Any other special route that may be selected on an ad-hoc basis.

7.2.223 Sand Area Type

7.2.223.1 Definition

The type of Beach, Dune or Sand Plains.

7.2.223.2 Domain/unit of measure

- Beach/Dune
- Desert
- Other

7.2.224 Separator

7.2.224.1 Definition

A part of the route number which separates the Route Type Prefix and the Route Number Body.

7.2.224.2 Domain/unit of measure

A character which forms a valid separator.

7.2.224.3 Description

EXAMPLE “-” in I-280, or “ ” in SR 92.

7.2.225 Service Address

7.2.225.1 Definition

Address description of a street-related or block-related address of a Service.

7.2.225.2 Domain/unit of measure

Composite.

7.2.225.3 Sub-Attributes

This Composite Attribute can consist of the following Sub-Attributes:

- Place Name [.]..[.]
- Street Name
- House Number
- Building Storey
- Postal Code

NOTE [.]..[.] indicates that the Sub-Attribute can have multiple instances in the framework of the Composite Attribute.

7.2.226 Settlement Type

7.2.226.1 Definition

The type or character of a Built-up Area.

7.2.226.2 Domain/unit of measure

- Residential
- Recreational
- Industrial
- Military

7.2.226.3 Description

The Settlement Type should specify the main activity which takes place in the area inside the Built-up Area. Professional activities should in this respect be classified as industrial.

7.2.227 Scenic Value

7.2.227.1 Definition

This Attribute when True indicates whether a Road Element is regarded as scenic.

7.2.227.2 Domain/unit of measure

- True
- False

7.2.227.3 Description

Assignment of scenic values is subjective and can be based on a variety of sources.

7.2.228 Scope

7.2.228.1 Definition

The Attribute Scope indicates the validity of associated Attribute value semantics or Relationship semantics.

7.2.228.2 Domain/unit of measure

- Full
- Partial

7.2.229 Side of Line

7.2.229.1 Definition

The side of a Line Feature for which an Attribute applies.

7.2.229.2 Domain/unit of measure

- Left Side
- Right Side

7.2.229.3 Description

7.2.229.3.1 Usage rules

Any Property that can vary for the left or the right side of a Line Feature can be expressed as such by combining the Attribute expressing the Property with the Attribute Side of Line as Sub-Attributes in a Composite Attribute. When this is done the Attribute expressing the Property is only valid at the side as specified in the Side of Line Attribute.

When there are no side restrictions on the Property, the Side of Line Attribute shall not be included.

7.2.229.3.2 Indication of a particular side

The definition of left and right side should take place by applying the direction of the Line Feature as seen from the start bounding Point Feature.

7.2.230 Sign Text

7.2.230.1 Definition

The text on a sign post representing one logical element.

7.2.230.2 Domain/unit of measure

Any printable characters which form a valid sign text.

7.2.230.3 Description

Usually, Sign Posts contain different independent elements of logical information (e.g. different place names, names of recreation areas etc.). These have to be modelled as different instances of the Attribute Sign Text. Route Numbers and Exit Numbers shall not be represented by the Attribute Sign Text.

7.2.231 Slip Road Type

7.2.231.1 Definition

The type of Slip Road.

7.2.231.2 Domain/unit of measure

- Parallel Road
- Slip Road of a grade separated crossing
- Slip Road of a crossing at grade
- Other

7.2.231.3 Description

7.2.231.3.1 General

This Sub-Attribute is used to further specify the Slip Road which has been specified in the associated Sub-Attribute Form of Way. Together with the Sub-Attributes Enclosed Traffic Area and Freeway, they make up the Composite Attribute Composite Form Of Way.

See Figure 135, Figure 136, Figure 137, Figure 138 and Figure 139 for examples.

7.2.231.3.2 Definition of a Slip Road of a grade separated crossing

A Slip Road of a grade separated crossing represents a part of the road network which is used only to enter or leave a Road Element and will connect two or more roads which have a grade separated crossing.

7.2.231.3.3 Definition of a Slip Road of a crossing at grade

A Slip Road of a crossing at grade is a Slip Road of a single or multiple carriageway but never a Freeway which forms a single-level Intersection with another single or multiple carriageway which is not a Freeway.

7.2.231.3.4 Definition of a Parallel Road

A Parallel Road is a sub-type of a Slip Road which connects to the same road both at its start and at its end. In between its start and end it runs parallel or nearly parallel to the road it connects to and it only gives access to Slip Roads. A parallel road always will be open in only one direction for motorized traffic.

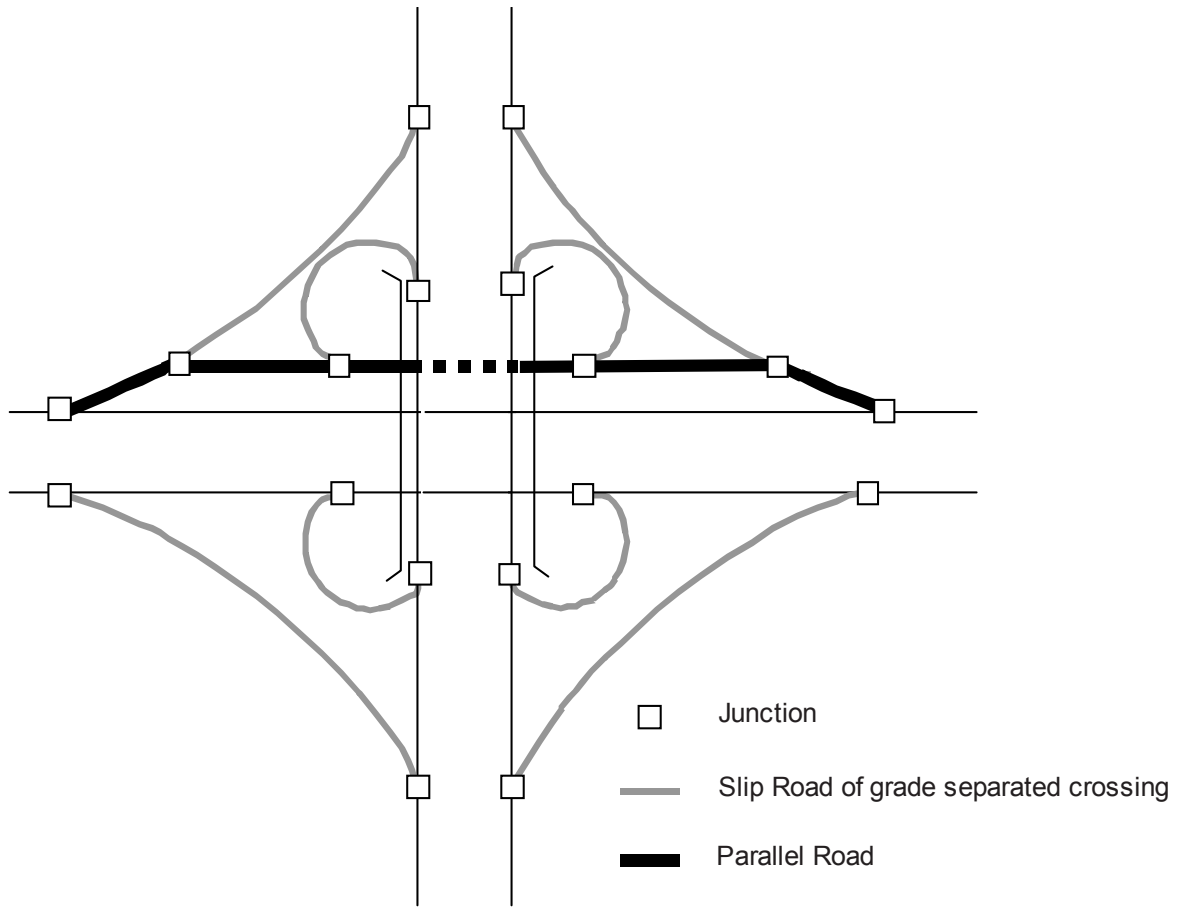

Figure 135 — Example of a Slip Road of type “Slip Road of a Grade Separated Crossing” and of type “Parallel Road”

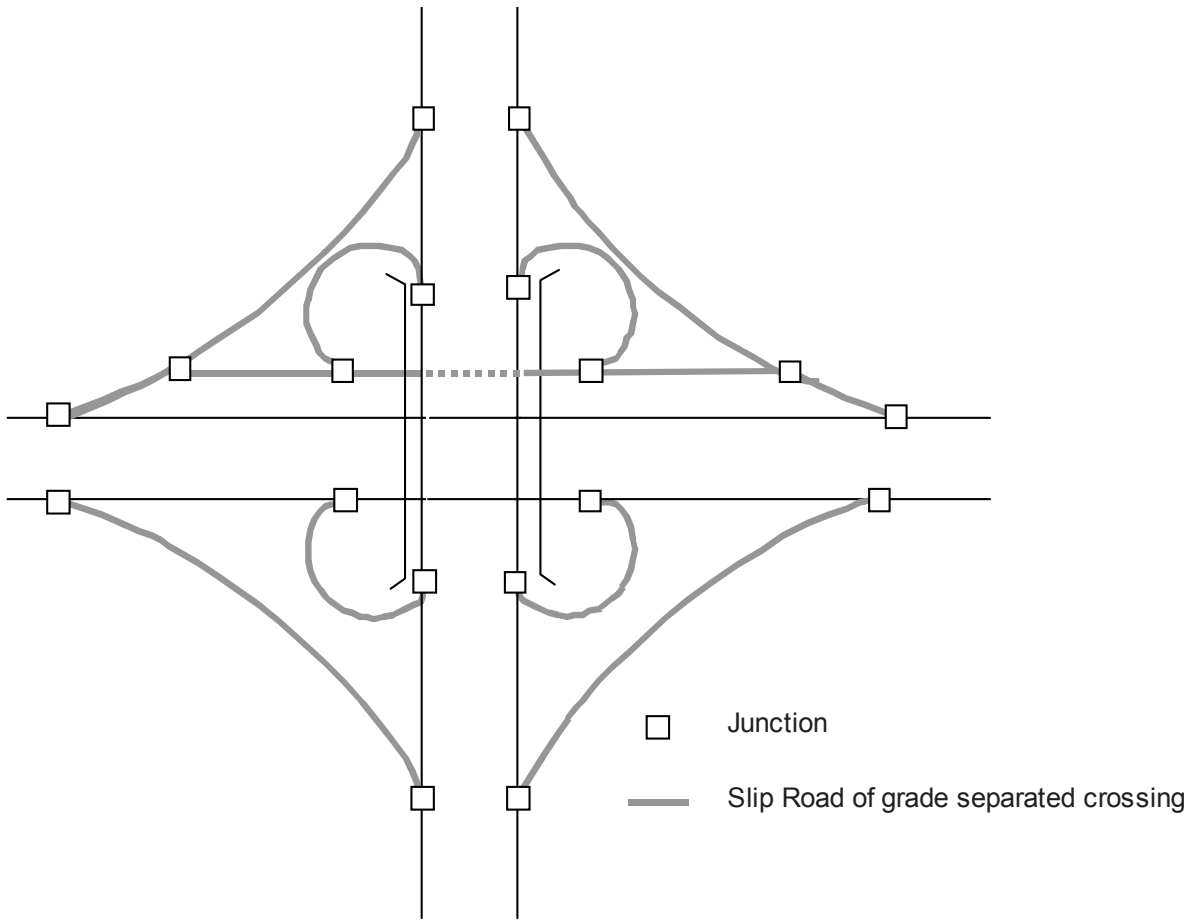

Figure 136 — Example of a Slip Road of type “Slip Road of a Grade Separated Crossing” when Parallel Road is not captured

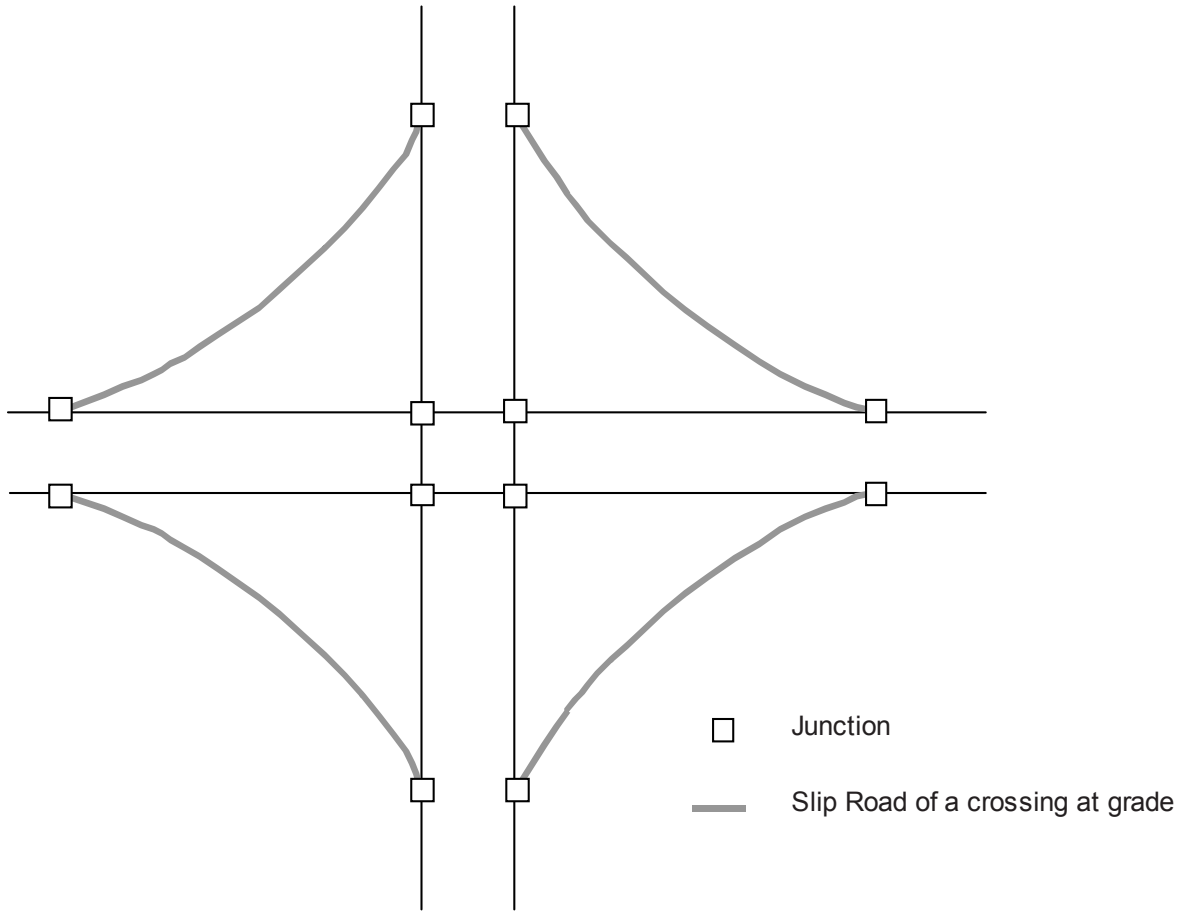

Figure 137 — Example of a Slip Road of type “Slip Road of a Crossing at Grade”

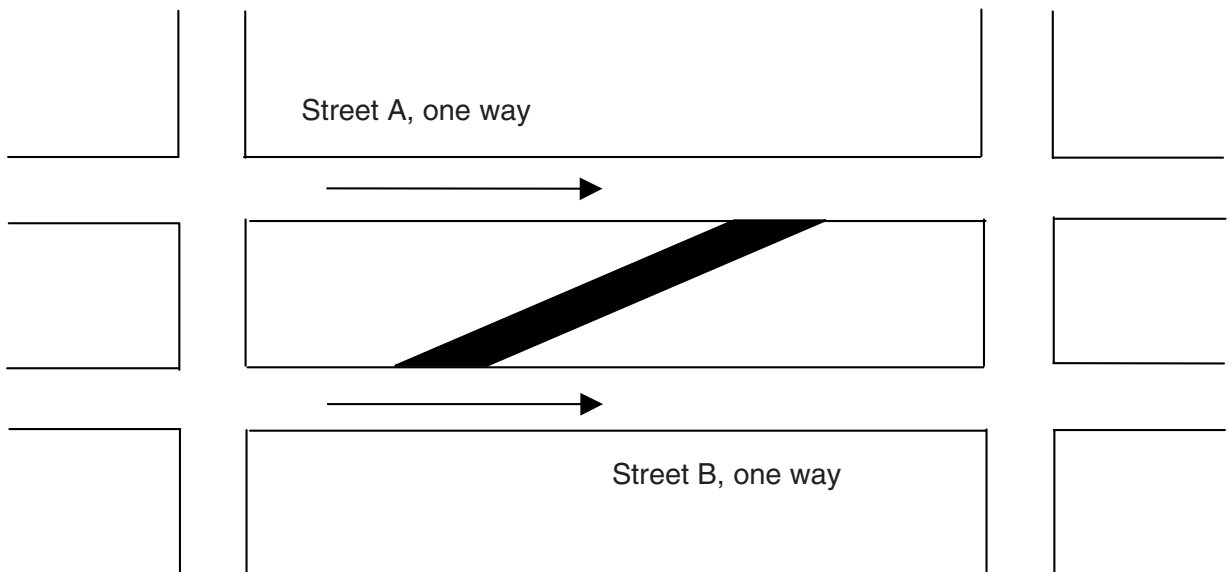

Figure 138 — Example of a Slip Road of type “Other”

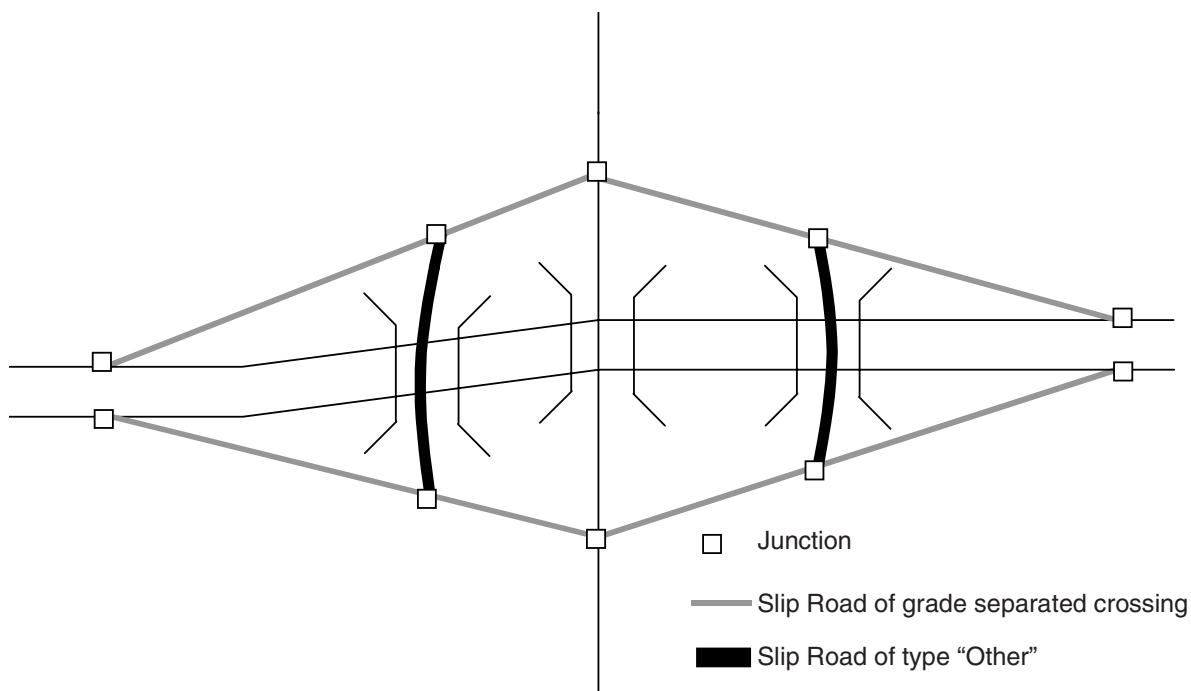

Figure 139 — Example of a Slip Road of type “Slip Road of Grade Separated Crossing” and of type “Other”

7.2.232 Slow Walker Limitation

7.2.232.1 Definition

This Attribute when True indicates accessibility limitation for people who walk slowly due to use of special devices such as walkers.

7.2.232.2 Domain/unit of measure

- True
- False

7.2.232.3 Description

Slow Walker limitation is a Sub-Attribute that limits access to road elements to people using walking assistance devices. Together with Hearing Limitation, Vision Limitation, and Wheelchair Limitation, it forms the Composite Attribute Accessibility Limitation.

Slow Walker Limitation can be restricted by the Restrictive Sub-Attribute Validity Period, which expresses temporality associated with accessibility limitations.

7.2.233 Snack Served

7.2.233.1 Definition

This Attribute when True indicates whether snacks or light refreshments are available.

7.2.233.2 Domain/unit of measure

- True
- False

7.2.234 Special Routing

7.2.234.1 Definition

Information about special routing along a sequence of Road Elements and/or Ferry Connections or along a sequence of Paths.

7.2.234.2 Domain/unit of measure

Composite.

7.2.234.3 Sub-Attributes

This Composite Attribute can consist of the following Sub-Attributes:

- Routing Identifier — Mandatory
- Routing Type — Mandatory
- Routing Sequence Number — Mandatory

7.2.235 Speed Restrictions

7.2.235.1 Definition

The maximum speed limit allocated to a Road Element.

7.2.235.2 Domain/unit of measure

7.2.235.2.1 Value domain

The value should be expressed in either Metric or English default units, or in user-defined units. Metric default unit is kilometre per hour; English default unit is mile per hour.

7.2.235.2.2 Measure

A measure of Speed Restrictions is composed of a value and a unit of measure.

7.2.235.2.3 Unit of measure

The unit of measure of Speed Restrictions is a Union of three: a Metric default unit, an English default unit, or a user-defined unit. User-defined units allow overriding of the default.

7.2.235.3 Description

This Attribute can be used in conjunction with the Sub-Attribute Vehicle Type, Validity Direction and Validity Period to indicate for which vehicles, driving direction and/or time period the restriction holds.

7.2.236 Spoken Language

7.2.236.1 Definition

A spoken language, or dialect within a spoken language.

7.2.236.2 Domain/unit of measure

An ISO 639-2 language code [1]

7.2.236.3 Description

The Attribute Spoken Language may be associated with Features, with name Attributes, or with name strings, i.e. with the actual values of name Attributes.

7.2.237 Start End Flag

7.2.237.1 Definition

Specification of a start or end designation.

7.2.237.2 Domain/unit of measure

- Start
- End

7.2.237.3 Description

This Attribute is used as a Sub-Attribute in conjunction with Distance Expression. Together these Sub-Attributes form the Composite Attribute Linear Position.

7.2.238 Street Lighted

7.2.238.1 Definition

This Attribute when True indicates street lighting present along a Road Element or Pathway.

7.2.238.2 Domain/unit of measure

- True
- False

7.2.239 Street Name

7.2.239.1 Definition

Name of the street which is part of the address description of a Service.

7.2.239.2 Domain/unit of measure

Any combination of letters, numbers or punctuation which forms a valid name.

7.2.239.3 Description

This Sub-Attribute is used in conjunction with the Sub-Attributes Place Name, Postal Code and House Number. Together they form the Composite Attribute Service Address.

7.2.240 Street Type Prefix

7.2.240.1 Definition

A part of the official street name or alternate street name of a Road Element or Address Area Boundary Element identifying the street type and including possible articles and prepositions. A prefix precedes the Official/Alternate Street Name Body of a road.

7.2.240.2 Domain/unit of measure

Any combination of characters and punctuation which form a valid Street Type Prefix.

7.2.240.3 Description

Generally, the Street Type Prefixes which exist are dependent on the country or the address system in which the Road Element is located in.

NOTE Street Type Prefixes in the USA are officially defined by the USPS (United States Postal Service).

EXAMPLE 1 "Rue de" in France, Belgium.

EXAMPLE 2 "Piazza della" in Italy.

EXAMPLE 3 "Plaza" in Spain.

This Attribute is used as a Sub-Attribute, possibly in conjunction with the Sub-Attributes Official/Alternate Street Name Body, Directional Prefix, Trailing Spaces, Street Type Suffix, Directional Suffix and Composite Pronunciation. Together these form the Composite Attribute Official/Alternate Street Name.

7.2.241 Street Type Suffix

7.2.241.1 Definition

A part of the official street name or alternate street name of a Road Element or Address Areas Boundary Element identifying the street type and including a possible leading blank (i.e. a space character) in the case when the Official/Alternate Street Name Body and the Street Type Suffix are separated by a blank. A Street Type Suffix succeeds the Official/Alternate Street Name Body of a road.

7.2.241.2 Domain/unit of measure

Any combination of letters and punctuation which forms a valid Street Type Suffix.

7.2.241.3 Description

Generally, the Street Type Suffixes which exist are dependent on the country or the address system in which the Road Element is located in.

NOTE Street Type Suffixes in the USA are officially defined by the USPS.

EXAMPLE 1 Seventh Avenue with Street Type Suffix Avenue.

EXAMPLE 2 Rozengracht with Street Type Suffix gracht.

EXAMPLE 3 Friedrichstraße with Street Type Suffix straÙe.

This Attribute is used as a Sub-Attribute, possibly in conjunction with the Sub-Attributes Official/Alternate Street Name Body, Directional Prefix, Street Type Prefix, Trailing Spaces, Directional Suffix and Composite Pronunciation. Together these form the Composite Attribute Official/Alternate Street Name.

7.2.242 Structure Abutment

7.2.242.1 Definition

Identifies constructive parts of a Structure directly alongside a Road Element.

7.2.242.2 Domain/unit of measure

- Structure abutment on the left of Road Element
- Structure abutment on the right of Road Element
- Structure abutment in the middle of the Road Element

7.2.242.3 Description

This Attribute identifies abutments, such as supporting pillars or the buttress of a bridge, located to the left, to the right of a Road Element and/or in the middle of the roadway, i.e. the road is split either side of the abutment.

In case abutments related to a structure correspond to more than one of the Attribute values, combinations (e.g. both left and right) can be represented by summing up the respective Attribute value codes into one (cumulated) value.

This Attribute should be used as a Sub-Attribute in conjunction with the Sub-Attribute Divider Width. Together they form the Composite Attribute Structure Abutment Info.

7.2.243 Structure Abutment Info

7.2.243.1 Definition

Describes constructive parts of a Structure directly alongside a Road Element.

7.2.243.2 Domain/unit of measure

Composite.

7.2.243.3 Sub-Attributes

This Composite Attribute can consist of the following Sub-Attributes:

- Structure Abutment - Mandatory
- Divider Width

7.2.243.4 Description

The Sub-Attribute Divider Width may be used in conjunction with the Structure Abutment value “Structure abutment in the middle of the Road Element”.

7.2.244 Structure Category

7.2.244.1 Definition

The category of traffic flow for a Structure.

7.2.244.2 Domain/unit of measure

- over
- under
- other

7.2.244.3 Description

This Attribute can be used as an Attribute of the Relationships Multi-Point Assignment, Exclusive Multi-Point Assignment, or Linear Assignment in order to specify whether the traffic flow is over or under the referenced Structure (or different from over or under).

7.2.245 Structure Identifier

7.2.245.1 Definition

A unique alphanumeric identifier, ascribed to a particular Structure Feature, which may provide a key to an external database.

7.2.245.2 Domain/unit of measure

As specified by the administrating body.

7.2.246 Structure Type

7.2.246.1 Definition

The classification of a Structure.

7.2.246.2 Domain/unit of measure

- Bridge
- Viaduct
- Aqueduct
- Tunnel
- Cutting
- Gallery
- Retaining wall
- Embankment

7.2.246.3 Description

7.2.246.3.1 General

The types are not mutually exclusive. (see Figure 140)

7.2.246.3.2 Definition of Bridge

A man-made construction to either carry a Transportation Element over another Feature or to span over a Transportation Element. In the case where one Transportation Element spans over another, the bridge represents a grade separated crossing.

7.2.246.3.3 Definition of Viaduct

A type of bridge, usually characterised by multiple spans. A viaduct often carries a Transportation Element elevated above ground level (such as a fly-over).

7.2.246.3.4 Definition of Aqueduct

A type of bridge, carrying a water Feature.

7.2.246.3.5 Definition of Tunnel

An enclosed man-made construction to carry a Transportation Element through or below a natural Feature or other obstructions.

7.2.246.3.6 Definition of Cutting

A non-enclosed, man-made excavation carrying a Transportation Element below the surrounding ground-level.

7.2.246.3.7 Definition of Embankment

A non-enclosed man-made earth construction carrying a Transportation Element above the surrounding ground-level.

7.2.246.3.8 Definition of Gallery

A man-made construction that covers a Transportation Element and is usually open on one side. Like a tunnel, it carries a Transportation Element through or under a natural Feature or obstruction.

7.2.246.3.9 Definition of Retaining wall

A man-made construction that either retains natural ground at a higher level than an associated Transportation Element or supports the Transportation Element at a higher level than the surrounding ground.

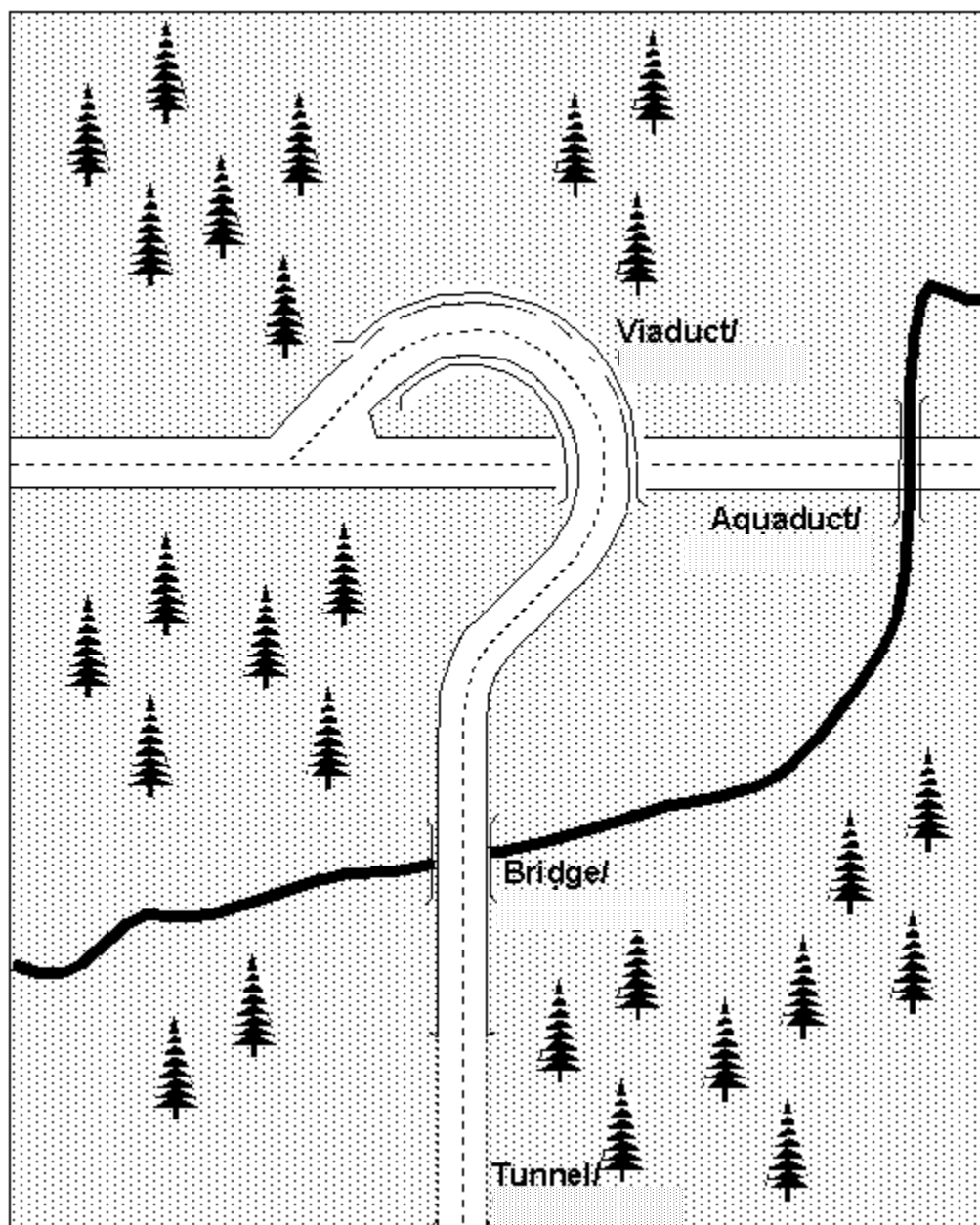

Figure 140 — Examples of different Structure Types

7.2.246.4 Relation between Structure Types and grade-separations

The Structure Types bridge, viaduct, tunnel, gallery and aqueduct can relate to:

- one Transportation Element (non grade separated, or the fact that a grade separation occurs is not relevant), or
- two Transportation Elements (grade separated).

Cutting, embankment and retaining wall do not relate to grade separation.

7.2.247 Suitable for Disabled or Challenged

7.2.247.1 Definition

This Attribute when True indicates whether the Service is suitable for a disabled person, such as people confined to a wheelchair, or otherwise physically challenged.

7.2.247.2 Domain/unit of measure

- True
- False

7.2.247.3 Description

Suitable for Disabled or Challenged is used in conjunction with the Sub-Attributes Accessibility Limitation and Infrastructure Accessibility Aids. Together they form the Composite Attribute Accessibility.

7.2.248 Summer Time

7.2.248.1 Definition

Summer Time identifies whether an area observes Summer Time and offsets clocks forward to achieve more daylight in the evening (this is Daylight Savings Time in the U.S.).

7.2.248.2 Domain/unit of measure

7.2.248.2.1 Value domain

The value should be expressed in either Metric or English default units, or in user-defined units. Metric default unit is minute; English default unit is minute.

7.2.248.2.2 Measure

A measure of Summer Time is composed of a value and a unit of measure.

7.2.248.2.3 Unit of measure

The unit of measure of Summer Time is a Union of three: a Metric default unit, an English default unit, or a user-defined unit. User-defined units allow overriding of the default.

7.2.248.3 Description

This Attribute is used with the validity period to describe when Summer Time is in effect. Typically this is applied to the highest administrative area level for which it applies, and then overridden when necessary by applying a different Summer Time value or Validity Period to a lower level area. For example, most of the United States observes Daylight Savings Time, but Arizona (and other places) does not. In this case the country Feature for the U.S. will receive a Summer Time value of 60 and the State Feature for Arizona will receive a Summer Time value of 0.

7.2.249 Symbol on Traffic Sign

7.2.249.1 Definition

A description of the symbol that occurs on the traffic sign.

7.2.249.2 Domain/unit of measure

- All traffic
- Motor cycle
- Private car
- Private car with trailer
- Heavy Goods Vehicle
- Heavy Goods Vehicle with trailer
- Bus
- Motor vehicle, having a maximum speed of 25 km/h
- Vehicle with explosive goods
- Vehicle with water-polluting goods
- Vehicle with other dangerous goods
- Tram
- Train
- Bicycle
- Moped
- Horse-drawn vehicle
- Rider
- Pedestrian
- Pedestrian with hand-drawn vehicle
- Speed

- Total weight
- Weight per axle
- Width
- Height
- Length

NOTE The values “Speed” to “Length” have to be followed by the Attribute Value on Traffic Sign.

7.2.249.3 Description

This Attribute is used as a Sub-Attribute for the Composite Attribute Traffic Sign Information. Its use is only meaningful if it is preceded by the Attribute Traffic Sign Class.

7.2.250 Telefax Number

7.2.250.1 Definition

The telefax number of the Service.

7.2.250.2 Domain/unit of measure

The number should be specified according to the following standard syntax:

+(country code)-(area code without leading zero)-local telefax number

EXAMPLE +(44)-(171)-1234567.

Any combination of letters, numbers or punctuation which forms a valid Telefax Number.

7.2.251 Telephone Number

7.2.251.1 Definition

The telephone number of the Service.

7.2.251.2 Domain/unit of measure

The number should be specified according to the same syntax as the telefax number. See 7.12.66.2.

Any combination of letters, numbers or punctuation which forms a valid Telephone Number.

7.2.252 Time Difference of Flight Connection

7.2.252.1 Definition

The difference in time between the destination and starting point of a flight connection.

7.2.252.2 Domain/unit of measure

The value shall be expressed as a single time duration according to the Time Domain syntax. For destinations in a time zone that is behind the time at the starting point, a negative time difference shall be represented by means of a negative time duration expression.

7.2.252.3 Description

This Attribute can be used as a Sub-Attribute of the Composite Attribute Flight Info.

7.2.253 Time of Arrival of Flight Connection

7.2.253.1 Definition

The arrival time at the Destination of Flight Connection of a flight connection.

7.2.253.2 Domain/unit of measure

Any point in time expressed as a single starting date according to the “Syntax for Time Domain” rules.

7.2.253.3 Description

This Attribute can be used as a Sub-Attribute of the Composite Attribute Flight Info.

7.2.254 Time of Departure of Flight Connection

7.2.254.1 Definition

The departure time for a flight connection.

7.2.254.2 Domain/unit of measure

Any point in time expressed as a single starting date according to the “Syntax for Time Domain” rules.

7.2.254.3 Description

This Attribute can be used as a Sub-Attribute of the Composite Attribute Flight Info.

7.2.255 Time Zone

7.2.255.1 Definition

Time Zone identifies the difference between local time offset from GMT for an area.

7.2.255.2 Domain/unit of measure

A number between -12.00 and +12.00, where the number before the decimal point represents the hours offset from GMT and the number after the decimal point represents the number of additional minutes offset from GMT.

EXAMPLE 1 Chicago is -6.00 from GMT.

EXAMPLE 2 Netherlands is +1.00 from GMT.

7.2.255.3 Description

The Time Zone is typically applied at the highest area level that the time zone covers, and overridden at a lower level area when necessary. For example, since the U.S. crosses many time zones, the state level will generally be the highest level for applying this information. The state of Indiana crosses the Central and Eastern Time zones. The state of Indiana can receive the time zone of -5.00 since the majority of the state is in the Eastern Time zone. For the administrative areas in the Central Time zone, the time zone of -6.00 can be applied at the next lower administrative level (county). The time represents standard time, not summer time. Summer time is addressed with the Summer Time Attribute

7.2.256 Toll

7.2.256.1 Definition

Fee to be paid in a certain currency to travel on (a section of) a toll road.

7.2.256.2 Domain/unit of measure

Composite.

7.2.256.3 Sub-Attributes

- Toll Charge — Mandatory
- Currency

7.2.256.4 Description

This Attribute is usable in conjunction with the Relationship Toll Route.

7.2.257 Toll Charge

7.2.257.1 Definition

Fee to be paid to travel on (a section of) a toll road.

7.2.257.2 Domain/unit of measure

Amount specified in the smallest unit of a certain currency which is accepted by the associated user defined Feature Toll Location.

7.2.257.3 Description

This Sub-Attribute is to be used in combination with the Sub-Attribute Currency to specify a certain Toll to be paid.

7.2.258 Toll Point Type

7.2.258.1 Definition

The type of Toll Point.

7.2.258.2 Domain/unit of measure

- Physical Toll Booth
- Virtual Toll Booth
- Hybrid

7.2.258.3 Description

7.2.258.3.1 Definition of a Physical Toll Booth

A Toll Booth is a construction along or across the road where toll can be paid to employees of the organization in charge of collecting the toll, to machines capable of automatically recognizing coins or bills or to machines involving electronic methods of payment like credit cards or bank cards.

7.2.258.3.2 Definition of a Virtual Toll Booth

At a virtual point of toll payment, toll will be charged via automatic registration of the passing vehicle by subscription or invoice.

7.2.258.3.3 Definition of Hybrid

Hybrid signifies a Toll Booth which is both Physical and Virtual.

7.2.259 Toll Road

7.2.259.1 Definition

This Attribute when True indicates whether travelling a Road Element requires payment of toll.

7.2.259.2 Domain/unit of measure

- True
- False

7.2.260 Traffic Flow

7.2.260.1 Definition

Information about the traffic flow on Road Elements or Path.

7.2.260.2 Domain/unit of measure

Composite.

7.2.260.3 Sub-Attributes

This Composite Attribute can consist of the following Sub-Attributes:

- Traffic Flow Measurement — Mandatory
- Traffic Flow Measurement Type — Mandatory
- Traffic Flow Measurement Unit — Mandatory
- Percentage of International Traffic

7.2.261 Traffic Flow Measurement

7.2.261.1 Definition

The traffic flow on Road Elements or Path, expressed for instance by number of vehicles per day.

7.2.261.2 Domain/unit of measure

A positive numerical value.

7.2.261.3 Description

The value shall be expressed in the unit specified by the Sub-Attribute Traffic Flow Measurement Unit.

This Sub-Attribute is used in conjunction with the Sub-Attributes Traffic Flow Measurement Type, Traffic Flow Measurement Unit and Percentage of International Traffic.

7.2.262 Traffic Flow Measurement Type

7.2.262.1 Definition

Classification of traffic flow measurement on Road Elements or Path.

7.2.262.2 Domain/unit of measure

- Average Traffic
- Average Flow during Peak Periods
- Maximum Flow

7.2.262.3 Description

This Sub-Attribute is used in conjunction with the Sub-Attributes Traffic Flow Measurement, Traffic Flow Measurement Unit and Percentage of International Traffic.

7.2.263 Traffic Flow Measurement Unit

7.2.263.1 Definition

Time unit over which the traffic flow measurement is recorded.

7.2.263.2 Domain/unit of measure

The value shall be specified by a single time duration expressed according to the Time Domain syntax.

7.2.263.3 Description

This Sub-Attribute is used in conjunction with the Sub-Attributes Traffic Flow Measurement, Traffic Flow Measurement Type and Percentage of International Traffic.

7.2.264 Traffic Jam Sensitivity

7.2.264.1 Definition

Probability of a traffic jam on a Road Element.

7.2.264.2 Domain/unit of measure

- No or low probability
- High probability

7.2.265 Traffic Light Info

7.2.265.1 Definition

The Traffic Light Info specifies the driving direction to which a number of special traffic lights apply and where these signalling units are positioned relative to the road

7.2.265.2 Domain/unit of measure

Composite

7.2.265.3 Sub-Attributes

This Composite Attribute can consist of the following Sub-Attributes:

- Direction Category
- Road Furniture Position

7.2.266 Traffic Sign Class

7.2.266.1 Definition

The classification of the traffic sign.

7.2.266.2 Domain/unit of measure

Traffic signs are classified in the following 9 different categories:

- Right of Way
- Directional
- Right of Passage
- Signpost
- Route prohibition
- Stopping prohibition
- Warning sign
- Directional Sign
- Variable Speed Sign

Figure 141 provides graphical examples of the first four categories.



Figure 141 — Traffic Signs according to Traffic Sign Class

7.2.266.3 Description

This Attribute is used as a Sub-Attribute for the Composite Attribute Traffic Sign Information.

7.2.267 Traffic Sign Information

7.2.267.1 Definition

A description of the information contained in a traffic sign. The information should comprise the information contained in the traffic sign itself, as well as supplementary information present on e.g. additional text plates.

7.2.267.2 Domain/unit of measure

Composite.

7.2.267.3 Sub-Attributes

- Traffic Sign Class — Mandatory
- Symbol on Traffic Sign [..[]
- Direction [..[]
- Value on Traffic Sign [..[]
- Exit Number [..[]
- Destination Info on Traffic Sign [..[]
- Other Textual Content of Traffic Sign [..[]

NOTE [..[] indicates that the Sub-Attribute can have multiple instances in the framework of the Composite Attribute.

7.2.268 Trailing Spaces

7.2.268.1 Definition

An indication of the presence of a space character between the Official /Alternate Street Name Body and the preceding or succeeding part.

7.2.268.2 Domain/unit of measure

- None
- Between preceding part and Official /Alternate Street Name Body.
- Between Official /Alternate Street Name Body and succeeding part.
- Between preceding part and the Official /Alternate Street Name Body and between the Official /Alternate Street Name Body and the succeeding part.

7.2.268.3 Description

In case in the Official or Alternate Street Name, the Official /Alternate Street Name Body and the Street Type Prefix or the Street Type Suffix are divided by a space, this should be indicated by the Sub-Attribute Trailing Spaces.

This Attribute is used as a Sub-Attribute, possibly in conjunction with the Sub-Attributes Alternate or Official Street Name Body, Directional Prefix, Street Type Prefix, Street Type Suffix, Directional Suffix and Composite Pronunciation. Together these form the Composite Attribute Alternate or Official Street Name.

7.2.269 Transcription Description

7.2.269.1 Definition

Description of the phonetic transcription to aid in understanding.

7.2.269.2 Domain/unit of measure

Any text.

7.2.269.3 Description

This Attribute is used as a Sub-Attribute in conjunction with the Sub-Attributes Pronunciation, Pronunciation System, and Phonetic Alphabet. Together these Sub-Attributes form the Composite Attribute Composite Pronunciation.

Alternatively, this Attribute is used as a Sub-Attribute in conjunction with the Sub-Attributes Alternate Pronunciation, Pronunciation Variant, Phonetic Alphabet, and Pronunciation Language. Together these Sub-Attributes form the Composite Attribute Composite Alternate Pronunciation.

7.2.270 Transition

7.2.270.1 Definition

Identifies a Road Element whose existence in the Roads and Ferries network serves to topologically connect road centre geometry without reflecting centreline characteristics.

7.2.270.2 Domain/unit of measure

- Regular geometry
- Transitional geometry

7.2.270.3 Description

Generally, Road Elements are modelled to reflect linear road objects. Road Elements also imply network connectivity through topological connections to other Road Elements (via Junctions). In some situations Road Elements exist in the network only to connect other Road Elements without corresponding to linear characteristics present in the real world. See Figure 142 and Figure 143 for examples. Such special Road Elements play the role of representing the transition (i.e. topological network connection) between sections of regular geometry.

This Attribute gives the possibility of identifying such special Road Elements.

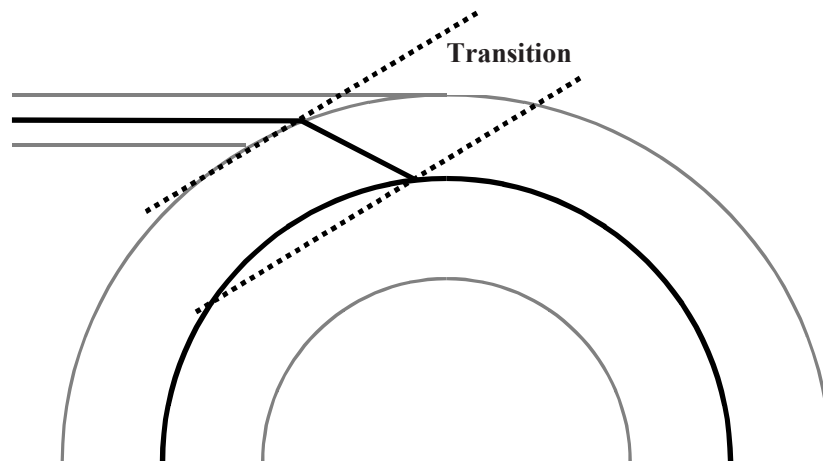

Figure 142 – Schematic example of road centreline transition at a curve/roundabout circle

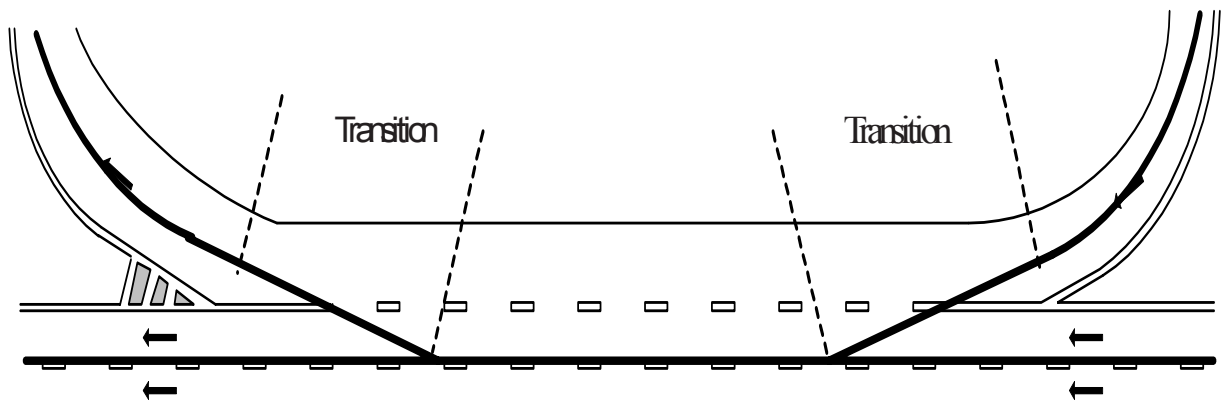

Figure 143 – Schematic example of road centreline transition at an entry/exit lane

7.2.271 Travel Time

7.2.271.1 Definition

The one-way travel time that a Ferry Connection or a Public Transport Connection takes to traverse along the connection.

7.2.271.2 Domain/unit of measure

The value shall be expressed as a single time duration using Time Domain Syntax.

7.2.271.3 Description

The travel time shall represent the average duration of a trip by the transport mode in question.

7.2.272 Type of Public Transport Point

7.2.272.1 Definition

The functional significance of a Public Transport Point.

7.2.272.2 Domain/unit of measure

- Timing Point
- Traffic Control Point
- Activation Point
- Turn Station
- Break Facility
- Parking Point
- Relief Point

7.2.273 Underground Flag

7.2.273.1 Definition

Indication whether a (Schematic) Building or Railway Line, or a Stop Point or Route Link, is aboveground or underground.

7.2.273.2 Domain/unit of measure

- Aboveground
- Underground

7.2.274 Unpaved Road Surface Type

7.2.274.1 Definition

The Type of surface an unpaved Road Element has.

7.2.274.2 Domain/unit of measure

- Gravel
- Dirt

7.2.274.3 Description

Dirt roads are those roads whose surface is formed by the removal of vegetation and/or by the transportation movements over that road which inhibit further growth of any vegetation. Gravel roads are dirt roads whose surface has been improved by grading with gravel.

This Attribute is a Sub-Attribute which together with the Sub-Attributes Pavement Status, Paved Road Surface Type and Road Surface Condition forms the Composite Attribute Road Surface.

7.2.275 Upper Building Elevation

7.2.275.1 Definition

The upper elevation of a Building above ground.

7.2.275.2 Domain/unit of measure

7.2.275.2.1 Value domain

The value shall be expressed in either Metric or English default units, or in user-defined units. Metric default unit is metre; English default unit is foot.

7.2.275.2.2 Measure

A measure of Upper Building Elevation is composed of a value and a unit of measure.

7.2.275.2.3 Unit of measure

The unit of measure of Upper Building Elevation is a Union of three: a Metric default unit, an English default unit, or a user-defined unit. User-defined units allow overriding of the default.

7.2.275.3 Description

The Attribute Upper Building Elevation is used in conjunction with the Sub-Attribute Lower Building Elevation. Together they make up the Composite Attribute Complex Building Elevation.

7.2.276 Urban Railway Station

7.2.276.1 Definition

This Attribute when True indicates a facility established to provide rail transportation within an urban area.

7.2.276.2 Domain/unit of measure

- True
- False

7.2.277 Validity Direction

7.2.277.1 Definition

The direction sense of a (Sub-)Attribute associated with a Line Feature, or a Relationship involving a Line Feature, defined relative to the given Line Feature's positive direction.

7.2.277.2 Domain/unit of measure

- Same direction
- Opposite direction

7.2.277.3 Description

The Validity Direction Attribute can serve in two ways, either by restricting the validity of an associated (Sub-)Attribute to a single direction, or by setting the direction sense for associating Attribute and/or Relationship properties with a Line Feature.

This Attribute may be used as a Sub-Attribute in conjunction with Correspondence Order. Together these Sub-Attributes form the Composite Attribute Correspondence.

7.2.278 Validity Period

7.2.278.1 Definition

The period, for which a value defined in an associated Sub-Attribute or Relationship is valid.

7.2.278.2 Domain/unit of measure

The value of the Attribute Validity Period shall be constructed as a combination of both starting date(s) and time duration(s) according to the Syntax for Time Domain rules.

7.2.278.3 Description

Any Property that has a variable character over time can be expressed as such by combining the Attribute expressing the Property with the Attribute Validity Period as Sub-Attributes in a Composite Attribute. When this is done the Attribute expressing the Property is only valid in the period as specified in the Validity Period Attribute.

When there are no time restrictions on the Property, the Validity Period Attribute shall be left out or its value shall be left blank.

7.2.279 Value on Referent

7.2.279.1 Definition

The (alpha-)numeric value that is painted on the marker that physically represents a Referent.

7.2.279.2 Domain/unit of measure

As specified by the administrating body.

7.2.279.3 Description

The values depicted on reference markers are typically miles or kilometres, with possibly one digit behind the decimal point (e.g. 50.7).

7.2.280 Value on Traffic Sign

7.2.280.1 Definition

A value mentioned on a traffic sign.

7.2.280.2 Domain/unit of measure

7.2.280.2.1 Value domain

The value can be any user defined integer value.

7.2.280.2.2 Measure

A measure of Value on Traffic Sign is composed of a user defined unit of measure.

7.2.280.2.3 Unit of measure

The unit of measure of Value on Traffic Sign is composed of a base unit (metre, minute, kilogram, kilometre per hour, or degree), and a conversion (scaling) factor.

7.2.280.3 Description

This Attribute is used as a Sub-Attribute for the Composite Attribute Traffic Sign Information. It is used in conjunction with Symbol On Traffic Sign and stores the numeric value associated with given traffic signs.

7.2.281 Vehicle Type

7.2.281.1 Definition

The type of vehicle for which the information contained in an associated Sub-Attribute or Relationship holds.

7.2.281.2 Domain/unit of measure

- All Vehicles
- Passenger Cars
- Delivery Truck
- Transport Truck
- Pedestrian
- Bicycle
- Motorcycle
- Moped
- Emergency Vehicle
- Taxi
- Public Bus
- Facility Vehicle
- Residential
- Employee vehicle
- High Occupancy Vehicle
- Military Vehicle
- Car with Trailer
- Private Bus
- Farm Vehicle
- Vehicles with an explosive load
- Vehicles with a water-polluting load
- Vehicles with other dangerous loads
- Trolley Bus
- Light Rail
- School Bus
- 4 Wheel Drive Vehicle
- Vehicle carrying snow chains
- Mail Vehicle

- Tanker
- Vehicle for disabled persons
- Snowmobile
- User-Defined

7.2.281.3 Description

7.2.281.3.1 Usage rules

This Restrictive Sub-Attribute should be used if the restriction to Vehicle Type is indicated through traffic signs. The negative value of a vehicle would have the semantic of negation, i.e. everything except that vehicle.

7.2.281.3.2 Definition of 4 Wheel Drive Vehicle

Vehicle that is capable of transferring power to all wheels.

7.2.281.3.3 Definition of All Vehicles

Any vehicle, not including Pedestrians.

7.2.281.3.4 Definition of an Employee Vehicle

A vehicle operated by an employee of an organization that is used within that organization's grounds.

7.2.281.3.5 Definition of Bicycle

Pedal-driven two-wheeled vehicle.

7.2.281.3.6 Definition of Car with Trailer

A passenger car with an attached trailer.

7.2.281.3.7 Definition of Delivery Truck

A truck vehicle of relatively small size, whose principal use is for delivery of good and materials.

7.2.281.3.8 Definition of Emergency Vehicle

A vehicle engaged in emergency response, included but not limited to police, ambulance and fire.

7.2.281.3.9 Definition of Facility Vehicle

A vehicle dedicated to a localized area within a private or restricted estate.

EXAMPLE Facilities roads within an airport or theme park.

7.2.281.3.10 Definition of Farm Vehicle

Vehicle commonly associated with Farming Activities.

7.2.281.3.11 Definition of High Occupancy Vehicle

Vehicle populated with a number of occupants corresponding to (or exceeding) the specified minimum number of passengers.

7.2.281.3.12 Definition of Light Rail

Train-like transport vehicle limited to a rail network within a limited area; does not include heavy rail lines.

7.2.281.3.13 Definition of Mail Vehicle

A vehicle that collects, carries or delivers mail.

7.2.281.3.14 Definition of Military Vehicle

Vehicle authorized by a Military Authority.

7.2.281.3.15 Definition of Moped

Low powered two-wheeled motor vehicle with pedals.

7.2.281.3.16 Definition of Motorcycle

High powered two-wheeled motor vehicle without pedal propulsion.

7.2.281.3.17 Definition of Passenger Car

A small vehicle designed for private transport of people.

7.2.281.3.18 Definition of Pedestrian

A person on foot.

7.2.281.3.19 Definition of Private Bus

A vehicle designed for transport of large groups of people, privately owned or chartered.

7.2.281.3.20 Definition of Public Bus

A vehicle designed for transport of large groups of people that is generally characterized by published routes and schedules.

7.2.281.3.21 Definition of Residential Vehicle

A vehicle whose owner is resident (or a guest) of particular street or town area.

7.2.281.3.22 Definition of Snowmobile

A motorised vehicle designed for transportation on snow and ice surface.

7.2.281.3.23 Definition of School Bus

Vehicle operated on behalf of a school to transport students.

7.2.281.3.24 Definition of Tanker

A truck with more than two axles used to transport liquid loads in bulk.

7.2.281.3.25 Definition of Taxi

A vehicle licensed for hire usually fitted with a meter.

7.2.281.3.26 Definition of Transport Truck

A truck vehicle for long range transport of goods.

7.2.281.3.27 Definition of Trolley Bus

A Bus-like mass transport vehicle hooked up to an electrical network for power supply.

7.2.281.3.28 Definition of User-Defined

A vehicle of a user-defined type.

7.2.281.3.29 Definition of Vehicle carrying snow chains

Vehicle equipped with snow chains.

7.2.281.3.30 Definition of Vehicle for disabled persons

A vehicle with supporting identification that designates a vehicle for disabled persons.

7.2.281.3.31 Definition of Vehicles with a water-polluting load

Vehicle transporting water-polluting cargo.

7.2.281.3.32 Definition of Vehicles with an explosive load

Vehicle transporting explosive cargo.

7.2.281.3.33 Definition of Vehicles with other dangerous loads

Vehicle transporting dangerous cargo, other than explosive or water-polluting loads.

7.2.282 Vision Limitation

7.2.282.1 Definition

This Attribute when True indicates accessibility limitation due to a limitation of vision.

7.2.282.2 Domain/unit of measure

- True
- False

7.2.282.3 Description

Vision limitation is a Sub-Attribute that limits access to road elements to people with vision limitations. Together with Slow Walker Limitation, Hearing Limitation, and Wheelchair Limitation, it forms the Composite Attribute Accessibility Limitation.

Vision Limitation can be restricted by the Restrictive Sub-Attribute Validity Period, which expresses temporality associated with accessibility limitations.

7.2.283 Water Boundary Element Type

7.2.283.1 Definition

The type of Water Boundary Element.

7.2.283.2 Domain/unit of measure

- Ocean or Sea shore line
- Bay side
- Lake shore line
- River side
- Canal side
- Wetland side
- Harbour side
- Water side of Pier or Dock
- Others

7.2.283.3 Description

7.2.283.3.1 Definition of a Shore line

That part of the land in immediate contact with a water body including the areas between high and low water lines.

7.2.283.3.2 Definition of a Pier or Dock

A Pier or Dock is a structure built out into the water to serve as a landing place for ships.

For definitions of other water bodies bounded by Water Boundary Elements of the types mentioned, see 6.8.12.

7.2.283.3.3 Combination rules

The types of Water Boundary Element Type are not mutually excluding. In case of conflicts the following hierarchical order should be applied, in which a higher order type always will be applied instead of a lower order type:

Highest order

- Water side of Pier or Dock
- Harbour side
- River or Canal side

Lowest Order

- Ocean or Sea shore line

7.2.284 Water Body Type

7.2.284.1 Definition

The type of Water Body.

7.2.284.2 Domain/unit of measure

- Harbour/Port
- Marina
- Bay
- Unspecified

7.2.284.3 Description

7.2.284.3.1 Definition of Harbour/Port

An area for mooring, loading and unloading commercial ships.

7.2.284.3.2 Definition of Marina

An area with docking and service facility for pleasure craft.

7.2.284.3.3 Definition of a Bay

An area largely yet not entirely surrounded by land and open to a larger Water Body.

7.2.285 Wheelchair Limitation

7.2.285.1 Definition

This Attribute when True indicates accessibility limitation for use of wheelchairs.

7.2.285.2 Domain/unit of measure

- True
- False

7.2.285.3 Description

Wheelchair limitation is a Sub-Attribute that limits access to road elements to people using wheelchairs. Together with Slow Walker Limitation, Vision Limitation, and Hearing Limitation, it forms the Composite Attribute Accessibility Limitation.

Wheelchair Limitation can be restricted by the Restrictive Sub-Attribute Validity Period, which expresses temporality associated with accessibility limitations.

7.2.286 Width

7.2.286.1 Definition

The width of a Road Element or Path, a lane or a Road Furniture or Structure Feature.

7.2.286.2 Domain/unit of measure

7.2.286.2.1 Value domain

The value should be expressed in either Metric or English default units, or in user-defined units. Metric default unit is centimetre; English default unit is inch.

7.2.286.2.2 Measure

A measure of Width is composed of a value and a unit of measure.

7.2.286.2.3 Unit of measure

The unit of measure of Width is a Union of three: a Metric default unit, an English default unit, or a user-defined unit. User-defined units allow overriding of the default.

7.2.286.3 Description

If this Attribute is used to specify the width of a Road Element it should be attached as a normal Attribute to a Road Element or Path. If the width of a lane is specified, it should be attached to a Road Element using the Composite Attribute Lane Info (within which Width is treated as a Sub-Attribute).

8 Relationship Catalogue

8.1 Generic Specifications

8.1.1 Features and their Relationships

Some information related to real world objects needs to be modelled in the form of a Relationship between Features.

EXAMPLE “*Is Capital of*” is the Relationship between “*Paris*” and “*France*”.

This clause documents the Relationships included in GDF.

The Conceptual Data Models for the Relationship Catalogue are given in Figure 144, Figure 145, Figure 146, Figure 147, Figure 148, Figure 149, Figure 150, Figure 151, Figure 152, Figure 153, Figure 154, Figure 155, Figure 156, Figure 157, Figure 158, Figure 159, Figure 160, Figure 161, Figure 162, Figure 163, Figure 164, Figure 165, Figure 166, Figure 167, Figure 168, Figure 169, Figure 170, Figure 171, Figure 172, Figure 173, Figure 174 and Figure 175.

The Conceptual Data Models comprise applicable Attribute types per Relationship Type, detailing the Attribute usage provided in 7.1.18 for the Relationship Catalogue as a whole. For information, signalisation of extended Attribute usage is provided by using a plus (+), going beyond the Attribute scope depicted in the respective conceptual data models.

All Relationships are referenced by a particular Relationship name. These names are written with initial capitals in order to distinguish them from the daily life common usage terms from which they have been derived (e.g.: “*Service along Road Element*” versus “*service along road element*”).

A Feature may be involved in more than one Relationship. Two different Relationships may relate identical Feature instances as with the Relationships “*is seat of government of*” and “*is capital of*” to the Feature instances “*Paris*” and “*France*”.

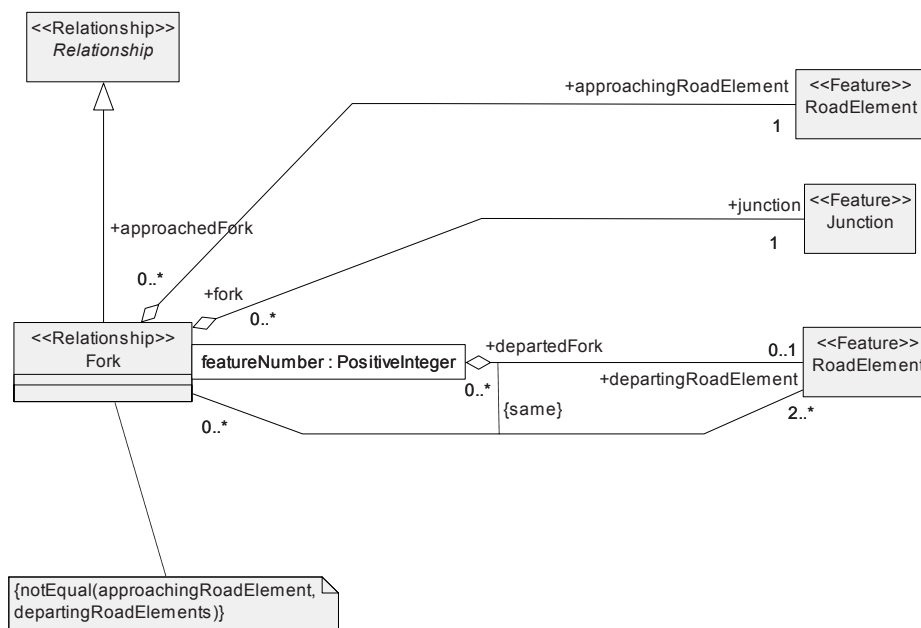

Figure 144 — The Conceptual Data Model for the Fork Relationship

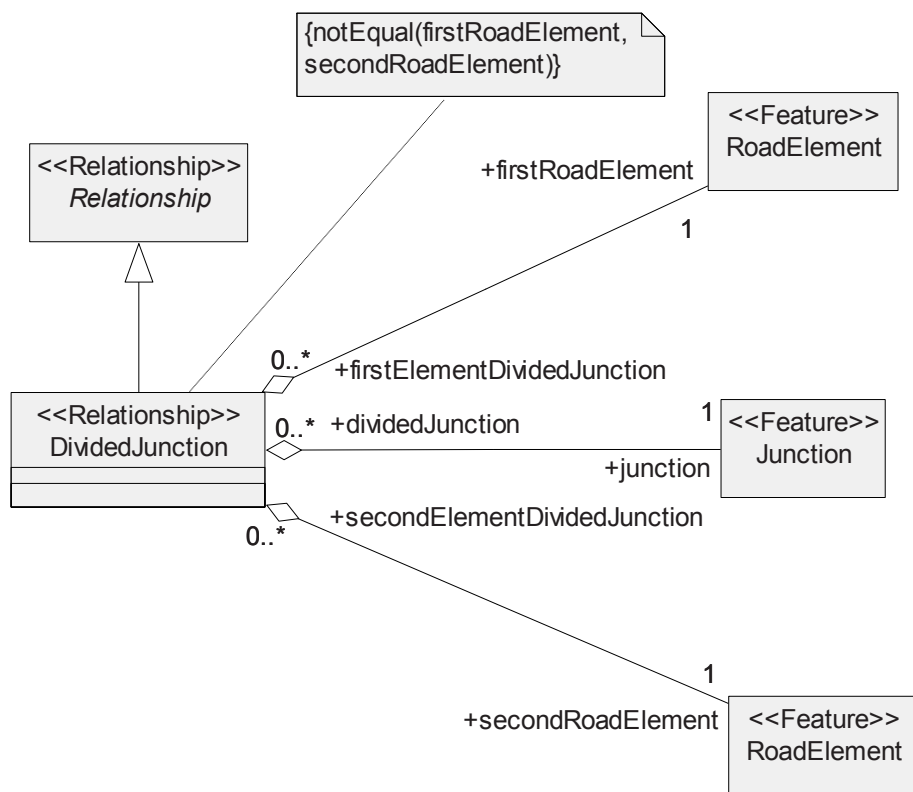

Figure 147 — The Conceptual Data Model for the Divided Junction Relationships

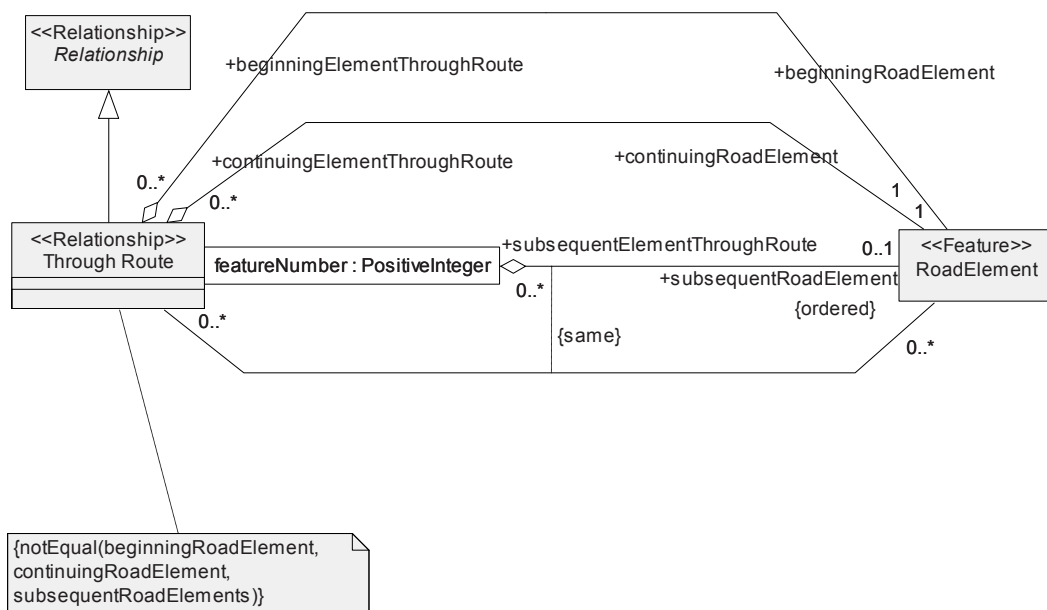

Figure 148 — The Conceptual Data Model for the Through Route Relationship

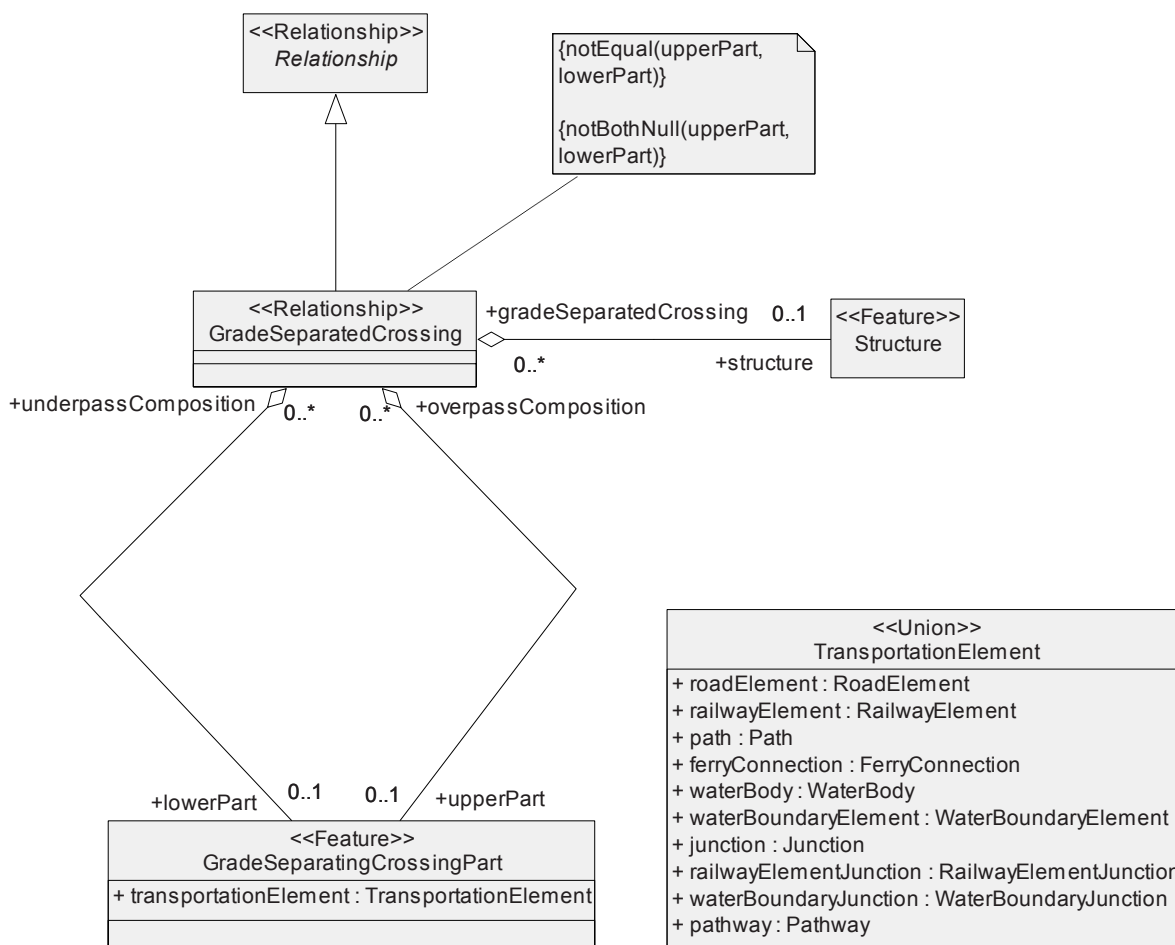

Figure 149 — The Conceptual Data Model for the Grade-separated Crossing Relationship

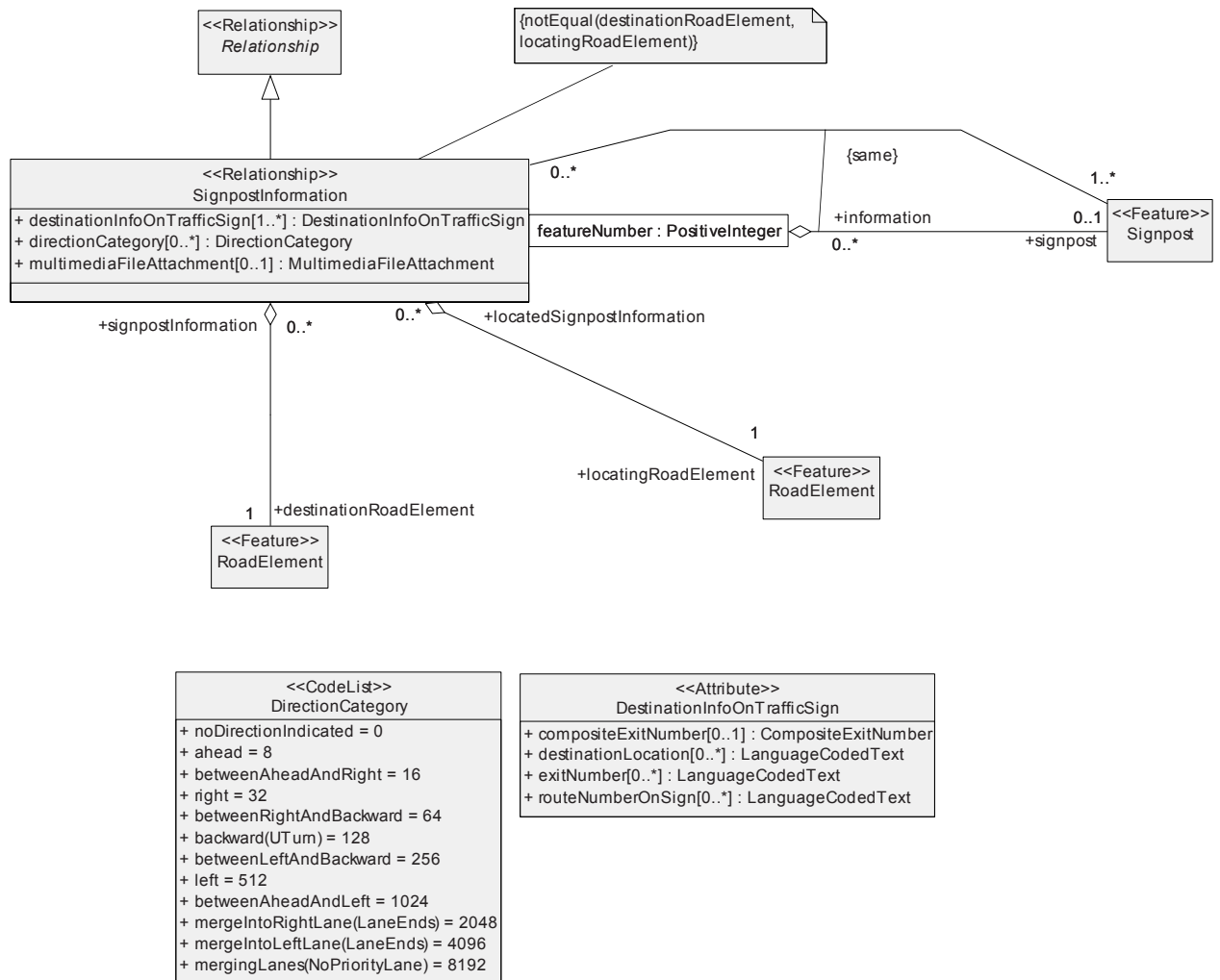

Figure 150 — The Conceptual Data Model for the Signpost Information Relationship

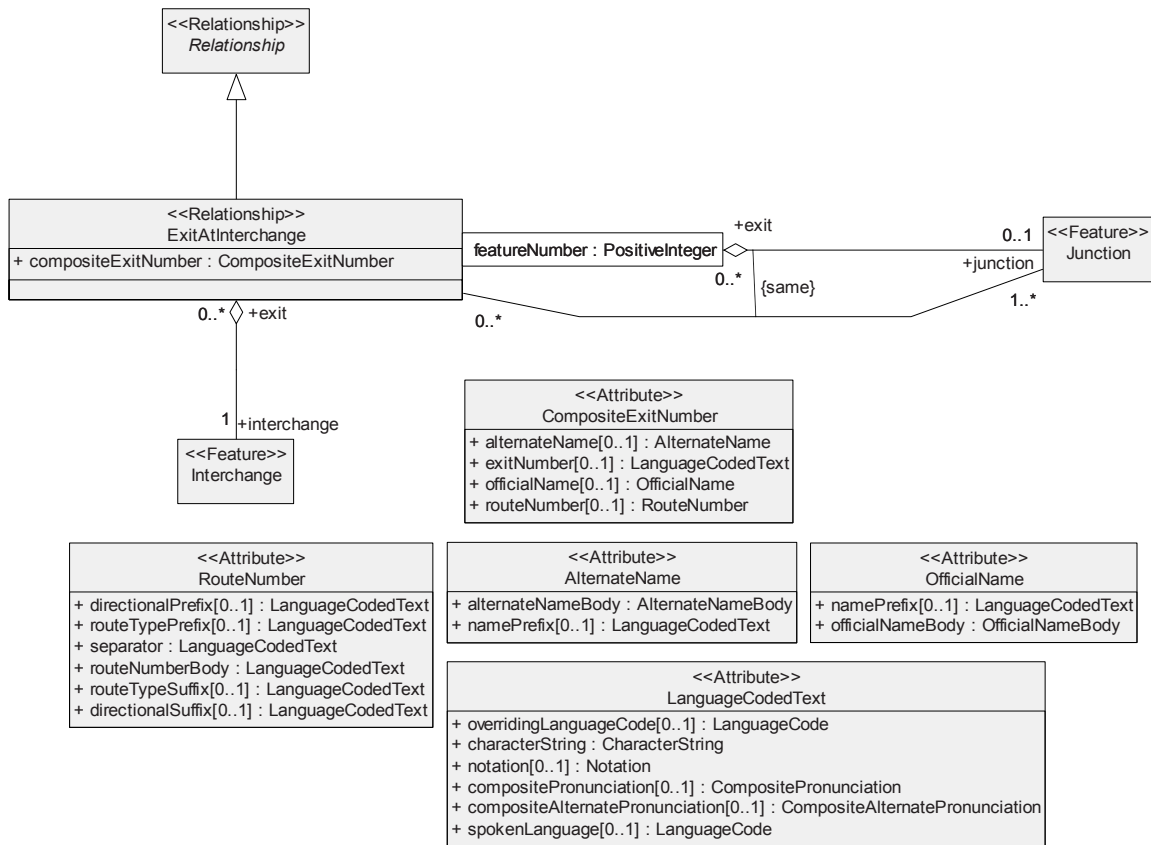

Figure 151 — The Conceptual Data Model for the Exit at Interchange Relationship

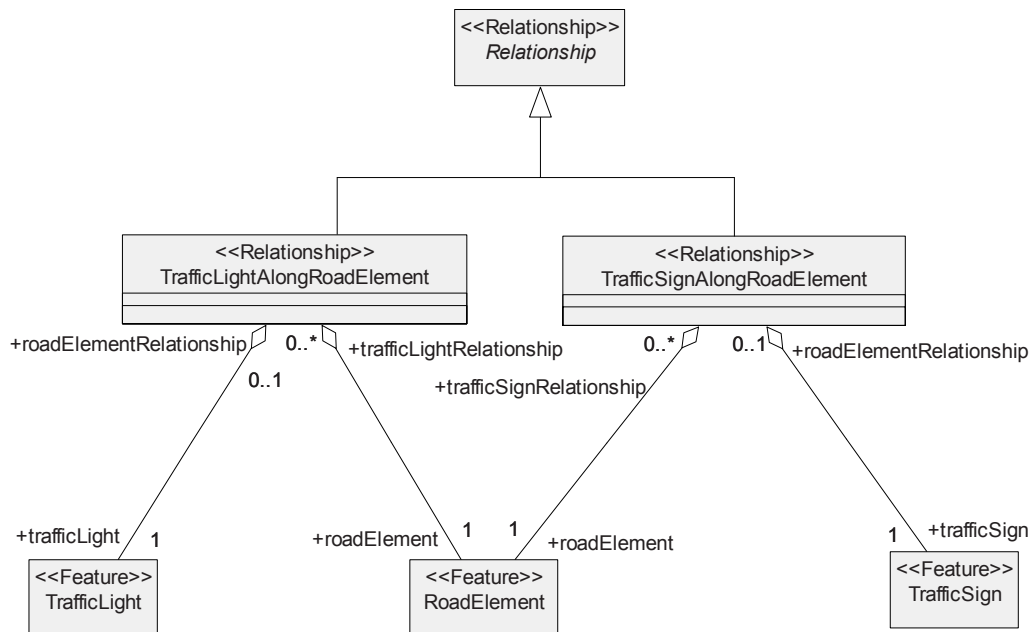

Figure 152 — The Conceptual Data Model for the Traffic Sign along Road Element and the Traffic Light along Road Element Relationships

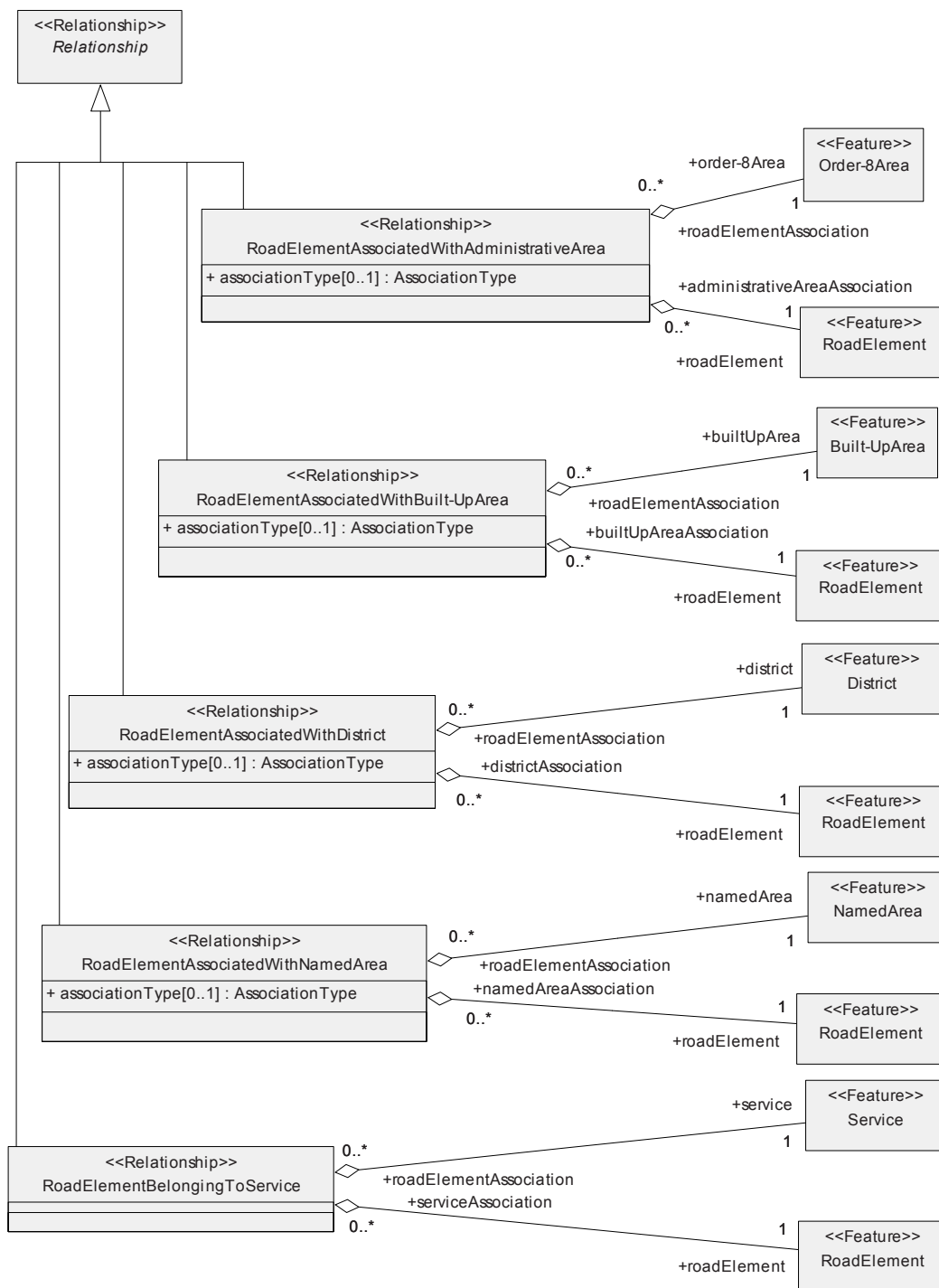

Figure 153 — The Conceptual Data Model for Relationships with arity 2, involving the Feature Themes Roads and Ferries, Administrative Areas, Named Areas, Land Cover and Use, and Services

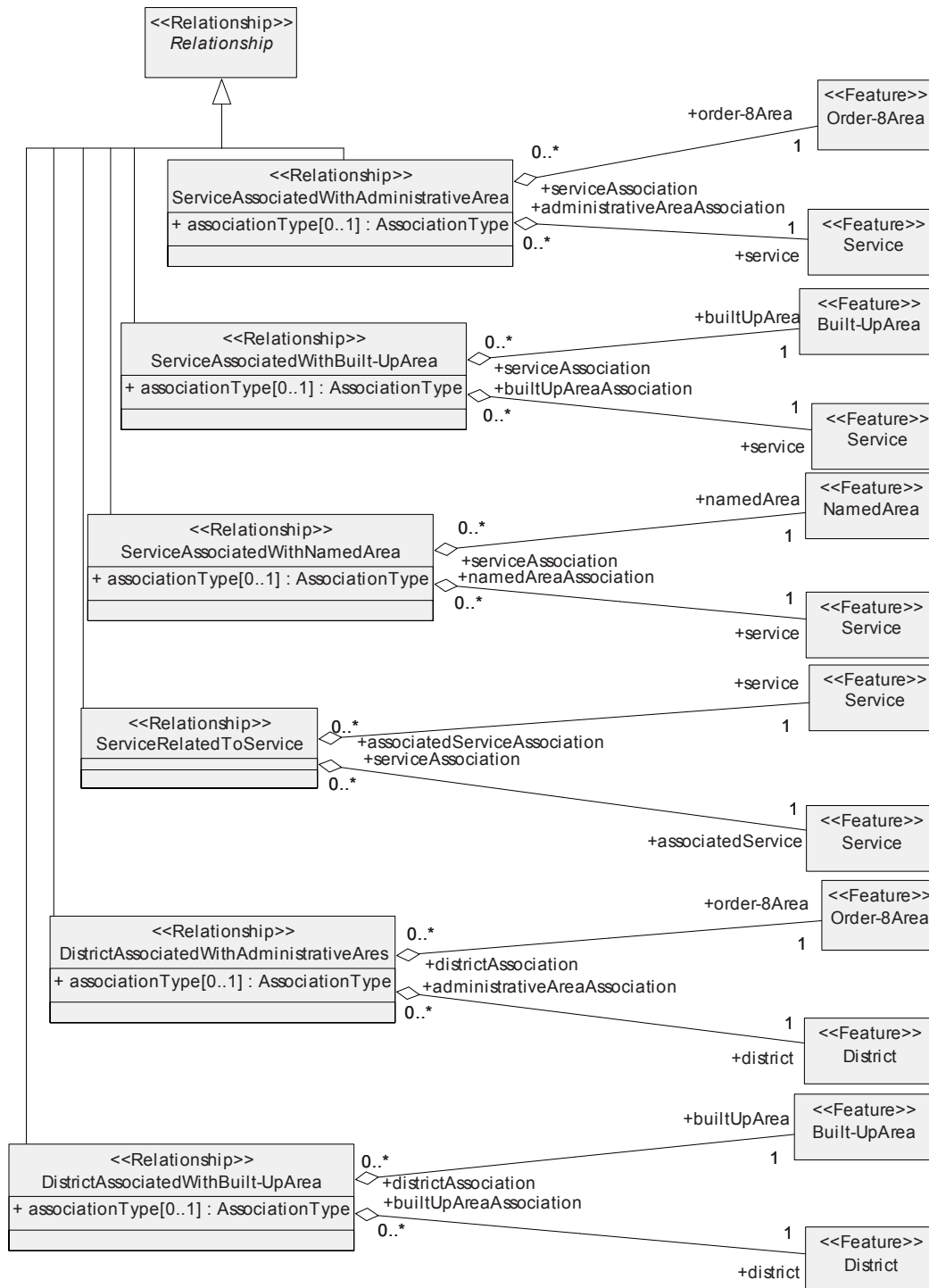

Figure 155 — The Conceptual Data Model for Relationships with arity 2, involving the Feature Themes Roads and Ferries, Administrative Areas, Named Areas, Land Cover and Use, and Services (Continued)

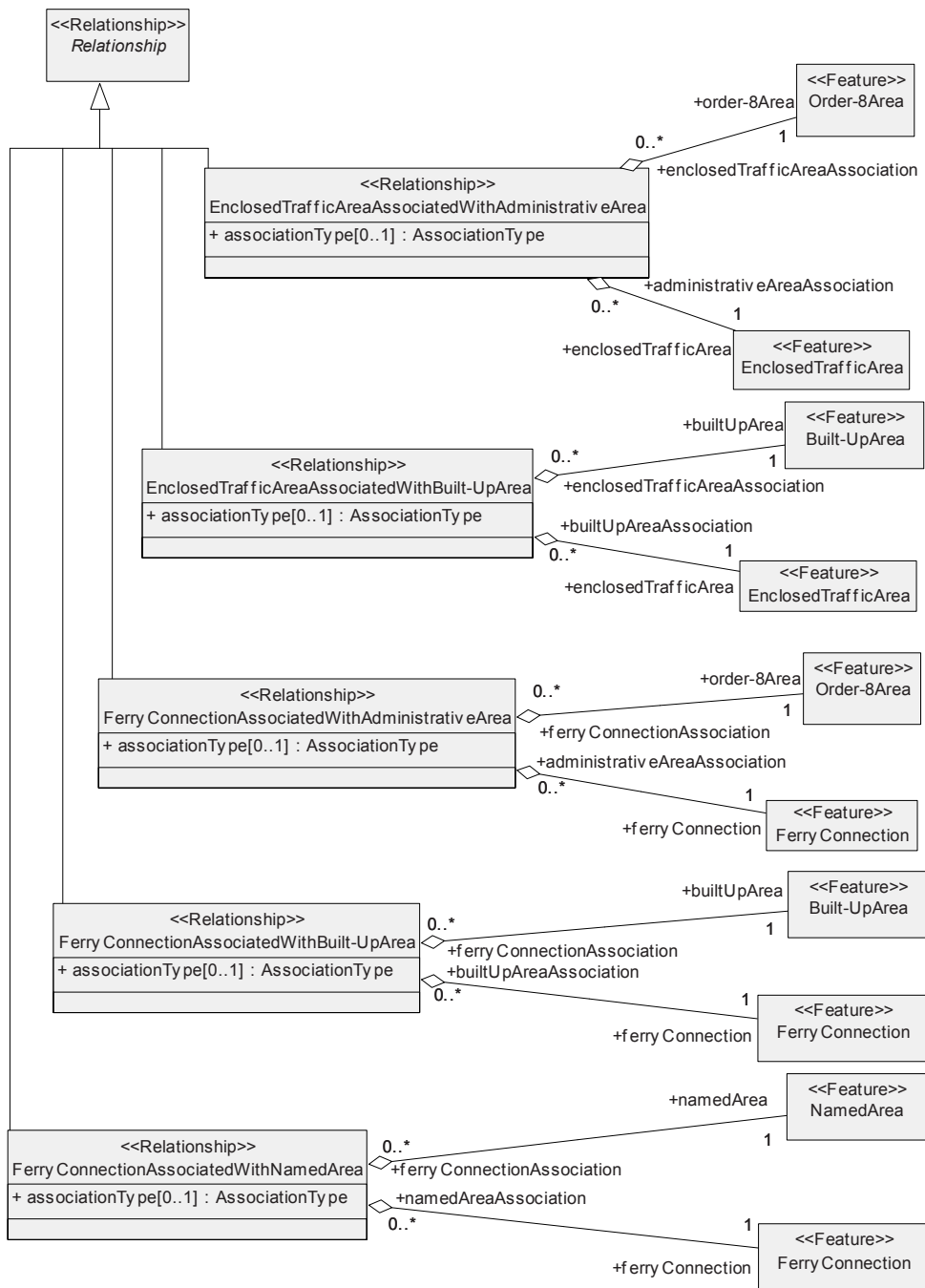

Figure 156 — The Conceptual Data Model for Relationships with arity 2 involving the Feature Themes Roads and Ferries, Administrative Areas, Named Areas, Land Cover and Use, and Services (Continued)

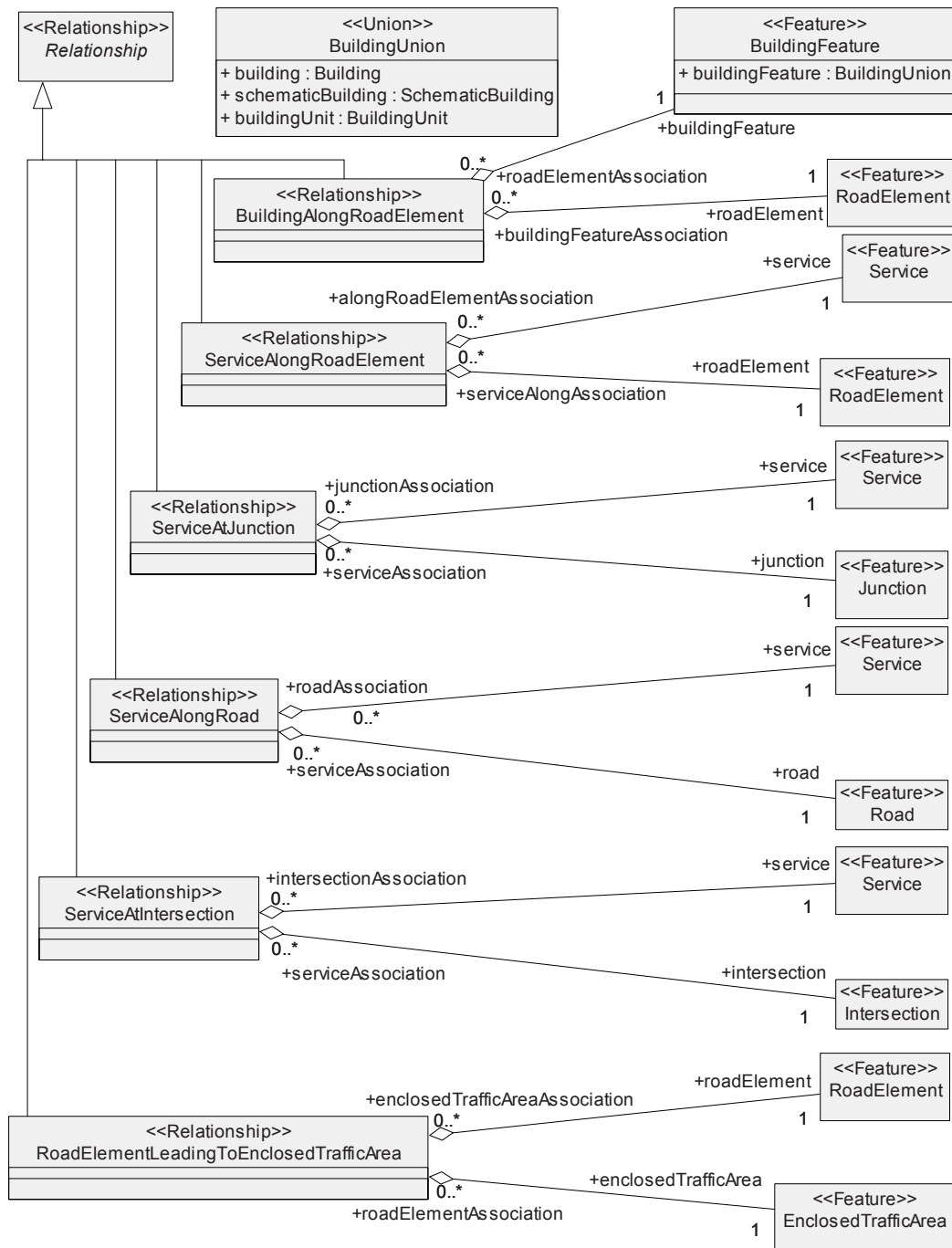

Figure 157 — The Conceptual Data Model for Relationships with arity 2, involving the Feature Themes Roads and Ferries, Administrative Areas, Named Areas, Land Cover and Use, and Services (Continued)

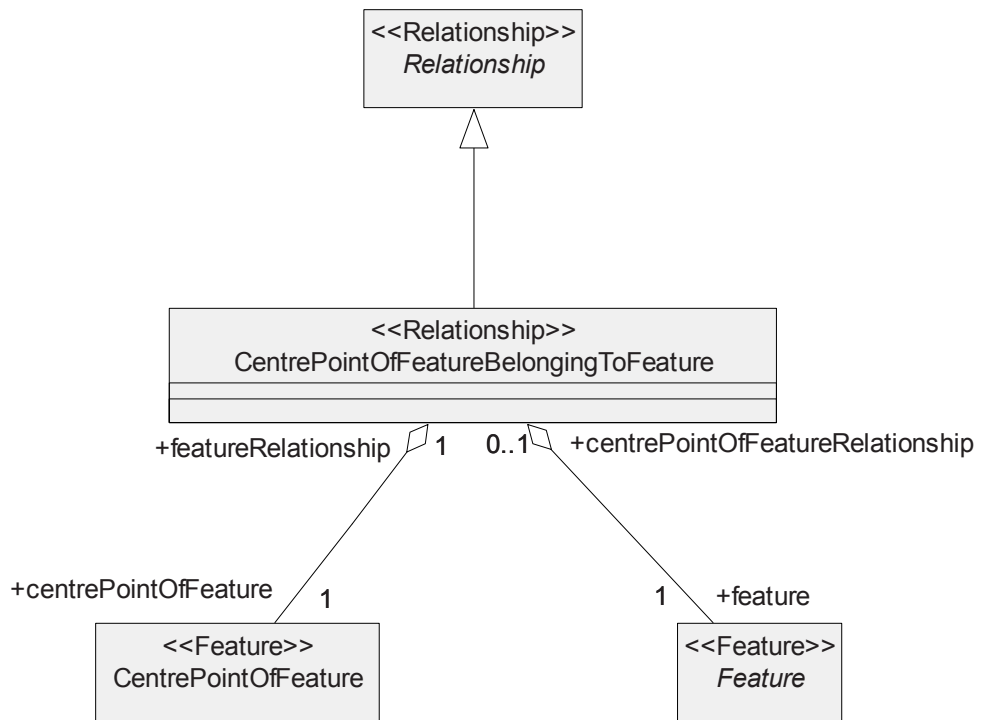

Figure 159 — The Conceptual Data Model for the Centre Point of Feature belonging to Feature Relationship

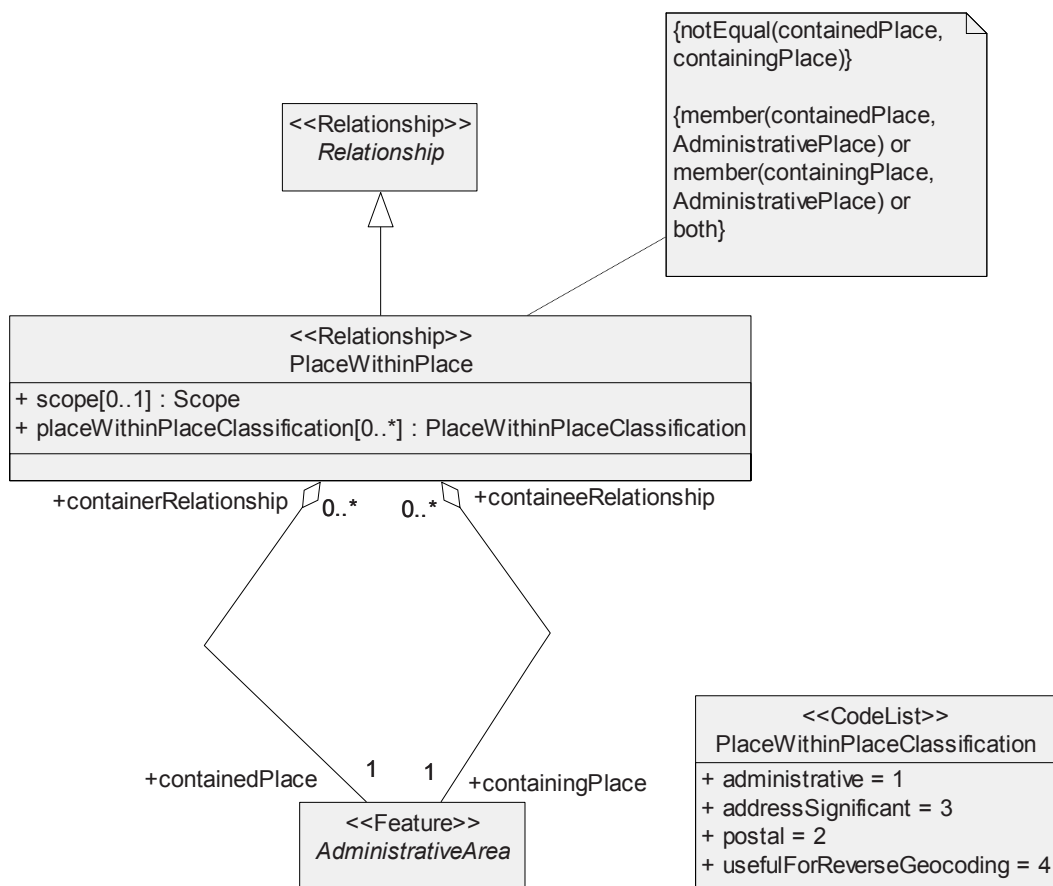

Figure 160 — The Conceptual Data Model for the Place within Place Relationship

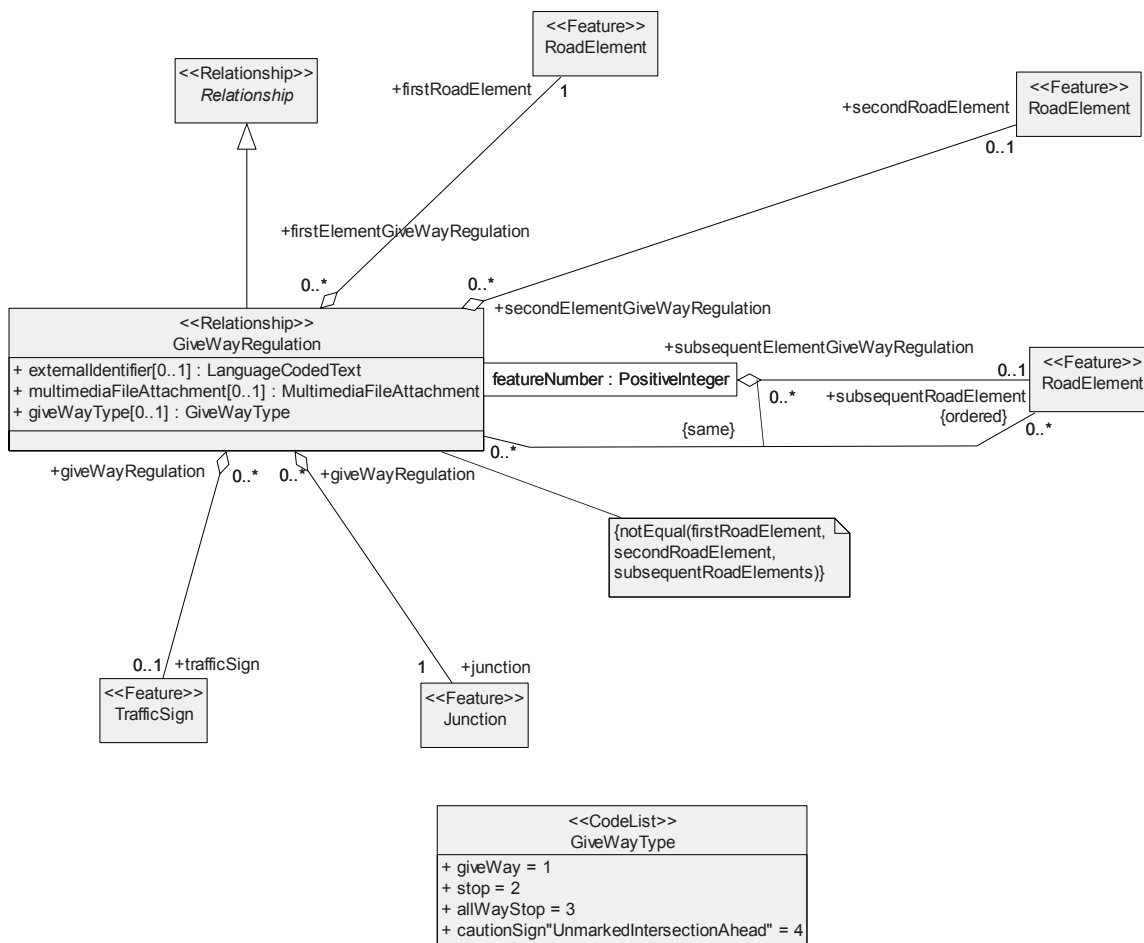

Figure 161 — The Conceptual Data Model for the Give Way Regulation Relationship

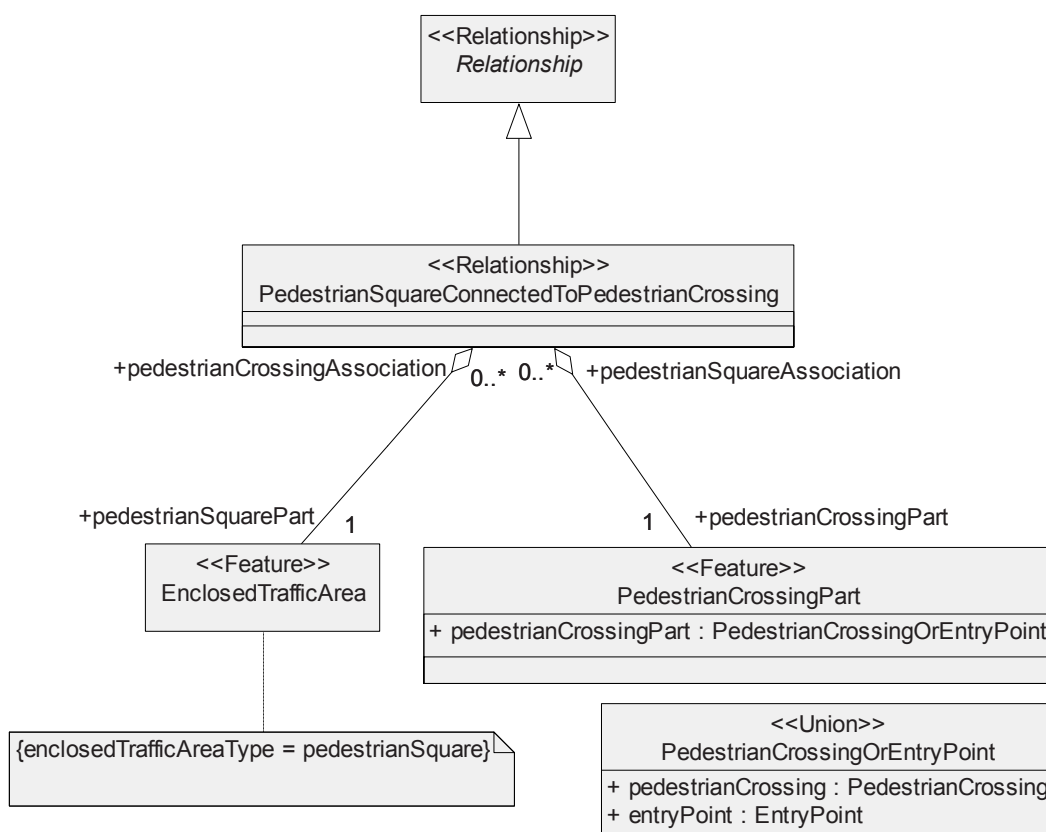

Figure 162 — The Conceptual Data Model for the Pedestrian Square Connected To Pedestrian Crossing Relationship

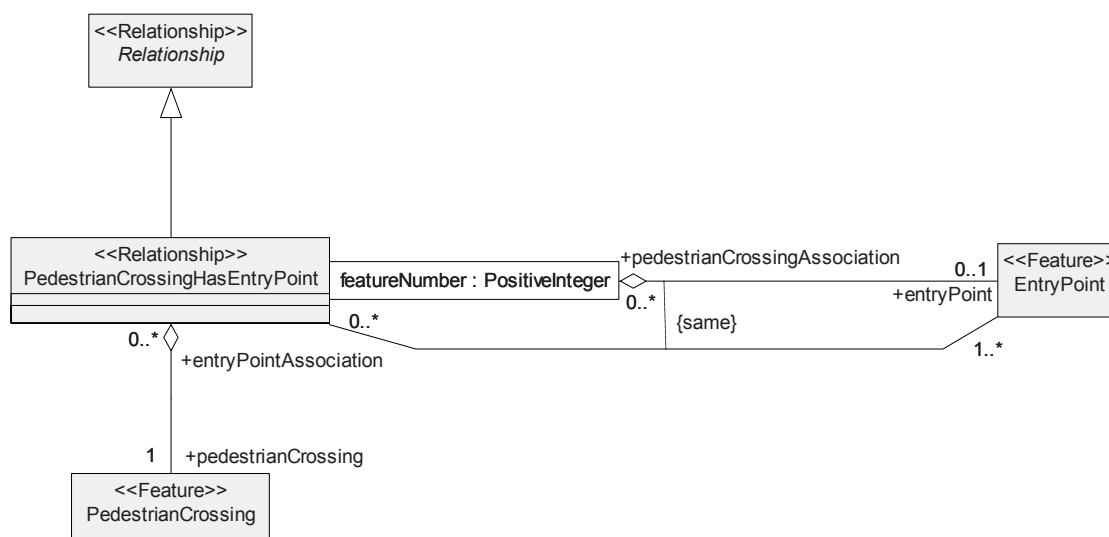

Figure 163 — The Conceptual Data Model for the Pedestrian Crossing Has Entry Point Relationship

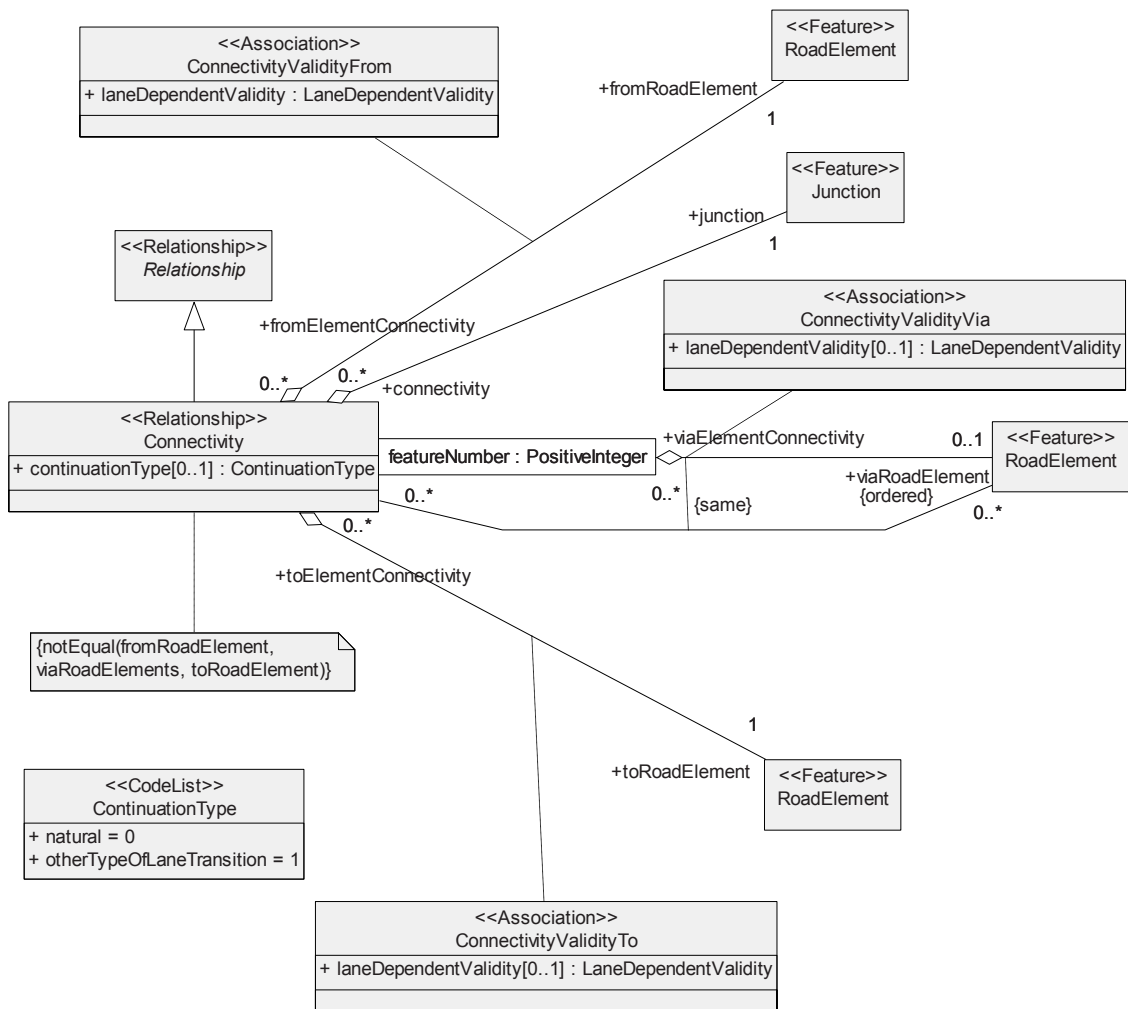

Figure 164 —The Conceptual Data Model for the Connectivity Relationship

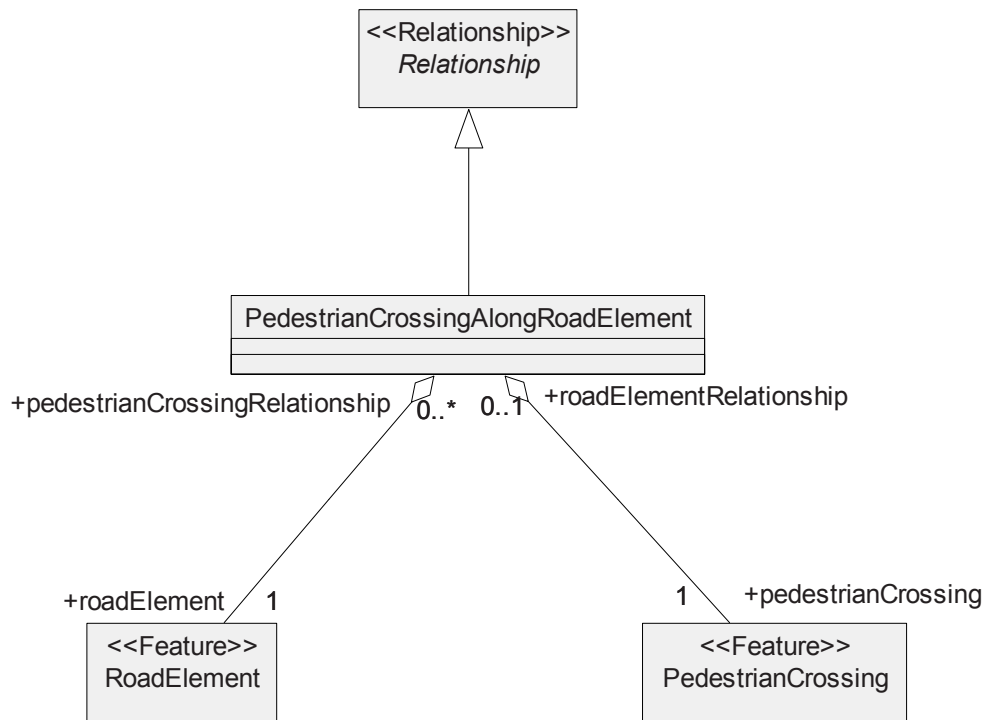

Figure 167 — The Conceptual Data Model for Pedestrian Crossing along Road Element Relationship

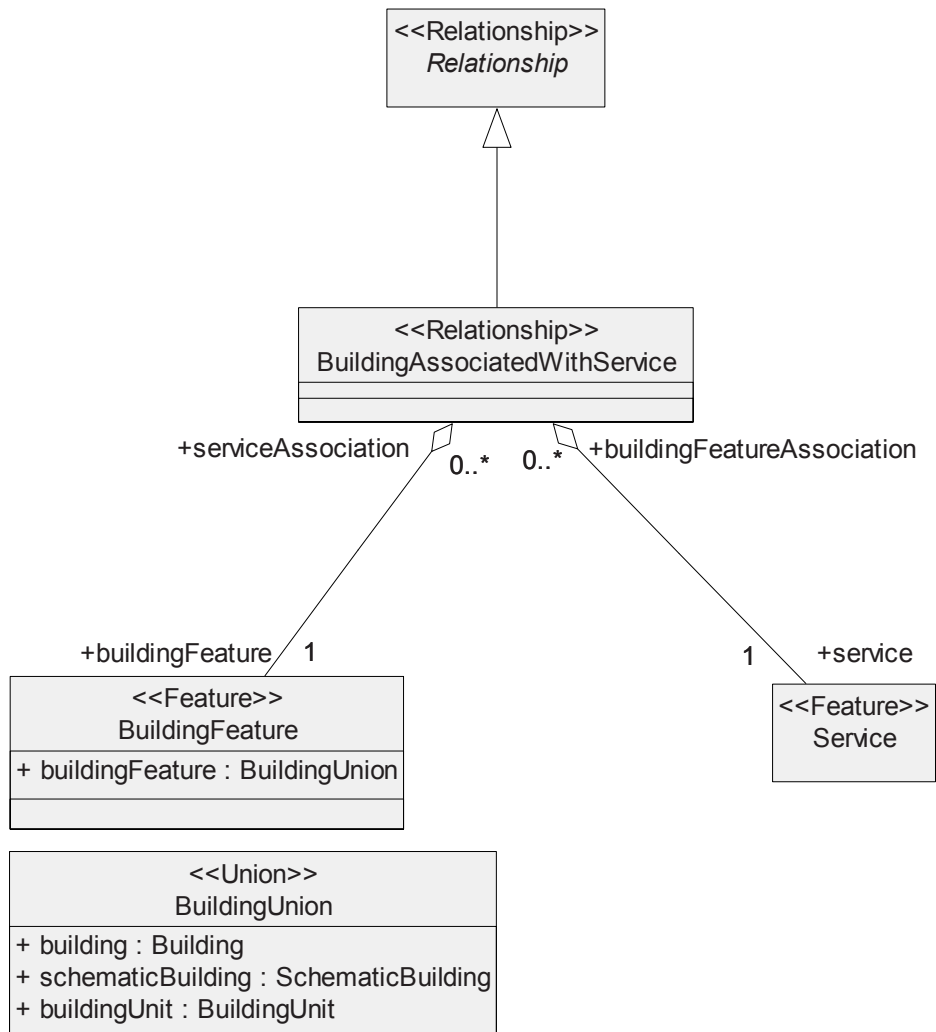

Figure 168 —The Conceptual Data Model for the Building Associated With Service Relationship

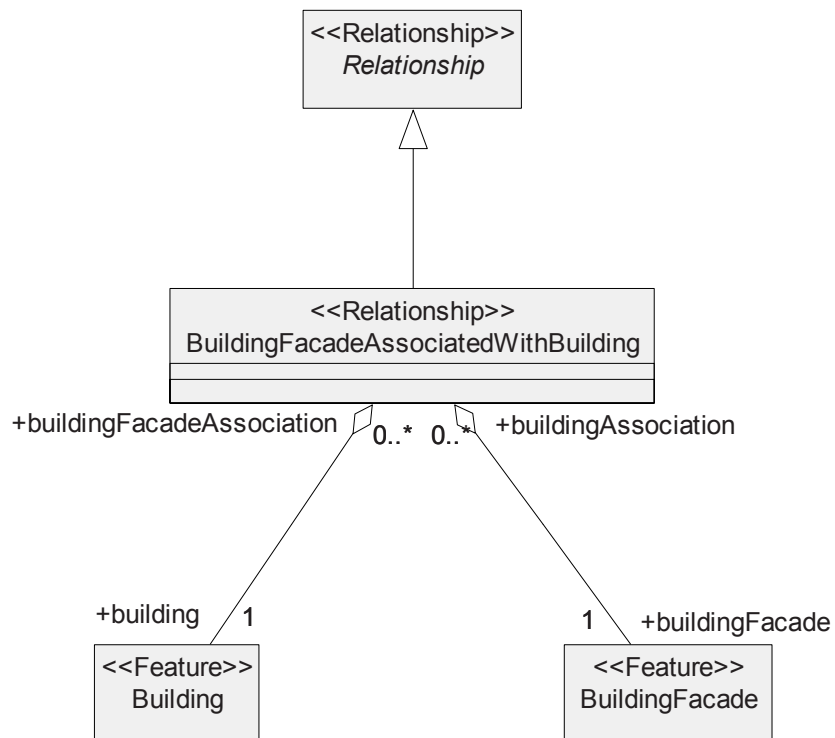

Figure 169 —The Conceptual Data Model for the Building Façade Associated With Building Relationship

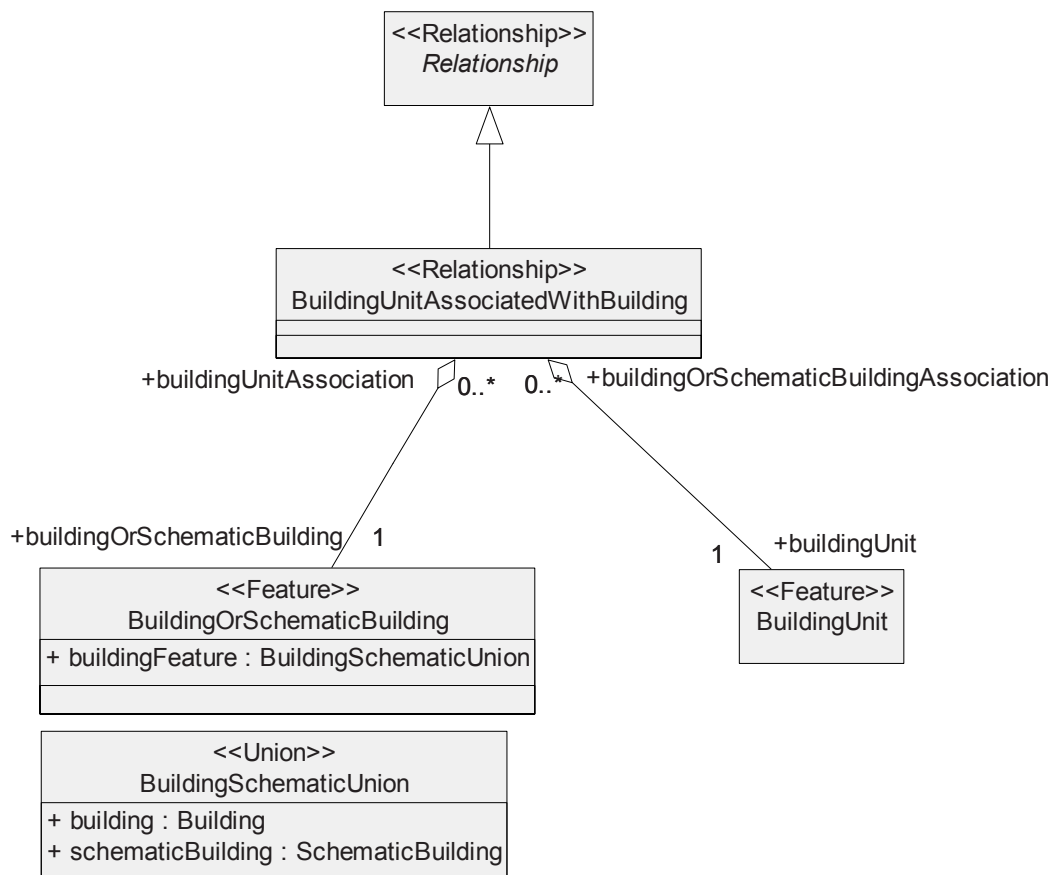

Figure 170 —The Conceptual Data Model for the Building Unit Associated With Building Relationship

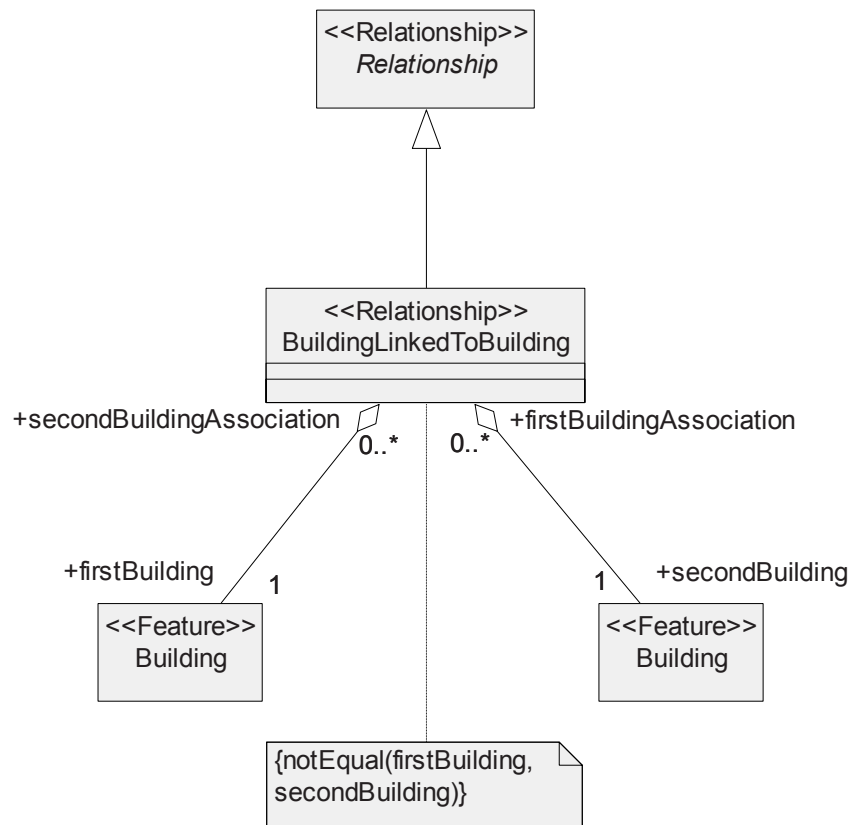

Figure 171 —The Conceptual Data Model for the Building Linked To Building Relationship

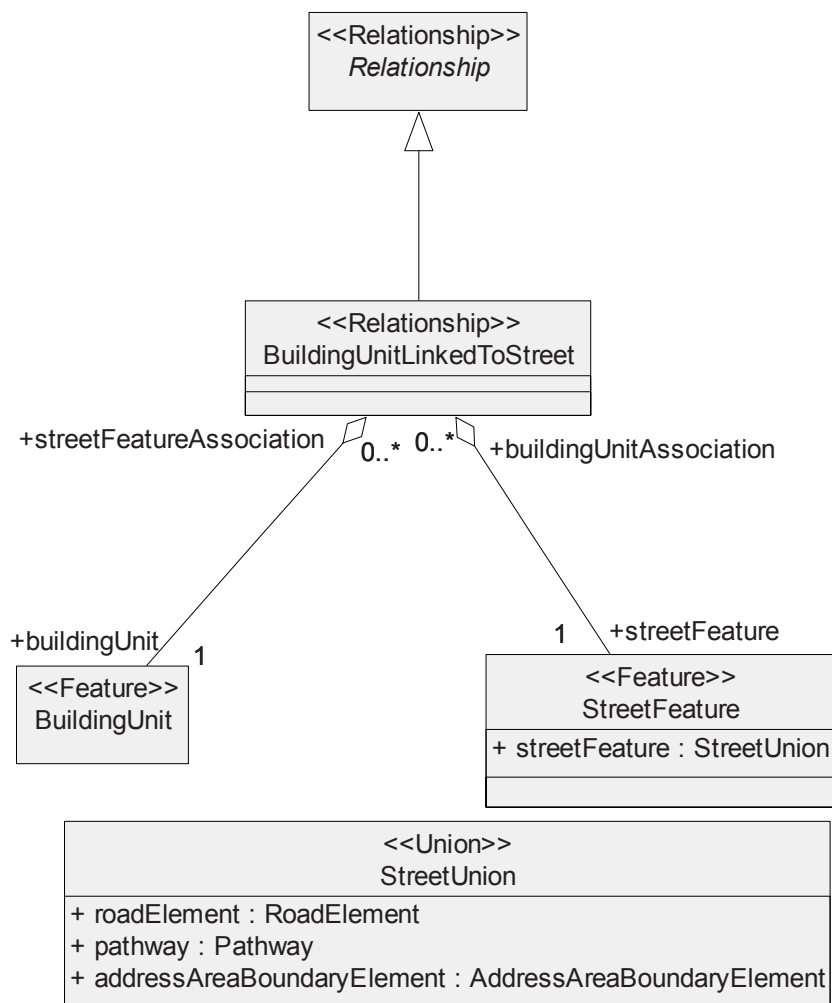

Figure 172 —The Conceptual Data Model for the Building Unit Linked To Street Relationship

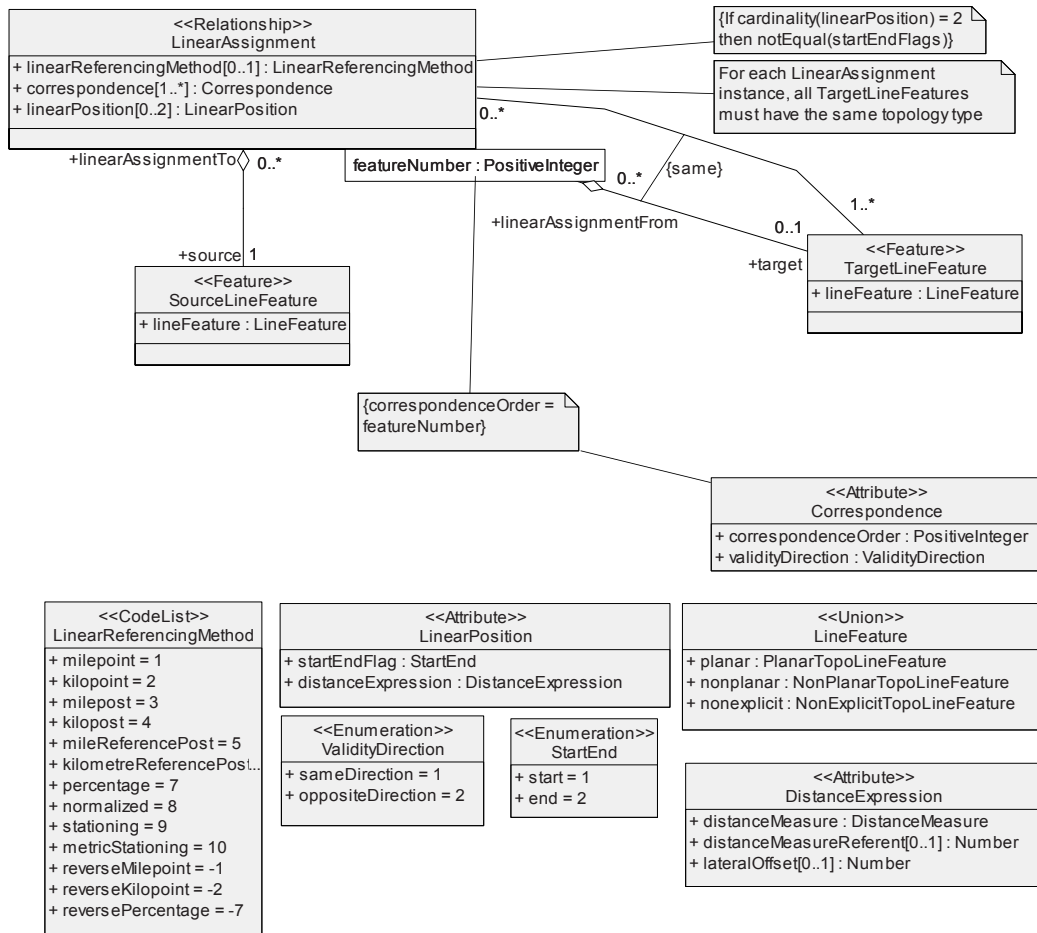

Figure 173 —The Conceptual Data Model for the Linear Assignment Relationship

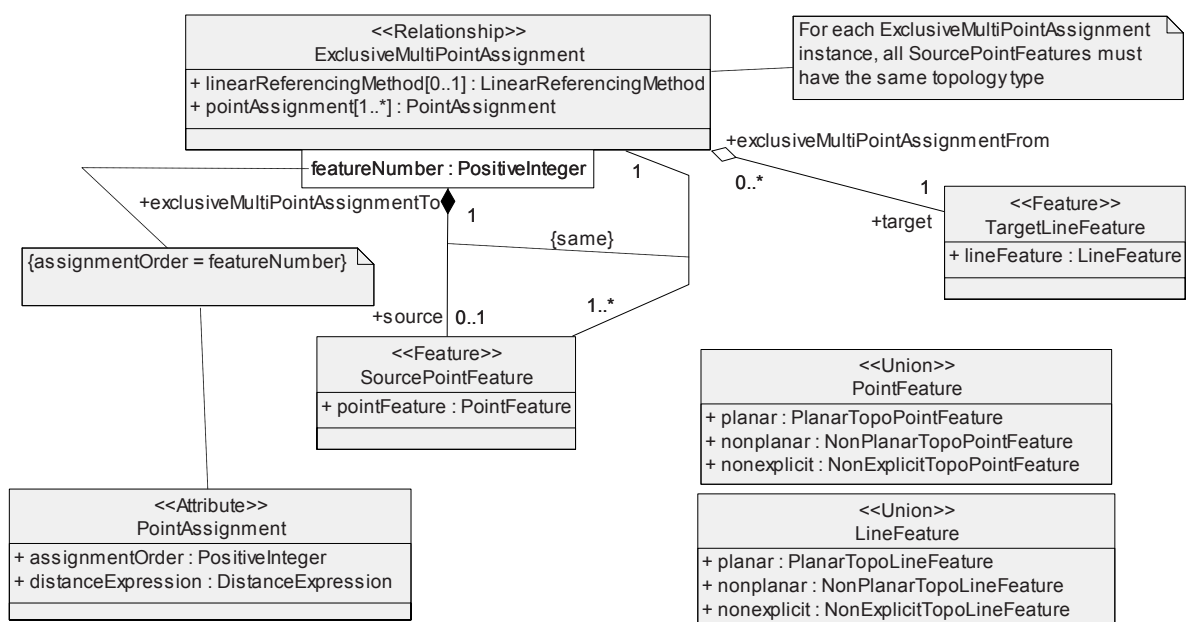

Figure 174 — The Conceptual Data Model for the Exclusive Multi-Point Assignment Relationship

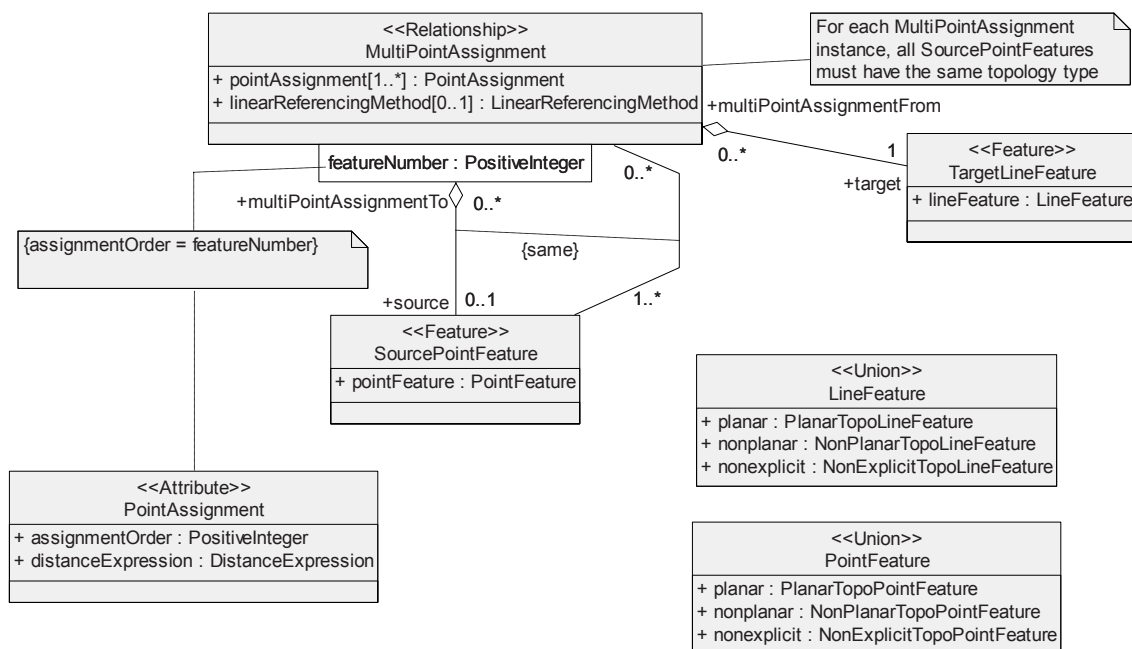

Figure 175 — The Conceptual Data Model for the Multi-Point Assignment Relationship

8.1.2 Relationship Types

All identical relationships between *Features* belonging to the same *Feature Class* are said to belong to the same *Relationship* type. E.g. the facts that Paris is the capital of France and Madrid is the capital of Spain can both be seen as instances of the *Relationship* type “Is capital of” between two instances of the *Feature* class “Settlement” and “Country” respectively.

8.1.3 Relationship Type Codes

The referencing by *Relationship* Type Names is applied in this document. In the physical data structure, however, Relationships are referenced by a *Relationship* Type Code. Clause A.4 contains an overview of the defined *Relationship* Type Codes.

8.1.4 Arity of a Relationship

Most information can be modelled in the form of binary relationships, i.e. relationships with only two partners, as in the examples of country capitals given above. However, some facts cannot be split into binary relationships with impunity. If one wants to express the fact that London Bridge leads High Street over the Thames, this can only be represented correctly by means of a ternary *Relationship* between the three *Features* “Structure”, “Road Element” and “Waterway Element”. Trying to split this fact into two binaries would cause loss of information.

The number of *Feature* classes in a *Relationship* is called the arity of that *Relationship*.

8.1.5 Roles and partners of a Relationship

The *Feature* classes involved in a particular *Relationship* are called the partners in the *Relationship*. Each partner plays a dedicated role within the Relationship Type in question. In the above mentioned example “City” and “Country” are the roles in the *Relationship* “Is capital of”.

For each role in a Relationship, its role number and role name is defined (both unique among the Relationship's roles). Also, it is defined if a role is mandatory, meaning that there has to be at least one Feature playing this role. Furthermore, it is defined if a role can repeat, whereby a role may correspond to multiple Features of the same Feature Class (e.g. multiple departing Road Elements of a Fork). In case such multiple Feature instances conceptually reflect a particular order, an explicit ordering constraint is specified.

For a role, commonly a single Feature Class is applicable. However, multiple "candidate" Feature Classes may be allowable in certain cases (e.g. the role of upper Transportation Element may be played by either a Road Element, a Junction, or a Railway Element, to name a few allowable Feature Classes).

Two Features of the same Feature Class may play two different roles in the same Relationship (e.g. Transportation Elements as Underpass and Overpass of a grade-separated crossing, respectively).

8.1.6 Homogeneous Relationships and their constraints

8.1.6.1 Introduction

A *Relationship* is called homogeneous if and only if at least two partners in that *Relationship* are of the same *Feature* class.

EXAMPLE 1 The *Relationship Prohibited Manoeuvre*, where each *Relationship* involves at least two Road Elements.

EXAMPLE 2 The *Relationship Grade Separated Crossing*, where each *Relationship* involves two *Transportation Elements*.

Homogeneous relationships can be characterised according to whether they are reflexive, symmetric, transitive or not. What these constraints mean is explained in the following sub-clauses by mathematical definitions.

8.1.6.2 Reflexivity

A *Relationship* R is called reflexive over A if and only if for all x in A , (x,x) is an element of R . A *Relationship* R is called irreflexive if and only if for all x , (x,x) is not an element of R . *Relationships* that do not meet one of these conditions are called non reflexive. (Note that this is not the same as irreflexive.)

8.1.6.3 Symmetry

A *Relationship* R is called symmetric over A if and only if for all x in A , (x_i,x_j) is an element of R when (x_j,x_i) is an element of R .

A *Relationship* R is called asymmetric over A if and only if for all x in A , (x_i,x_j) and (x_j,x_i) are not both an element of R .

Relationships that do not satisfy one of these conditions are called non symmetric. (Note that this is not the same as asymmetric.)

8.1.6.4 Transitivity

A *Relationship* R is called transitive if and only if for all x , y and z , (x,z) is an element of R when both (x,y) and (y,z) are elements of R . A *Relationship* R is called intransitive if and only if for all x , y and z , (x,z) is not an element of R when both (x,y) and (y,z) are elements of R .

Relationships that do not meet one of these conditions are called non transitive. Note that this is not the same as intransitive.

8.2 Relationship Types

8.2.1 Building along Road Element

8.2.1.1 Definition

Relationship between a *Building*, *Schematic Building* or *Building Unit* and the *Road Element* along which it is located.

8.2.1.2 Feature roles

8.2.1.2.1 Road Element

- This role is mandatory.
- This role is not repeatable.

8.2.1.2.2 Building Feature

- This role is mandatory.
- This role is not repeatable.

8.2.1.3 Description

This *Relationship* identifies the *Road Element* along which the entrance of the *Building*, *Schematic Building* or *Building Unit* is situated. For the conceptual data model, see Figure 157.

In most cases the *Road Element* to which a *Building*, *Schematic Building* or *Building Unit* logically “belongs”, will be the closest. However, this will not always be the case. See Figure 176.

One *Building*, *Schematic Building* or *Building Unit* may belong to two or more different *Road Elements* if the *Building* or *Bilding Unit* has several entrances located at different *Road Elements*. Each is represented as a separate *Relationship*.

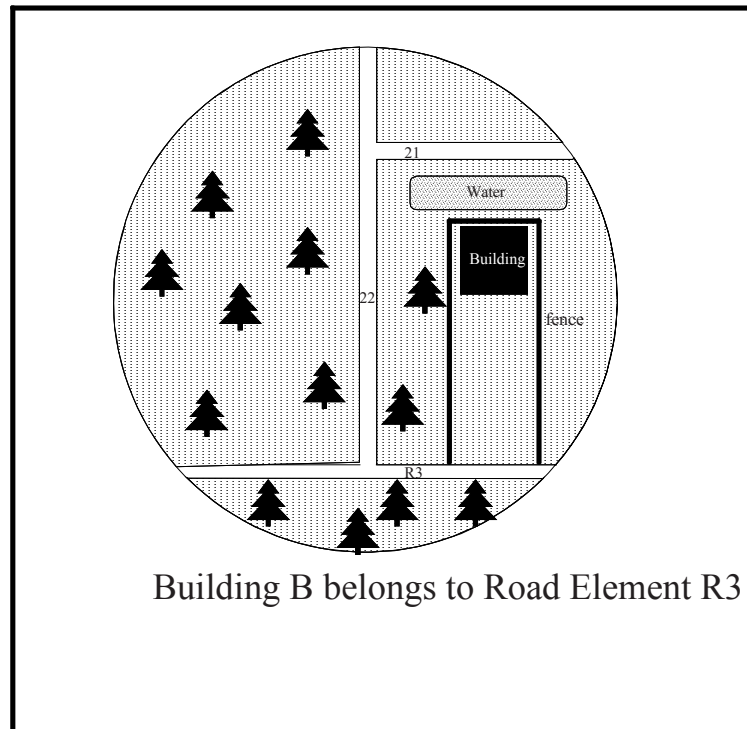

Figure 176 — Example of a Building along Road Element

8.2.2 Building Associated with Administrative Area

8.2.2.1 Definition

Relationship between a Building, Schematic Building or Building Unit and the Administrative Area in which it is located or with which it is commonly associated.

8.2.2.2 Feature Roles

8.2.2.2.1 Order-8 Area

- This role is mandatory.
- This role is not repeatable.

8.2.2.2.2 Building Feature

- This role is mandatory.
- This role is not repeatable.

8.2.2.3 Description

For the conceptual data model, see Figure 154.

8.2.3 Building Associated with Built-up Area

8.2.3.1 Definition

Relationship between a Building, Schematic Building or Building Unit and the Built-up Area in which it is located or with which it is commonly associated.

8.2.3.2 Feature roles

8.2.3.3 Built-up-Area

- This role is mandatory.
- This role is not repeatable.

8.2.3.3.1 Building Feature

- This role is mandatory.
- This role is not repeatable.

8.2.3.4 Description

For the conceptual data model, see Figure 154.

8.2.4 Building Associated with Service

8.2.4.1 Definition

Relationship between a Building, Schematic Building or Building Unit and the Service with which it is commonly associated.

8.2.4.2 Feature roles

8.2.4.2.1 Service

- This role is mandatory.
- This role is not repeatable.

8.2.4.2.2 Building Feature

- This role is mandatory.
- This role is not repeatable.

8.2.4.3 Description

For the conceptual data model, see Figure 168.

8.2.5 Building Façade is associated with Building

8.2.5.1 Definition

Relationship between a Building Façade and the footprint of a Building with which it is commonly associated.

8.2.5.2 Feature roles

8.2.5.2.1 Building Façade

- This role is mandatory.
- This role is not repeatable.

8.2.5.2.2 Building

- This role is mandatory.
- This role is not repeatable.

8.2.5.3 Description

For the conceptual data model, see Figure 169.

This Relationship represents the linkage between the façade of a Building with the building object.

8.2.6 Building Unit is associated with Building

8.2.6.1 Definition

Relationship between a Building Unit and the Building or Schematic Building with which it is commonly associated.

8.2.6.2 Feature roles

8.2.6.2.1 Building Unit

- This role is mandatory.
- This role is not repeatable.

8.2.6.2.2 Building or Schematic Building

- This role is mandatory.
- This role is not repeatable.

8.2.6.3 Description

For the conceptual data model, see Figure 170.

This Relationship represents the linkage between addressable and architectural (visual) information components associated with (schematic) building objects.

8.2.7 Building Unit linked to Street

8.2.7.1 Definition

Relationship between a Road Element, Pathway or Address Area Boundary Element and the Building Unit carrying its street address.

8.2.7.2 Feature roles

8.2.7.2.1 Street Feature

- This role is mandatory.
- This role is not repeatable.

8.2.7.2.2 Building Unit

- This role is mandatory.
- This role is not repeatable.

8.2.7.3 Description

For the conceptual data model, see Figure 172.

This Relationship identifies the Road Element or Address Area Boundary Element that is associated with the street address of a Building Unit. In most cases the closest Road Element or Address Area Boundary Element will be the correct one, possibly the closest Pathway. However, this will not always be the case.

8.2.8 Building linked to Building

8.2.8.1 Definition

Relationship between a Building and other Building(s) it is linked to, representing a group of buildings recognised as one (logical) structure.

8.2.8.2 Feature roles

8.2.8.2.1 First Building

- This role is mandatory.
- This role is not repeatable.

8.2.8.2.2 Second Building

- This role is mandatory.
- This role is not repeatable.

8.2.8.3 Description

For the conceptual data model, see Figure 171.

Linked Buildings are considered part of one entity. The individual building may be referred to by a common name, potentially supplemented by additional sub-names for the respective parts. Linked buildings may or may not be attached to each other, and may or may not be connected, e.g. via an underground passage.

Examples are twin towers, a hotel building next an annex building, or two buildings connected by an elevated skyway (which may be represented by its own (projected) building footprint).

8.2.9 Built-up Area Associated with Administrative Area

8.2.9.1 Definition

Relationship between a Built-Up Area and the Administrative Area in which it is located or to which it is commonly associated.

8.2.9.2 Feature roles

8.2.9.2.1 Order-8 Area

- This role is mandatory.
- This role is not repeatable.

8.2.9.2.2 Built-up Area

- This role is mandatory.
- This role is not repeatable.

8.2.9.3 Description

The Relationship between Built-up Areas and Administrative Areas is many to many. That means that one Administrative Area may contain many different Built-up Areas and that one Built-up Area may belong to many different Administrative Areas because it may cross more than one boundary. Each pair of Built-up Area and Administrative Area is represented as a separate Relationship. For the conceptual data model, see Figure 154.

8.2.10 Centre Point of Feature belonging to Feature

8.2.10.1 Definition

Relationship between a Centre Point of Feature and the Feature for which it is the centre point.

8.2.10.2 Feature roles

8.2.10.2.1 Centre Point

- This role is mandatory.
- This role is not repeatable.

8.2.10.2.2 Feature

- This role is mandatory.
- This role is not repeatable.

8.2.10.3 Description

For the conceptual data model, see Figure 159.

8.2.11 Connectivity

8.2.11.1 Definition

Representation of connectivity between lanes across junctions are based on a directed Manoeuvre of the incoming (“From”) Road Element, a Junction to indicate the direction, optional intermediate (“via”) Road Element(s), and the outgoing (“To”) Road Element.

8.2.11.2 Feature roles

8.2.11.2.1 From Road Element

- This role is mandatory.
- This role is not repeatable.

8.2.11.2.2 Junction

- This role is mandatory.
- This role is not repeatable.

8.2.11.2.3 Via Road Element

- This role is optional.
- This role is repeatable. Conceptually, Features playing this role shall be ordered.

8.2.11.2.4 To Road Element

- This role is mandatory.
- This role is not repeatable.

8.2.11.3 Description

For the conceptual data model, see Figure 164.

Lane specific details are supplemented through pair(s) of Restrictive Sub-Attributes Lane-Dependent Validity, corresponding to the concerned lane(s) of the “From” and the “To” Road Elements, respectively.

Multiple pairs of Lane-dependent Validity Attributes can be attached to this relationship to map the entire lane connectivity “matrix” between the “From” and “To” Road Element.

In addition, the coded lane connectivity can be classified whether or not it represents natural continuations between incoming lane(s) and outgoing lane(s). This classification is modelled by the Attribute Continuation Type. Consequently, the connectivity matrix is to be broken up in such cases and two Relationship instances are to be specified, containing the naturally continued and not naturally continued lanes, respectively.

In complex situation “via road elements” can be specified as part of the connectivity definition. These via road elements give a path from the incoming Road Element to the outgoing road element. Road elements along this via path do not necessarily carry additional lane information.

8.2.12 District Associated with Administrative Area

8.2.12.1 Definition

Relationship between a Census District, Elective District, Emergency Medical Dispatch District, Fire Dispatch District, Phone District, Police District, Postal District or School District and the Administrative Area in which it is located or to which it is commonly associated.

8.2.12.2 Feature roles

8.2.12.2.1 Order-8 Area

- This role is mandatory.
- This role is not repeatable.

8.2.12.2.2 District

- This role is mandatory.
- This role is not repeatable.

8.2.12.3 Description

The Relationship between Districts and Administrative Areas is many to many. That means that one Administrative Area may contain many different Districts and that one District may belong to many different Administrative Areas because it may cross more than one boundaries. Each pair of District and Administrative Area is represented as a separate Relationship. For the conceptual data model, see Figure 155.

8.2.13 District Associated with Built-up Area

8.2.13.1 Definition

Relationship between a Census District, Elective District, Emergency Medical Dispatch District, Fire Dispatch District, Phone District, Police District, Postal District or School District and the Built-up Area in which it is located or to which it is commonly associated.

8.2.13.2 Feature roles

8.2.13.2.1 Built-up Area

- This role is mandatory.
- This role is not repeatable.

8.2.13.2.2 District

- This role is mandatory.
- This role is not repeatable.

8.2.13.3 Description

For the conceptual data model, see Figure 155.

8.2.14 Divided Junction

8.2.14.1 Definition

A Divided Junction is a manoeuvre that contains a Junction which has a physical or legal divider that prevents crossing it in a particular direction. The two Road Elements bounded by the Junction indicate along which Road Elements the Junction is divided. This implies that certain Manoeuvres are prevented.

8.2.14.2 Feature roles

8.2.14.2.1 First Road Element

- This role is mandatory.
- This role is not repeatable.

8.2.14.2.2 Junction

- This role is mandatory.
- This role is not repeatable.

8.2.14.2.3 Second Road Element

- This role is mandatory.
- This role is not repeatable.

8.2.14.3 Description

For the conceptual data model, see Figure 147.

8.2.15 Enclosed Traffic Area Associated with Administrative Area

8.2.15.1 Definition

Relationship between an Enclosed Traffic Area and the Administrative Area in which it is located or to which it is commonly associated..

8.2.15.2 Feature roles

8.2.15.2.1 Order-8 Area

- This role is mandatory.
- This role is not repeatable.

8.2.15.2.2 Enclosed Traffic Area

- This role is mandatory.
- This role is not repeatable.

8.2.15.3 Description

For the conceptual data model, see Figure 156.

8.2.16 Enclosed Traffic Area Associated with Built-up Area

8.2.16.1 Definition

Relationship between an Enclosed Traffic Area and the Built-up Area in which it is located or to which it is commonly associated..

8.2.16.2 Feature roles

8.2.16.2.1 Built-up Area

- This role is mandatory.
- This role is not repeatable.

8.2.16.2.2 Enclosed Traffic Area

- This role is mandatory.
- This role is not repeatable.

8.2.16.3 Description

For the conceptual data model, see Figure 156.

8.2.17 Exclusive Multi-Point Assignment

8.2.17.1 Definition

Relationship used to exclusively link source Point Feature(s) to a target Line Feature.

8.2.17.2 Feature roles

8.2.17.2.1 Source

- This role is mandatory.
- This role is repeatable. Conceptually, no particular order of Features playing this role is implied.

8.2.17.2.2 Target

- This role is mandatory.
- This role is not repeatable.

8.2.17.3 Description

For the conceptual data model, see Figure 174.

Exclusive Multi-Point Assignments are defined as Relationships between one or more source Point Features and the target Line Features. A source Point Feature is exclusively linked to a target Line Features, and thus must not play a role in other Multi-Point Assignments or Exclusive Multi-Point Assignments.

A Point Assignment indicates that that part of the Exclusive Multi-Point Assignment is between a source Point Feature and the target Line Feature.

Point Assignments are ordered, based on their Assignment Order Attribute.

The corresponding locations are defined in accordance with the standard for Linear Referencing contained within ISO 19148, Linear referencing [30]. Locations are described with three mandatory components.

- The first component is the linear element being measured, in this case the target Line Feature.
- The second component is the measurement method, called the Linear Referencing Method (LRM). The LRM used to measure along the target Line Feature is its Default Linear Referencing Method, and in the case of the target Line Feature being an Anchor Section, its Linear Datum's Default Linear Referencing Method; it can be overridden by an individual Linear Referencing Method Attribute specified for the actual Exclusive Multi-Point Assignment.
- The third component is the measured value along the linear element being measured. It is the Distance Expression Sub-Attribute of the Point Assignment Attribute which is measuring along the target Line Feature.

8.2.18 Exit at Interchange

8.2.18.1 Definition

The Relationship between an Interchange and one or more contained Junctions which correspond to an exit specified by means of one Composite Exit Number.

8.2.18.2 Feature roles

8.2.18.2.1 Interchange

- This role is mandatory
- This role is not repeatable.

8.2.18.2.2 Junction

- This role is mandatory.
- This role is repeatable. Conceptually, no particular order of Features playing this role is implied.

8.2.18.3 Description

For the conceptual data model, see Figure 151. The specified Junction(s) is/are the turning point(s) within the Interchange which is/are associated with the attached Composite Exit Number.

Consider a dual carriageway crossing another dual carriageway. Exit 5a is considered to be a single Exit At Interchange even if it includes both the Northbound and Southbound carriageway exits since both lead to the East bound carriageway. This Exit At Interchange has a single Composite Exit Number (5a) but two Junctions – one where you turn off from Northbound and the other where you turn off from Southbound. Another Exit At Interchange would exist for 5b for the exits to Westbound.

8.2.19 Ferry Connection Associated with Administrative Area

8.2.19.1 Definition

Relationship between a Ferry Connection and the Administrative Area in which it is located or to which it is commonly associated.

8.2.19.2 Feature roles

8.2.19.2.1 Order-8 Area

- This role is mandatory.
- This role is not repeatable.

8.2.19.2.2 Ferry Connection

- This role is mandatory.
- This role is not repeatable.

8.2.19.3 Description

For the conceptual data model, see Figure 156.

8.2.20 Ferry Connection Associated with Named Area

8.2.20.1 Definition

Relationship between a Ferry Connection and the Named Area in which it is located or to which it is commonly associated.

8.2.20.2 Feature roles

8.2.20.2.1 Named Area

- This role is mandatory.
- This role is not repeatable.

8.2.20.2.2 Ferry Connection

- This role is mandatory.
- This role is not repeatable.

8.2.20.3 Description

For the conceptual data model, see Figure 156.

8.2.21 Ferry Connection Associated with Built-up Area

8.2.21.1 Definition

Relationship between a Ferry Connection and the Built-up Area in which it is located or to which it is commonly associated.

8.2.21.2 Feature roles

8.2.21.2.1 Built-up Area

- This role is mandatory.
- This role is not repeatable.

8.2.21.2.2 Ferry Connection

- This role is mandatory.
- This role is not repeatable.

8.2.21.3 Description

For the conceptual data model, see Figure 156.

8.2.22 Fork

8.2.22.1 Definition

A fork in the road at which — for an approaching road — more than one departing road could be considered as the natural continuation.

8.2.22.2 Feature roles

8.2.22.2.1 Approaching Road Element

- This role is mandatory.
- This role is not repeatable.

8.2.22.2.2 Junction

- This role is mandatory.
- This role is not repeatable.

8.2.22.2.3 Departing Road Element

- This role is mandatory.
- This role is repeatable. Conceptually, no particular order of Features playing this role is implied.

8.2.22.3 Description

For the conceptual data model, see Figure 144. Forks are typically recognized by the fact that

- the continuations have no sharp bends or kinks at/immediately after the fork point and
- the angle between the (most) right and the (most) left continuation is less than 90°.

Note that forks include road forks with more than two natural continuations, e.g. a three-lane carriageway which branches off at one point into three separate roads, each as a continuation of one lane.

The following situations typically do not represent forks:

- Situations in which all but one of the continuations are slip roads of a crossing at grade having a deceleration lane.
- T-like Junctions.

Forks are relevant for route guidance. They allow for the generation of special route guidance instructions. Therefore, the information to be modelled shall reflect the road user's perception of the road continuation(s) at junctions. This might be ambiguous.

8.2.23 Give Way Regulation

8.2.23.1 Definition

A Manoeuvre at the end of which a driver must give way to other intervening traffic.

8.2.23.2 Feature roles

8.2.23.2.1 First Road Element

- This role is mandatory.
- This role is not repeatable.

8.2.23.2.2 Junction

- This role is mandatory.
- This role is not repeatable.

8.2.23.2.3 Second Road Element

- This role is optional.
- This role is not repeatable.

8.2.23.2.4 Subsequent Road Element

- This role is optional.
- This role is repeatable. Conceptually, Features playing this role shall be ordered.

8.2.23.2.5 Traffic Sign

- This role is optional.
- This role is not repeatable.

8.2.23.3 Description

For the conceptual data model, see Figure 161.

Two different forms of Give Way Regulation exist:

- An implicit form, implied from general traffic rules. For example “traffic coming from the right (or left) has right of way”.
- An explicit form, at a particular Intersection where give way information is indicated by means of traffic signs and which overrule the general traffic rule.

Figure 177 shows some examples of give way traffic signs:



Figure 177 – Examples for Give Way traffic signs

Regulations can involve only a Road Element from which the driver is approaching the Junction and the junction itself.. In such a case the Give Way Regulation is not limited to any particular (sequence of) outbound Road Element(s). In other situations the give way situation can be effective along a path connecting the road element from which the driver is approaching the Junction to an outbound Road Element, and possibly further subsequent Road Elements, in order to connect to the Road Element that is exclusively related to the Give Way Regulation (however not any subsets of fewer Road Elements).

Note that the Relationship Give Way Regulation is not symmetric.

8.2.24 Grade Separated Crossing

8.2.24.1 Definition

A Relationship between Transportation Elements that cross at different elevations that is comprised of an upper Transportation Element, a lower Transportation Element, and the Structure which grade-separates the two.

8.2.24.2 Feature roles

8.2.24.2.1 Upper Part

- This role is optional.
- This role is not repeatable.

8.2.24.2.2 Lower Part

- This role is optional.
- This role is not repeatable.

8.2.24.2.3 Structure

- This role is optional.
- This role is not repeatable.

8.2.24.3 Description

For the conceptual data model, see Figure 149.

8.2.24.4 Constraint

Either the upper or lower Transportation Element may be absent, but not both.

The Relationship is transitive, When 3 Transportation Elements pass over each other at the same location using the same Structure two Relationships will be created; one describing the separation between the lower and the middle element, and one describing the separation between the upper and middle element. The separation between the upper and lower element shall not be explicitly described.

8.2.25 Junction Associated with Administrative Area

8.2.25.1 Definition

Relationship between a Junction and the Administrative Area in which it is located or to which it is commonly associated.

8.2.25.2 Feature roles

8.2.25.2.1 Order-8 Area

- This role is mandatory.
- This role is not repeatable.

8.2.25.2.2 Junction

- This role is mandatory.
- This role is not repeatable.

8.2.25.3 Description

For the conceptual data model, see Figure 154.

8.2.26 Junction Associated with Built-up Area

8.2.26.1 Definition

Relationship between a Junction and the Built-up Area in which it is located or to which it is commonly associated.

8.2.26.2 Feature roles

8.2.26.2.1 Built-up Area

- This role is mandatory.
- This role is not repeatable.

8.2.26.2.2 Junction

- This role is mandatory.
- This role is not repeatable.

8.2.26.3 Description

For the conceptual data model, see Figure 154.

8.2.27 Linear Assignment

8.2.27.1 Definition

Relationship used to link a source Line Feature to target Line Feature(s).

8.2.27.2 Feature roles

8.2.27.2.1 Source

- This role is mandatory.
- This role is not repeatable.

8.2.27.2.2 Target

- This role is mandatory.
- This role is repeatable. Conceptually, no particular order of Features playing this role is implied.

8.2.27.3 Description

For the conceptual data model, see Figure 173.

Linear Assignments are defined as Relationships between a source Line Feature and one or more, entire or partial target Line Features. Linear Assignments have one or more Correspondences, one per source-target combination.

A Correspondence indicates that that part of the Linear Assignment is between an entire source Line Feature and an entire or partial target Line Feature. Its Validity Direction Attribute indicates whether the source Line Feature is in the same or opposite direction as the target Line Feature.

Correspondences are ordered, based on their Correspondence Order Attribute. Only the first and the last target Line Feature can be subject to a partial Correspondence.

The corresponding locations are defined in accordance with the standard for Linear Referencing contained within ISO 19148, Linear referencing. Locations are described with three mandatory components.

1. The first component is the linear element being measured, in this case the target Line Feature.
2. The second component is the measurement method, called the Linear Referencing Method (LRM). The LRM used to measure along the target Line Feature is its Default Linear Referencing Method, and in the case of the target Line Feature being an Anchor Section, its Linear Datum's Default Linear Referencing Method; it can be overridden by an individual Linear Referencing Method Attribute specified for the actual Linear Assignment.
3. The third component is the measured value along the linear element being measured. It is the Linear Position Attribute of the Linear Assignment which is measuring along the target Line Feature.

8.2.27.4 Examples

8.2.27.4.1 Simple assignment with single, entire target in same direction

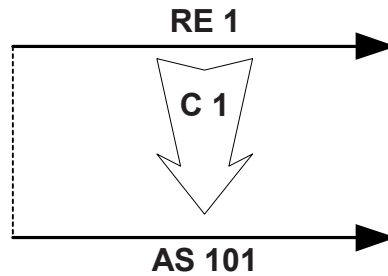

The source Line Feature, Road Element RE1, is assigned to the single, entire target Line Feature, Anchor Section AS101, representing source feature number 1, with a single Correspondence C1 having a Correspondence Order of 1 (one) and a Validity Direction Attribute equal to “same direction”.

8.2.27.4.2 Simple assignment with single, entire target in opposite direction

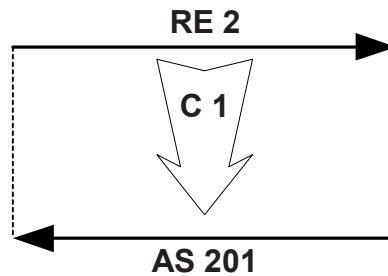

The source Line Feature, Road Element RE2, is assigned to the single, entire target Line Feature, Anchor Section AS201, representing source feature number 1, with a single Correspondence C1 having a Correspondence Order of 1 (one) and a Validity Direction Attribute equal to “opposite direction”.

8.2.27.4.3 Simple assignment with single, partial target

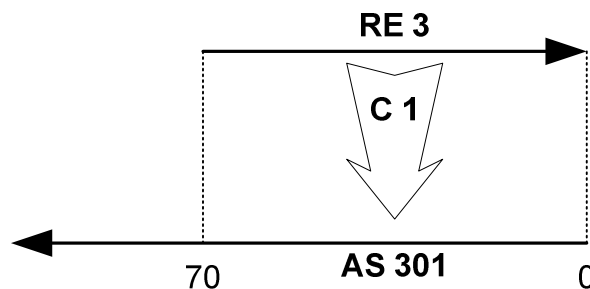

The source Line Feature, Road Element RE3, is assigned to a part of the single target Line Feature, Anchor Section AS301, representing source feature number 1, with a single Correspondence C1 having a Correspondence Order of 1 (one) and a Validity Direction Attribute equal to “opposite direction”.

A composite Linear Position value of 70 (Distance Expression) and “Start” (Start End Flag) for the Linear Assignment indicates that the beginning of the Source corresponds to a location of 70 along the Target. Along with the Validity Direction value, the absence of a second Linear Position value indicates that the end of the Source corresponds to the beginning of the Target. The presence of another composite Linear Position value (with Start End Flag set to “end”) would specify where along the Target the Source ends. The default Location Referencing Method for the Linear Datum containing Anchor Section AS301 is Percentage.

8.2.27.4.4 Simple assignment with multiple target

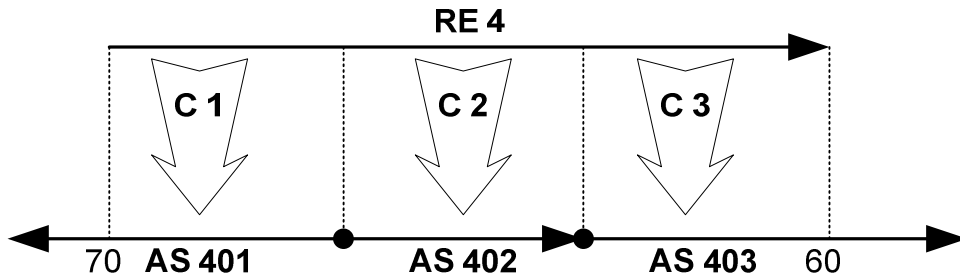

A single, simple assignment can be used to assign a Source to multiple Targets, in this case three: The source Line Feature, Road Element RE4, is assigned to three target Line Features, Anchor Sections AS401, AS402 and AS403, in that order, representing source feature numbers 1, 2, and 3, respectively. Three Simple Correspondences are required: C1, C2, and C3, respectively.

A composite Linear Position value of 70 (Distance Expression) and “Start” (Start End Flag) for the Linear Assignment indicates that the beginning of the Source corresponds to a location of 70 along the first Target, AS401. A composite Linear Position value of 60 (Distance Expression) and “End” (Start End Flag) indicates that the end of the Source corresponds to a location of 60 along the last Target, AS403. Correspondence C1 would have Correspondence Order and Validity Direction values of 1 and “opposite direction”, respectively; C2 would have 2 and “same direction”; C3 would have 3 and “same direction”. The default Location Referencing Method for the Linear Datum containing Anchor Sections AS401, AS402 and AS403 is Percentage.

When mapping the Source to the Target parts, the entire length of RE4 is pro-rated across the combined length of the three Target parts.

Any number of Targets can exist, however only the first and last can be partial.

8.2.28 Manoeuvre (abstract)

8.2.28.1 Definition

Relationship between a first and second Road Element, the Junction connecting them, and optionally any number of additional, subsequent Road Elements. A Manoeuvre shall be either a Priority Manoeuvre, a Right of Way Regulation, or a Restrictive Manoeuvre.

8.2.28.2 Feature roles

8.2.28.2.1 First Road Element

- This role is mandatory.
- This role is not repeatable.

8.2.28.2.2 Junction

- This role is mandatory.
- This role is not repeatable.

8.2.28.2.3 Second Road Element

- This role is mandatory.
- This role is not repeatable.

8.2.28.2.4 Subsequent Road Element

- This role is optional.
- This role is repeatable. Conceptually, Features playing this role shall be ordered.

8.2.28.2.5 Traffic Sign

- This role is optional.
- This role is not repeatable.

8.2.28.3 Description

For the conceptual data model, see Figure 146. As an abstract class, Manoeuvre cannot be instantiated.

8.2.29 Multi-Point Assignment

8.2.29.1 Definition

Relationship used to non-exclusively link source Point Feature(s) to a target Line Feature.

8.2.29.2 Feature roles

8.2.29.2.1 Source

- This role is mandatory.
- This role is repeatable. Conceptually, no particular order of Features playing this role is implied.

8.2.29.2.2 Target

- This role is mandatory.
- This role is not repeatable.

8.2.29.3 Description

For the conceptual data model, see Figure 175.

Multi-Point Assignments are defined as Relationships between one or more source Point Features and the target Line Features. A source Point Feature may be linked to multiple target Line Features, and thus play a role in multiple Multi-Point Assignments.

A Point Assignment indicates that that part of the Multi-Point Assignment is between a source Point Feature and the target Line Feature.

Point Assignments are ordered, based on their Assignment Order Attribute.

The corresponding locations are defined in accordance with the standard for Linear Referencing contained within ISO 19148, Linear referencing [30]. Locations are described with three mandatory components.

- The first component is the linear element being measured, in this case the target Line Feature.
- The second component is the measurement method, called the Linear Referencing Method (LRM). The LRM used to measure along the target Line Feature is its Default Linear Referencing Method, and in the

case of the target Line Feature being an Anchor Section, its Linear Datum's Default Linear Referencing Method; it can be overridden by an individual Linear Referencing Method Attribute specified for the actual Multi-Point Assignment.

- The third component is the measured value along the linear element being measured. It is the Distance Expression Sub-Attribute of the Point Assignment Attribute which is measuring along the target Line Feature.

8.2.30 Overhead Structure along Road Element

8.2.30.1 Definition

The indication of a linear Structure spanning a Road Element or part of it.

8.2.30.2 Feature roles

8.2.30.2.1 Structure

- This role is mandatory.
- This role is not repeatable.

8.2.30.2.2 Road Element

- This role is mandatory.
- This role is not repeatable.

8.2.30.3 Description

For the conceptual data model, Figure 165.

Overhead structures subject to this Relationship include road or rail bridges, gantries carrying road signs that cross entirely or partially the road, etc.

8.2.31 Pedestrian Crossing along Road Element

8.2.31.1 Definition

The presence of a Pedestrian Crossing along a Road Element.

8.2.31.2 Feature roles

8.2.31.2.1 Pedestrian Crossing

- This role is mandatory.
- This role is not repeatable.

8.2.31.2.2 Road Element

- This role is mandatory.
- This role is not repeatable.

8.2.31.3 Description

For the conceptual data model, see Figure 167.

8.2.32 Pedestrian Crossing has Entry Point

8.2.32.1 Definition

The relation between a non-street level Pedestrian Crossing and its Entry Point(s).

8.2.32.2 Feature roles

8.2.32.2.1 Pedestrian Crossing

- This role is mandatory.
- This role is not repeatable.

8.2.32.2.2 Entry Point

- This role is mandatory.
- This role is repeatable. Conceptually, no particular order of Features playing this role is implied.

8.2.32.3 Description

For the conceptual data model, see Figure 163.

A Pedestrian Crossing may have zero or more Entry Points which give access via stairs, elevators, etc., situated either out-door or in-door. Entry Points are modelled by the Entry Point Feature Class.

8.2.33 Pedestrian Square connected to Pedestrian Crossing

8.2.33.1 Definition

The presence of a Enclosed Traffic Area is connected to a Pedestrian Crossing, or Entry Point of a Pedestrian Crossing, as part of a pedestrian transportation network.

8.2.33.2 Feature roles

8.2.33.2.1 Pedestrian Square

- This role is mandatory.
- This role is not repeatable.

8.2.33.2.2 Pedestrian Crossing Part

- This role is mandatory.
- This role is not repeatable.

8.2.33.3 Description

For the conceptual data model, see Figure 162.

This Relationship captures topological links between Pedestrian Squares (sub-type of Enclosed Traffic Area) and Pedestrian Crossings and/or Entry Points of a Pedestrian Crossing. Entry Points of Pedestrian Crossings are modelled by the Entry Point Feature Class, which are related to Pedestrian Crossings by means of the Pedestrian Crossing has Entry Point Relationship.

8.2.34 Place within Place

8.2.34.1 Definition

Relationship between a Administrative Place and another Administrative Place in which it is located.

8.2.34.2 Feature roles

8.2.34.2.1 Contained Place

- This role is mandatory.
- This role is not repeatable.

8.2.34.2.2 Containing Place

- This role is mandatory.
- This role is not repeatable.

8.2.34.3 Description

For the conceptual data model, see Figure 160. This Relationship specifies the fact that at least part of the contained Place is contained within the containing Place according to a particular classification scheme. The type of classification scheme may be specified by the Attribute Place within Place Classification.

8.2.35 Right of Way Regulation

8.2.35.1 Definition

A Manoeuvre which has the right of way over other intervening traffic.

8.2.35.2 Feature roles

8.2.35.2.1 First Road Element

- This role is mandatory.
- This role is not repeatable.

8.2.35.2.2 Junction

- This role is mandatory.
- This role is not repeatable.

8.2.35.2.3 Second Road Element

- This role is mandatory.
- This role is not repeatable.

8.2.35.2.4 Subsequent Road Element

- This role is optional.
- This role is repeatable. Conceptually, Features playing this role shall be ordered.

8.2.35.2.5 Traffic Sign

- This role is optional.
- This role is not repeatable.

8.2.35.3 Description

For the conceptual data model, see Figure 146.

Two different forms of Right of Way Regulation exist:

- An implicit form, implied from general traffic rules. For example “Traffic coming from the right (or left) has the right of way”.
- An explicit form, at a particular Intersection where right-of-way is indicated by means of traffic signs which overrule the general traffic rules.

Figure 178 shows some examples of traffic signs granting right of way.



Figure 178 — Examples for Right of Way traffic signs

Regulations granting the right of way always involve a Road Element from which the driver is approaching the junction and a Road Element leaving the junction. In some situations the right of way situation can also be effective along a path connecting the road element from which the driver is approaching the junction to an outbound road element.

An example of a Right of Way Regulation is given in Figure 179, including Traffic Sign Features (optional). Note that the Relationship Right of Way Regulation is not symmetric.

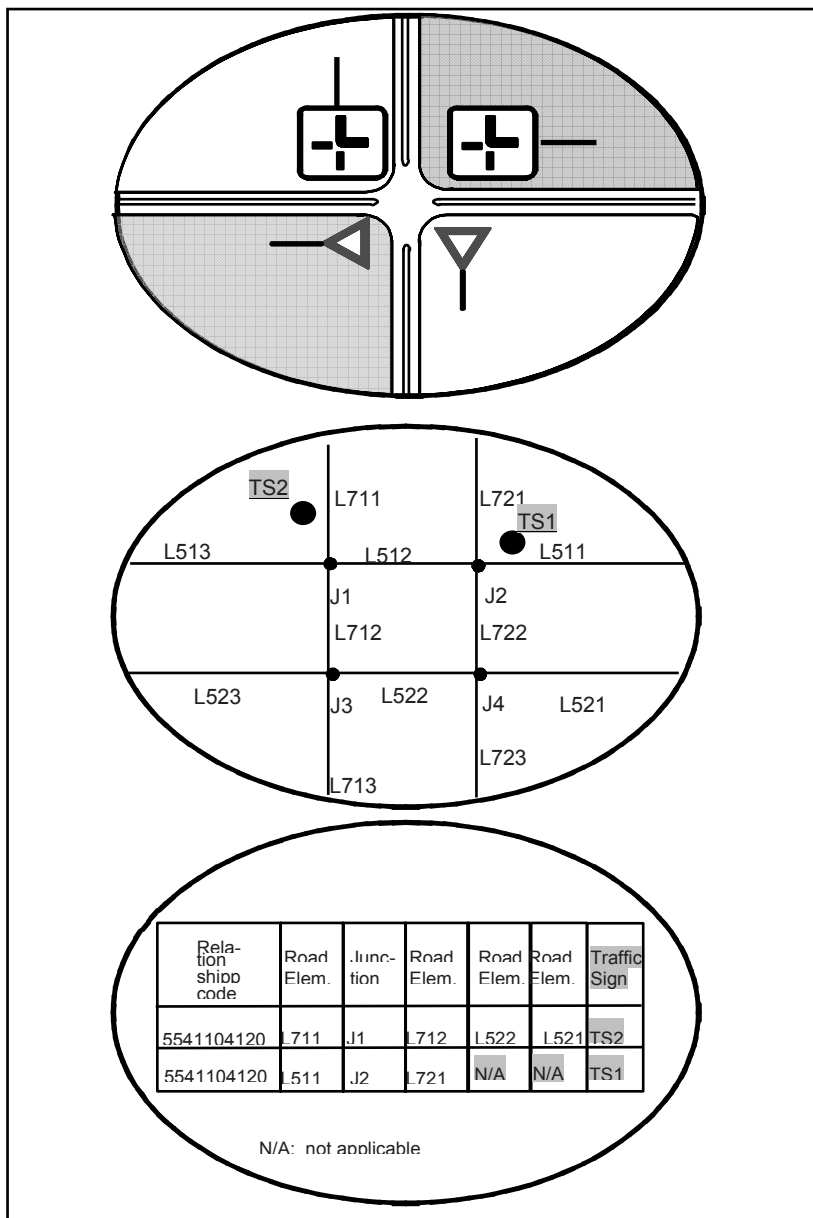

Figure 179 — Example of Right of Way Regulation

8.2.36 Prohibited Manoeuvre

8.2.36.1 Definition

A Manoeuvre which is physically possible but which is “prohibited” by means of legal measures, as denoted by traffic signs.

8.2.36.2 Feature roles

8.2.36.2.1 First Road Element

- This role is mandatory.
- This role is not repeatable.

8.2.36.2.2 Junction

- This role is mandatory.
- This role is not repeatable.

8.2.36.2.3 Second Road Element

- This role is mandatory.
- This role is not repeatable.

8.2.36.2.4 Subsequent Road Element

- This role is optional.
- This role is repeatable. Conceptually, Features playing this role shall be ordered.

8.2.36.2.5 Traffic Sign

- This role is optional.
- This role is not repeatable.

8.2.36.3 Description

For the conceptual data model, see Figure 146.

Three different forms of prohibited Manoeuvres can be distinguished. Examples are given in Figure 181. These are:

- Prohibited because of one-way traffic flow on one of the Road Elements of the Manoeuvres. These are not required to be modelled as Prohibited Manoeuvres.
- All prohibited Manoeuvres, indicated by traffic signs and not resulting from one-way situations on one of the Road Elements of the Manoeuvres. These are required to be modelled as Prohibited Manoeuvres. Examples for traffic signs indicating these situations are given in Figure 180.
- All prohibited Manoeuvres, neither resulting from one way situations nor explicitly indicated by traffic signs, but resulting from the road network. These are required to be either modelled as Prohibited Manoeuvres or as Restricted Manoeuvres.

An example of the construction of a Prohibited Manoeuvre is given in Figure 182.

Note that a Prohibited Manoeuvre Relationship is not necessarily symmetrical: i.e. the reverse direction Manoeuvre need not be prohibited.

Attributes may be added to this Relationship for further description. For instance, it may be used in conjunction with the Attribute Validity Period to define changing circumstances through time.

EXAMPLE Prohibited Manoeuvre only during Peak Period.

The Prohibited Manoeuvre may also be used in conjunction with the Attribute Vehicle Type for which the Manoeuvre is prohibited.

8.2.36.4 Constraints

If a Road Element is the first Road Element in a Prohibited Manoeuvre, then it cannot be the first element in a Restricted Manoeuvre with the same Junction.

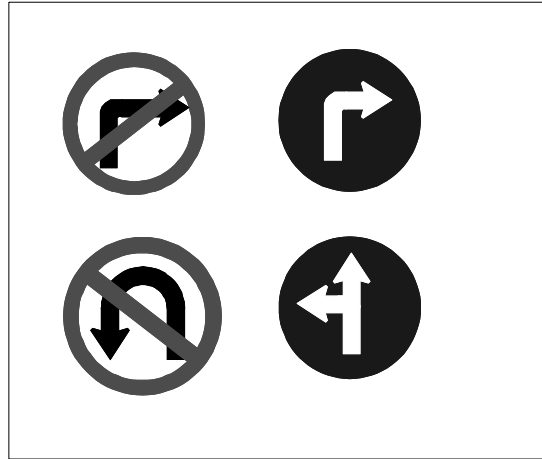

Figure 180 — Traffic Signs for Prohibited Manoeuvre and Restricted Manoeuvre

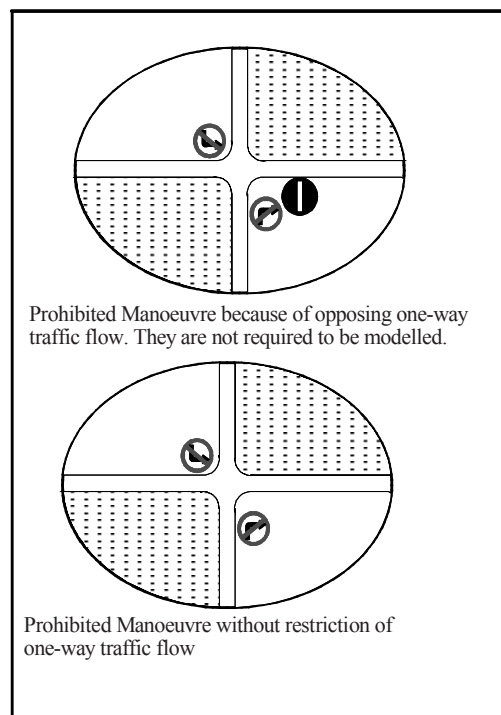

Figure 181 — Examples of Prohibited Manoeuvres

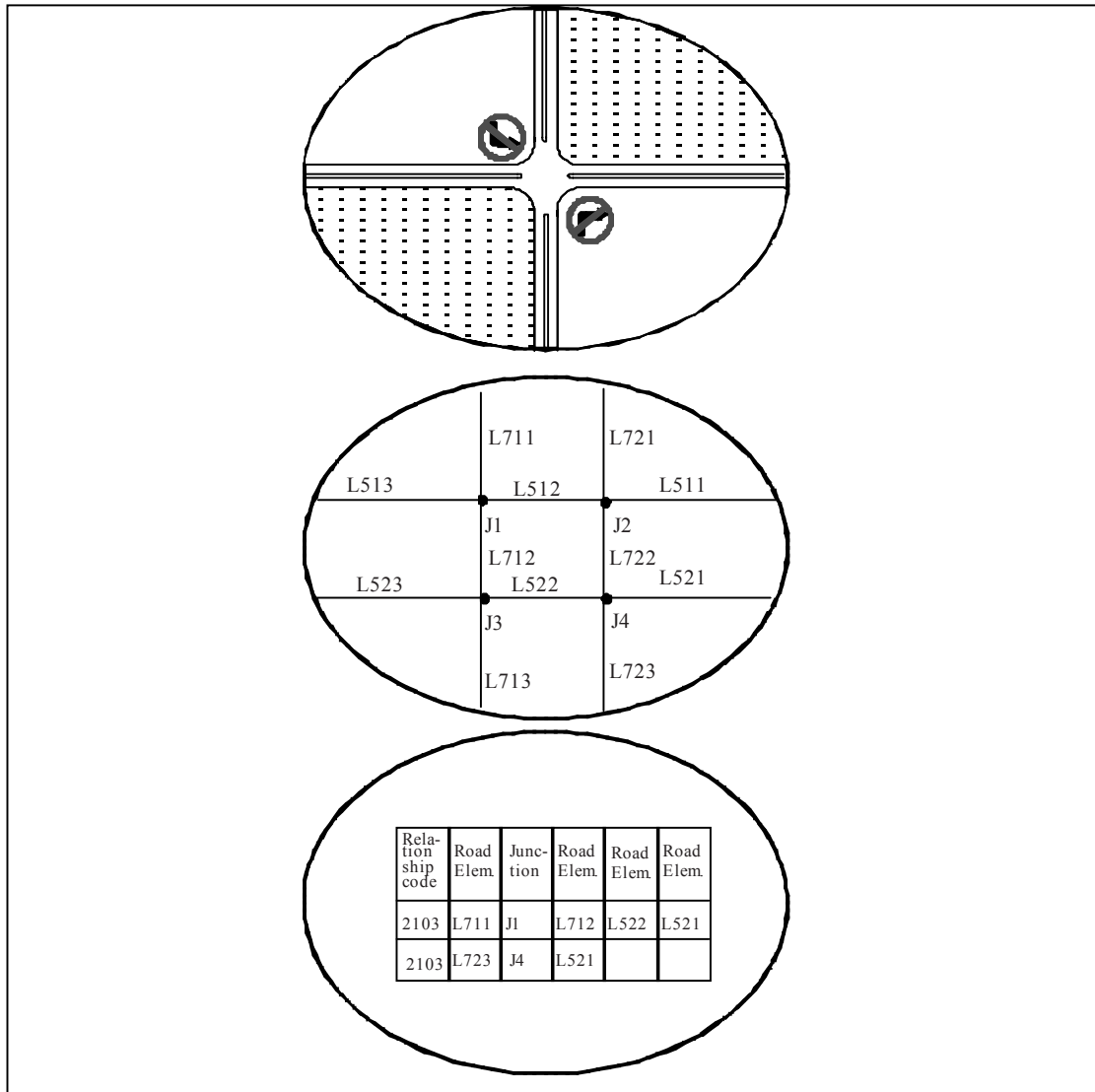

Figure 182 — Representation of a Prohibited Manoeuvre

8.2.37 Public Transport Connection

8.2.37.1 Definition

The presence of two Stop Points served by the same public transport mode are consecutive stops of a public transport Line.

8.2.37.2 Feature roles

8.2.37.2.1 Originating Stop Point

- This role is mandatory.
- This role is not repeatable.

8.2.37.2.2 Connected Stop Point

- This role is mandatory.
- This role is not repeatable.

8.2.37.3 Description

For the conceptual data model, see Figure 158.

Public Transport Connection is modelling the topological network of connected Stop Points by means of bi-valent relations per mode.

This Relationship is non-symmetrical, i.e. the order of Stop Points is significant as it links an originating Stop Point with a connected Stop Point.

8.2.38 Public Transport Point along Route Link

8.2.38.1 Definition

Relationship between a Public Transport Point and the Route Link to which it belongs.

8.2.38.2 Feature roles

8.2.38.2.1 Public Transport Point

- This role is mandatory.
- This role is not repeatable.

8.2.38.2.2 Route Link

- This role is mandatory.
- This role is not repeatable.

8.2.38.3 Description

For the conceptual data model, see Figure 158.

8.2.39 Restricted Manoeuvre

8.2.39.1 Definition

A Manoeuvre which is explicitly permitted by means of legal measures, as denoted by traffic signs.

8.2.39.2 Feature roles

8.2.39.2.1 First Road Element

- This role is mandatory.
- This role is not repeatable.

8.2.39.2.2 Junction

- This role is mandatory.
- This role is not repeatable.

8.2.39.2.3 Second Road Element

- This role is mandatory.
- This role is not repeatable.

8.2.39.2.4 Subsequent Road Element

- This role is optional.
- This role is repeatable. Conceptually, Features playing this role shall be ordered.

8.2.39.2.5 Traffic Sign

- This role is optional.
- This role is not repeatable.

8.2.39.3 Description

For the conceptual data model, see Figure 146.

Whether the Restricted Manoeuvre is the only possibility to manoeuvre from the specified Road Element via the specified Junction cannot be concluded from the Relationship. The full description can be derived by taking all Restricted Manoeuvre Relationships where the first specified Road Element and the Junction play the same role.

Three different forms of restricted Manoeuvre can be distinguished:

- Restricted because of one-way traffic flow on one of the roads not belonging to the restricted Manoeuvre but accessing the junction of this restricted Manoeuvre. These situations are not required to be modelled as Restricted Manoeuvre.
- All restricted Manoeuvres, indicated by traffic signs and not resulting from one-way traffic flow on one of the roads not belonging to the restricted Manoeuvre but accessing the junction of this restricted Manoeuvre. These are required to be modelled as Restricted Manoeuvres. Examples for traffic signs indicating these situations are given in Figure 180.
- All restricted Manoeuvres, neither resulting from one-way situations nor explicitly indicated by traffic signs, but resulting from the road network. These are required to be either modelled as Restricted Manoeuvres or as Prohibited Manoeuvres.

Note that a Restricted Manoeuvre Relationship is not necessarily symmetrical: i.e. the reverse direction Manoeuvre need not be restricted.

Attributes may be added to this Relationship for further description. For instance, it may be used in conjunction with the Attribute Validity Period to define changing circumstances through time.

EXAMPLE Restricted Manoeuvre only during Peak Period.

The Restricted Manoeuvre may also be used in conjunction with the Attribute Vehicle Type for which the Manoeuvre is restricted.

8.2.39.4 Constraints

If a Road Element is the first Road Element in a Restricted Manoeuvre, then it cannot be the first element in a Prohibited Manoeuvre with the same Junction..

8.2.40 Road Element Associated with Administrative Area

8.2.40.1 Definition

Relationship between a Road Element and the Administrative Area in which it is located or with which it is commonly associated.

8.2.40.2 Feature roles

8.2.40.2.1 Order-8 Area

- This role is mandatory.
- This role is not repeatable.

8.2.40.2.2 Road Element

- This role is mandatory.
- This role is not repeatable.

8.2.40.3 Description

For the conceptual data model, see Figure 153.

8.2.41 Road Element Associated with Built-up Area

8.2.41.1 Definition

Relationship between a Road Elements and the Built-up Area in which it is located or with which it is commonly associated.

8.2.41.2 Feature roles

8.2.41.2.1 Built-up Area

- This role is mandatory.
- This role is not repeatable.

8.2.41.2.2 Road Element

- This role is mandatory.
- This role is not repeatable.

8.2.41.3 Description

For the conceptual data model, see Figure 153.

8.2.42 Road Element Associated with District

8.2.42.1 Definition

Relationship between a Road Element and the Census District, Elective District, Emergency Medical Dispatch District, Fire Dispatch District, Phone District, Police District, Postal District or School District with which it is commonly associated.

8.2.42.2 Feature roles

8.2.42.2.1 District

- This role is mandatory.
- This role is not repeatable.

8.2.42.2.2 Road Element

- This role is mandatory.
- This role is not repeatable.

8.2.42.3 Description

For the conceptual data model, see Figure 153.

8.2.43 Road Element Associated with Named Area

8.2.43.1 Definition

Relationship between a Road Element and the Named Area with which it is commonly associated.

8.2.43.2 Feature roles

8.2.43.2.1 Named Area

- This role is mandatory.
- This role is not repeatable.

8.2.43.2.2 Road Element

- This role is mandatory.
- This role is not repeatable.

8.2.43.3 Description

For the conceptual data model, see Figure 153.

8.2.44 Road Element belonging to Service

8.2.44.1 Definition

Relationship between a Road Element and the Service to which it belongs.

8.2.44.2 Feature roles

8.2.44.2.1 Road Element

- This role is mandatory.
- This role is not repeatable.

8.2.44.2.2 Service

- This role is mandatory.
- This role is not repeatable.

8.2.44.3 Description

For the conceptual data model, see Figure 153.

8.2.45 Road Element leading to Enclosed Traffic Area

8.2.45.1 Definition

Relationship between a Road Element and the Enclosed Traffic Area to which it leads.

8.2.45.2 Feature roles

8.2.45.2.1 Road Element

- This role is mandatory.
- This role is not repeatable.

8.2.45.2.2 Enclosed Traffic Area

- This role is mandatory.
- This role is not repeatable.

8.2.45.3 Description

For the conceptual data model, see Figure 157.

8.2.46 Route Link along Road Element

8.2.46.1 Definition

Relationship between a Route Link and the Road Element to which all or parts of the Route Link belongs.

8.2.46.2 Feature roles

8.2.46.2.1 Route Link

- This role is mandatory.
- This role is not repeatable.

8.2.46.2.2 Road Element

- This role is mandatory.
- This role is not repeatable.

8.2.46.3 Description

This relation between Route Link and Road Element is many to many. One Road Element can contain more than one Route Link and one Route Link can contain more than one Road Element. Each pair of Route Link and Road Element is represented as a separate Relationship. For the conceptual data model, see Figure 158.

8.2.47 Service along Road

8.2.47.1 Definition

Relationship between a Service and the Road along which it is situated.

8.2.47.2 Feature roles

8.2.47.2.1 Road

- This role is mandatory.
- This role is not repeatable.

8.2.47.2.2 Service

- This role is mandatory.
- This role is not repeatable.

8.2.47.3 Description

For the conceptual data model, see Figure 157.

8.2.48 Service along Road Element

8.2.48.1 Definition

Relationship between a Service and the Road Element along which it is situated.

8.2.48.2 Feature roles

8.2.48.2.1 Road Element

- This role is mandatory.
- This role is not repeatable.

8.2.48.2.2 Service

- This role is mandatory.
- This role is not repeatable.

8.2.48.3 Description

For the conceptual data model, see Figure 157.

8.2.49 Service Associated with Administrative Area

8.2.49.1 Definition

Relationship between a Service and the Administrative Area in which it is located or to which it is commonly associated.

8.2.49.2 Feature roles

8.2.49.2.1 Order-8 Area

- This role is mandatory.
- This role is not repeatable.

8.2.49.2.2 Service

- This role is mandatory.
- This role is not repeatable.

8.2.49.3 Description

For the conceptual data model, see Figure 155.

8.2.50 Service Associated with Built-up Area

8.2.50.1 Definition

Relationship between a Service and the Built-up Area in which it is located or to which it is commonly associated.

8.2.50.2 Feature roles

8.2.50.2.1 Built-up Area

- This role is mandatory.
- This role is not repeatable.

8.2.50.2.2 Service

- This role is mandatory.
- This role is not repeatable.

8.2.50.3 Description

For the conceptual data model, see Figure 155.

8.2.51 Service Associated with Named Area

8.2.51.1 Definition

Relationship between a Service and the Named Area in which it is located or to which it is commonly associated.

8.2.51.2 Feature roles

8.2.51.2.1 Named Area

- This role is mandatory.
- This role is not repeatable.

8.2.51.2.2 Service

- This role is mandatory.
- This role is not repeatable.

8.2.51.3 Description

For the conceptual data model, see Figure 155.

8.2.52 Service at Intersection

8.2.52.1 Definition

Relationship between a Service and the Intersection at which it is situated.

8.2.52.2 Feature roles

8.2.52.2.1 Intersection

- This role is mandatory.
- This role is not repeatable.

8.2.52.2.2 Service

- This role is mandatory.
- This role is not repeatable.

8.2.52.3 Description

For the conceptual data model, see Figure 157.

8.2.53 Service at Junction

8.2.53.1 Definition

Relationship between a Service and the Junction at which it is situated.

8.2.53.2 Feature roles

8.2.53.2.1 Junction

- This role is mandatory.
- This role is not repeatable.

8.2.53.2.2 Service

- This role is mandatory.
- This role is not repeatable.

8.2.53.3 Description

For the conceptual data model, see Figure 157.

8.2.54 Service related to Service

8.2.54.1 Definition

Relationship between one Service and another Service to which it functionally belongs or to which it is related.

8.2.54.2 Feature roles

8.2.54.2.1 Service

- This role is mandatory.
- This role is not repeatable.

8.2.54.2.2 Associated Service

- This role is mandatory.
- This role is not repeatable.

8.2.54.3 Description

For the conceptual data model, see Figure 155.

8.2.55 Signpost Information

8.2.55.1 Definition

A single Signpost or set of related Signposts situated on a particular Road Element which correspond to a particular Manoeuvre and describe in textual or graphical form the signpost information.

EXAMPLE A Place name or road number.

8.2.55.2 Feature roles

8.2.55.2.1 Signpost

- This role is mandatory.
- This role is repeatable. Conceptually, no particular order of Features playing this role is implied.

8.2.55.2.2 Locating Road Element

- This role is mandatory.
- This role is not repeatable.

8.2.55.2.3 Destination Road Element

- This role is mandatory.
- This role is not repeatable.

8.2.55.3 Description

For the conceptual data model, see Figure 150. The logical information on a (set of) signpost(s) is expressed as a Relationship between:

- the (set of) Signpost(s),
- the locating Road Element along which the (set of) Signpost(s) is located,
- The destination Road Element which is the first Road Element leading exclusively to the destination indicated on the Signpost.

In practice the number of “physical” signposts referring to the same situation is of no importance. All the information can be considered as one “logical” signpost, belonging to this particular Manoeuvre.

Data items on signposts of interest include:

- names of towns, villages or other names (e.g. names of industrial areas, conference centres, tourist attractions) and area numbers (e.g. S109 in Amsterdam),
- route numbers,
- exit numbers,
- directional arrows.

8.2.55.4 Notes

Names and area number information shall be attached to the Relationship via the Destination Location Attribute, Route Numbers via the Route Number on Sign Attribute and exit numbers via the Exit Number Attribute, all of which are contained within the Composite Attribute Destination Info On Traffic Sign. A Directional arrow may be included in the Relationship via the Direction Attribute.

Some examples are given in Figure 183.

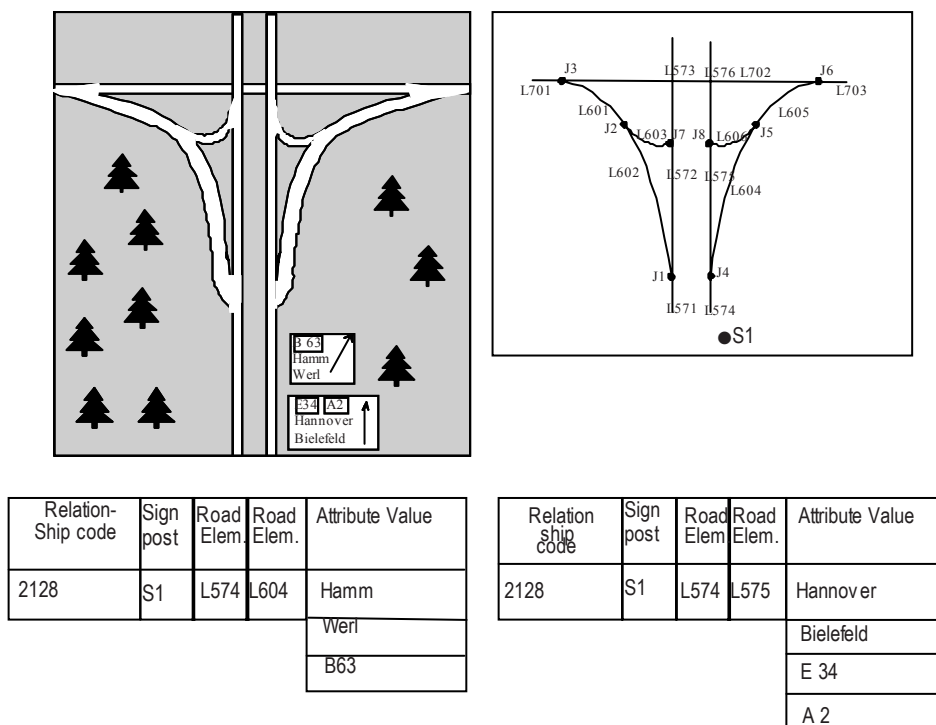

Figure 183 — Example of Signpost Information

8.2.56 Stop Point along Road Element

8.2.56.1 Definition

Relationship between a Stop Point and a nearby Road Element.

8.2.56.2 Feature roles

8.2.56.2.1 Stop Point

- This role is mandatory.
- This role is not repeatable.

8.2.56.2.2 Road Element

- This role is mandatory.
- This role is not repeatable.

8.2.56.3 Description

For the conceptual data model, see Figure 158. This Relationship is used to indicate in which street the Stop Point is located. The Attribute Distance Expression could be used to give a more accurate position of the Stop Point.

8.2.57 Stop Point along Route

8.2.57.1 Definition

Relationship between a Stop Point and the Route to which it belongs.

8.2.57.2 Feature roles

8.2.57.2.1 Stop Point

- This role is mandatory.
- This role is not repeatable.

8.2.57.2.2 Route

- This role is mandatory.
- This role is not repeatable.

8.2.57.3 Description

For the conceptual data model, see Figure 158.

8.2.58 Stop Point at Junction

8.2.58.1 Definition

Relationship between a Stop Point and a nearby Junction.

8.2.58.2 Feature roles

8.2.58.2.1 Stop Point

- This role is mandatory.
- This role is not repeatable.

8.2.58.2.2 Junction

- This role is mandatory.
- This role is not repeatable.

8.2.58.3 Description

For the conceptual data model, see Figure 158.

In most cases a Stop Point has a relation with a Road Element. In the case where a bus stop is located on a Junction between two Road Elements, the Stop Point could be related to the Junction.

8.2.59 Stop Point located near Service

8.2.59.1 Definition

Relationship between a Stop Point and the Service that is nearby or for which it is a reference point.

8.2.59.2 Feature roles

8.2.59.2.1 Stop Point

- This role is mandatory.
- This role is not repeatable.

8.2.59.2.2 Service

- This role is mandatory.
- This role is not repeatable.

8.2.59.3 Description

This relation will be typically used to indicate which public transport stops are in the neighbourhood of a service.

EXAMPLE "Which bus stop or tram stop could be used to travel to a theatre".

This relation is many to many: a bus stop could be the reference location for more than one service and a service could have more than one bus or tram stops. Each pair of Stop Point and Service is represented as a separate Relationship. For the conceptual data model, see Figure 158.

8.2.60 Through Route

8.2.60.1 Definition

A relation between two or more Road Elements that describes the continuation of the road.

8.2.60.2 Feature roles

8.2.60.2.1 Beginning Road Element

- This role is mandatory.
- This role is not repeatable.

8.2.60.2.2 Continuing Road Element

- This role is mandatory.
- This role is not repeatable.

8.2.60.2.3 Subsequent Road Element

- This role is optional.
- This role is repeatable. Conceptually, Features playing this role shall be ordered.

8.2.60.3 Description

For the conceptual data model, see Figure 148.

The Through Route Relationship is useful for Route Guidance.

The upper part of Figure 184 shows a schematic representation of the road as seen in reality, while the bottom part is the “digital” representation. The digital representation might imply incorrectly that R2 is the natural continuation of R1. To rectify this, the Through Route relation can be used.

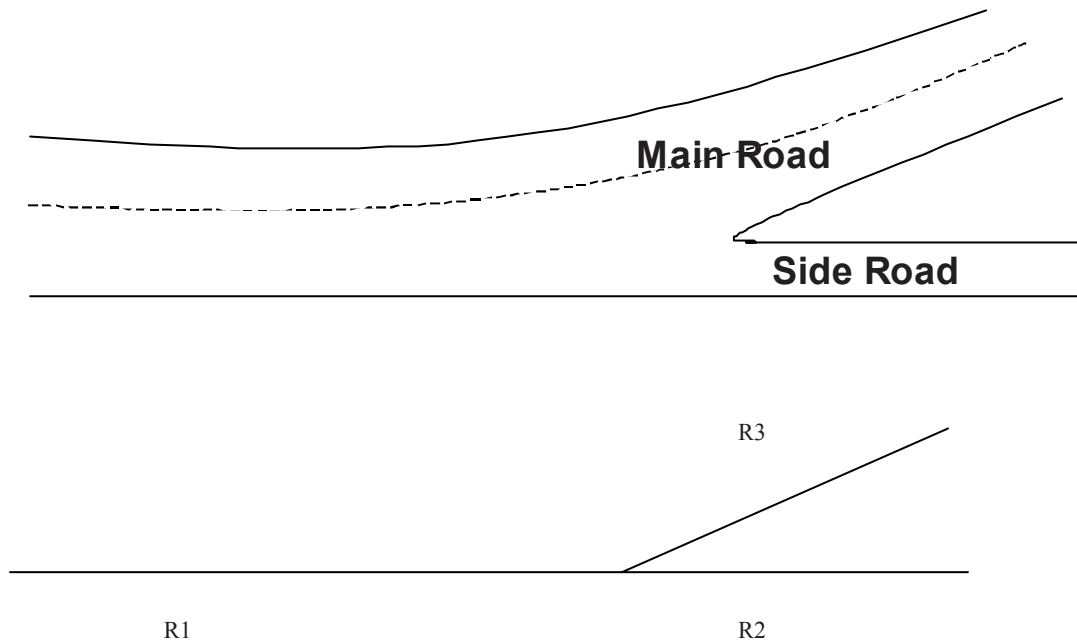

Figure 184— Example of a Through Route

8.2.61 Toll Route

8.2.61.1 Definition

The relation between the Toll Location, which represents the point of toll payment, the first Road Element or Ferry Connection of the Toll Route, the last Road Element or Ferry Connection of the Toll Route and possible intermediate Road Element or Ferry Connections if these are necessary to uniquely describe the Toll Route. The relation represents (a section of) a Toll Route with a certain fee to be paid.

8.2.61.2 Feature roles

8.2.61.2.1 Toll location

- This role is mandatory.
- This role is not repeatable.

8.2.61.2.2 First Toll Route Part

- This role is mandatory.
- This role is not repeatable.

8.2.61.2.3 Selective Intermediate Toll Route Part

- This role is optional.
- This role is repeatable. Conceptually, Features playing this role shall be ordered.

8.2.61.2.4 Last Toll Route Part

- This role is mandatory.
- This role is not repeatable.

8.2.61.3 Description

For the conceptual data model, see Figure 145. The Relationship specifies an ordered set of two or more Road Elements or Ferry Connections representing a Toll Route associated with a certain toll payment to be paid when traveling the Toll Route. The reverse combination of two Road Elements may relate to a different toll payment and is to be specified by a separate Relationship. If the Toll Route is not uniquely described by the first and last Road Element of the Toll Route (e.g., in between two Road Elements several Toll Routes exist, each associated with a different toll payment), intermediate Road Elements shall be specified to uniquely describe the Toll Route. The toll payment may be specified by the Toll Attribute.

8.2.62 Traffic Light Along Road Element

8.2.62.1 Definition

The presence of a Traffic Light relevant for traffic moving along a Road Element.

8.2.62.2 Feature roles

8.2.62.2.1 Traffic Light

- This role is mandatory.
- This role is not repeatable.

8.2.62.2.2 Road Element

- This role is mandatory.
- This role is not repeatable.

8.2.62.3 Description

For the conceptual data model, see Figure 152.

8.2.63 Traffic Light Regulation

8.2.63.1 Definition

The presence of a Traffic Light at a Road Element entering a Junction.

8.2.63.2 Feature roles

8.2.63.2.1 Road Element

- This role is mandatory.
- This role is not repeatable.

8.2.63.2.2 Junction

- This role is mandatory.
- This role is not repeatable.

8.2.63.2.3 Traffic Light

- This role is optional.
- This role is repeatable. Conceptually, no particular order of Features playing this role is implied.

8.2.63.3 Description

For the conceptual data model, see Figure 166.

For traffic lights present at Junctions, the traffic light regulation involves an individual Road Element from which the driver is approaching the Junction regulated by the traffic lights in question. Driving direction to which a number of special traffic lights apply and information where these signalling units are positioned relative to the road can be modelled through the Composite Attribute Traffic Light Info. See Figure 185 for an example.

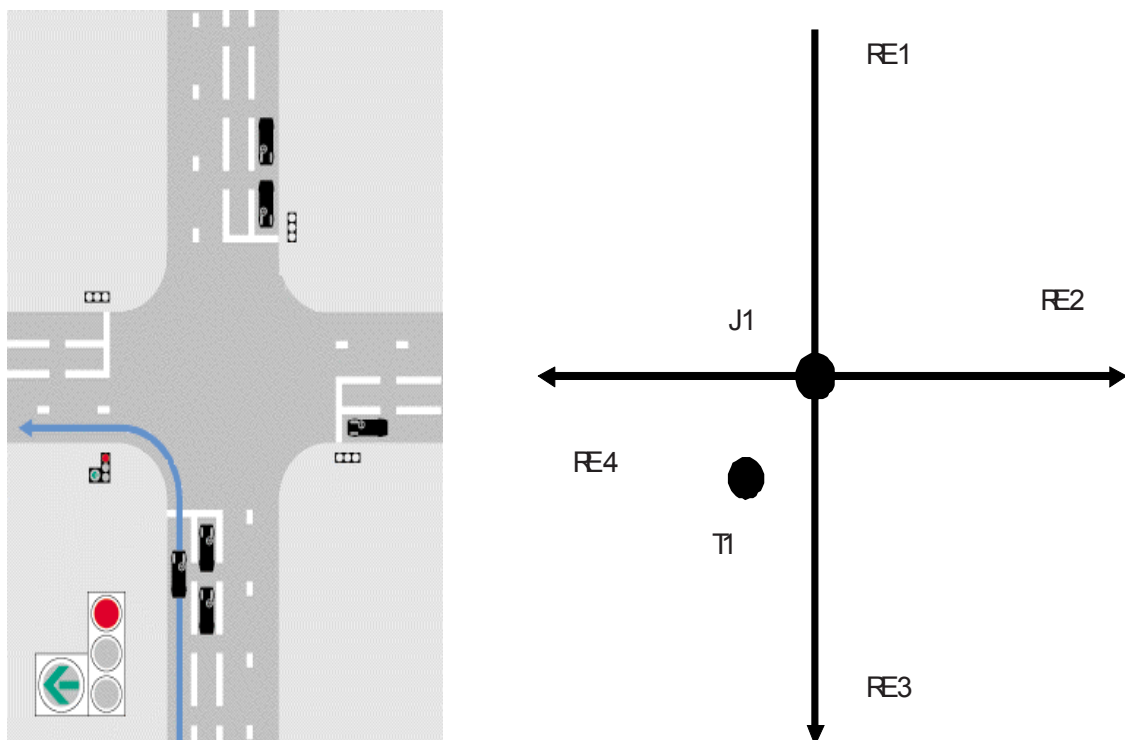

The enlarged traffic lights can be expressed as
(plus Traffic Light Info attributes in brackets): RE3/J1/ T1 (0/2) (512/2)

Figure 185 — Example of Traffic Light Regulation

8.2.64 Traffic Sign Along Road Element

8.2.64.1 Definition

The presence of a Traffic Sign relevant for traffic moving along a Road Element.

8.2.64.2 Feature roles

8.2.64.2.1 Traffic Sign

- This role is mandatory.
- This role is not repeatable.

8.2.64.2.2 Road Element

- This role is mandatory.
- This role is not repeatable.

8.2.64.3 Description

For the conceptual data model, see Figure 152.

9 Feature representation rules

9.1 Generic specifications

9.1.1 Introduction

The objective of the Feature Representation Rules is to specify how individual Features should be represented by the different Feature Categories and how Simple Features shall be represented by the cartographic primitives: Nodes, Edges, Faces, Dots, Polylines and Polygons.

9.1.2 Feature Categories

The Overall Conceptual Data Model (Figure 8) illustrates that in each of the three topology types Features are divided into Complex Features and Simple Features. It also shows that Simple Features can be either zero-dimensional (Point Features), one-dimensional (Line Features), or two-dimensional (Area Features). Depending on the topology type, a Point Feature is represented by one Node or by one Dot, a Line Feature is represented by one or more Edges or by one Polyline and an Area Feature is a Feature represented by one or more Faces, by one or more Edges (representing its boundary) or by one Polygon. The fact that each of these Feature Categories can be represented in more than one way in a GDF relates to the different types of topology that can be represented (see sub-clause 5.2.3). Constraints are defined for the use of these alternative representations (see Figure 8, Figure 9, Figure 11, Figure 12, Figure 13, Figure 14, Figure 15, Figure 21, Figure 22, Figure 23, and sub-clause 9.1.5).

For the sake of simplicity, the terms “Point Features, Line Features, Area Features and Complex Features” are often abbreviated to “Points, Lines, Areas and Complexes”. These together form the four Feature categories.

Features belonging to the same Feature Class (for instance Buildings) need not all belong to the same Feature Category. For example, one Building may be seen as a Point Feature, represented by an (isolated) Node, whereas another Building may be an Area Feature, represented by one or more Faces or by one or more Edges.

9.1.3 Types of topology

The following types of topology are defined in GDF:

1 Non-explicit topology:

- Simple Features are based on Dots, Polylines and Polygons.
- Topological relations are only defined via coordinate values of the Dots, Polylines and Polygons.

2 Non-Planar topology:

- Simple Features are based on Nodes and Edges.
- Topological relations between these two cartographic primitives are explicitly defined.
- Area Features are not fully topologically integrated.

3 Planar topology:

- Simple Features are based on Nodes, Edges and Faces.
- Topological relations between all cartographic primitives are explicitly defined.

Non-planar topology and planar topology are collectively referred to as topologically structured representations.

9.1.4 Levels of representation

9.1.4.1 Level 0: the geometry

Level 0 describes the geometry of the map in terms of the cartographic primitives. It breaks the map down into its most basic form for representation. All elements of the map may or may not be represented by a planar graph, i.e. on a single plane.

Curved shapes have to be represented by a series of segmented straight lines. These segments, however, are not represented in an explicit form. Instead, a segmented shape between the first geometry point and the last geometry point of an Edge, Polyline, or Polygon is described by an ordered sequence of Intermediate Points. Each pair of consecutive Intermediate Points bounds exactly one Segment.

For an Edge, the first geometry point is the geometry of the From Node and the last geometry point is the geometry of the To Node. For a Polyline and Polygon, the sequence of the first geometry point, zero or more intermediate points and the last geometry point collectively constitute the vertices of the segmented shape.

In addition to the core positional dimensions X, Y, and Z (optional), 3-dimensional object elevation as well as temporal existence may be specified for the cartographic primitives Dot, Polyline, and Polygon in non-explicit topology.

9.1.4.2 Level 1: the Simple Features

Level 1 describes the map in terms of Simple Features. These may take the form of either Points, Lines or Areas.

EXAMPLE 1 A Road Element is a Simple Line Feature.

EXAMPLE 2 A Junction is a Simple Point Feature.

On level 1, the level 0 elements receive a “real world” significance. For non-explicit topology Features, the notion of Level 0 is artificial due to the 1:1 relation between a Feature and its representation by a cartographic primitive.

Non-planar situations (e.g. a grade separated crossing between two roads) need to be represented on Level 1 as non-planar.

The following Relationships exist between Level 1 and the associated cartographic primitives (Level 0):

- Each Point on Level 1 must be represented by one Node on Level 0 or one Dot, except for topologically structured Points with no geometry, in which case the Point does not have a corresponding Node.
- Each Line on Level 1 must be represented by one or more Edges on Level 0 or one Polyline, except for topologically structured Lines without geometry, in which case the Line does not have any corresponding Edge(s).
- Each Area on level 1 must be represented by one or more Faces on Level 0, one or more Edges on Level 0 (describing the Area's boundary) or one Polygon, except for topologically structured Areas with no geometry, in which case the Area does not have any corresponding Face(s), or Edge(s), respectively.

- A Node on Level 0 will represent 0, 1 or more Points on Level 1.
- A Dot will represent one and only one Point on Level 1.
- An Edge will represent (part of) one or more Lines on level 1, a boundary of a Face on level 0, a boundary of an Area on level 1 or a combination of these.
- A Polyline will represent one and only one Line on level 1.
- A Face on level 0 will represent (part of) one or more Areas on level 1.
- A Polygon will represent one and only one Area on level 1.

9.1.4.3 Level 2: the Complex Features

Some Features are composed of other Features. These Features are called Complex Features. Complex Features can consist of Simple Features or other Complex Features.

EXAMPLE An Intersection is a group of Road Elements and Junctions forming an aggregation of Simple Features.

9.1.4.4 Symbolisation

In this clause, a fixed set of symbols is used for the visualisation of Level 2, Level 1 and Level 0 representations. The symbols for topologically-structured representations are shown in Figure 186, Figure 187 and Figure 188.

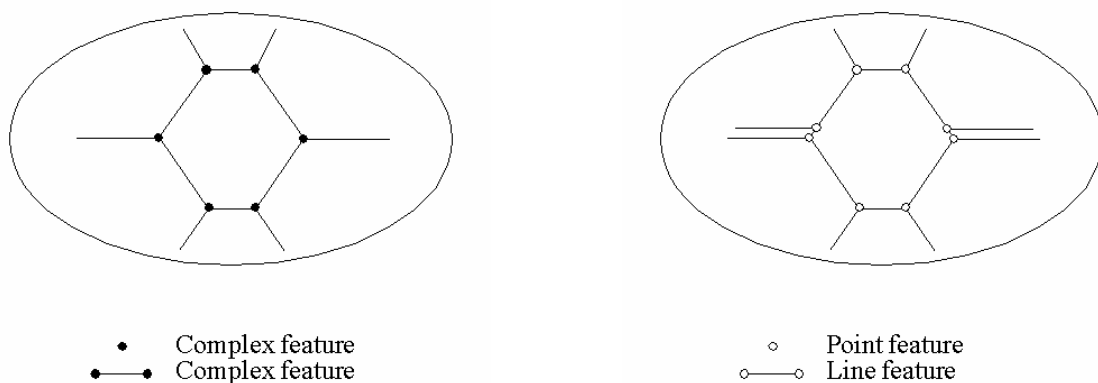

Figure 186 — Symbols in a Level-2 representation Figure 187 — Symbols in a Level-1 representation

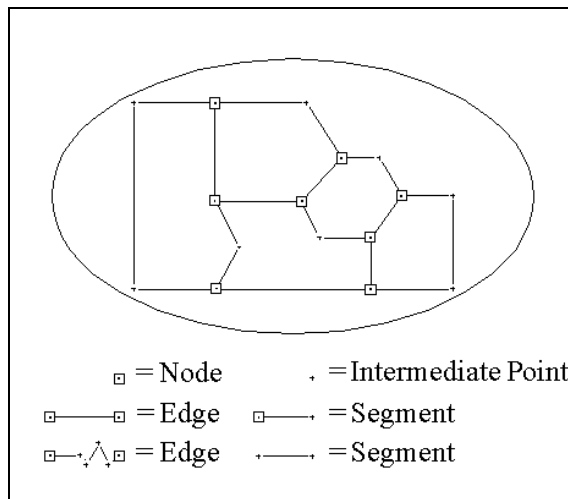

Figure 188 — Symbols in a Level-0 representation

A generic overview of the concept of a topologically-structured representation in three levels is given in Figure 194.

For the representation of non-explicit topological Features, the relation between Level 0 and Level 1 is much simpler. Each element in Level 0 corresponds to exactly one element in Level 1.

9.1.5 Layers on level 0

A Layer contains the set of level-0 elements of a GDF which are either all structured in planar topology, in non-planar topology, or which all represent non-explicit topological Features (see Figure 22). If two level-0 objects are present in two different Layers no topological integration has to take place.

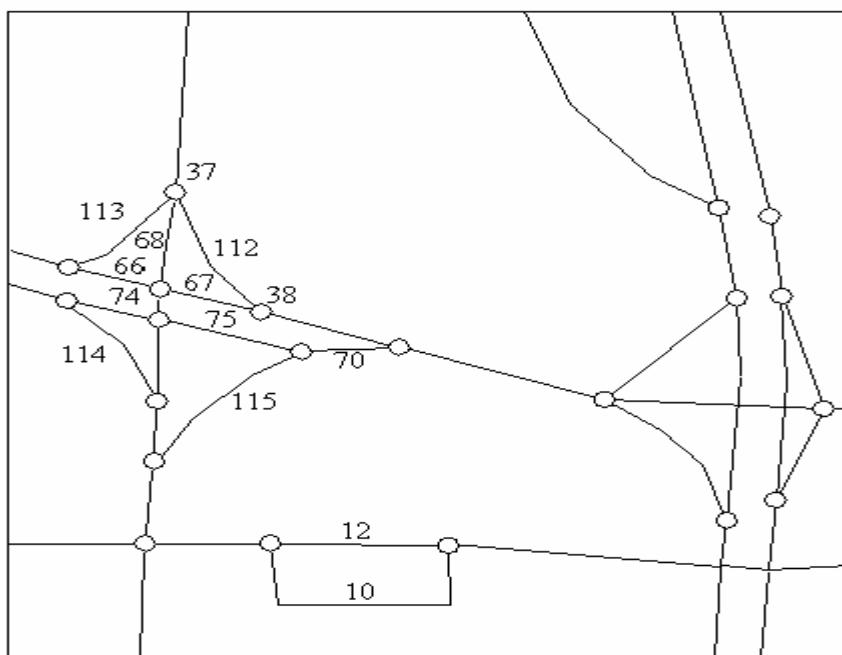

Figure 189 — Example of Level-1 representation of Roads and Ferries

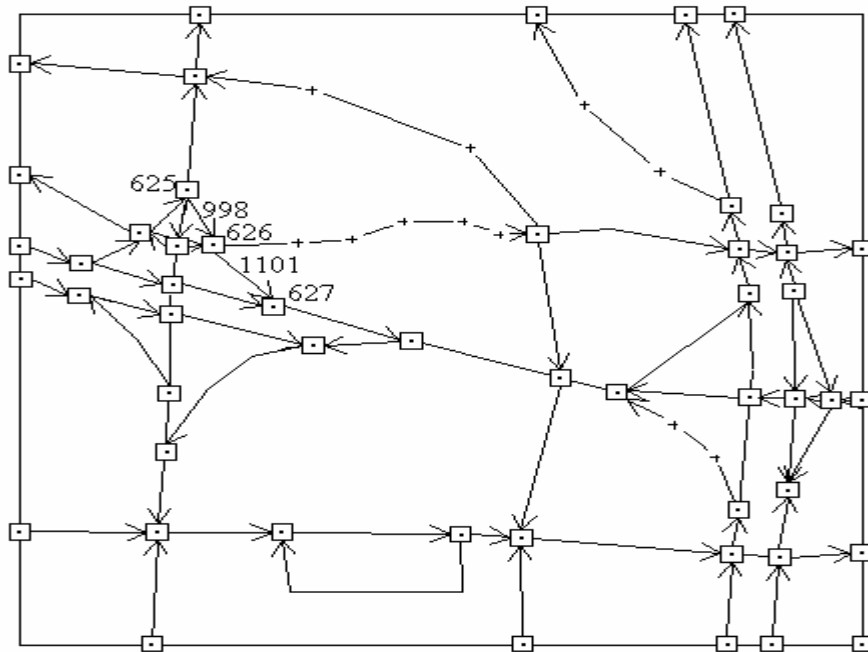

Figure 190 — Example of topological Level-0 representation of Roads and Ferries, Administrative Areas and Waterways in planar or non-planar topology

9.1.6 Rules for level 0 representation

9.1.6.1 Two dimensional geometry model

9.1.6.1.1 General rules

For the purpose of these specifications, the geometrical representation in 2-dimensional space is based on the coordinate triplet X, Y, and Z, whereby Z is optional.

- X and Y represent the spatial position on the earth's surface.
- Z represents the altitude of the earth's surface (in terms of a 2.5-dimensional geometry model rather than representing a full 3rd dimension).

The interrelation between Level 0 and Level 1 is illustrated by Figure 189 and Figure 190. Figure 189 shows the representation of a theme (Roads and Ferries) in terms of Points and Lines. Figure 190 shows the corresponding representation in terms of Nodes, Edges, Segments and Intermediate Points.

For the construction of the topologically structured Level 0 from the corresponding Level 1 representation, the following general rules apply:

- Each Level 1 Point Feature shall be represented by a Node at Level 0. If in a planar Level 0 representation two or more different Point Features of the same Feature Theme share the same position, they should be represented by one single Node. Otherwise, multiple Nodes “above” each other are allowed (in a non-planar Level 0 representation).

- Each intersection between a Level 0 Edge and the Section border shall be represented by a Node.
- Level-0 within one Layer may or may not form a planar graph. Intersections of Edges of the same Layer not represented by a Node are allowed in a non-planar Level 0 representation.
- Different themes can be combined in one Layer in which case a Level 0 element shall be shared by Level 1 elements having the same location from different themes.
- Each Line Feature shall be represented by one or more Edges. An Edge may connect vertically aligned Nodes (either connect from and to a single Node in a planar Level 0 representation, or connect from and to two Nodes located “above” each other in a non-planar Level 0 representation).

For the construction of the non-explicit topological geometric primitives, each simple Feature (Point, Line, Area) has a 1:1 relation to its corresponding Dot, Polyline or Polygon representation.

The shape of an Edge or Polyline is described by one or more Segments. The Segments are used only to represent the shape of the Edge/Polyline. Rules for the correct representation of different kinds of object shapes are given below.

9.1.6.1.2 Straight linear objects

A Straight Line Feature is represented by an Edge/Polyline that contains only one single Segment. The location of this Segment is fixed by means of two pairs of coordinates which either form the bounding Nodes (of the Edge) or the two pairs of coordinates describing the Polyline. Intermediate Points are not needed. An example is given in Figure 191 and Figure 192.

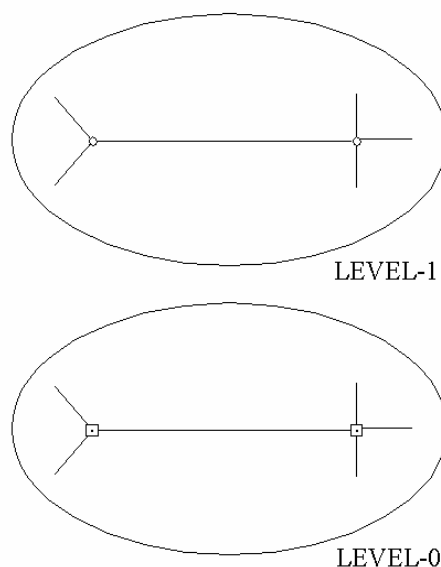

Figure 191 — Representation of straight lines

9.1.6.1.3 Linear objects with kinks

Some Line Features are not straight, but can be split into a distinct number of straight parts. These Lines can be represented by means of one or more Edges or one Polyline containing several Segments where each Segment corresponds exactly to one straight part of the Line Feature. Intermediate Points bounding the Segments represent the Kinks. An example is given in Figure 192.

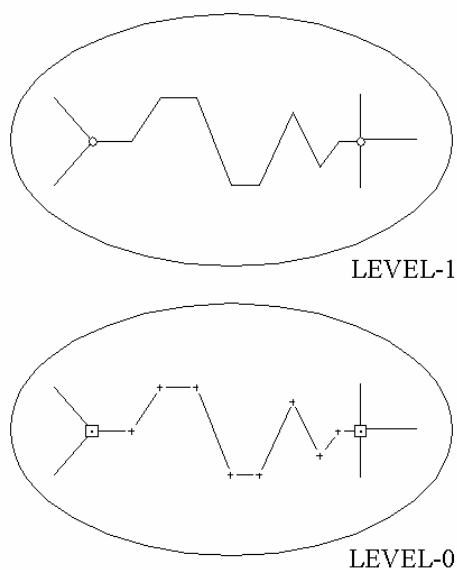

Figure 192 — Representation of a segmented line

9.1.6.1.4 Curved linear objects

An approximated representation of a curved Line Feature also will need to be made using straight Line Segments and Intermediate Points. In this case however, the positions of the intermediate points and thus their density will depend on how close an approximation is needed. An example is given in Figure 193.

The density of intermediate points is determined by the accuracy requirements.

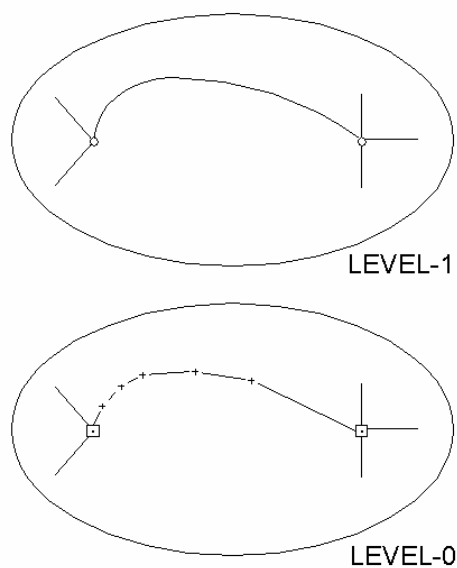

Figure 193 — Representation of curved linear objects

9.1.6.1.5 Angles between curved linear objects

The representation of the angle between two intersecting Line Features can only be approximated using Segments and Intermediate Points.

9.1.6.1.6 Example of topologically structured geo-topo representation

See Figure 194 for a generic overview of the concept of a topologically-structured representation in three levels.

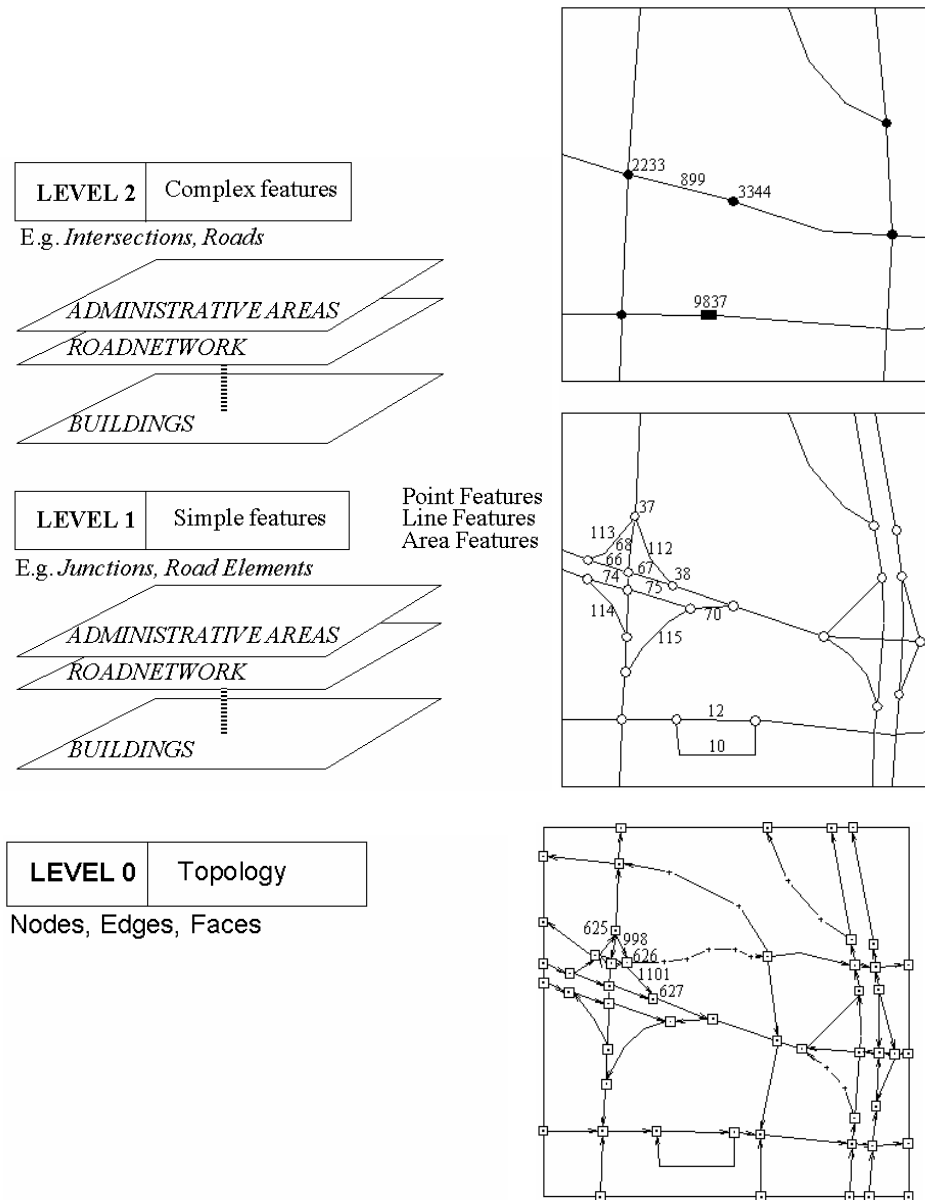

Figure 194 — The building blocks of the three levels of representation (topologically structured)

9.1.6.2 Three-dimensional geometry model

9.1.6.2.1 General rules

For the purpose of these specifications, the geometrical representation in 3-dimensional space is based on the coordinates X, Y, Z, H1, and H2, whereby Z and H2 are optional.

- X and Y represent the spatial position on the earth's surface.
- Z represents the altitude of the earth's surface.
- H1 and H2 represent the upper and lower object elevation, respectively, above (or below) the earth's surface.

The 3-dimensional geometry model is applicable to the cartographic primitives Dot, Polyline, and Polygon in non-explicit topology.

The shape of a Polyline or a Polygon (in terms of a closed Polyline) is described by one or more Segments. The same rules for the correct representation of different kinds of object shapes (such as straight lines, curved lines, etc.) as specified in the 2-dimensional geometry model apply for the X and Y dimensions of the 3-dimensional objects.

9.1.6.2.2 Basic model

A geometrical object is modelled in terms of the object's 2-dimensional footprint projected onto the earth's surface and the object's elevation.

- For a Dot, this allows modelling a vertical straight line, or "pole".
- For a Polyline, this allows modelling a vertical plane, or "wall", either with a constant height or width individual elevations specified per Intermediate Point.
- For a Polygon, this allows modelling a solid object with vertical walls, or "blocks", either with a constant height or with individual elevations specified per Intermediate Point.

The upper object elevation (H1) specifies the total vertical height relative to the earth's surface. The optional lower elevation (H2) further modifies the object's geometry by introducing open space between object and the earth's surface ($0 < H2 < H1$), or by extending the object's vertical extent below the earth's surface ($H2 < 0$). In a special case, both H1 and H2 may be below ground ($H2 < H1 < 0$). H2 is not applicable to Dots.

9.1.6.2.3 Block modelling with polygons

The 3-dimensional polygons support different degrees of sophistication, depending on the occurrence of lower object elevations or individual heights per Intermediate Point.

Complex 3-dimensional geometries can be modelled by breaking them down into basic models, each represented by a Polygon (so-called wood block models).

Figure 195 and Figure 196 give two examples for complex cases.

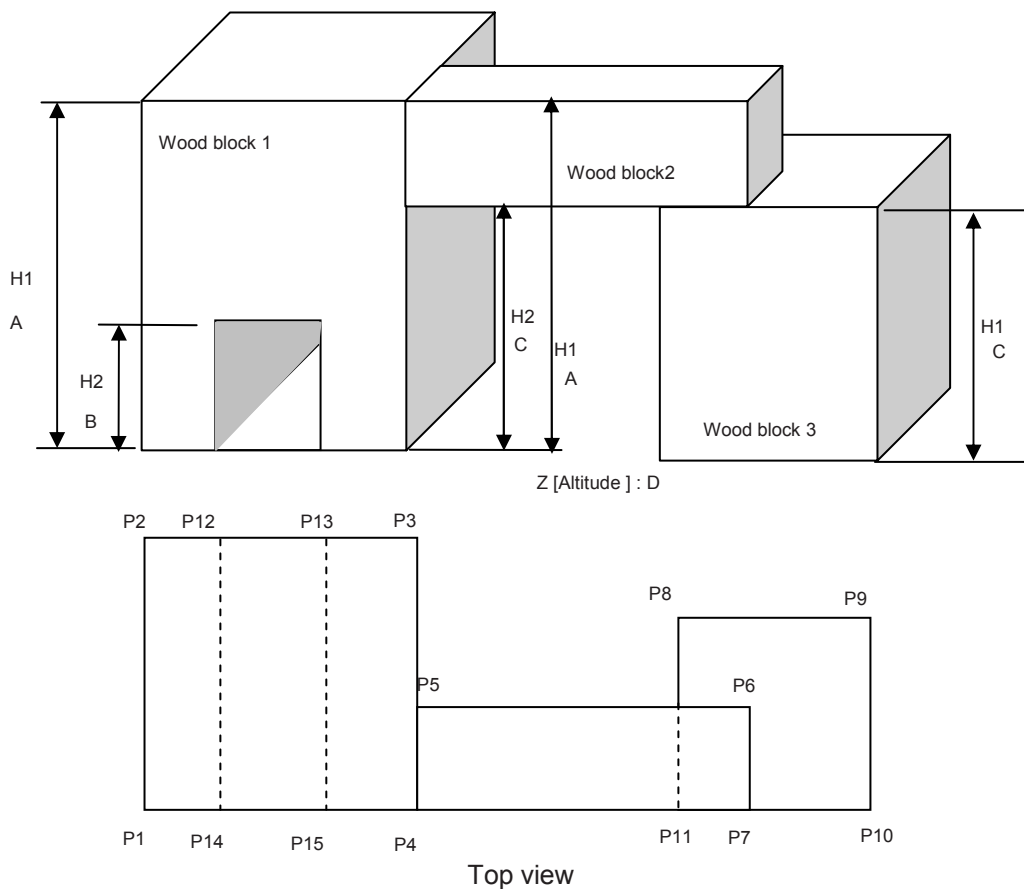

Description of extended geometry

Wood block 1

Foot print (X,Y)	P1	P2	P12	P12	P13	P13	P3	P4	P15	P15	P14	P14	P1
Z	D												
H1	A												
H2	0		B		0			B		0			

Wood block 2

Foot print (X,Y)	P4	P5	P6	P7	P4
Z	D				
H1	A				
H2	C				

Wood block 3

Foot print (X,Y)	P8	P9	P10	P11	P8
Z	D				
H1	C				
H2	0				

Figure 195 — Wood block model example of a complex 3-dimensional geometry

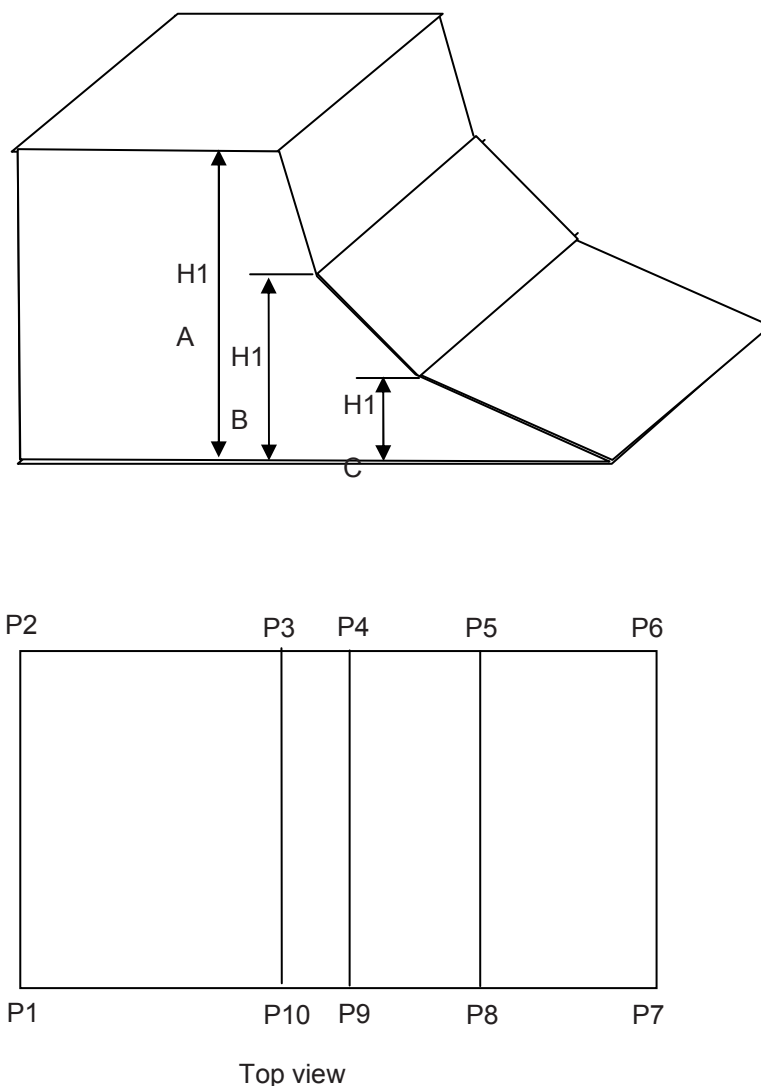

Figure 196 — Basic block model example of a sophisticated 3-dimensional geometry

9.1.6.3 Four-dimensional geometry model

9.1.6.3.1 General rules

For the purpose of these specifications, the geometrical representation in 4-dimensional space is constituted by extending the 2-dimensional or the 3-dimensional geometry model with temporal coordinates about the object's existence. The 4-dimensional model is based on the coordinates X, Y, Z, H1, H2, SA, EA, SD, and ED, whereby Z, H1, and H2 are optional.

- X and Y represent the spatial position on the earth's surface.
- Z represents the altitude of the earth's surface.
- H1 and H2 represent the upper and lower object elevation, respectively, above (or below) the earth's surface.
- SA (Start Appearance), EA (End Appearance), SD (Start Disappearance), and ED (End Disappearance) represent the start and end of the object's existence in time, including time ramps for the period during which the object came into existence (SA→EA), and during which it ceased to exist (SD→ED) [39].

The 4-dimensional geometry model is applicable to the cartographic primitives Dot, Polyline, and Polygon in non-explicit topology.

The shape of a Polyline and a Polygon (in terms of a closed Polyline) is described by one or more Segments. The same rules for the correct representation of different kinds of object shapes (such as straight lines, curved lines, etc.) as specified in the 2-dimensional geometry model apply for the X and Y dimensions of the 4-dimensional objects.

9.1.6.3.2 Temporal scenarios

Object geometry may use only some and not all of the temporal coordinates to describe its existence over time, including the transitions [39].

A Feature can be one of the 17 cases

A. The Feature without temporal coordinates reflects that

- The Feature exists at the current time, but
- there is no temporal information associated with it.
- Note that this is not considered a case of 4-dimensional geometry.

B. The Feature with temporal coordinates used presents one of 16 cases listed below whereby

- the Feature has the temporal information even though it disappeared, and
- there could be some missing temporal information for the four time coordinates.
- If the Feature is associated with temporal information, it is present in the map regardless of its temporal state.

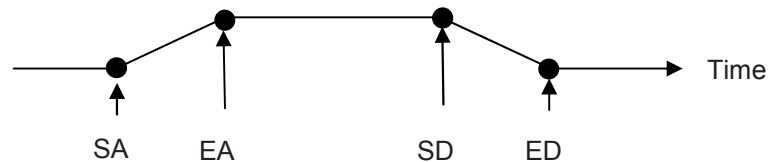

No	Action	SA	EA	SD	ED	Interpretation
0		-	-	-	-	Feature no longer exists w/ incomplete info
1		•	-	-	-	Feature is being built
2		-	•	-	-	Feature exists now w/ incomplete info
3		•	•	-	-	Feature was built and exists now

No	Action	SA	EA	SD	ED	Interpretation
4		-	-	•	-	Feature is deserted w/ incomplete info
5		•	-	•	-	Feature was built, and deserted
6		-	•	•	-	Feature was built w/ incomplete info, and deserted
7		•	•	•	-	Feature was built, and deserted
8		-	-	-	•	Feature no longer exists w/ incomplete info
9		•	-	-	•	Feature was built, and no longer exists w/ incomplete info
10		-	•	-	•	Feature was built, and no longer exists w/ incomplete info
11		•	•	-	•	Feature was built, and no longer exists
12		-	-	•	•	Feature no longer exists w/ incomplete info
13		•	-	•	•	Feature was built, and no longer exists
14		-	•	•	•	Feature was built, and no longer exists
15		•	•	•	•	Feature was built and no longer exists
● : time info; ● : unknown time info; —: known period; - -: unknown period						

Figure 197 depicts an example of a geometry which ceases to exist. Both Figure 197 and Figure 198 contain an example of geometry that comes into existence. Figure 198 additionally shows the default case of geometry that remains unchanged over time. Figure 199 describes an example of the lifespan of the geometry of a building.

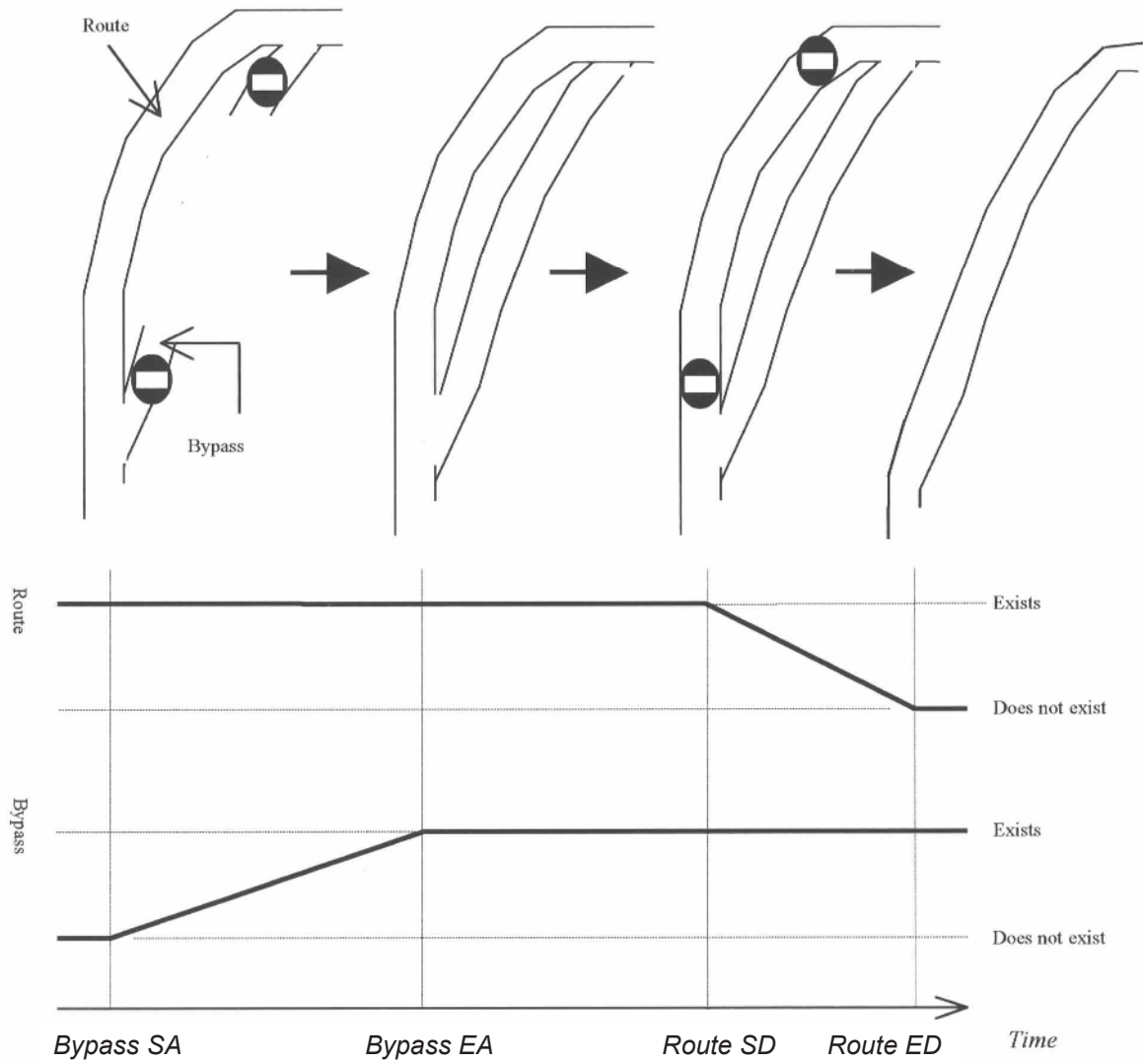

Figure 197 — Transition over time of bypass construction example replacing route

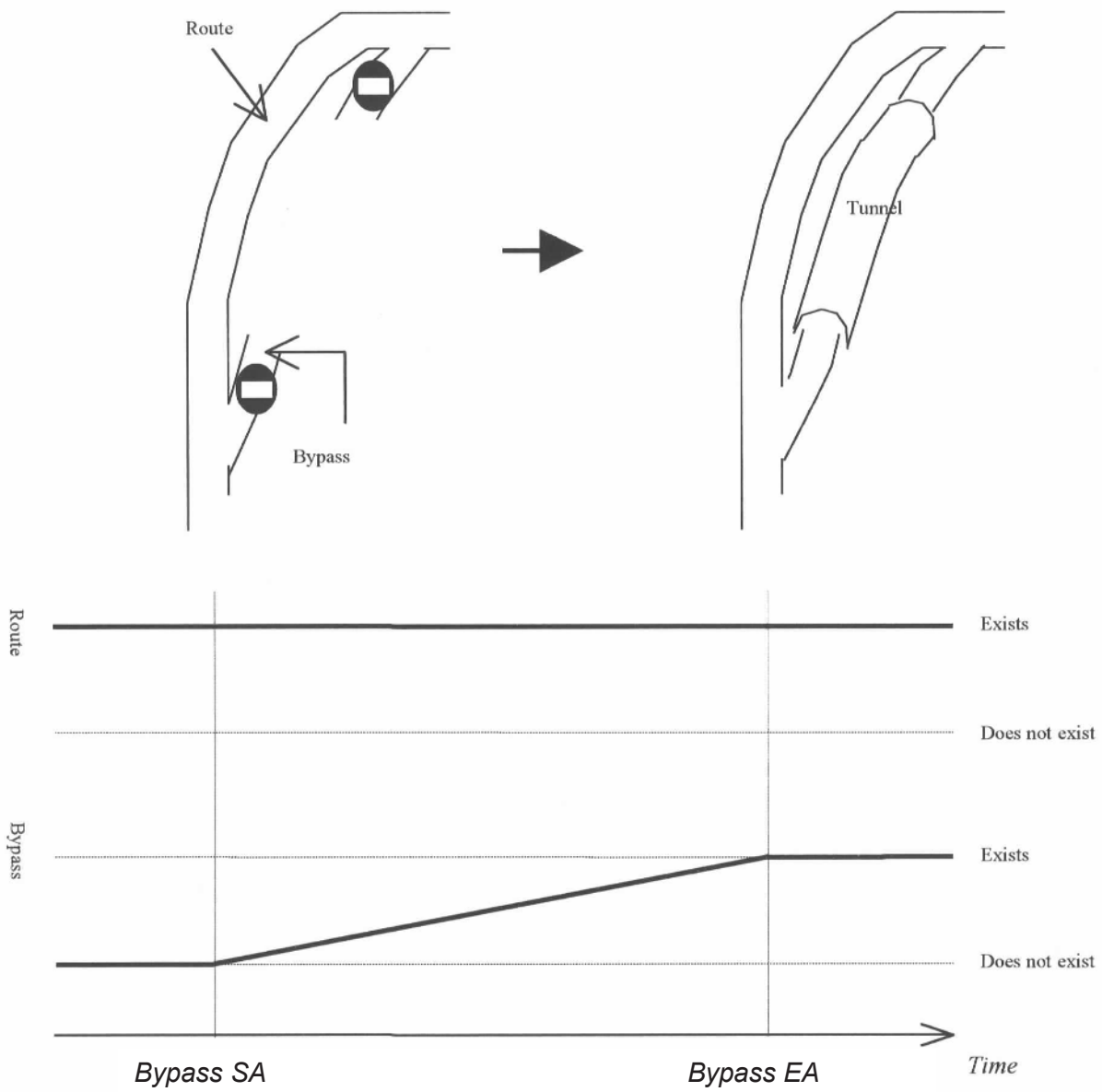

Figure 198 — Transition over time of bypass construction example adding tunnel

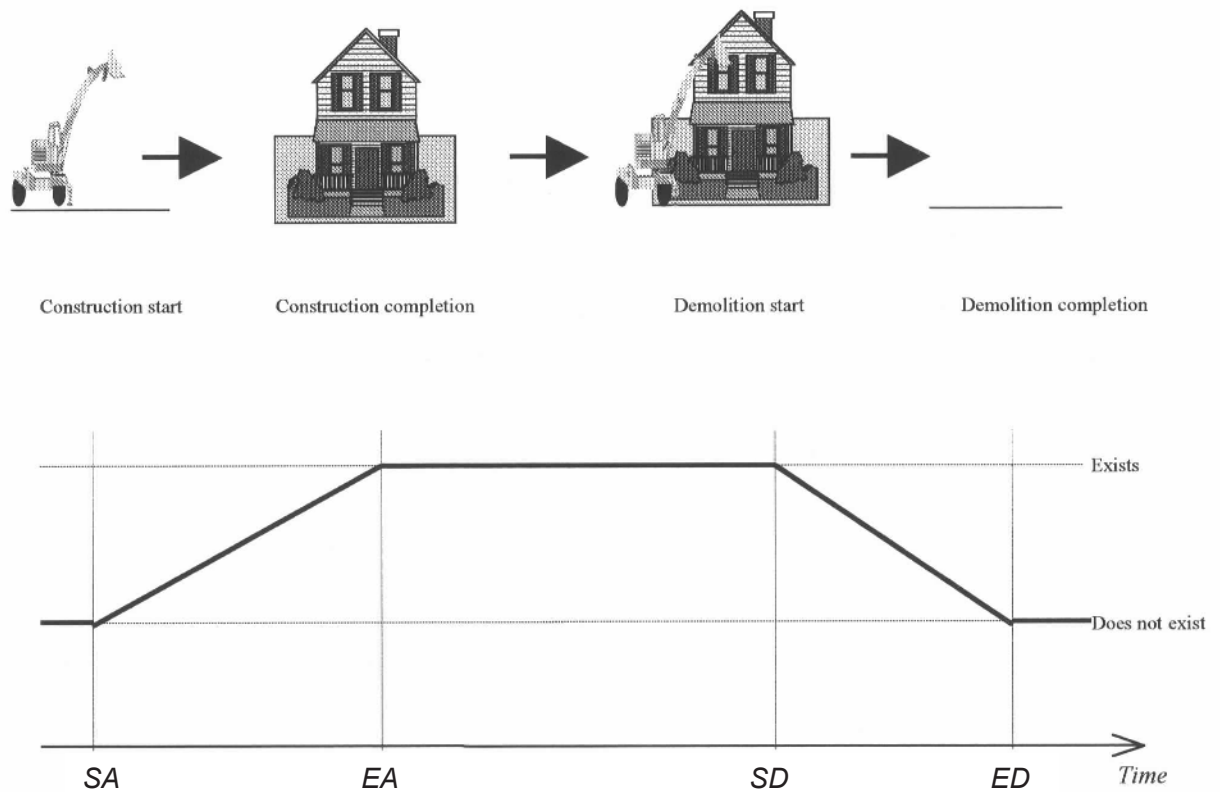

Figure 199 — Transition over time of building construction and demolition example

9.2 Roads and Ferries

9.2.1 Introduction

This clause describes the three different levels of representation (Level 0, Level 1, Level 2) for the Feature Theme Roads and Ferries. Only topologically structured elements shall be used.

9.2.2 Level 2 representation

A Road, a Ferry, an Intersection, an Interchange, a Roundabout and an Aggregated Way are Complex Features.

Guidelines for the formation of Roads, Intersections, Roundabouts and Interchanges can be found in Annex F.

9.2.3 Level 1 representation for planar or non-planar topology

9.2.3.1 General rules

- A Road Element is always a Line Feature, represented by one or more Edges at Level 0.
- A Pathway is always a Line Feature, represented by one or more Edges at Level 0.
- A Ferry Connection is always a Line Feature represented by one or more Edges at Level 0.
- A Junction is always a Point Feature, represented by one single Node at Level 0.

- An Address Area is always an Area Feature, represented by one or more Faces or Edges at Level 0.
- An Address Area Boundary Element is always a Line Feature, represented by one or more Edges at Level 0.
- An Enclosed Traffic Area is always represented by an Area Feature, represented by one or more Faces or Edges at Level 0.

9.2.3.2 Road Element

Road Elements are Line Features and are represented by one or more Edges at Level 0. They are represented by the centrelines of a road. In case the centreline of the road is ambiguous or discontinuous the general flow of traffic should be used as a guideline for defining the shape of the Road Element.

The Edges should fall within the curb lines.

9.2.3.3 Pathway

Pathways are Line Features and are represented by one or more Edges at Level 0. They are represented by the centrelines of a pedestrian passageway. The Edges should fall within the curb lines (boundary lines) where applicable.

In the case of a vertical Pathway (i.e. elevator), the representation is dependent upon the type of topology:

- In planar topology, an Edge of length zero is to form a connection between two instances of the same Node;
- In non-planar topology, a description of the height difference between the two Nodes stacked above each other to bound the vertical Edge shall appear.

Where a centreline is ambiguous or discontinuous a different representation by means of an Enclosed Traffic Area (type Pedestrian Square) may be more appropriate.

9.2.3.4 Junction

A Junction is always a Point Feature, represented by one single Node at Level 0. The location of the Junction corresponds to:

- the connection point between two or more Road Elements, two or more Pathways, two or more Ferry Connections, or a combination of either of the former;
- or the intersection point between one or more of the former and the outline of an Enclosed Traffic Area;
- or the end of a dead end Road Element or Pathway.

9.2.3.5 Enclosed Traffic Area

Within Enclosed Traffic Areas, the identification of a road centreline is an unrealistic task. Also a general flow of traffic is non-existent. These objects are therefore not represented by a Line Feature but by an Area Feature.

The connectivity of all Road Elements, and/or Pathways leading to one Enclosed Traffic Area can be described in three ways:

- by means of their shared Node(s) or Edge(s);

- by means of a number of bivalent Relationships defined between the Enclosed Traffic Area in question and each Road Element, or Pathway respectively, linked to it;
- by means of (artificial) Road Elements inside the Enclosed Traffic Area connecting the Junctions situated on the outline with an (artificial) centre point Junction somewhere inside the traffic area.

In the latter case, the Attribute Type Form of Way can be attached to the additional Road Elements, or Pathway respectively, in order to indicate their special status.

For Enclosed Traffic Areas where pedestrians or non-motorised vehicles are only allowed along the outer Edges but not inside, the outline of the Enclosed Traffic Area shall be represented either by Pathways or, for those parts of an Enclosed Traffic Area that are bounded by Road Elements, by the Attribute Road with Sidewalk.

9.2.3.6 Ferry Connection

A Ferry Connection is always a Line Feature represented by one or more Edges at Level 0.

9.2.3.7 Address Area

An Address Area is always an Area Feature, represented by one or more Faces at Level 0 or by one or more Edges on level 0 representing its boundary.

9.2.3.8 Address Area Boundary Element

An Address Area Boundary Element is always a Line Feature, represented by one or more Edges at Level 0.

9.2.4 Level 1 representation for non-explicit topology

A Point, Line, or Area Feature is represented by a single Dot, Polyline, or Polygon, respectively, at any point in time.

Generally, the same representation rules apply as for planar or non-planar topology, except that any of the specified topological relations shall be (implicitly) fulfilled by spatial relations.

9.2.5 Level 0 representation

9.2.5.1 Introduction

The general rules for the construction of a Level 0 representation are described in an earlier sub-clause. This sub-clause contains some worked examples and detailed rules relevant for Roads and Ferries.

9.2.5.2 Enclosed Traffic Area

The Face(s) representing the Enclosed Traffic Area or the Edges or the Polyline describing its boundary shall describe the maximum extent of the permitted area for vehicle use.

Special attention has to be paid to those situations where the (part of the) outline of an Enclosed Traffic Area spatially coincides with the centrelines of a “normal” Road Element.

Figure 200 describes the situation where a parking area is directly situated along the side of a road. At Level 0 Edge C203 is used for representation of both the centreline of the Road Element and the outline of the parking area.

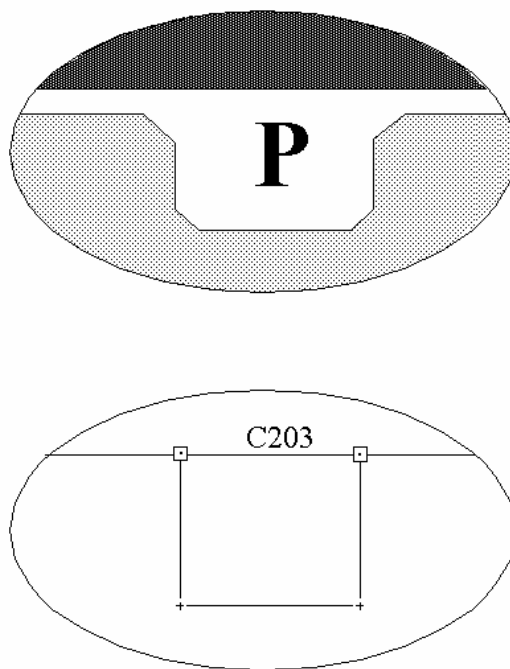

Figure 200 — The Level-0 representation of a parking area (in planar or non-planar topology)

9.2.5.3 Ferry Connection

The Edge(s) or the Polyline that represent(s) a Ferry Connection need to mirror the average route of the ferry boats. A detailed representation is not practical as the route may vary by season or by tide.

9.3 Administrative Areas

9.3.1 Level 1 and Level 2 representation for planar or non-planar topology

9.3.1.1 Administrative Boundary Element

An Administrative Boundary Element is always treated as a Line Feature. Every Administrative Boundary Element should be part of a set of Administrative Boundary Elements which together form a closed polygon, which means that “dead ends” or “dangling nodes” are not allowed.

To avoid dead ends at the borders of a particular Section the border has to be represented as a Administrative Boundary Element as well, so that closed polygons can always be formed. See Figure 201 and Figure 202.

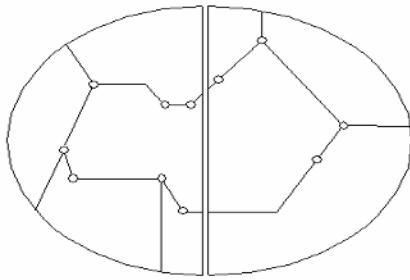

Figure 201 — Administrative Boundary Elements are represented by one or more Edges

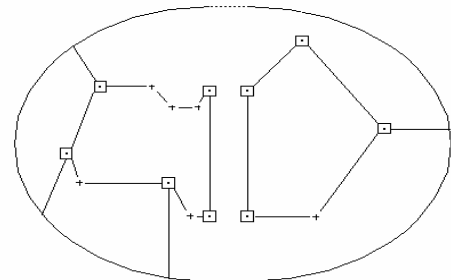

Figure 202 — Section borders have to be represented as Administrative Boundary Elements to avoid dangling nodes

9.3.1.2 Administrative Boundary Junction

An Administrative Boundary Junction is always a Point Feature represented by one single Node.

If a boundary of a particular Administrative Area (or parts of that Area) is not connected with any other boundary (in the case of enclaves or isolated parts), an Administrative Boundary Junction has to be introduced somewhere along its length in order to define at least one Administrative Boundary Element. (See Figure 203).

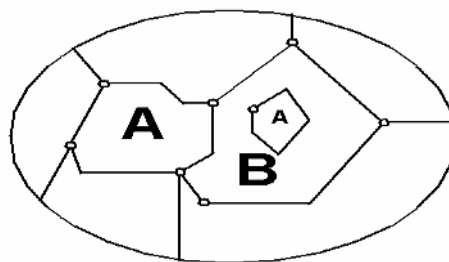

Figure 203 — For an isolated (part of an) Administrative Area, an Administrative Boundary Junction must be introduced to define one Administrative Boundary Element

9.3.1.3 Order-9 Area and higher, Country

A Feature of the lowest occurring order in the hierarchy of Administrative Areas is generally represented as an Area Feature defined by one or more Faces or by one or more Edges describing its boundary. If not, it should be represented as a Point Feature represented by a Node. The above rule assumes that if they are represented in a separate Layer, they may also be represented by Polygons. Hierarchical Administrative Areas of higher order have to be seen as Complex Features. They are composed of lower order Administrative Areas, either Area or Complex Features.

9.3.1.4 Administrative Place n

An Administrative Place n is generally represented as an Area Feature defined by one or more Faces or by one or more Edges describing its boundary. If not, it should be represented as a Point Feature represented by a Node. The above rule assumes that, if they are represented in a separate Layer, they may also be represented by Polygons.

9.3.1.5 Supra-National Area

A Supra-National Area is represented as a Complex Feature consisting of its member countries.

9.3.2 Level 1 and Level 2 representation for non-explicit topology

A Point, Line, or Area Feature is represented by a single Dot, Polyline, or Polygon, respectively, at any point in time.

Generally, the same representation rules apply as for planar or non-planar topology, except that any of the specified topological relations shall be (implicitly) fulfilled by spatial relations.

9.3.3 Level 0 representation

The general rules for the Level-0 representation apply.

9.4 Named Areas

9.4.1 Level 2 representation

There are no Level 2 Features in the Named Areas theme.

9.4.2 Level 1 representation for planar or non-planar topology

9.4.2.1 General rules

Except in the two cases represented below, Named Areas are generally represented as Area Features. If not, they should be represented as Point Features.

9.4.2.2 Boundary Element

A Boundary Element is always treated as a Line Feature. Every Boundary Element should be part of a set of Boundary Elements which together form a closed polygon, which means that “dead ends” or “dangling nodes” are not allowed.

To avoid dead ends at the borders of a particular Section the border has to be represented as a Boundary Element as well, so that closed polygons can always be formed. See Figure 204 and Figure 205.

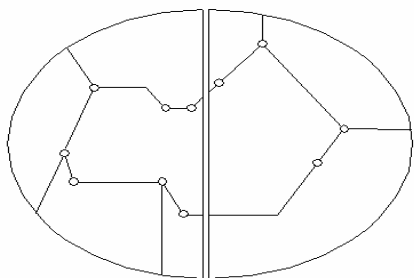

Figure 204 — Boundary Elements are represented by one or more Edges

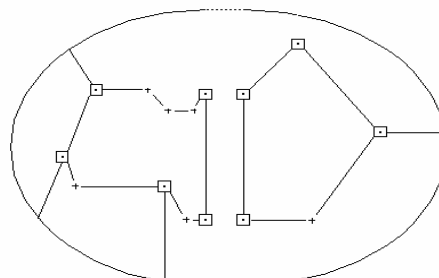

Figure 205 — Section borders have to be represented as Boundary Elements to avoid dangling nodes

9.4.2.3 Boundary Junction

A Boundary Junction is always a Point Feature represented by one single Node.

If a boundary of a particular Named Area (or parts of that Area) is not connected with any other boundary (in the case of enclaves or isolated parts), a Boundary Junction has to be introduced somewhere along its length in order to define at least one Boundary Element. (See Figure 206).

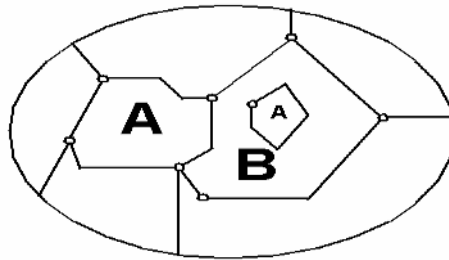

Figure 206 — For an isolated (part of a) Named Area, a Boundary Junction must be introduced to define one Boundary Element

9.4.3 Level 1 representation for non-explicit topology

A Point, Line, or Area Feature is represented by a single Dot, Polyline, or Polygon, respectively, at any point in time.

Generally, the same representation rules apply as for planar or non-planar topology, except that any of the specified topological relations shall be (implicitly) fulfilled by spatial relations.

9.4.4 Level 0 representation

The general rules for the Level-0 representation apply.

9.5 Land Cover And Use

9.5.1 Level 2 representation

There are no Level 2 Features in the Land Cover And Use theme.

9.5.2 Level 1 representation

Building Units are always represented as Point Features.

Building Façade, Building Detail and Block Detail are represented as Line Features.

All other Features of Land Cover And Use are generally represented as Area Features. If not, they should be represented as Point Features.

9.5.3 Level 0 representation

The general rules for the Level-0 representation apply.

9.6 Terrain Elevation

9.6.1 Level 2 representation

There are no Level 2 Features in the Terrain Elevation theme.

9.6.2 Level 1 representation for planar and non-planar topology

These topology types support terrain surface modelling by means of full TINs (planar topology only) and reduced TINs.

- A TIN Node is represented by a Point Feature.
- A TIN Breakline and a TIN Stopleveline is each represented by a Line Feature.
- A TIN Surface is represented by an Area Feature composed of multiple (triangular) Faces.

9.6.3 Level 1 representation for non-explicit topology

This topology type supports terrain surface modelling by means of full TINs, reduced TINs, contour lines, and grids.

- A TIN Node and Contour Line Point is each represented by a Point Feature in terms of a single Dot.
- A TIN Breakline, a TIN Stopleveline, and a Contour Line is each represented by a Line Feature in terms of a single Polyline.
- A TIN Triangle is represented by an Area Feature in terms of a single (triangular) Polygon.
- A Gridded Surface is represented by an Area Feature in terms of a single (quadrangular) Polygon outlining the bounding box of the rasterised elevation points.
- A Contour Line Area is represented by an Area Feature in terms of a single Polygon.

9.6.4 Level 0 representation

The general rules for the Level-0 representation apply. Extended Area Geometry Information may be specified for Faces (modelling TIN Surfaces) and Area Features (modelling TIN Triangles and Gridded Surfaces).

9.7 Structures

9.7.1 Level 2 representation

There are no Level 2 Features in the Structures theme.

9.7.2 Level 1 representation

9.7.2.1 General rules

Structures may be treated as Point Features, Line Features, or Area Features.

Normally use can be made of existing geometry created for other Features. New geometry may be created to more accurately represent the physical construction of the Structure. However, in certain cases it is required to create Level 0 elements for the representation of a Structure. This applies e.g. to a bridge over a valley, a tunnel through a mountain, and more specifically to Cutting, Gallery and Retaining Wall.

Below rules are given for the representation of Structures where they are represented in the same Layer as the associated Transportation Elements. If Structures are represented in a separate Layer, they may also be represented by Dots, Polylines or Polygons.

9.7.2.2 Structures as Point Features

In most cases, Structures will be seen as Point Features, for example grade separated Structures situated on the crossing between two single carriageway Road Elements, as illustrated in Figure 207. The Level 0 representation of such a crossing will have one single Node. The same Node shall also be used to describe the location of the Structure.

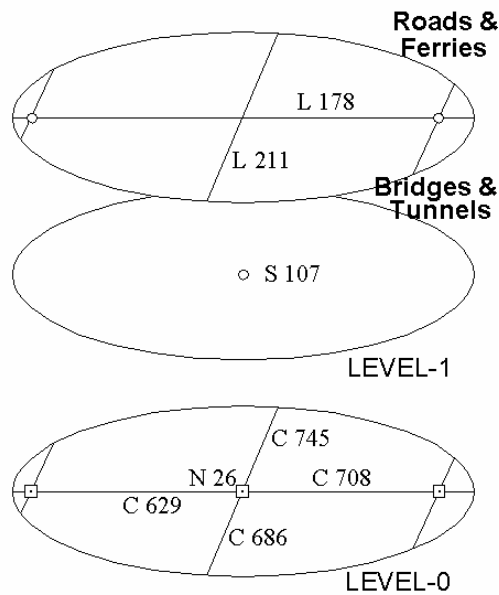

Figure 207 — Structure as a Point Feature

9.7.2.3 Structures as Line Features

Structures related to a crossing between a single and a dual carriageway (see Figure 208 and Figure 209) are treated as Line Features as shown in the example in Figure 209.

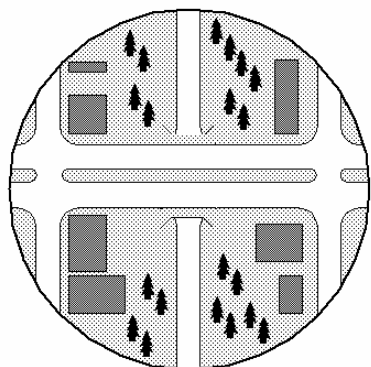

Figure 208 — A Structure at the crossing of a single and dual carriageway road

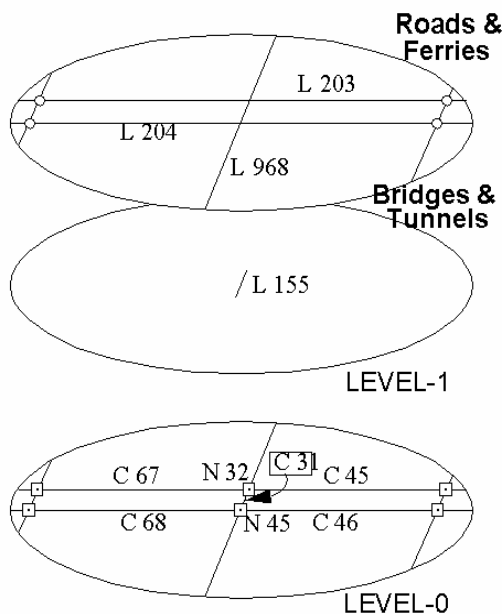

Figure 209 — Structure as a Line Feature

In certain cases additional geometrical elements may need to be introduced for an accurate representation. This applies e.g. to a tunnel through a mountain (as illustrated in Figure 210 and Figure 211), or a very long viaduct, cutting, gallery and retaining wall.

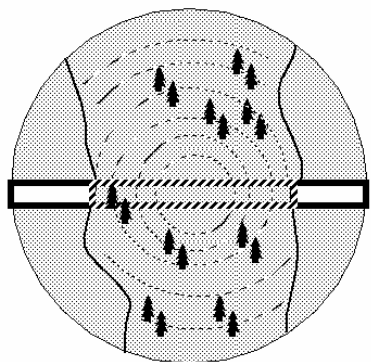

Figure 210 — A Structure as a tunnel through a mountain

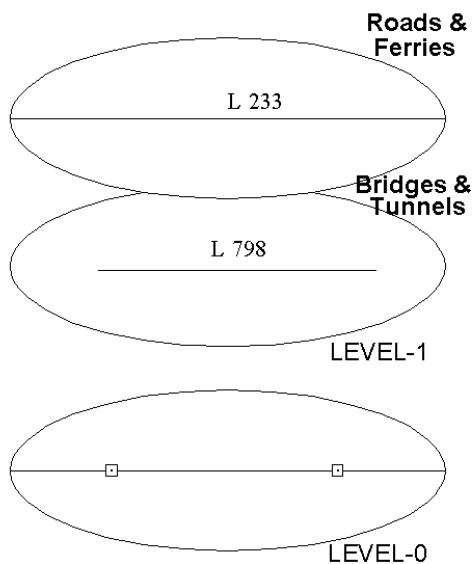

Figure 211 — Representation of the tunnel at Level-0 and Level-1

9.7.2.4 Structures as Area Features

Structures related to a crossing between two dual carriageways (see Figure 212 and Figure 213) can be treated in two ways, depending on whether it should be considered as one or two separate structure constructions:

- Representation as Area Features, as shown in Figure 213.
- Representation as two (parallel) Line Features. Depending on the construction, either two bridges or two tunnels are created, both represented according to Line Feature Structures (see above).

Cutting, embankment and retaining wall shall not be represented as an Area Feature.

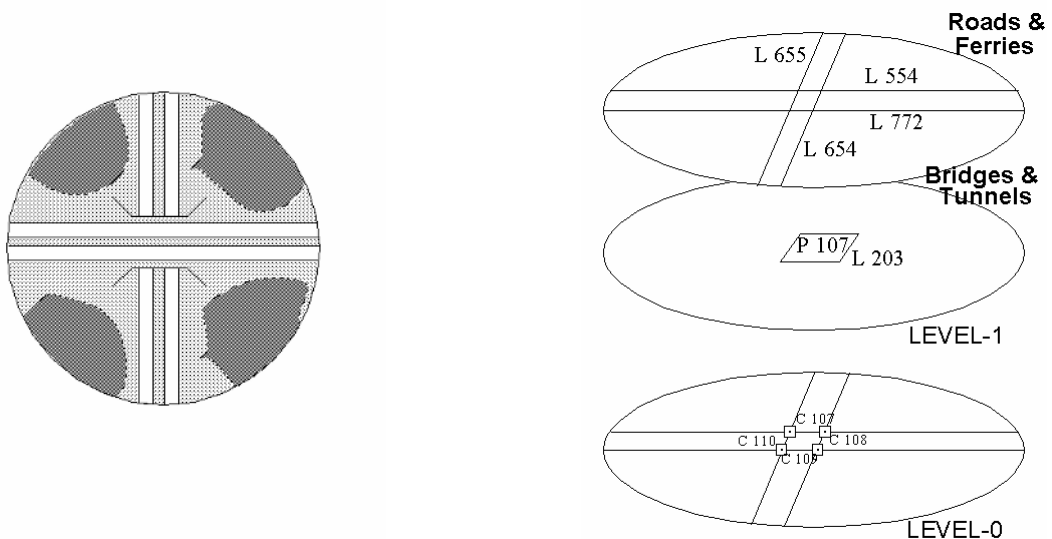

Figure 212 — A structure at the crossing of 2 dual carriageways

Figure 213 — A Structure represented as an Area Feature

9.7.3 Level 0 representation

The general rules for the Level-0 representation apply.

9.8 Railways

9.8.1 Level 2 representation

There are no Level 2 Features in the Railways theme.

9.8.2 Level 1 representation

9.8.2.1 Railway Element

A Railway Element is always represented as a Line Feature.

9.8.2.2 Railway Element Junction

A Railway Junction is always represented as a Point Feature.

9.8.3 Level 0 representation

The general rules for the Level-0 representation apply.

9.9 Waterways

9.9.1 Level 2 representation

There are no Level 2 Features in the Waterway theme.

9.9.2 Level 1 representation

9.9.2.1 General rules

Water bodies can be represented in three ways:

- by describing the outline of the water body;
- by describing the water itself, i.e. the area which is covered by water;
- a combination of above methods.

The representation of the second case (i.e. the coverage representation by means of Water Bodies) considers whether the water body is of linear (e.g. rivers) or areal (e.g. lakes, wide rivers) nature or a landmark (spring, pond, etc.).

9.9.2.2 Water Body

A Water Body is either a Point Feature, a Line Feature or an Area Feature depending on its size and the defined accuracy. In the case of Point Features, the centre point of water bodies is represented. With Line Features, the centreline is described. In case of Area Features, the physical extent is represented.

When the width of a Water Body does not exceed xx meters, it should be treated as a Line Feature. Otherwise, it forms an Area Feature. If along a river or canal the width varies around yy meters, so that the representation changes very often between line and area, one of these representations shall be chosen for a longer distance. Transitions between line and area representations should be kept to a minimum.

When the length or diameter of a Water Body does not exceed zz meters, it should be treated as a Point Feature. This Point shall correspond to the centre point of the cartographic representation in the source map.

The values for xx , yy and zz are user and/or application dependent.

9.9.2.3 Water Boundary Element

A Water Boundary Element is always represented as a Line Feature. It is directed to describe to which side of the boundary the water exists (see Feature Catalogue).

9.9.2.4 Water Boundary Junction

A Water Boundary Junction is always represented as a Point Feature.

9.9.3 Level 0 representation

The general rules for the Level-0 representation apply.

9.10 Road Furniture

9.10.1 Level 2 representation

Complex Pedestrian Crossing is a Complex Feature.

9.10.2 Level 1 representation

9.10.2.1 Pedestrian Crossing

Pedestrian Crossing objects are either a Point Feature, a Line Feature or an Area Feature depending on the size and the defined accuracy. In case of a Point Feature the Centre point of the object is represented. With Line Features, the center line is described. In case of Area Features the physical extent of the object is represented. When the width or diameter of the object does not exceed yy meters it should be treated as a Line Feature, otherwise it forms an Area Feature. When the length or diameter of the object does not exceed zz meters, it should be treated as a Point Feature.

The values for yy, zz are user and/or application dependent.

9.10.2.2 Environmental Equipment, Road Markings, Safety Equipment

Environmental Equipment, Road Markings and Safety Equipment objects are either a Point Feature or a Line Feature depending on the size and the defined accuracy. In case of a Point Feature, the centre point of the object is represented. With Line Features, the centreline is described.

When the length of the object does not exceed zz meters, it should be treated as a Point Feature.

The value for zz is user and/or application dependent.

Lighting, Measurement Device, Traffic Sign, Traffic Light and Signpost objects are always represented as a Point Feature.

9.10.3 Level 0 representation

The general rules for the Level-0 representation apply, except that it is not required to collect the position (i.e. the coordinates) of the Road Furniture Features.

9.11 Services

9.11.1 Level 1 and Level 2 representation

All Service objects are represented as either Point, Line or Area Features.

9.11.2 Level 0 representation

The general rules for the Level-0 representation apply.

9.12 Public Transport

9.12.1 Level 2 representation

Lines, Routes and Stop Areas are represented as Complex Features.

9.12.2 Level 1 representation

A Taxi Stand, Stop Point, a Public Transport Point and a Route Point are always Point Features.

A Route Link is represented as a Line Feature.

9.12.3 Level 0 representation

The general rules for the Level-0 representation apply.

9.13 Linear Referencing Features

9.13.1 Level 1 and Level 2 representation

9.13.1.1 Path

A Path shall be represented as a Line Feature.

9.13.1.2 Referent

A Referent shall be represented as a Point Feature.

9.13.2 Level 0 representation

The general rules for the Level 0 representation apply.

9.14 Linear Datum Features

9.14.1 Level 2 representation

The Linear Datum is always represented as a Complex Feature.

Each Linear Datum shall have at least two Anchor Points.

Each Linear Datum shall have at least one Anchor Section.

9.14.2 Level 1 representation

An Anchor Point is always represented as a Point Feature.

An Anchor Section is always represented as a Line Feature.

Each Anchor Section must have one and only one start Anchor Point.

Each Anchor Section must have one and only one end Anchor Point.

9.14.3 Level 0 representation

When Linear Datums are defined with planar topology or non-planar topology, level 0 representation Nodes and Edges are used for the Anchor Points and Anchor Sections, respectively. The general rules for the Level-0 representation apply. Alternatively, the level 0 representation may be omitted. For non-explicit topology, there is no level 0 representation.

In a planar graph, a single Anchor Section may be composed of multiple Edges. Crossing Anchor Sections shall not intersect each other, i.e. no additional Anchor Points shall artificially be introduced even if crossing Anchor Sections represent roads that cross at the same grade in the real-world.

9.15 General Features

9.15.1 Level 2 representation

A Traffic Location is represented as a Complex Feature.

9.15.2 Level 1 representation

Centre Point of Feature and Entry Point are always represented as a Point Feature.

9.15.3 Level 0 representation

The general rules for the Level-0 representation apply.

10 Metadata Catalogue

10.1 Generic specification

10.1.1 Introduction

A set of data in GDF format should be as self descriptive as possible, so that a recipient can interpret the data without the need for copious volumes of documentation. This self descriptive information is called "metadata" and contains the following main items:

- The identification and description of the different logical and physical units.
- The definition of field and record types.
- The table of contents.
- The description of external data sources that have been used.
- The specification of the spatial reference system that has been used.
- The description of syntactical information used for the publishing of Update Information.

Metadata in GDF Datasets is compliant with ISO/TC 211 International Standard ISO 19115:2003, "Geographic Information – Metadata", and the Technical Corrigendum ISO 19115:2003/Cor 1:2006 [28]. Compliance with ISO 19115 is asserted by inclusion of all mandatory data elements from the standard. In addition, selected data elements that are optional in ISO 19115 are included in GDF where doing so facilitates use of GDF by the Geographic Information community.

NOTE Any GDF Dataset produced in accordance with this standard is subject to compliance testing as specified in normative Annex D, Abstract test suite, of ISO 19115.

The following table lists the ISO 19115 data items (elements and classes) included in GDF. Unless otherwise labeled, all elements are mandatory in ISO 19115. New code lists and enumerations added are given in Figure 214.

ISO 19115 Elements	GDF Album Applicable	GDF Data-set Applicable	ISO 19115 Data Type	Definition	Correspondence Status
Organization Name	√		CI_ResponsibleParty.organizationName (CharacterString)	name of the responsible organization	Data Supplier Name
Role	√		CI_ResponsibleParty.CI_RoleCode (code list)	function performed by the responsible party	Adopted by and added to GDF Metadata
Metadata Date Stamp	√		MD_Metadata.dateStamp (CharacterString)	date that the metadata was created.	Adopted by and added to GDF Metadata
Dataset Title		√	CI_Citation .datasetTitle (CharacterString)	dataset name	Dataset Title
Dataset Reference Date		√	CI_Citation .CI_Date (CharacterString)	reference date	Adopted by and added to GDF Metadata
Dataset Reference Date Type		√	CI_Citation .CI_DateTypeCode (code list)	event used for reference date	Adopted by and added to GDF Metadata

Abstract		√	Character String	brief narrative summary of the content of the resource(s)	Adopted by and added to GDF Metadata
Geographic Extent (Optional)		√	Can be geographic extents (EX_GeographicBoundingBox) or by identifier (EX_GeographicDescription).	spatial extent of data	Spatial Domain, in terms of Geographic Bounding Box or Area Name.
Dataset Language		√	MD_DataIdentification.language (code list)	language(s) used within a Dataset	Dataset Language
Topic Category			MD_TopicCategoryCode (code list)	main themes (topics) of the Dataset	Adopted by and added to GDF Metadata

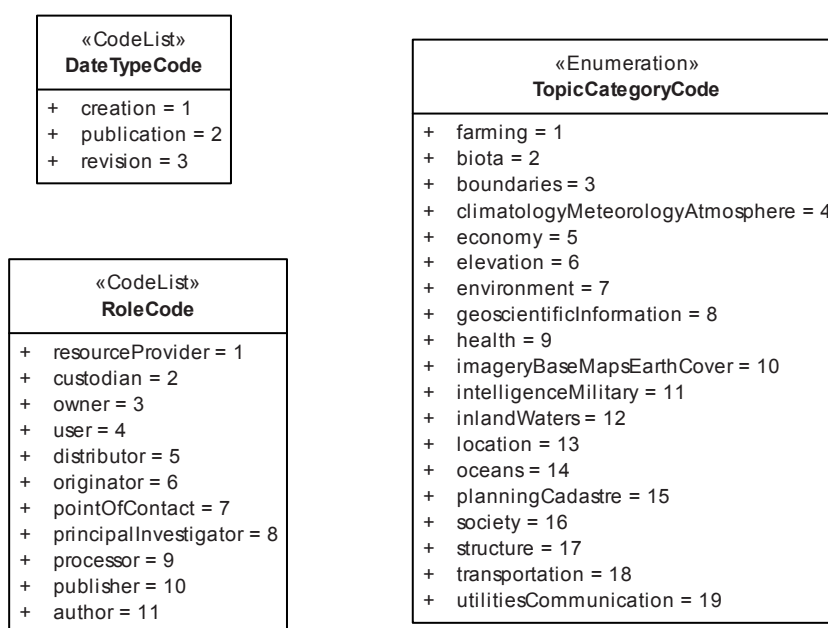

Figure 214 — Code Lists and Enumerations reused from ISO 19115

10.1.2 Syntax of the Metadata description

This is described in detail as part of physical format definitions (such as in Clause 12, Media Record Specifications).

10.1.3 Partitioning of GDF

Each GDF is split up into subparts in order to keep the Dataset manageable. This is called partitioning. A GDF is partitioned into Information Units (generally applicable to the Logical Data Structure and any physical format) and Medium Units (possibly applicable to a physical format in which case Medium Units are further detailed as part of the physical format specification in question).

Information unit partitions describe the characteristics of the data which as a whole is equivalent to the Album. There are three levels of information units within an Album: the Dataset, the Layer, and the Section.

10.1.3.1 Album

A collection of Datasets.

10.1.3.2 Dataset

The highest level of partitioning into Information Unit. The term designates a large set of data of a particular geographic area, created at a particular moment and delivered by a particular data supplier.

10.1.3.3 Layer

A subset of a Dataset. It comprises either a planar graph composed of Nodes, Edges, and Faces (planar topology), a non-planar graph composed of Nodes and Edges (non-planar topology), or it comprises a non-explicit topological representation of Features and their geometries. A Layer may represent one or more Feature Themes.

10.1.3.4 Section

A Section is a geographical subset of a Layer.

10.2 Headers and terminators

10.2.1 General

The information and medium units into which a Dataset has been partitioned can be identified by use of headers.

According to the names of the units, these headers are called Album Header, Dataset Headers, Layer Headers and Section Headers.

10.2.2 Album Header

10.2.2.1 General

Each Album starts with an Album Header. This header specifies global Album related characteristics. Furthermore, it specifies the links to the Datasets associated with the Album.

An Album Header contains the following items:

- Short Organisation Name
- Organisation Name
- Role Code
- Standard Name
- Version Number
- Album Size
- Album Identifier
- Default Character Set
- Associated Datasets
- Local Character Set Definition Information

- Creation Date
- Metadata Date Stamp
- Date of Copyright
- Copyright Owner

10.2.2.2 Short Organisation Name

The short name of the main producer and/or deliverer of the Album specified by using the default character set.

10.2.2.3 Organisation Name

The name of the main producer and/or deliverer of the Album.

The producer is taken to mean the company with the responsibility for the production of the Album, not the company responsible for the source material, if they are different.

Where there is more than one major producer of the Album, a combination of names can be given.

All other producers involved will be described in detail in the Dataset Header.

10.2.2.4 Role Code

The function performed by the main producer and/or deliverer of the Album.

Roles are defined by the Code List Role Code and will be defined at the time of Album publication. Annex B.4.2 provides the TC211-adopted description of Role Code. The following values have been fixed:

1 = Resource provider

2 = Custodian

3 = Owner

4 = User

5 = Distributor

6 = Originator

7 = Point of contact

8 = Principal investigator

9 = Processor

10 = Publisher

11 = Author

10.2.2.5 Standard Name

The name of the standard to which the Album conforms.

10.2.2.6 Version Number

The number of the version or release of the standard to which the Album conforms.

10.2.2.7 Album Size

The size of the present Album expressed in bytes.

10.2.2.8 Album Identifier

The unique identification number of the Album.

Each physical occurrence of an Album gets its own identification number, even when the Album is an exact copy of another one.

10.2.2.9 Default Character Set

The character set applicable for the entire Album as a default. This setting may be overridden by Local Character Set definitions.

The following character set designators have been fixed [8] [9] [10] [11] [12] [13] [14] [15] [16] [17] [18] [19] [20] [21] [22] [24]:

1 = ISO 8859-1 (Latin-1)

2 = ISO 8859-2 (Latin-2)

3 = ISO 8859-3 (Latin-3)

4 = ISO 8859-4 (Latin-4)

5 = ISO 8859-5 (Cyrillic)

6 = ISO 8859-6 (Arabic)

7 = ISO 8859-7 (Greek)

8 = ISO 8859-8 (Hebrew)

9 = ISO 8859-9 (Latin-5)

10 = ISO 8859-10 (Latin-6)

11 = ISO 8859-11 (Thai)

12 = reserved/not used

13 = ISO 8859-13 (Latin-7)

14 = ISO 8859-14 (Latin-8)

15 = ISO 8859-15 (Latin-9)

16 = ISO 8859-16 (Latin-10)

17 ~ 29 = reserved for future use

30 = ISO/IEC 10646 Annex D (Unicode - UTF-8)

10.2.2.10 Associated Datasets

10.2.2.10.1 Introduction

Specifies which Datasets can be found in the present Album .

It consists of the Number of Datasets in the Album, and a Dataset Identifier.

10.2.2.10.2 Number of Datasets

The number of Datasets that are associated with the Album.

10.2.2.10.3 Dataset Identifier

For each Dataset, the identification number of the Dataset header which is related to the Album.

10.2.2.11 Local Character Set Definition Information

10.2.2.11.1 Introduction

Local Character Set Information used in the Album.

10.2.2.11.2 Local Character Set

Designation of a Local Character Set used in the Album.

The following character set designators have been fixed [8] [9] [10] [11] [12] [13] [14] [15] [16] [17] [18] [19] [20] [21] [22] [24] [47] [48]:

1 = ISO 8859-1 (Latin-1)

2 = ISO 8859-2 (Latin-2)

3 = ISO 8859-3 (Latin-3)

4 = ISO 8859-4 (Latin-4)

5 = ISO 8859-5 (Cyrillic)

6 = ISO 8859-6 (Arabic)

7 = ISO 8859-7 (Greek)

8 = ISO 8859-8 (Hebrew)

9 = ISO 8859-9 (Latin-5)

10 = ISO 8859-10 (Latin-6)

11 = ISO 8859-11 (Thai)

12 = reserved/not used

13 = ISO 8859-13 (Latin-7)

14 = ISO 8859-14 (Latin-8)

15 = ISO 8859-15 (Latin-9)

16 = ISO 8859-16 (Latin-10)

17 ~ 29 = reserved for future use

30 = ISO/IEC 10646 Annex D (Unicode - UTF-8)

31 = ISO/IEC 10646 (Unicode - UCS-2)

32 = ISO/IEC 10646 (Unicode - UCS-2, big endian)

33 ~ 49 = reserved for future use

50 = Shift-JIS (Japanese)

51 = KS X 1001 (Korean)

52 ~ 99 = reserved for the User Defined

10.2.2.11.3 Organization Information

Specification of the ISO 3166 alpha-3 country code of the country of the organization maintaining the Local character set.

10.2.2.11.4 Character Set Code Table Name

The Character Set Code Table Name for the character set used in the Album.

10.2.2.11.5 Character Set Code Table Version Number

The version number of the Character Set Code Table.

10.2.2.11.6 Local Character Sub-string Delimiter Codes (Local-In, Local-Out)

10.2.2.11.6.1 Introduction

The Local-In (start) and Local-Out (end) code values to be used to separate a sub-string of local characters from the surrounding one-byte text.

The Local-In code marks the beginning of a sub-string of local characters and Local-Out marks the end.

By not specifying these delimiter codes, the local character set at hand becomes the default character set for Fields of type L (overruling the general default character set). Only one default character set may be declared; for any other local character set Local In and Local Out Codes must be provided.

10.2.2.11.6.2 Local-In Code

The value used as the Local-In Code.

10.2.2.11.6.3 Local-Out Code

The value used as the Local-Out Code.

10.2.2.11.7 Language Code

The ISO 639-2 language code(s) [1] of (a) language(s) applying to the specified Character Set Code Table

10.2.2.11.8 Collating Sequence

Designation of the collating sequence, i.e. the order in which character strings should be placed when sorting them, by means of ISO 639-2 language code for each language associated with the specified Character Set Code Table.

10.2.2.12 Creation Date

The date of creation of the physical copy of the Album.

10.2.2.13 Metadata Date Stamp

The date of creation of the metadata for the Album.

Metadata Date Stamp is a string which shall follow the format for date specified by ISO 8601 basic format, i.e. YYYYMMDD, without separators [6].

10.2.2.14 Date of Copyright

The date that the (possible) copyrights of the present Album, if any, were registered.

10.2.2.15 Copyright Owner

The name of the owner of the (possible) copyrights of the present Album, if any.

10.2.3 Dataset Header

10.2.3.1 Introduction

This marks the beginning of a new Dataset and the end of the previous one.

The Dataset Header contains the following items:

- International Dataset Identification Number
- Supplier Dataset Identification Number
- Edition Date
- Unit System
- Dataset Language
- Country Involved
- Default Language
- Dataset Title
- Production Info
- Creation Year
- Dataset Reference Date
- Reference Date Type
- Abstract

- Dataset Geographical Coverage
- Thematical Coverage
- Dataset XY Resolution
- Dataset Topic Category

10.2.3.2 International Dataset Identification Number

An identification number that is unique world wide. To guarantee the uniqueness of these identification numbers, the distribution has to be coordinated by an international organization. This item will be left empty until such agreements are made.

10.2.3.3 Supplier Dataset Identification Number

An identification number that is unique within the system of a data supplier or within the system of a group of suppliers. The same technique can be followed as for the assignment of Album Identifiers.

10.2.3.4 Edition Date

Date and hour that this particular version of the Dataset has been created.

When a Dataset is changed completely or changed on essential points, it will be considered as a new Dataset and receive a new Dataset identification number. When there have been only minor changes (e.g. corrections and additions), the Dataset can keep its former identification number. In such cases the Edition Date is used to denote the version number of the Dataset.

10.2.3.5 Unit System

An enumeration of “English” or “Metric” specifying the default unit system for the entire Dataset.

10.2.3.6 Dataset Language

The ISO 639-2 Language Code [1] of a language which is used in the Dataset Header and Layer Headers or in the data. Clause B.1 gives an overview of ISO 639-2 Language Codes.

10.2.3.7 Countries Involved

The ISO 3166 alpha-3 code of the countries involved in the production of the Dataset in issue. Clause B.2 gives an overview of ISO 3166 codes.

10.2.3.8 Default Language

The ISO 639-2 Language Code [1] of a language used as the default language of character strings in this Dataset. Clause B.1 gives an overview of ISO 639-2 Language Codes.

10.2.3.9 Dataset Title

10.2.3.9.1 Introduction

The title and subtitles of a Dataset. The item may have multiple instances in case a Dataset Title is given in more than one language.

It is composed of a Dataset Title Language, a Dataset Main Title, and a Dataset Subtitle.

10.2.3.9.2 Dataset Title Language

The ISO 639-2 Language Code [1] (see Clause B.1) of the language in which the Dataset Title is written.

10.2.3.9.3 Dataset Main Title

The proper title of a Dataset.

10.2.3.9.4 Dataset Subtitle

A possible subtitle of the Dataset.

The language used should be the same as that used in Dataset Main Title.

10.2.3.10 Production Information

10.2.3.10.1 Introduction

Information about the producers and the production places of the Dataset. The item may repeat as many times as needed to list all producers and places of production.

Production Information lists the Production Country, the Production Place, and the Producer Name.

10.2.3.10.2 Production Country

The ISO 3166 alpha-3 country code (see Clause B.2) of the country in which the place of production is situated.

10.2.3.10.3 Production Place

The place name of the location of the producer such as a city, town or village.

Should the producer have more than one office location state only the location of the company's headquarters and/or the location of the real production division.

The name of the location shall be written in the major national language at that location.

EXAMPLE 1 "London" and not "Londres".

EXAMPLE 2 "Mons" and not "Bergen".

EXAMPLE 3 "Antwerpen" and not "Anvers".

In completely bilingual cases, both names may be specified.

EXAMPLE 4 "Bruxelles"/"Brussel".

This requires the use of two different Production Information instances.

10.2.3.10.4 Producer Name Language

The ISO 639-2 Language Code [1] (see Clause B.1) of the language used to specify the Producer Name.

10.2.3.10.5 Producer Name

The name of a producer of the Dataset. In case a producer is known by different names (multinationals, in multilingual countries), each of these names must be specified in a separate Production Information instance.

The producer is the organization which has entirely or partly the intellectual Property of the Dataset.

10.2.3.11 Creation Year

The year of creation of the intellectual and logical content of the Dataset.

10.2.3.12 Dataset Reference Date

The reference date of the intellectual and logical content of the Dataset.

Dataset Reference Date is a string which shall follow the format for date specified by ISO 8601 basic format [6], i.e. YYYYMMDD.

10.2.3.13 Reference Date Type

Event used for the Dataset Reference Date.

Reference Date Type can be one of three types:

- Creation
Identifies when the Dataset was brought into existence.
- Publication
When the Dataset was issued
- Revision
When the Dataset was examined or re-examined and improved or amended.

10.2.3.14 Abstract

Brief narrative summary of the content of the Dataset.

10.2.3.15 Dataset Geographical Coverage

The name of a geographical area that is representative for the area covered by the Dataset.

EXAMPLE A political or economical area, or a landscape unit.

10.2.3.16 Thematic Coverage

10.2.3.16.1 Introduction

This describes a Feature Theme Code and a Feature Theme Name.

10.2.3.16.2 Feature Theme Code

The code of a Feature Theme contained in the present Dataset. Permissible theme codes are described in Clause A.1.

10.2.3.16.3 Feature Theme Name

The name of a Feature Theme contained in the present Dataset. Permissible theme names are described in Clause A.1.

10.2.3.17 Dataset XY Resolution

The worst case planimetric resolution anywhere in the Dataset, expressed in meters.

The worst case resolution shall be expressed in metres as whole numbers. Non integer values shall be rounded off upwards: e.g. a resolution of 1,25 m shall be rounded to 2 m.

The determination of this worst case shall be based on the corresponding resolution values in the Layer Headers. The worst case resolution corresponds with the maximum of the values found in the Layer Headers.

10.2.3.18 Dataset Topic Category

Enumeration of the possible main themes of a Dataset. The value for a particular Dataset is defined at time of publication. Annex B.4.3 provides the ISO 19115 description of Dataset Topic Category [28]. The following values have been fixed:

- 1 = Farming
- 2 = Biota
- 3 = Boundaries
- 4 = Climatology / meteorology / atmosphere
- 5 = Economy
- 6 = Elevation
- 7 = Environment
- 8 = Geoscientific information
- 9 = Health
- 10 = Imagery base maps earth cover
- 11 = Intelligence military
- 12 = Inland waters
- 13 = Location
- 14 = Oceans
- 15 = Planning cadastre
- 16 = Society
- 17 = Structure
- 18 = Transportation
- 19 = Utilities communication

10.2.4 Layer Header

10.2.4.1 Introduction

The Layer Header indicates the beginning of a new Layer and the end of the previous one.

It contains the following data items:

- Layer Identifier
- Thematic Coverage
- Level-0 Network Topology
- Edge Height Level Referencing
- Layer XY Resolution
- Layer Geometry Accuracy Level

10.2.4.2 Layer Identifier

This number must be unique within the set of all Layer Identification Numbers for a particular Dataset.

10.2.4.3 Thematic Coverage

Indication of the Feature Theme(s) that belong to a particular Layer.

10.2.4.4 Level-0 Network Topology

Indication of the topology of the level-0 network in this Layer. The following topology types are allowed:

- Non-explicit Topology
No topological relations between objects are explicitly defined. That is, topological relations are only defined via coordinate values.
- Non-planar topology
Topological relations are explicitly defined, Objects may fully or partially coincide, or intersect or overlap each other.
- Planar topology
Topological relations are explicitly defined, Objects must not fully or partially coincide, and must not intersect or overlap each other. Intersecting/overlapping objects lead to fragmentation, whereby common parts are present exactly once.

10.2.4.5 Edge Height Level Referencing

The method of Edge height level referencing applied in this Layer.

- Implied by coordinates
The Z coordinate of the Nodes referenced by the Edge and the Intermediates of the Edges in this Layer specify the geographic height level according to the coordinate system applied.

- Achieved via Edge levels

The height of Edges in this Layer is not specified as part of the definition of the Edge itself. Instead, the relative height of the start, the middle and the end of Edges in this Layer is specified in combination with their use in the definition of the Line Feature(s) they represent. The relative height can range from –9 to +99.

- Achieved only via Grade-separated Crossing Relationships

The height level information in the Layer is not specified via Z coordinates. Instead, the relative height levels are specified via the Relationship Grade-separated Crossing.

- No height level referencing

No height levels are specified in this Layer.

NOTE 1 Grade-separated Crossings can appear in combination with the values implied by coordinates and achieved via Edge levels.

NOTE 2 The relative height of Edge levels may be greater than 9 (up to 99) when modelling vertical connectivity of Pathway Features connecting floors in high-rise buildings. When modelling road, rail or water transportation networks, the maximum Edge level is set to +9.

10.2.4.6 Layer XY Resolution

Information about the resolution of the Layer. The values which shall be specified for resolution are worst case values expressed in metres.

10.2.4.7 Layer Geometry Accuracy Level

10.2.4.7.1 General

For all geometry present in a given Layer, accuracy levels can be specified. Use case for this is terrain surface modelling using tessellated surface areas or gridded data.

10.2.4.7.2 Horizontal Accuracy Level

A user-defined horizontal accuracy level measure, such as Root Mean Square Error (RSME) or the like. The actual measure chosen can be textually described.

10.2.4.7.3 Vertical Accuracy Level

A user-defined vertical accuracy level measure, such as Root Mean Square Error (RSME) or the like. The actual measure chosen can be textually described.

10.2.5 Section Header

10.2.5.1 Introduction

The Section Header indicates the start of a new Section and the end of the previous one. It contains information and the parameters which are essential for interpretation and processing of some of the Fields in the data records.

A Section Header contains the following items:

Section Identification Number

Section Geographic Coverage

Section XY Resolution

Lane Counting Direction

Source Document

Geodetic Datum

Reference Ellipsoid

Horizontal Reference Type

Projection Method

National Map Grid

Magnetic Declination

Height Reference Type

Geoid Undulation

Coordinate Offset

Section Border

Planimetric Control Point

Height Control Point

Network Specification Identifier

Artificial ETA Connectivity

10.2.5.2 Section Identification Number

This number must be unique within the set of all Section Identification Numbers for a particular Layer.

10.2.5.3 Section Geographic Coverage

The name of a geographical area that is representative for the area covered by the Section. Rules are as for Dataset Geographic Coverage Section.

10.2.5.4 Section XY Resolution

Information about the resolution of the Section. The values which shall be specified for resolution are worst case values expressed in metres.

10.2.5.5 Lane Counting Direction

The convention for default direction of lane counting in a Section.

This field can be used in cases where all instances of the Restrictive Sub-Attribute Lane-Dependent Validity in a given Section deliberately use the same convention for the counting direction.

NOTE The counting direction is repeated within each Attribute value of Lane-Dependent Validity.

10.2.5.6 Source Document

See Sub-clause 10.5.2.

10.2.5.7 Geodetic Datum

See Sub-clause 10.6.2.

10.2.5.8 Reference Ellipsoid

See Sub-clause 10.6.4.

10.2.5.9 Horizontal Reference Type

An indicator which specifies whether the coordinate values in the Section must be interpreted as **geographical** coordinates (latitude and longitude), or as X- and Y-values within a **rectangular** plane coordinate system (with linearly divided axes and equal length units along these axes).

The indicator can express two different values:

Geographical coordinates

Rectangular Plane coordinates

10.2.5.10 Projection Method

See Sub-clause 10.6.5.

10.2.5.11 National Map Grid

See Sub-clause 10.6.6.

10.2.5.12 Magnetic Declination

See Sub-clause 10.6.8.

10.2.5.13 Height Reference Type

An indicator which specifies whether the Z-values in this Section must be interpreted as ellipsoidal heights or as orthometric heights.

The indicator may have one of three values:

Ellipsoidal heights

Orthometric heights

Relative heights

10.2.5.14 Geoid Undulation

See Sub-clause 10.6.7.

10.2.5.15 Coordinate Offset

10.2.5.15.1 Introduction

Contains the following components:

- XY Multiplication Factor
- Z Multiplication Factor
- X Offset
- Y Offset
- Z Offset

10.2.5.15.2 XY Multiplication Factor

The multiplication factor (M) of the X and Y coordinate values in the data records in this Section, expressed as $10\log M$. This makes it possible to specify coordinates which have a higher resolution than the length unit, or to delete non relevant zeros at the end of coordinate values with a coarse resolution.

Only integer values of $10\log M$ are allowed. Positive values must be preceded by a plus sign (+); negative values by a minus sign (-).

EXAMPLE 1 A value of -2 means a multiplication factor of 0,01.

EXAMPLE 2 A value of -1 means a multiplication factor of 0,1.

EXAMPLE 3 A value of 0 means a multiplication factor of 1.

EXAMPLE 4 A value of 1 means a multiplication factor of 10.

EXAMPLE 5 A value of 2 means a multiplication factor of 100.

10.2.5.15.3 Z Multiplication Factor

A multiplication factor of the Z-values in a particular Section, expressed as $10\log M$.

10.2.5.15.4 X Offset

The offset value for all the X-coordinates in the data records in this Section. This value must be added to all the X-coordinate values in the data records to obtain national grid coordinate values.

Use of the X-offset reduces the length of the coordinate values in the individual data records.

10.2.5.15.5 Y Offset

Contains the offset value for all the Y-coordinates in a particular Section. Rules as for X Offset.

10.2.5.15.6 Z Offset

Contains the offset value for all the Z-coordinates in a Section. Rules as for X Offset.

When a Section does not contain Z-values, Z Offset shall remain blank.

10.2.5.16 Section Border

Contains the following components:

- **Maximum X:** The maximum value of any X-coordinate in the Section.
- **Maximum Y:** The maximum value of any Y-coordinate in the Section.
- **Minimum X:** The minimum value of any X-coordinate in the Section.
- **Minimum Y:** The minimum value of any Y-coordinate in the Section.

NOTE In the specification of the maximum and minimum values, X Offset and Y Offset values are not added or included in these Attributes.

10.2.5.17 Planimetric Control Point

10.2.5.17.1 Introduction

A Point Feature with highly accurate X and Y coordinates. May be used to check the accuracy of coordinates obtained from digitizing. The Planimetric Control Point contains the following components:

10.2.5.17.2 Point Name

An identifier for the Point Feature. This can be the name or number, or a combination of both, by which the Point is known in the catalogue of a local organization for land surveying.

If the uniqueness of the identifier cannot be guaranteed within a larger context, it must be preceded by the name of the town to which it belongs, or by the name of the survey organization responsible for its delivery.

10.2.5.17.3 X Digitized

The value of the X-coordinate, expressed in centimeters, as obtained by digitizing a paper map or by another indirect method of data capture, such as photogrammetry.

10.2.5.17.4 Y Digitized

The value of the Y-coordinate, expressed in centimeters, of the point in issue as obtained by digitizing a paper map or by another method of indirect surveying.

Rules as for X Digitized.

10.2.5.17.5 X Surveyed

The value of the X-coordinate, expressed in centimeters, as delivered by a land survey organization.

10.2.5.17.6 Y Surveyed

The value of the Y-coordinate, expressed in centimeters, as delivered by the land survey organization.

10.2.5.18 Height Control Point

10.2.5.18.1 Introduction

A Point Feature with highly accurate coordinates. May be used to check the accuracy of coordinates obtained from photogrammetry.

A Height Control Point contains the following components:

10.2.5.18.2 Point Name

As for Planimetric Control Point.

10.2.5.18.3 X Reference

The X-coordinate of the point specified in the same length unit as used in the data records in this Section.

10.2.5.18.4 Y Reference

The Y-coordinate of the point specified in the same length unit as used in the data records in this Section.

10.2.5.18.5 Z Digitized

The value of the Z-coordinate of the point obtained by means of the same technique by which the Z-values in the data records have been determined (e.g. interpolation of contour lines on a paper map or obtained by stereo restitution).

The Z-value shall be expressed in centimeters.

10.2.5.18.6 Z Surveyed

The value of the Z-coordinate, expressed in centimeters, as delivered by a survey organization.

10.2.5.19 Network Specification Identifier

The specification of the kind of (road) networks which are present in the Section.

10.2.5.20 Artificial ETA Connectivity

An indicator which specifies whether artificial connectivity is present for all Enclosed Traffic Areas (ETA) within the Section for representing connectivity within Enclosed Traffic Areas (ETA) between connected Road Elements and/or connected Pathways.

The indicator can express two different values:

Artificial ETA connectivity not present

Artificial ETA connectivity present

10.3 Data Dictionary

10.3.1 General

All Field, record, Feature and Attribute Types that are used in a particular GDF shall be defined explicitly at the beginning of a Dataset.

The definition is split into four parts: Field Definition, Record Definition, Feature Definition and Attribute Definition. These definitions immediately follow the Dataset header in the order stated.

10.3.2 Field Definition

10.3.2.1 Introduction

The Field types which are used in a particular Dataset. Each occurrence of a Field-type will be represented by one occurrence of a Field Definition. Therefore, there should be as many occurrences of Field Definition in the file as there are Field types. For the definition of Fields, records will be used which also consist of Fields. These last Fields also need to be defined in Field Definition.

Field Definition contains the following items:

Field Name

Field Size

Data Type

Data Unit Type

Data Unit

Unit Exponent

No Data

Field Value Domain

Field Class

Field Description

10.3.2.2 Field Name

The name of a particular Field type. This may be any string of printable characters, excluding the Space character.

The maximum name length of Fields is 10 characters.

10.3.2.3 Field Size

The length of a particular Field expressed as the number of character positions that have been reserved for that Field.

The length of a fixed length Field is specified by a positive integer value which can range from 1 to 99.

A variable length Field is indicated by means of the value = 0.

Field types of Data Type L may contain multi-byte characters and thus shall be no shorter than 4 bytes. Alternatively, such Field types may have a variable Field length.

10.3.2.4 Data Type

The subset of Global/Local Character Set characters allowed in a particular Field type. The Valid Data Type values are:

L ::= {<space>|<printable character>| <local character string> }
 G ::= <space>|<printable character> {<printable character>| Space character}
 A ::= <space>|<alphabetic character> {<alphabetic character>| Space character}
 AN ::= <space>|<alphanumeric character> {<alphanumeric character>| Space character}
 N ::= {Space character} {<digit>}
 I ::= {Space character} [<sign character> <digit> {digit}]

where

<printable character> ::= <alphanumeric character> |<graphic character>|<sign character>
 <alphanumeric character> ::= <alphabetic character>|<digit>
 <alphabetic character> ::= A| B| C| ...Z| a| b| c| ... z| <ISO/IEC 8859-1 character 12/0 - 15/15>
 <digit> ::= 0| 1| 2| 3| 4| 5| 6| 7| 8| 9|
 <graphic character> ::= !| "| #| \$| %| &| ' | (|)| *| ,| /| :| ;| <| =| >| ?| @| [| \ |]| ^| _| `| { | || }| ~|
 <ISO/IEC 8859-1 character 10/01 - 10/12>|
 <ISO/IEC 8859-1 character 10/14 - 11/15>
 <sign character> ::= +| -
 <space> ::= Space character {Space character}
 Space character ::= the ISO/IEC 8859-1 character 2/0

and where

<local character string> ::= <local-in code> {<local character>} <local-out code>
 <local character> ::= character from user-defined local character set
 <local-in code> ::= <double character>
 <local-out code> ::= <double character>
 <double character> ::= character from default character set, character from default character set

The symbols used in the above mentioned production rules have the following meaning:

:: = is replaced by, produces, consists of
 | exclusive or
 [] term enclosed is optional (used zero, or one times)
 {} term enclosed is optional (used zero, one, or more times)
 <> term enclosed is non-terminal
 , exists together with
 indicates a repetitive list of similar items

10.3.2.5 Data Unit Type

Specifies the data unit type as either a unit of measure (MSR) or a GDF defined unit.

10.3.2.6 Data Unit

Indication of the unit in which the values in the Field type in question are expressed.

Only units as specified in the list below are allowed. Other units using decimal prefixes (cm, gram etc.) shall be split into a basic unit and an exponent value. The exponent shall be represented by means of Unit Exponent.

The following units of measure and their corresponding codes are applicable:

DEG = Degree

MTR	=	Metres
KMR	=	Kilometre
INC	=	Inch
FET	=	Feet
MIL	=	Mile
KGR	=	Kilogram
PND	=	Pound (US pound)
KIP	=	Kilo Pound
TON	=	Ton (metric ton)
MIN	=	Minute (of time)
KPH	=	Kilometres per hour
MPH	=	Miles per hour
YMD	=	Year, month, day
MDH	=	Month, day, hour
YXH	=	Year, month, day, hour
OTH	=	Other SI-unit, to be described in Field Description

The following GDF-defined data units are allowed:

COD	=	Code list
ENM	=	Enumeration
CNT	=	Number
BOL	=	Boolean
BMR	=	Bit Mask Register (binary number as binary)
BMI	=	Bit Mask Integer (binary number as decimal)
TIM	=	Time
SCS	=	(Simple) Character String
PRC	=	Percentage
CMP	=	Composite
IDN	=	Identifier
PRS	=	Signed Percentage

In case the Field type in question does not contain a value that is expressed in a particular unit of measure (e.g. when the Field-type contains a free text comment), Data Unit shall be left empty.

10.3.2.7 Unit Exponent

The multiplication factor to be applied to the values in a particular Field type in order to convert them to the unit of measurement as specified in Data Unit.

The Unit Exponent is expressed as an exponent of 10.

The exponent shall be preceded by a plus (+) or minus (-) sign, and can range from -9 to +9.

In case the values do fit directly with the unit of measurement as specified in Data Unit, Unit Exponent shall contain the value = 0 (which corresponds to a multiplication factor of 1).

Example of the use of Data Unit and Unit Exponent:

Value	Data Unit	Unit Exponent	Value in field
2,65 m	MTR	-2	265
377 mm	MTR	-3	377
75 km/h	KMH	0	75
45 %	PRC	0	45
30 October 1986	YMD	<S>	19861030

10.3.2.8 No Data

The characters the Field will contain in the case that the Field is “empty”, i.e. has “no data”. There are the following possibilities:

<S> The empty Field will contain Space characters. This is needed in, but not restricted to, Fields of Data Type N and I, where 0 is a meaningful value.

{a valid value} The empty Field will contain any value allowable for the data type in question, and within the valid value range in case of data type N, and for the rest Space characters. This may be needed in Fields of data types other than N or I, where a string of spaces is a meaningful value.

Obl The Field is not allowed to be empty as a correct interpretation of the data would be impossible.

10.3.2.9 Field Value Domain

10.3.2.9.1 Introduction

A logical domain of the values in a particular Field type in terms of its allowable minimum and maximum values. This may be quite different from the physical domain.

10.3.2.9.2 Minimum Value Allowed

The allowable minimum value of a particular Field type.

10.3.2.9.3 Maximum Value Allowed

The allowable maximum value of a particular Field type.

10.3.2.10 Field Class

Indication of the kind of use and purpose of a particular Field type. The following Field classes are specified:

- 1 = Entity
- 2 = Foreign Identifier
- 3 = Field Counter
- 4 = Other

10.3.2.11 Field Description

Textual description of the content and use of a particular Field type.

10.3.3 Record Definition

10.3.3.1 Introduction

The specification of a record type that is used in the Dataset. Each of the record types in a particular Dataset must be represented by one Record Definition. There will be as many occurrences of Record Definition in the Dataset as there are record types. For the definition of records, records also will be used. These last records also need to be defined in Record Definition.

Record Definition contains the following items:

Record Type Code

Record Subtype Code

Record Name

Field Name List

Repeating Field Flag

Record Type Description

10.3.3.2 Record Type Code

The reference code of a particular record type. This code value will be found at the beginning of each occurrence of a record of that particular type.

Only numerical codes containing 2 digits are allowed. The code containing two Space characters shall be assigned to the null record.

10.3.3.3 Record Subtype Code

A possible record subtype code of a record.

It is possible to subdivide a particular record type into 99 different subtypes by building in a Record Subtype Code. It is a digit code the value of which will be found in each occurrence of that record subtype. In case a record type is not subdivided into subrecords, the Record Subtype Code shall remain empty.

10.3.3.4 Record Name

The name by which a record type is referred to in a specification document.

Any string of printable characters up to a maximum length of 10 is allowed.

10.3.3.5 Field Name List

A list of Field names defined by means of Field Name in Field Name Definition. The different instances of Field Name in Field Name List must occur in the same order as the corresponding data Fields do in any occurrence of the record type itself.

10.3.3.6 Repeating Field Level

Repeating Fields are marked by means of specifying a level that indicates the nesting of a repeating Field within another (lower-level) group of repeated Fields. A Repeating Field Level of 0 means that the Field is not repeated.

In a given sequence of Fields, the Repeating Field Level may be incremented, decremented, or kept constant compared to the Repeating Field Level of the respective previous Field. Increments and decrements larger than 1 level must not occur.

10.3.3.7 Record Type Description

Textual description of the record type.

10.3.4 Feature Definition

10.3.4.1 Introduction

The definition of a Feature Class, with corresponding Feature Class Name, Feature Class Code and Feature hierarchy information.

Feature hierarchies can be specified for Features from the Feature Themes Land Cover and Use, Road Furniture, Services, and for user-defined Features. The hierarchy is specified in terms of a list of (optional) sub-types of a particular Feature Class. These sub-types are Features in their own right and are to be defined by separate Feature definitions. This implies that any sub-type may be further sub-typed. Within the definition of the list of Feature Class sub-types, the sub-types are referred to by their Feature Class Codes.

Feature Definition consists of the following items:

- Feature Class Code
- Language Code
- Feature Class Name
- Feature Description
- Feature Hierarchy Information

10.3.4.2 Feature Class Code

A four digit code of the Feature Class in question.

10.3.4.3 Language Code

The ISO 639-2 Language Code [1] of the language used in Feature Class Name (for codes, see Clause B.1).

10.3.4.4 Feature Class Name

A name for the Feature Class. Feature Class Names shall have an uppercase character at the beginning of the individual words. The other characters shall be lower case.

For each Feature Class, names can be specified in multiple languages.

10.3.4.5 Feature Description

Textual description of the Feature Class.

10.3.4.6 Feature Hierarchy Information

10.3.4.6.1 Introduction

The Feature hierarchy information consists of the number of hierarchical levels, a list of (optional) sub-types of a particular Feature Class and further textual descriptions of the sub-types.

10.3.4.6.2 Number of Hierarchical Levels

The number of levels in the hierarchical tree to which a particular Feature belongs. In case of the definition of a non-hierarchical Feature, the number shall be set to one.

10.3.4.6.3 Sub-type Feature Class Code

Specification of a direct sub-type of the particular Feature Class in issue by means of a four-digit Feature Class Code from the Feature Themes Land Cover and Use, Road Furniture, Services, and for user-defined Features.

10.3.5 Attribute Definition

10.3.5.1 Introduction

Parameters of the Attribute subfields that belong to a particular Attribute Type.

Attribute Definition contains the following items:

- Attribute Type Code
- Language Code
- Attribute Type Name
- Attribute Value Data Type
- Maximum Attribute Value Width
- Attribute Data Type
- Attribute Data Unit
- Attribute Base Unit and Conversion Factor
- Attribute Value Domain
- Attribute Description

10.3.5.2 Attribute Type Code

The code of a particular Attribute Type. The code consists of two printable characters.

The code value must correspond to the code value as used in the individual occurrences of the Attribute Field in issue.

10.3.5.3 Language Code

The ISO 639-2 Language Code [1] of the language used in Attribute Type name (for codes, see Clause B.1).

10.3.5.4 Attribute Type Name

A name for the Attribute Type. Attribute Type names shall have an uppercase character at the beginning of the individual words. The other characters shall be lowercase.

For each Attribute Type, names can be specified in multiple languages.

10.3.5.5 Attribute Value Data Type

See Sub-clause 10.3.2.4.

10.3.5.6 Maximum Attribute Value Width

The maximum Width of an Attribute Value in terms of the number of digits or characters. This Width can range from 1 to 11. Special provisions are made for Time and Language-Coded Text values whose width can be greater than 11.

10.3.5.7 Attribute Data Type

The applicable data type of the Attribute type in question.

COD = Code List

ENM = Enumeration

CNT = Number

BOL = Boolean

BMR = Bit Mask Register (binary number as binary)

BMI = Bit Mask Integer (binary number as decimal)

TMR = Time Domain (GDF Time Domain syntax)

SCS = (Simple) Character String

TXT = (Language-Coded) Text

PRC = Percentage

CMP = Composite

IDN = Identifier

GSD = Geopolitical Structure Definition

PRS = Signed Percentage

MSR = Measure (with the Attribute's Unit of Measure being specified separately; see 10.3.5.8 and 10.3.5.9)

10.3.5.8 Attribute Data Unit

The following units of measure and their corresponding codes are applicable as either metric or English default attribute units (see 7.1.15). This is a subset of all units of measure applicable to Fields as part of Field definitions (see 10.3.2.6).

DEG = Degree

MTR = Metres

KMR = Kilometre

INC = Inch

FET = Feet

MIL = Mile

KGR = Kilogram

PND = Pound (US pound)

KIP= Kilo Pound

TON = Ton (metric ton)

MIN = Minute (of time)

KPH = Kilometres per hour

MPH = Miles per hour

10.3.5.9 Attribute Base Unit and Conversion Factor

10.3.5.9.1 General

In the event that a unit of measure other than any of the Metric or English default units is applicable, a base unit and a conversion factor expressed in terms of the base unit shall be used.

10.3.5.9.2 Attribute Base unit

The following base units are applicable:

DEG = Degree

MTR = Metres

KGR = Kilogram

MIN = Minute (of time)

KPH = Kilometres per hour

10.3.5.9.3 Conversion factor

The unit of measure is expressed by multiplying the base unit by a conversion factor. The conversion factor is expressed in terms of a mantissa (positive integer) and an exponent (base 10).

The exponent is the power of 10 by which the mantissa is multiplied. The exponent shall be preceded by a plus (+) or minus (-) sign, and can range from -9 to +9.

Together, mantissa and exponent express the “floating point” conversion factor.

10.3.5.10 Attribute Value Domain

10.3.5.10.1 Introduction

A logical domain of the values in a particular Attribute in terms of its allowable minimum and maximum values.

10.3.5.10.2 Minimum Value Allowed

The allowable minimum value of a particular Attribute.

10.3.5.10.3 Maximum Value Allowed

The allowable maximum value of a particular Attribute.

10.3.5.11 Attribute Description

A textual description of the content and use of the Attribute Type in question.

10.3.6 Attribute Value Definition

10.3.6.1 Introduction

The definition of Attribute Values that represent a set of enumerated coded cases rather than measurements.

Attribute Value Definition consists of the following items:

- Attribute type
- Feature Class Code
- Attribute Value
- Language Code
- Value Description

10.3.6.2 Attribute Type

The Attribute Type Code composed of two printable characters for the Attribute in question.

Values of an Attribute Type may be Feature Class-sensitive, i.e. only applicable if used in combination with a certain Feature Class, or set of Feature Classes. Examples for this include a different range of values for different Feature Classes, and different value semantics depending on the Feature Class context.

10.3.6.3 Feature Class Code

The Feature Class(es) for which this Attribute Value is applicable.

In the event of no Feature Class Code being specified (i.e. in case of zero occurrences of a Feature Class Code), it does not mean that there is no information available for this metadata Field. It means that this is a “standard” value for this Attribute, one that isn't sensitive to which Feature it is applied to. Only Attribute values which are specifically mentioned with a particular Feature, or set of Features, to which they apply would “override” this value.

10.3.6.4 Attribute Value

A particular Attribute Value (allowable value code for attribute type of data type COD or ENM) which corresponds to the meaning described in the Value Code Description.

Note that a “standard” set of attribute values (i.e. non-sensitive to Features) is always to be specified. This is, Feature-sensitive attribute values may be only specified in addition to a standard set of attribute values.

10.3.6.5 Language Code

The ISO 639-2 Language Code [1] of the language used in Value Code Description (for codes, see Clause B.1).

10.3.6.6 Value Code Description

A textual description of the specified value code.

10.3.7 Relationship Definition

10.3.7.1 Introduction

The definition of a Relationship Type with corresponding Relationship Type name and Relationship Type Code.

Relationship Definition contains the following items:

- Relationship Type Name
- Language Code
- Relationship Type Code
- Relationship Partner Information
- Relationship Description

10.3.7.2 Relationship Type Code

The four-digit code of a Relationship Type being defined.

10.3.7.3 Language Code

The ISO 639-2 Language Code [1] of the language used in Relationship Type name (for codes, see Clause B.1).

10.3.7.4 Relationship Type Name

The name of a Relationship Type. Relationship Type names shall have an upper case character at the beginning of the individual words. The other characters shall be lower case.

For each Relationship Type, names can be specified in multiple languages.

10.3.7.5 Relationship Partner Information

10.3.7.5.1 Introduction

A specification of the roles, as well as the Features classes candidate(s) allowable per role, which are partners in this Relationship. It shall be specified whether the role can appear repeatedly or only once. Repeatedly in this respect shall be interpreted as repeating with an unfixed number of times. If the number of repetitions is fixed, each appearance shall be indicated by a separate Feature Class specification. It also shall be indicated whether the appearance of the role is mandatory or optional.

10.3.7.5.2 Feature Role

For each partner in a Relationship, its role number is assigned (unique within the Relationship). Numbering starts from 1 up to the total number of roles present.

One role may correspond to multiple Features of the same Feature Class (e.g. multiple outgoing Road Elements of a Fork), or two Features of the same class may play two different roles (e.g. Transportation Elements as Underpass and Overpass of a grade-separated crossing, respectively).

10.3.7.5.3 Feature Role Name

The name of the role in question.

10.3.7.5.4 Feature Class Code

The four-digit Feature Class Code of the Feature class candidate(s) that appears in the role at hand.

For a role, commonly instantiation by a single Feature Class is allowed. However, multiple “candidate” Feature Classes may be specified as allowable in certain cases (e.g. the role of upper Transportation Element may be played by either a Road Element, a Junction, or a Railway Element, to name a few allowable Feature Classes).

10.3.7.5.5 Repeat Information

Indication whether the presence of this role can repeat.

10.3.7.5.6 Mandatory Information

Indication whether the appearance of this role is mandatory.

10.3.7.6 Relationship Description

A textual description of the content and intended use of the Relationship Type being defined.

10.4 Table of Contents

10.4.1 General

The Dataset Header and the definitions for Field, Record, Attribute Types, Attribute Value Codes, Feature Classes and Relationship Types are followed by information that briefly describes what can be found in the Dataset. Concise information is also given about the geographic coverage of each particular Section. Furthermore, it contains a specification of transportation network types, default Attribute Values, abbreviations, and the generic Administrative Area structures that are present in the Dataset.

The Table of Contents contains the following items:

- Directory.
- Spatial Domain.
- Network Specification.
- Default Attribute Values.
- Administrative Structure Definition.
- Abbreviations.

10.4.2 Directory

10.4.2.1 Introduction

How many instances of one particular record type (or subtype) occur within a particular Section within a particular Layer.

The Directory contains the following parts:

10.4.2.2 Layer Identifier

The Identification number of a particular Layer. See Sub-clause 10.2.5.2. In the Directory records of Dataset records, the value of Layer Identifier shall be left empty because the Dataset records do not belong to any particular Layer.

10.4.2.3 Section Identification

The identification number of a Section which occurs within the Layer in question.

In the Directory records of Dataset records the value of Section Identification Number shall be left empty. See also Sub-clause 10.2.5.2.

10.4.2.4 Record Type Code

The record type code of a record type which occurs within the Section and Layer in question. See Sub-clause 10.3.3.2. Only codes of logical record types will be mentioned.

10.4.2.5 Record Subtype Code

See Sub-clause 10.3.3.3.

10.4.2.6 Record Quantity

The number of logical record instances of the record type and subtype in question.

10.4.3 Spatial Domain

10.4.3.1 Introduction

A description of the geographic coverage of a particular Section. It is described both in mathematical terms (latitude and longitude values) and in linguistic terms. The geometry will be described in a coarse form (200 metres ground resolution) so that information of the geodetic datum is not needed.

At the Section level the geographic coverage will be described in a more detailed way, together with all the geodetic parameters belonging to it. The Spatial Domain description shall contain a Section Identification Number, Geographic Bounding Box and an Area Name. Spatial Domain is the equivalent of the ISO 19115 data element Geographic Extent.

10.4.3.2 Section Identification Number

The ID-number of a particular Section. See Sub-clause 10.2.5.2.

10.4.3.3 Geographic Bounding Box

10.4.3.3.1 Introduction

The geographic Bounding Box is described by means of bounding Longitudes and Latitudes.

10.4.3.3.2 North Bound Latitude

The geographical latitude of the most northern part of the Section. This value is specified in decimal degrees with a resolution of millidegrees, so the latitude of e.g. the North Pole will be : +90000. The value shall be preceded by a plus sign (+) for latitudes in the Northern hemisphere, and a minus sign (-) for those in the South. See also ISO 6709, reference [5].

10.4.3.3.3 East Bound Longitude

The geographical longitude of the most eastern part of the Section. This value shall be specified in decimal degrees, referring to the Prime Meridian of Greenwich, with a resolution of millidegrees. Longitudes east of Greenwich shall be designated by use of the plus sign (+), longitudes west of Greenwich shall be designated by use of the minus sign (-). See also ISO 6709, reference [5].

10.4.3.3.4 South Bound Latitude

The value of the geographical latitude of the most southern part of the Section. Rules are as for North Bound Latitude.

10.4.3.3.5 West Bound Longitude

The geographical longitude of the most western point in the Section. Rules are as for East Bound Latitude.

10.4.3.4 Area Name

The name of a geographical area. This name must be representative for the area covered by the Section. Area Name is the equivalent of the mandatory portion of the ISO 19115 data element Geographic Identifier, an option for defining geographic extent.

Rules are as for Dataset Geographical Coverage (see Sub-clause 10.2.3.15).

10.4.4 Network Specification

10.4.4.1 Introduction

GDF databases often contain different kinds of road networks.

EXAMPLE Networks containing all the roads, only the more important roads or only Motorways.

The network specification consists of the following parts:

- Network Identifier
- Completeness level of the network
- Network description

10.4.4.2 Network Identifier

An identifier of the network which is unique in the current Dataset.

10.4.4.3 Completeness Level of the network

A specification of the Completeness level of the network in the form of a value between 0 and 9 whereby 0 indicates no network and 9 a full network. The further meaning of the values is data producer defined.

10.4.4.4 Network Description

A verbal description of the specified Completeness level.

10.4.5 Default Attribute Values

10.4.5.1 Introduction

By default, the default Attribute Value in a GDF specifies the not-known/not-collected case. In case it is desired that the default Attribute Value specifies a different value (i.e. an Attribute Value defined for a certain Attribute Type), the Default Attribute Value Record can be used. However, the information that a certain Attribute Value has not been captured or is unknown, can now no longer be defined.

Default values of an Attribute Type may be Feature Class-sensitive, i.e. only applicable if used in combination with a certain Feature Class, or set of Feature Classes.

10.4.5.2 Feature Class Code

The Feature Class(es) for which this Default Attribute Value is applicable.

In the event of no Feature Class Code being specified (i.e. in case of zero occurrences of a Feature Class Code), it does not mean that there is no information available for this metadata Field. It means that this is a “standard” value for this Attribute, one that isn't sensitive to which Feature it is applied to. Only Attribute values which are specifically mentioned with a particular Feature, or set of Features, to which they apply would “override” this value.

10.4.5.3 Attribute Type

The Attribute Type for which the default value is defined.

10.4.5.4 Default Attribute Value

The Attribute Value of the Attribute Type specified which is considered default in a Dataset.

Note that a “standard” value (i.e. non-sensitive to Features) does not have to be specified. This is, default attribute values may be specified for a certain Feature Class, or set of Feature Classes, only.

10.4.6 Geopolitical Structure Definition

10.4.6.1 Introduction

The purpose of the Geopolitical Structure Definition is to provide a mapping between the GDF defined general placeholders for Administrative Areas or Named Areas and actual instances of those in certain areas covered by the GDF. Several different structures may be defined, either for different countries or for different regions within a country which have different geopolitical structures. Geopolitical structures are composed of Administrative Areas and/or Named Areas, such as Country, Order-8 Area, School District, or Built-up Area, to form a directed acyclic graph (DAG) of sub-divisions and containment which may be fully or partially hierarchical.

For each geopolitical structure, all occurring Geopolitical Structure Component (i.e. Administrative Area and Named Areas Feature Classes) are generically labelled with their local name(s).

Administrative Structure Definition consists of the following items:

- Geopolitical Structure Identifier
- Geopolitical Structure Name
- Geopolitical Structure Component Identifier
- Feature Class Code of Administrative Area or Named Area

- Language Code
- Local Name of Administrative Area or Named Area
- Immediate Parent Geopolitical Structure Component
- Lowest Full Predecessor Geopolitical Structure Component
- Geopolitical Structure Component Description

10.4.6.2 Geopolitical Structure Identifier

A numerical identifier of the Geopolitical Structure in question. This is the identifier of the structure that is being defined. Other Administrative Areas or Named Areas contribute to this Structure. They all share the same Geopolitical Structure ID. Other Geopolitical Structures share a different ID.

10.4.6.3 Geopolitical Structure Name

A name for the Geopolitical Structure in question.

10.4.6.4 Geopolitical Structure Component Identifier

A numerical identifier for the Geopolitical Structure Component in question. Geopolitical Structures are composed of Geopolitical Structure Component, such as Country, Order-8 Area, School District, or Built-up Area, to form a graph of sub-divisions and containment which may be fully or partially hierarchical. By means referring to Geopolitical Structure Identifiers and Geopolitical Structure Component Identifiers, instances of Features from the Feature Themes Administrative Area and Named Area can declare which geopolitical structure they are a member of, as well as which specific component within that structure they correspond to.

10.4.6.5 Feature Class Code of Administrative Area or Named Area

The four-digit Feature Class Code of an Administrative Area Feature Class or Named Area Feature Class that occurs within the particular geopolitical structure in question.

10.4.6.6 Language Code

The ISO 639-2 Language Code [1] language code of the language used to define the Local Name of the Administrative Area or Named Area (for codes, see Clause B.1).

10.4.6.7 Local Name of Administrative Area or Named Area

The Local Name of Administrative Area or Named Area is the Field that records the local name of the generic Administrative Area or Named Area within this particular structure. There may be several languages in which this name is provided.

EXAMPLE State, County, Bundesland, Département, Postleitzahlenbezirk, or Woonplaats.

These might correspond to "Built-up Area", "Postal District", "Order-3 Administrative Area" or "Administrative Place C". A multilingual release of a GDF can be provided with the multiple language mechanism for local Administrative Area or Named Area names.

10.4.6.8 Immediate Parent Geopolitical Structure Component

One or multiple direct parent Geopolitical Structure Components of the local Geopolitical Structure Component in question. The totality of all parent definitions within a Geopolitical Structure establishes its fully or partially hierarchical graph of sub-divisions and containment.

10.4.6.9 Lowest Full Predecessor Geopolitical Structure Component

The next hierarchical predecessor Geopolitical Structure Component(s) of the local Geopolitical Structure Component in question (“the local component”). One or multiple full predecessors are derived by recursively exploring all parents if they are fully containing the local component. The recursion is effected when a parent does not fully contain the local component; then in turn its parent(s) become subject to further exploration. The set of all Lowest Full Predecessors is determined upon reaching the final parent that fully contains the local component and no additional explorations are required.

The geopolitical structure is locally hierarchical if the set of Immediate Parents and the set of Lowest Full Predecessors are identical. The totality of all parent definitions within a Geopolitical Structure establishes its fully or partially hierarchical graph of sub-divisions and containment.

10.4.6.10 Geopolitical Structure Component Description

An informative description of the characteristics of the Geopolitical Structure Component in question.

10.4.7 Abbreviation

10.4.7.1 Introduction

Common cartographic practice often leads to the abbreviation of common words on a map to reduce clutter and make the map more visually appealing.

EXAMPLE “Professor van Essenstraat” can be abbreviated “Prof. v. Essenstr.”.

Additionally, users may enter addresses using these abbreviations for geocoding. The Abbreviation Record may be used to describe the common abbreviations for a given language.

10.4.7.2 Language Code

The ISO 639-2 Language Code [1] of the language which a particular occurrence of an abbreviation applies to.

10.4.7.3 Abbreviation Short

The abbreviation of an abbreviated term.

10.4.7.4 Abbreviation Long

The full spelling of the abbreviated term.

10.5 Source Material

10.5.1 General

Each instance of a Dataset will be based, to a certain degree, on information which already was available, either in the form of documents and/or in reality. These documents can have the form of a map, a book, report or other monographic document, both in printed and in digitized form. Each Dataset shall contain short descriptions of the sources that have been used for its creation. These references are needed for reasons of copyright, but they are also useful as tools for quality control.

In the description of the source documents, the standard rules as formulated by the International Federation of Library Associations (IFLA) shall be followed. These rules are found in the standards ISBD(G) and ISBD(CM) [42].

For the description of reality as a source, so called Field Data Capture of Field Verification information will be specified. This “Field” information is sufficiently characterized by the date on which the survey took place.

It is possible that both a source document and field information is relevant. Usually this concerns information from a document which afterwards has been verified or updated in the field.

The descriptions of the sources will be situated immediately after the spatial domain descriptions. These descriptions concern all reference documents and field information of the entire Dataset. It is possible to refer on the Section level to those descriptions which are relevant for that particular Section.

10.5.2 Source

10.5.2.1 Introduction

The description of the Sources used in the creation of a Dataset. Each single document will in principle be represented by one Cartographic Source description. Field information will be represented by the date on which the field activity was conducted.

A description of the sources shall contain the following items:

- Description Level
- Level of Completeness
- Source Description Identifier
- International Standard Book Number
- International Standard Serial Number
- Document Language(s)
- Country(ies) Involved
- Year of Survey
- Date of Survey
- Map Scale (for Cartographic Documents only)
- Author Name
- Document Title
- Document Title Language
- Document Volume Name
- Edition Number
- Impression Number
- Year of Publication
- Place of Publication
- Name of Publisher
- Year of Distribution
- Place of Distribution
- Name of Distributor
- Host Document Relation
- Field Information

10.5.2.2 Description Level

Indicates whether the description is “stand alone” or whether it forms a “description tree” with host documents. The relations to possible host document shall be specified.

It may contain one of four different values which indicates the level of description that applies to the subsequent Source description.

The first level in a multilevel description or an independent (single level) description.

The second level in a multi level description.

The third level in a multi level description.

The fourth level in a multi level description.

Single level descriptions will always have the value 1. Parents in a two level description will have a value 1, the child 2. Codes 3 and 4 are only used in exceptional cases of descriptions with three and four different levels.

10.5.2.3 Level of Completeness

This code may only have the value 1 indicating the 1st level of Completeness for this version of this International Standard.

10.5.2.4 Source Description Identifier

An identification number of this particular Source description. This number must be unique for all Source Material descriptions covering all Datasets.

10.5.2.5 International Standard Book Number

The ISBN-number [2] of the source document. In case the document in question has no ISBN-number, this field shall be left empty.

10.5.2.6 International Standard Serial Number

The ISSN-number [3] of the source document. For a non serial numbered document, or for documents not having an ISSN-number, this field shall be left empty.

10.5.2.7 Document Language(s)

The ISO 639-2 Language Code [1] of the main language(s) used in the source document. See Clause B.1 for ISO 639-2 Language Codes.

10.5.2.8 Country(ies) Involved

The ISO 3166 alpha-3 country code of a country or countries which have been involved in the production, publication or distribution of a document.

10.5.2.9 Year of Survey

The year of the primary field survey of the real world situation as represented in the document. Surveys performed for updating purposes are not considered. When the primary survey cannot be fixed on one year (because the survey lasted more than one year), a mean value can be taken.

10.5.2.10 Date of Survey

The actual date of the survey expressed in the form of month, day and hour. This exact information will only be required for documents having a very precise moment of survey: e.g. aerial photographs or satellite images.

10.5.2.11 Map Scale (for Cartographic Document only)

The scale denominator of the cartographic document given without punctuation.

EXAMPLE A scale of 1:25 000 will be treated as 25000.

10.5.2.12 Author Name

The name(s) of the author(s) of a document according to the rules given in ISO 690. The name of the author shall be recorded as given on the source, but with the family name first. If the name of more than one author appears on the source, the name appearing most prominently shall be recorded first. If the names are given equal prominence, the name appearing first shall be recorded first. If not more than three authors share principle responsibility for the work, the names of both or all three shall be included. If four or more authors share responsibility for the work, only the name of the first, or the names of the first two or three need to be recorded; the names of the others may be omitted, the abbreviation "et al." or its equivalent shall be added following the last name recorded.

10.5.2.13 Document Title

10.5.2.13.1 Introduction

The main title of the document in issue. When the title is specified in more than one language, a corresponding number of repeating Document Title descriptions shall be used. Parts of the title which differ from document volume to document volume are considered as subtitles and must be described by document volume Name.

In a multilevel description, Document Title will be used to specify the general title. The general title is that part of the title that belongs to a series of documents as a whole and that is present in all (or almost all) the individual titles.

Document Title contains two sub elements:

Document Title Language

Document Title Text

10.5.2.13.2 Document Title Language

The ISO 639-2 Language Code of the language used in the Document Title Text. See Clause B.1 for ISO 639-2 Language Codes.

10.5.2.13.3 Document Title Text

The main title of a document.

Any string of words which can be used for the identification of a document or a series of documents and which is present on the document itself. If a document has no title in the sense of the definition in the foregoing sentence, a title shall be devised and recorded in square brackets.

In the case of a multilevel description, the main title shall only contain that part of the title which is common to all document volumes. The individual document volume titles and document volume numbers are given in Document Volume Name. In single level descriptions, a document having a long title that consists of two or

more clearly distinguishable parts, of which only the first part is required for identification purposes and of which the secondary part(s) give(s) only a more detailed description, may be split into two parts: a main title and a sub-title. The subtitle shall be represented in Document Volume Name.

In case the title is not self explanatory, a General Comment shall be included, which explains in one or two lines the content of a document. This General Comment shall immediately follow the Document Title Text.

10.5.2.14 Document Volume Name

10.5.2.14.1 Introduction

The subtitle elements within a one level description or those parts of a title within a multilevel description that are not common to all document volumes and will differ from one document volume to the other. Also document volume numbers are considered to be (part of) a subtitle.

If the document contains parallel subtitles in different languages, a corresponding number of repeating Document Volume Name descriptions must be created. These records repeat independently from Document Title.

Document Volume Name contains two elements:

Document Volume Name Language

Document Volume Name Text

10.5.2.14.2 Document Volume Name Language

The ISO 639-2 Language Code [1] of the language used in Document Volume Name Text. When Document Volume Name Text contains only a document volume number, the Document Volume Name Language may remain empty.

10.5.2.14.3 Document Volume Name Text

That part of the title which is not included in the main title. Also document volume numbers are considered to be a part of the sub title and are handled as such.

10.5.2.15 Edition Number

The edition number of a particular document. When there is no edition number mentioned on the document, it is assumed to be the first edition.

10.5.2.16 Impression Number

The impression number of the document.

10.5.2.17 Year of Publication

The year (according to the international "Gregorian" calendar) of the publication or distribution of the document.

10.5.2.18 Place of Publication

Contains two sub-items: Country of Publication and Place of Publication.

- **Country of Publication:** The ISO 3166 alpha-3 code of the country to which the place specified in Place Name belongs.

- **Place of Publication:** The name of the place where the publisher is located. For rules, see Production Place (10.2.4.8.3).

10.5.2.19 Name of Publisher

The name of a publisher of the document, or the organisation (legal person) who has been entirely or partly financially responsible for the publication of a document. The name of the publisher is mandatory in every document description.

10.5.2.20 Year of Distribution

The year (according to the international “Gregorian” calendar) of the distribution of the document.

10.5.2.21 Place of Distribution

Contains two items: Country of Distribution and Place of Distribution.

- **Country of Distribution:** The ISO 3166 alpha-3 code of the country to which the place belongs which is described in Place of Distribution.
- **Place of Distribution:** The name of the place where the distributor is located. For rules, see Production Place (10.2.4.8.3).

10.5.2.22 Name of Distributor

The name of a distributor of the document.

As for Name of Publisher.

10.5.2.23 Host Document Relation

10.5.2.23.1 Introduction

The relations that exist between the document or the document series in issue and the host documents. A Host Document description contains 5 different elements:

Host Description Identifier
Relationship Kind
From Page
To Page
General Comment

10.5.2.23.2 Host Description Identifier

The Description Identifier of the host document.

10.5.2.23.3 Relationship Kind

The type of relation between the document in issue and the host document. The following values have been fixed:

11 = Descended from
12 = Appendix to
13 = Published together with
14 = Additional map to
15 = Inset map to
16 = Is part of

10.5.2.23.4 From Page

The page number within the host document where the document in question starts.

10.5.2.23.5 To Page

The page number within the host document where the document in question ends.

10.5.2.23.6 General Comment

Any free text to represent a short comment.

10.5.2.24 Field Information

10.5.2.24.1 Introduction

The date on which field data capture or verification was conducted. Field Information contains three different elements:

- Start Date of Field Data Capture
- End Date of Field Data Capture
- General Comment

10.5.2.24.2 Start Date of Field Data Capture

The date of the start of the field activity via which the information was collected, verified or last updated.

10.5.2.24.3 End Date of Field Data Capture

The date of the end of the field activity via which the information was collected, verified or last updated. In case this field is left empty, the field activity took place on the start date of the Field Data Capture.

10.5.2.24.4 General Comment

Any free text for any additional FDC information.

10.6 Geodetic Parameters

10.6.1 General

In a Dataset, all the geodetic parameters needed for the correct interpretation of the X, Y and Z coordinates shall be described explicitly so that the coordinates can be transformed into any other coordinate system.

The descriptions of the geodetic parameters are given at the Dataset level, and are provided with an identification number so that they can be referred to by the Section Headers for which they are relevant.

Geodetic Parameters contain the following parts:

- Geodetic Datum
- Vertical Datum
- Reference Ellipsoid
- Projection Method
- National Map Grid
- Geoid Undulation
- Magnetic Declination

10.6.2 Geodetic Datum

10.6.2.1 Introduction

A description of the geodetic (horizontal) datum that underlies a particular national grid. It is needed in order to be able to shift from one geographical coordinate system into another. This description consists of the following items:

- Datum Origin
- Datum Rotation
- Scale Factor
- Datum Name
- Datum Code

10.6.2.2 Datum Origin

10.6.2.2.1 Introduction

The origin of the datum in question in WGS '84 coordinates. It contains the following elements:

10.6.2.2.2 X-Origin

The value of the X-coordinate of the origin of the geodetic datum, in WGS '84 and expressed in decimeters.

10.6.2.2.3 Y-Origin

The value of the Y-coordinate of the datum's origin, in WGS '84 and expressed in decimeters.

10.6.2.2.4 Z-Origin

The value of the Z-coordinate of the datum's origin, in WGS '84 and expressed in decimeters.

10.6.2.3 Datum Z Rotation

The rotation parameters of the datum in relation to WGS '84.

The angle of the rotation around the Z-axis in WGS '84, expressed in hundredths of milligons (gon E-5). This rotation is defined as the angle between the direction of the X-axis of the datum in question minus the direction of the X-axis of the WGS-datum.

10.6.2.4 Scale Factor

The quotient between a distance between two points expressed in the length unit of the local datum divided by the same distance expressed in the length unit of WGS '84.

Assuming that the length units in both systems are based on meters, this factor always will have values of almost 1.

EXAMPLE Values of 0,9999995 or 1,0000005.

In Scale Factor not the value of M_0 itself, but the value of $(1 - M_0) \cdot 10^9$ will be stored. These values shall be rounded at an integer and preceded by their sign.

In the examples mentioned above, this will lead to values of +500 and -500 respectively.

10.6.2.5 Datum Name

Name of the geodetic (horizontal) datum.

A list of horizontal datum names is given in Clause B.3.

10.6.2.6 Datum Code

Code of the geodetic (horizontal) datum.

A list of horizontal datum codes is given in Clause B.3.

10.6.3 Vertical Datum

10.6.3.1 Introduction

A description of the orthometric reference system used in a certain country, together with adjacent orthometric reference systems. This is needed in order to be able to translate height data either side of the interface between adjacent height levels. This description consists of the following items:

- Relevant Country
- Height Level Name
- Height Level Code
- Adjacent Orthometric Reference System(s)

10.6.3.2 Relevant Country

ISO 3166 country code of the country in which the orthometric reference system in issue is used.

10.6.3.3 Height Level Name

Name of the vertical datum in use.

A list of vertical datum names is given in Clause B.3.

10.6.3.4 Height Level Code

Code of the vertical datum in use.

A list of vertical datum codes is given in Clause B.3.

10.6.3.5 Adjacent Orthometric Reference Systems

10.6.3.5.1 Introduction

Specification of zero or more orthometric reference systems that are adjacent to the vertical datum in use. Each adjacent orthometric reference system is described by the following items:

- Relevant Country
- Height Level Name
- Height Level Code
- Height Difference

10.6.3.5.2 Relevant Country

ISO 3166 country code of the country in which the adjacent orthometric reference system is used.

10.6.3.5.3 Height Level Name

Name of an adjacent vertical datum.

A list of vertical datum names is given in Clause B.3.

10.6.3.5.4 Height Level Code

Code of an adjacent vertical datum.

A list of vertical datum codes is given in Clause B.3.

10.6.3.5.5 Height Difference

The orthometric height of the origin of the adjacent system, relative to the system in issue.

10.6.4 Reference Ellipsoid

10.6.4.1 Introduction

The reference ellipsoid is described by the following elements:

- Semi Major Axis
- Semi Minor Axis
- Ellipsoid Code
- Ellipsoid Description

10.6.4.2 Semi Major Axis

The length of the semi-major axis of the reference ellipsoid expressed in metres.

10.6.4.3 Semi Minor Axis

The length of the semi-minor axis of the reference ellipsoid expressed in metres.

10.6.4.4 Ellipsoid Code

The reference code of the ellipsoid. A list of ellipsoid codes is given in Clause B.3.

10.6.4.5 Ellipsoid Description

Textual description of the Ellipsoid used. This information is mandatory if no ellipsoid code is specified.

10.6.5 Projection Method

10.6.5.1 Introduction

Information about the projection used in a particular national grid is needed to be able to transform XY- coordinates into geographical coordinates. In case all the coordinates in the Sections are directly given in the form of geographical coordinates, Projection Method can be left empty.

Each description of the projection shall contain the following items:

- Projection Type Code
- Projection Parameter
- Projection Type Description

10.6.5.2 Projection Type Code

A reference code of the projection used by a Dataset.

A list of projection type codes is given in Clause B.3.

10.6.5.3 Projection Parameter

10.6.5.3.1 Introduction

The longitude and/or latitude value(s) of the base line(s), together with a point scale factor, which define the projection.

10.6.5.3.2 Latitude Longitude

This item may repeat up to 3 times. The value of the geographical latitude and longitude values shall refer to the same datum and reference ellipsoid described in Geodetic Datum and Reference Ellipsoid.

Latitude

The value of the latitude depending on the projection type.

The latitude shall be expressed in microdegrees (degrees E-6). It shall be preceded by a plus sign (+) for latitudes on the Northern hemisphere and a minus sign (-) for latitudes on the Southern hemisphere.

The latitude of the equator shall be expressed as +0000000. The latitude of the North Pole will be +90000000. See also ISO 6709.

Longitude

The value of the longitude depending on the projection type.

Longitudes shall be expressed in microdegrees. The longitudes shall refer to the Prime meridian of Greenwich. Longitudes east of Greenwich shall be designated by use of the plus sign (+), longitudes west of Greenwich shall be designated by use of the minus sign (-). The prime Meridian shall be designated by use of the plus sign (+). The 180th meridian shall be designated by use of the minus sign (-). See also ISO 6709 [5].

10.6.5.3.3 Point Scale Factor

The scale factor in a defined point or along a defined parameter line depending on the projection type.

The scale factor (M_0) is defined as the quotient between the value of a distance between two infinitesimal adjacent points calculated from the XY-coordinates of the projection system and the other value calculated from the geographical latitude and longitude and the corresponding reference ellipsoid.

In Point Scale Factor not the value of M_0 itself, but the value of $(1 - M_0) \cdot 10^7$ will be specified. These values shall be rounded at an integer and preceded by a plus (+) or minus (-) sign.

The longitude of the central meridian is specified in the first Latitude Longitude group which is directly followed by Point Scale Factor.

EXAMPLE 1 For a projection of the type "Transverse Mercator", the geographical longitude of the central meridian and the point scale factor along the central meridian has to be known.

EXAMPLE 2 For a projection of the type "Lambert Conformal Conic with two standard parallels", the following parameters are required:

- latitude of the Northern standard parallel,
- latitude of the Southern standard parallel,
- latitude of the central parallel at which the point scale factor is specified,
- the point scale factor.

The latitude of the Northern parallel shall be given in the first Latitude Longitude group, the latitude of the Southern parallel in the second and the latitude to which the point scale factor belongs in the third one, followed by a Point Scale Factor.

The geographical latitude and longitude values must refer to the same datum and reference ellipsoid described in Geodetic Datum and Reference Ellipsoid.

10.6.5.4 Projection Type Description

Textual description of the Projection Type used. This information is mandatory if no projection type code is specified.

10.6.6 National Map Grid

10.6.6.1 Introduction

The characteristics of the national grid to which the coordinates of a particular Section refer are needed to interpret correctly the X- and Y-coordinate values, and to be able to transform from XY-coordinates into geographical coordinates.

The description contains three items:

- Indication whether the grid axes are left- or right-turning.
- Description of the origin of a "help" grid in terms of latitude and longitude.
- Description of the origin of the national grid relative to the help grid.

The help grid shall be normal Cartesian and have its + Y-axis northwards and tangential to the projection of the meridian in the origin. The length unit used in the help grid shall be the metre.

In case the real grid is rotated with respect to the help grid, this shall be specified by means of Grid Rotation.

A description of the national grid shall contain the following items:

- Grid Axes Orientation
- Help Grid Latitude
- Help Grid Longitude
- X Origin
- Y Origin
- Grid Rotation
- Grid Name
- Grid Code

10.6.6.2 Grid Axes Orientation

An indicator of whether the grid in issue (the national grid) is normal Cartesian or reverse Cartesian.

- 0 normal Cartesian
- 1 reverse Cartesian

For the rest, grids shall be rectangular and have orthogonal coordinate axes, both using the same length unit.

Normal Cartesian means that the clockwise counted angle between the +Y-axis and the +X-axis ($Y_r - X_r$) is 300 gon. Reverse Cartesian means that this angle is 100 gon.

10.6.6.3 Help Grid Latitude

The latitude of the origin of the "help" grid.

This value shall be expressed in microdegrees (degrees E-6).

Rules as for Latitude.

10.6.6.4 Help Grid Longitude

This field shall contain the value of the longitude of the origin of the "help" grid.

Rules as for Longitude.

10.6.6.5 X Origin

The X-coordinate of the origin of the national grid expressed in the "help" grid. This value shall be expressed in decimeters. Positive coordinate values shall be preceded by a plus sign (+) and negative values by a minus sign (-). In case the origin of the national grid coincides with the origin of the "help" grid (which will often be the case), this field shall contain the value: +00.

10.6.6.6 Y Origin

The Y-coordinate of the origin of the national grid expressed in the "help" grid. Rules as for X Origin.

10.6.6.7 Grid Rotation

The clockwise counted angle between the + Y-axis of the national grid and the + Y-axis of the "help" grid, expressed in microgons (gon E-6).

Expressed in symbols: $Rot = Y_n - Y_h$

where Y_n is the direction of the +Y-axis of the national grid and Y_h is the direction of the +Y-axis of the help grid.

If the Y-axes of both grids coincide (or are parallel to each other), which will often be the case, this field shall contain: +0000000.

10.6.6.8 Grid Name

Name of the national grid.

A list of National Grids is given in Clause B.3.

10.6.6.9 Grid Code

Code of the national grid.

A list of National Grids is given in Clause B.3.

10.6.7 Geoid Undulation

10.6.7.1 Introduction

The height of the geoid above the reference ellipsoid in some particular reference points has to be described.

A description of Geoid Undulation is needed when Z-values are used in the data records.

Each Section shall refer to 4 different geoid undulation reference points which surround the Section, so that the local geoid height in the Section can be calculated by means of interpolation.

Each description of a geoid undulation reference point shall contain the following items:

Reference Point Latitude

Reference Point Longitude

Ellipsoidal Height

10.6.7.2 Reference Point Latitude

The value of the latitude of the point in question.

Rules as for Latitude.

10.6.7.3 Reference Point Longitude

The value of the longitude of the point in question.

Rules as for Longitude.

10.6.7.4 Ellipsoidal Height

The ellipsoidal height of the local geoid.

The height above the reference ellipsoid (the same as that described in Reference Ellipsoid) shall be expressed in decimeters. Positive values shall be preceded by a plus sign (+), negative values by a minus sign (-).

10.6.8 Magnetic Declination

10.6.8.1 Introduction

Information about the magnetic declination and the annual deviation is needed to be able to correct for this declination in the heading of a navigation compass.

The magnetic declination shall be specified in the centre point of a Section or in 4 different points that surround the Section so that the local value can be calculated by means of interpolation.

Each description of a magnetic declination reference point shall contain the following items:

Reference Point Latitude

Reference Point Longitude

Validity Date

Magnetic Variation

Annual Change

Horizontal Magnetic Field Intensity

Vertical Magnetic Field Intensity

10.6.8.2 Reference Point Latitude

See Sub-clause 10.6.7.2.

10.6.8.3 Reference Point Longitude

See Sub-clause 10.6.7.3.

10.6.8.4 Validity Date

The year, month and day which correspond to the value of the magnetic declination which is specified in Magnetic Variation.

10.6.8.5 Magnetic Variation

The angle between the direction of the Magnetic North (N_m) and the Geographic North (N_g), in symbols: $Dec = N_m - N_g$.

The angle shall be expressed in milligons (gon E-3) and shall be preceded by a plus sign for eastward declinations and by a minus sign for westward declinations.

10.6.8.6 Annual Change

The annual change in the magnetic declination. This change is defined as: the clockwise counted angle between the direction of the Magnetic North in year i ($N_m(i)$) and the direction of N_m in the preceding year $i-1$ ($N_m(i-1)$).

In symbols: $Dev(A_n) = N_m(i) - N_m(i-1)$.

The angle shall be expressed in milligons (gon E-3).

Eastward annual changes are preceded by a plus (+) sign. Westward annual changes are preceded by a minus sign (-).

10.6.8.7 Horizontal Magnetic Field Intensity

Horizontal Magnetic Field Intensity expressed in nanoteslas.

10.6.8.8 Vertical Magnetic Field Intensity

Vertical Magnetic Field Intensity expressed in nanoteslas.

10.7 Update Information

10.7.1 General

For publishing update information, certain syntactical structures shall be specified. These are described in the following.

10.7.2 Time Stamp Format

Formatting string for the time stamps used within the given Section:

The time unit symbols correspond to those used for Time Domain expressions (Annex D). The Logical Data Structures specifies further Time Stamp Format composition rules and constraints (see 11.6.3.9).

d = day

M = month

y = year

h = hour (0...23)

m = minutes

s = seconds

: = separator

For instance, “dd:MM:yyyy:hh:mm” means that a time stamp is stored in a day/month/year system followed by the hour and the minutes.

10.8 General Comment

A free text allowing any necessary comment to other items.

11 Logical Data Structures

11.1 Introduction

This document specifies the logical GDF data structures that help understand the semantics of the GDF data and thereby help with the transfer and exchange of data. These data structures can be considered as independent of any specific realization method in which they are implemented. This data structures can be used to build the basis of in-memory data structures that would be used by a reader (parser) program on a computer to ingest (accept / store) the GDF content from any realization.

11.1.1 Data description language: ESN

To describe the data structures, use is made of a Data Description Language, called ESN. This language enables data types to be constructed of any complexity from a set of elementary types. This can be illustrated by means of the following example:

PROJECTION TYPE =

```
[
Projection Identifier           : PROJECTION ID           11.8.7.33
Projection Type Code           : PROJECTION TYPE CODE     11.8.3.8
Projection Parameters Sequence : PROJECTION PARAMETERS  11.3.15.9
]
```

The name written entirely in uppercase letters ("PROJECTION TYPE" in the example) is the proper name of the data type. This name is used to identify just this particular data structure so that it can be referenced in the definition of data types of higher complexity. The name may not be used for any other data type. Furthermore, it is recommended that one particular data type (i.e. with exactly that particular specification, constraints included) carries just one name.

Each data type definition begins with the symbol "[" and ends with the symbol"]". Each line between these square brackets describes a particular component of the data type in question. At the right hand side, the data type of that particular component is mentioned. In the example above, the datatype of the first component is "PROJECTION ID". This name is followed by the number of the section where that data type is described (11.8.7.33 in the example).

The example shows that the data type "PROJECTION ID" has the role of a Projection Identifier. Therefore "Projection Identifier" is called the "role name". Role names are always found in the left column and are always written in lowercase with initial caps. Role names correspond (for the most part) to the names used in the Metadata Catalogue and the Media Record Specifications. It often occurs that the role name and the data type name are identical (apart from the different use of uppercase letters). This indicates that the data type has been especially constructed for the role in question. If the data type is used for more than one role, the names will be different. The order in which the individual components are listed is significant. When the same components are listed in another order, this implies that the data type defined is different. See the diagram of section 11.1.5. for a graphical illustration of what is written in this section.

11.1.2 Sets, elements and ranges

A particular data type used in ESN is the Set. A Set is simply an un-ordered collection of one or more elements (instances) of the same data type and is specified in the following form:

$L = [T]^+$, where the + indicates that in the Set L there may be multiple elements of type T.

The elements of type T in a particular instance of the Set L are not order significant. However, if the order is meaningful, then a constraint to note that has to be specified: as in the example of the order of X,Y Coordinate Sequence in $[COORDINATE PAIR]^+$ (i.e. the ordered SET of COORDINATE PAIRs) in NON-EXPLICIT TOPO LINE GEO RENDERING, as further explained in constraint C2; see 11.5.4.4.14. A datatype may be constrained by saying that its domain must be a subset of the elements of a particular list. This is done by means of the constructs ELEMENT(L) or RANGE(L). ELEMENT(L) means that the component refers to not more than one element of the Set L. RANGE(L) means that the component refers to zero, one or more

elements of the Set L. The order in which these elements are referred to is not relevant, unless otherwise specified. Such use of ELEMENT and RANGE operators are often used in the constraints – but there, they play an important role. This technique is known as “denotational semantics”. It is a branch of computer science which formalizes “meaning” of computer (synthetic) languages.

11.1.3 Summary of the syntax notation

- (0) literals in this language are either numbers (like 17) or strings in quotes (like 'a' or 'November');
- (0a) NULL denotes an absence of a value;
- (1) $e : T$ component with role e is of data type T;
- (2) $T = [A|B]$ an instance of data type T is either expressed as an A type or as a B; where A and B are simple data types, which can be further turned into some values;
- (2a) $T = [17|'a']$ an instance of data type T is either the value 17 or the value a; where both 17 and a are literal values;
- (3) $T =$
 $[$
 $e1: T1$ - a component of data type T1 playing role e1
 $e2: T2$ - a component of data type T2 playing role e2
 $]$ an instance of data type T contains 2 components:
- (3a) $T =$
 $[$
 $e1: T1$ - a component of data type T1 playing role e1
 $|$ - or
 $e2: T2$ - a component of data type T2 playing role e2
 $]$ an instance of data type T contains exactly 1 of the following 2 components:
- (4) $L = [T]^*$ an instance of data type L is a Set of zero or more instances of data type T;
- (4a) $L = [T]^+$ an instance of data type L is a Set of one or more instances of data type T;
- (5) $T = (i..j)$ an instance of data type T is an integer in the range $i \leq t \leq j$;
- (5a) $T = (i..j, k..l)$ an instance of data type T is an integer in the range $i \leq t \leq j$ or $k \leq t \leq l$;
- (5b) $T = (i, j, k, l)$ an instance of data type T is an integer whose value is either i, j, k, or l;
 where in these examples i, j, k, and l are some integers;
- (6) ELEMENT(L) denotes a reference to one instance of the Set L;
 if L isn't the empty Set, ELEMENT(L) must return exactly one value;
- (6a) RANGE(L) denotes a reference to zero, one, or more instances of the Set L.

11.1.4 Useful consequences of the syntax notation

Putting "together" (0), (0a), (2), and (2a) yields:

- (7) $T = ['a' | NULL]$ an instance of data type T can have either the value of 'a' or the absence of a value, that is no value at all;

Putting together (2), (2a), (3), and (7) above yields:

(8) $T =$
 $[$
 e1: T1 - an optional component of data type T1 playing role e1
 | NULL
 e2: T2 - a mandatory component of data type T2 playing role e2
 $]$

Putting together (3), (4a), and (7) yields:

(9) $T =$
 $[$
 e1: [T1]+ - an optional component (or a Set of such components) of data type T1
 | NULL playing (together) role e1
 e2: T2 - a mandatory component of data type T2 playing role e2
 $]$

and also

(9a) $T =$
 $[$
 e1: [T1]+ - at least one component (or a Set of such components) of data type T1
 playing (together) role e1
 e2: T2 - a mandatory component of data type T2 playing role e2
 $]$

If we take the or '|' symbol out of (2) and (2a), we are left with

(10) $T = [A]$

and

(10a) $T = ['a']$

which can be more “naturally” rendered as

(11) $T = A$

and

(11a) $T = 'a'$

Putting together (0), (5b), and (11a) allows us the convenient way to render something like this:

(12) $T = (\text{Sunday}=1, \text{Monday}=2, \text{Tuesday}=3, \text{Wednesday}=4, \text{Thursday}=5, \text{Friday}=6, \text{Saturday}=7)$

which is a very pleasant way to render “meaningful” value lists.

(13) $T = (\text{Car}=12, \text{Bus}, \text{Taxi}, \text{Truck}=51)$

takes this notation a step further, where arguments without explicit value assume to continue the former element. So in this example Bus and Taxi would have the values 13 and 14 respectively.

If a Set like this doesn't specify any value (or at least not the first value), that value is assumed to be 1. For all other situations, an explicit value must be presented.

11.1.5 Diagrammatic Overview of the overall structure

At the highest level observation a GDF-Album is made up of the following components:

- GDF Album {11.2}
 - + Album Metadata {11.2.3}
 - Dataset SET {11.3}
 - + Dataset Metadata {11.3.3}
 - + Dataset Data {11.3.16}
 - Layer SET {11.4}
 - + Layer Metadata {11.4.3}
 - + Layer Data {11.4.4}
 - + Section SET {11.5}

In the above rendition the highest level view is provided. It only shows Album, Dataset, Layer, and Section, as well as their respective Metadata components. The '-' sign shows that the object to its right has been "opened" of "laid out to see" its 1st level components. A '+' shows that the object to its right has not yet been "opened".

At the next level of presentation, the 2nd level view of the above diagram (after having "opened" Album Metadata and Dataset Metadata) appears as follows:

- GDF Album {11.2}
 - Album Metadata {11.2.3}
 - + Local Char Set Defn. <optional> {11.2.5}
 - + Global Album Info {11.2.6}
 - Dataset SET {11.3}
 - Dataset Metadata {11.3.3}
 - + Dataset Header {11.3.4}
 - + Media Record Set Constructs <opt> {11.3.5}
 - + Data Dictionary {11.3.6}
 - + Directory <opt> {11.3.7}
 - + Spatial Domain SET <opt> {11.3.8}
 - + Sources <opt> {11.3.9}
 - + Network Specifications <opt> {11.3.10}
 - + Abbreviations <opt> {11.3.11}
 - + Admin. Structure Definitions <opt> {11.3.13}
 - + Geodetical Parameters <opt> {11.3.15}
 - Dataset Data {11.3.16}
 - + Update Info SET <opt> {11.7}
 - + Relationship SET <opt> {11.5.4.5}
 - + Attribute SET <opt> {11.5.4.6}
 - + Text Record SET <opt> {11.5.4.7}
 - + Time Domain Record SET <opt> {11.6.2}
 - + Object Reference SET <opt> {11.5.4.9}
 - Layer SET {11.4}
 - + Layer Metadata {11.4.3}
 - + Layer Data {11.4.4}
 - + Section SET {11.5}

For the 3rd "level" of exposition, Layer Metadata as well as Section Metadata and Data is "opened":

- GDF Album {11.2}
 - Album Metadata {11.2.3}
 - + Local Char Set Defn. <optional> {11.2.5}
 - + Global Album Info {11.2.6}
 - Dataset SET {11.3}
 - Dataset Metadata {11.3.3}
 - + Dataset Header {11.3.4}
 - + Media Record Set Constructs <opt> {11.3.5}
 - + Data Dictionary {11.3.6}

+ Directory	<opt>	{11.3.7}
+ Spatial Domain SET	<opt>	{11.3.8}
+ Sources	<opt>	{11.3.9}
+ Network Specifications	<opt>	{11.3.10}
+ Abbreviations	<opt>	{11.3.11}
+ Admin. Structure Definitions	<opt>	{11.3.13}
+ Geodetical Parameters	<opt>	{11.3.15}
- Dataset Data		{11.3.16}
+ Update Info SET	<opt>	{11.7}
+ Relationship SET	<opt>	{11.5.4.5}
+ Attribute SET	<opt>	{11.5.4.6}
+ Text Record SET	<opt>	{11.5.4.7}
+ Time Domain Record SET	<opt>	{11.6.2}
+ Object Reference SET	<opt>	{11.5.4.9}
- Layer SET		{11.4}
+ Layer Metadata		{11.4.3}
+ Layer Topology		{11.4.5.2}
+ Height Level Method		{11.4.5.3}
+ X,Y Resolution		{inside 11.4.3}
+ Layer Theme SET	<opt>	{11.8.2.6}
+ Layer Data		{11.4.4}
+ Update Info SET	<opt>	{11.7}
+ Relationship SET	<opt>	{11.5.4.5}
+ Attribute SET	<opt>	{11.5.4.6}
+ Text Record SET	<opt>	{11.5.4.7}
+ Time Domain Record SET	<opt>	{11.6.2}
+ Object Reference SET	<opt>	{11.5.4.9}
+ Section SET		{11.5}
- Section Metadata		{11.5.3.2}
+ Section Identification		{11.5.3.3}
+ X,Y Resolution	<opt>	{inside 11.5.3.2}
+ Network Identification	<opt>	{11.3.10}
+ Datasource References	<opt>	{11.3.9.2}
+ Datum & Magnetism Use	<opt>	{11.5.3.5}
+ Orthometric Ref. Use	<opt>	{11.5.3.7}
+ Section Borders		{11.5.3.9}
+ XY Control Point	<opt>	{11.5.3.10}
+ Z Control Point	<opt>	{11.5.3.11}
+ Upd. Time Stamp Format	<opt>	{11.6.3.9}
- Section Data		{11.5.4}
+ Update Info SET	<opt>	{11.7}
- Topo/Geo Data	<opt>	{11.5.4.3}
+ Node SET		{11.5.4.3.3}
+ Edge SET		{11.5.4.3.4}
+ Face SET		{11.5.4.3.5}
- Feature Data		{11.5.4.4}
- Simple Feature Data		{11.5.4.4}
+ Point Feature SET		{11.5.4.4.4}
+ Line Feature SET		{11.5.4.4.9}
+ Area Feature SET		{11.5.4.4.17}
+ Complex Feature Data		{11.5.4.4.24}
+ Relationship SET	<opt>	{11.5.4.5}
+ Attribute SET	<opt>	{11.5.4.6}
+ Text Record SET	<opt>	{11.5.4.7}
+ Time Domain Record SET	<opt>	{11.6.2}
+ Conversion Record SET	<opt>	{11.5.4.8}
+ Object Reference SET	<opt>	{11.5.4.9}

11.2 Logical GDF Album

11.2.1 Overview

The aggregation of all the information pertaining to a particular geographical area, created at a particular moment by a certain supplier, is called an Album. An Album contains one or more Datasets.

The relations between Album, Datasets, Layers and Sections are illustrated in the diagram of section 11.1.5 as well as UML data model Figure 21 and Figure 22.

11.2.2 Album

[
Album Identifier	: ALBUM ID		11.8.7.9
Album Metadata	: ALBUM HEADER		11.2.3
Datasets	: [DATASET]+		11.3.2
]			

Constraints

C1: An Album Identifier is an identifier of an Album and must be unique within the set of Albums supplied by a certain supplier.

C2: Each Dataset must belong to exactly one Album.

11.2.3 ALBUM HEADER

[
Album Introduction	ALBUM HEADER INTRO		11.2.4
Local Character Set Definition List	: [LOCAL CHARACTER SET DEFINITION]+		11.2.5
	NULL		
Global Album Information	: GLOBAL ALBUM INFORMATION		11.2.6
]			

Constraints

C1: An Album must contain at least one Dataset

C2: A Dataset must belong to exactly one Album

11.2.4 ALBUM HEADER INTRO

[
Short Organization Name	: STRING		11.5.4.7.4
Standard Name	: STRING		11.5.4.7.4
Standard Version	: STRING		11.5.4.7.4
Default Character Set Identifier	: (1..30)		
Album Size	: (0..99999999999999999999)		
]			

Constraints

C1: The Short Organization Name may not exceed 18 characters (nor 18 bytes, which ever comes first).

C2: The Standard Name for this standard is "GDF".

C3: The Standard Version for this standard is "5.0".

C4: Default Character Set Identifier is limited to a narrower subset of possible character sets from the bigger available set. See clause 10.2.2.9 for the full list.

C5: Album Size is specified in bytes.

C6: An Album Identifier is an identifier of an Album and must be unique within the set of Albums supplied by a certain supplier.

Comments:

K1: Corresponds to 12.6.1.1 ALBUM HEADER INTRO in MRS (Rec01.01)

11.2.5 LOCAL CHARACTER SET DEFINITION

[
Local In Code	: TWO CHARACTERS		11.5.4.7.6
Local Out Code	: TWO CHARACTERS		11.5.4.7.6
Character Set Identifier	: CHARACTER SET ID		11.8.7.42
Organization Code	: ISO COUNTRY CODE		11.8.6.2
Character set Code Table Name	: STRING		11.5.4.7.4
Character set Code Table Version Number	: STRING		11.5.4.7.4
Character set Languages	: [LANGUAGE CODE]+		11.5.4.7.7
	NULL		
Collating Sequence	: LANGUAGE CODE		11.5.4.7.7
	NULL		
]			

Constraints

- C1: A Character Set Identifier is an identifier of a local character set and must be unique within the Album in issue.
- C2: This Character Set Identifier must be different than the Default Character Set in ALBUM HEADER INFO.
- C3: The Local In Code must be from the Album default character set and must be unique within the Album in issue.
- C4: The Local Out Code must be from the Album default character set.

Comments:

K1: Corresponds to 12.6.1.2LOCAL CHARACTER SET DEFINITION in MRS (Rec01.02)

11.2.6 GLOBAL ALBUM INFORMATION

[
Organization Name	: STRING		11.5.4.7.4
Organization Role	: ORGANIZATION ROLE CODE		11.2.7.2
Album Creation Date	: DATE STAMP		11.6.3.2
	NULL		
Metadata Creation Date	: DATE STAMP		11.6.3.2
Date of Copyright	: DATE STAMP		11.6.3.2
	NULL		
Copyright Owner	: STRING		11.5.4.7.4
	NULL		
]			

Comments:

K1: Corresponds to 12.6.1.3 GLOBAL ALBUM INFORMATION in MRS (Rec01.03)

11.2.7 Basic Data Types used by Album

11.2.7.1 Overview

Simple types used by Album

11.2.7.2 ORGANIZATION ROLE CODE

= (Resource Provider=1, Custodian=2, Owner=3, User=4, Distributor=5, Originator=6, Point of Contact=7, Principal, Investigator=8, Processor=9, Publisher=10, Author=11)

11.3 Datasets

11.3.1 Overview

The Datasets partition the Album geographically. Of course, an Album may consist of just a single Dataset, or it can consist of several Datasets.

A Dataset may contain one or more Layers.

11.3.2 DATASET

[
Dataset Identifier	: DATASET ID		11.8.7.10
Dataset Metadata	: DATASET METADATA		11.3.3.2
Dataset Data	: DATASET DATA		11.3.16
Layer Set	: [LAYER]+		11.4.2
]			

Constraints

C1: The Supplier Dataset Identifier is an identifier of the Dataset which is unique within the set of Datasets supplied by a particular supplier.

11.3.3 Dataset Metadata

11.3.3.1 Overview

Each Dataset starts with Dataset Metadata: data about the data needed to interpret these data in the right context.

11.3.3.2 DATASET METADATA

[
Dataset Header	: DATASET HEADER		11.3.4.2
MRS Realization Constructs	: MRS GENOME		11.3.5
Data Dictionary	: DATA DICTIONARY		11.3.6.2
Directory	: [DIRECTORY ENTRY]+		11.3.7.2
	NULL		
Spatial Domain	: [SPATIAL DOMAIN ENTRY]+		11.3.8.2
	NULL		
Sources	: [SOURCE DEFINITION]+		11.3.9.2
	NULL		
Network Specifications	: [NETWORK SPECIFICATION]+		11.3.10
	NULL		
Abbreviations	: [ABBREVIATION]+		11.3.11
	NULL		
Admin Structure Definitions	: [ADMINISTRATIVE STRUCTURE DEFINITION]+		11.3.13
	NULL		
Geodetical Parameters	: GEODETICAL PARAMETERS		11.3.15.2
	NULL		
]			

Constraints

C1: MRS GENOME is only useful for the MRS realization.

11.3.4 Dataset Header

11.3.4.1 Overview

The Dataset Header is the first component of the Dataset Metadata.

11.3.4.2 DATASET HEADER

[
Dataset Identification	: DATASET IDENTIFICATION		11.3.4.3
Dataset Titles	: DATASET TITLES		11.3.4.4
	NULL		
Dataset Producer	: DATASET PRODUCER		11.3.4.5
	NULL		
Dataset Extensiveness	: GEOGRAPHIC COVERAGE NAME		11.5.3.3
	NULL		
Dataset Currency	: CREATION YEAR		11.3.4.6
	NULL		
Dataset Geographical Coverage	: DATASET CONTENTS		11.3.4.7
	NULL		
Dataset XY Resolution	: (0..999)		
	NULL		
]			

Comments:

K1: Corresponds to 12.6.2 DATASET HEADER in MRS

11.3.4.3 DATASET IDENTIFICATION

[
IDSI Number	: STRING		11.5.4.7.4
	NULL		
Edition Date	: DATE/HOUR STAMP		11.6.3.3
Reference Date	: DATE STAMP		11.6.3.2
Reference Type	: DATASET REFERENCE TYPE		11.3.4.9.2
Dataset Topic	: DATASET TOPIC		11.3.4.9.3
Unit System	: DATASET UNIT SYSTEM		11.3.4.9.4
	NULL		
Dataset Languages	: [LANGUAGE CODE]+		11.5.4.7.7
	NULL		
Default Language	: LANGUAGE CODE		11.5.4.7.7
	NULL		
Countries Involved	: [ISO COUNTRY CODE]+		11.8.6.2
	NULL		
Abstract	: STRING		11.5.4.7.4
]			

Constraints:

C1: IDSI Number (International DataSet Identification Number) is 13 characters wide.

C2: If Unit System is not specified, the default value is 'Metric' (1).

Comments:

K1: Corresponds to 12.6.2.1 and 12.6.2.2 DATASET IDENTIFICATION in MRS (Rec02.01)

11.3.4.4 DATASET TITLES

[
Dataset Main Title	: LANGUAGE TEXT PAIR		11.5.4.7.3
	NULL		
Dataset Subtitle	: STRING		11.5.4.7.4
	NULL		
]			

Constraints

C1: If DATASET TITLES is specified, at least one of its elements should be present.

Comments:

K1: Corresponds to 12.6.2.3 DATASET TITLES in MRS (Rec02.02 and Rec02.03)

11.3.4.5 DATASET PRODUCER

[
Production Place	: PLACE		11.8.6.1
	NULL		
Producer Name	: LANGUAGE TEXT PAIR		11.5.4.7.3
	NULL		
]			

Constraints

C1: It should not be the case that all fields are NULL

Comments:

K1: Corresponds to 12.6.2.4 DATASET PRODUCER in MRS (Rec02.04)

11.3.4.6 CREATION YEAR

= YEAR CODE 11.6.3.5

Comments:

K1: Corresponds to 12.6.2.5 CREATION YEAR in MRS (Rec02.05)

11.3.4.7 DATASET CONTENTS

[
Thematic Coverage	: [THEME]+		11.3.4.8
	NULL		
]			

Comments:

K1: Corresponds to 12.6.2.6 DATASET CONTENTS in MRS (Rec02.06)

11.3.4.8 THEME

[
Feature Theme Code	: FEATURE THEME CODE		11.8.2.6
Feature Theme Name	: FEATURE THEME NAME		11.8.2.7
]			

11.3.4.9 Basic Data Types used by Dataset Header

11.3.4.9.1 Overview

Simple types used by Dataset Header

11.3.4.9.2 DATASET REFERENCE TYPE

= (Creation=1, Publication=2, Revision=3)

11.3.4.9.3 DATASET TOPIC

= (Farming=1, Biota=2, Boundaries=3, Climatology / Meteorology / Atmosphere=4, Economy=5, Elevation=6, Environment=7, Geoscientific Information=8, Health=9, Imagery / Base Maps / Earth Cover=10, Intelligence / Military=11, Inland Water=12, Location=13, Oceans=14, Planning Cadastre=15, Society=16, Structure=17, Transportation=18, Utilities / Communications=19)

11.3.4.9.4 DATASET UNIT SYSTEM

= (Metric=1, English=2)

11.3.5 MRS GENOME

11.3.5.1 Overview

MRS Genome are the building blocks used to self-define the layout of the MRS realization.

11.3.5.2 MRS GENOME

[
Field Definitions	: [FIELD DEFINITION]+		11.3.5.3
	NULL		
Record Definitions	: [RECORD DEFINITION]+		11.3.5.4
	NULL		
]			

11.3.5.3 FIELD DEFINITION

[
Field Name	: SHORT STRING		11.5.4.7.5
Field Size	: (1..99)		
Data Type	: DATA TYPE CODE		11.8.4.1
Data Unit Type	: DATA UNIT TYPE		11.8.4.3
Data Unit Code	: DATA UNIT CODE		11.8.4.2
	NULL		
Unit Exponent	: (-9..9)		
No Data	: NO DATA MARK		11.3.5.7.3
Value Domain	: VALUE DOMAIN		11.3.5.7.2
Data Use	: DATA USE		11.3.5.7.7
Field Description	: STRING		11.5.4.7.4
]			

Constraints

C1: The Field Name is an identifier of a Field which is unique within the field definitions of GDF.

11.3.5.4 RECORD DEFINITION

[
Record Type/Subtype Code	: RECORD TYPE IDENTIFIER		11.3.5.5
Record Name	: RECORD NAME		11.3.5.7.6
Field Sequence	: [FIELD]+		11.3.5.6
Record Comment	: STRING		11.5.4.7.4
]			

Constraints

- C1: The Record Type Code is an identifier of a record type which must be unique within a particular Dataset. However legal, it is uncommon for Field Type Codes to vary from one Dataset to another.
- C2: The Record Name is an identifier of a record type or record subtype which must be unique within a particular Dataset. However legal, it is uncommon for Field Type Codes to vary from one Dataset to another.
- C3: The number of fields in the Field Sequence may not exceed 99.

11.3.5.5 RECORD TYPE IDENTIFIER

[
Record Type Code	: RECORD TYPE CODE		11.3.5.7.4
Record Sub-Type Code	: RECORD SUB-TYPE CODE		11.3.5.7.5
	NULL		
]			

Constraints

- C1: Not all combinations from the respective sets of Record Type Code and Record Sub-type Code are meaningful.

11.3.5.6 FIELD

[
Field Name	: SHORT STRING		11.5.4.7.5
Repeat Flag	: (0..9)		
]			

Constraints

- C1: Field Name has to be an ELEMENT(FIELD DEFINITION SET)->Field Name

11.3.5.7 Basic Data Types used by MRS Genome

11.3.5.7.1 Overview

Simple and compound types used by MRS Genome

11.3.5.7.2 VALUE DOMAIN

[
Minimum Value Allowed	: (-999999999999999999..9999999999999999)		
Maximum Value Allowed	: (-999999999999999999..9999999999999999)		
]			

11.3.5.7.3 NO DATA MARK

[
No Data Mark	: 'Obl'		
	'<S>'		
	STRING		11.5.4.7.4
]			

Constraints

- C1: The '<S>' mark may be of length 1 or of some field width n of some length, but must not exceed the allowable width of the field that it decorates.
C2: The STRING instance for a particular FIELD DEFINITION must be an allowable field value for the given Data Type and, in case of DATA TYPE CODE 'N', be from the allowable numeric value range.

11.3.5.7.4 RECORD TYPE CODE

= (0..11, 13..19, 24, 25, 29, 41, 44..46, 50..54, 61..66, 83, 89, 90)

11.3.5.7.5 RECORD SUB-TYPE CODE

= (0..10)

11.3.5.7.6 RECORD NAME

= ('ALHDREC.01', 'ALHDREC.02', 'ALHDREC.03', 'DSHDREC.01', 'DSHDREC.02', 'DSHDREC.03', 'DSHDREC.04', 'DSHDREC.05', 'DSHDREC.06', 'DSHDREC.07', 'ATDEFREC', 'DIREC', 'FEATDEFREC', 'SPADOREC', 'RELDEFREC', 'GPLSTRDREC', 'GPLCOMDREC', 'SRCEREC.01', 'SRCEREC.02', 'SRCEREC.03', 'SRCEREC.04', 'SRCEREC.05', 'SRCEREC.06', 'SRCEREC.07', 'SRCEREC.08', 'SRCEREC.09', 'SRCEREC.10', 'DATTVALREC', 'SECHREC.01', 'SECHREC.02', 'SECHREC.03', 'SECHREC.04', 'SECHREC.05', 'SECHREC.06', 'SECHREC.07', 'SECHREC.08', 'SECHREC.09', 'LAYHREC', 'ATTVALREC', 'NWSPECSREC', 'DATELREC', 'VERDATREC', 'PROJECREC', 'NATGRIDREC', 'GEOIDREC', 'MAGNETREC', 'EDGEREC', 'NODEREC', 'FACEREC', 'TEXTREC', 'ATTREC', 'TIMEREC', 'CONVERTREC', 'RELATREC', 'POFEREC', 'LIFEREC', 'ARFEREC', 'COFEREC', 'OBJREFREC', 'UPDIREC.01', 'UPDIREC.02', 'UPDIREC.01')

11.3.5.7.7 DATA USE

= (Entity=1, Foreign ID=2, Field Counter=3, Other=4)

11.3.6 Data Dictionary

11.3.6.1 Overview

The Data Dictionary contains the explicit description of the definitions of Features, Attributes, and Relationships components used in a particular Dataset.

11.3.6.2 DATA DICTIONARY

```
[
Feature Component           : [FEATURE DEFINITION]+           11.3.6.4
                             | NULL
Attribute Component         : ATTRIBUTE COMPONENT           11.3.6.3
Relationship Component      : [RELATIONSHIP DEFINITION]+       11.3.6.19
                             | NULL
]
```

11.3.6.3 ATTRIBUTE COMPONENT

[
Attribute Definitions	: [ATTRIBUTE DEFINITION]+	11.3.6.11	
	NULL		
Attribute Value Definitions	: [ATTRIBUTE VALUE DEFINITION]+	11.3.6.27	
	NULL		
Default Attributes	: [DEFAULT ATTRIBUTE]+	11.3.6.28.2	
	NULL		
]			

11.3.6.4 FEATURE DEFINITION

[
Maximum Level	: (1..99)		
Feature Type Translation Name Set	: FEATURE TYPE TRANSLATION NAME SET	11.3.6.5	
Feature Subtype Set	: [(7100..9999)]+		
Feature Description	: STRING	11.5.4.7.4	
	NULL		
]			

Constraints

- C1: There can be at most 99 Feature Class Names in the Translation Name Set.
- C2: There can be at most 999 Feature Subtypes.
- C3: Each member of the Feature Subtype Set must exist.

Comments:

- K1: Corresponds to 12.6.5FEATURE DEFINITION in MRS (Rec07)

11.3.6.5 FEATURE TYPE TRANSLATION NAME SET

[
Translation Name Set	: FEATURE TYPE TRANSLATION NAME SET PRE-DEFINED	11.3.6.6	
	FEATURE TYPE TRANSLATION NAME SET USER-DEFINED	11.3.6.7	
]			

Constraints

- C1: Inside each of the members of the Set inside the Translation Name Set, there can only be one mention of any Language Code. If there are more Names in the Set, they have to be in another language. They must all share the same Class Code and mean the same thing, just in different languages: a translated set.

11.3.6.6 FEATURE TYPE TRANSLATION NAME SET PRE-DEFINED

[
Feature Class Code	: FEATURE CLASS CODE	11.8.2.4	
Translation Name Set	: [FEATURE CLASS NAME PRE-DEFINED]+	11.3.6.8	
]			

11.3.6.7 FEATURE TYPE TRANSLATION NAME SET USER-DEFINED

[
Feature Class Code	: (8100..9999)		
Translation Name Set	: [FEATURE CLASS NAME USER-DEFINED]+	11.3.6.9	
]			

Constraints

- C1: The Feature Class Codes are “newly-defined” (i.e. user-defined) from the range (8100..9999), which is exactly reserved for that. Once newly-defined user-defined class code is defined, it “joins” the FEATURE

CLASS CODE set and may no longer be used again to define a new Feature Class Code. For example if the code 9007 has been used to define some user-defined Feature, the next time a user-defined Feature is defined, that value: 9007, is no longer available, and “recuses itself” from the (8100..9999) range available for the remaining values.

Denotation semantics: each time a new definition of a Feature is made, its Feature Class Code is added to the already existing set of previously defined codes.

If D is set of so far defined Class Codes, and
d = newly defined Feature Class Code
then $D \leftarrow D \cup d$ (where U stands for Union)

and furthermore, symbolically, d is only allowed the new value if and only if
d isn't already ELEMENT(D), before the union

11.3.6.8 FEATURE CLASS NAME PRE-DEFINED

[
Feature Class Language	: LANGUAGE CODE	11.5.4.7.7	
	NULL		
Feature Class Name	: FEATURE CLASS NAME	11.8.2.5	
]			

11.3.6.9 FEATURE CLASS NAME USER-DEFINED

[
Feature Class Language	: LANGUAGE CODE	11.5.4.7.7	
	NULL		
Feature Class Name	: STRING	11.5.4.7.4	
]			

11.3.6.10 ANY FEATURE CLASS CODE

[
Feature Class Code	: FEATURE CLASS CODE	11.8.2.4	
	(8100..9999)		
]			

Constraints

C1: {In order to be used, a Feature Class Code must exist. That is, it is either from the pre-defined set FEATURE CLASS CODE or from the user-defined set (namely, the [8100..9999] range). If it is from the latter, it has to have been previously ‘created’ in a FEATURE DEFINITION. If so, it can be named here.

11.3.6.11 ATTRIBUTE DEFINITION

[
Attribute Type Translation Name Set	: ATTRIBUTE TYPE TRANSLATION NAME SET	11.3.6.12	
Attribute Value Type	: DATA TYPE CODE	11.8.4.1	
Maximum Attribute Value Width	: (1..11)		
	NULL		
Attribute Data Type	: ATTRIBUTE DATA TYPE	11.8.4.2	
Attribute Data Unit	: DATA UNIT TYPE	11.8.4.3	
	NULL		
Conversion Mantissa	(1..999999999999)		
	NULL		
Conversion Exponent	: (-9..9)		
	NULL		
Attribute Value Domain	: ATTRIBUTE VALUE DOMAIN	11.3.6.17	
	NULL		

Attribute Description : STRING 11.5.4.7.4
 | NULL
]

Constraints

- C1: There can be at most 99 Attribute Type Names.
- C2: Attribute Data Unit is only specified if the value of Attribute Data Type is MSR (Measure).
- C3: Semantically, here cannot be more than one Attribute Type Name, however, it may be delivered in several different languages

Comments:

K1: Corresponds to 12.6.6 ATTRIBUTE DEFINITION in MRS (Rec05)

11.3.6.12 ATTRIBUTE TYPE TRANSLATION NAME SET

[
 Translation Name Set : ATTRIBUTE TYPE TRANSLATION NAME SET PRE-DEFINED 11.3.6.13
 | ATTRIBUTE TYPE TRANSLATION NAME SET USER-DEFINED 11.3.6.14
]

Constraints

- C1: Inside each of the members of the Set inside the Translation Name Set, there can only be one mention of any Language Code. If there are more Names in the Set, they have to be in another language. They must all share the same Type Code and mean the same thing, just in different languages: a translated set.

11.3.6.13 ATTRIBUTE TYPE TRANSLATION NAME SET PRE-DEFINED

[
 Attribute Type Code : ATTRIBUTE TYPE CODE 11.8.2.1
 Translation Name Set : [ATTRIBUTE TYPE NAME PRE-DEFINED]+
]

11.3.6.14 ATTRIBUTE TYPE TRANSLATION NAME SET USER-DEFINED

[
 Attribute Type Code : TWO CHARCTERS 11.5.4.7.6
 Translation Name Set : [ATTRIBUTE TYPE NAME USER-DEFINED]+
]

Constraints

- C1: The Attribute Type Codes are “newly-defined” (ie user-defined) designated by two characters. Those two character companions may not be the same as any such combination from the Pre-defined Attribute Type Code Set . Once newly-defined user-defined code is defined, it “joins” the ATTRIBUTE TYPE CODE set and may no longer be used again to define a new Attribute Type Code. For example if the code 7G has been used to define some user-defined Attribute, the next time a user-defined Attribute is defined, that value: 7G, is no longer available, and “recuses itself” from the available two character combinations for the remaining values.

Denotation semantics: each time a new definition of an Attribute is made, its Attribute Type Code is added to the already existing set of previously defined codes.

If D is set of so far defined Type Codes, and
 d = newly defined Attribute Type Code
 then $D \leftarrow D \cup d$ (where U stands for Union)

and furthermore, symbolically, d is only allowed the new value if and only if
 d isn't already ELEMENT(D), before the union

11.3.6.15 ATTRIBUTE TYPE NAME PRE-DEFINED

[
Attribute Type Language	: LANGUAGE CODE		11.5.4.7.7
	NULL		
Attribute Type Name	: ATTRIBUTE TYPE NAME		11.8.2.2
]			

11.3.6.16 ATTRIBUTE TYPE NAME USER-DEFINED

[
Attribute Type Language	: LANGUAGE CODE		11.5.4.7.7
	NULL		
Attribute Type Name	: STRING		11.5.4.7.4
]			

11.3.6.17 ATTRIBUTE VALUE DOMAIN

[
Minimum Value Allowed	: (-9999999999..9999999999)		
Maximum Value Allowed	: (-9999999999..9999999999)		
]			

Constraint:

C1: Minimum Value Allowed < Maximum Value Allowed

11.3.6.18 ANY ATTRIBUTE TYPE CODE

[
Attribute Type Code	: ATTRIBUTE TYPE CODE		11.8.2.1
	TWO CHARCTERS		11.5.4.7.6
]			

Constraints

C1: In order to be used, a Attribute Type Code must exist. That is, it is either from the pre-defined set ATTRIBUTE TYPE CODE or from the user-defined set. If it is from the latter, it has to have been previously 'created' in a ATTRIBUTE DEFINITION. If so, it can be named here.

11.3.6.19 RELATIONSHIP DEFINITION

[
Relationship Type Translation Name Set	: RELATIONSHIP TYPE TRANSLATION NAME SET		11.3.6.20
Role Sequence	: [ROLE DEFINITION]+		11.3.6.25
Relationship Description	: STRING		11.5.4.7.4
	NULL		
]			

Constraints

C1: Semantically, here cannot be more than one Relationship Type Name, however, it may be delivered in several different languages

Comments:

K1: The unique 'key' or identifier of each such new Relationship Defined here is to be found deep inside the Relationship Type Translation Name Set, namely, it is the Relationship Type Code.

K2: Corresponds to 12.6.9 RELATIONSHIP DEFINITION in MRS (Rec09)

11.3.6.20 RELATIONSHIP TYPE TRANSLATION NAME SET

[Translation Name Set	: RELATIONSHIP TYPE TRANSLATION NAME SET PRE-DEFINED	11.3.6.21
		RELATIONSHIP TYPE TRANSLATION NAME SET USER-DEFINED	11.3.6.24
]			

Constraints

C1: Inside each of the members of the Set inside the Translation Name Set, there can only be one mention of any Language Code. If there are more Names in the Set, they have to be in another language. They must all share the same Type Code and mean the same thing, just in different languages: a translated set.

11.3.6.21 RELATIONSHIP TYPE TRANSLATION NAME SET PRE-DEFINED

[Relationship Type Code	: RELATIONSHIP TYPE CODE	11.8.2.8
	Translation Name Set	: [RELATIONSHIP TYPE NAME PRE-DEFINED]+	11.3.6.23
]			

11.3.6.22 RELATIONSHIP TYPE TRANSLATION NAME SET USER-DEFINED

[Relationship Type Code	: (9000..9999)	
	Translation Name Set	: [RELATIONSHIP TYPE NAME USER-DEFINED]+	11.3.6.24
]			

Constraints

C1: The Relationship Type Codes are “newly-defined” (ie user-defined) from the range (9000..9999), which is exactly reserved for that. Once newly-defined user-defined code is defined, it “joins” the RELATIONSHIP TYPE CODE set and may no longer be used again to define a new Relationship Type Code. For example if the code 9007 has been used to define some user-defined Relationship, the next time a user-defined Relationship is defined, that value: 9007, is no longer available, and “recuses itself” from the (9000..9999) range available for the remaining values.

Denotation semantics: each time a new definition of a Relationship is made, its Relationship Type Code is added to the already existing set of previously defined codes.

If D is set of so far defined Type Codes, and
d = newly defined Relationship Type Code
then $D \leftarrow D \cup d$ (where U stands for Union)

and furthermore, symbolically, d is only allowed the new value if and only if
d isn't already ELEMENT(D), before the union

11.3.6.23 RELATIONSHIP TYPE NAME PRE-DEFINED

[Relationship Type Language	: LANGUAGE CODE	11.5.4.7.7
		NULL	
	Relationship Type Name	: RELATIONSHIP TYPE NAME	11.8.2.9
]			

11.3.6.24 RELATIONSHIP TYPE NAME USER-DEFINED

[Relationship Type Language	: LANGUAGE CODE	11.5.4.7.7
		NULL	
	Relationship Type Name	: STRING	11.5.4.7.4
]			

11.3.6.25 ROLE DEFINITION

[
Feature Role Number	: (1..99)		
Feature Role Name	: STRING		11.5.4.7.4
Role Feature Class Code Set	: [ANY FEATURE CLASS CODE]+		11.3.6.10
Repeat Flag	: BOOLEAN		11.8.8.1
Mandatoriness Flag	: BOOLEAN		11.8.8.1
]			

Constraints

- C1: The Feature Role Name must not exceed 40 characters width.
 C2: There can be no more than 99 elements in the Role Feature Class Code Set.
 C3: Each of the elements in the Role Feature Class Code Set must exist in order to be named.

11.3.6.26 ANY RELATIONSHIP CLASS CODE

[
Relationship Type Code	: RELATIONSHIP TYPE CODE		11.8.2.8
	(9000..9999)		
]			

Constraints

- C1: {In order to be used, a Relationship Type Code must exist. That is, it is either from the pre-defined set RELATIONSHIP TYPE CODE or from the user-defined set (namely, the [8100..9999] range). If it is from the latter, it has to have been previously 'created' in a RELATIONSHIP DEFINITION. If so, it can be named here.

11.3.6.27 ATTRIBUTE VALUE DEFINITION

[
Attribute Type Code	: ANY ATTRIBUTE TYPE CODE		11.3.6.18
Feature Class Code Set	: [ANY FEATURE CLASS CODE]+		11.3.6.10
	NULL		
Attribute Value Code	: ATTRIBUTE VALUE CODE		11.8.2.3
Attribute Code Description	: LANGUAGE TEXT PAIR		11.5.4.7.3
	NULL		
]			

Constraints

- C1: The possible values of Attribute Value Code is either taken from the set of pre-defined code list values or from any of the user-defined Attributes, whose codes list values are 'added' to the ATTRIBUTE VALUE CODE set. This is a value code from a set of tables which are either pre-defined, or a set of tables added by user definition of new tables of code lists.
 C2: Attribute Type Code and Attribute Value Code together form a composite key, which means that in any given Dataset there cannot be more than one such definition.

Comments:

- K1: Corresponds to 12.6.7 ATTRIBUTE VALUE DEFINITION in MRS (Rec18)

11.3.6.28 Default Attributes

11.3.6.28.1 Overview

A Default Attribute provides a method to assign a particular attribute value to a set of Features instead of a single Feature. Declaring a particular value as the default value of an attribute indicates that the absence of that attribute for a particular Feature instance means that the default attribute value should be applied to that Feature.

The use of Default Attribute is only allowed under the following conditions:

- The Attribute must be applicable for all instances of the Features for a given class.
- The Attribute must have been collected for 100 percent of the relevant Features.

11.3.6.28.2 DEFAULT ATTRIBUTE

[
Attribute Type Code	: ANY ATTRIBUTE TYPE CODE	11.3.6.18
Feature Class Code Set	: [ANY FEATURE CLASS CODE]+	11.3.6.10
	NULL	
Attribute Value	: SHORT STRING	11.5.4.7.5
	TEXT ID	11.8.7.23
	TIME ID	11.8.7.24
]		

Comments:

K1: Corresponds to 12.6.8 DEFAULT ATTRIBUTE in MRS (Rec15)

11.3.7 Directory

11.3.7.1 Overview

The Directory lists the number of records stored in each Section, inside all Layers, inside all Datasets, of a particular record type (and subtype when appropriate). Each directory “entry” gives one such count. There are as many directory “entries” as there are record types in each of the Sections (in their respective scopes).

11.3.7.2 DIRECTORY ENTRY

[
Directory Entry Identifier	: DIRECTORY ID	11.8.7.38
Layer Identification	: LAYER ID	11.8.7.11
Section Identification	: SECTION ID	11.8.7.12
Record Type/Subtype Code	: RECORD TYPE IDENTIFIER	11.3.5.5
Record Quantity	: (0..99999999)	
]		

Constraints

C1: The Directory Entry Identifier is an identifier of the Directory Entry which must be unique within the Dataset.

C2: The Layer referred to by Layer Identifier must be an element of the set of Layers within the Dataset which this Directory belongs to or symbolically:

Layer Identifier : ELEMENT(LAYER SET)
 need to specify scope of LAYER SET to be in this Dataset, somehow

where LAYER SET is inside 11.3.2 (DATASET)

C3: The Section referred to by Section Identifier must be an element of the set of Sections within the Layer as referred to by the preceding Layer Identifier or symbolically:

Section Identifier: ELEMENT(SECTION SET)
 need to specify scope of SECTION SET to be in the Layer of comment C2, somehow

where SECTION SET is inside 11.4.2 (LAYER)

C4: The Record Type/Subtype referred to by Record Type/Subtype Code must be an element of the set of record types/subtypes `_defined_` within the same Dataset as this Directory is in or symbolically:

Record Type/Subtype Code : ELEMENT(RECORD DEFINITION SET)

where RECORD DEFINITION SET is inside 11.3.5 (MRS GENOME)

C5: The Record Type/Subtype referred to by Record Type/Subtype Code must be an element of the set of record types/subtypes `_used_` within the same Section as referred to by the Section Identifier of comment C3 or symbolically:

Record Type/Subtype Code : ELEMENT(RECORD SET)

need to specify scope of RECORD SET to be in the Section of comment C3, somehow

where RECORD SET is implicitly present within the Section of comment C3

Comments:

K1: Corresponds to 12.6.13 DIRECTORY ENTRY in MRS (Rec06) [DIREC].

K2: Corresponds to 11.3.7.2 in the Metadata Catalogue.

11.3.8 Spatial Domain

11.3.8.1 Overview

The Spatial Domain describes the geographical coverage of a Dataset. It does so by “duplicating” the Section boundary information of each Section (in each Layer) in the Dataset.

11.3.8.2 SPATIAL DOMAIN ENTRY

[
Spatial Domain Entry Identifier	: SPATDOM ID	11.8.7.37
Layer Identifier	: LAYER ID	11.8.7.11
Section Identifier	: SECTION ID	11.8.7.12
Geo Coverage Boundaries	: SPATIAL DOMAIN BOUNDARY	11.3.8.3
	NULL	
Area Name	: STRING	11.5.4.7.4
	NULL	
]		

Constraints

C1: The Spatial Domain Entry Identifier is an identifier of a Spatial Domain Entry which must be unique within the Dataset.

C2: The Layer referred to by Layer Identifier must be an element of the set of Layers within the Dataset which this Spatial Domain element belongs to or symbolically:

Layer Identifier : ELEMENT(LAYER SET)

need to specify scope of LAYER SET to be in this Dataset, somehow

where LAYER SET is inside 11.3.2 (DATASET)

C3: The Section referred to by Section Identifier must be an element of the set of Sections within the Layer as referred to by the preceding Layer Identifier or symbolically:

Section Identifier: ELEMENT(SECTION SET)

need to specify scope of SECTION SET to be in the Layer of comment C2, somehow

where SECTION SET is inside 11.4.2 (LAYER)

C4: At least one of the Geo Coverage Boundaries or Area Name has to be specified.

Comments:

K1: Corresponds to 12.6.12 SPATIAL DOMAIN ENTRY in MRS (Rec08)

K2: Corresponds to 11.3.8.2 in the Metadata Catalogue.

11.3.8.3 SPATIAL DOMAIN BOUNDARY

[
North-most Latitude	:	(-90000..90000)
South-most Latitude	:	(-90000..90000)
West-most Longitude	:	(-180000..180000)
East-most Longitude	:	(-180000..180000)
]		

Comments:

K1: The latitude and longitude fields are measured in milli-degrees.

11.3.9 Sources

11.3.9.1 Overview

“Source” is the general term for the documents (books, reports, maps, aerial photos, etc.) that are used in the establishment of the Dataset.

See the Metadata Catalogue for more details (10.5.2).

11.3.9.2 SOURCE DEFINITION

[
Source Definition Identifier	:	SOURCE ID	11.8.7.30
Source Description Info	:	SOURCE DESCRIPTION INFO	11.3.9.3
		NULL	
ISBN & Survey	:	ISBN AND SURVEY	11.3.9.4
		NULL	
Author Names	:	STRING	11.5.4.7.4
		NULL	
Map Scale	:	(1..9999999)	
		NULL	
Title	:	TITLE	11.3.9.5
		NULL	
Volume/Map Sheet Name	:	VOLUME/MAP SHEET NAME	11.3.9.6
		NULL	
Edition & Impression	:	EDITION AND IMPRESSION	11.3.9.7
		NULL	
Publisher	:	PUBLISHER	11.3.9.8
		NULL	
Distribution	:	DISTRIBUTION	11.3.9.9
		NULL	
Host Document	:	HOST DOCUMENT	11.3.9.10
		NULL	
Field Data Capturing	:	FIELD DATA CAPTURING	11.3.9.11
		NULL	
]			

Constraints

C1: The Source Definition Identifier is an identifier of the Source which must be unique within the Dataset.

C2: Besides the mandatory SOURCE ID the rest of the other members cannot all be NULL. That is, one of the other ones (at least) must have a value.

11.3.9.3 SOURCE DESCRIPTION INFO

[
Description Level	: (1..4)		
	NULL		
Level of Completeness	: 1		
	NULL		
Parent Source	: SOURCE ID	11.8.7.30	
	NULL		
]			

Constraints

C1: The Source Identifier referred to by the Parent Source must be an element of the set of Source Definition Set, which is *defined* within the Dataset, or symbolically:

Parent source Identifier : ELEMENT(SOURCE DEFINITION SET)
need to specify scope of SOURCE DEFINITION SET to be in the Dataset of this Source Description Info, somehow

where SOURCE DEFINITION SET is inside 11.3.3.2 (DATASET METADATA)

C2: The Source referred to by Parent Source Identifier must belong to the same Dataset as this Source Description Info.

C3: The members of this structure cannot all be NULL. That is, one of them (at least) must have a value.

Comments:

K1: Corresponds to 12.6.16.1 SOURCE DESCRIPTION INFO in MRS (Rec14.01).

11.3.9.4 ISBN AND SURVEY

[
International Standard Book Number	: STRING	11.5.4.7.4	
	NULL		
International Standard Serial Number	: SHORT STRING	11.5.4.7.5	
	NULL		
Document Languages	: [LANGUAGE CODE]+	11.5.4.7.7	
	NULL		
Countries Involved	: [ISO COUNTRY CODE]+	11.8.6.2	
	NULL		
Year of Survey	: YEAR CODE	11.6.3.5	
	NULL		
Date of Survey	: MONTH/HOUR STAMP	11.6.3.4	
	NULL		
]			

Constraints

C1: The International Standard Book Number may not exceed 13 characters wide

C2 : The members of this structure cannot all be NULL. That is, at least one of them must have a value

Comments:

K1: Corresponds to 12.6.16.2 ISBN AND SURVEY in MRS (Rec14.02).

11.3.9.5 TITLE

[
Language Code	: LANGUAGE CODE	11.5.4.7.7	
	NULL		
Document Title	: STRING	11.5.4.7.4	
]			

11.3.9.6 VOLUME/MAP SHEET NAME

[
Language Code	: LANGUAGE CODE	11.5.4.7.7	
	NULL		
Volume/Map Sheet Name	: STRING	11.5.4.7.4	
	NULL		
]			

Constraints

C1: The members of this structure cannot all be NULL. That is, at least one of them must have a value.

11.3.9.7 EDITION AND IMPRESSION

[
Edition Number	: STRING	11.5.4.7.4	
	NULL		
Impression Number	: STRING	11.5.4.7.4	
	NULL		
]			

Constraints

C1: The members of this structure cannot all be NULL. That is, at least one of them must have a value.

11.3.9.8 PUBLISHER

[
Year of Publication	: YEAR CODE	11.6.3.5	
	NULL		
Place of Publication	: PLACE	11.8.6.1	
	NULL		
Name of Publisher	: STRING	11.5.4.7.4	
	NULL		
]			

Constraints

C1: The members of this structure cannot all be NULL. That is, at least one of them must have a value.

Comments:

K1: Corresponds to 12.6.16.7PUBLISHERin MRS (Rec14.07)

11.3.9.9 DISTRIBUTION

[
Year of Distribution	: YEAR CODE	11.6.3.5	
	NULL		
Place of Distribution	: PLACE	11.8.6.1	
	NULL		
Name of Distributor	: STRING	11.5.4.7.4	
	NULL		
]			

Constraints

C1: The members of this structure cannot all be NULL. That is, at least one of them must have a value.

11.3.9.10 HOST DOCUMENT

[
Host Source Identifier	: SOURCE ID		11.8.7.30
Kind of Relationship	: RELATIONSHIP KIND CODE		11.3.9.10.1.2
	NULL		
From Page	: (1 ... 999)		
	NULL		
To Page	: (1 ... 999)		
	NULL		
General Comments	: STRING		11.5.4.7.4
	NULL		
]			

Constraints

C1: The Source Identifier referred to by the host Source Identifier must be an element of the set of Source Definition Set, which is *defined* within the Dataset, or symbolically:

Host source Identifier : ELEMENT(SOURCE DEFINITION SET)
need to specify scope of SOURCE DEFINITION SET to be in the Dataset of this Host Document, somehow

where SOURCE DEFINITION SET is inside 11.3.3.2 (DATASET METADATA)

C2: The Source referred to by Parent Source Identifier must belong to the same Dataset as this Host Document.

11.3.9.10.1 Basic Data Types used by Host Documents

11.3.9.10.1.1 Overview

Simple types used by Host Documents

11.3.9.10.1.2 RELATIONSHIP KIND CODE

= (Descended from=11, Appendix to=12, Published together with=13, Additional map to=14, Inset map to=15, Is part of=16)

11.3.9.11 FIELD DATA CAPTURING

[
Start Data Field Data Capture Activity	: DATE STAMP		11.6.3.2
End Date Field Data Capture Activity	: DATE STAMP		11.6.3.2
	NULL		
General Comment	: STRING		11.5.4.7.4
	NULL		
]			

11.3.10 NETWORK SPECIFICATION

[
Road Network Identifier	: NETWORK ID		11.8.7.40
Completeness Level	: (0..9)		
Completeness Description	: STRING		11.5.4.7.4
	NULL		
Section BP Set	: [SECTION ID]+		11.8.7.12
	NULL		
Features BP Set	: [ANY FEATURE IN DATASET]+		11.8.7.2
	NULL		
]			

Constraints:

C1: The Road Network Identifier is an identifier of a Road Network which must be unique within the Dataset.

Comments:

K1: Corresponds to 12.6.15 NETWORK SPECIFICATION in MRS (Rec19).

11.3.11 ABBREVIATION

[
Language Code	: LANGUAGE CODE		11.5.4.7.7
Abbreviation Short	: STRING		11.5.4.7.4
Abbreviation Long	: STRING		11.5.4.7.4
]			

Constraints:

C1: Abbreviation Short may not exceed 20 characters wide and Abbreviation Long may not exceed 50 characters wide.

Comments:

K1: Corresponds to 12.6.14 ABBREVIATION in MRS (Rec13).

11.3.12 GEOPOLITICAL STRUCTURE DEFINITION

[
Geopolitical Structure Identifier	: GPL STR ID		11.8.7.41
Geopolitical Structure Name	: STRING		11.5.4.7.4
	NULL		
Geopolitical Structure Component Set	: [GPL STR CMP ID]+		11.8.7.39
Attribute BP Set	: [ANY ATTRIBUTE IN DATASET]+		11.5.4.6.8
	NULL		
]			

Constraints:

C1: The Geopolitical Structure Identifier is an identifier of a Geopolitical Structure which must be unique within the Dataset

C2: Geopolitical Structure Name should not exceed 40 characters width.

Comments:

K1: Corresponds to 12.6.10 GEOPOLITICAL STRUCTURE DEFINITION in MRS (Rec10).

11.3.13 GEOPOLITICAL STRUCTURE COMPONENT DEFINITION

[
Geopolitical Structure Component Identifier	: GPL STR CMP ID		11.8.7.39
Feature Class Code	: ANY FEATURE CLASS CODE		11.3.6.10
Local Area Type Name Set	: [LANGUAGE TEXT PAIR]+		11.5.4.7.3
Immediate Parent Set	: [GPL STR CMP ID]+		11.8.7.39
	NULL		
Full Predecessor Set	: [GPL STR CMP ID]+		11.8.7.39
	NULL		
Geopolitical Structure Component Description	: STRING		11.5.4.7.4
	NULL		
Attribute BP Set	: [ANY ATTRIBUTE IN DATASET]+		11.5.4.6.8
	NULL		
]			

Constraints:

- C1: The Geopolitical Structure Component Identifier is an identifier of a Geopolitical Structure Component which must be unique within the Dataset
 C2: The Feature Class Code must be in the range (1100..3199)

Comments:

- K1: Corresponds to 12.6.11 GEOPOLITICAL STRUCTURE COMPONENT DEFINITION in MRS (Rec11).

11.3.14 GEOPOLITICAL STRUCTURE REFERENCE

[
Geopolitical Structure ID	: GPL STR ID		11.8.7.41
Geopolitical Structure Component ID	: GPL STR CMP ID		11.8.7.39
]			

Constraints:

- C1: The Geopolitical Structure ID and the Geopolitical Structure Component ID must belong to the same Geopolitical Structure Definition scheme.

11.3.15 Geodetical Parameters

11.3.15.1 Overview

The Geodetical Parameters group contains general information about Geodetical items, such as datums, ellipsoids, Geoid undulation, projection methods and grid systems. It includes data which is needed in order to interpret the metric data in a correct way.

See the Metadata Catalogue for more details (see 10.6).

11.3.15.2 GEODETICAL PARAMETERS

[
Geodetical Datum & Ellipsoid Set	: [HORIZONTAL DATUM]+		11.3.15.3
	NULL		
Orthometric Height References	: [VERTICAL DATUM]+		11.3.15.6
	NULL		
Projection Methods	: [PROJECTION TYPE]+		11.3.15.8
	NULL		
National Map Grids	: [NATIONAL GRID]+		11.3.15.10
	NULL		
Geoid Undulations	: [GEOID UNDULATION]+		11.3.15.12
	NULL		
Earth Magnetic Field Set	: [MAGNETIC FIELD DECLINATION]+		11.3.15.13
	NULL		
]			

Comments:

K1: Corresponds to GEODETICAL PARAMETERS in MRS

11.3.15.3 HORIZONTAL DATUM

[
Horizontal Datum Identifier.	: HORIZONTAL DATUM ID		11.8.7.31
Datum Origin Translation	: DATUM ORIGIN		11.3.15.4
	NULL		
Datum Z Rotation	: (0..40000000)		
	NULL		
Scale Factor	: (-9999..9999)		
	NULL		
Datum Name	: DATUM NAME		11.8.3.2
	NULL		
Datum Code	: DATUM CODE		11.8.3.1
Reference Ellipsoid	: ELLIPSOID		11.3.15.5
	NULL		
]			

Constraints:

C1: The Horizontal Datum Identifier is an identifier of the Horizontal Datum which must be unique within the Dataset.

C2: The optional members of this structure cannot all be NULL. That is, at least one of them must have a value.

Comments:

K1: Corresponds to 12.6.17.1 HORIZONTAL DATUM in MRS (Rec61).

11.3.15.4 DATUM ORIGIN

[
X-Origin	: (-9999..9999)	
	NULL	
Y-Origin	: (-9999..9999)	
	NULL	
Z-Origin	: (-9999..9999)	
	NULL	
]		

Constraints:

C1: All elements are specified in decimetres.

11.3.15.5 ELLIPSOID

[
Semi Major Axis	: (1..99999999)		
	NULL		
Semi Minor Axis	: (1..99999999)		
	NULL		
Ellipsoid Code	: ELLIPSOID CODE		11.8.3.3
Ellipsoid Description	: STRING		11.5.4.7.4
	NULL		
]			

11.3.15.6 VERTICAL DATUM

[
Vertical Datum Identifier.	: VERTICAL DATUM ID		11.8.7.32
Relevant Country	: ISO COUNTRY CODE		11.8.6.2
Height Level Name	: HEIGHT LEVEL NAME		11.8.3.7
	NULL		
Height Level Code	: HEIGHT LEVEL CODE		11.8.3.6
Adjacent Levels	: [ADJACENT LEVEL]+		11.3.15.7
	NULL		
]			

Constraints

- C1: The Vertical Datum Description Identifier is an identifier of the vertical datum which must be unique within a Dataset.
- C2: The combination of Relevant Country and Height Level Name is a identifier of a vertical datum which must be unique within a particular Dataset.

Comments:

K1: Corresponds to 12.6.17.2 VERTICAL DATUM in MRS (Rec62)

11.3.15.7 ADJACENT LEVEL

[
Used in Country	: ISO COUNTRY CODE		11.8.6.2
Height Level Name	: HEIGHT LEVEL NAME		11.8.3.7
	NULL		
Height Level Code	: HEIGHT LEVEL CODE		11.8.3.6
Height Difference	: (-9999..9999)		
]			

Constraints

- C1: The combination of Used in Country and Height Level Name must be a unique Adjacent Level within a particular Dataset.
- C2: Height Difference is specified in centimeters.

11.3.15.8 PROJECTION TYPE

[
Projection Identifier	: PROJECTION ID		11.8.7.33
Projection Type Code	: PROJECTION TYPE CODE		11.8.3.8
Projection Parameters Sequence	: PROJECTION PARAMETERS		11.3.15.9
Projection Description	: STRING		11.5.4.7.4
	NULL		
]			

Constraints

- C1: The Projection Identifier is an identifier of the Projection Type which must be unique within the Dataset.

Comments:

K1: Corresponds to 12.6.17.3 PROJECTION TYPE in MRS (Rec63).

11.3.15.9 PROJECTION PARAMETERS

[
First Latitude Parameter	: (-900000000..900000000)	
	NULL	
First Longitude Parameter	: (-1800000000..1800000000)	
	NULL	
Second Latitude Parameter	: (-900000000..900000000)	
	NULL	
Second Longitude Parameter	: (-1800000000..1800000000)	
	NULL	
Third Latitude Parameter	: (-900000000..900000000)	
	NULL	
Third Longitude Parameter	: (-1800000000..1800000000)	
	NULL	
Point Scale Factor	: (-9999..9999)	
	NULL	
]		

11.3.15.10 NATIONAL GRID

[
National Grid Identifier	: NATIONAL GRID ID		11.8.7.34
Grid Axis Orientation	: GRID AXIS ORIENTATION		11.8.8.1
Help Grid Origin	: LAT/LONG PAIR		11.3.15.11
	NULL		
National Grid Origin	: OPTIONAL COORDINATE PAIR		11.8.5.5
	NULL		
Grid Rotation	: (0..400000000)		
	NULL		
Grid Name	: GRID NAME		11.8.3.5
	NULL		
Grid Code	: GRID CODE		11.8.3.4
]			

Constraints

- C1: The National Grid Identifier is an identifier of the National Grid which must be unique within the Dataset.
 C2: At least one optional field must be present.
 C3: National Grid Origin is expressed in decimetres.

Comments:

K1 Corresponds to 12.6.17.4 NATIONAL GRID in MRS (Rec64).

11.3.15.11 LAT/LONG PAIR

[
Latitude	: (-900000000..900000000)	
	NULL	
Longitude	: (-1800000000..1800000000)	
	NULL	
]		

Constraints

- C1: At least one optional field must be present.

11.3.15.12 GEOID UNDULATION

[
Geoid Description Identifier	: GEOID UNDULATION ID	11.8.7.35	
Reference Point Position	: LAT/LONG PAIR	11.3.15.11	
Ellipsoidal Height	: (-9999..9999)		
]			

Constraints

- C1: The Geoid Undulation Identifier is an identifier of the of a Geoid Undulation which must be unique within the Dataset.
C2: Ellipsoidal Height is expressed in decimetres.

Comments:

K1: Corresponds to 12.6.17.5 GEOID UNDULATION in MRS (Rec65)

11.3.15.13 MAGNETIC FIELD DECLINATION

[
Magnetic Field Description Identifier	: MAGNETIC FIELD DECLINATION ID	11.8.7.36	
Reference Point Position	: LAT/LONG PAIR	11.3.15.11	
Declination Validity Date	: DATE STAMP	11.6.3.2	
	NULL		
Magnetic Variation Value	: (-400000..400000)		
	NULL		
Annual Change	: (-400000..400000)		
	NULL		
Horizontal Magnetic Field Intensity	: (0..99999)		
	NULL		
Vertical Magnetic Field Intensity	: (0..99999)		
	NULL		
]			

Constraints

- C1: The Magnetic Field Declination Identifier is an identifier of the Magnetic Field Declination, which must be unique within the Dataset.
C2: At least one optional field must be non-NULL.
C3: Horizontal and Vertical Magnetic Field Intensities are specified in nano Tesla.

Comments:

K1: Corresponds to 12.6.17.6 MAGNETIC FIELD DECLINATION in MRS (Rec66).

11.3.15.14 Basic Data Types used by Geodetical Parameters

11.3.15.14.1 Overview

Simple types used by Geodetical Parameters

11.3.15.14.2 GRID AXIS ORIENTATION

= (Normal Cartesian=0, Reverse Cartesian=1)

11.3.16 DATASET DATA

[
Update Information Records	: [UPDATE INFORMATION]+		11.7.2
	NULL		
Relationships	: [RELATIONSHIP]+		11.5.4.5.2
	NULL		
Attributes	: [ATTRIBUTE GROUP]+		11.5.4.6.2
	NULL		
Text Records	: [TEXT RECORD]+		11.5.4.7.2
	NULL		
Time Domain Syntax Records	: [TIME DOMAIN]+		11.6.2.2
	NULL		
Object Reference Records	: [OBJECT REFERENCE]+		11.5.4.9.2
	NULL		
]			

Constraints

C1: Update Information Records and Object Reference Records may only exist if at least one of the other 4 elements is present and they need to decorate any subset of those other elements.

11.4 Layers

11.4.1 Overview

A Dataset is subdivided into one or more Layers, which are in turn subdivided into Sections. Typically, Datasets division to Layers is based upon content criteria, while Layers division to Section is based upon geographical criteria.

Relations between Section, Layers and Primitives are illustrated in the diagram of section 11.1.5 and in UML data model Figure 21, Figure 22 and Figure 23.

11.4.2 LAYER

[
Layer Identifier	: LAYER ID		11.8.7.11
Layer Metadata	: LAYER HEADER		11.4.3
Section Set	: [SECTION]+		11.5.2
]			

Constraints

C1: The Layer Identifier is an identifier of a Layer which must be unique within a particular Dataset.

11.4.3 LAYER HEADER

[
Layer Topology	: LAYER TOPOLOGY		11.4.5.2
Height Level Referencing	: HEIGHT LEVEL METHOD		11.4.5.3
XY Resolution	: (0..999)		
Layer Theme SET	: [FEATURE THEME CODE]+		11.8.2.6
	NULL		
]			

11.4.4 LAYER DATA

[
Update Information Records	: [UPDATE INFORMATION]+		11.7.2
	NULL		
Relationships	: [RELATIONSHIP]+		11.5.4.5.2
	NULL		
Attributes	: [ATTRIBUTE GROUP]+		11.5.4.6.2
	NULL		
Text Records	: [TEXT RECORD]+		11.5.4.7.2
	NULL		
Time Domain Syntax Records	: [TIME DOMAIN]+		11.6.2.2
	NULL		
Object Reference Records	: [OBJECT REFERENCE]+		11.5.4.9.2
	NULL		
]			

Constraints

C1: Update Information Records and Object Reference Records may only exist if at least one of the other 4 elements is present and they need to decorate any subset of those other elements.

11.4.5 Basic Data Types used by Layers

11.4.5.1 Overview

Simple and compound types used by Layers

11.4.5.2 LAYER TOPOLOGY

= (Non-Explicit Topology=1, Non-Planar-Connectivity Topology=2, Planar-Full Topology=3)

11.4.5.3 HEIGHT LEVEL METHOD

= (Implied by Coordinates=0, Via Edge Levels=1, Via Grade Separated Crossing Relationship=2, None=3)

11.5 Sections

11.5.1 Overview

A Layer is subdivided into one or more Sections, typically, based upon geographical criteria. See UML data model figures Figure 22, Figure 23 and Figure 25 for topology type-specific composition primitives of Sections and for Feature conversion across Sections.

11.5.2 SECTION

[
Section Identifier	: SECTION ID		11.8.7.12
Section Metadata	: SECTION HEADER		11.5.3.2
Section Data	: SECTION DATA		11.5.4.2
]			

11.5.3 Section Metadata

11.5.3.1 Overview

This clause describes the Section Metadata.

11.5.3.2 SECTION HEADER

[
Section Identification	: GEOGRAPHIC COVERAGE NAME	11.5.3.3	
	NULL		
XY Resolution	: (0..999)		
	NULL		
Lane Counting Default Direction Convention	: LANE COUNTING DIRECTION	11.5.3.4	
	NULL		
Network	: NETWORK ID	11.8.7.40	
	NULL		
Datasource References	: [SOURCE ID]+	11.8.7.30	
	NULL		
Section Datum & Magnetism Use	: DATUM AND MAGNETISM USE	11.5.3.5	
	NULL		
Section Orthometric Reference Use	: ORTHOMETRIC REFERENCE USE	11.5.3.7	
	NULL		
Section Borders	: SECTION BORDERS	11.5.3.9	
XY Control Point	: XY CONTROL POINT	11.5.3.10	
	NULL		
Z Control Point	: Z CONTROL POINT	11.5.3.11	
	NULL		
Update Information Time Stamp Format	: TIME STAMP FORMAT	11.6.3.9	
	NULL		
]			

Constraints

- C1: The Sources referred to by Datasource Reference Identifiers must belong to the same Dataset as the Section in question (inside Layer). Furthermore, the Sources must have been previously defined in order to be used here.
- C2: The Geoid height values referred to by Geoid Description Identifier must belong to the same Dataset as the Section in question.

11.5.3.3 GEOGRAPHIC COVERAGE NAME

= STRING 11.5.4.7.4

11.5.3.4 LANE COUNTING DIRECTION

= (RIGHT=0, LEFT=1)

11.5.3.5 DATUM AND MAGNETISM USE

[
Horizontal Datum Used	: HORIZONTAL DATUM ID	11.8.7.31	
Horizontal Reference Coordinate Type	: COORDINATE TYPE	11.5.3.6	
Projection Used	: PROJECTION ID	11.8.7.33	
	NULL		
National Grid Used	: NATIONAL GRID ID	11.8.7.34	
	NULL		
Magnetic Field Declinations Set Used	: [MAGNETIC FIELD DECLINATION ID]+	11.8.7.36	
	NULL		
]			

Constraints

- C1: The Horizontal Datum referred to by the Horizontal Datum Used Identifier must belong to the same Dataset as the Section in question (inside Layer). Furthermore, the Horizontal Datums must have been previously defined in order to be used here.
- C2: The Projection referred to by Projection Used Identifier must belong to the same Dataset as the Section in question (inside Layer). Furthermore, the Projections must have been previously defined in order to be used here.
- C3: The National Grid referred to by National Grid Used Identifier must belong to the same Dataset as the Section in question (inside Layer). Furthermore, the National Grids' Identifiers must have been previously defined in order to be used here.
- C4: The Magnetic Field Declinations referred to by Magnetic Field Declination Used Identifiers must belong to the same Dataset as the Section in question (inside Layer). Furthermore, the Magnetic Field Declinations must have been previously defined in order to be used here.
- C5: In this structure Datum and Magnetism cannot both be NULL.

Comments:

K1: Corresponds to 12.6.19.5 DATUM AND MAGNETISM USE in MRS (Rec16.05)

11.5.3.6 COORDINATE TYPE

= (LAT/LONG=0, X/Y=1)

11.5.3.7 ORTHOMETRIC REFERENCE USE

[
Height Reference Type	: HEIGHT REFERENCE TYPE		11.5.3.8
Vertical Datum Used	: VERTICAL DATUM ID		11.8.7.32
	NULL		
Geoid Undulation Set	: [GEOID UNDULATION ID]+		11.8.7.35
	NULL		
]			

Constraints

- C1: The Vertical Datum referred to by Vertical Datum Used must belong to the same Dataset as the Section in question (inside Layer). Furthermore, the Vertical Datums must have been previously defined in order to be used here.
- C2: {The Geoid Undulations referred to by Geoid Undulation Set must belong to the same Dataset as the Section in question (inside Layer). Furthermore, the Geoid Undulations must have been previously defined in order to be used here.

11.5.3.8 HEIGHT REFERENCE TYPE

= (Ellipsoidal=0, Orthometric=1, Relative=2)

11.5.3.9 SECTION BORDERS

[
XY Multiplication Factor	: (-9..9)		
Z Multiplication Factor	: (-9..9)		
	NULL		
XYZ Offset	: COORDINATE TRIPLET		11.8.5.3
	NULL		
Maximum XY	: COORDINATE PAIR		11.8.5.4
	NULL		
Minimum XY	: COORDINATE PAIR		11.8.5.4
	NULL		
]			

Comments:

K1: Corresponds to 12.6.19.7 SECTION BORDERS in MRS (Rec16.07)

11.5.3.10 XY CONTROL POINT

[
Point Name	: STRING	11.5.4.7.4	
	NULL		
X Digitized	: (-9999999999..9999999999)		
	NULL		
Y Digitized	: (-9999999999..9999999999)		
	NULL		
X Surveyed	: (-9999999999..9999999999)		
	NULL		
Y Surveyed	: (-9999999999..9999999999)		
	NULL		
]			

Constraints

C1: The members of this structure cannot all be NULL. That is, at least one of them must have a value
 C2: The Point Name is an “identifier” of a control point which must be unique within the particular Section.
 C3: All the X,Y values are specified in centimetres.

11.5.3.11 Z CONTROL POINT

[
Point Name	: STRING	11.5.4.7.4	
	NULL		
XY Reference	: COORDINATE PAIR	11.8.5.4	
	NULL		
Z Digitized	: COORDINATE VALUE	11.8.5.7	
	NULL		
Z Surveyed	: COORDINATE VALUE	11.8.5.7	
	NULL		
]			

Constraints

C1: The members of this structure cannot all be NULL. That is, at least one of them must have a value
 C2: The Point Name is an “identifier” of a control point which must be unique within the particular Section.

11.5.4 Section Data

11.5.4.1 Overview

This clause describes the Section Data.

11.5.4.2 SECTION DATA

[
Update Information Records	: [UPDATE INFORMATION]+	11.7.2	
	NULL		
Topological Geometric Data	: TOPO/GEO DATA	11.5.4.3.2	
	NULL		
Feature Data	: FEATURE DATA	11.5.4.4.2	
	NULL		
Relationships	: [RELATIONSHIP]+	11.5.4.5.2	
	NULL		
Attributes	: [ATTRIBUTE GROUP]+	11.5.4.6.2	
	NULL		
]			

Text Records	NULL : [TEXT RECORD]+	11.5.4.7.2
Time Domain Syntax Records	NULL : [TIME DOMAIN]+	11.6.2.2
Conversion Records	NULL : [CONVERSION]+	11.5.4.8.2
Object Reference Records	NULL : [OBJECT REFERENCE]+	11.5.4.9.2
	NULL	
]		

11.5.4.3 Topological Geometric Data

11.5.4.3.1 Overview

Topology, Geometry, and their constructs are described here.

11.5.4.3.2 TOPO/GEO DATA

[
Nodes	: [NODE]+	11.5.4.3.3
	NULL	
Edges	: [EDGE]+	11.5.4.3.4
	NULL	
Faces	: [FACE]+	11.5.4.3.5
	NULL	
]		

11.5.4.3.3 NODE

[
Node Identifier	: NODE ID	11.8.7.14
Source	: SOURCE ID	11.8.7.30
	NULL	
Node in Face	: FACE ID	11.5.4.3.5
	NULL	
Node Status	: NODE STATUS	11.5.4.3.8.2
	NULL	
Coordinate Record	: COORDINATE ID	11.8.7.13
Edge BP Set	: [EDGE ID]+	11.8.7.15
	NULL	
Point Feature BP Set	: [POINT FEATURE ID]+	11.8.7.17
	NULL	
]		

Constraints

C1: The Node Identifier is an identifier of a Node which must be unique within a particular Section.

C2: Source Description Identifier must exist.

C3: The Face referred by Node in Face must belong to the same Section as the Node in question.

C4: The Edges and Point Features must belong to the same Section as the Node in question.

11.5.4.3.4 EDGE

[
Edge Identifier	: EDGE ID		11.8.7.15
Source	: SOURCE ID		11.8.7.30
	NULL		
From Node	: NODE ID		11.8.7.14
To Node	: NODE ID		11.8.7.14
Left Face	: FACE ID		11.8.7.16
	NULL		
Right Face	: FACE ID		11.8.7.16
	NULL		
Edge Status	: EDGE STATUS		11.5.4.3.8.3
	NULL		
Coordinate Record	: COORDINATE ID		11.8.7.13
Line Feature BP Set	: [LINE FEATURE ID]+		11.8.7.18
	NULL		
Area Feature BP Set	: [AREA FEATURE ID]+		11.8.7.19
	NULL		
]			

Constraints

- C1: The Edge Identifier is an identifier of an Edge which must be unique within a particular Section.
- C2: Source Description Identifier must exist.
- C3: The Nodes referred to by From Node Identifier and To Node Identifier must belong to the same Section as the Edge in question.
- C4: The Faces referred to by Left Face Identifier and Right Face Identifier must belong to the same Section as the Edge in question.
- C5: The order of the Coordinate values referred to via the Coordinate ID is meaningful. The order represents the topological order and orientation of the point sequence of the Edge (as rendered inside the Coordinate Record)..
- C6: The Line BP and Area BP Feature Sets must belong to the same Section as the Edge.

11.5.4.3.5 FACE

[
Face Identifier	: FACE ID		11.8.7.16
Source	: SOURCE ID		11.8.7.30
	NULL		
Bounding Edges	: [BOUNDING EDGE]+		11.5.4.3.6
Area Feature BP Set	: [AREA FEATURE ID]+		11.8.7.19
	NULL		
Extended Area Geometry	: EXTENDED AREA GEOMETRY		11.5.4.3.7
	NULL		
]			

Constraints:

- C1: The Face Identifier is an identifier of a Face which must be unique within a particular Section
- C2: Source Description Identifier must exist.
- C3: The Edge(s) referred to by Edge Identifiers (inside BOUNDING EDGE) must belong to the same Section as this Face.

11.5.4.3.6 BOUNDING EDGE

[
Edge Identifier	: EDGE ID		11.8.7.15
Edge Orientation	: EDGE ORIENTATION		11.5.4.3.8.4
]			

Constraints

C1: ELEMENT(EDGE ID) should exist in this scope.

11.5.4.3.7 EXTENDED AREA GEOMETRY

[
Geometrical Type	:	GEOMETRICAL TYPE	11.5.4.3.8.5
Outline Length of Bounded Area		(0..9999999999)	
		NULL	
Size of Bounded Area		(0..9999999999)	
		NULL	
Slope of Bounded Area	:	(0..999)	
		NULL	
Aspect of Bounded Area	:	(0..3599)	
		NULL	
Light Value of Bounded Area	:	(0..255)	
		NULL	
]			

Constraints:

C1: Outline Length is specified in decimeters.

C2: Size is specified in square meters.

C3: Slope is specified in percentage.

11.5.4.3.8 Basic Data Types used by Topological Geometric Data

11.5.4.3.8.1 Overview

Simple and compound types used by Topological Geometric Data

11.5.4.3.8.2 NODE STATUS

= (Section Border Node=1, Normal Node=2, Dataset Border Node=3, End of Stubble=4, Normal Node on a Section and/or Dataset border=5)

11.5.4.3.8.3 EDGE STATUS

= (Section Border Edge=1, Normal Edge=2, Dataset Border Edge=3, Normal Edge on a Section and/or Dataset border=5)

11.5.4.3.8.4 EDGE ORIENTATION

= (Clockwise=0, Counter-clockwise=1)

11.5.4.3.8.5 GEOMETRICAL TYPE

= (Triangular=3, Quadrangular=4, Other=0)

11.5.4.4 Feature Data

11.5.4.4.1 Overview

Feature Data is described here.

11.5.4.4.2 FEATURE DATA

[
Simple Feature Data	: SIMPLE FEATURE DATA	11.5.4.4.3	
	NULL		
Complex Feature Data	: [COMPLEX FEATURE]+	11.5.4.4.24	
	NULL		
]			

11.5.4.4.3 SIMPLE FEATURE DATA

[
Point Feature	: [POINT FEATURE]+	11.5.4.4.4	
	NULL		
Line Feature	: [LINE FEATURE]+	11.5.4.4.9	
	NULL		
Area Feature	: [AREA FEATURE]+	11.5.4.4.17	
	NULL		
]			

11.5.4.4.4 POINT FEATURE

[
Point Feature Identifier	: POINT FEATURE ID	11.8.7.17	
Source	: SOURCE ID	11.8.7.30	
	NULL		
Network	: NETWORK ID	11.8.7.40	
	NULL		
Feature Class Code	: ANY FEATURE CLASS CODE	11.3.6.10	
Topo/Geo Rendering	: EXPLICIT TOPOLOGY POINT RENDERING	11.5.4.4.5	
	NON-EXPLICIT TOPOLOGY POINT RENDERING	11.5.4.4.6	
Attribute Group Set	: [SCOPED ATTRIBUTE]+	11.5.4.6.6	
	NULL		
Complex Feature Set	: [COMPLEX FEATURE ID]+	11.8.7.20	
	NULL		
Relationship Set	: [RELATIONSHIP ID]+	11.8.7.22	
	NULL		
Conversion Record Set	: [CONVERSION ID]+	11.8.7.25	
	NULL		
]			

Constraints

- C1: The Point Feature Identifier is an identifier of a Point Feature which must be unique within a particular Section.
- C2: The data source referred to by Source Description Identifier must belong to the same Dataset as the Point Feature in question.
- C3: NETWORK ID must exist as ELEMENT(NETWORK ID).
- C4: The Node below “must exist” as ELEMENT(NODE ID).
- C5: The Node referred to by Node Identifier (inside EXPLICIT TOPO POINT GEO RENDERING, inside EXPLICIT TOPOLOGY POINT RENDERING) must belong to the same Section as the Point Feature in question. In the Non-Explicit Topology case no Nodes are used.
- C6: The Topo Rendering choice for this Point Feature should be the same for all Features in the Layer.

11.5.4.4.5 EXPLICIT TOPOLOGY POINT RENDERING

[
Geometry	: EXPLICIT TOPO POINT GEO RENDERING	11.5.4.4.7	
	NULL		
Line BP Set	: [LINE FEATURE ID]+	11.8.7.18	
	NULL		
]			

11.5.4.4.6 NON-EXPLICIT TOPOLOGY POINT RENDERING

[
Geometry : NON-EXPLICIT TOPO POINT GEO RENDERING 11.5.4.4.8
]

11.5.4.4.7 EXPLICIT TOPO POINT GEO RENDERING

[
Node Identifier : NODE ID 11.8.7.14
]

Constraints

C1: ELEMENT(NODE ID) should exist in the scope that it is used from.

11.5.4.4.8 NON-EXPLICIT TOPO POINT GEO RENDERING

[
Coordinate Mask : (0..3331)
Time Mask : (1..16)
| NULL
X,Y Coordinates : COORDINATE PAIR 11.8.5.4
Z Coord : COORDINATE VALUE 11.8.5.7
| NULL
H1 Coordinate : COORDINATE VALUE 11.8.5.7
| NULL
Temporal Coordinate Tuple : TEMPORAL COORDINATE TUPLE 11.8.5.6
| NULL
]

11.5.4.4.9 LINE FEATURE

[
Line Feature Identifier : LINE FEATURE ID 11.8.7.18
Source : SOURCE ID 11.8.7.30
| NULL
Network : NETWORK ID 11.8.7.40
| NULL
Feature Class Code : ANY FEATURE CLASS CODE 11.3.6.10
Split Indicator : SPLIT INDICATOR 11.5.4.4.27.2
Topo/Geo Rendering : EXPLICIT TOPOLOGY LINE RENDERING 11.5.4.4.10
| NON-EXPLICIT TOPOLOGY LINE RENDERING 11.5.4.4.14
Attribute Group Set : [SCOPED ATTRIBUTE]+ 11.5.4.6.6
| NULL
Complex Feature Set : [COMPLEX FEATURE ID]+ 11.8.7.20
| NULL
Relationship Set : [RELATIONSHIP ID]+ 11.8.7.22
| NULL
Conversion Record Set : [CONVERSION ID]+ 11.8.7.25
| NULL
]

Constraints

C1: The Line Feature Identifier is an identifier of a Line Feature which must be unique within a particular Section.

C2: The data source referred to by Source Description Identifier must belong to the same Dataset as the Point Feature in question.

C3: The Points referred to by From Point Identifier and To Point Identifier must belong to the same Section as the Line Feature in question.

C4: The Edge referred to by Edge Identifier (deep inside EDGE REFERENCE) must belong to the same Section as this Line Feature. Only used in “explicit” mode.

C5: ELEMENT(source, network) have to exist.

C6: The Topo Rendering choice for this Line Feature should be the same for all the Features in this Layer.

11.5.4.4.10 EXPLICIT TOPOLOGY LINE RENDERING

[
Topology	: EXPLICIT TOPO LINE TOPOLOGY		11.5.4.4.12
Geometry	: EXPLICIT TOPO LINE GEO RENDERING		11.5.4.4.13
	NULL		
]			

11.5.4.4.11 NON-EXPLICIT TOPOLOGY LINE RENDERING

[
Geometry	: NON-EXPLICIT TOPO LINE GEO RENDERING		11.5.4.4.14
]			

11.5.4.4.12 EXPLICIT TOPO LINE TOPOLOGY

[
From Point Feature	: POINT FEATURE ID		11.8.7.17
	NULL		
To Point Feature	: POINT FEATURE ID		11.8.7.17
	NULL		
]			

11.5.4.4.13 EXPLICIT TOPO LINE GEO RENDERING

[
Edge Reference Sequence	: [EDGE REFERENCE]+		11.5.4.4.15
	NULL		
Ending Height	: (-9..9)		
	NULL		
]			

11.5.4.4.14 NON-EXPLICIT TOPO LINE GEO RENDERING

[
Coordinate Mask	: (0..3331)		
Time Mask	: (1..16)		
	NULL		
X,Y Coordinate Sequence	: [COORDINATE PAIR]+		11.8.5.4
From Interval Position Sequence	: [(0..99999)]+		
	NULL		
Discrete Dynamic Counter of Zs	(0..99999)		
Z Coordinate Sequence	: [COORDINATE VALUE]+		11.8.5.7
	NULL		
Discrete Dynamic Counter of H1s	(0..99999)		
H1 Coordinate Sequence	: [COORDINATE VALUE]+		11.8.5.7
	NULL		
Discrete Dynamic Counter of H2s	(0..99999)		
H2 Coordinate Sequence	: [COORDINATE VALUE]+		11.8.5.7
	NULL		
Temporal Coordinate Tuple	: TEMPORAL COORDINATE TUPLE		11.8.5.6
	NULL		
]			

Constraints

C1: There shall be at least 2 points in the X,Y Coordinate Sequence.

C2: The order of the Coordinate Pairs in the X,Y Coordinate Sequence is significant and is to be maintained.

11.5.4.4.15 EDGE REFERENCE

[
Starting Height	: (-9..9)		
	NULL		
Intermediate Height	: (-9..9)		
	NULL		
Composing Edge	: COMPOSING EDGE	11.5.4.4.16	
]			

11.5.4.4.16 COMPOSING EDGE

[
Edge Identifier	: EDGE ID	11.8.7.15	
Line Direction	: LINE DIRECTION	11.5.4.4.27.4	
]			

Constraints

C1: ELEMENT(EDGE ID) should exist in this scope.

11.5.4.4.17 AREA FEATURE

[
Area Feature Identifier	: AREA FEATURE ID	11.8.7.19	
Source	: SOURCE ID	11.8.7.30	
	NULL		
Network	: NETWORK ID	11.8.7.40	
	NULL		
Feature Class Code	: ANY FEATURE CLASS CODE	11.3.6.10	
Split Indicator	: SPLIT INDICATOR	11.5.4.4.27.2	
Topo/Geo Rendering	: FULL TOPOLOGY AREA RENDERING	11.5.4.4.18	
	CONNECTIVITY TOPOLOGY AREA RENDERING	11.5.4.4.19	
	NON-EXPLICIT TOPOLOGY AREA RENDERING	11.5.4.4.23	
Attribute Group Set	: [SCOPED ATTRIBUTE]+	11.5.4.6.6	
	NULL		
Complex Feature Set	: [COMPLEX FEATURE ID]+	11.8.7.20	
	NULL		
Relationship Set	: [RELATIONSHIP ID]+	11.8.7.22	
	NULL		
Conversion Record Set	: [CONVERSION ID]+	11.8.7.25	
	NULL		
]			

Constraints

C1: The Area Feature Identifier is an identifier of an Area Feature that must be unique within a particular Section.

C2: The Face(s) referred to by Face Identifier must belong to the same Section as the Area Feature in question.

C3: The Face referred to by Face Identifier inside the full topology rendering must belong to the same Section as the Area Feature that refers to that Face. Furthermore, the Face must have been previously defined in order to be used here.

C4: The Edge referred to by Edge Identifier inside the connectivity rendering must belong to the same Section as the Area Feature that refers to that Edge. Furthermore, the Edge must have been previously defined in order to be used here.

C5: The Source must have been previously defined in order to be used here.

C6: The Network must have been previously defined in order to be used here.

C7: The Topological Rendering choice for this Area Feature should be the same for all Features in this Layer.

11.5.4.4.18 FULL TOPOLOGY AREA RENDERING

```
[
Geometry           : FULL TOPO AREA GEO RENDERING      11.5.4.4.21
                   | NULL
]
```

11.5.4.4.19 CONNECTIVITY TOPOLOGY AREA RENDERING

```
[
Geometry           : CONNECTIVITY TOPO AREA GEO RENDERING 11.5.4.4.22
                   | NULL
]
```

11.5.4.4.20 NON-EXPLICIT TOPOLOGY AREA RENDERING

```
[
Geometry           : NON-EXPLICIT TOPO AREA GEO RENDERING 11.5.4.4.23
]
```

11.5.4.4.21 FULL TOPO AREA GEO RENDERING

```
[
Face Identifiers   : [FACE ID]+                          11.8.7.16
]
```

11.5.4.4.22 CONNECTIVITY TOPO AREA GEO RENDERING

```
[
Bounding Edge Sequence : [BOUNDING EDGE]+                11.5.4.3.6
]
```

Constraints

C1: There Must be at least 3 Edges in the Sequence.

11.5.4.4.23 NON-EXPLICIT TOPO AREA GEO RENDERING

```
[
Coordinate Mask     : (0..3331)
Time Mask           : (1..16)
                   | NULL
X,Y Coordinate Sequence : [COORDINATE PAIR]+           11.8.5.4
From Interval Position Sequence : [ (0..99999) ]+
                   | NULL
Discrete Dynamic Counter of Zs (0..99999)
Z Coordinate Sequence : [COORDINATE VALUE]+           11.8.5.7
                   | NULL
Discrete Dynamic Counter of H1s (0..99999)
H1 Coordinate Sequence : [COORDINATE VALUE]+           11.8.5.7
                   | NULL
Discrete Dynamic Counter of H2s (0..99999)
H2 Coordinate Sequence : [COORDINATE VALUE]+           11.8.5.7
                   | NULL
]
```

Temporal Coordinate Tuple	: TEMPORAL COORDINATE TUPLE NULL	11.8.5.6
Extended Area Geometry	: EXTENDED AREA GEOMETRY NULL	11.5.4.3.7

]

Constraints

C1: There shall be at least 3 points in the X,Y Coordinate Sequence.

C2: The order of the Coordinate Pairs in the X,Y Coordinate Sequence is significant and is to be maintained.

C3: If the final X,Y COORDINATE PAIR does not match (equal) the first X,Y COORDINATE PAIR then it should be “inferred” that there is an additional ‘segment’ which connects the final COORDINATE PAIR to the first, to close the ‘polygon’.

11.5.4.4.24 COMPLEX FEATURE

[
Complex Feature Identifier	: COMPLEX FEATURE ID	11.8.7.20
Source	: SOURCE ID NULL	11.8.7.30
Network	: NETWORK ID NULL	11.8.7.40
Feature Class Code	: ANY FEATURE CLASS CODE	11.3.6.10
Complex Split Indicator	: COMPLEX SPLIT INDICATOR	11.5.4.4.27.3
Topology	: EXPLICIT COMPLEX FEATURE TOPOLOGY NULL	11.5.4.4.25
Complex Feature Part Sequence	: [COMPOSING FEATURE]+ NULL	11.5.4.4.26
Attribute Group Set	: [SCOPED ATTRIBUTE]+ NULL	11.5.4.6.6
Parent Complex Feature BP Set	: [COMPLEX FEATURE ID]+ NULL	11.8.7.20
Relationship Set	: [RELATIONSHIP ID]+ NULL	11.8.7.22
Conversion Record Set	: [CONVERSION ID]+ NULL	11.8.7.25
]		

Constraints

C1: The Complex Feature Identifier is an identifier of a Complex Feature which must be unique within a particular Section.

C2: source ID and network ID “must exist” in this Dataset.

C3: The Complex Features referred to by From Complex Feature and To Complex Feature (inside EXPLICIT COMPLEX FEATURE TOPOLOGY) must belong to the same Section as this Complex Feature.

C4: The Features referred to by Feature Identifier (inside – even nested – the COMPOSING FEATURE) must belong to the same Section as this Complex Feature.

11.5.4.4.25 EXPLICIT COMPLEX FEATURE TOPOLOGY

[
From Complex Feature	: COMPLEX FEATURE ID NULL	11.8.7.20
To Complex Feature	: COMPLEX FEATURE ID NULL	11.8.7.20
Complex Feature From/To BP Spoke Set	: [COMPLEX FEATURE ID]+ NULL	11.8.7.20
]		

Constraints:

C1: From/To topological information is only attached to “line-ish” Complex Features.

11.5.4.4.26 COMPOSING FEATURE

[
Feature Identifier	:	ANY FEATURE	11.8.7.1
Feature Part Attribute Group Set	:	[SCOPED ATTRIBUTE]+	11.5.4.6.6
		NULL	
]			

Constraints

C1: The Features referred to by Feature Identifier (inside ANY FEATURE) must exist in their declared scope.

11.5.4.4.27 Basic Data Types used by Feature Data

11.5.4.4.27.1 Overview

Simple and compound types used by Feature Data

11.5.4.4.27.2 SPLIT INDICATOR

= (Entire Feature=0, Part of a Split Feature=1)

11.5.4.4.27.3 COMPLEX SPLIT INDICATOR

= (Entire Feature=0, Part of a Split Feature=1, Repeated in another Section=2)

11.5.4.4.27.4 LINE DIRECTION

= (Same as Edge=0, Opposite=1)

11.5.4.5 Relationships

11.5.4.5.1 Overview

The data structures defined in this section are meant to represent Relationships between features and Attributes.

11.5.4.5.2 RELATIONSHIP

[
Relationship Identifier	:	RELATIONSHIP ID	11.8.7.22
Source	:	SOURCE ID	11.8.7.30
		NULL	
Relationship Code	:	ANY RELATIONSHIP CLASS CODE	11.3.6.26
Relationship Feature Partner Sequence	:	[PARTNER]+	11.5.4.5.3
Relationship Attribute Group Set	:	[EXPLICITLY SCOPED ATTRIBUTE]+	11.5.4.6.7
		NULL	
]			

Constraints

C1: The Relationship Identifier is an identifier of a Relationship instance which must be unique within a particular Section.

C2: The source document referred to by Source Description Identifier must belong to the same Dataset as the Relationship in question. It also needs to exist ie ELEMENT().

- C3: ELEMENT(ATTRIBUTE ID SET LIST)} that is we have to make sure that the ATTRIBUTE ID exists as an ELEMENT(Attributes in the section of this Relationship, ie in scope).
Any elements of the Attribute Group Set which are *not* contained in the same <DLS> as the Relationship must have the sufficient set of <DLS> in its Scoped Attribute to be located.
*]
- C4: ELEMENT([rel. def.]->rel code set) i.e. the code used has to be in the set defined by the structure in rel. def record set.

11.5.4.5.3 PARTNER

[
Partner Feature	: ANY FEATURE		11.8.7.1
Feature Role Number	: (1..99)		
Relationship Partner Attributes Record Set	: [SCOPED ATTRIBUTE]+		11.5.4.6.6
	NULL		
]			

Constraints

C1 Partner Feature must exist as well as within its scope and all of its components.

11.5.4.6 Attributes

11.5.4.6.1 Overview

Attributes travel in 'groups'. The top level entity (that is, the Attribute Group) is a sequence (in which order is significant) of Attributes (either simple or composite).

11.5.4.6.2 ATTRIBUTE GROUP

[
Attribute Group Identifier	: ATTRIBUTE ID		11.8.7.21
Attribute Sequence	: [ATTRIBUTE]+		11.5.4.6.3
]			

Constraints

C1: The Attribute Set Identifier is an identifier of a particular Attribute Set which is unique within a particular Section.

C2: The [ATTRIBUTE]+ is not a "usual" Set, but actually a Sequence, that is order matters.

11.5.4.6.3 ATTRIBUTE

[
Attribute Sequence Element	: SIMPLE ATTRIBUTE		11.5.4.6.4
	COMPOSITE ATTRIBUTE		11.5.4.6.5
]			

11.5.4.6.4 SIMPLE ATTRIBUTE

[
Attribute Type Code	: ANY ATTRIBUTE TYPE CODE		11.3.6.18
Source	: SOURCE ID		11.8.7.30
	NULL		
Value Scope	: DATA SCOPE		11.5.4.6.9.2
	NULL		
Attribute Value	: SHORT STRING		11.5.4.7.5
	TEXT ID		11.8.7.23
	TIME ID		11.8.7.24
	GEOPOLITICAL STRUCTURE REFERENCE		11.3.14
Feature BP Set	: [ANY FEATURE IN DATASET]+		11.8.7.2

Text Record BP Set	NULL : [TEXT RECORD IN DATASET]+	11.8.7.3
Relationship BP Set	NULL : [RELATIONSHIP IN DATASET]+ NULL	11.8.7.4

]

Constraints:

- C1: The data source referred to by Description Identifier must belong to the same Dataset as the Attribute in question.
- C2: ELEMENT(ATTRIBUTE DEFINITION LIST) or type codes defined in {ATTRIBUTE TYPE CODE} set.
- C3: The Source must have been previously defined in order to be used here .
- C4: The Source Description Id must be in the {Dataset}. The data source referred to by Description Identifier must belong to the same Dataset as the Attribute in question.
- C5: The Text must have been previously defined in order to be used here.
- C6: The Time Domain must have been previously defined in order to be used here.
- C7: If Attribute Value is of type SHORT STRING then Value Scope is NULL.
- C8: The Feature referred to by Feature BP (back pointer) must have been previously defined in order to be used here.
- C9: The Text referred to by Text BP (back pointer) must have been previously defined in order to be used here.
- C10: The Relationship referred to by Relationship BP (back pointer) must have been previously defined in order to be used here.

11.5.4.6.5 COMPOSITE ATTRIBUTE

Sub-Attributes	: [ATTRIBUTE]+	11.5.4.6.3
----------------	----------------	------------

]

Constraints

- C1: The Sub-Attributes in the [ATTRIBUTE]+ are ordered, that is it is a Sequence, even if not in all case there is a strict semantic ordering intended by the specific Composite Attribute.
- C2: Each *Sub-Attribute* of a *Composite Attribute* is either a *Simple Attribute*, a *Composite Attribute*, or a *Restrictive Sub-Attribute*. Any *Sub-Attribute* being a *Composite Attribute* recursively builds a hierarchical tree of *Sub-Attribute* sets at different hierarchical level. In case a *Restrictive Sub-Attribute* operates on a (*Simple or Composite*) *Attribute*, it implies representing a different (hierarchical) level than said *Attribute*.

11.5.4.6.6 SCOPED ATTRIBUTE

Attribute Partition Level Scope	: DATA SCOPE	11.5.4.6.9.2
Attribute Identifier	: ATTRIBUTE ID	11.8.7.21

]

Comments

- K1: See Figure 24 for a UML data model view of Attribute and Relationship partition scope.

11.5.4.6.7 EXPLICITLY SCOPED ATTRIBUTE

Dataset Identifier	: DATASET ID NULL	11.8.7.10
Layer Identifier	: LAYER ID NULL	11.8.7.11
Section Identifier	: SECTION ID NULL	11.8.7.12
Attribute Identifier	: ATTRIBUTE ID	11.8.7.21

]

Constraints

C1: All items in the EXPLICITLY SCOPED ATTRIBUTE structure must exist and they must form together a partitioning scope which exists in the actual data representation.

Comments

K1: The EXPLICITLY SCOPED ATTRIBUTE structure equals the notion of ANY ATTRIBUTE, in the spirit of related definitions (ANY ATTRIBUTE IN DATASET) and of similar definitions (ANY FEATURE), it just does so more explicitly.

11.5.4.6.8 ANY ATTRIBUTE IN DATASET

[
Layer Identifier	: LAYER ID	11.8.7.11
	NULL	
Section Identifier	: SECTION ID	11.8.7.12
	NULL	
Attribute Identifier	: ATTRIBUTE ID	11.8.7.21
]		

Constraints

C1: All items in the ANY ATTRIBUTE IN DATASET structure must exist and they must form together a scope which exists in the actual data representation.

11.5.4.6.9 Basic Data Types used by Attributes

11.5.4.6.9.1 Overview

Simple and compound types used by Attributes

11.5.4.6.9.2 DATA SCOPE

= (Section='S', Layer='L', Dataset='D')

Comments

K1: The partition level scope of Section is considered local scope, Layer is considered semi-global scope, and Dataset is considered global scope.

11.5.4.7 Text Records

11.5.4.7.1 Overview

All text needs addressed here.

11.5.4.7.2 TEXT RECORD

[
Text Identifier	: TEXT ID	11.8.7.23
Source	: SOURCE ID	11.8.7.30
	NULL	
Text	: LANGUAGE TEXT PAIR	11.5.4.7.3
Text Attribute Group Set	: [SCOPED ATTRIBUTE]+	11.5.4.6.6
	NULL	
Attribute BP Set	: [EXPLICITLY SCOPED ATTRIBUTE]+	11.5.4.6.6
	NULL	
]		

Constraints:

C1: The Text Identifier is an identifier of a Text Record which is unique within a particular Section.

C2: The data source referred to by SOURCE ID must belong to the same Dataset as the this Text Record.
C3: SOURCE ID must exist ie ELEMENT(sources in the Dataset?)

11.5.4.7.3 LANGUAGE TEXT PAIR

[
Language	: LANGUAGE CODE	11.5.4.7.7	
	NULL		
Text	: STRING	11.5.4.7.4	
]			

11.5.4.7.4 STRING

= [CHARACTER]* 11.5.4.7.9

11.5.4.7.5 SHORT STRING

= [CHARACTER]* 11.5.4.7.9

Constraints

C1: Spaces are not allowed.

C2: The length of SHORT STRING may not exceed 11 characters.

11.5.4.7.6 TWO CHARACTERS

[
First Character	: CHARACTER	11.5.4.7.9	
Second Character	: CHARACTER	11.5.4.7.9	
]			

Constraints

C1: The 2 characters are concatenated together.

11.5.4.7.7 LANGUAGE CODE

= A value from the set of ISO Language Codes, which in some cases, may be extended by other language entries as appropriate

See the Metadata Catalogue Annex B.1 for a list of ISO codes

11.5.4.7.8 ALPHABETIC CHARACTER

= ('A'..'Z', 'a'..'z')

11.5.4.7.9 CHARACTER

A printable character from an “appropriate” character set.

11.5.4.8 Conversion Records

11.5.4.8.1 Overview

The data structures described in this sub-clause are meant to enable cross-reference between Features that belong to different Sections.

11.5.4.8.2 CONVERSION

[
Conversion Identifier	: CONVERSION ID	11.8.7.25
Local Feature Category	: FEATURE CATEGORY	11.8.7.8
Local Feature Identifier	: ANY FEATURE ID	11.8.7.5
Foreign Features	: [ANY FEATURE]+	11.8.7.1
]		

Constraints

C1: CONVERSION ID must be unique in the Section that it “resides” in.

C2: The Foreign Features [in the set of ANY FEATURES] must have *all* of the Dataset, Layer, *and* Section Identifiers specified.

11.5.4.9 Object References

11.5.4.9.1 Overview

The object reference is a mechanism which allows the creation of a “permanent-complex-long” ID which usually doesn't fit into a 10-wide integer identifier.

11.5.4.9.2 OBJECT REFERENCE

[
Object Reference Identifier	: OBJECT REF ID	11.8.7.27
Record Type/Subtype Code	: RECORD TYPE IDENTIFIER	11.3.5.5
Object Record Identifier	: ANY GEOMETRICAL ID	11.8.7.6
	ANY OBJECT ID	11.8.7.7
Object Reference Type	: ALPHABETIC CHARACTER	11.5.4.7.8
	NULL	
Object Reference Data Type	: DATA TYPE CODE	11.8.4.1
Object Reference Length	: (1..99999)	
Object Reference	: STRING	11.5.4.7.4
]		

Constraints

C1: The Object Reference Identifier is an identifier of Object Reference Information which must be unique within a particular Section.

C2: The Object Record identifier has a “special” meaning in the MRS realization which is specifically different than in the other realizations which don't part take in the MRS Genome.

C3: The Object Record Identifier must belong to the same scope as the Object Reference in question.

C4: ELEMENT(rec type) must exist, ie in rec def set.

11.6 Time Domain Syntax

11.6.1 Overview

All temporal needs of GDF taken care of here.

11.6.2 Time Domain Syntax Records

11.6.2.1 Overview

The data structures described in this sub-clause provide the means to express a time period of any complexity. See Annex D for more details. Also clause 12 for Time Domain Record (rec45).

11.6.2.2 TIME DOMAIN

[
Time Domain Identifier	: TIME ID		11.8.7.24
Source	: SOURCE ID		11.8.7.30
	NULL		
Time Domain Description	: TIME DOMAIN DESSCRIPTION		11.6.2.3
]			

Constraints

C1: The Time Domain Identifier is an identifier of a Time Domain which must be unique within a particular Section.

C2: The data source referred to by Source Description Identifier must belong to the same Dataset as the Time Domain in question.

11.6.2.3 TIME DOMAIN DESCRIPTION

[
Time Domain Description	: COMPOSITE TIME DOMAIN		11.6.2.4
	BASIC TIME DOMAIN		11.6.2.8
]			

11.6.2.4 COMPOSITE TIME DOMAIN

[
Open Bracket	: '['		
Time Domain Description	: TIME DOMAIN DESCRIPTION		11.6.2.3
Set Operator	: SET OPERATOR		11.6.2.6
Time Domain Description	: TIME DOMAIN DESCRIPTION		11.6.2.3
Additional Terms	: COMPOSITE TIME DOMAIN ELEMENT		
	NULL		
Close Bracket	: ']'		
]			

11.6.2.5 COMPOSITE TIME DOMAIN ELEMENT

[
Set Operator	: REPEATABLE SET OPERATOR		11.6.2.7
Time Domain Description	: TIME DOMAIN DESCRIPTION		11.6.2.3
]			

11.6.2.6 SET OPERATOR

= ('+', '*', '-')

The Set Operator symbols have the following meaning:

A+B: the union of A and B

A*B: the intersection of A and B

A-B: the difference of A and B

11.6.2.7 REPEATABLE SET OPERATOR

= ('+', '*')

11.6.2.8 BASIC TIME DOMAIN

[
Open Bracket	: '['		
Basic Time Domain Expression	: START-DURATION METHOD	11.6.2.9	
	START-END METHOD	11.6.2.10	
Close Bracket	: ']'		
]			

11.6.2.9 START-DURATION METHOD

[
Starting Date Clause	: STARTING OR ENDING DATE CLAUSE	11.6.2.11	
	NULL		
Duration Clause	: DURATION CLAUSE	11.6.2.31	
	NULL		
]			

Constraints

C1: Starting Date and Duration cannot both be NULL.

11.6.2.10 START-END METHOD

[
Starting Date Clause	: STARTING OR ENDING DATE CLAUSE	11.6.2.11	
	NULL		
Ending Date Clause	: STARTING OR ENDING DATE CLAUSE	11.6.2.11	
	NULL		
]			

Constraints

C1: Starting Date and Ending Date cannot both be NULL.

11.6.2.11 STARTING OR ENDING DATE CLAUSE

[
Open Parenthesis	: '('		
Starting Or Ending Date	: STARTING DATE	11.6.2.12	
Close Parenthesis	: ')'		
]			

Comments:

K1: Note that both, starting dates and ending dates are meant to be covered by the STARTING DATE data type and any sub-structures simply referring to START, or STARTING.

11.6.2.12 STARTING DATE

[
Year	: YEAR TAG	11.6.2.13	
	NULL		
Sub-year	: SUB YEAR STARTING DATE	11.6.2.14	
	NULL		
Time	: TIME START DATE	11.6.2.22	
	NULL		
Fuzzy Start Date Sequence	: [FUZZY START DATE]+	11.6.2.28	
	NULL		
]			

Constraints

C1: The elements cannot all be NULL.

11.6.2.13 YEAR TAG

[
Year Designator Code	:	'y'	
Year	:	YEAR CODE	11.6.3.5
]			

Constraints

C1: The fields in this type are concatenated.

11.6.2.14 SUB YEAR STARTING DATE

[
Sub-year Date	:	MONTH IN YEAR START DATE	11.6.2.15
		WEEK IN YEAR START DATE	11.6.2.26
]			

11.6.2.15 MONTH IN YEAR START DATE

[
Month in Year	:	MONTH IN YEAR TAG	11.6.2.16
		NULL	
Day	:	DAY START DATE	11.6.2.17
		NULL	
]			

Constraints

C1: The elements cannot all be NULL.

11.6.2.16 MONTH IN YEAR TAG

[
Month in Year Designator Code	:	'M'	
Month in Year	:	(1..12)	
]			

Constraints

C1: The fields in this type are concatenated.

11.6.2.17 DAY START DATE

[
Day	:	DAY IN MONTH TAG	11.6.2.18
		[DAY IN WEEK TAG]+	11.6.2.19
		FORWARD DAY IN WEEK IN MONTH TAG	11.6.2.20
		REVERSE DAY IN WEEK IN MONTH TAG	11.6.2.21
]			

Constraints

C1: No blank space between the literals and the numbers following them.

11.6.2.18 DAY IN MONTH TAG

```
[
Minus Sign                : '-'
                          | NULL
Day in Month Designator Code : 'd'
Day in Month              : (1..31)
]
```

Constraints

C1: The fields in this type are concatenated.

11.6.2.19 DAY IN WEEK TAG

```
[
Day in Week Designator Code : 't'
Day in Week                 : DAY IN WEEK EXTENDED    11.6.2.30
]
```

Constraints

C1: The fields in this type are concatenated.

11.6.2.20 FORWARD DAY IN WEEK IN MONTH TAG

```
[
Forward Day in Week in Month Designator Code : 'f'
Week in Month                               : (1..5)
Day in Week                                 : DAY IN WEEK    11.6.2.29
]
```

Constraints

C1: The fields in this type are concatenated.

11.6.2.21 REVERSE DAY IN WEEK IN MONTH TAG

```
[
Reverse Day in Week in Month Designator Code : 'r'
Week in Month                               : (1..5)
Day in Week                                 : DAY IN WEEK    11.6.2.29
]
```

Constraints

C1: The fields in this type are concatenated.

11.6.2.22 TIME START DATE

```
[
Hour in Day                : HOUR IN DAY TAG        11.6.2.23
                          | NULL
Minute in Hour             : MINUTE IN HOUR TAG     11.6.2.24
                          | NULL
Second in Minute           : SECOND IN MINUTE TAG   11.6.2.25
                          | NULL
]
```

Constraints

C1: The fields in this type are concatenated.

11.6.2.23 HOUR IN DAY TAG

```
[  
Minus Sign           : '-'  
                    | NULL  
Hour in Day Designator Code : 'h'  
Hour in Day         : (0..23)  
]
```

Constraints

C1: The fields in this type are concatenated.

11.6.2.24 MINUTE IN HOUR TAG

```
[  
Minus Sign           : '-'  
                    | NULL  
Minute in Hour Designator Code : 'm'  
Minute in Hour      : (0..59)  
]
```

Constraints

C1: The fields in this type are concatenated.

11.6.2.25 SECOND IN MINUTE TAG

```
[  
Minus Sign           : '-'  
                    | NULL  
Second in Minute Designator Code : 's'  
Second in Minute    : (0..59)  
]
```

Constraints

C1: The fields in this type are concatenated.

11.6.2.26 WEEK IN YEAR START DATE

```
[  
Week in Year           : WEEK IN YEAR TAG           11.6.2.27  
                    | NULL  
Day in Week           : DAY IN WEEK TAG           11.6.2.19  
                    | NULL  
]
```

11.6.2.27 WEEK IN YEAR TAG

```
[  
Minus Sign           : '-'  
                    | NULL  
Week in Year Designator Code : 'W'  
Week in Year        : (1..52)  
]
```

Constraints

C1: The fields in this type are concatenated.

11.6.2.28 FUZZY START DATE

```
[
Minus Sign           : '-'
                    | NULL
Fuzzy Designator Code : 'z'
Start Fuzzy Values   : (0..100)
]
```

Constraints

C1: The fields in this type are concatenated.

11.6.2.29 DAY IN WEEK

= (Sunday=1, Monday=2, Tuesday=3, Wednesday=4, Thursday=5, Friday=6, Saturday=7)

11.6.2.30 DAY IN WEEK EXTENDED

= (Sunday=1, Monday=2, Tuesday=3, Wednesday=4, Thursday=5, Friday=6, Saturday=7, Holiday=8)

11.6.2.31 DURATION CLAUSE

```
[
Open Braces         : '{'
Duration            : DURATION           11.6.2.32
Close Braces        : '}'
]
```

11.6.2.32 DURATION

```
[
Number of Years     : YEARS NUMBER TAG   11.6.2.33
                    | NULL
Number of Months    : MONTHS NUMBER TAG  11.6.2.34
                    | NULL
Number of Weeks     : WEEKS NUMBER TAG   11.6.2.35
                    | NULL
Number of Days      : DAYS NUMBER TAG    11.6.2.36
                    | NULL
Number of Hours     : HOURS NUMBER TAG   11.6.2.37
                    | NULL
Number of Minutes   : MINUTES NUMBER TAG  11.6.2.39
                    | NULL
Number of Seconds   : SECONDS NUMBER TAG  11.6.2.39
                    | NULL
Fuzzy Duration Sequence : [FUZZY DURATION]+ 11.6.2.40
                    | NULL
]
```

Constraints

C1: The present fields in this type are concatenated.

C2: The fields in this structure cannot all be absent.

11.6.2.33 YEARS NUMBER TAG

```
[  
Minus Sign           : '-'  
                     | NULL  
Years Number Designator Code : 'y'  
Years                : (0..99)  
]
```

Constraints

C1: The fields in this type are concatenated.

11.6.2.34 MONTHS NUMBER TAG

```
[  
Minus Sign           : '-'  
                     | NULL  
Months Number Designator Code : 'M'  
Months              : (0..99)  
]
```

Constraints

C1: The fields in this type are concatenated.

11.6.2.35 WEEKS NUMBER TAG

```
[  
Minus Sign           : '-'  
                     | NULL  
Weeks Number Designator Code : 'w'  
Weeks                : (0..99)  
]
```

Constraints

C1: The fields in this type are concatenated.

11.6.2.36 DAYS NUMBER TAG

```
[  
Minus Sign           : '-'  
                     | NULL  
Days Number Designator Code : 'd'  
Days                 : (0..99)  
]
```

Constraints

C1: The fields in this type are concatenated.

11.6.2.37 HOURS NUMBER TAG

```
[  
Minus Sign           : '-'  
                     | NULL  
Hours Number Designator Code : 'h'  
Hours                : (0..99)  
]
```

Constraints

C1: The fields in this type are concatenated.

11.6.2.38 MINUTES NUMBER TAG

```
[
Minus Sign                : '-'
                          | NULL
Minutes Number Designator Code : 'm'
Minutes                   : (0..99)
]
```

Constraints

C1: The fields in this type are concatenated.

11.6.2.39 SECONDS NUMBER TAG

```
[
Minus Sign                : '-'
                          | NULL
Seconds Number Designator Code : 's'
Seconds                   : (0..99)
]
```

Constraints

C1: The fields in this type are concatenated.

11.6.2.40 FUZZY DURATION

```
[
Minus Sign                : '-'
                          | NULL
Fuzzy Designator Code    : 'z'
Duration Fuzzy Values    : (50..100)
]
```

Constraints

C1: The fields in this type are concatenated.

11.6.3 Direct Time Expressions Usage

11.6.3.1 Overview

The following time structures are used “directly” by other higher level structures and do not go via the intermediation of an actual Time Record. Both direct usage as well as format of time stamps for usage (as in time stamp format, which is not, strictly speaking, a time expression but rather metadata about how a time stamp shall look like) are described in this ‘direct-usage’ sub-clause.

11.6.3.2 DATE STAMP

```
[
Year                : YEAR CODE                11.6.3.5
Month               : MONTH CODE              11.6.3.6
Day                 : DAY CODE                11.6.3.7
]
```

11.6.3.3 DATE/HOUR STAMP

[
Date	: DATE STAMP		11.6.3.2
Hour	: HOUR CODE		11.6.3.8
]			

11.6.3.4 MONTH/HOUR STAMP

[
Month	: MONTH CODE		11.6.3.6
Day	: DAY CODE		11.6.3.7
Hour	: HOUR CODE		11.6.3.8
]			

11.6.3.5 YEAR CODE

= (1000..9999)

11.6.3.6 MONTH CODE

= ('01', '02', '03', '04', '05', '06', '07', '08', '09', 10..12)

11.6.3.7 DAY CODE

= ('01', '02', '03', '04', '05', '06', '07', '08', '09', 10..31)

11.6.3.8 HOUR CODE

= ('01', '02', '03', '04', '05', '06', '07', '08', '09', 10..23)

11.6.3.9 TIME STAMP FORMAT

[
Day Component	: DAY COMPONENT		11.6.3.10
	NULL		
Month Component	: MONTH COMPONENT		11.6.3.11
	NULL		
Year Component	: YEAR COMPONENT		11.6.3.12
	NULL		
Hour Component	: HOUR COMPONENT		11.6.3.13
	NULL		
Minute Component	: MINUTE COMPONENT		11.6.3.14
	NULL		
Second Component	: SECOND COMPONENT		11.6.3.15
	NULL		
]			

Constraints

C1: At least one of the time components must be different from NULL.

C2: The TIME STAMP FORMAT isn't allowed to end with a Separator

C3: The total length of the TIME STAMP FORMAT must not exceed 20 characters width.

11.6.3.10 DAY COMPONENT

[
Day Placeholder Code Set	: [DAY PLACEHOLDER CODE]+		11.6.3.16
Separator	: ','		
	NULL		
]			

Constraints

C1: The Separator is only used if this component isn't the last one in the TIME STAMP FORMAT.

11.6.3.11 MONTH COMPONENT

```
[
Month Placeholder Code Set      : [MONTH PLACEHOLDER CODE]+  11.6.3.17
Separator                      : ':'
                               | NULL
]
```

Constraints

C1: The Separator is only used if this component isn't the last one in the TIME STAMP FORMAT.

11.6.3.12 YEAR COMPONENT

```
[
Year Placeholder Code          : [YEAR PLACEHOLDER CODE]+  11.6.3.18
Separator                      : ':'
                               | NULL
]
```

Constraints

C1: The Separator is only used if this component isn't the last one in the TIME STAMP FORMAT.

11.6.3.13 HOUR COMPONENT

```
[
Hour Placeholder Code          : [HOUR PLACEHOLDER CODE]+  11.6.3.19
Separator                      : ':'
                               | NULL
]
```

Constraints

C1: The Separator is only used if this component isn't the last one in the TIME STAMP FORMAT.

11.6.3.14 MINUTE COMPONENT

```
[
Minute Placeholder Code        : [MINUTE PLACEHOLDER CODE]+  11.6.3.20
Separator                      : ':'
                               | NULL
]
```

Constraints

C1: The Separator is only used if this component isn't the last one in the TIME STAMP FORMAT.

11.6.3.15 SECOND COMPONENT

```
[
Second Placeholder Code        : [SECOND PLACEHOLDER CODE]+  11.6.3.21
]
```

11.6.3.16 DAY PLACEHOLDER CODE

= 'd'

11.6.3.17 MONTH PLACEHOLDER CODE

= 'M'

11.6.3.18 YEAR PLACEHOLDER CODE

= 'y'

11.6.3.19 HOUR PLACEHOLDER CODE

= 'h'

11.6.3.20 MINUTE PLACEHOLDER CODE

= 'm'

11.6.3.21 SECOND PLACEHOLDER CODE

= 's'

11.7 Update Information

11.7.1 Overview

The Update Information Records are used to register changes in a particularly published GDF Album vis-à-vis former such publishing.

11.7.2 UPDATE INFORMATION

[
Update Information	:	GEO TOPO UPDATE INFORMATION	11.7.3
		OBJECT UPDATE INFORMATION	11.7.4
		ATTRIBUTE UPDATE INFORMATION	11.7.5
]			

Constraints

C1: UPDATE ID must be unique within the applicable scope.

Comments:

K1: Corresponds to 12.8.1 UPDATE INFORMATION in MRS

11.7.3 GEO TOPO UPDATE INFORMATION

[
Update Identifier	:	UPDATE GEO TOPO ID	11.8.7.26
Product Cycle	:	(0..99)	
		NULL	
Geo Topo Category	:	GEO TOPO CATEGORY	11.7.6.2
Geo Topo Object Identifier	:	ANY GEOMETRICAL ID	11.8.7.6
Action Class	:	ACTION CLASS	11.7.6.4
Action Time Stamp	:	STRING	11.5.4.7.4
]			

Constraints

C1: The Geo Topo Category and Geo Topo Object Identifier must form a unique composite “key” in the Dataset.

C2: ELEMENT(any geo id) has to exist.

11.7.4 OBJECT UPDATE INFORMATION

[
Update Identifier	UPDATE OBJECT ID		11.8.7.27
Product Cycle	: (0..99)		
	NULL		
Object Category	: OBJECT CATEGORY		11.7.6.3
Object Record Identifier	ANY OBJECT ID		11.8.7.7
Object Code	: ANY FEATURE CLASS CODE		11.3.6.10
	SPECIAL OBJECT CODE		11.7.6.5
Action Class	: ACTION CLASS		11.7.6.4
Action Time Stamp	: STRING		11.5.4.7.4
]			

Constraints

C1: ELEMENT(any obj id) has to exist.

C2: ELEMENT(Feature Class Code) has to actually exist.

11.7.5 ATTRIBUTE UPDATE INFORMATION

[
Update Identifier	UPDATE ATTRIBUTE ID		11.8.7.28
Product Cycle	: (0..99)		
	NULL		
Object Category	: OBJECT CATEGORY		11.7.6.3
Object Record Identifier	ANY OBJECT ID		11.8.7.7
Object Code	: ANY FEATURE CLASS CODE		11.3.6.10
	SPECIAL OBJECT CODE		11.7.6.5
Action Class	: ACTION CLASS		11.7.6.4
Action Time Stamp	: STRING		11.5.4.7.4
Attribute Update Sequence	: [ATTRIBUTE]+		11.5.4.6.3
]			

Constraints

C1: All constraints that apply to each of the original Attributes apply to the updated Attributes.

Comments:

K1: For Attribute Update Sequence, order matters.

11.7.6 Basic Data Types used by Update Information

11.7.6.1 Overview

Simple and compound types used by Update Information Records

11.7.6.2 GEO TOPO CATEGORY

= (Node=1, Edge=2, Face=3, Dot=4, Polyline=5, Polygon=6, Coordinate tuple=7)

11.7.6.3 OBJECT CATEGORY

= (Point Feature=1, Line Feature=2, Area Feature=3, Complex Feature=4, Relationship=5, Name=6, Time Domain=7, Other Text=8, Geopolitical Structure=9, Geopolitical Structure Component=10)

11.7.6.4 ACTION CLASS

= (Update of source only=0, New=1, Delete=2, Modify=3)

11.7.6.5 SPECIAL OBJECT CODE

= (Relationship='0001', Name='0002', Time Domain='0003', Other Text='0004', Geopolitical Structure='0005', Geopolitical Structure Component='0006')

11.8 Common Data Types

11.8.1 Overview

Data Types which are used in more than one particular sub-clause are better defined here.

11.8.2 Pre-defined code lists and value lists

11.8.2.1 ATTRIBUTE TYPE CODE

= A value from the set of Attribute Type Codes.

See Attribute Catalogue Annex A.2 for a list of Attribute Type Codes.

11.8.2.2 ATTRIBUTE TYPE NAME

= A value from the set of Attribute Type Names.

See Attribute Catalogue Annex A.2 for a list of Attribute Type Codes.

The Attribute Type Codes and the Attribute Type Names “travel” in pairs. They shouldn't be assigned out of such order.

11.8.2.3 ATTRIBUTE VALUE CODE

= A value from the set of sets of Attribute Value Codes. There are actually many code lists that this value may come from. They are {list them all} with individual x-reference.

See Annex A.1. {times n.}

11.8.2.4 FEATURE CLASS CODE

= A value from the set of Feature Class Codes, in the range of (1000..8099)

See Annex A.1 for a list of Feature Class Codes

11.8.2.5 FEATURE CLASS NAME

= A value from the set of Feature Class Names.

See Annex A.1 for a list of Feature Class Names

11.8.2.6 FEATURE THEME CODE

= A value from the set of Feature Theme Codes.

See Annex A.1 for a list of Feature Theme Codes

11.8.2.7 FEATURE THEME NAME

= A value from the set of Feature Theme Names.

See Annex A.1 for a list of Feature Theme Names

11.8.2.8 RELATIONSHIP TYPE CODE

= A value from the set of Relationship Type Codes, in the range of (1000..8999).

See Relationship Catalogue Annex A.3.1 for a list of Relationship Type Codes.

11.8.2.9 RELATIONSHIP TYPE NAME

= A value from the set of Relationship Type name.

See Relationship Catalogue Annex A.3.1 for a list of Relationship Type names.

11.8.3 Geodeticals

11.8.3.1 DATUM CODE

= A code value from the Horizontal Datum List

See Metadata Catalogue Annex B.3 for a list of Horizontal Datums

11.8.3.2 DATUM NAME

= A name value from the Horizontal Datum List

See Metadata Catalogue Annex B.3 for a list of Horizontal Datums

11.8.3.3 ELLIPSOID CODE

= A value from the list of ellipsoid codes

See Annex B.3 for a list of ellipsoid codes

11.8.3.4 GRID CODE

= A code from the list of National Grid codes

See Annex B.3 for a list of National Grids in use.

11.8.3.5 GRID NAME

= A name from the list of National Grids

See Annex B.3 for a list of National Grids in use.

11.8.3.6 HEIGHT LEVEL CODE

= A code from the list of Vertical Datum codes

See Annex B.3 for a list of Vertical Datums in use.

11.8.3.7 HEIGHT LEVEL NAME

= A name from the list of Vertical Datums

See Annex B.3 for a list of Vertical Datums in use.

11.8.3.8 PROJECTION TYPE CODE

= A value from the list of Projection Codes

See Annex B.3 for a list of Projection Codes

11.8.4 Units & measures

11.8.4.1 DATA TYPE CODE

= ('G', 'A', 'N', 'AN', 'I', 'L')

See the Metadata Catalogue for a more detailed description (see 10.3.2.4).

11.8.4.2 ATTRIBUTE DATA TYPE

= (Code list=**COD**, Enumeration=**ENM**, Number=**CNT**, Boolean=**BOL**, Bitmask Register=**BMR**, Bitmask Integer=**BMI**, Time Domain=**TMR**, Simple Character String=**SCS**, Language Coded Text=**TXT**, Percentage=**PRC**, Composite=**CMP**, Identifier=**IDN**, Geopolitical Structure Definition=**GSD**, Signed Percentage=**PRS**, Measure=**MSR**)

See the Metadata Catalogue for a list of assigned Data Unit Codes and further descriptions (see 10.3.2.6).

11.8.4.3 DATA UNIT TYPE

= (Degree=**DEG**, Meters=**MTR**, Kilometers=**KMR**, Inch=**INC**, Feet=**FET**, Mile=**MIL**, Kilogram=**KGR**, US Pound=**PND**, Kilo Pound=**KIP**, Metric Ton=**TON**, Minute of Time=**MIN**, Kilometer Per Hour=**KPH**, Miles Per Hour=**MPH**)

11.8.5 Coordinates

11.8.5.1 COORDINATE RECORD

[
Coordinate Identifier	: COORDINATE ID		11.8.7.13
Source	: SOURCE ID		11.8.7.30
	NULL		
Coordinate Sequence	: [COORDINATE TUPLE]+		11.8.5.2
Node BP Set	: [NODE ID]+		11.8.7.14
	NULL		
Edge BP Set	: [EDGE ID]+		11.8.7.15
	NULL		
]			

Constraints:

C1: The Coordinate Identifier is the unique key in some Section.

C2: Only one Coordinate Tuple should appear if the Coordinate Record is referenced from a Node or an explicit topology Point Feature.

C3: The order of the Coordinate Sequence is significant and is to be maintained.

11.8.5.2 COORDINATE TUPLE

[
Coordinate	:	COORDINATE TRIPLET	11.8.5.3
		COORDINATE PAIR	11.8.5.4
]			

11.8.5.3 COORDINATE TRIPLET

[
Coordinate Pair	:	COORDINATE PAIR	11.8.5.4
Third Coordinate	:	COORDINATE VALUE	11.8.5.7
		NULL	
]			

11.8.5.4 COORDINATE PAIR

[
First Coordinate	:	COORDINATE VALUE	11.8.5.7
Second Coordinate	:	COORDINATE VALUE	11.8.5.7
]			

11.8.5.5 OPTIONAL COORDINATE PAIR

[
First Coordinate	:	COORDINATE VALUE	11.8.5.7
		NULL	
Second Coordinate	:	COORDINATE VALUE	11.8.5.7
		NULL	
]			

Constraints:

C1: Cannot both be NULL.

11.8.5.6 TEMPORAL COORDINATE TUPLE

[
Start Appearance	:	TEMPORAL COORDINATE VALUE	11.8.5.8
End Appearance	:	TEMPORAL COORDINATE VALUE	11.8.5.8
Start Disappearance	:	TEMPORAL COORDINATE VALUE	11.8.5.8
End Disappearance	:	TEMPORAL COORDINATE VALUE	11.8.5.8
]			

11.8.5.7 COORDINATE VALUE

= (-9999999999..9999999999)

11.8.5.8 TEMPORAL COORDINATE VALUE

= (1000010100..9999123123)

11.8.6 Geographics

11.8.6.1 PLACE

[
Country	: ISO COUNTRY CODE		11.8.6.2
	NULL		
Place Name	: STRING		11.5.4.7.4
	NULL		
]			

Constraints:

C1: In a Place, both can't be NULL.

11.8.6.2 ISO COUNTRY CODE

= A value from the set of ISO 3166 Alpha-3 Country Codes

See Annex B.2 for a list of ISO Country Codes

11.8.7 Identifier types

11.8.7.1 ANY FEATURE

[
Dataset Identifier	: DATASET ID		11.8.7.10
	NULL		
Layer Identifier	: LAYER ID		11.8.7.11
	NULL		
Section Identifier	: SECTION ID		11.8.7.12
	NULL		
Feature Category	: FEATURE CATEGORY		11.8.7.8
Feature Identifier	: ANY FEATURE ID		11.8.7.5
]			

Constraints

C1: All items in the ANY FEATURE structure must exist and they must form together a scope which exists in the actual data representation.

C2: When an ANY FEATURE is referenced from a CONVERSION (11.5.4.8.2), the Dataset, Layer, *and* Section Identifiers must all be specified.

C3: When an ANY FEATURE is referenced from a COMPOSING FEATURE, PARTNER, or a CONVERSION, then only those <DLS> required to reference this Feature from the scope of the <caller,user> record must be specified. The others are optional.

11.8.7.2 ANY FEATURE IN DATASET

[
Layer Identifier	: LAYER ID		11.8.7.11
	NULL		
Section Identifier	: SECTION ID		11.8.7.12
	NULL		
Feature Category	: FEATURE CATEGORY		11.8.7.8
Feature Identifier	: ANY FEATURE ID		11.8.7.5
]			

Comments

K1: Same as above, but without Dataset Identifier and without Feature Category.

K2: A Feature ID sufficiently scoped to Section, and Layer as necessary to make it accessible across Sections or Layers from the <calling/accessing> Feature.

11.8.7.3 TEXT RECORD IN DATASET

[
Layer Identifier	: LAYER ID		11.8.7.11
	NULL		
Section Identifier	: SECTION ID		11.8.7.12
	NULL		
Text Identifier	: TEXT ID		11.8.7.23
]			

Comments

K1: Same as above, but instead of Feature a Text Record reference.

11.8.7.4 RELATIONSHIP IN DATASET

[
Layer Identifier	: LAYER ID		11.8.7.11
	NULL		
Section Identifier	: SECTION ID		11.8.7.12
	NULL		
Relationship Identifier	: RELATIONSHIP ID		11.8.7.22
]			

Comments

K1: Same as above, but instead of Text Record a Relationship reference.

11.8.7.5 ANY FEATURE ID

[
Any Feature Identifier	: POINT FEATURE ID		11.8.7.17
	LINE FEATURE ID		11.8.7.18
	AREA FEATURE ID		11.8.7.19
	COMPLEX FEATURE ID		11.8.7.20
]			

11.8.7.6 ANY GEOMETRICAL ID

[
Any Geo Identifier	: NODE ID		11.8.7.14
	EDGE ID		11.8.7.15
	FACE ID		11.8.7.16
	COORDINATE ID		11.8.7.13
]			

11.8.7.7 ANY OBJECT ID

[
Any Object Identifier	: ANY FEATURE ID		11.8.7.5
	RELATIONSHIP ID		11.8.7.22
	TEXT ID		11.8.7.23
	TIME ID		11.8.7.24
	GPL STR ID		11.8.7.41
	GPL STR CMP ID		11.8.7.39
]			

11.8.7.8 FEATURE CATEGORY

= (Point=1, Line=2, Area=3, Complex=4)

11.8.7.9 ALBUM ID

= RECORD ID 11.8.7.43

11.8.7.10 DATASET ID

= RECORD ID 11.8.7.43

11.8.7.11 LAYER ID

= RECORD ID 11.8.7.43

11.8.7.12 SECTION ID

= RECORD ID 11.8.7.43

11.8.7.13 COORDINATE ID

= RECORD ID 11.8.7.43

11.8.7.14 NODE ID

= RECORD ID 11.8.7.43

11.8.7.15 EDGE ID

= RECORD ID 11.8.7.43

11.8.7.16 FACE ID

= RECORD ID 11.8.7.43

11.8.7.17 POINT FEATURE ID

= RECORD ID 11.8.7.43

11.8.7.18 LINE FEATURE ID

= RECORD ID 11.8.7.43

11.8.7.19 AREA FEATURE ID

= RECORD ID 11.8.7.43

11.8.7.20 COMPLEX FEATURE ID

= RECORD ID 11.8.7.43

11.8.7.21 ATTRIBUTE ID

= RECORD ID 11.8.7.43

11.8.7.22 RELATIONSHIP ID

= RECORD ID 11.8.7.43

11.8.7.23 TEXT ID

= RECORD ID 11.8.7.43

11.8.7.24 TIME ID

= RECORD ID 11.8.7.43

11.8.7.25 CONVERSION ID

= RECORD ID 11.8.7.43

11.8.7.26 UPDATE GEO TOPO ID		
	= RECORD ID	11.8.7.43
11.8.7.27 UPDATE OBJECT ID		
	= RECORD ID	11.8.7.43
11.8.7.28 UPDATE ATTRIBUTE ID		
	= RECORD ID	11.8.7.43
11.8.7.29 OBJECT REF ID		
	= RECORD ID	11.8.7.43
11.8.7.30 SOURCE ID		
	= RECORD ID	11.8.7.43
11.8.7.31 HORIZONTAL DATUM ID		
	= RECORD ID	11.8.7.43
11.8.7.32 VERTICAL DATUM ID		
	= RECORD ID	11.8.7.43
11.8.7.33 PROJECTION ID		
	= RECORD ID	11.8.7.43
11.8.7.34 NATIONAL GRID ID		
	= RECORD ID	11.8.7.43
11.8.7.35 GEOID UNDULATION ID		
	= RECORD ID	11.8.7.43
11.8.7.36 MAGNETIC FIELD DECLINATION ID		
	= RECORD ID	11.8.7.43
11.8.7.37 SPATDOM ID		
	= RECORD ID	11.8.7.43
11.8.7.38 DIRECTORY ID		
	= RECORD ID	11.8.7.43
11.8.7.39 GPL STR CMP ID		
	= 6 DIGIT RECORD ID	11.8.7.44
11.8.7.40 NETWORK ID		
	= 5 DIGIT RECORD ID	11.8.7.45
11.8.7.41 GPL STR ID		
	= 4 DIGIT RECORD ID	11.8.7.46
11.8.7.42 CHARACTER SET ID		
	= 2 DIGIT RECORD ID	11.8.7.47
11.8.7.43 RECORD ID		
	= (1..9999999999)	

11.8.7.44 6 DIGIT RECORD ID

= (1..999999)

11.8.7.45 5 DIGIT RECORD ID

= (1..99999)

11.8.7.46 4 DIGIT RECORD ID

= (1..9999)

11.8.7.47 2 DIGIT RECORD ID

= (1..99)

11.8.8 Basic types

11.8.8.1 Boolean

= (0..1)

12 Media Record Specifications

12.1 General specifications

12.1.1 Introduction

This sub-clause explains basic concepts of the exchange format specifications using Media Records.

12.1.2 Partitioning

12.1.2.1 General

Each GDF is split up into subparts in order to keep the Dataset manageable. This is called partitioning. A GDF is partitioned into Information Units and Medium Units.

12.1.2.2 Information units

Information Units are the generally applicable scheme for partitioning GDF, independent from a particular physical format, and describe the partitioning characteristics of the data which as a whole is equivalent to the Album. There are three levels of partitioning into information units: the Dataset, the Layer, and the Section.

See the Metadata Catalogue for detailed specifications (clause 10.1.3)

12.1.2.3 Medium units

The physical medium upon which the GDF is stored.

12.1.2.3.1 Volume

The smallest physical unit of medium.

EXAMPLE A floppy disk, a CD-ROM, or a DVD.

A single Volume may contain one, more than one, or a part of a Dataset depending on Dataset size. The collection of related Volumes physically constitute the Album.

A Volume is terminated by a Volume Terminator.

12.1.2.3.2 Volume Header

The Album Header is supplemented with Volume related characteristics. Furthermore, it specifies the links to the Dataset(s) associated with the Volume in issue.

12.1.3 Logical Record

A group of sequential data Fields which belong together and which can be considered as a logical unit. A logical record has no fixed length. It may contain one or more media records. The start and end of a logical record is governed by the record type code and the Continuation Mark.

12.1.4 Media Record

The name of a group of sequential data Fields which belong together.

All characters controlling the behaviour of Media Records utilize a single-byte character set (as per the default character set defined in the Album Header; see 10.2.2.9).

A GDF media record has a length of 81 or 82 characters, depending on whether one or two control characters are used to terminate the record.

Each media record starts with a record type code and ends with a Carriage Return character (CR), a Line Feed (LF) or a combination of these two control characters, as agreed by the data supplier and the customer.

(In terms of ISO/IEC 8859-1, the character code for <CR> and <LF> characters is 0/13 and 0/10, respectively).

12.1.5 Continuation Record

A media record that is used for the representation of that part of a particular logical record which exceeds 80 characters. A continuation record has two Zero characters in the Field which is used for the record type code.

12.1.6 Null Record

Media records which can be used to fill a block. The first two positions of this record (reserved for the record type code) shall contain two Space characters (code 2/0).

12.1.7 Fields of variable and fixed length

Most of the data Fields will have a pre-specified fixed length. Only text Fields may have a variable length. The actual Field length for a given text content is determined by the last position that is only followed by trailing space characters (code 2/0).

The Field size of all fixed-length Fields is specified as the number of characters. A Field size of " * " is used in the documentation to indicate a field of variable length. The size of Field size itself in the field definition record (12.6.3) is an integer of size 2. In this case, the value of " 0 " is used to indicate a field of variable size, but the printed layout in this standard will actually contain "*" .

A fixed length Field should not be split. When a particular Field does not fit in media record X, this Field has to be moved to the next media record (which is then, by definition, a Continuation Record, see 12.1.4). Conversely, a variable length Field may be split across more than one media record when the actual text content exceeds the number of positions present in the (remainder of the) media record.

12.1.8 Repeating Fields

A repeating Field is a Field that may have more than one successive instance in a particular record.

The number of occurrences of a repeating Field in the record is variable.

Each repeating Field is preceded by a Field Counter which specifies how many times the subsequent Field repeats within the logical record in issue.

In the specification of the format of the individual record types (sub-clauses 12.6, 12.7, 12.8), a repeating Field is indicated by means of a vertical line (|) preceding the Field.

12.1.9 Repeating Field Groups

A sequence of two or more Fields which may repeat, together with the other Fields belonging to that group.

A repeating group is also preceded by a Field Counter. This counter belongs to the group as a whole. It specifies how many times the repeating group repeats within the logical record in issue.

In the specification of the format of the record (sub-clauses 12.6, 12.7, 12.8), the presence of a repeating Field group is indicated by means of a vertical line (|) preceding the repeating Fields.

12.1.10 Nesting Of Repeating Fields

Within a repeating field group, one or more sub-sets of Fields may again be repeated, i.e. nested within another repeating field group. Each sub-set, either a single Field or a sequence of two or more Fields, shall be preceded by a field counter as specified above, which itself is embedded in the lower-level repeating field group.

Up to 9 nesting levels may be defined.

In the specification of the format of the record (sub-clauses 12.6, 12.7, 12.8), the presence of multiple repeat levels is indicated by means of multiple vertical lines (|) preceding the repeating Fields. The number of vertical lines corresponds to the number of nesting levels.

12.1.11 Packing

Any character positions unused between the last complete Field and position 80 have to be packed with Space characters (code 2/0). The Continuation Mark and the agreed control character(s) are then written.

12.1.12 Data Types

The characters that can be contained in a Field are of different data types. The constraints for the individual Fields regarding the data type of the characters they can contain is specified in the Record Specification (see sub-clauses 12.6, 12.7, 12.8). Data type definitions are specified in the Metadata Catalogue and are consistent throughout the GDF, with the exception of the data type L, which allows for the use of local character sets not included in the default character set specified for the GDF Album (see sub-clause 12.1.13).

12.1.13 Character sets

This International Standard supports the exclusive use of a single character set for all Fields except for the Fields of data type L. This general default character set is defined in the Album Header Record and can be any of the ISO 8859 variants, or ISO/IEC 10646 Annex D (UNICODE – UTF8).

The data type L contains one-byte or multi-byte characters from a character set defined externally and specified in the Local Character Set Definition Record (ALHDREC.02). Such a character set is referred to as a “Local Character Set”. The use of characters from a Local Character Set, and the use of characters from the default character set of the GDF Album after the use of characters from a Local Character Set is indicated by the presence of characters from the default character set specially defined for this use and referred to as Local-In and Local-Out. This is done in the Local Character Set Definition Record.

The use of the Local-In code supposes that the first character of this code is not used for any other purpose within the default character set used in the GDF. The use of the Local-Out code supposes that the code is not used for any other purpose within the Local Character Set.

As special case is the choice to not specify Local-In and Local-Out; in this case the local character set at hand becomes the default character set for Fields of type L (overruling the general default character set). Only one default character set may be declared; for any other local character set Local In and Local Out Codes must be provided.

12.1.14 Justification

Numeric values (Fields of data type I or N) are right or left justified. Alphanumeric values (Fields of data type A, G, L and AN) are left justified. In Fields of type I or N, unused leading characters will be Space characters.

12.1.15 Order of Records

Figure 144 shows that every Album has to start with a Volume Header Subrecord from the Album Header Record. Each Volume ends with a Volume Termination Record.

The Album Header Record is followed immediately by the Dataset Header Record which is the first of a group of records which are called Dataset records (because they contain general information that applies to the whole Dataset). The group occurs only once in a Dataset. If a Dataset is distributed over more than one Volume, these records appear only in the first Volume.

The occurrence of a Dataset Header Record indicates the beginning of a Dataset. The Dataset ends with the next Dataset Header Record or with a Volume Termination Record with a Volume Termination Mark = 0 (last Volume in an Album).

The order of the Dataset records, apart from the Dataset Header Record, is not essential. However, it is recommended to arrange them in a standardized order, e.g. in the order as proposed in Figure 144.

The Dataset records are immediately followed by a Layer Header Record. Its first appearance means the beginning of the first Layer. The Layer logically ends at the occurrence of another Layer Header Record with a different Layer ID or with the presence of a Volume Termination Record having a Volume Termination Mark = 0 (last Volume of an Album).

If a Layer logically continues on the next Volume, the corresponding Layer Header Record has to be repeated.

The Layer Header Record is followed by a Section Header Record. This record indicates the beginning of a new Section. A Section ends at the occurrence of another Section Header Record.

The last Section of a Layer ends at the occurrence of a Layer Header Record, a Volume Termination Record or a Dataset Header Record.

When Update Information is contained in a GDF, the Section Header Record is followed by one or more Update Information Records, each possibly together with a Text Record or Time Domain Record. These Update Information Record combinations are in their turn followed by the so-called "data records". In case Update Information is not contained, the Section Header Record is directly followed by the "data records". The order of the records within this group is not essential, but it is strongly recommended to arrange them in some standardized and logical way, e.g. as proposed in Figure 144: first all Node Records, next all Edge Records, etc.

12.1.16 Order of subrecords

12.1.16.1 General

Some records are subdivided into a number of subrecords. This concerns the Album Header Record, the Dataset Header Record, the Source Record, and the Section Header Record.

The subrecord instances have to occur in a particular order within the record they belong to. This is specified in the following.

NOTE An asterisk (*) indicates that a record or record group can repeat within one group.

12.1.16.2 Album Header Record

[
Album Header Intro Subrecord
Local Character Set Definition Subrecord*
Global Album Information Subrecord
Volume Header Subrecord*
]

The Global Album Information Sub-Record shall be repeated in each Volume.

12.1.16.3 Dataset Header Record

[
Dataset Identification Subrecord
[

Dataset Main Title Subrecord
Dataset Subtitle Subrecord
]*
Dataset Producer Subrecord*
Dataset Extensiveness & Currency Subrecord
Dataset Contents Subrecord*
Dataset XY Resolution Subrecord
]

12.1.16.4 Source Record

[
Description Info Subrecord
ISBN & Survey Subrecord
Author Name Subrecord
Scale and Title Subrecord*
Volume Name Subrecord*
Edition and Impression Subrecord
Publisher Subrecord*
Distribution Subrecord*
Host Document Subrecord
Field Data Capturing Subrecord
]

12.1.16.5 Section Header Record

[
Section Identification Subrecord
Section Settings Subrecord
Network Identification Subrecord
Datasource Reference Subrecord
Datum & Magnetism Subrecord
Orthometric Reference Subrecord
Section Border Subrecord
XY Control Point Subrecord*
Z Control Point Subrecord*
Update Information Format Subrecord
]

12.1.16.6 Point Feature Record

Depending on the declared topology type for the Layer containing the Point Feature(s) at hand, either of the subrecords shall be applicable.

[

Explicit Point Topology Subrecord

]*

XOR:

[

Non-explicit Point Topology Subrecord

]*

12.1.16.7 Line Feature Record

Depending on the declared topology type for the Layer containing the Line Feature(s) at hand, either of the subrecords shall be applicable.

[

Explicit Line Topology Subrecord

]*

XOR:

Non-explicit Line Topology Subrecord

]*

12.1.16.8 Area Feature Record

Depending on the declared topology type for the Layer containing the Area Feature(s) at hand, either of the subrecords shall be applicable.

[

Full Rendering Area Topology Subrecord

]*

XOR:

[

Connectivity Rendering Area Topology Subrecord

]*

XOR:

[

Non-explicit Area Topology Subrecord

]*

12.1.16.9 Complex Feature Record

Depending on the declared topology type for the Layer containing the Complex Feature(s) at hand, either of the subrecords shall be applicable.

[

Explicit Complex Topology Subrecord

]*

XOR:

[

Non-explicit Complex Topology Subrecord

]*

12.1.16.10 Update Information Record

[

Geo-topo Update information Subrecord

Object Update Information Subrecord

Object Attribute Update Information Subrecord

]

12.1.17 Links between data records

The relations between the entities of the Overall Conceptual Data Model (see Clause 5) have been implemented with some exceptions in the form of pointers between the data records. Each record type has therefore been provided with a Field where a unique identifier for a record occurrence can be stored.

The Coordinate Record identifiers for 2D and 3D coordinates, respectively, share the same ID space and must be unique across all Coordinate Records in a given Section.

Each record type has furthermore one or more Fields in which a reference pointer to another record can be stored. Non-explicit topological Features do not have relations with Nodes, Edges and Faces. In this case there are no Node, Edge or Face records, because the Feature geometry is stored within the Feature records. Pointer arrangement related to Feature records differs according to the type of topology.

Figure 216, Figure 217 and Figure 218 show how these record types are inter-linked for the different topological models. Figure 219 and Figure 220 show the other pointer relations related to Feature records. For simplicity, pointer relations are only shown in one direction. Pointer relations in the reverse direction (optional pointers) are not shown.

Figure 221, Figure 222 and Figure 223 show the pointer Fields and their role in the records. An open dot indicates a Field where the identifier is assigned. A full black dot indicates a Field that is used to refer to another record.

<u>Album Level</u>	<u>Dataset Level</u>	<u>Layer Level</u>	<u>Section Level</u>
Album Header Rc	[Dataset Header Rc Field Definition Rc* Record Definition Rc* Feature Definition Rc* Attribute Definition Rc* Attribute Value Def Rc* Default Attribute Rc* Relationship Definition Rc* Geopol. Structure Def. Rc* Geopol. Struc. Comp. Def. Rc* Spatial Domain Rc* Directory Rc* Abbreviation Rc* Network Specification Rc* Source Rc* Datum & Ellipsoid Rc* Vertical Datum Rc* Projection Rc* National Grid Rc* Geoid Undulation Rc* Earth Magn. Field Rc* Update Info Rc* Relationship Rc* Attribute Rc* Text Rc* Time Domain Rc* Object Reference Rc*	[Layer Header Rc Update Info Rc* Relationship Rc* Attribute Rc* Text Rc* Time Domain Rc* Object Reference Rc*	[Section Header Rc Update Info Rc* 2D Coordinate Rc* 3D Coordinate Rc* Node Rc* Edge Rc* Face Rc* Point Feature Rc* Line Feature Rc* Area Feature Rc* Complex Feature Rc* Conversion Rc* Attribute Rc* Relationship Rc* Text Rc* Time Domain Rc* Object Reference Rc*]*
]*]*	

NOTE 1 An asterisk (*) indicates that a record can repeat within one group. "Rc" means "Record"

NOTE 2 A special case are Comments Rc* and Volume Termination Rc, which can occur in-between any 2 records. Regardless of the above, Volume Termination Rc has to occur as the last record of an Album.

Figure 215 — Order of Records

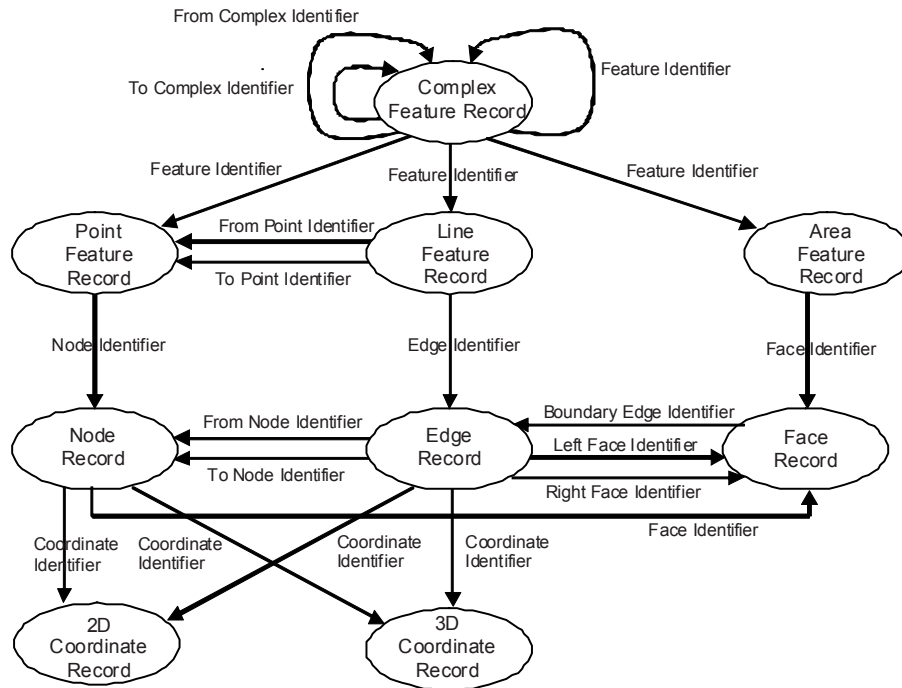

Figure 216 — Pointer relations among feature and topological primitive records in the full integration rendering model of planar topology (the reverse direction for each pointer relation is not shown)

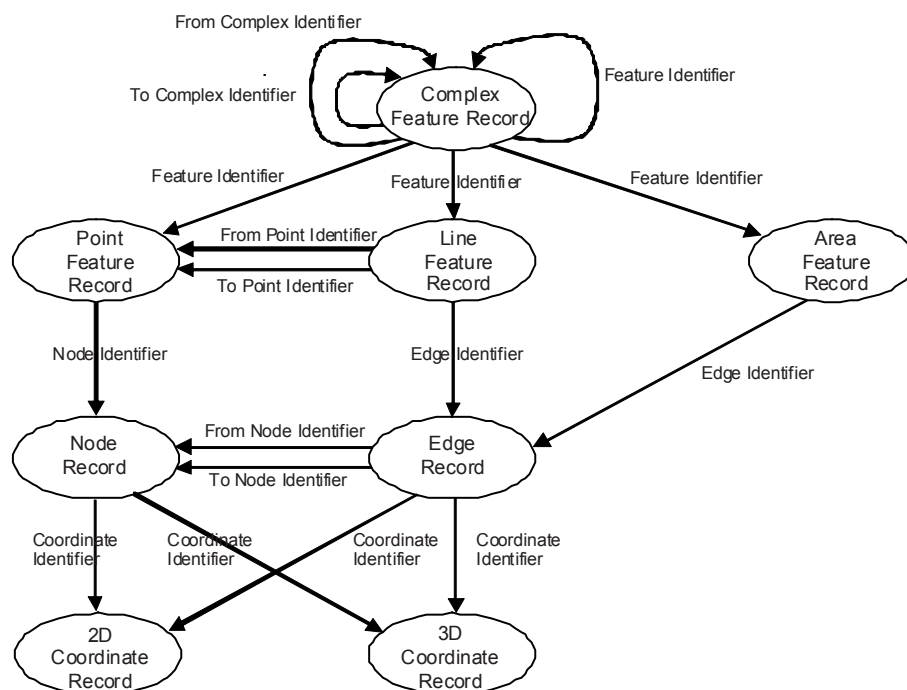

Figure 217 — Pointer relations among feature and topological primitive records in the connectivity rendering model of non-planar topology (the reverse direction for each pointer relation is not shown)

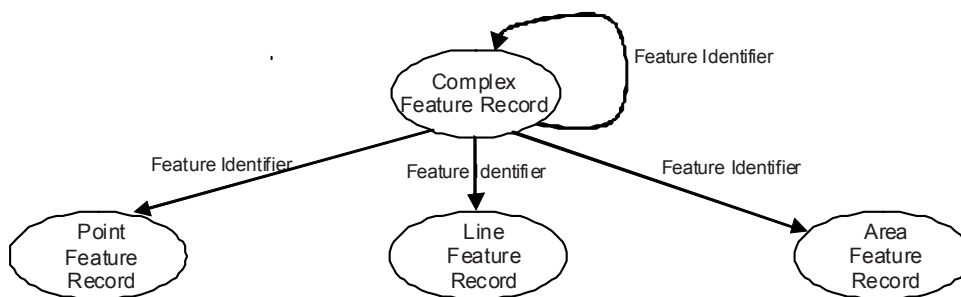

Figure 218 — Pointer relations among features in the non-explicit topology model (the reverse direction for each pointer relation is not shown)

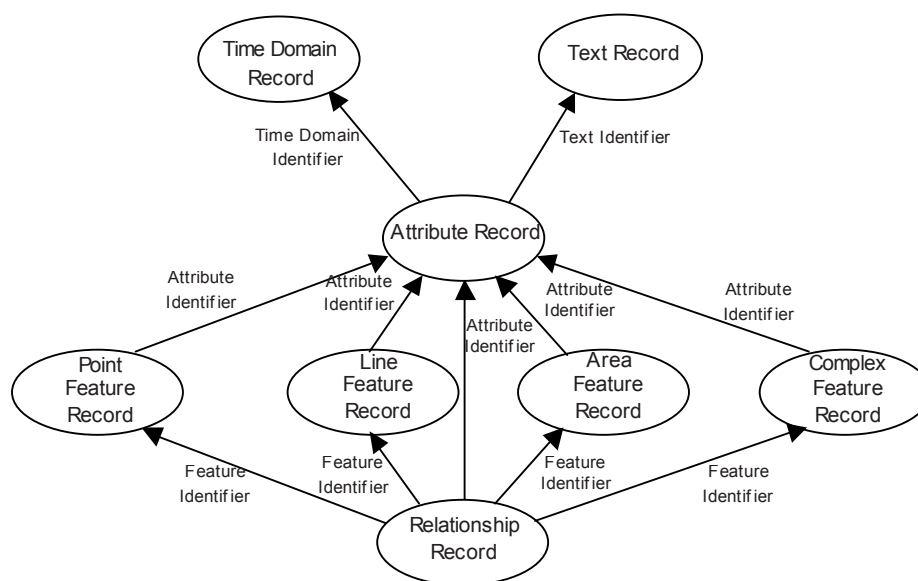
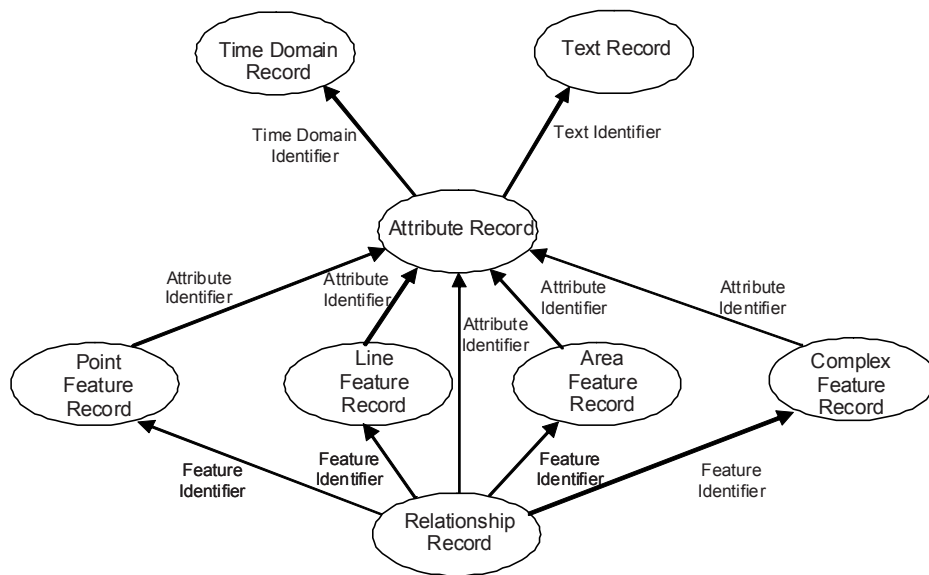

Figure 219 — Other pointer relations between data records (topological features) (the reverse direction for each pointer relation is not shown)



**Figure 220 — Other pointer relations between data records (non-explicit topological features)
(the reverse direction for each pointer relation is not shown)**

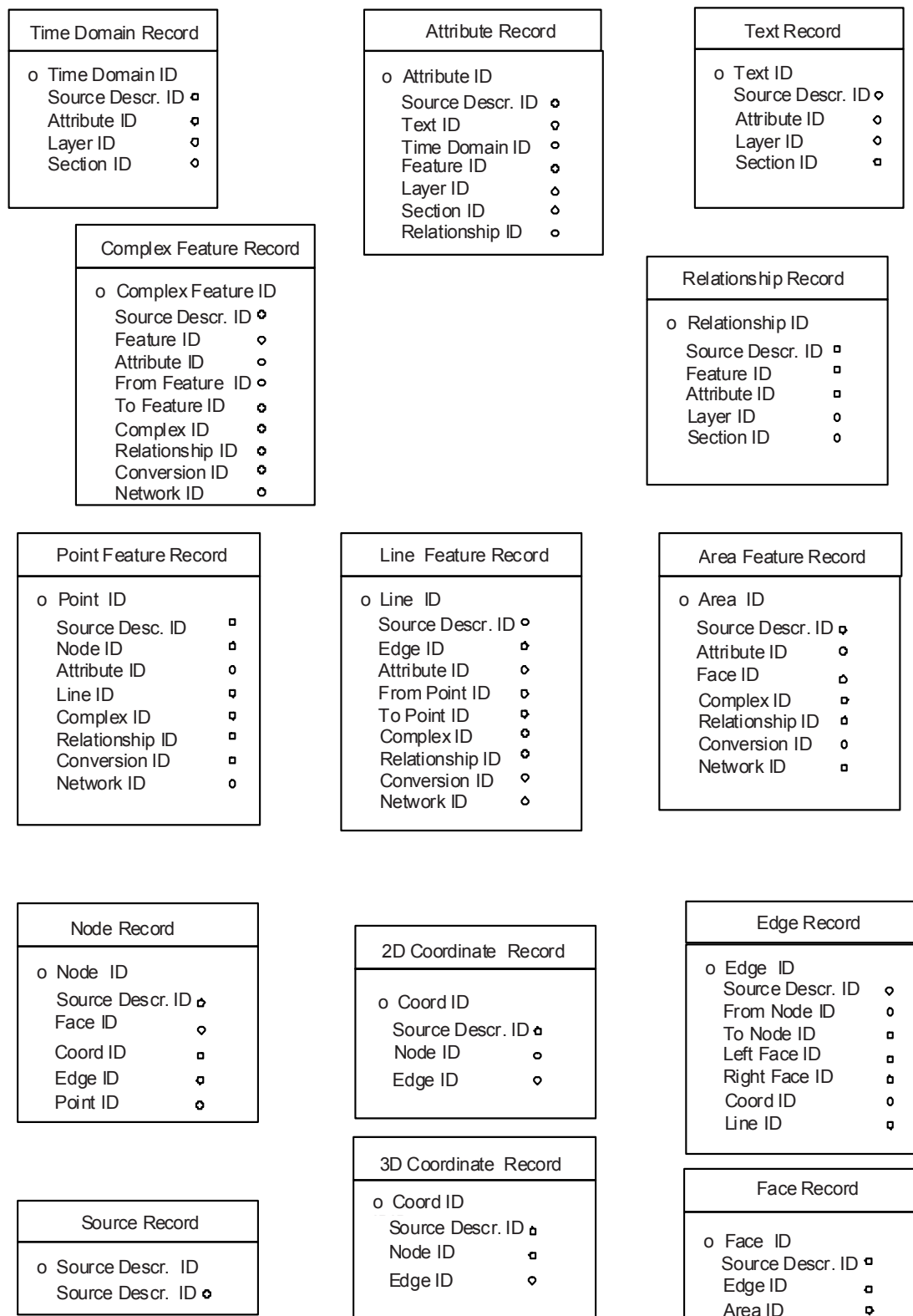

Figure 221 — Pointer fields and their role in the records (full integration rendering of planar topology)

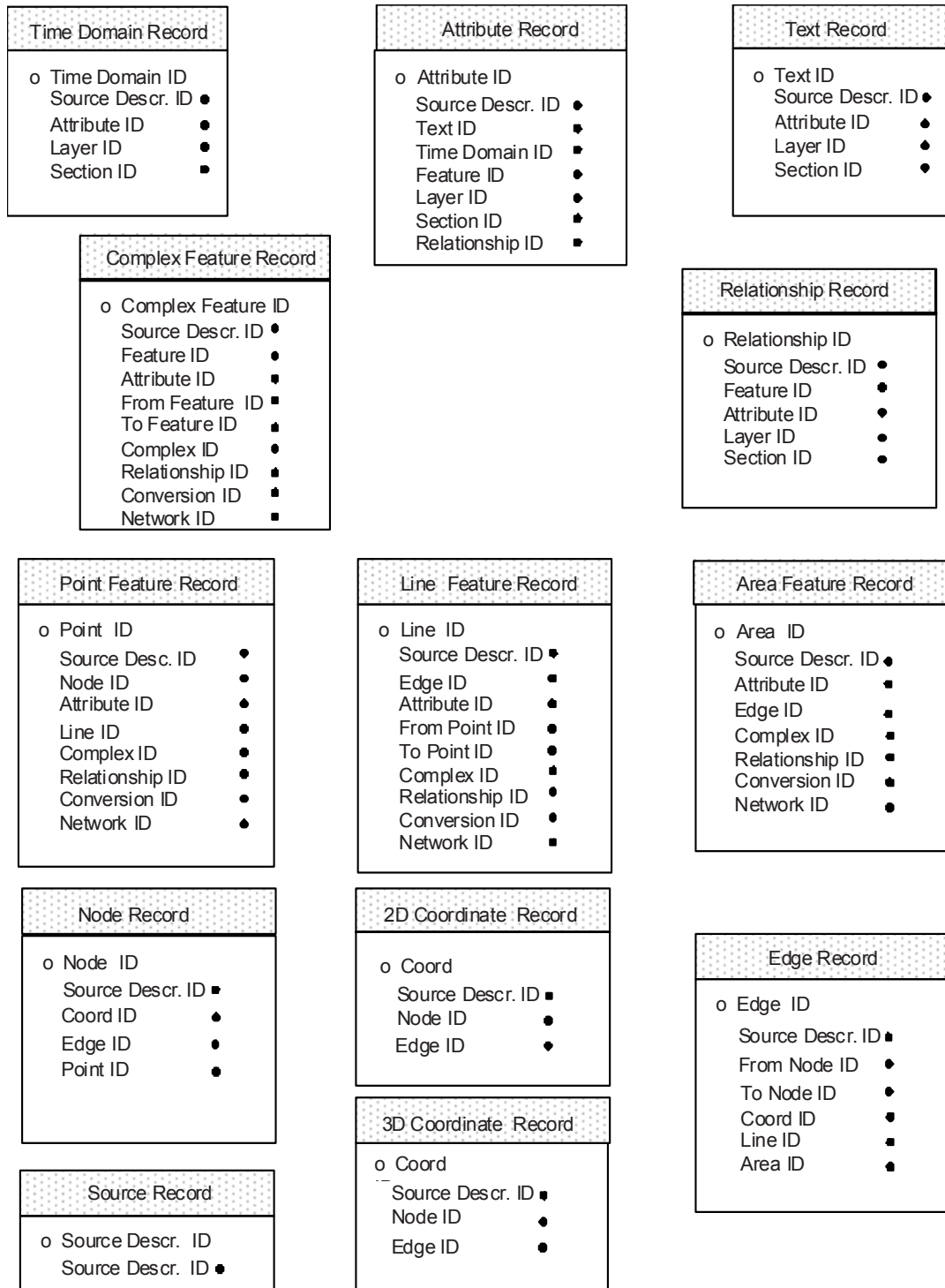

Figure 222 — Pointer fields and their role in the records (connectivity rendering of non-planar topology)

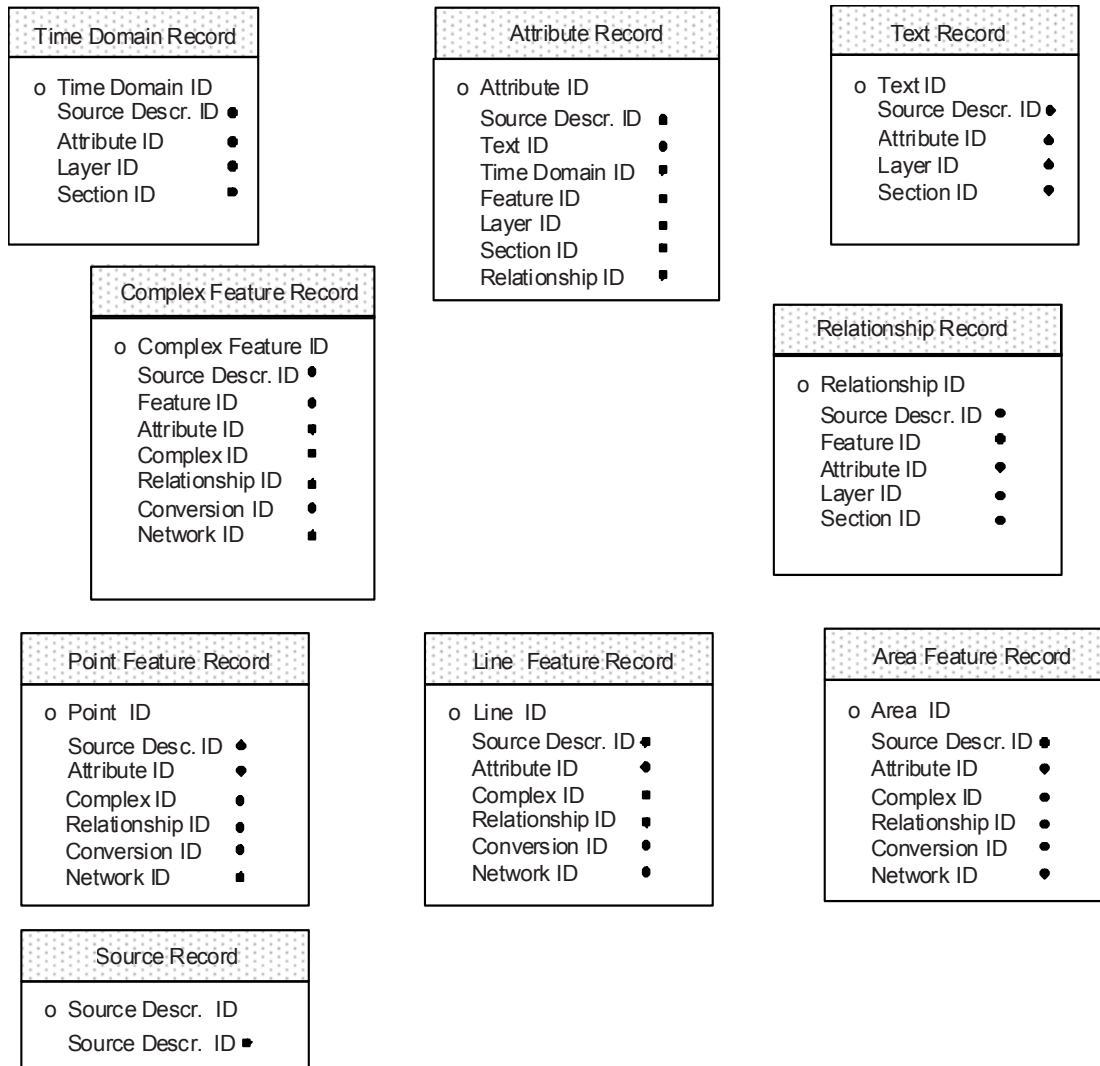

Figure 223 — Pointer fields and their role in the records (non-explicit topology)

12.2 Field specifications

12.2.1 Field Name

The Field Name is an identifier of a Field which is unique within the Field definitions of GDF.

12.2.2 Record Control Fields

12.2.2.1 General

Some fields are used for record control. These include the Record Type Code, the Record Subtype Code, the Continuation Mark and the Field Counter. The following sub-clauses describe these Fields which are used for record control.

12.2.2.2 Record Type Code

This is a two-character Field which occurs at the beginning of each logical and media record. It is used to indicate the record type of a particular record, and contains a numeric code.

The following codes have been fixed:

Code	Mnemonic Name	Full Record Name
All-purpose media records		
<SS>	[NULLREC]	Null Record
00	[CONTREC]	Continuation Record

<SS> means two successive Space characters

Global records

01	[ALHDREC]	Album Header Record
02	[DSHDREC]	Dataset Header Record
03	[FIELDEFREC]	Field Definition Record
04	[RECDEFREC]	Record Definition Record
05	[ATDEFREC]	Attribute Definition Record
06	[DIREC]	Directory Record
07	[FEATDEFREC]	Feature Definition Record
08	[SPADOREC]	Spatial Domain Record
09	[RELDEFREC]	Relationship Definition Record
10	[GPLSTRDREC]	Geopolitical Structure Definition Record
11	[GPLCOMDREC]	Geopolitical Structure Component Definition Record
13	[ABBRREC]	Abbreviation Record
14	[SRCEREC]	Source Record
15	[DATTVALREC]	Default Attribute Value Record
16	[SECHREC]	Section Header Record
17	[LAYHREC]	Layer Header Record

18	[ATTVALREC]	Attribute Value Definition Record
19	[NWSPECSREC]	Network Specification Record
61	[DATELREC]	Datum & Ellipsoid Record
62	[VERDATREC]	Vertical Datum Record
63	[PROJECREC]	Projection Record
64	[NATGRIDREC]	National Grid Record
65	[GEOIDREC]	Geoid Undulation Record
66	[MAGNETREC]	Earth Magnetic Field Record
90	[COMMENTREC]	Comment Record
99	[VOLTERMREC]	Volume Termination Record

Data records

22	[XYREC]	2D Coordinate Record
23	[XYZREC]	3D Coordinate Record
24	[EDGEREC]	Edge Record
25	[NODEREC]	Node Record
29	[FACEREC]	Face Record
41	[TEXTREC]	Text Record
44	[ATTREC]	Attribute Record
45	[TIMEREC]	Time Domain Record
46	[CONVERTREC]	Conversion Record
50	[RELATREC]	Relationship Record
51	[POFEREC]	Point Feature Record
52	[LIFEREC]	Line Feature Record
53	[ARFEREC]	Area Feature Record
54	[COFEREC]	Complex Feature Record
83	[OBJREFREC]	Object Reference Record

Update Information records

89	[UPDIREC]	Update Information Record
----	-----------	---------------------------

12.2.2.3 Record Subtype Code

A record type can be subdivided up to a hundred different subtypes by means of a subtype code. This Field has a length of 2 positions and can be filled with numbers ranging from 00 to 99.

The following record subtypes have been defined. This concerns subdivisions of the Album Header Record, the Dataset Header Record, the Source Record, the Section Header Record, the Point Feature Record, the Line Feature Record, the Area Feature Record, the Complex Feature Record and the Update Information Record.

Rec. Code	Subt. Code	Mnemonic Name	Full Record Name
Album Header Record			
01	01	[ALHDREC.01]	Album Header Intro Subrecord
01	02	[ALHDREC.02]	Local Character Set Definition Subrecord
01	03	[ALHDREC.03]	Global Album Information Subrecord
01	04	[ALHDREC.04]	Volume Header Subrecord
Dataset Header Record			
02	01	[DSHDREC.01]	Dataset Identification Subrecord
02	02	[DSHDREC.02]	Dataset Main Title Subrecord
02	03	[DSHDREC.03]	Dataset Subtitle Subrecord
02	04	[DSHDREC.04]	Dataset Producer Subrecord
02	05	[DSHDREC.05]	Dataset Extensiveness & Currency Subrecord
02	06	[DSHDREC.06]	Dataset Contents Subrecord
02	07	[DSHDREC.07]	Dataset XY Resolution Subrecord
Source Record			
14	01	[SRCEREC.01]	Description Info Subrecord
14	02	[SRCEREC.02]	ISBN & Survey Subrecord
14	03	[SRCEREC.03]	Author Name Subrecord
14	04	[SRCEREC.04]	Scale and Title Subrecord
14	05	[SRCEREC.05]	Volume Name Subrecord
14	06	[SRCEREC.06]	Edition & Impression Subrecord
14	07	[SRCEREC.07]	Publisher Subrecord
14	08	[SRCEREC.08]	Distribution Subrecord
14	09	[SRCEREC.09]	Host Document Subrecord
14	10	[SRCEREC.10]	Field Data Capturing Subrecord
Section Header Record			
16	01	[SECHREC.01]	Section Identification Subrecord
16	02	[SECHREC.02]	Section Settings Subrecord
16	03	[SECHREC.03]	Network Identification Subrecord
16	04	[SECHREC.04]	Datasource Reference Subrecord
16	05	[SECHREC.05]	Datum & Magnetism Subrecord
16	06	[SECHREC.06]	Orthometric Reference Subrecord
16	07	[SECHREC.07]	Section Border Subrecord
16	08	[SECHREC.08]	XY Control Point Subrecord
16	09	[SECHREC.09]	Z Control Point Subrecord
Point Feature Record			
51	01	[POFEREC.01]	Explicit Point Topology Subrecord
51	02		Not defined in its own right (identical to 51.01)
51	03	[POFEREC.03]	Non-explicit Point Topology Subrecord

Line Feature Record

52	01	[LIFEREC.01]	Explicit Line Topology Subrecord
52	02		Not defined in its own right (identical to 52.01)
52	03	[LIFEREC.03]	Non-explicit Line Topology Subrecord

Area Feature Record

53	01	[ARFEREC.01]	Full Rendering Area Topology Subrecord
53	02	[ARFEREC.02]	Connectivity Rendering Area Topology Subrecord
53	03	[ARFEREC.03]	Non-explicit Area Topology Subrecord

Complex Feature Record

54	01	[COFEREC.01]	Explicit Complex Topology Subrecord
54	02		Not defined in its own right (identical to 54.01)
54	03	[COFEREC.03]	Non-explicit Complex Topology Subrecord

Update Information Record

89	01	[UPDIREC.01]	Geo-topo Update Information Subrecord
89	02	[UPDIREC.02]	Object Update Information Subrecord
89	03	[UPDIREC.03]	Object Attribute Update Information Subrecord

12.2.2.4 Continuation Mark

The Continuation Mark is a one-character Field which occurs at the end of each media record (at the 80th position). It occurs in all record types except the Volume Termination Record (which instead has an explicit Volume Continuation Mark field, CONT_VOL, at the 80th position). The regular Continuation Mark's function is to indicate the end of media and/or logical records.

The Continuation Mark can have two values: 0 or 1.

0: means that the logical record ends together with the media record.

1: means that the logical record continues in the subsequent Continuation Record.

12.2.2.5 Field counter

12.2.2.5.1 NUM Counters

In many record types data Fields or Field groups occur which may repeat within the overall structure of the logical record. This means that within a particular instance of a logical record, there may be 0, 1 or more occurrences of that Field. This number may vary from one logical record instance to the other.

When there are more than 1 of these repeating Field types in a record, or when the repeating Field is followed by other (non repeating) Fields, it will be necessary to specify the number of occurrences in advance, because otherwise the Fields cannot be interpreted in a correct manner.

The number of repetitions is indicated by means of a Field Counter. This is a small Field that immediately precedes a repeating Field or Field group. The mnemonic names of these Fields all have the generic form: {NUM_ * }, where * has to be substituted by a letter string.

The following regular Field Counters have been defined:

Mnemonic Field Name	Description
NUM_FIELD	Number of fields
NUM_PARTS	Number of Feature parts
NUM_DASET	Number of Datasets
NUM_COMP	Number of components to Geopolitical Structure
NUM_CNTRY	Number of countries
NUM_FUL	Number of full predecessor Geopolitical Structure Component
NUM_IMM	Number of Immediate Parent Geopolitical Structure Components
NUM_SUBT	Number of Subtypes
NUM_LAN	Number of languages
NUM_LEV	Number of adjacent orthometric levels
NUM_PAR	Number of parameter sets
NUM_DOC	Number of Sources
NUM_THEM	Number of themes
NUM_COORD	Number of coordinates tuples
NUM_TIME	Number of T coordinates tuples
NUM_EDGE	Number of Edges
NUM_NODE	Number of Nodes
NUM_FACE	Number of Faces
NUM_ATT	Number of Attribute Sets or Number of Attributes in a Attribute Record or Number of Attributes in an Update Information Record
NUM_NAME	Number of Feature Class Names or Number of Attribute Type names or Number of Relationship Type names or Number of Administrative Area or Named Area names
NUM_FEAT	Number of Features
NUM_FEAT_C	Number of Feature Class candidates
NUM_ATT_BP	Number of Attribute back pointers
NUM_ATT_P	Number of Attribute sets per part(ner)
NUM_COMPLX	Number of Complex Features
NUM_EDG_BP	Number of Edge backpointers
NUM_CONV	Number of conversion records
NUM_H1	Number of H1 coordinates
NUM_INTVAL	Number of coordinate intervals

Mnemonic Field Name	Description
NUM_AREA	Number of Area Features
NUM_LINE	Number of Line Features
NUM_POINT	Number of Point Features
NUM_REC	Number of Records
NUM_REL	Number of Relationships
NUM_BP_FT	Number of reverse pointer Features
NUM_ROLE	Number of Roles
NUM_SECT	Number of Sections
NUM_TEXT	Number of Text Records
NUM_Z	Number of Z coordinates
NUM_EXTGEO	Number flagging the presence of Extended area geometry information

12.2.2.5.2 DD_NUM Counters

Contrary to a NUM Counter, a DD_NUM Counter can dynamically assume a discrete number of allowable values from within the specified min/max range. These values may or may not be conditional to other NUM or DD_NUM fields. An example would be a Discrete Dynamic Counter that can be set to either '0', '1', or 'all' ('all' being specified in terms of a value specified in another field, such as a NUM field).

The following DD_NUM Counters have been defined:

Mnemonic Field Name	Description
---------------------	-------------

DD_NUM_Z	Discrete Dynamic Counter of Number of Z coordinates
DD_NUM_H1	Discrete Dynamic Counter of Number of H1 coordinates
DD_NUM_H2	Discrete Dynamic Counter of Number of H2 coordinates

12.2.3 Common fields

12.2.3.1 Introduction

This sub-clause describes Fields which occur in many different record types.

12.2.3.2 Language Code

Some free text Fields may be preceded by a Field named Language Code. This Field shall contain the ISO 639-2 language code [4] of the language which is used in the text Field that follows.

12.2.3.3 ISO 3166 Country Code

This Field shall contain the alpha-3 country code as specified in ISO 3166-1 [7].

A comprehensive list of the codes of countries can be found in Clause B.2.

12.2.3.4 Theme Code

This Field is 2 characters long and contains numerical values and shall be used to specify the Feature Theme Code. The Feature Theme Code values can be found in Clause A.1.

12.2.3.5 Feature Code

A Field that can be found in all Feature records. This Field shall contain a four-digit code of the Feature Class to which the Feature in issue belongs.

The Feature Code values can be found in Clause A.1.

12.2.3.6 Identifiers

Many record types have Fields where an ID-number of a particular entity is declared or that refer to the ID-number of an entity declared in another record. These ID-numbers have to be unique within a given context (Section, Layer, Dataset, Supplier) and for a particular entity type (Feature Category, Edge Name, Source Description, etc.). This means that no two entity instances of the same type within the same context may have the same ID-number.

For a set of sub-records belonging together, the ID-number has to be the same one designated to the “master” sub-record. As an example, the designated DESC_ID in the Description Info Sub-record 14.01 shall be the same for all associated source document sub-records 14.x. Additionally, for any sub-record which can occur multiple times, a supplementary sub-identifier is introduced, unless uniqueness among multiples is achieved by means of a composite key involving other fields.

Relationship Records, Attribute Records, Text Records, and Time Domain Records may be stored

- Locally within a Section,
- Semi-globally on Layer level (outside of a particular Section), or
- On Dataset level (outside of a particular Layer).

Data records referring to these records (Point/Line/Area/Complex Feature Record → Attribute Record; Relationship Record → Attribute Record; Attribute Record → Text Record/Time Domain Record; Text Record → Attribute Record) will flag the respective ID scope which determines the respective context for ID uniqueness. Attributes have to be published at the same or a higher scope level as the Relationships in question (e.g. a Relationship on Layer level must not refer to an Attribute specified within a particular Section). Text Records and Time Domain Records have to be published at the same or a higher scope level as the Attribute in question (e.g. an Attribute on Layer level must not refer to a text record specified within a particular Section). Attributes have to be published at the same or a higher scope level as the Text Record in question (e.g. a text record on Layer level must not refer to an Attribute specified within a particular Section).

The Fields for ID-numbers have a length of 2, 4, 5, or 10 characters. The maximum value that may be stored in a 10 character ID-Field is $2^{32}-1$. As a convention, the minimum value for any ID-number is 1, regardless of the Field length. However, the value 0 (zero) may be used with a special meaning in certain cases.

As a rule the ID-number Fields have mnemonic Field names which have the generic form: {*_ID}, where * may be substituted by a string of letters.

There are exceptions to this rule, specifically:

- Field Definition Record FLD_NAME is used as an Identifier
- Attribute Definition Record ATT_TYPE is used as an Identifier
- Feature Definition Record FEAT_CODE is used as an Identifier
- Relationship Definition Record REL_CODE is used as an Identifier

In select cases, multiple fields are used together as a composite key:

- Record Definition Record: use REC_TYPE + REC_CODE as a composite key
- Abbreviation Record: use LAN_CODE + ABBR_SHORT as a composite key.

Default Attribute Record: use ATT_TYPE + ATT_VAL as a composite key

Attribute Value Definition Record: use ATT_TYPE + ATT_VAL as a composite key

The following ID-Fields have been defined (without listing sub identifiers {*_SUBID}) and derived ID-fields such as VOL_ID_S):

Global records

Mnemonic Name	Description
ALBUM_ID	Album Identifier
VOL_ID	Volume Identifier
DASET_ID	Dataset Identification Number
LAY_ID	Layer Identifier
SECT_ID	Section Identification Number
NW_ID	Network Specification Type Identifier
GPL_STR_ID	Geopolitical Structure Identifier
GPL_S_C_ID	Geopolitical Structure Component Identifier
DESC_ID	Source Description Identifier
PAR_ID	Parent Description Identifier
HOST_ID	Host Description Identifier
DATEL_ID	Datum Description Identifier
VERDAT_ID	Vertical Datum Description Identifier
PROJEC_ID	Projection Description Identifier
NATGRID_ID	Grid Description Identifier
GEOID_ID	Geoid Description Identifier
MAGN_ID	Declination Description Identifier
GEOREC_ID	Geodetic Parameter Record Identifier
DIR_ID	Directory Record Identifier

Data records

Mnemonic Name	Description
TEXT_ID	Text Identifier
ATT_ID	Attribute Identifier
ATT_ID_P	Attribute Identifier of Feature part(ner)
NODE_ID	Node Identifier
FNODE_ID	From Node Identifier
TNODE_ID	To Node Identifier
EDGE_ID	Edge Identifier
FACE_ID	Face Identifier
L_FACE_ID	Left Face Identifier
R_FACE_ID	Right Face Identifier
POINT_ID	Point Feature Identifier
LINE_ID	Line Feature Identifier
AREA_ID	Area Feature Identifier
COMPLEX_ID	Complex Feature Identifier
FROM_ID	From Feature Identifier
TO_ID	To Feature Identifier
CONV_ID	Conversion Record Identifier
FEAT_ID	Feature Identifier

EXT_ID	Foreign Section Feature Identifier
INT_ID	Internal Section Feature Identifier
REL_ID	Relationship Identifier
TIME_ID	Time Domain Identifier
OBJREF_ID	Object Reference Identifier
REC_REF_ID	Record Identifier of record referenced by Object Reference Record
COORD_ID	Coordinate identifier
PAR_IMM_ID	Immediate parent identification
PRE_FUL_ID	Lowest full predecessor identification
REC_ID	Record identifier
SPATDOM_ID	Spatial domain identifier

Update Information records

Mnemonic Name	Description
GEO_ID	Geometry/Topology Object Identifier
OBJ_ID	Object Identifier
UPD_GEO_ID	Geo-topo Update Information Record Identifier
UPD_OBJ_ID	Object Update Information Record Identifier
UPD_ATT_ID	Object Attribute Update Information Record Identifier

12.2.4 Fields in Global Records

12.2.4.1 General

Detailed descriptions of the Fields that occur in the Global Records can be found in the Metadata Catalogue. The Field names used in the column “Description” of the record syntax definitions (sub-clause 12.6-12.8) correspond to sub-clause headings in the Metadata Catalogue and can be found by means of the index.

12.2.4.2 Volume related fields

12.2.4.2.1 Volume Identifier

The sequence number of the present Volume within the context of an Album. It starts with 1 for the first volume and is incremented for each subsequent volume up to a maximum of 9999. The Volume Identifier of the last Volume of an Album is by definition identical to the number of volumes.

In combination with the Album Identifier it serves as a unique identification number of the Volume in issue.

12.2.4.2.2 Volumes Size

The size of the present Volumes expressed in bytes.

12.2.4.2.3 Number of Volumes

The total number of Volumes in the Album. The maximum number of Volumes in an Album is 9999.

12.2.4.2.4 Associated Datasets

12.2.4.2.4.1 Introduction

Specifies which Datasets can be found in the present Volume.

It consists of the Number of Datasets associated with the Volume in issue, and a Dataset Identifier and a Start Volume Identifier where the Dataset Header is stored for each Dataset or part of a Dataset in the present Volume.

12.2.4.2.4.2 Number of Datasets

The number of Datasets or parts of Datasets that are associated with the Volume.

12.2.4.2.4.3 Dataset Identifier

For each Dataset or part of a Dataset, the identification number of the Dataset header which is related to the Volume.

12.2.4.2.4.4 Start Volume Identifier

The identification number of the Volume where the Dataset Header for the Dataset specified in the Dataset Identifier can be found. This number may be the local Volume number

12.2.4.2.5 Volume Terminator

12.2.4.2.5.1 Introduction

Indicates that the present Volume is terminated and specifies whether it is followed by another Volume or not. It consists of Volume Termination Comments and a Volume Continuation Mark.

12.2.4.2.5.2 Volume Termination Comments

Any kind of relevant information concerning the present Volume.

12.2.4.2.5.3 Volume Continuation Mark

A mark expressing one of the two following values:

- The present Volume is the last one of the Album.
- The present Volume is not the last and will be followed by another one.

12.2.5 Fields in Data Records

12.2.5.1 XYZ Coordinates

12.2.5.1.1 X-coordinate

This Field contains the value of the X-coordinate of a point.

The coordinate value shall refer to the (national) grid as mentioned in the Section Header, taking into account the offset value as specified in the same header.

The coordinate value shall be expressed in the length unit of the (national) grid as mentioned in the Section Header, taking into account the multiplication factor as specified in the same header.

12.2.5.1.2 Y-coordinate

This Field contains the value of the corresponding Y-coordinate of the point in question. See "X-coordinate" for further specifications.

12.2.5.1.3 Z-coordinate

This Field contains the value of the corresponding Z-coordinate of the point in question. The Z-value shall be expressed in the length unit and relative to the vertical datum as mentioned in the Section Header, taking into account the multiplication factor as specified in the same header.

Together with above-specified XY coordinates, a 2.5-dimensional object model for the geometrical representing of both, topological and non-explicit topological Features is provided (see also sub-clause 9.1.6.1).

12.2.5.2 Extended geometry

12.2.5.2.1 H1 and H2 Coordinates

These Fields contain the upper object elevation H1 and lower object elevation H2, respectively, above (or below) the earth's surface. Together with before-mentioned XYZ coordinates, a three-dimensional object model for representing Dot, Polyline, and Polygon geometry of non-explicit topological Features is provided (see also sub-clause 9.1.6.2).

H1 and H2 are measured in metres. Negative values designate elevations below the earth's surface.

The upper object elevation specifies the total vertical height relative to the earth's surface. The lower elevation further modifies the object's geometry by introducing open space between object and the earth's surface ($0 < H2 < H1$), or by extending the object's vertical extent below the earth's surface ($H2 < 0$). In a special case, both H1 and H2 may be below ground ($H2 < H1 < 0$).

As part of Dot geometry, H1 may be absent or not absent. H2 is not applicable to Dots.

As part of Polyline and Polygon geometry, H1 may be absent, may be set to a constant value for the entire Polyline/Polygon, may be specified for 2 or more intervals of sequences of Polyline/Polygon vertices, or may be specified individually for each Polyline/Polygon vertex. Equally, H2 may be absent, may be set to a constant value for the entire Polyline/Polygon, may be specified for 2 or more intervals of sequences of Polyline/Polygon vertices, or may be specified individually for each Polyline/Polygon vertex.

If H1 is absent, H2 shall be absent, too. If H1 is present without H2, H2 assumes default value 0.

Use of intervals requires repetition of XY coordinates at interval borders. If more than one coordinate is intervallic, intervals may have to be made smaller to represent the least common denominator of two, or three, levels of intervallic coordinates. See sub-clause 12.2.5.3.4 for basic examples of intervals.

12.2.5.2.2 T Coordinates

These Fields contain the set of temporal coordinates SA (Start Appearance), EA (End Appearance), SD (Start Disappearance), and ED (End Disappearance) about the object's existence. Together with before-mentioned XYZ coordinates and H1/H2 coordinates, a four-dimensional object model for representing Dot, Polyline, and Polygon geometry of non-explicit topological Features is provided (see also sub-clause 9.1.6.3).

SA, EA, SD, and ED are stored as a time stamp with format YYYYMMDDHH. Specification of year (YYYY), month (MM) and day (DD) is mandatory. Hours (HH) shall be set to '00' if not applicable.

SA, EA, SD, and ED represent the start and end of the object's existence in time, including time ramps for the period during which the object came into existence ($SA \rightarrow EA$), and during which it ceased to exist ($SD \rightarrow ED$) [39]. Temporal coordinates describe the object's existence as a whole; individualized temporality per Polyline/Polygon vertex or interval is not applicable. Multiple geometrical representations of an object (each valid at a different time period) must not mutually overlap.

Object geometry may use only some and not all of the temporal coordinates to describe its existence over time, including the transitions, with a total of 16 valid combinations. Note that two- or three-dimensional object

geometry without temporal coordinates is treated separate from four-dimensional geometry with T coordinates all being absent (see also sub-clause 9.1.6.3.2).

12.2.5.3 Coordinate Mask, Time Mask and Examples

12.2.5.3.1 General

Whether or not the Z, H1, H2, and T coordinates are present, and if so (where applicable) with an individual, intervallic, or constant scheme, is signalled by the coordinate mask field. Additionally, the presence of each of the four temporal coordinates is signalled by the time mask field.

12.2.5.3.2 Coordinate Mask

This Field contains four one-digit mask positions for Z, H1, H2, and T (or in short ZHHT).

Four different mask values are defined for Z, H1, and H2, respectively:

- 0 : no occurrence of coordinate
- 1 : constant coordinate for whole Polyline/Polygon (not applicable to Dots)
- 2 : constant coordinate per interval (not applicable to Dots)
- 3 : individual coordinate per XY position

Two different mask values are defined for T:

- 0 : no occurrence of coordinates, and as a consequence time mask is not applicable
- 1 : constant set or coordinates, applicable to entire Dot, Polyline, or Polygon

Valid ZHHT mask settings for Dot geometry allow for a total $2^2 \times 2^2$, or 8, cases:

- Z = 0 | 3
- HH = 00 | 30
- T = 0 | 1

Valid ZHHT mask settings for Polyline/Polygon geometry allow for a total $4^2 \times 3^2$, or 104, cases:

- Z = 0 | 1 | 2 | 3
- HH = 00 | 10 | 20 | 30 | 11 | 21 | 31 | 12 | 22 | 32 | 13 | 23 | 33
- T = 0 | 1

12.2.5.3.3 Time Mask

This Field contains four one-digit mask positions for SA, EA, SD, and ED. Two binary states are defined for each coordinate:

- 0 : no occurrence of coordinate
- 1 : coordinate occurs

The mask renders the composite binary states of the four temporal coordinates as a decimal value as follows:

Mask	Action	SA	EA	SD	ED	Interpretation
0		-	-	-	-	Feature no longer exists w/ incomplete info
1		•	-	-	-	Feature is being built
2		-	•	-	-	Feature exists now w/ incomplete info
3		•	•	-	-	Feature was built and exists now
4		-	-	•	-	Feature is deserted w/ incomplete info
5		•	-	•	-	Feature was built, and deserted
6		-	•	•	-	Feature was built w/ incomplete info, and deserted
7		•	•	•	-	Feature was built, and deserted
8		-	-	-	•	Feature no longer exists w/ incomplete info
9		•	-	-	•	Feature was built, and no longer exists w/ incomplete info
10		-	•	-	•	Feature was built, and no longer exists w/ incomplete info
11		•	•	-	•	Feature was built, and no longer exists
12		-	-	•	•	Feature no longer exists w/ incomplete info
13		•	-	•	•	Feature was built, and no longer exists
14		-	•	•	•	Feature was built, and no longer exists
15		•	•	•	•	Feature was built and no longer exists
<p>●: time info; ●: unknown time info; —: known period; -÷: unknown period</p>						

12.2.5.3.4 Examples

To illustrate the capabilities of the four-dimensional geometry model for non-explicit topological Features, a number of examples are provided. These examples focus in the usage options for Z, H1, and H2. The aspect of temporal existence is deliberately left out. For temporal examples, see sub-clause 9.1.6.3.2.

Figure 224 gives an example with the ZHHT mask set to 132*:

- Z is constant;
- H1 is individually specified per vertex; and
- H2 is constant for a number of intervals.

Note that XY coordinates are to be repeated at interval borders (here H2 intervals).

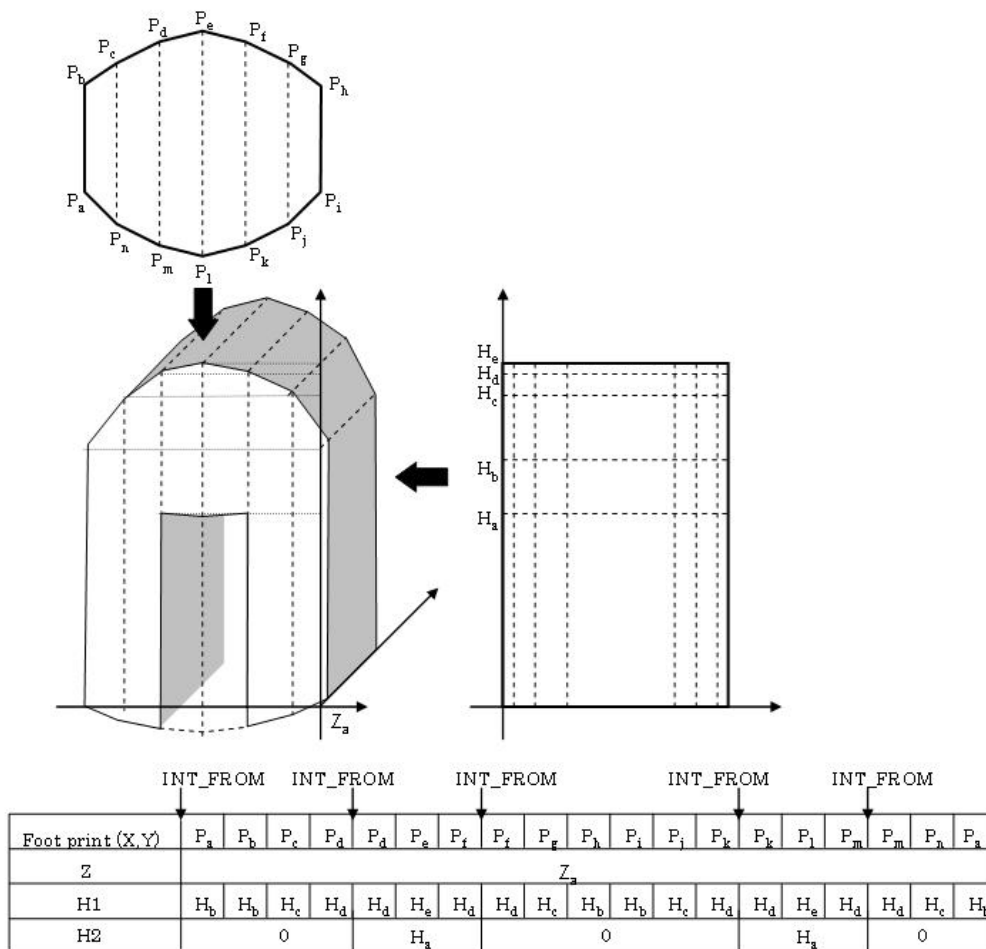

Figure 224 — Example for 132* coordinate mask

Figure 225 gives an example with the ZHHT mask set to 213*.

- Z is constant for a number of intervals;
- H1 is constant for the entire object; and
- H2 is individually specified per vertex.

Note that XY coordinates are to be repeated at interval borders (here Z intervals).

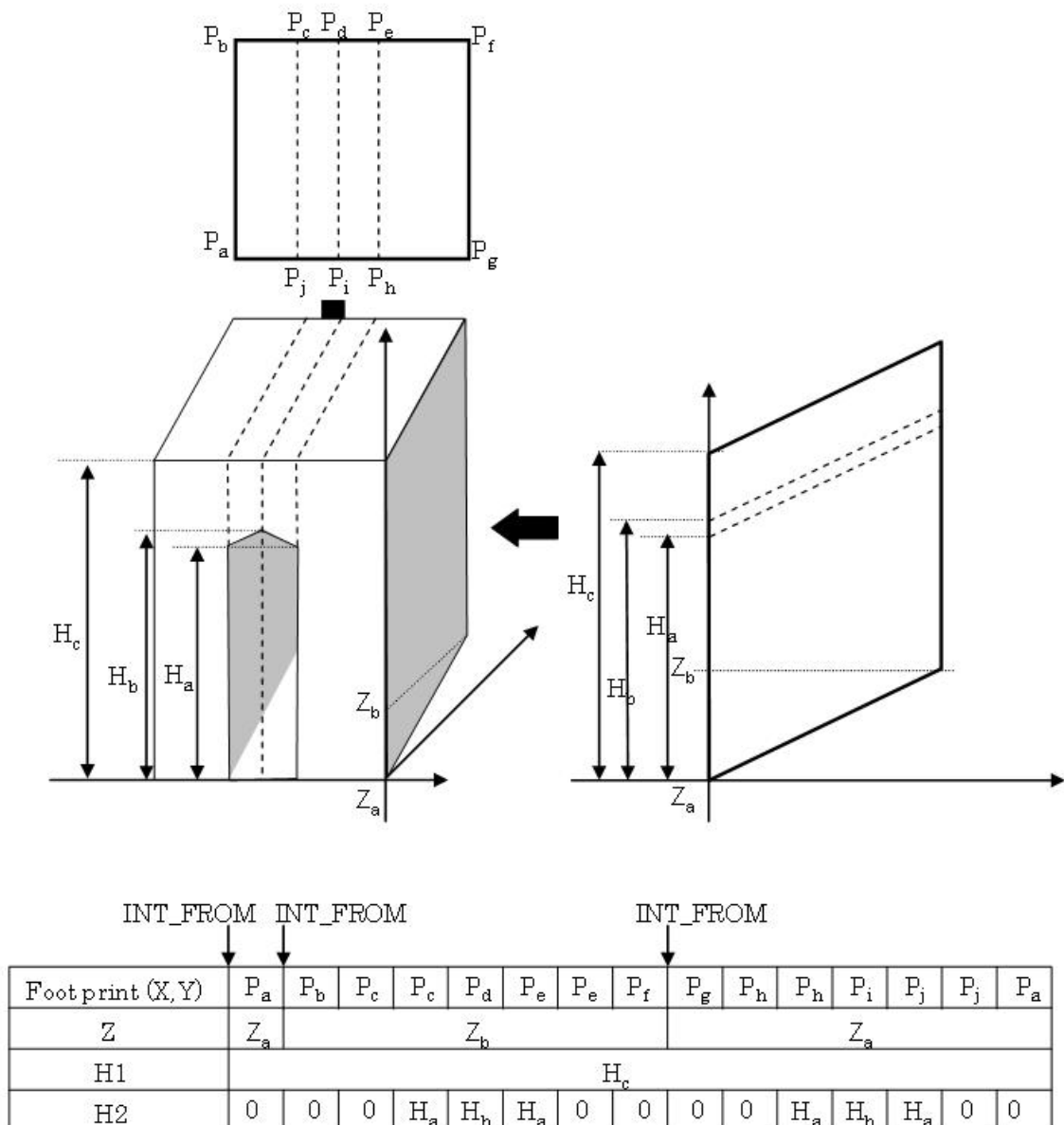

Figure 225 — Example for 213* coordinate mask

Figure 226 gives an example with the ZHHT mask set to 231*:

- Z is constant for a number of intervals;
- H1 is individually specified per vertex; and
- H2 is constant for the entire object.

Note that XY coordinates are to be repeated at interval borders (here Z intervals).

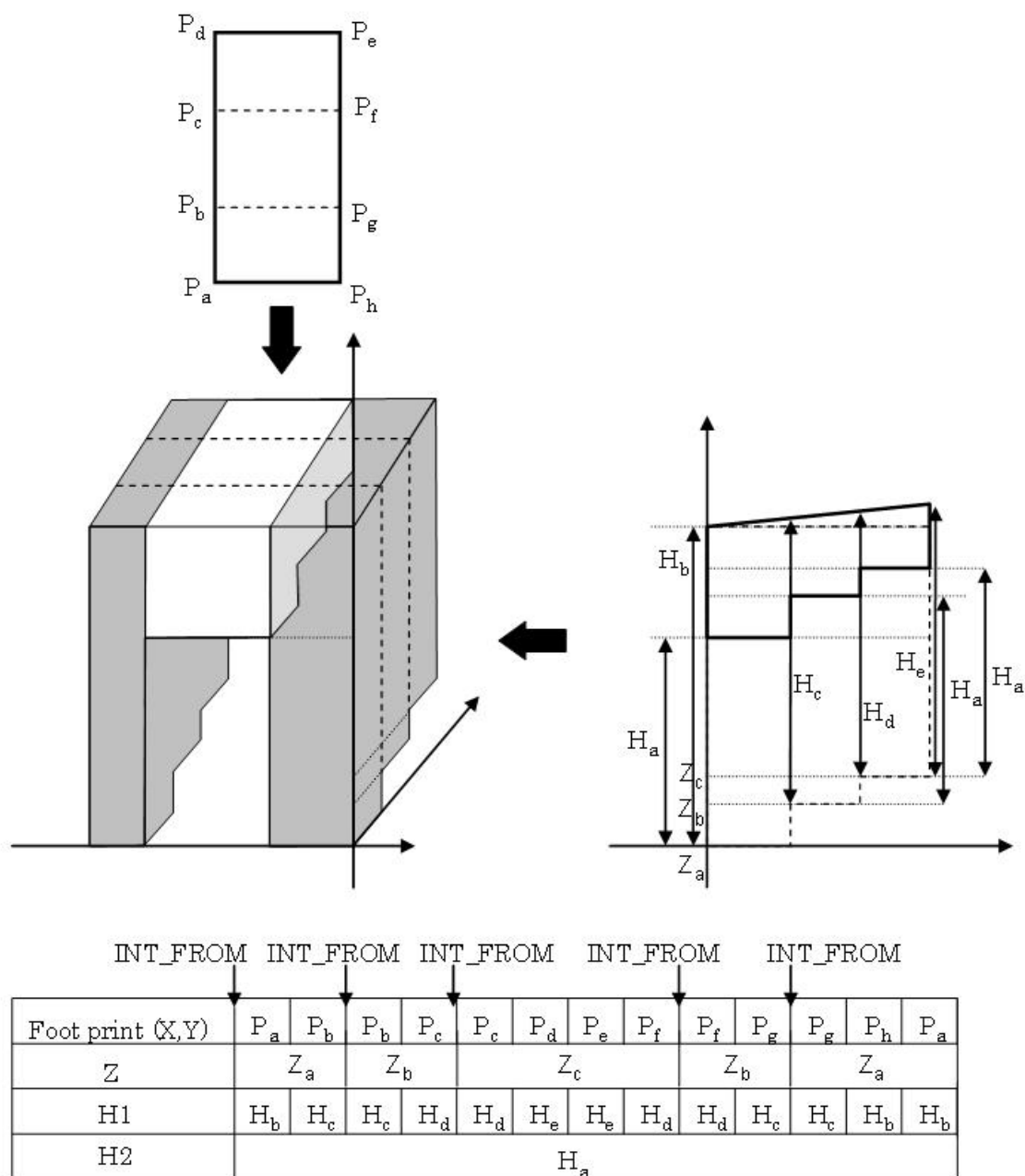
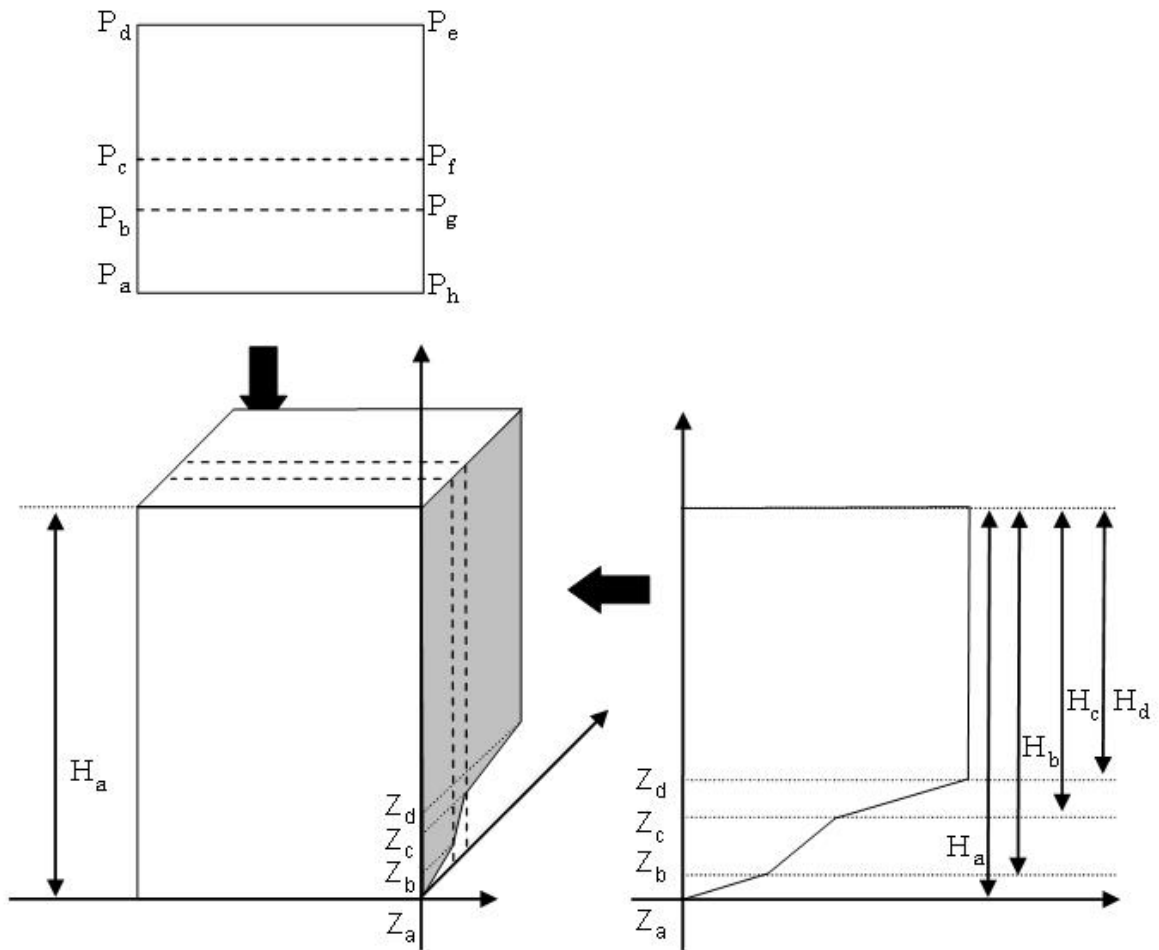

Figure 226 — Example for 231* coordinate mask

Figure 227 gives an example with a ZHHT mask set to 330*:

- Z and H1 are specified individually per vertex; and
- H2 is absent (with default value 0).



Foot print (X,Y)	P _a	P _b	P _c	P _d	P _e	P _f	P _g	P _h	P _a
Z	Z _a	Z _b	Z _c	Z _d	Z _d	Z _c	Z _b	Z _a	Z _a
H1	H _a	H _b	H _c	H _d	H _d	H _e	H _b	H _a	H _a
H2	0								

Figure 227 — Example for 330* coordinate mask

12.2.5.4 Status

This Field contains an indicator which specifies whether the Node or Edge is located exactly at the Section Border (and thus corresponds with a Node or an Edge in the adjacent Section) or whether it is located inside the Section.

The fact that a Node or an Edge is located on a Section border is either caused because it simply is located there (already before the sectioning) or because it was introduced in order to terminate the Edges continuing in the other Section. When two neighbouring Sections, or to terminate the Face continuing in the other Section, respectively, are merged again into one, a pair of Nodes of the first type will have to be combined into one and a pair of Nodes of the second type will have to be deleted completely. Similarly, when two neighbouring Sections are merged again into one, a pair of Edges of the first type will have to be combined into one and a pair of Edges of the second type will have to be deleted completely.

When two Sections are merged into one new one, appropriate Nodes or Edges will be deleted or combined into one. In order to distinguish the different types of Nodes, they can be flagged with a Status indicator.

Status can have the values 1-5:

- 1: means that the Node or Edge is situated at the Section border for sectioning purposes only.
- 2: means that the Node or Edge is "normal", i.e. not situated at the Section Border.
- 3: means that the Node or Edge is situated at the Section Border which is also the Dataset Border (please note that this status value is implicitly including the status value of "1").
- 4: means that the Node is at the end of a so-called "stub", i.e. a Line at the interior of a Section or Dataset that has been truncated and only represents a part of a Feature because further information was not available or required.
- 5: means that the Node or Edge is situated at the Section Border and/or Dataset border for reasons other than sectioning.

12.2.5.5 Edge Orientation

This Field indicates the direction of an Edge relative to the boundary of the Face or Area Feature that it bounds.

- 0: means that the Edge is clockwise oriented.
- 1: means that the Edge is counterclockwise oriented.

The direction of an Edge is determined by its start and end Nodes. In the case of circular Edges (i.e. with identical start and end Node) two possibilities exists to define the direction:

- 1: the Edge can be split into two Edges (Non circular).
- 2: the order of the vertices of the Edge.

12.2.5.6 NUM_ATT

12.2.5.6.1 General

Usually, a Feature has more than one Attribute Value attached to it. Several ways exist to specify these. The Feature records contain the Fields NUM_ATT and ATT_ID through which NUM_ATT Attribute records can be referred. These Attribute records themselves contain the Fields NUM_ATT, ATT_TYPE and ATT_VAL, which can be used to specify a set of NUM_ATT Attribute Values.

12.2.5.6.2 Specification of Composite Attributes

Composite Attributes do not occur as an Attribute Type Code on an Attribute Record. Rather, the existence of a Composite Attribute is inferred by the presence of one (or more) of the Simple Attributes that participate in the Composite Attribute.

A Composite Attribute may consist of Composite Attributes itself. In order to identify the bounds of a Composite Attribute, parentheses can be used. Additionally, parentheses can be used to group Simple Attributes with Restrictive Attributes, or Composite Attributes with Restrictive Attributes. Generally speaking, the parentheses can be used to define logical groups of Sub-Attributes and Sub-Attribute/Restrictive Sub-combinations. For consistency reasons it is advised that all Attributes are encased between at least one set of parentheses.

Restrictive Attributes at a given scope level are accumulated and then further restricted by Restrictive Attributes at the next higher level, and so on. In other words, using the language of set theory, Restrictive Attributes within an Attribute scope level are unioned and then intersected with the Restrictive Attribute at the next higher level and so on.

The actual parentheses do not appear in the GDF File. Rather a count of left and right parentheses is embedded around each occurrence of an ATT_TYPE/ATT_VAL field combination in the Composite Attribute Record.

As a consequence, the use of the NUM_ATT field in the Feature Record in relation to the use of NUM_ATT field in the Composite Attribute Record is restricted in the case of Composite Attributes or Attributes restricted by one or more Restrictive Sub-Attributes. These last two cases shall be completely specified within a Composite Attribute Record. In all other cases it is left to the user how the respective fields are used in combination.

EXAMPLE 1 A situation where a Road Element is Closed for trucks all the time, on Sunday closed for all vehicles and the rightmost lane is closed for all vehicles all the time:

("CLOSED IN BOTH DIRECTIONS" "TRUCKS" "SUNDAY" "RIGHTMOST LANE").

All Restrictive Sub-Attributes operate on the same scope level (the Attribute Direction of Traffic Flow with the value Closed in Both Directions). Consequently, the description represents the situation where all Restrictive Sub-Attributes operate individually on the logical group Closed in both Directions, the result of which subsequently are combined via an OR operator (i.e. unioned):

- Closed for trucks (all the time)
- ALSO closed (for all vehicles) on Sunday
- ALSO the rightmost lane is closed for all vehicles all the time

A situation as above where the rightmost lane is not closed for all vehicles but open for emergency vehicles in the positive direction could look like:

("CLOSED IN BOTH DIRECTIONS" "TRUCKS" "SUNDAY" "RIGHTMOST LANE") "ALL BUT EMERGENCY VEHICLES").

And

("OPEN IN POSITIVE DIRECTION" "RIGHTMOST LANE" "EMERGENCY VEHICLES").)

This situation needs to be specified via two Attribute Records because it contains two logical groups: Closed in Both Directions and Open in Positive Direction. Within this first group the Restrictive Sub-Attribute Values "Trucks", "Sunday" and "Rightmost Lane" all operate on the same scope level. The resulting statement is true for all vehicles except emergency vehicles.

- Closed for trucks (all the time) (for all lanes) except for emergency vehicles
- ALSO closed on Sunday (for all lanes) except for emergency vehicles
- ALSO the rightmost lane is closed (all the time) except for emergency vehicles

Because this does not describe yet what is true for emergency vehicles, the second logical group (i.e. what is true for emergency vehicles) needs also to be specified.

- The rightmost lane is open in positive direction for emergency vehicles

A situation where a Road Element is closed for Trucks on Sunday and the rightmost lane is closed for all vehicles on Sunday can be described as:

((“CLOSED” “TRUCKS” “RIGHTMOST LANE”) SUNDAY), meaning

- Closed for trucks on Sunday
- ALSO the rightmost lane closed on Sunday for all vehicles

A situation where the rightmost lane of a Road Element is closed for Trucks all the time and the rightmost lane is closed for all vehicles on Sunday can be described as:

((“CLOSED” “TRUCKS” “SUNDAY”) “RIGHTMOST LANE”), meaning

- The rightmost lane closed for trucks (all the time)
- ALSO the rightmost lane closed on Sunday for all vehicles

((“CLOSED” “TRUCKS”) “RIGHTMOST LANE”) “SUNDAY”), meaning

- Rightmost lane is closed for trucks on Sunday

Note that Restrictive Sub-Attributes operating on the same scope level can be exchanged. Exchanging Restrictive Sub-Attributes for different scope levels may lead to essentially different specifications.

12.2.5.7 Attribute Type Code

This Field contains the code of the Attribute Type in issue. This code governs the type, range and interpretation of the subsequent Attribute Value Field.

The Attribute Type Code consists of 2 letters. These can be found in Clause A.2.

12.2.5.8 Attribute Value

This Field contains an Attribute Value of the object in question, within the range of the Attribute Type. The data type of this Field is always “G”. The domain of a particular Attribute Type can be found in Clause 7 – Attribute Catalogue. The designated Attribute data type and, if applicable, codes for corresponding values, can be found in Clause A.2.

12.2.5.9 Text or Time Domain as Attribute Value

Most Attribute Values are stored in the Field Attribute Value. This is however not possible if the Attribute Value has or can have a length exceeding ten characters. In this case a different mechanism is offered. For all Attributes of Attribute data type TXT (Language-coded Text), the mechanism makes use of a special record type, the Text Record which shall be used to store the Attribute Value. In order to link the value to the Feature, the Attribute Value Field of the Attribute Record linked to the Feature Record shall contain a Text Identifier (TEXT_ID) which serves as a pointer towards the Text Record. It shall be noted that Attributes of Attribute

data type SCS (Short Character String) do not use this mechanism, but store any Attribute Values directly in the Field Attribute Value.

The specification of time domains also may exceed the length of ten characters. Therefore, for all Attributes of Attribute data type TIM (Time), the Attribute Value Field shall contain a Time Record Identifier (TIME_ID) which serves as a pointer to a Time Domain Record.

12.2.5.10 Feature Category Code

This Field indicates the Category to which a Feature belongs (see Clause A.1 for an explanation).

1 = Point Feature

2 = Line Feature

3 = Area Feature

4 = Complex Feature

12.2.5.11 Relationship Code

This Field contains a 4 digit code specifying the Relationship Type represented in a particular Relationship Record. Clause A.4 lists the Relationship Type names and their associated codes.

12.2.5.12 Time Domain Description

Time domains are represented by a particular record type, the Time Domain Record, which has its own particular syntax (See Clause D.1). Each Attribute that refers to a Time Domain (e.g. Opening Period, Validity Period) contains in the Attribute Value Field a pointer to a Time Domain Record.

12.2.5.13 Split Indicator

When a Layer is split into Sections, Features may be split across Sections. In such a case a Feature will be represented by two or more Lines (or Areas or Complexes), one in each Section and each only representing a part of the Feature.

When the Split Indicator has a value = 0, this means that the Line, Area or Complex represents the entire Feature. When it has a value = 1, this means that the Line, Area or Complex only represents a part of the Feature and that the other parts are to be found in the adjacent Section(s). In the case of a Complex Feature it is also possible that the complete Feature is defined in both Sections completely. This is indicated by the value 2. Value 2 refers to Complex Features only. It indicates that a definition of the Feature is repeated in another Section.

12.2.5.14 Line Direction

Indicator whether a Line has the same direction or the opposite direction as the underlying Edge.

0 = in direction of Edge

1 = in opposite direction

12.2.5.15 Network Identifier

The specification of the kind of network a particular Feature is part of. The use of this network identifier applies to transportation networks and refers to network types defined and described by metadata.

12.2.5.16 Extended Area Geometry Information

12.2.5.16.1 General

For areas, extended geometrical properties can be provided representing generated (i.e. redundant) information which facilitates data processing, such as graphical rendering. Use case for this is terrain surface modelling using either a Face in planar rendering of Full Topology, or an Area Feature in Non-Explicit Topology rendering.

12.2.5.16.2 Geometrical Type

Classification of the Geometrical Type of bounded area at hand. The geometrical type can be:

3 = Triangular

4 = Quadrangular

0 = Other.

12.2.5.16.3 Outline Length

Outline Length of bounded area at hand, expressed in decimetres.

12.2.5.16.4 Area Size

Size of bounded area at hand, expressed in square metres.

12.2.5.16.5 Area Slope

Slope of bounded area at hand, representing the (maximum) inclination, expressed as positive percentage.

12.2.5.16.6 Aspect

Aspect of bounded area at hand, representing the horizontal bearing of slope vector (maximum inclination), expressed as clockwise angle against North measured in 1/10 of a degree.

12.2.5.16.7 Light Value

Light Value of bounded area at hand, representing an artificial hill shade, expressed as a grey scale. No standardized provisions are made as to the position of the (virtual) illumination source, i.e. distance, azimuth, and altitude are user-defined.

12.2.5.17 Object Referencing

In order to facilitate effective Object ID management, this International Standard provides for Object Referencing. In the context of the Media Record Specifications, Object Referencing describes the possibility to publish user-defined references for a range of data entities, including:

- Node
- Edge
- Face
- Point Feature
- Line Feature
- Area Feature
- Complex Feature
- Relationship
- Attribute (single or composite), including Restrictive Sub-Attributes
- Text (name) of an Attribute of a Feature or Relationship
- Time Domain

An Object Reference is specified like a cross-reference in a look-up table. For a specific data record, identified through Record Type Code and Record Identifier, a user-defined Object Reference is published. Each single Object Reference is further described by

- the data Type of the Object Reference
- the length of the Object Reference
- an Object Reference Type from a user-defined set of types

The Object Reference Record needs to be published at the same scope level as the referenced record. In other words, the Object Reference Records needs to reside in the same Section, Layer, or Dataset, respectively, as the data record it references.

12.2.6 Fields in Update Information Records

12.2.6.1 General

Descriptions of fields uniquely used for publishing update information. Other fields that are adopted from Data records are not described, except if their use differs from their usual purpose.

12.2.6.2 Product Cycle

User-defined reference number to update cycles.

12.2.6.3 GEO Category

This field indicates the category of geometrical objects affected by an update.

1 = Node

2 = Edge

3 = Face

4 = Dot

5 = Polyline

6 = Polygon

12.2.6.4 Object Category

This field indicates the category to which a Feature belongs. In the context of classifying update information, Relationships are treated as another category.

1 = Point Feature

2 = Line Feature

3 = Area Feature

4 = Complex Feature

5 = Relationship

6 = Name

7 = Time Domain

8 = Other Text

12.2.6.5 Object Class Code

A unique identification of the object updated. If the object is a Feature, the Feature Class Code shall be used. If the object is not a Feature, the following codes shall be used:

Object type	Code
Relationship	0001
Name	0002
Time Domain	0003
Other Text	0004

12.2.6.6 Action Class

Indicator of the type of update action.

0 = Update of source only (i.e. no action in relation to actual Object or Geometry)

1 = New (i.e. added information)

2 = Delete (i.e. information no longer valid)

3 = Modify (i.e. information superseding present information)

Note that Modify is non-applicable for Objects of Object Category Point Feature, Line Feature, Area Feature, or Complex Feature.

12.2.6.7 Action Time Stamp

Time of the GDF alteration specified by means of the other update fields. The format of the time stamp is specified through Metadata.

12.2.7 Fields Catalogue

The following table is a central repository of all the Fields that occur in all the Record Types. They are listed alphabetically and cross referenced by the Record Types where the Fields are used.

If a Field type occurs more than once in a particular record type, or in two or more different record types, the minimum and maximum values may vary for each individual occurrence due to the semantic context within the particular record type. In such cases, the Field catalogue specifies the outer minimum-maximum range that is syntactically possible. The respective values are marked with a “ * ” to identify that some occurrences of the affected Field type may have a higher minimum value or a lower maximum value respectively.

No.	Field name	Description	Records	Size	Type	Minimum	Maximum
1	ABBR_SHORT	Abbreviation short	13	20	L		
2	ABBR_LONG	Abbreviation long	13	50	L		
3	ABSTRACT	Content summary	02.01	*	L		
4	ACTION	Action Class	89.01, 89.02, 89.03	2	N	0	3
5	ACT_DATE	Action Time Stamp	89.01, 89.02, 89.03	20	G		
6	ALBUM_ID	Album identifier	01.01, 01.03	10	N	1	$2^{32}-1$
7	ALB_SIZE	Album size	01.01	20	N	640	$10^{20}-1$
8	AREA_ID	Area Feature ID	24, 29, 53.01, 53.02, 53.03	10	N	1	$2^{32}-1$
9	ASPECT	Aspect of bounded area	29, 53.03	4	N	0	3599
10	AT_MAX_VAL	Maximum Attribute Value	05	11	I	-2^{31}	$2^{31}-1$
11	AT_MIN_VAL	Minimum Attribute Value	05	11	I	-2^{31}	$2^{31}-1$
12	ATT_DESC	Attribute description	05	*	L		
13	ATT_DIR	Segmentation direction	44	1	G		

No.	Field name	Description	Records	Size	Type	Minimum	Maximum
14	ATT_D_TYPE	Attribute data type	05	3	A		
15	ATT_ID	Attribute ID	10, 11, 41, 44, 45, 50, 51.01, 51.03, 52.01, 52.03, 53.01, 53.02, 53.03, 54.01, 54.03	10	N	1	$2^{32}-1$
16	ATT_ID_BP	Attribute identifier pointing back to Attribute of text record	41	10	N	1	$2^{32}-1$
17	ATT_ID_P	Attribute Identifier of Feature part(ner)	50, 54.01, 54.03	10	N	1	$2^{32}-1$
18	ATT_NAME	Attribute Type Name	05	40	L		
19	ATT_TYPE	Attribute Type Code	05, 15, 18, 44, 89.03	2	G		
20	ATT_VAL	Attribute value code	15, 18, 44, 89.03	11	G		
21	AUTHOR	Author name	14.03	*	L		
22	CHAR_SET	Character set designation	01.01, 01.02	2	N	1	99*
23	CHAR_TBL	Character Code Table Name	01.02	20	G		
24	CHAR_VER	Character Code Table Version No.	01.02	10	G		
25	CMPSPILTIND	Complex Split indicator	54, 54.01, 54.03	1	N	0	2
26	CNT_CODE	Country involved	02.01, 02.04, 14.02, 14.07, 14.08	3	A		
27	CNT_CODE_A	Adjacent country involved	62	3	A		
28	COLL_SEQ	Collating Sequence	01.02	3	A		

No.	Field name	Description	Records	Size	Type	Minimum	Maximum
29	COMPLEX_ID	Complex Feature ID	50, 51.01, 51.03, 52.01, 52.03, 53.01, 53.02, 53.03, 54.01, 54.03,	10	N	1	2^{32}
30	COMMENT	Comment	04, 14.09, 14.10, 61, 63, 90	*	L		
31	COMPL_LEV	Level of completeness	14.01	1	N	1	1
32	CONT_VOL	Volume continuation mark	99	1	N	0	1
33	CONV_EXP	Conversion unit exponent	05	2	I	-9	9
34	CONV_ID	Conversion Record Identifier	44, 46, 51.01, 51.03, 52.01, 52.03, 53.01, 53.02, 53.03, 54.01, 54.03	10	N	1	$2^{32}-1$
35	CONV_MAN	Conversion unit Mantissa	05	11	I	1	$2^{32}-1$
36	COORD_ID	Coordinate identifier	22, 23, 24, 25	10	N	1	$2^{32}-1$
37	COORD_MASK	Coordinate mask	51.03, 52.03, 53.03	4	N	0	3331
38	COORD_TYPE	Horizontal ref. Type	16.05	1	N	0	1
39	CORI_DATE	Copyright date	01.03	8	N	10000101	99991231
40	CORI_OWNER	Copyright owner	01.03	*	L		
41	COUNT_LF_(Number of logical left parenthesis	44, 89.03	1	N	0	9
42	COUNT_RT_)	Number of logical right parenthesis	44, 89.03	1	N	0	9
43	CREA_DATE	Creation date	01.03	8	N	10000101	99991231
44	CREA_YEAR	Creation year	02.05	4	N	1000	9999

No.	Field name	Description	Records	Size	Type	Minimum	Maximum
45	DASET_ID	Dataset identifier	01.01, 02.01, 02.02, 02.03, 02.04, 02.05, 02.06, 02.07, 01.03, 01.04, 02.01, 46, 50	10	N	1	$2^{32}-1$
46	DAST_SUBID	Sub Identifier of Dataset ID	02.02, 02.03, 02.04, 02.06	3	N	1	999
47	DASET_NAME	Dataset main title	02.02	*	L		
48	DATA_TYPE	Data type	03, 83	2	A		
49	DATA_UNIT	Data unit	03, 05	3	A		
50	DATA_USE	Field class	03	2	N	1	4
51	DATEL_ID	Datum description ID	16.05, 61	10	N	1	$2^{32}-1$
52	DATE_FMT	Time Stamp Format	16.10	20	G		
53	DAT_CODE	Horizontal Datum Code	61	4	A		
54	DAT_NAME	Horizontal Datum name	61	50	L		
55	DD_NUM_H1	Discrete dynamic counter of number of H1 coordinates	52.03, 53.03	5	N	0	99999
56	DD_NUM_H2	Discrete dynamic counter of number of H2 coordinates	52.03, 53.03	5	N	0	99999
57	DD_NUM_Z	Discrete dynamic counter of number of Z coordinates	52.03, 53.03	5	N	0	99999
58	DEC_DATE	Validity date	66	8	N	10000101	99991231
59	DEC_VALUE	Magnetic variation	66	7	I	-400000	400000
60	DESCR_LEV	Description level	14.01	1	N	1	4

No.	Field name	Description	Records	Size	Type	Minimum	Maximum
61	DESC_ID	Source description ID	14.01, 14.02, 14.03, 14.04, 14.05, 14.06, 14.07, 14.08, 14.09, 14.10, 16.04, 22, 23, 24, 25, 29, 41, 44, 45, 50, 51.01, 51.03, 52.01, 52.03, 53.01, 53.02, 53.03, 54.01, 54.03,	5	N	1	99999
62	DESC_SUBID	Sub Identifier of source description ID	14.04, 14.05, 14.07, 14.08	3	N	1	999
63	DEFAULTLAN	Default language	02.01	3	A		
64	DEV_ANNUAL	Annual change	66	7	I	-400000	400000
65	DIR_ID	Directory identifier	06	10	N	1	$2^{32}-1$
66	DIST_NAME	Name of distributor	14.08	*	L		
67	DIST_PLACE	Place of distribution	14.08	20	L		
68	DIST_YEAR	Year of distribution	14.08	4	N	1000	9999
69	DOC_TITLE	Document title	14.04	*	L		
70	DSET_TOPIC	Main Theme	02.01	2	N	1	19
71	EAST_LONG	East bound longitude	08	7	I	-180000	180000
72	EDGELEVE	Edge height level at end Node	52.01	2	I	-9	99
73	EDGELEVI	Intermediate Edge height level	52.01	2	I	-9	99
74	EDGELEVS	Edge height level at start Node	52.01	2	I	-9	99
75	EDGE_ID	Edge ID	22, 23, 25, 24, 29, 52.01, 53.02	10	N	1	$2^{32}-1$
76	EDIT_NR	Edition number	14.06	20	G		

No.	Field name	Description	Records	Size	Type	Minimum	Maximum
77	ED_DATE	Edition date	02.01	10	N	1000010100	9999123123
78	EL_CODE	Ellipsoid code	61	2	A		
79	END_FDC	End date FDC	14.10	8	N	10000101	99991231
80	ETA_CONN	Artificial ETA Connectivity	16.03	1	N	0	1
81	EXT_F_CAT	External Feature category	46	2	N	1	4
82	EXT_ID	Foreign Section Feature identifier	46	10	N	1	2 ³² -1
83	FACE_ID	Face identifier	25, 29, 53.01	10	N	1	2 ³² -1
84	FEAT_CAT	Feature Category	19, 44, 50, 54	2	N	1	4
85	FEAT_CAT_I	Internal Feature Category	46	2	N	1	4
86	FEAT_CAT_F	Foreign Feature Category	46	2	N	1	4
87	FEAT_CODE	Feature Class Code	07, 09, 11, 15, 18, 51.01, 51.03, 52.01, 52.03, 53.01, 53.02, 53.03, 54.01, 54.03,	4	N	1000*	9999*
88	FEAT_COD_S	Subtype Feature code	07	4	N	7100	9999
89	FEAT_DESC	Feature description	07	*	L		
90	FEAT_ID	Feature ID	19, 44, 50, 54.01	10	N	1	2 ³² -1
91	FEAT_ID_FT	Feature ID for from/to backpointers	54.03	10	N	1	2 ³² -1
92	FEAT_NAME	Feature name	07	40	L		
93	FIELD_DESC	Field description	03	*	L		
94	FIELD_SIZE	Field length	03	2	N	0	99
95	FNODE_ID	From Node ID	24	10	N	1	2 ³² -1
96	FLD_NAME	Field name	03, 04	10	G		
97	FROLE_NAME	Feature role name	09	40	L		
98	FROLE_NUM	Feature role	09, 50	2	N	1	99
99	FROM_ID	From ID	52.01, 54.01	10	N	1	2 ³² -1

No.	Field name	Description	Records	Size	Type	Minimum	Maximum
100	FST_PAGE	From page	14.09	5	N	1	99999
101	GEOID_ID	Geoid description ID	16.06, 65	10	N	1	$2^{32}-1$
102	GEOID_UND	Ellipsoid height	65	5	I	-9999	9999
103	GEO_AREA	Area name	02.05, 08, 16.01	*	L		
104	GEO_CAT	Geometry/Topology Object Category	89.01	2	N	1	7
105	GEO_ID	Geometry/Topology Object Identifier	89.01	10	N	1	$2^{32}-1$
106	GEO_TYPE	Geometrical type	29, 53.03	1	N	0	4
107	GPL_STR_ID	Geopolitical structure ID	10	4	N	1	9999
108	GPL_STR_NM	Geopolitical structure name	10	40	L		
109	GPL_S_C_DC	Geopolitical structure component description	11	*	L		
110	GPL_S_C_ID	Geopolitical structure component identifier	10, 11	6	N	1	999999
111	GRID_CODE	Grid Code	64	2	A		
112	GRID_NAME	Grid Name	64	50	L		
113	GRID_ORI	Grid axes orientation	64	1	N	0	1
114	HELP_LAT	Help grid latitude	64	10	I	-90000000	90000000
115	HELP_LONG	Help grid longitude	64	10	I	-180000000	180000000
116	HMAG_INT	Horizontal magnetic intensity	66	5	I	0	99999
117	HOST_ID	Host identifier	14.09	5	N	1	99999
118	H_TYPE	Height ref. type	16.06	1	N	0	2
119	H1_COORD	Upper height	51.03, 52.03, 53.03	11	I	-2^{31}	$2^{31}-1$
120	H2_COORD	Upper height	51.03, 52.03, 53.03	11	I	-2^{31}	$2^{31}-1$
121	IDS1_NR	Intern'l Dataset ID	02.01	13	G		

No.	Field name	Description	Records	Size	Type	Minimum	Maximum
122	ID_SCOPE	ID scope level	41, 44, 50, 51.01, 51.03, 52.01, 52.03, 53.01, 53.02, 53.03, 54.01, 54.03,	1	A		
123	ID_SCOPE_P	ID scope level Attribute of Feature part(ner)	44, 50, 54.01, 54.03	1	A		
124	IMP_NR	Impression number	14.06	20	G		
125	INT_ID	Internal Section Feature identifier	46	10	N	1	$2^{32}-1$
126	INT_FROM	From position of polyline interval	52.03, 53.03	5	N	1	99999
127	INT_F_CAT	Internal Feature type	46	2	N	1	4
128	ISBN	ISBN of document	14.02	13	G		
129	ISSN	ISSN of document	14.02	10	G		
130	LAN_CODE	language code	01.02, 02.01, 02.02, 02.04, 05, 07, 09, 11, 13, 14.02, 14.04, 14.05, 18; 41	3	A		
131	LAY_ID	Layer ID	06, 08, 10, 11, 17, 41, 44, 45, 46, 50	10	N	0*	$2^{32}-1$
132	LAY_TOPOLOGY	Layer Topology	17	1	N	1	3
133	LCL_IN_COD	Local In Code	01.02	2	L		
134	LCL_OT_COD	Local Out Code	01.02	2	L		
135	LEV_CODE	Height level code	62	2	A		
136	LEV_CODE_A	Adjacent Height level code	62	2	A		
137	LEV_NAME	Height level name	62	50	L		
138	LEV_NAME_A	Adjacent Height level name	62	50	L		
139	LIGHT_VAL	Light value of bounded area	29, 53.03	3	N	0	255

No.	Field name	Description	Records	Size	Type	Minimum	Maximum
140	LINE_ID	Line Feature ID	24, 51.01, 52.01, 52.03	10	N	1	$2^{32}-1$
141	LN_CNT_DIR	Direction for the counting of lanes	16.02	1	N	0	1
142	LST_PAGE	To page	14.09	5	N	1	99999
143	L_FACE_ID	Left Face identifier	24	10	N	1	$2^{32}-1$
144	LOCAL_NM	Local administrative area name	11	40	L		
145	MAGN_ID	Declination desc. ID	16.05, 66	10	N	1	$2^{32}-1$
146	MANDATRY	Mandatory indicator	09	1	N	0	1
147	MAP_SCALE	Map scale	14.04	7	N	1	9999999
148	MAX_LEVEL	Maximum no. of hierarchical Feature levels	07	2	N	1	99
150	MAX_VAL	Max. allowed value	03	20	I	-2^{63}	$2^{63}-1$
151	MDAT_DATE	Album metadata creation date	01.03	8	N	10000101	99991231
154	MIN_VAL	Min. allowed value	03	20	I	-2^{63}	$2^{63}-1$
155	NATGRID_ID	Grid description ID	16.05, 64	10	N	1	$2^{32}-1$
156	NODE_ID	Node identifier	22, 23, 25, 51.01	10	N	1	$2^{32}-1$
157	NORTH_LAT	North bound latitude	08	7	I	-90000	90000
158	NO_DATA	No data value	03	3	G		
159	NUM_AREA	Number of Area Features	24, 29	10	N	0	$2^{32}-1$
160	NUM_ATT	Number of Attributes or Attribute sets	41, 44, 50, 51.01, 51.03, 52.01, 52.03, 53.01, 53.02, 53.03, 54.01, 54.03, 89.03	5	N	0*	99999
161	NUM_ATT_BP	Number of Attribute back pointers	10, 11, 41, 45	10	N	0	$2^{32}-1$
162	NUM_ATT_P	Number of Attribute sets per part(ner)	50, 54.01, 54.03	5	N	0	99999

No.	Field name	Description	Records	Size	Type	Minimum	Maximum
163	NUM_BP_FT	Number of reverse pointer Features	54.01	10	N	0	$2^{32}-1$
164	NUM_CNTRY	Number of countries	02.01, 14.02	3	N	0	999
165	NUM_COMP	Number of components	10	2	N	1	99
166	NUM_COMPLX	Number of Complex Features	51.01, 51.03, 52.01, 52.03, 53.01, 53.02, 53.03, 54.01, 54.03,	10	N	0	$2^{32}-1$
167	NUM_CONV	Number of conversion records	51.01, 51.03, 52.01, 52.03, 53.01, 53.02, 53.03, 54.01, 54.03,	10	N	0	$2^{32}-1$
168	NUM_COORD	Number of coordinates tuples	22, 23, 52.03, 53.03	5	N	1*	99999
169	NUM_DASET	Number of Datasets	01.01, 01.03, 01.04	2	N	1	99
170	NUM_DOC	Number of sources	16.04	2	N	0	99
171	NUM_EDGE	Number of Edges	29, 52.01, 53.02	10	N	0*	$2^{32}-1$
172	NUM_EDG_BP	Number of Edge backpointers	22, 23, 25	10	N	0	$2^{32}-1$
173	NUM_EXTGEO	Number flagging the presence of Extended area geometry information	29, 53.03	1	N	0	1
174	NUM_FACE	Number of Faces	53.01	10	N	0	$2^{32}-1$
175	NUM_FEAT	Number of Features	15, 18, 19, 44, 46, 50	5	N	0*	99999
176	NUM_FEAT_C	Number of Feature Class candidates	09	2	N	1	99
177	NUM_FIELD	Number of fields	04, 16.05, 16.06	2	N	0*	99
178	NUM_FUL	Number of full predecessors	11	2	N	0	99

No.	Field name	Description	Records	Size	Type	Minimum	Maximum
179	NUM_H1	Number of H1 coordinates	51.03	1	N	0	1
180	NUM_IMM	Number of immediate parents	11	2	N	1	99
181	NUM_INTVAL	Number of coordinate intervals	52.03, 53.03	5	N	0	99999
182	NUM_LAN	Number of languages	01.02, 02.01, 14.02	3	N	0	999
183	NUM_LEV	Number of adjacent orthometric levels	62	2	N	0	99
184	NUM_LINE	Number of Line Features	24, 51.01	10	N	0	$2^{32}-1$
185	NUM_NAME	Number of names	05, 07, 09, 11	2	N	1	99
186	NUM_NODE	Number of Nodes	22, 23	10	N	0	$2^{32}-1$
187	NUM_PAR	Number of parameter sets	63	2	N	1	3
188	NUM_PARTS	Number of Feature parts	54.01, 54.03	5	N	0	99999
189	NUM_POINT	Number of Point Features	25	10	N	0	$2^{32}-1$
190	NUM_REC	Number of records	14.01	5	N	0	99999
191	NUM_REL	Number of Relationships	44, 50, 51.01, 51.03, 52.01, 52.03, 53.01, 53.02, 53.03, 54.01, 54.03,	10	N	0	$2^{32}-1$
192	NUM_ROLE	Number of Roles	09	2	N	2	99
193	NUM_SECT	Number of Sections	19	5	N	0	99999
194	NUM_SUBT	Number of subtypes	07	3	N	0	999
195	NUM_TEXT	Number of Text Records	44	10	N	0	$2^{32}-1$
196	NUM_THEM	Number of themes	17	2	N	1	99
197	NUM_TIME	Number of T coordinate tuples	51.03, 52.03, 53.03	1	N	0	1
198	NUM_Z	Number of Z coordinates	51.03	1	N	0	1
199	NW_COMPL	Network completeness level	19	1	N	0	9

No.	Field name	Description	Records	Size	Type	Minimum	Maximum
200	NW_DESC	Network completeness description	19	*	L		
201	NW_ID	Network Identifier	16.03, 19, 51.01, 51.03, 52.01, 52.03, 53.01, 53.02, 53.03, 54.01, 54.03,	5	N	1	99999
202	OBJ_CAT	Object Category	89.02, 89.03	2	N	1	10
203	OBJ_CODE	Object Class Code	89.02, 89.03	4	N	1	9999
204	OBJ_ID	Object Identifier	89.02, 89.03	10	N	1	$2^{32}-1$
205	OBJREF	Object Reference Value	83	*	*		
206	OBJREF_ID	Object Reference Identifier	83	10	N	1	$2^{32}-1$
207	OBJREF_LEN	Object Reference Length	83	5	N	1	99999
208	OBJREF_TYP	Object Reference Type	83	1	A		
209	ORG_CODE	Country Code	01.02	3	A		
210	ORG_NAME	Organisation name	01.03	40	L		
211	ORG_NAM_SH	Short Organisation name	01.01	18	L		
212	ORIENT	Orientation	29, 53.02	1	N	0	1
213	OUT_LENGTH	Outline length of bounded area	29, 53.03	10	N	0	$2^{32}-1$
214	P_CYCLE	Product Cycle	89.01, 89.02, 89.03	2	N	0	99
215	PAR_ID	Parent description ID	14.01	5	N	1	99999
216	PAR_IMM_ID	Immediate parent identification	11	6	N	1	999999
217	PAR_LAT	Latitude parameter	63	10	I	-90000000	90000000
218	PAR_LONG	Longitude parameter	63	10	I	-180000000	180000000
219	POINT_ID	Point ID	25, 51.01, 51.03	10	N	1	$2^{32}-1$

No.	Field name	Description	Records	Size	Type	Minimum	Maximum
220	POINT_NAME	Point name	16.08, 16.09	20	L		
221	POS_NEG	Orientation	52.01	2	N	0	1
222	PRE_FUL_ID	Lowest full predecessor identification	11	6	N	1	999999
223	PROD_NAME	Producer name	02.04	*	L		
224	PROD_PLACE	Production place	02.04	50	L		
225	PROJEC_ID	Projection ID	16.05, 63	10	N	1	$2^{32}-1$
226	PROJ_CODE	Projection type code	63	2	A		
227	PUB_NAME	Name of publisher	14.07	*	L		
228	PUB_PLACE	Place of publication	14.07	50	L		
229	PUB_YEAR	Year of publication	14.07	4	N	1000	9999

No.	Field name	Description	Records	Size	Type	Minimum	Maximum
230	REC_CODE	Record subtype code	01.01, 01.02, 01.03, 01.04, 02.01, 02.02, 02.03, 02.04, 02.05, 02.06, 02.07, 04, 06, 14.01, 14.02, 14.03, 14.04, 14.05, 14.06, 14.07, 14.08, 14.09, 14.10, 16.01, 16.02, 16.03, 16.04, 16.05, 16.06, 16.07, 16.08, 16.09, 16.10, 51.01, 51.03, 52.01, 52.03, 53.01, 53.02, 53.03, 54.01, 54.03, 89.01, 89.02, 89.03	2	N	1*	99*

No.	Field name	Description	Records	Size	Type	Minimum	Maximum
231	REC_DESCR	Record type code	01.01, 01.02, 01.03, 01.04, 02.01, 02.02, 02.03, 02.04, 02.05, 02.06, 02.07, 03, 04, 05, 06, 07, 08, 09, 10, 11, 13, 14.01, 14.02, 14.03, 14.04, 14.05, 14.06, 14.07, 14.08, 14.09, 14.10, 15, 16.01, 16.02, 16.03, 16.04, 16.05, 16.06, 16.07, 16.08, 16.09, 16.10, 17, 18, 19, 22, 23, 24, 25, 29, 41, 44, 45, 46, 50, 51.01, 51.03, 52.01, 52.03, 53.01, 53.02, 53.03, 54.01, 54.03, 61, 62, 63, 64, 65, 66, 83, 89.01, 89.02, 89.03, 90, 99	2	N	0*	99*
232	REC_ID	Record identifier	14.01	10	N	1	2 ³² -1
233	REC_NAME	Record name	04	10	G		
234	REC_QTY	Number of records	06	8	N	0	99999999

No.	Field name	Description	Records	Size	Type	Minimum	Maximum
235	REC_SUBTYPE	Record subtype	14.01	2	N	1	99
236	REC_TYPE	Record type code	04, 06, 14.01, 83	2	N	1	99
237	REF_DATE	Reference date	02.01	8	N	10000101	99991231
238	REF_LAT	Reference point, latitude	65, 66	10	I	-90000000	90000000
239	REF_LONG	Reference point, longitude	65, 66	10	I	-180000000	180000000
240	REF_REC_ID	Record ID of referenced Record	83	10	N	1	$2^{32}-1$
241	REF_TYPE	Reference Type	02.01	1	N	1	3
242	REL_CODE	Relationship Type Code	09, 50	4	N	1000	9999
243	REL_DESC	Relationship Type description	09	*	L		
244	REL_ID	Relationship ID	44, 50, 51.01, 51.03, 52.01, 52.03, 53.01, 53.02, 53.03, 54.01, 54.03,	10	N	1	$2^{32}-1$
245	REL_KIND	Kind of Relationship	14.09	2	N	11	16
246	REL_NAME	Name of Relationship	09	40	L		
247	REPEAT	Repeat indicator	04, 09	1	N	0	9
248	ROLE_CODE	Function of the Album	01.03	2	N	1	11
249	ROT_GRID	Grid rotation	64	10	I	0	400000000
250	ROT_Z	Z-rotation	61	9	I	0	40000000
251	R_FACE_ID	Right Face identifier	24	10	N	1	$2^{32}-1$
252	SCALE_FAC	Point scale factor	61, 63	5	I	-9999	9999

No.	Field name	Description	Records	Size	Type	Minimum	Maximum
253	SECT_ID	Section ID	06, 08, 10, 11, 16.01, 16.02, 16.03, 16.04, 16.05, 16.06, 16.07, 16.08, 16.09, 16.10, 19, 41, 44, 45, 46, 50	10	N	0*	$2^{32}-1$
254	SECT_ID_F	Section ID of referenced Feature	19	10	N	0*	$2^{32}-1$
255	SECT_SUBID	Sub Identifier of Section ID	16.08, 16.09	3	N	1	999
256	SEC_NAME	Dataset subtitle	02.03	*	L		
257	SEM_MAJOR	Semi-major axis	61	8	N	0	99999999
258	SEM_MINOR	Semi-minor axis	61	8	N	0	99999999
259	SIZE	Size of bounded area	29, 53.03	10	N	0	$2^{32}-1$
260	SLOPE	Slope of bounded area	29, ,53.03	3	N	0	999
261	SOUTH_LAT	South bound latitude	08	7	I	-90000	90000
262	SPATDOM_ID	Spatial domain identifier	08	10	N	1	$2^{32}-1$
263	SPLIT_IND	Split indicator	52.01, 52.03, 53.01, 53.02, 53.03	1	N	0	1
264	STAN_NAME	Data standard	01.01	10	G		
265	START_FDC	Start date FDC	14.10	8	N	10000101	99991231
266	STATUS	Status code	24, 25	2	N	1	5
267	SURV_DATE	Survey date	14.02	6	N	1	123123
268	SURV_YEAR	Survey year	14.02	4	N	1000	9999
269	TEXT_ID	Text ID	41, 44	10	N	1	$2^{32}-1$
270	TEXT	Text	41	*	L		
271	THEM_COD	Feature Theme Code	02.06, 17	2	N	10	99
272	THEM_NAME	Feature Theme Name	02.06	*	G		
273	TIME_DOM	Time domain desc.	45	*	G		

No.	Field name	Description	Records	Size	Type	Minimum	Maximum
274	TIME_ID	Time domain rec. ID	45	10	N	1	$2^{32}-1$
275	TIME_MASK	Time mask	51.03, 52.03, 53.03	2	N	1	16
276	TNODE_ID	To Node ID	24	10	N	1	$2^{32}-1$
277	TOT_VOL	Number of volumes	01.01, 01.04,	4	N	1	9999
278	TO_ID	To ID	52.01, 54.01	10	N	1	$2^{32}-1$
279	TRANS_H	Height difference	62	5	I	-9999	9999
280	TRANS_X	X-origin	61	5	I	-9999	9999
281	TRANS_Y	Y-origin	61	5	I	-9999	9999
282	TRANS_Z	Z-origin	61	5	I	-9999	9999
283	T_SA_COORD	Start appearance coordinate	51.03, 52.03, 53.03	10	N	1000010100	9999123123
284	T_EA_COORD	End appearance coordinate	51.03, 52.03, 53.03	10	N	1000010100	9999123123
285	T_SD_COORD	Start disappearance coordinate	51.03, 52.03, 53.03	10	N	1000010100	9999123123
286	T_ED_COORD	End disappearance coordinate	51.03, 52.03, 53.03	10	N	1000010100	9999123123
287	UNIT_EXP	Exponent multiplier	03	2	I	-9	9
288	UNIT_SYSTEM	Default Unit System	02.01, 02.01	1	N	1	2
289	UNIT_TYPE	Data unit type	03	1	N	0	1
290	UPD_ATT_ID	Object Attribute update identification	89.03	10	N	1	$2^{32}-1$
291	UPD_GEO_ID	Geo-topo update identification	89.01	10	N	1	$2^{32}-1$
292	UPD_OBJ_ID	Object update identification	89.02	10	N	1	$2^{32}-1$
293	VAL_DESC	Value Code description	18	*	L		
294	VAL_SIZE	Maximum Attribute Value Width	05	2	N	1	11
295	VAL_TYPE	Attribute Value Data Type	05	2	A		

No.	Field name	Description	Records	Size	Type	Minimum	Maximum
296	VERDAT_ID	Vertical datum desc.	16.06, 62	10	N	1	$2^{32}-1$
297	VERSION	Version number	01.01	4	G		
298	VMAG_INT	Vert. Magn. Intensity	66	5	I	0	99999
299	VOLENDTEXT	Volume termination comments	99	77	L		
300	VOL_ID	Volume identifier	01.04, 06	4	N	1	9999
301	VOL_ID_S	Start volume identifier	01.03, 01.04, 06	4	N	1	9999
302	VOL_NAME	Volume name	14.05	*	L		
303	VOL_SIZE	Volume size	01.04	20	N	640	$10^{20}-1$
304	WEST_LONG	West bound longitude	08	7	I	-180000	180000
305	XY_ACC_LEV	Horizontal accuracy level	17	5	N	0	99999
307	XY_AL_DESC	Horizontal accuracy level description	17	40	L		
308	XY_CONFAC	XY mult. Factor	16.07	2	I	-9	9
309	XY_RES	XY resolution	02.07, 16.02, 17	3	N	0	999
310	X_COORD	X coordinate	16.09, 22, 23, 51.03, 52.03, 53.03	11	I	-2^{31}	$2^{31}-1$
311	X_DIG	Digitized X coord.	16.08	12	I	$-(10^{11}-1)$	$10^{11}-1$
312	X_MAX	Maximum X value	16.07	11	I	-2^{31}	$2^{31}-1$
313	X_MIN	Minimum X value	16.07	11	I	-2^{31}	$2^{31}-1$
314	X_OFFSET	X offset	16.07	11	I	-2^{31}	$2^{31}-1$
315	X_ORIG	X origin	64	10	I	$-(10^9-1)$	10^9-1
316	X_SURV	Surveyed X coord.	16.08	12	I	$-(10^{11}-1)$	$10^{11}-1$
317	Y_COORD	Y coordinate	16.09, 22, 23, 51.03, 52.03, 52.03, 53.03	11	I	-2^{31}	$2^{31}-1$
318	Y_DIG	Digitized Y coord.	16.08	12	I	$-(10^{11}-1)$	$10^{11}-1$
319	Y_MAX	Maximum Y value	16.07	11	I	-2^{31}	$2^{31}-1$
320	Y_MIN	Minimum Y value	16.07	11	I	-2^{31}	$2^{31}-1$

No.	Field name	Description	Records	Size	Type	Minimum	Maximum
321	Y_OFFSET	Y offset	16.07	11	I	-2^{31}	$2^{31}-1$
322	Y_ORIG	Y origin	64	10	I	$-(10^9-1)$	10^9-1
323	Y_SURV	Surveyed Y coord.	16.08	12	I	$-(10^{11}-1)$	$10^{11}-1$
324	Z_ACC_LEV	Vertical accuracy level	17	5	N	0	99999
325	Z_AL_DESC	Vertical accuracy level description	17	40	L		
326	Z_CONFAC	Z mult. Factor	16.07	2	I	-9	9
327	Z_COORD	Z coordinate	23, 51.03, 53.03	11	I	-2^{31}	$2^{31}-1$
328	Z_DIG	Digitized Z coord.	16.09	11	I	-2^{31}	$2^{31}-1$
329	Z_OFFSET	Z offset	16.07	11	I	-2^{31}	$2^{31}-1$
330	Z_REF	Z referencing method	17	1	N	0	3
331	Z_SURV	Surveyed Z coord.	16.09	11	I	-2^{31}	$2^{31}-1$

12.3 Additional Constraints for Topological Features

12.3.1 Order of multiple Coordinate tuples in Coordinate Records

The coordinate tuples stored in Coordinate records (either 2D coordinates records or 3D coordinate records) together form a List. This means that the order in which they are stored is significant, i.e. representing the direction of the corresponding Edge. The coordinate list shall be ordered in such a way that within the Edge definition the first vertex is preceded by the coordinate tuple of the start Node (exclusive to the coordinate list at hand) and the last vertex succeeded by the coordinate tuple of the end Node (exclusive to the coordinate list at hand).

12.3.2 Order of Edges in Line Features, Area Features and Faces

Within a Line Feature, Edges shall be listed in consecutive order. Edges describing the boundary of an Area Feature or a Face, respectively, shall be (consecutively) ordered in clockwise orientation (i.e. the Area Feature/Face is situated on the right side of the boundary line). Consequently enclaves shall be described counterclockwise.

12.3.3 Order of Features in Relationship Records

The physical order of Features in a Relationship shall reflect the specified sequence (numbering) of roles, and (if applicable and specified for a given Relationship Type) the conceptual ordering of Features per role. For the Relationship Types defined in GDF, see Clause A.3.1 for the role numbers.

12.3.4 Order of Features in Relationship Records

The physical order of Features in a Complex Feature assembly shall reflect (if applicable and specified for a given Complex Feature class) the conceptual ordering of Features.

12.4 Additional Constraints for Non-Explicit Topological Features: Order of Coordinate triplets in Feature Records

When Features are defined in a non-explicit topological way, their geometrical definition has the form of coordinate tuples defined in the Feature record, comprising X and Y, and possibly Z, H1, H2, and T coordinates. In the case of Line and Area Features the order with which these tuples appear in the Feature Record is significant. In the case of Line Features only the fact that the tuples appear ordered is significant. The direction of the order is not significant. In the case of Area Features also the direction of the ordering is significant. The Area Feature (and thus the underlying polygon) is defined to be on the right side of the directed set of coordinate tuples (clockwise orientation). In this way it becomes possible to not only define simple areas but also areas containing enclaves (and exclaves).

12.5 Mandatory Records

Of all the Records of GDF, eight must appear at least once in each GDF file. These Records are:

Album header record	[01.01]
Album header record	[01.03]
Dataset header record	[02.01]
Dataset header record	[02.02]
Layer header	[17]
Section header record	[16.01]
Section header record	[16.07]
Volume termination record	[99]

Each Dataset, declared by a set of Dataset header records, has to include at least one Layer (header). Each Layer, declared by a Layer header record, has to include at least one Section (header).

12.6 Record Format Specifications: Global Records

NOTE 1 A vertical bar to the left of a field name indicates that the field is part of a repeating group of fields.

NOTE 2 The character "*" is used in the documentation of field size to indicate a field of variable length. Electronically, fields of variable length are indicated by a numeric value of "0", but printed record layouts in this standard will show "*".

12.6.1 Album Header Record [ALHDREC]

12.6.1.1 Album Header Intro Subrecord [ALHDREC.01]

Field name	Size	Type	No data	Min.	Max.	Description
REC_DESCR	2	N	Obl			Record Type Code (01)
REC_CODE	2	N	Obl			Record Subtype Code (01)
ORG_NAM_SH	18	L ⁶	<S>			Short Organisation Name: Name of the producer or deliverer of this album
STAN_NAME	10	G	Obl			Standard Name to which this ⁷ album conforms
VERSION	4	G	Obl			Version Number of the standard to which this album conforms ⁸
CHAR_SET	2	N	1	1	30	Default Character Set applicable to whole GDF 1 = ISO 8859-1 (Latin-1) 2 = ISO 8859-2 (Latin-2) 3 = ISO 8859-3 (Latin-3) 4 = ISO 8859-4 (Latin-4) 5 = ISO 8859-5 (Cyrillic) 6 = ISO 8859-6 (Arabic) 7 = ISO 8859-7 (Greek) 8 = ISO 8859-8 (Hebrew) 9 = ISO 8859-9 (Latin-5) 10 = ISO 8859-10 (Latin-6) 11 = ISO 8859-11 (Thai) 12 = reserved/not used 13 = ISO 8859-13 (Latin-7) 14 = ISO 8859-14 (Latin-8) 15 = ISO 8859-15 (Latin-9) 16 = ISO 8859-16 (Latin-10) 17 ~ 29 = reserved for future use 30 = ISO/IEC 10646 Annex D (Unicode - UTF-8)
ALB_SIZE	20	N	<S>	640	10 ²⁰ -1	Album Size in bytes
ALBUM_ID	10	N	Obl	1	2 ³² -1	A unique Album Identifier

NOTE The exact meaning of the data types (N, A, G, etc.) can be found in the Metadata Catalogue. (see 10.3.2.4)

⁶ Note that the (local) character set applicable to this field is declared by a different sub-record of the Album Header and may differ from the general default character.

⁷ The name of this International Standard is "GDF"

⁸ The version number is "5.0"

12.6.1.2 Local Character Set Definition Subrecord [ALHDREC.02]

Field name	Size	Type	No data	Min.	Max.	Description
REC_DESCR	2	N	Obl			Record Type Code (01)
REC_CODE	2	N	Obl			Record Subtype Code (02)
LCL_IN_COD ⁹	2	L	<S>			Local In Code. By not specifying this field, the local character set at hand becomes the default character set for Fields of type L (overruling the general default character set). Only one default character set may be declared; for any other local character set a Local In Code must be provided.
LCL_OT_COD ¹⁰	2	L	<S>			Local Out Code. By not specifying this field, the local character set at hand becomes the default character set for Fields of type L (overruling the general default character set). Only one default character set may be declared; for any other local character set a Local In Code must be provided.
CHAR_SET	2	N	Obl	1	99	Local Character Set applicable to Fields of Type L. 1 = ISO 8859-1 (Latin-1) 2 = ISO 8859-2 (Latin-2) 3 = ISO 8859-3 (Latin-3) 4 = ISO 8859-4 (Latin-4) 5 = ISO 8859-5 (Cyrillic) 6 = ISO 8859-6 (Arabic) 7 = ISO 8859-7 (Greek) 8 = ISO 8859-8 (Hebrew) 9 = ISO 8859-9 (Latin-5) 10 = ISO 8859-10 (Latin-6) 11 = ISO 8859-11 (Thai) 12 = reserved/not used 13 = ISO 8859-13 (Latin-7) 14 = ISO 8859-14 (Latin-8) 15 = ISO 8859-15 (Latin-9) 16 = ISO 8859-16 (Latin-10) 17 ~ 29 = reserved for future use 30 = ISO/IEC 10646 Annex D (Unicode - UTF-8) 31 = ISO/IEC 10646 (Unicode - UCS-2) 32 = ISO/IEC 10646 (Unicode - UCS-2, big endian) 33 ~ 49 = reserved for future use 50 = Shift-JIS (Japanese) 51 = KS X 1001 (Korean) 52 ~ 99 = reserved for the User Defined
ORG_CODE	3	A	<S>			Organisation Information (ISO 3166 alpha-3 country code)
CHAR_TBL	20	G	<S>			Character Set Code Table name
CHAR_VER	10	G	<S>			Character Set Code Table Version Number
NUM_LAN	3	N	Obl	0	999	Number of languages

⁹ The Local In Code is to be composed using the general default character set. The use of the Local In Code supposes that the first character of this code is not used for any other purpose in regular text.

¹⁰ The Local Out Code is to be composed using the general default character set. The use of the Local Out Code supposes that the code is not used for any other purpose within the Local Character Set.

LAN_CODE	3	A	Obl			Character Set Language: The ISO 639-2 language code of a language applying to the specified Character Set Code Table
COLL_SEQ	3	A	<S>			Collating Sequence: Designation of collating sequence by means of ISO 639-2 language code.

12.6.1.3 Global Album Information Subrecord [ALHDREC.03]

Field name	Size	Type	No data	Min.	Max.	Description
REC_DESCR	2	N	Obl			Record Type Code (01)
REC_CODE	2	N	Obl			Record Subtype Code (03)
ALBUM_ID	10	N	Obl	1	2 ³² -1	A unique Album Identifier ¹¹
ORG_NAME	40	L	Obl			Organization Name: Name of the producer or deliverer of this album
ROLE_CODE	2	N	Obl	1	11	Function performed by the main producer and/or deliverer of this album. 1 : resource provider 2 : custodian 3 : owner 4 : user 5 : distributor 6 : originator 7 : point of contact 8 : principal investigator 9 : processor 10 : publisher 11 : author
CREA_DATE	8	N	<S>	10000101	99991231	Creation Date of this album(YYYYMMDD)
MDAT_DATE	8	N	Obl	10000101	99991231	Date of creation of the metadata for this album (YYYYMMDD).
NUM_DASET	2	N	Obl	1	99	Number of Datasets
DASET_ID	10	N	Obl	1	2 ³² -1	Dataset Identifier of a Dataset which is associated with this album
VOL_ID_S	4	N	Obl	1	9999	Start Volume Identifier of the volume which contains the Dataset Header.
CORI_DATE	8	N	<S>	10000101	99991231	Date of Copyright (YYYYMMDD)
CORI_OWNER	*	L	<S>			Copyright Owner: Name of the legal Person having the copyrights of album

¹¹ For a set of sub-records associated with the same album header, the ID has to be the same as the designated ALBUM_ID in "master" sub-record 01.01.

12.6.1.4 Volume Information Subrecord [ALHDREC.04]

Field name	Size	Type	No data	Min.	Max.	Description
REC_DESCR	2	N	Obl			Record Type Code (01)
REC_CODE	2	N	Obl			Record Subtype Code (04)
VOL_ID	4	N	Obl	1	9999	The sequence number of the present Volume serving as a unique Volume Identifier
VOL_SIZE	20	N	<S>	640	10 ²⁰ -1	Volume Size in bytes
TOT_VOL	4	N	<S>	1	9999	Number of Volumes in the album
NUM_DASET	2	N	Obl	1	99	Number of Datasets
DASET_ID	10	N	Obl	1	2 ³² -1	Dataset Identifier of a Dataset which is associated with this volume
VOL_ID_S	4	N	Obl	1	9999	Start Volume Identifier of the volume which contains the Dataset Header. This number may be the local Volume number

12.6.2 Dataset Header Record [DSHDREC]

12.6.2.1 Dataset Identification Subrecord [DSHDREC.01]

Field name	Size	Type	No data	Min.	Max.	Description
REC_DESCR	2	N	Obl			Record Type Code (02)
REC_CODE	2	N	Obl			Record Subtype Code (01)
DASET_ID	10	N	Obl	1	2 ³² -1	Supplier Dataset Identification Number, which is unique within the system of the producer (supplier) of this Dataset
IDSJ_NR	13	G	<S>			International Dataset Identification Number
ED_DATE	10	N	Obl	1000010100	9999123123	Edition Date and hour of this particular version of the Dataset which constitutes also a unique version number of the present version (YYYYMMDDHH)
REF_DATE	8	N	Obl	10000101	99991231	Reference date of the intellectual and logical content of this Dataset (YYYYMMDD)
REF_TYPE	1	N	Obl	1	3	Event used for the Dataset reference date 1 : Creation 2 : Publication 3 : Revision

DSET_TOPIC	2	N	Obl	1	19	Main theme of this Dataset ¹² 1 : farming 2 : biota 3 : boundaries 4 : climatology/meteorology/atmo sphere 5 : economy 6 : elevation 7 : environment 8 : geoscientific information 9 : health 10 : imagery base maps earth cover 11 : intelligenceMilitary 12 : inlandWaters 13 : location 14 : oceans 15 : planning cadastre 16 : society 17 : structure 18 : transportation 19 : utilities communication
UNIT_SYSTEM	1	N	1	1	2	Default unit system for a Dataset 1 : Metric 2 : English
NUM_LAN	3	N	Obl	0	999	Number of languages
LAN_CODE	3	A	Obl			Dataset Language: The ISO 639-2 language code of a language used in this Dataset
DEFAULTLAN	3	A	<S>			Default Language: The ISO 639-2 language code of a language used as the default language of character strings in this Dataset
NUM_CNTRY	3	N	Obl	0	999	Number of countries
CNT_CODE	3	A	Obl			The ISO 3166 alpha-3 code of a country involved in the production of this Dataset
ABSTRACT	*	L	Obl			Narrative summary of the content of the Dataset

¹² Most commonly the main theme applicable is 18 : transportation.

12.6.2.2 Dataset Main Title Subrecord [DSHDREC.02]

Field name	Size	Type	No data	Min.	Max.	Description
REC_DESCR	2	N	Obl			Record Type Code (02)
REC_CODE	2	N	Obl			Record Subtype Code (02)
DASET_ID	10	N	Obl	1	$2^{32}-1$	Supplier Dataset Identification Number, which is unique within the system of the producer (supplier) of this Dataset ¹³
DAST_SUBID	3	N	Obl	1	999	Sub Identifier of Supplier Dataset Identification Number which is unique among multiple occurrences of this subrecord in a given Dataset
LAN_CODE	3	A	<S>			Dataset Title Language: The ISO 639-2 language specified in the next field
DASET_NAME	*	L	Obl			Dataset Main Title

¹³ For a set of sub-records associated with the same dataset header, the ID has to be the same as the designated DASET_ID in “master” sub-record 02.01.

12.6.2.3 Dataset Subtitle Subrecord [DSHDREC.03]

Field name	Size	Type	No data	Min.	Max.	Description
REC_DESCR	2	N	Obl			Record Type Code (02)
REC_CODE	2	N	Obl			Record Subtype Code (03)
DASET_ID	10	N	Obl	1	$2^{32}-1$	Supplier Dataset Identification Number, which is unique within the system of the producer (supplier) of this Dataset ¹⁴
DAST_SUBID	3	N	Obl	1	999	Sub Identifier of Supplier Dataset Identification Number which is unique among multiple occurrences of this subrecord in a given Dataset
SEC_NAME	*	L	Obl			Dataset Subtitle in the same language as in Dataset Main Title

¹⁴ For a set of sub-records associated with the same dataset header, the ID has to be the same as the designated DASET_ID in "master" sub-record 02.01.

12.6.2.4 Dataset Producer Subrecord [DSHDREC.04]

Field name	Size	Type	No data	Min.	Max.	Description
REC_DESCR	2	N	Obl			Record Type Code (02)
REC_CODE	2	N	Obl			Record Subtype Code (04)
DASET_ID	10	N	Obl	1	$2^{32}-1$	Supplier Dataset Identification Number, which is unique within the system of the producer (supplier) of this Dataset ¹⁵
DAST_SUBID	3	N	Obl	1	999	Sub Identifier of Supplier Dataset Identification Number which is unique among multiple occurrences of this subrecord in a given Dataset
CNT_CODE	3	A	<S>			Production Country: The ISO 3166 alpha-3 country code of the country to which Production Place belongs
PROD_PLACE	50	L	<S>			Production Place
LAN_CODE	3	A	<S>			Producer Name Language: The ISO 639-2 language code of the Producer Name
PROD_NAME	*	L	<S>			Producer Name

NOTE The layout of this record assumes that at least one optional field will be specified.

¹⁵ For a set of sub-records associated with the same dataset header, the ID has to be the same as the designated DASET_ID in “master” sub-record 02.01.

12.6.2.5 Dataset Extensiveness & Currency Subrecord [DSHDREC.05]

Field name	Size	Type	No data	Min.	Max.	Description
REC_DESCR	2	N	Obl			Record Type Code (02)
REC_CODE	2	N	Obl			Record Subtype Code (05)
DASET_ID	10	N	Obl	1	$2^{32}-1$	Supplier Dataset Identification Number, which is unique within the system of the producer (supplier) of this Dataset ¹⁶
CREA_YEAR	4	N	<S>	1000	9999	Creation Year (YYYY)
GEO_AREA	*	L	<S>			Dataset Geographical coverage: An area name that is representative for the Dataset

NOTE The layout of this record assumes that at least one optional field will be specified.

¹⁶ For a set of sub-records associated with the same dataset header, the ID has to be the same as the designated DASET_ID in “master” sub-record 02.01.

12.6.2.6 Dataset Contents Subrecord [DSHDREC.06]

Field name	Size	Type	No data	Min.	Max.	Description
REC_DESCR	2	N	Obl			Record Type Code (02)
REC_CODE	2	N	Obl			Record Subtype Code (06)
DASET_ID	10	N	Obl	1	$2^{32}-1$	Supplier Dataset Identification Number, which is unique within the system of the producer (supplier) of this Dataset ¹⁷
DAST_SUBID	3	N	Obl	1	999	Sub Identifier of Supplier Dataset Identification Number which is unique among multiple occurrences of this subrecord in a given Dataset
THEM_COD	2	N	<S>	10	99	Feature Theme Code
THEM_NAME	*	G	<S>			Feature Theme Name: The name of a Feature Theme which is present in this Dataset

NOTE The layout of this record assumes that at least one optional field will be specified.

¹⁷ For a set of sub-records associated with the same dataset header, the ID has to be the same as the designated DASET_ID in “master” sub-record 02.01.

12.6.2.7 Dataset XY Resolution Subrecord [DSHDREC.07]

Field name	Size	Type	No data	Min.	Max.	Description
REC_DESCR	2	N	Obl			Record Type Code (02)
REC_CODE	2	N	Obl			Record Subtype Code (07)
DASET_ID	10	N	Obl	1	$2^{32}-1$	Supplier Dataset Identification Number, which is unique within the system of the producer (supplier) of this Dataset ¹⁸
XY_RES	3	N	Obl	0	999	Dataset XY Resolution: Worst case value in any part of the Dataset, expressed in meters

¹⁸ For a set of sub-records associated with the same dataset header, the ID has to be the same as the designated DASET_ID in “master” sub-record 02.01.

12.6.3 Field Definition Record [FIELDDEFREC]

Field name	Size	Type	No data	Min.	Max.	Description
REC_DESCR	2	N	Obl			Record Type Code (03)
FLD_NAME	10	G	Obl			Field Name: The name of the field which is specified in this record
FIELD_SIZE	2	N	Obl	0	99	Field Size: Length of the field which is specified The value 0 signifies a variable field length
DATA_TYPE	2	A	Obl			Data Type: The subset of the field may contain G = printable characters L = Local Characters A = alphabetic characters N = digits I = digits and + or - AN = alphabetic and numeric
UNIT_TYPE	1	N	Obl	0	1	Data Unit Type: Specifies either unit of measurement or GDF defined unit 0 = general unit of measurement 1 = GDF defined unit
DATA_UNIT	3	A	<S>			Data Unit: Code of the unit of measurement or GDF defined unit in which the data values are expressed. GDF defined units may include COD = Code list ENM = Enumeration CNT = Number BOL = Boolean BMR = Bit Mask Register (binary number as binary) BMI = Bit Mask Integer (binary number as decimal) TIM = Time PRC = Percentage CMP = Composite IDN = Identifier PRS = Signed Percentage
UNIT_EXP	2	I	<S>	-9	9	Unit Exponent: 10LOG of the multiplication factor with which the data values, expressed in the unit specified in DATA_UNIT, have to be multiplied.
NO_DATA	3	G	Obl			No Data: Value if no data is being provided Obl = Obligatory <S> = Space(s) {a valid value} = any value allowable for the data type assigned for the field in question, and within the valid value range in case of being data type N
MIN_VAL	20	I	<S>	-2 ⁶³	2 ⁶³ -1	Minimum Value Allowed
MAX_VAL	20	I	<S>	-2 ⁶³	2 ⁶³ -1	Maximum Value Allowed
DATA_USE	2	N	<S>	1	4	Field Class: Indication to which Field Class the field belongs: 1 = Entity 2 = Foreign Identifier 3 = Field Counter 4 = Other
FIELD_DESC	*	L	<S>			Field Description: Short explanation of the field which is specified

NOTE The character "*" is used in the Size column to indicate a field of variable length, for example FIELD_DESC. In this record, a numeric value of "0" for FIELD_SIZE indicates that the field is of variable length, but a printed record layout in this standard will show "**".

12.6.4 Record Definition Record [RECDEFREC]

Field name	Size	Type	No data	Min.	Max.	Description
REC_DESCR	2	N	Obl			Record Type Code (04)
REC_TYPE	2	N	Obl	01	99	Record Type Code: Code of the record type which is specified
REC_CODE	2	N	<S>	01	99	Record Subtype Code: A possible subtype code of the record type which is specified
REC_NAME	10	G	<S>			Record Name: Name of the record type which is specified in this record
NUM_FIELD	2	N	Obl	2	99	Number of fields
FLD_NAME	10	G	Obl			Field Name: A list of field names, for the record type in issue, in order
REPEAT	1	N	Obl	0	9	Repeating Field Level indicating how the field (field group) is nested. 0 = non repeating 1...9 = repeated field (group) nested within previous repeating field level
COMMENT	*	L	<S>			Record Type Description: Short indication of the content of the record type in issue

12.6.5 Feature Definition Record [FEATDEFREC]

Field name	Size	Type	No data	Min.	Max.	Description
REC_DESCR	2	N	Obl			Record Type Code (07)
FEAT_CODE	4	N	Obl	1000	9999	Feature Class Code: Four-digit code of the Feature Class
MAX_LEVEL	2	N	Obl	1	99	The maximum number of levels in the hierarchical tree according to which the hierarchical Features in the current Dataset are defined. In case of non-hierarchical Features this field shall contain the value 1.
NUM_NAME	2	N	Obl	1	99	Number of names associated with the Feature Class
LAN_CODE	3	A	<S>			Language Code: ISO 639-2 language code of the language used in the Feature Class Name
FEAT_NAME	40	L	Obl			Feature Class Name: name for the Feature Class
NUM_SUBT	3	N	Obl	0	999	The number of subtypes which have been defined for the current Feature Class. In case of non-hierarchical Features this number shall be zero.
FEAT_COD_S	4	N	Obl	7100	9999	Subtype Feature Class Code: Four-digit code of the child Feature Class (only applicable for hierarchical Feature definitions)
FEAT_DESC	*	L	<S>			Feature Description: Textual description of the current (parent) Feature Class which is specified

12.6.6 Attribute Definition Record [ATDEFREC]

Field name	Size	Type	No data	Min.	Max.	Description
REC_DESCR	2	N	Obl			Record Type Code (05)
ATT_TYPE	2	G	Obl			Attribute Type Code: The code of the Attribute type which is specified in this record
NUM_NAME	2	N	Obl	1	99	Number of names associated with the Attribute Type
LAN_CODE	3	A	<S>			Language Code: ISO 639-2 language code of the language used in the Attribute Type Name
ATT_NAME	40	L	Obl			Attribute Type Name: name for the Attribute type
VAL_TYPE	2	A	Obl			Attribute Value Data Type G = Printable characters A = Alphabetic characters N = Digits I = Digits and + or - AN = Alphabetic and numeric L = Local characters
VAL_SIZE	2	N	<S>	1	11	Maximum Attribute Value Width
ATT_D_TYPE	3	A	Obl			Attribute Data Type: Specifies applicable Data type of the Attribute type COD = Code List ENM = Enumeration CNT = Number BOL = Boolean BMR = Bit Mask Register (binary number as binary) BMI = Bit Mask Integer (binary number as decimal) TMR = Time Domain SCS = (Simple) Character String TXT = (Language-Coded) Text PRC = Percentage CMP = Composite IDN = Identifier GSD = Geopolitical Structure Definition PRS = Signed Percentage MSR = Measure

DATA_UNIT	3	A	<S>			Attribute Data Unit: Code of the unit of measure in which the data values are expressed. (only specified if ATT_D_TYPE is set to MSR). DEG = Degree* MTR = Metre* KMR = Kilometre INC = Inch FET = Feet MIL = Mile KGR = Kilogram* PND = Pound (US pound) KIP= Kilo Pound TON = Ton (metric ton) MIN = Minute (of time)* KPH = Kilometres per hour* MPH = Miles per hour In case Conversion Factor and conversion exponent are defined, DATA_UNIT must be from allowable set of Base Units (marked by *)
CONV_MAN	11	I	<S>	1	2 ³¹ -1	Base Unit Conversion Mantissa
CONV_EXP	2	I	<S>	-9	9	Exponent: 10LOG of the conversion factor with which the conversion mantissa, expressed in the base unit specified in DATA_UNIT, have to be multiplied.
AT_MIN_VAL	11	I	<S>	-2 ³¹	2 ³¹ -1	Minimum Value Allowed
AT_MAX_VAL	11	I	<S>	-2 ³¹	2 ³¹ -1	Maximum Value Allowed
ATT_DESC	*	L	<S>			Attribute Description: Textual description of the Attribute type which is specified

12.6.7 Attribute Value Definition Record [ATTVALREC]

Field name	Size	Type	No data	Min.	Max.	Description
REC_DESCR	2	N	Obl			Record Type Code (18)
ATT_TYPE	2	G	Obl			Attribute Type Code: The code of the Attribute which is specified in this record
NUM_FEAT	5	N	Obl	0	99999	Number of Features
FEAT_CODE	4	N	<S>	1000	9999	Feature Class Code: Four-digit code of the Feature Class
ATT_VAL	11	G	Obl			Value of an Attribute (allowable value code for Attribute type of data type COD or ENM)
LAN_CODE	3	A	<S>			ISO 639-2 Language Code of the Value Code Description
VAL_DESC	*	L	<S>			Value Code Description: Textual description of the specified value code

NOTE A usage of this record without mention of the FEAT_CODE field is the general mode, i.e. Feature Class independent and compatible with the previous version of this standard (apart from the additional NUM_FEAT field specifying a count of zero). See 10.3.6 for further descriptions.

12.6.8 Default Attribute Record [DATTVALREC]

Field name	Size	Type	No data	Min.	Max.	Description
REC_DESCR	2	N	Obl			Record Type Code (15)
ATT_TYPE	2	G	Obl			Attribute Type Code
NUM_FEAT	5	N	Obl	0	99999	Number of Features
FEAT_CODE	4	N	<S>	1000	9999	Feature Class Code: Four-digit code of the Feature Class
ATT_VAL	11	G	Obl			Default Attribute Value

NOTE 1 Although the SPACE character <S> is a legal value in the ATT_VAL *Field*, it does not mean that there is no information available for this metadata *Field*. It means that in the *Attribute* data of the given type, “not-collected / unknown” must be considered as the default case.

NOTE 2 A usage of this record without mention of the FEAT_CODE field is the general mode, i.e. Feature Class independent and compatible with the previous version of this standard (apart from the additional NUM_FEAT field specifying a count of zero). See 10.4.5.4 for further descriptions.

12.6.9 Relationship Definition Record [RELDEFREC]

Field name	Size	Type	No data	Min.	Max.	Description
REC_DESCR	2	N	Obl			Record Type Code (09)
REL_CODE	4	N	Obl	1000	9999	Relationship Type Code: four-digit Relationship Type Code
NUM_NAME	2	N	Obl	1	99	Number of names associated with the Relationship Type
LAN_CODE	3	A	<S>			Language Code: ISO 639-2 language code of the language used in the Relationship Type Name
REL_NAME	40	L	Obl			Relationship Type name: name of the Relationship Type
NUM_ROLE	2	N	Obl	2	99	Number of roles that are defined in this Relationship Type
FROLE_NUM	2	N	Obl	1	99	Declaration of the role, in terms of a role number (unique within the Relationship), that this Relationship partner (Feature) plays
FROLE_NAME	40	L	<S>			Name of the Feature role
NUM_FEAT_C	2	N	Obl	1	99	Number of Feature class candidates that can appear in the role at hand
FEAT_CODE	4	N	Obl	1000	9999	Feature class candidate(s) that can appears in the role at hand in this Relationship Type
REPEAT	1	N	Obl	0	1	Indication whether the presence of this role can repeat 0 = non-repeating 1 = repeating
MANDATRY	1	N	Obl	0	1	Indication whether the appearance of this role is mandatory 0 = non-mandatory 1 = mandatory
REL_DESC	*	L	<S>			A textual description of the Relationship Type specified

12.6.10 Geopolitical Structure Definition Record [GPLSTRDREC]

Field name	Size	Type	No data	Min.	Max.	Description
REC_DESCR	2	N	Obl			Record Type Code (10)
GPL_STR_ID	4	N	Obl	1	9999	Geopolitical Structure ID
GPL_STR_NM	40	L	<S>			Geopolitical Structure Name: A name for the Geopolitical Structure
NUM_COMP	2	N	Obl	1	99	Number of components participating in this Geopolitical Structure
GPL_S_C_ID	6	N	Obl	1	999999	Geopolitical Structure Component ID ¹⁹
NUM_ATT_BP	10	N	Obl	0	$2^{32}-1$	Number of Attribute back pointers
LAY_ID	10	N	Obl ²⁰	0	$2^{32}-1$	Layer Identifier: ID number of the Layer within which the Attribute referred to by the geopolitical structure definition resides.
SECT_ID	10	N	Obl ²¹	0	$2^{32}-1$	Section Identifier: ID number of the Section within which the Attribute referred to by the geopolitical structure definition resides.
ATT_ID	10	N	Obl	1	$2^{32}-1$	ATT_ID: Attribute which uses this Geopolitical Structure Definition

¹⁹ No order is implied by this repeating field; instead graph relations between Geopolitical Structure Components are established by means of Immediate Parent and Lowest Full Predecessor definitions in Geopolitical Structure Component Definition Record (Record Type Code 11).

²⁰ If the referred-to attribute resides on Dataset level, the Layer ID is not applicable and rendered as 'zero'.

²¹ If the referred-to attribute resides on Dataset or Layer level, the Section ID is not applicable and rendered as 'zero'.

12.6.11 Geopolitical Structure Component Definition Record [GPLCOMDREC]

Field name	Size	Type	No data	Min.	Max.	Description
REC_DESCR	2	N	Obl			Record Type Code (11)
GPL_S_C_ID	6	N	Obl	1	999999	Geopolitical Structure Component ID
FEAT_CODE	4	N	Obl	1100	3199	Feature Class Code: Four-digit Feature Class Code of the Administrative Area Feature or Named Area which is part of the specified Geopolitical Structure ²²
NUM_NAME	2	N	Obl	1	99	Number of names associated with the Administrative Area or Named Area in the structure
LAN_CODE	3	A	<S>			Language Code: ISO 639-2 language code of the language used to name the Administrative Area or Named Area
LOCAL_NM	40	L	Obl			Administrative Area or Named Area Name: The local name of the Administrative Area or Named Area in the specified language
NUM_IMM	2	N	Obl	0	99	Number of Immediate Parent Geopolitical Structure Components ²³
PAR_IMM_ID	6	N	<S>	1	999999	Immediate parent Geopolitical Structure Component
NUM_FUL	2	N	Obl	0	99	Number of full predecessor Geopolitical Structure Component ²⁴
PRE_FUL_ID	6	N	<S>	1	999999	Lowest full predecessor Geopolitical Structure Component
GPL_S_C_DC	*	L	<S>			Geopolitical Structure Component Description: An informative description of the characteristics of this component
NUM_ATT_BP	10	N	Obl	0	$2^{32}-1$	Number of Attribute back pointers
LAY_ID	10	N	Obl ²⁵	0	$2^{32}-1$	Layer Identifier: ID number of the Layer within which the Attribute referred to by the geopolitical structure component definition resides.
SECT_ID	10	N	Obl ²⁶	0	$2^{32}-1$	Section Identifier: ID number of the Section within which the Attribute referred to by the geopolitical structure component definition resides.

²² Min/max boundary of allowable ranges is targeting feature codes from the Admin Area and Named Area Feature Themes (11xx, 31xx), excluding 1200.....3099.

²³ NUM_IMM is only allowed to be zero if the actual Geopolitical Structure Component is the root of the Geopolitical Structure Definition and thus does not have a parent.

²⁴ If the set of immediate parents and the set of full predecessors is identical, the counter for the full predecessors can be set to zero (i.e. repetition of the component IDs is not necessary).

²⁵ If the referred-to attribute resides on Dataset level, the Layer ID is not applicable and rendered as 'zero'.

²⁶ If the referred-to attribute resides on Dataset or Layer level, the Section ID is not applicable and rendered as 'zero'.

ATT_ID	10	N	Obl	1	$2^{32}-1$	ATT_ID: Attribute which uses this Geopolitical Structure Component Definition
--------	----	---	-----	---	------------	---

12.6.12 Spatial Domain Record [SPADOREC]

Field name	Size	Type	No data	Min.	Max.	Description
REC_DESCR	2	N	Obl			Record Type Code (08)
SPATDOM_ID	10	N	Obl	1	$2^{32}-1$	Spatial Domain Identifier, which is unique within the Dataset
LAY_ID	10	N	Obl	1	$2^{32}-1$	Layer Identifier: ID-number of the Layer that contains the Section specified in the next field
SECT_ID	10	N	Obl	1	$2^{32}-1$	Section Identification Number: The ID-number of the Section of which the spatial domain is specified in this record
NORTH_LAT	7	I	<S>	-90000	90000	North Bound Latitude: Most northern latitude value of the Section, in millidegrees
SOUTH_LAT	7	I	<S>	-90000	90000	South Bound Latitude: Most southern latitude value in the Section, in millidegrees
WEST_LONG	7	I	<S>	-180000	180000	West Bound Longitude: Most western longitude value of the Section in millidegrees
EAST_LONG	7	I	<S>	-180000	180000	East Bound Longitude: Most eastern longitude value of the Section in millidegrees
GEO_AREA	*	L	<S>			Area Name: A characteristic topographical name of the Section

NOTE The layout of this record assumes that at least one optional field will be specified.

12.6.13 Directory Record [DIREC]

Field name	Size	Type	No data	Min.	Max.	Description
REC_DESCR	2	N	Obl			Record Type Code (06)
DIR_ID	10	N	Obl	1	$2^{32}-1$	Directory Identifier, which is unique within the Dataset
VOL_ID	4	N	Obl	1	9999	Volume Identifier: The identification number of the volume that contains the Layer specified in Layer Identifier
LAY_ID	10	N	<S>	1	$2^{32}-1$	Layer Identifier: Identification number of the Layer that contains the Sections specified in the next field
SECT_ID	10	N	<S>	1	$2^{32}-1$	Section Identification Number: The identification number of the Section containing the records which are specified in the next fields
REC_TYPE	2	N	Obl	1	99	Record Type Code: Code of the record type of which the amount is specified in Record Quantity
REC_CODE	2	N	<S>	1	99	Record Subtype Code: Code of the record sub-type of which the amount is specified in Record Quantity
REC_QTY	8	N	<S>	0	99999999	Record Quantity: Number of occurrences of the logical record type mentioned in Record Type Code

12.6.14 Abbreviation Record [ABBRREC]

Field name	Size	Type	No data	Min.	Max.	Description
REC_DESCR	2	N	Obl			Record Type Code (13)
LAN_CODE	3	A	Obl			Language Code: ISO 639-2 language code for which the abbreviation applies
ABBR_SHORT	20	L	Obl			Abbreviation Short: the abbreviation of the abbreviated term
ABBR_LONG	50	L	Obl			Abbreviation Long: the full version of the abbreviated term

12.6.15 Network Specification Record [NWSPECSREC]

Field name	Size	Type	No data	Min.	Max.	Description
REC_DESCR	2	N	Obl			Record Type Code (19)
NW_ID	5	N	Obl	1	99999	Road Network Identifier which is unique in the current Dataset
NW_COMPL	1	N	Obl	0	9	Level of completeness whereby 0 indicates no Road Network and 9 a full Road Network
NUM_SECT	5	N	Obl	0	99999	Number of Sections
SECT_ID	10	N	Obl	1	$2^{32}-1$	SECT_ID: Section which uses this network
NUM_FEAT	5	N	Obl	0	99999	Number of Features
FEAT_CAT	2	N	Obl	1	4	Feature Category Code: Feature Category of the Feature referred to in the next field 1 = Point 2 = Line 3 = Area 4 = Complex
LAY_ID	10	N	Obl	0	$2^{32}-1$	Layer Identifier: ID number of the Layer within which the Feature referred to by the network specification resides.
SECT_ID_F	10	N	Obl	0	$2^{32}-1$	Section Identifier: ID number of the Section within which the Feature referred to by the network specification resides.
FEAT_ID	10	N	Obl	1	$2^{32}-1$	Feature Identifier: ID-number of a Point, Line, Area or Complex Feature which uses this network
NW_DESC	*	L	<S>			Description of the meaning of the specified completeness level

12.6.16 Source Record [SRCEREC]

12.6.16.1 Description Info Subrecord [SRCEREC.01]

Field name	Size	Type	No data	Min.	Max.	Description
REC_DESCR	2	N	Obl			Record Type Code (14)
REC_CODE	2	N	Obl			Record Subtype Code (01)
DESC_ID	5	N	Obl	1	99999	Source Description Identifier: An identification number of this Cartographic Source Description which is unique within the set of all Source Material Descriptions ²⁷
PAR_ID	5	N	<S>	1	99999	Parent Description Identifier: The specification number of the "parent" of the source description in issue
DESCR_LEV	1	N	<S>	1	4	Description Level
COMPL_LEV	1	N	<S>	1	1	Level of Completeness: Always = 1 in the current version of the standard
NUM_REC	5	N	Obl	0	99999	Number of records
REC_TYPE	2	N	Obl	1	99	REC_TYPE: Type of the record referred to in the REC_ID field 16 = Section Header (Data Source Reference Subrecord) 45 = Time Domain 44 = Attribute 41 = Text 51 = Point 52 = Line 53 = Area 54 = Complex 25 = Node 24 = Edge 29 = Face 50 = Relationship
REC_SUBTYPE	2	N	<S>	1	99	REC_SUBTYPE: Subtype of the record referred to in the REC_ID field Where the record subtype doesn't exist, <space> should be used.
REC_ID	10	N	Obl	1	2 ³² -1	Record Identifier: ID-number of record which uses this network

²⁷ For the published set of grouped Source records (sub-records SRCEREC.01 – SRCEREC.10), they make reference to the same DESC_ID. On the contrary, PAR_ID (SRCEREC.01) and HOST_ID (SRCEREC.09), if applicable, make reference to a Source Description Identifier different from DESC_ID.

NOTE This record is published even with all optional fields left empty, if at least one other associated sub-record 14.x is published.

12.6.16.2 ISBN & Survey Subrecord [SRCEREC.02]

Field name	Size	Type	No data	Min.	Max.	Description
REC_DESCR	2	N	Obl			Record Type Code (14)
REC_CODE	2	N	Obl			Record Subtype Code (02)
DESC_ID	5	N	Obl	1	99999	Source Description Identifier: An identification number of this Cartographic Source Description which is unique within the set of all Source Material Descriptions ²⁸
ISBN	13	G	<S>			International Standard Book Number of the document in issue
ISSN	10	G	<S>			International Standard Serial Number of the document
NUM_LAN	3	N	Obl	0	999	Number of languages used in the document
LAN_CODE	3	A	Obl			Document Language: ISO 639-2 language code of a language used in the document
NUM_CNTRY	3	N	Obl	0	999	Number of countries involved in the production of the document in issue
CNT_CODE	3	A	Obl			Country Involved: The ISO 3166 alpha-3 code of a country involved in the production of the document
SURV_YEAR	4	N	<S>	1000	9999	Year of Survey of the situation as represented in the document (YYYY)
SURV_DATE	6	N	<S>	1	123123	Date of Survey: Month and (if relevant) day and hour of survey of the situation as represented in the document (MMDDHH)

NOTE The layout of this record assumes that at least one optional field will be specified or one counter is greater than zero.

²⁸ For a set of sub-records associated with the same source description, the ID has to be the same as the designated DESC_ID in "master" sub-record 14.01.

12.6.16.3 Author Name Subrecord [SRCEREC.03]

Field name	Size	Type	No data	Min.	Max.	Description
REC_DESCR	2	N	Obl			Record Type Code (14)
REC_CODE	2	N	Obl			Record Subtype Code (03)
DESC_ID	5	N	Obl	1	99999	Source Description Identifier: An identification number of this Cartographic Source Description which is unique within the set of all Source Material Descriptions ²⁹
AUTHOR	*	L	Obl			Author Name: Name(s) of the author(s) of the document according to ISO 690 specifications

²⁹ For a set of sub-records associated with the same source description, the ID has to be the same as the designated DESC_ID in “master” sub-record 14.01.

12.6.16.4 Scale and Title Subrecord [SRCEREC.04]

Field name	Size	Type	No data	Min.	Max.	Description
REC_DESCR	2	N	Obl			Record Type Code (14)
REC_CODE	2	N	Obl			Record Subtype Code (04)
DESC_ID	5	N	Obl	1	99999	Source Description Identifier: An identification number of this Cartographic Source Description which is unique within the set of all Source Material Descriptions ³⁰
DESC_SUBID	3	N	Obl	1	999	Sub Identifier of Source Description Identification which is unique among multiple occurrences of this subrecord in a given source description
MAP_SCALE	7	N	Obl	1	9999999	Map Scale (cartographic documents only): The value with which all distances on the map have to multiplied to obtain real world distances
LAN_CODE	3	A	<S>			Document Title Language: ISO 639-2 language code of the title as specified
DOC_TITLE	*	L	Obl			Document Title Text: Title of the document in issue

³⁰ For a set of sub-records associated with the same source description, the ID has to be the same as the designated DESC_ID in "master" sub-record 14.01.

12.6.16.5 Volume Name Subrecord [SRCEREC.05]

Field name	Size	Type	No data	Min.	Max.	Description
REC_DESCR	2	N	Obl			Record Type Code (14)
REC_CODE	2	N	Obl			Record Subtype Code (05)
DESC_ID	5	N	Obl	1	99999	Source Description Identifier: An identification number of this Cartographic Source Description which is unique within the set of all Source Material Descriptions ³¹
DESC_SUBID	3	N	Obl	1	999	Sub Identifier of Source Description Identification which is unique among multiple occurrences of this subrecord in a given source description
LAN_CODE	3	A	<S>			Document Volume Name Language: ISO 639-2 language code of the Document Volume Name as specified in the next field
VOL_NAME	*	L	<S>			Document Volume Name: Short name and/or number of a document volume or map sheet

NOTE The layout of this record assumes that at least one optional field will be specified.

³¹ For a set of sub-records associated with the same source description, the ID has to be the same as the designated DESC_ID in “master” sub-record 14.01.

12.6.16.6 Edition & Impression Subrecord [SRCEREC.06]

Field name	Size	Type	No data	Min.	Max.	Description
REC_DESCR	2	N	Obl			Record Type Code (14)
REC_CODE	2	N	Obl			Record Subtype Code (06)
DESC_ID	5	N	Obl	1	99999	Source Description Identifier: An identification number of this Cartographic Source Description which is unique within the set of all Source Material Descriptions ³²
EDIT_NR	20	G	<S>			Edition Number of the document
IMP_NR	20	G	<S>			Impression Number of the document

NOTE The layout of this record assumes that at least one optional field will be specified.

³² For a set of sub-records associated with the same source description, the ID has to be the same as the designated DESC_ID in "master" sub-record 14.01.

12.6.16.7 Publisher Subrecord [SRCEREC.07]

Field name	Size	Type	No data	Min.	Max.	Description
REC_DESCR	2	N	Obl			Record Type Code (14)
REC_CODE	2	N	Obl			Record Subtype Code (07)
DESC_ID	5	N	Obl	1	99999	Source Description Identifier: An identification number of this Cartographic Source Description which is unique within the set of all Source Material Descriptions ³³
DESC_SUBID	3	N	Obl	1	999	Sub Identifier of Source Description Identification which is unique among multiple occurrences of this subrecord in a given source description
PUB_YEAR	4	N	<S>	1000	9999	Year of Publication
CNT_CODE	3	A	<S>			Country of Publication: ISO 3166 alpha-3 code of the country to which the place belongs that is specified in Place of Publication
PUB_PLACE	50	L	<S>			Place of Publication
PUB_NAME	*	L	<S>			Name of Publisher

NOTE The layout of this record assumes that at least one optional field will be specified.

³³ For a set of sub-records associated with the same source description, the ID has to be the same as the designated DESC_ID in “master” sub-record 14.01.

12.6.16.8 Distribution Subrecord [SRCEREC.08]

Field name	Size	Type	No data	Min.	Max.	Description
REC_DESCR	2	N	Obl			Record Type Code (14)
REC_CODE	2	N	Obl			Record Subtype Code (08)
DESC_ID	5	N	Obl	1	99999	Source Description Identifier: An identification number of this Cartographic Source Description which is unique within the set of all Source Material Descriptions ³⁴
DESC_SUBID	3	N	Obl	1	999	Sub Identifier of Source Description Identification which is unique among multiple occurrences of this subrecord in a given source description
DIST_YEAR	4	N	<S>	1000	9999	Year of Distribution
CNT_CODE	3	A	<S>			Country of Distribution: ISO 3166 alpha-3 code of the country to which the place belongs that is specified in Place of Distribution
DIST_PLACE	20	L	<S>			Place of Distribution
DIST_NAME	*	L	<S>			Name of Distributor

NOTE The layout of this record assumes that at least one optional field will be specified.

³⁴ For a set of sub-records associated with the same source description, the ID has to be the same as the designated DESC_ID in "master" sub-record 14.01.

12.6.16.9 Host Document Subrecord [SRCEREC.09]

Field name	Size	Type	No data	Min.	Max.	Description
REC_DESCR	2	N	Obl			Record Type Code (14)
REC_CODE	2	N	Obl			Record Subtype Code (09)
DESC_ID	5	N	Obl	1	99999	Source Description Identifier: An identification number of this Cartographic Source Description which is unique within the set of all Source Material Descriptions ³⁵
HOST_ID	5	N	Obl	1	99999	Host Description Identifier: Identification number of a host document
REL_KIND	2	N	<S>	11	16	Kind of Relationship: Code for the kind of relation with the host document 11 = Descended from 12 = Appendix to 13 = Published together with 14 = Additional map to 15 = Inset map to 16 = Is part of
FST_PAGE	5	N	<S>	1	99999	From Page
LST_PAGE	5	N	<S>	1	99999	To Page
COMMENT	*	L	<S>			General Comment

³⁵ For a set of sub-records associated with the same source description, the ID has to be the same as the designated DESC_ID in “master” sub-record 14.01.

12.6.16.10 Field Data Capturing Subrecord [SRCEREC.10]

Field name	Size	Type	No data	Min.	Max.	Description
REC_DESCR	2	N	Obl			Record Type Code (14)
REC_CODE	2	N	Obl			Record Subtype Code (10)
DESC_ID	5	N	Obl	1	99999	Source Description Identifier: An identification number of this Cartographic Source Description which is unique within the set of all Source Material Descriptions ³⁶
START_FDC	8	N	Obl	10000101	99991231	Start date FDC activities (YYYYMMDD)
END_FDC	8	N	<S>	10000101	99991231	End date FDC activities (YYYYMMDD) In case this field is left empty START_FDC contains the FDC date
COMMENT	*	L	<S>			General Comment: Free text field for additional FDC information

³⁶ For a set of sub-records associated with the same source description, the ID has to be the same as the designated DESC_ID in "master" sub-record 14.01.

12.6.17 Geodetical Parameter Records

12.6.17.1 Datum & Ellipsoid Record [DATELREC]

Field name	Size	Type	No data	Min.	Max.	Description
REC_DESCR	2	N	Obl			Record Type Code (61)
DATEL_ID	10	N	Obl	1	$2^{32}-1$	Datum Description Identifier: Identification number of this datum description which is unique within the set of all Datum & Ellipsoid Records in the Dataset
TRANS_X	5	I	<S>	-9999	9999	X-Origin: X-coordinate of the origin of the datum, expressed in decimeters, relative to the origin of WGS '84
TRANS_Y	5	I	<S>	-9999	9999	Y-Origin: Y-coordinate of the origin of the datum, expressed in decimeters, relative to the origin of WGS '84
TRANS_Z	5	I	<S>	-9999	9999	Z-Origin: Z-coordinate of the origin of the datum, expressed in decimeters, relative to the origin of WGS '84
ROT_Z	9	I	<S>	0	40000000	Z-Rotation: Rotation around the Z-axis, expressed in gon $\times 10^{-5}$ (hundredths of a milligon)
SCALE_FAC	5	I	<S>	-9999	9999	Scale Factor: Scale factor Mo, expressed in the form $(1 - Mo) * 1\ 000\ 000\ 000$
DAT_NAME	50	L	<S>			Datum Name: The name of the geodetic datum in issue
DAT_CODE	4	A	<S>			Datum Code: The code of the geodetic datum in issue
SEM_MAJOR	8	N	<S>	0	99999999	Semi Major Axis: The length of the semi-major axis of the reference ellipsoid expressed in meters
SEM_MINOR	8	N	<S>	0	99999999	Semi Minor Axis: The length of the semi-minor axis of the reference ellipsoid expressed in meters
EL_CODE	2	A	<S>			Ellipsoid Code: code of the reference ellipsoid
COMMENT	*	L	<S>			Description of the Ellipsoid

NOTE The layout of this record assumes that at least one optional field will be specified.

12.6.17.2 Vertical Datum Record [VERDATREC]

Field name	Size	Type	No data	Min.	Max.	Description
REC_DESCR	2	N	Obl			Record Type Code (62)
VERDAT_ID	10	N	Obl	1	$2^{32}-1$	Vertical Datum Description Identifier: An identification number of the record that is unique within the set of all Vertical Datum Records in the Dataset
CNT_CODE	3	A	Obl			Relevant Country: ISO 3166 country code of the country in which the orthometric reference system, as mentioned in the next field Height Level Name, is used
LEV_NAME	50	L	<S>			Height Level Name: Name of the orthometric reference system in issue
LEV_CODE	2	A	Obl			Height Level Code: Code of the orthometric reference system in issue
NUM_LEV	2	N	Obl	0	99	Number of adjacent orthometric levels
CNT_CODE_A	3	A	Obl			Used in Country: ISO 3166 alpha-3 country code of the country in which the adjacent system, as specified in the next field Height Level Name, is used
LEV_NAME_A	50	L	<S>			Adjacent Height Level Name: Name of an adjacent orthometric reference system
LEV_CODE_A	2	A	Obl			Adjacent Height Level Code: Code of the adjacent orthometric reference system
TRANS_H	5	I	Obl	-9999	9999	Height Difference: The orthometric height of the origin of the adjacent system, relative to system in issue, expressed in centimeters

12.6.17.3 Projection Record [PROJECREC]

Field name	Size	Type	No data	Min.	Max.	Description
REC_DESCR	2	N	Obl			Record Type Code (63)
PROJEC_ID	10	N	Obl	1	$2^{32}-1$	Projection Description Identifier: An identification number of this record that is unique within the set of all Projection Records in the Dataset
PROJ_CODE	2	A	Obl			Projection Type Code
NUM_PAR	2	N	Obl	1	3	Number of parameter sets
PAR_LAT	10	I	<S>	-90000000	90000000	Parameter Latitude: Latitude of a projection parameter, expressed in microdegrees
PAR_LONG	10	I	<S> ³⁷	-180000000	180000000	Parameter Longitude: Longitude of a projection parameter, expressed in microdegrees
SCALE_FAC	5	I	0	-9999	9999	Point Scale Factor: Point scale factor M_0 , expressed in the form $(1 - M_0) * 10\ 000\ 000$
COMMENT	*	L	<S>			Description of the Projection Type

³⁷ Within a given repeat cycle, not both fields PAR_LAT and PAR_LONG can be left empty.

12.6.17.4 National Grid Record [NATGRIDREC]

Field name	Size	Type	No data	Min.	Max.	Description
REC_DESCR	2	N	Obl			Record Type Code (64)
NATGRID_ID	10	N	Obl	1	$2^{32}-1$	Grid Description Identifier: An identification number of this record that is unique within the set of all National Grid Records in the Dataset
GRID_ORI	1	N	Obl	0	1	Grid Axes Orientation: Indicates whether the orientation of the national grid is 0 : normal Cartesian or 1 : reverse Cartesian
HELP_LAT	10	I	<S>	-90000000	90000000	Help Grid Latitude: Latitude of the origin of the help grid, expressed in microdegrees
HELP_LONG	10	I	<S>	-180000000	180000000	Help Grid Longitude: Longitude of the origin of the help grid, expressed in micro-degrees
X_ORIG	10	I	<S>	$-(10^9-1)$	10^9-1	X Origin: X-coordinate of the origin of the national grid, relative to the origin of the help grid and expressed in decimeters
Y_ORIG	10	I	<S>	$-(10^9-1)$	10^9-1	Y Origin: Y-coordinate of the origin of the national grid, relative to the origin of the help grid, expressed in decimeters
ROT_GRID	10	I	<S>	0	400000000	Grid Rotation: Clockwise counted angle between the positive Y-axis of the national grid and the positive Y-axis of the help grid, expressed in gon $\times 10^{-6}$
GRID_NAME	50	L	<S>			Grid Name: Name of the national grid in issue
GRID_CODE	2	A	<S>			Grid Code: Code of the national grid in issue

NOTE The layout of this record assumes that at least one optional field will be specified.

12.6.17.5 Geoid Undulation Record [GEOIDREC]

Field name	Size	Type	No data	Min.	Max.	Description
REC_DESCR	2	N	Obl			Record Type Code (65)
GEOID_ID	10	N	Obl	1	$2^{32}-1$	Geoid Description Identifier: An identification number of the record that is unique within the set of all Geoid Undulation Records in the Dataset
REF_LAT	10	I	<S>	-90000000	90000000	Reference Point Latitude: Latitude of the point at which the geoid undulation is specified, expressed in microdegrees
REF_LONG	10	I	<S>	-180000000	180000000	Reference Point Longitude: Longitude of the point at which the geoid undulation is specified, expressed in microdegrees
GEOID_UND	5	I	<S>	-9999	9999	Ellipsoidal Height: Height of the national orthometric reference level (geoid) above the reference ellipsoid, expressed in decimeters

NOTE The layout of this record assumes that at least one optional field will be specified.

12.6.17.6 Earth Magnetic Field Record [MAGNETREC]

Field name	Size	Type	No data	Min.	Max.	Description
REC_DESCR	2	N	Obl			Record Type Code (66)
MAGN_ID	10	N	Obl	1	$2^{32}-1$	Declination Description Identifier: An identification number of this record that is unique within the set of all Earth Magnetic Field Records in the Dataset
REF_LAT	10	I	<S>	-90000000	90000000	Reference Point Latitude: Latitude of the point at which the magnetic declination is specified, expressed in microdegrees
REF_LONG	10	I	<S>	-180000000	180000000	Reference Point Longitude: Longitude of the point at which the magnetic declination is specified, expressed in microdegrees
DEC_DATE	8	N	<S>	10000101	99991231	Validity Date: Date of the declination value. Declination value is specified in the field Magnetic Variation (DEC_VALUE). (YYYYMMDD)
DEC_VALUE	7	I	<S>	-400000	400000	Magnetic Variation: Value of the clockwise counted angle between the direction of the Geographic North and the direction of the Magnetic North, expressed in milligons
DEV_ANNUAL	7	I	<S>	-400000	400000	Annual Change: Value of the clockwise counted angle of the annual deviation of the magnetic declination, expressed in milligons
HMAG_INT	5	I	<S>	0	99999	Horizontal Magnetic Field Intensity: in nanoteslas
VMAG_INT	5	I	<S>	0	99999	Vertical Magnetic Field Intensity: in nanoteslas

NOTE The layout of this record assumes that at least one optional field will be specified.

12.6.18 Layer Header Record [LAYHREC]

Field name	Size	Type	No data	Min.	Max.	Description
REC_DESCR	2	N	Obl			Record Type Code (17)
LAY_ID	10	N	Obl	1	$2^{32}-1$	Layer Identifier: Unique ID number for this Layer (within the Dataset to which it belongs)
LAY_TOPOL	1	N	Obl	1	3	Level-0 network topology of this Layer. 1: Non-explicit topology 2: Connectivity rendering of non-planar topology 3: Full integration rendering of planar topology
Z_REF	1	N	Obl	0	3	Method of Edge height level referencing applied in this Layer: 0: implied by coordinates 1: achieved via Edge levels 2: achieved via Relationship Grade-separated Crossing 3: no height level referencing
XY_RES	3	N	<S>	0	999	Layer XY Resolution
NUM_THEM	2	N	Obl	0	99	Number of Feature Themes
THEM_COD	2	N	<S>			Feature Theme Code: Code of Feature Theme that occurs in this Layer
XY_ACC_LEV	5	N	<S>	0	99999	Horizontal accuracy level measure (user-defined)
XY_AL_DESC	40	L	<S>			Description of Horizontal accuracy level measure
Z_ACC_LEV	5	N	<S>	0	99999	Vertical accuracy level measure (user-defined)
Z_AL_DESC	40	L	<S>			Description of Vertical accuracy level measure

12.6.19 Section Header Record [SECHREC]

12.6.19.1 Section Identification Subrecord [SECHREC.01]

Field name	Size	Type	No data	Min.	Max.	Description
REC_DESCR	2	N	Obl			Record Type Code (16)
REC_CODE	2	N	Obl			Record Subtype Code (01)
SECT_ID	10	N	Obl	1	$2^{32}-1$	Section Identification Number: An identification number of the Section in issue, which is unique within the Layer
GEO_AREA	*	L	<S>			Section Geographic Coverage: A characteristic topographical name of the Section

12.6.19.2 Section Settings Subrecord [SECHREC.02]

Field name	Size	Type	No data	Min.	Max.	Description
REC_DESCR	2	N	Obl			Record Type Code (16)
REC_CODE	2	N	Obl			Record Subtype Code (02)
SECT_ID	10	N	Obl	1	$2^{32}-1$	Section Identification Number: An identification number of the Section in issue, which is unique within the Layer ³⁸
XY_RES	3	N	<S>	0	999	Section XY Resolution: Worst case value in any part of the Section, expressed in meters
LN_CNT_DIR	1	N	<S>	0	1	Convention for default direction for the counting of lanes 0 = right 1 = left

NOTE The layout of this record assumes at least one optional field will be specified.

³⁸ For a set of sub-records associated with the same section header, the ID has to be the same as the designated SECT_ID in “master” sub-record 16.01.

12.6.19.3 Network Identification Subrecord [SECHREC.03]

Field name	Size	Type	No data	Min.	Max.	Description
REC_DESCR	2	N	Obl			Record Type Code (16)
REC_CODE	2	N	Obl			Record Subtype Code (03)
SECT_ID	10	N	Obl	1	$2^{32}-1$	Section Identification Number: An identification number of the Section in issue, which is unique within the Layer ³⁹
NW_ID	5	N	<S>	1	99999	Network Specification Identifier for the kind of (road) network present in the Section
ETA_CONN	1	N	<S>	0	1	Artificial Connectivity indicator for Enclosed Traffic Areas. 0: Artificial ETA connectivity not present 1: Artificial ETA connectivity present

NOTE The layout of this record assumes that at least one optional field will be specified.

³⁹ For a set of sub-records associated with the same section header, the ID has to be the same as the designated SECT_ID in “master” sub-record 16.01.

12.6.19.4 Datasource Reference Subrecord [SECHREC.04]

Field name	Size	Type	No data	Min.	Max.	Description
REC_DESCR	2	N	Obl			Record Type Code (16)
REC_CODE	2	N	Obl			Record Subtype Code (04)
SECT_ID	10	N	Obl	1	$2^{32}-1$	Section Identification Number: An identification number of the Section in issue, which is unique within the Layer ⁴⁰
NUM_DOC	2	N	Obl	0	99	Number of Sources
DESC_ID	5	N	Obl	1	99999	Source Description Identifier: Identification number of a [SRCEREC] record which is related to this Section

⁴⁰ For a set of sub-records associated with the same section header, the ID has to be the same as the designated SECT_ID in “master” sub-record 16.01.

12.6.19.5 Datum & Magnetism Subrecord [SECHREC.05]

Field name	Size	Type	No data	Min.	Max.	Description
REC_DESCR	2	N	Obl			Record Type Code (16)
REC_CODE	2	N	Obl			Record Subtype Code (05)
SECT_ID	10	N	Obl	1	$2^{32}-1$	Section Identification Number: An identification number of the Section in issue, which is unique within the Layer ⁴¹
DATEL_ID	10	N	Obl	1	$2^{32}-1$	Datum Description Identifier: The identification number of the Datum & Ellipsoid Record which contains information about the geodetic datum and reference ellipsoid which is relevant for the Section in issue
COORD_TYPE	1	N	Obl	0	1	Horizontal Reference Type: Indicates whether the coordinate values in the present Section are given in the form of geographical latitude and longitude (= 0) or as X- and Y-values within a rectangular Cartesian coordinate system (= 1)
PROJEC_ID	10	N	<S>	1	$2^{32}-1$	Projection Description Identifier: Identification number of the Projection Record that contains the information about the projection
NATGRID_ID	10	N	<S>	1	$2^{32}-1$	Grid Description Identifier: Identification number of the National Grid Record that contains information about the national grid
NUM_FIELD	2	N	Obl	0	99	Number of fields
MAGN_ID	10	N	Obl	1	$2^{32}-1$	Declination Description Identifier: Identification number of an Earth Magnetic Field Record that contains information about the magnetic declination

NOTE The layout of this record assumes that at least one optional field will be specified or the counter is greater than zero.

⁴¹ For a set of sub-records associated with the same section header, the ID has to be the same as the designated SECT_ID in "master" sub-record 16.01.

12.6.19.6 Orthometric Reference Subrecord [SECHREC.06]

Field name	Size	Type	No data	Min.	Max.	Description
REC_DESCR	2	N	Obl			Record Type Code (16)
REC_CODE	2	N	Obl			Record Subtype Code (06)
SECT_ID	10	N	Obl	1	$2^{32}-1$	Section Identification Number: An identification number of the Section in issue, which is unique within the Layer ⁴²
H_TYPE	1	N	Obl	0	2	Height Reference Type: Indicates whether the height values in the present Section are given in the form of ellipsoidal heights (= 0), as orthometric heights (= 1) or as relative heights (= 2)
VERDAT_ID	10	N	<S>	1	$2^{32}-1$	Vertical Datum Description Identifier: Identification number of the Vertical Datum Record that contains information about the orthometric height reference system, which is relevant for the Section in issue
NUM_FIELD	2	N	Obl	0	99	Number of fields
GEOID_ID	10	N	Obl	1	$2^{32}-1$	Geoid Description Identifier: Identification number of a Geoid Undulation Record that contains information about the geoid height at a particular point

⁴² For a set of sub-records associated with the same section header, the ID has to be the same as the designated SECT_ID in “master” sub-record 16.01.

12.6.19.7 Section Border Subrecord [SECHREC.07]

Field name	Size	Type	No data	Min.	Max.	Description
REC_DESCR	2	N	Obl			Record Type Code (16)
REC_CODE	2	N	Obl			Record Subtype Code (07)
SECT_ID	10	N	Obl	1	$2^{32}-1$	Section Identification Number: An identification number of the Section in issue, which is unique within the Layer ⁴³
XY_CONFAC	2	I	Obl	-9	9	XY Multiplication Factor: 10 LOG of the multiplication factor for the X- and Y-values in the present Section
Z_CONFAC	2	I	<S>	-9	9	Z Multiplication Factor: 10 LOG of the multiplication factor for the Z-values in this Section
X_OFFSET	11	I	<S>	-2^{31}	$2^{31}-1$	X Offset: An additive constant for all the X coordinates in this Section
Y_OFFSET	11	I	<S>	-2^{31}	$2^{31}-1$	Y Offset: An additive constant for all the Y coordinates in this Section
Z_OFFSET	11	I	<S>	-2^{31}	$2^{31}-1$	Z Offset: An additive constant for all the Z coordinates in this Section
X_MAX	11	I	<S>	-2^{31}	$2^{31}-1$	Maximum X: The maximum logical X-value which may occur in this Section
Y_MAX	11	I	<S>	-2^{31}	$2^{31}-1$	Maximum Y: The maximum logical Y-value which may occur
X_MIN	11	I	<S>	-2^{31}	$2^{31}-1$	Minimum X: The minimum logical X-value which may occur
Y_MIN	11	I	<S>	-2^{31}	$2^{31}-1$	Minimum Y: The minimum logical Y-value which may occur

⁴³ For a set of sub-records associated with the same section header, the ID has to be the same as the designated SECT_ID in "master" sub-record 16.01.

12.6.19.8 XY Control Point Subrecord [SECHREC.08]

Field name	Size	Type	No data	Min.	Max.	Description
REC_DESCR	2	N	Obl			Record Type Code (16)
REC_CODE	2	N	Obl			Record Subtype Code (08)
SECT_ID	10	N	Obl	1	$2^{32}-1$	Section Identification Number: An identification number of the Section in issue, which is unique within the Layer ⁴⁴
SECT_SUBID	3	N	Obl	1	999	Sub Identifier of Section Identification Number which is unique among multiple occurrences of this subrecord in a given Section
POINT_NAME	20	L	<S>			Point Name: A unique external identification number or name of the control point
X_DIG	12	I	<S>	$-(10^{11}-1)$	$10^{11}-1$	X Digitized: The digitized X-coordinate of the control point, expressed in centimeters
Y_DIG	12	I	<S>	$-(10^{11}-1)$	$10^{11}-1$	Y Digitized: The digitized Y-coordinate of the control point, expressed in centimeters
X_SURV	12	I	<S>	$-(10^{11}-1)$	$10^{11}-1$	X Surveyed: The surveyed X-coordinate of the control point, expressed in centimeters
Y_SURV	12	I	<S>	$-(10^{11}-1)$	$10^{11}-1$	Y Surveyed: The surveyed Y-coordinate of the bench mark, expressed in centimeters

NOTE The layout of this record assumes that at least one optional field will be specified.

⁴⁴ For a set of sub-records associated with the same section header, the ID has to be the same as the designated SECT_ID in "master" sub-record 16.01.

12.6.19.9 Z Control Point Subrecord [SECHREC.09]

Field name	Size	Type	No data	Min.	Max.	Description
REC_DESCR	2	N	Obl			Record Type Code (16)
REC_CODE	2	N	Obl			Record Subtype Code (09)
SECT_ID	10	N	Obl	1	$2^{32}-1$	Section Identification Number: An identification number of the Section in issue, which is unique within the Layer ⁴⁵
SECT_SUBID	3	N	Obl	1	999	Sub Identifier of Section Identification Number which is unique among multiple occurrences of this subrecord in a given Section
POINT_NAME	20	L	<S>			Point Name: A unique external identification number or name of the control point
X_COORD	11	I	<S>	-2^{31}	$2^{31}-1$	X Reference: X-coordinate of the control point expressed in the same unit as in the data records
Y_COORD	11	I	<S>	-2^{31}	$2^{31}-1$	Y Reference: Y-coordinate of the control point, expressed in the same unit as in the data records
Z_DIG	11	I	<S>	-2^{31}	$2^{31}-1$	Z Digitized: Digitized Z-coordinate of the control point, expressed in centimeters
Z_SURV	11	I	<S>	-2^{31}	$2^{31}-1$	Z Surveyed: Surveyed Z-coordinate of the control point, expressed in centimeters

NOTE The layout of this record assumes that at least one optional field will be specified.

⁴⁵ For a set of sub-records associated with the same section header, the ID has to be the same as the designated SECT_ID in “master” sub-record 16.01.

12.6.19.10 Update Information Subrecord [SECHREC.10]

Field name	Size	Type	No data	Min.	Max.	Description
REC_DESCR	2	N	Obl			Record Type Code (16)
REC_CODE	2	N	Obl			Record Subtype Code (10)
SECT_ID	10	N	Obl	1	$2^{32}-1$	Section Identification Number: An identification number of the Section in issue, which is unique within the Layer ⁴⁶
DATE_FMT	20	G	Obl			Time Stamp Format: Formatting string for the time stamps used within the given Section composed of: d = day M = month y = year h = hour (0...23) m = minute s = second := separator

⁴⁶ For a set of sub-records associated with the same section header, the ID has to be the same as the designated SECT_ID in “master” sub-record 16.01.

12.6.20 Comment Record [COMMENTREC]

Field name	Size	Type	No data	Min.	Max.	Description
REC_DESCR	2	N	Obl			Record Type Code (90)
COMMENT	*	L	<S>			General Comment

12.6.21 Volume Termination Record [VOLTERMREC]

Field name	Size	Type	No data	Min.	Max	Description
REC_DESCR	2	N	Obl			Record Type Code (99)
VOLENDTEXT	77	L	<S>			Volume Termination Comments
CONT_VOL	1	N	Obl	0	1	Volume Continuation Mark: 0 : if the present volume is the last volume in the Dataset 1 : if another volume follows

12.7 Record Format Specifications: Data Records

12.7.1 2D Coordinate Record [XYREC]

Field name	Size	Type	No data	Min.	Max.	Description
REC_DESCR	2	N	Obl			Record Type Code (22)
COORD_ID	10	N	Obl	1	$2^{32}-1$	Coordinate Identifier: The ID-number of the Coordinate which is unique within the Section
DESC_ID	5	N	<S>	1	99999	Source Description Identifier
NUM_COORD	5	N	Obl	1	99999	Number of coordinate tuples of intermediate points
X_COORD	11	I	Obl	-2^{31}	$2^{31}-1$	X-coordinate
Y_COORD	11	I	Obl	-2^{31}	$2^{31}-1$	Y-coordinate
NUM_NODE	10	N	Obl	0	$2^{32}-1$	Number of Nodes
NODE_ID	10	N	Obl	1	$2^{32}-1$	NODE_ID: Node which uses this coord record as geometry
NUM_EDG_BP	10	N	Obl	0	$2^{32}-1$	Number of Edge backpointers
EDGE_ID	10	N	Obl	1	$2^{32}-1$	EDGE_ID: Edge which uses this coord rec as geometry

12.7.2 3D Coordinate Record [XYZREC]

Field name	Size	Type	No data	Min.	Max.	Description
REC_DESCR	2	N	Obl			Record Type Code (23)
COORD_ID	10	N	Obl	1	$2^{32}-1$	Coordinate Identifier: The ID-number of the Coordinate which is unique within the Section
DESC_ID	5	N	<S>	1	99999	Source Description Identifier
NUM_COORD	5	N	Obl	1	99999	Number of coordinate tuples of intermediate points
X_COORD	11	I	Obl	-2^{31}	$2^{31}-1$	X-coordinate
Y_COORD	11	I	Obl	-2^{31}	$2^{31}-1$	Y-coordinate
Z_COORD	11	I	<S>	-2^{31}	$2^{31}-1$	Z-coordinate
NUM_NODE	10	N	Obl	0	$2^{32}-1$	Number of Nodes
NODE_ID	10	N	Obl	1	$2^{32}-1$	NODE_ID: Node which uses this coord record as geometry
NUM_EDG_BP	10	N	Obl	0	$2^{32}-1$	Number of Edge backpointers
EDGE_ID	10	N	Obl	1	$2^{32}-1$	EDGE_ID: Edge which uses this coord rec as geometry

12.7.3 Node Record [NODEREC]

Field name	Size	Type	No data	Min.	Max.	Description
REC_DESCR	2	N	Obl			Record Type Code (25)
NODE_ID	10	N	Obl	1	$2^{32}-1$	Node Identifier: The ID-number of the Node which is unique within the Section
DESC_ID	5	N	<S>	1	99999	Source Description Identifier
FACE_ID	10	N	<S>	1	$2^{32}-1$	Face Identifier: The ID-number of the Face containing this Node. This field is always empty for explicit connectivity rendering topology.
STATUS	2	N	Obl	1	5	Status Code: 1 = Section border Node 2 = normal Node 3 = Dataset border Node 4 = End of Stub 5 = Normal Node on a Section and/or Dataset border
COORD_ID	10	N	Obl	1	$2^{32}-1$	ID-number of a Coordinate record (2D or 3D)
NUM_EDG_BP	10	N	Obl	0	$2^{32}-1$	Number of Edge backpointers
EDGE_ID	10	N	Obl	1	$2^{32}-1$	EDGE_ID: Edge which uses this Node as a boundary
NUM_POINT	10	N	Obl	0	$2^{32}-1$	Number of Point Features
POINT_ID	10	N	Obl	1	$2^{32}-1$	POINT_ID: Point Feature which uses this Node as geo-topo representation. ⁴⁷

⁴⁷ This pointer identifies Point Features rendered by the Point Feature Record for explicit topology (Rec51.01).

12.7.4 Edge Record [EDGEREC]

Field name	Size	Type	No data	Min.	Max.	Description
REC_DESCR	2	N	Obl			Record Type Code (24)
EDGE_ID	10	N	Obl	1	$2^{32}-1$	Edge Identifier: ID-number of the Edge, which is unique within the Section
DESC_ID	5	N	<S>	1	99999	Source Description Identifier
FNODE_ID	10	N	Obl	1	$2^{32}-1$	From Node Identifier: ID-number of the From Node of this Edge
TNODE_ID	10	N	Obl	1	$2^{32}-1$	To Node Identifier: ID-number of the To Node of this Edge
L_FACE_ID	10	N	<S>	1	$2^{32}-1$	Left Face Identifier: ID-number of the Left Face of this Edge. This field is always empty for explicit connectivity rendering topology.
R_FACE_ID	10	N	<S>	1	$2^{32}-1$	Right Face Identifier: ID-number of the Right Face. This field is always empty for explicit connectivity rendering topology.
STATUS	2	N	Obl	1	5	Status Code: 1 = Section border Edge 2 = Normal Edge 3 = Dataset Border Edge 4 = (Not applicable) 5 = Normal Edge on a Section and/or Dataset border
COORD_ID	10	N	<S>	1	$2^{32}-1$	ID-number of a Coordinate record (2D or 3D)
NUM_LINE	10	N	Obl	0	$2^{32}-1$	Number of Line Features
LINE_ID	10	N	Obl	1	$2^{32}-1$	LINE_ID: Line Feature which uses this Edge as geo-topo representation. ⁴⁸
NUM_AREA	10	N	Obl	0	$2^{32}-1$	Number of Area Features
AREA_ID	10	N	Obl	1	$2^{32}-1$	AREA_ID: Area Feature which uses this Edge as geo-topo representation. ⁴⁹

⁴⁸ This pointer identifies Line Features rendered by the Line Feature Record for explicit topology (Rec52.01).

⁴⁹ This pointer identifies Area Features rendered by the Area Feature Record for explicit connectivity rendering topology (Rec53.02).

12.7.5 Face Record [FACEREC]

Field name	Size	Type	No data	Min.	Max.	Description
REC_DESCR	2	N	Obl			Record Type Code (29)
FACE_ID	10	N	Obl	1	$2^{32}-1$	Face Identifier: ID-number of this Face, which is unique within the Section
DESC_ID	5	N	<S>	1	99999	Source Description Identifier
NUM_EDGE	10	N	Obl	1	$2^{32}-1$	Number of Edges
EDGE_ID	10	N	Obl	1	$2^{32}-1$	Edge Identifier: ID-number of an Edge that forms the boundary of this Face
ORIENT	1	N	Obl	0	1	Edge Orientation: Indication of the orientation of the Edge on the Face border 0 = Clockwise 1 = Counterclockwise
NUM_AREA	10	N	Obl	0	$2^{32}-1$	Number of Area Features
AREA_ID	10	N	Obl	1	$2^{32}-1$	AREA_ID: Area Feature which uses this Face as geo-topo representation. ⁵⁰
NUM_EXTGEO	1	N	Obl	0	1	Number flagging the presence of Extended area geometry information
GEO_TYPE	1	N	<S>	0	4	Geometrical Type of bounded area 3 = Triangular 4 = Quadrangular 0 = Other
OUT_LENGTH	10	N	<S>	0	$2^{32}-1$	Outline Length of bounded area, expressed in decimetres
SIZE	10	N	<S>	0	$2^{32}-1$	Size of bounded area, expressed in square metres
SLOPE	3	N	<S>	0	999	Slope of bounded area, representing the (maximum) inclination, expressed as positive percentage
ASPECT	4	N	<S>	0	3599	Aspect of bounded area, representing the horizontal bearing of slope vector (maximum inclination), expressed as clockwise angle against North measured in 1/10 of a degree
LIGHT_VAL	3	N	<S>	0	255	Light Value of bounded area, representing an artificial hill shade, expressed as a grey scale

⁵⁰ This pointer identifies Area Features rendered by the Area Feature Record for explicit full integration rendering topology (Rec53.01).

12.7.6 Point Feature Record (Explicit Point Topology sub-record) [POFEREC.01]

Field name	Size	Type	No data	Min.	Max.	Description
REC_DESCR	2	N	Obl			Record Type Code (51)
REC_CODE	2	N	Obl			Record Subtype Code (01)
POINT_ID	10	N	Obl	1	$2^{32}-1$	Point Feature Identifier: ID-number of the Point Feature which is unique within the Section
DESC_ID	5	N	<S>	1	99999	Source Description Identifier
NW_ID	5	N	<S>	1	99999	Network Specification Identifier for the kind of (road) network the Feature is part of
FEAT_CODE	4	N	Obl	1000	9999	Feature Class Code: Code of the Feature Class to which the Feature belongs
NODE_ID	10	N	<S>	1	$2^{32}-1$	Node Identifier: The ID-number of the Node which contains the geometry of the Point Feature. It is allowable to have a Node-less Point Feature.
NUM_ATT	5	N	Obl	0	99999	Number of Attribute sets
ID_SCOPE	1	A	Obl			Scope switch: whether the Attribute Record referred to by the subsequent field is published locally, semi-globally, or globally. S = locally within same Section L = semi-globally within the Layer this Section belongs to D = globally within Dataset this Section belongs to
ATT_ID	10	N	Obl	1	$2^{32}-1$	Attribute Identifier: ID-number of an [ATTREC] record which contains relevant Attribute values for this Feature
NUM_LINE	10	N	Obl	0	$2^{32}-1$	Number of Line Features
LINE_ID	10	N	Obl	1	$2^{32}-1$	LINE_ID: Line Feature which uses this point as a boundary. ⁵¹
NUM_COMPLX	10	N	Obl	0	$2^{32}-1$	Number of Complex Features
COMPLEX_ID	10	N	Obl	1	$2^{32}-1$	COMPLEX_ID: Complex Feature which uses this point as a component ⁵²
NUM_REL	10	N	Obl	0	$2^{32}-1$	Number of Relationships
REL_ID	10	N	Obl	1	$2^{32}-1$	REL_ID: Relationship which uses this point as a component
NUM_CONV	10	N	Obl	0	$2^{32}-1$	Number of conversion records
CONV_ID	10	N	Obl	1	$2^{32}-1$	CONV_ID: Conversion record which converts this point

⁵¹ This pointer identifies Line Features rendered by the Line Feature Record for explicit topology (Rec52.01).

⁵² This pointer identifies Complex Features rendered by the Complex Feature Record for explicit topology (Rec54.01).

12.7.7 Point Feature Record (Non-explicit Point Topology sub-record) [POFEREC.03]

Field name	Size	Type	No data	Min.	Max.	Description
REC_DESCR	2	N	Obl			Record Type Code (51)
REC_CODE	2	N	Obl			Record Subtype Code (03)
POINT_ID	10	N	Obl	1	$2^{32}-1$	Point Feature Identifier: ID-number of the Point Feature which is unique within the Section
DESC_ID	5	N	<S>	1	99999	Source Description Identifier
NW_ID	5	N	<S>	1	99999	Network Specification Identifier for the kind of (road) network the Feature is part of
FEAT_CODE	4	N	Obl	1000	9999	Feature Class Code: Code of the Feature Class to which the Feature belongs
COORD_MASK	4	N	Obl	0	3331	Coordinate Mask: ZHHT value, whereby Z=0 3; HH= 00 30; T=0 1.
TIME_MASK	2	N	<S>	1	16	Time Mask: decimal value representing SA/EA/SD/ED occurrence of 16 cases ($2*2*2*2$ combinations). If the fourth position of the COORD_MASK is set to '0', the TIME_MASK shall not be specified (leave field empty).
X_COORD	11	I	Obl	-2^{31}	$2^{31}-1$	X Coordinate
Y_COORD	11	I	Obl	-2^{31}	$2^{31}-1$	Y Coordinate
NUM_Z	1	N	Obl	0	1	Number of Z coordinates of the geometry of this Point Feature, specifying whether Z coordinates are present or not.
Z_COORD	11	I	Obl	-2^{31}	$2^{31}-1$	Z Coordinate
NUM_H1	1	N	Obl	0	1	Number of H1 coordinates of the geometry of this Point Feature, specifying whether H1 coordinates are present or not.
H1_COORD	11	I	<S>	-2^{31}	$2^{31}-1$	Upper Object Elevation
NUM_TIME	1	N	Obl	0	1	Number of T coordinate tuples of the geometry of this Point Feature, specifying whether T coordinates are present or not.

T_SA_COORD	10	N	<S>	1000010100	9999123123	T Coordinate SA (Start Appearance) (YYYYMMDDHH)
T_EA_COORD	10	N	<S>	1000010100	9999123123	T Coordinate EA (End Appearance) (YYYYMMDDHH)
T_SD_COORD	10	N	<S>	1000010100	9999123123	T Coordinate SD (Start Disappearance) (YYYYMMDDHH)
T_ED_COORD	10	N	<S>	1000010100	9999123123	T Coordinate ED (End Disappearance) (YYYYMMDDHH)
NUM_ATT	5	N	Obl	0	99999	Number of Attribute sets
ID_SCOPE	1	A	Obl			Scope switch: whether the Attribute Record referred to by the subsequent field is published locally, semi-globally, or globally. S = locally within same Section L = semi-globally within the Layer this Section belongs to D = globally within Dataset this Section belongs to
ATT_ID	10	N	Obl	1	$2^{32}-1$	Attribute Identifier: ID-number of a [ATTREC] record which contains relevant Attribute values for this Feature
NUM_COMPLX	10	N	Obl	0	$2^{32}-1$	Number of Complex Features
COMPLEX_ID	10	N	Obl	1	$2^{32}-1$	COMPLEX_ID: Complex Feature which uses this point as a component ⁵³
NUM_REL	10	N	Obl	0	$2^{32}-1$	Number of Relationships
REL_ID	10	N	Obl	1	$2^{32}-1$	REL_ID: Relationship which uses this point as a component
NUM_CONV	10	N	Obl	0	$2^{32}-1$	Number of conversion records
CONV_ID	10	N	Obl	1	$2^{32}-1$	CONV_ID: Conversion record which converts this point

⁵³ This pointer identifies Complex Features rendered by the Complex Feature Record for non-explicit topology (Rec54.03).

12.7.8 Line Feature Record (Explicit Line Topology sub-record) [LIFEREC.01]

Field name	Size	Type	No data	Min.	Max.	Description
REC_DESCR	2	N	Obl			Record Type Code (52)
REC_CODE	2	N	Obl			Record Subtype Code (01)
LINE_ID	10	N	Obl	1	$2^{32}-1$	Line Feature Identifier: ID-number of the Line Feature which is unique within the Section
DESC_ID	5	N	<S>	1	99999	Source Description Identifier
NW_ID	5	N	<S>	1	99999	Network Specification Identifier for the kind of (road) network the Feature is part of
FEAT_CODE	4	N	Obl	1000	9999	Feature Class Code: Code of the Feature Class to which the Feature belongs
SPLIT_IND	1	N	Obl	0	1	Split Indicator: 0 = Line represents an entire Feature 1 = Line represents part of a split Feature
FROM_ID	10	N	<S>	1	$2^{32}-1$	From Point Identifier: The ID-number of the first bounding Point Feature of a Line Feature
TO_ID	10	N	<S>	1	$2^{32}-1$	To Point Identifier: The ID-number of the second bounding Point Feature of this Line Feature
NUM_EDGE	10	N	Obl	0	$2^{32}-1$	Number of Edges. It is allowable to have an edge-less Line Feature.
EDGELEVS	2	I	<S>	-9	99	Relative height level of Line Feature at starting Node of the current Edge
EDGELEVI	2	I	<S>	-9	99	Intermediate height level of the current Edge
EDGE_ID	10	N	Obl	1	$2^{32}-1$	ID-number of an Edge representing the Line Feature
POS_NEG	2	N	Obl	0	1	Line Direction: Indication of the direction of the Line in relation to the direction of the Edge 0 = in the direction of Edge 1 = in opposite direction
EDGELEVE	2	I	<S>	-9	99	Relative height level of end Node of the last Edge defining the Line Feature; field shall be left empty when NUM_EDGE is zero
NUM_ATT	5	N	Obl	0	99999	Number of Attribute sets
ID_SCOPE	1	A	Obl			Scope switch: whether the Attribute Record referred to by the subsequent field is published locally, semi-globally, or globally. S = locally within same Section L = semi-globally within the Layer this Section belongs to D = globally within Dataset this Section belongs to
ATT_ID	10	N	Obl	1	$2^{32}-1$	Attribute Identifier: ID-number of an [ATTREC] record which contains relevant Attribute values for this Feature
NUM_COMPLX	10	N	Obl	0	$2^{32}-1$	Number of Complex Feature

COMPLEX_ID	10	N	Obl	1	$2^{32}-1$	COMPLEX_ID: Complex Feature which uses this line as a component ⁵⁴
NUM_REL	10	N	Obl	0	$2^{32}-1$	Number of Relationships
REL_ID	10	N	Obl	1	$2^{32}-1$	REL_ID: Relationship which uses this line as a component
NUM_CONV	10	N	Obl	0	$2^{32}-1$	Number of conversion records
CONV_ID	10	N	Obl	1	$2^{32}-1$	CONV_ID: Conversion record which converts this line

NOTE The relative height of Edge levels can be greater than 9 (up to 99) when modelling vertical connectivity of Pathway Features connecting floors in high-rise buildings. When modelling road, rail or water transportation networks, the maximum Edge level is set to +9.

⁵⁴ This pointer identifies Complex Features rendered by the Complex Feature Record for explicit topology (Rec54.01).

12.7.9 Line Feature Record (Non-Explicit Line Topology sub-record) [LIFEREC.03]

Field name	Size	Type	No data	Min.	Max.	Description
REC_DESCR	2	N	Obl			Record Type Code (52)
REC_CODE	2	N	Obl			Record Subtype Code (03)
LINE_ID	10	N	Obl	1	$2^{32}-1$	Line Feature Identifier: ID-number of the Line Feature which is unique within the Section
DESC_ID	5	N	<S>	1	99999	Source Description Identifier
NW_ID	5	N	<S>	1	99999	Network Specification Identifier for the kind of (road) network the Feature is part of
FEAT_CODE	4	N	Obl	1000	9999	Feature Class Code: Code of the Feature Class to which the Feature belongs
SPLIT_IND	1	N	Obl	0	1	Split Indicator: 0 = Line represents an entire Feature 1 = Line represents part of a split Feature
COORD_MASK	4	N	Obl	0	3331	Coordinate Mask: ZHHT value, whereby Z=0 1 2 3; HH= 00 10 20 30 11 21 31 12 22 32 13 23 33; T=0 1.
TIME_MASK	2	N	<S>	1	16	Time Mask: decimal value representing SA/EA/SD/ED occurrence of 16 cases ($2*2*2*2$ combinations). If the fourth position of the COORD_MASK is set to '0', the TIME_MASK shall not be specified (leave field empty).
NUM_COORD	5	N	Obl	2	99999	Number of coordinate tuples of the XY polyline geometry of this Line Feature.
X_COORD	11	I	Obl	-2^{31}	$2^{31}-1$	X Coordinate
Y_COORD	11	I	Obl	-2^{31}	$2^{31}-1$	Y Coordinate
NUM_INTVAL	5	N	0	0	99999	Number of Coordinate Intervals for which Z and/or H1 and/or H2 are constant.
INT_FROM	5	N	Obl	1	99999	From position of begin of polyline interval within range of NUM_COORD shape points.
DD_NUM_Z	5	N	Obl	0	99999	Discrete Dynamic Counter of number of Z coordinates of the polyline geometry of this Line

						<p>Feature. This counter can assume the following states:</p> <p>0 = no occurrence of Z coordinates</p> <p>1 = constant Z coordinate for whole polyline</p> <p>NUM_INTVAL* = constant Z coordinate per interval</p> <p>NUM_COORD* = individual Z coordinate per XY position</p> <p>(* NUM_INTVAL and NUM_COORD as instantiated in the record at hand)</p> <p>Z Coordinate</p>
Z_COORD	11	I	Obl	-2^{31}	$2^{31}-1$	
DD_NUM_H1	5	N	Obl	0	99999	<p>Discrete Dynamic Counter of number of H1 coordinates of the polyline geometry of this Line Feature. This counter can assume the following states:</p> <p>0 = no occurrence of H1 coordinates</p> <p>1 = constant H1 coordinate for whole polyline</p> <p>NUM_INTVAL = constant H1 coordinate per interval</p> <p>NUM_COORD = individual H1 coordinate per XY position</p> <p>(* NUM_INTVAL and NUM_COORD as instantiated in the record at hand)</p>
H1_COORD	11	I	<S>	-2^{31}	$2^{31}-1$	Upper Object Elevation
DD_NUM_H2	5	N	Obl	0	99999	<p>Discrete Dynamic Counter of number of H2 coordinates of the polyline geometry of this Line Feature. This counter can assume the following states:</p> <p>0 = no occurrence of H2 coordinates</p> <p>1 = constant H2 coordinate for whole polyline</p> <p>NUM_INTVAL = constant H2 coordinate per interval</p> <p>NUM_COORD = individual H2 coordinate per XY position</p> <p>This counter must be '0' in case the counter for H1 coordinates is set to '0'.</p> <p>(* NUM_INTVAL and NUM_COORD as instantiated in the record at hand)</p>

H2_COORD	11	I	<S>	-2^{31}	$2^{31}-1$	Lower Object Elevation
NUM_TIME	1	N	Obl	0	1	Number of T coordinate tuples of the polyline geometry of this Line Feature, specifying whether T coordinates are present or not.
T_SA_COORD	10	N	<S>	1000010100	9999123123	T Coordinate SA (Start Appearance) (YYYYMMDDHH)
T_EA_COORD	10	N	<S>	1000010100	9999123123	T Coordinate EA (End Appearance) (YYYYMMDDHH)
T_SD_COORD	10	N	<S>	1000010100	9999123123	T Coordinate SD (Start Disappearance) (YYYYMMDDHH)
T_ED_COORD	10	N	<S>	1000010100	9999123123	T Coordinate ED (End Disappearance) (YYYYMMDDHH)
NUM_ATT	5	N	Obl	0	99999	Number of Attribute sets
ID_SCOPE	1	A	Obl			Scope switch: whether the Attribute Record referred to by the subsequent field is published locally, semi-globally, or globally. S = locally within same Section L = semi-globally within the Layer this Section belongs to D = globally within Dataset this Section belongs to
ATT_ID	10	N	Obl	1	$2^{32}-1$	Attribute Identifier: ID-number of a [ATTREC] record which contains relevant Attribute values for this Feature
NUM_COMPLX	10	N	Obl	0	$2^{32}-1$	Number of Complex Features
COMPLEX_ID	10	N	Obl	1	$2^{32}-1$	COMPLEX_ID: Complex Feature which uses this point as a component ⁵⁵
NUM_REL	10	N	Obl	0	$2^{32}-1$	Number of Relationships
REL_ID	10	N	Obl	1	$2^{32}-1$	REL_ID: Relationship which uses this line as a component
NUM_CONV	10	N	Obl	0	$2^{32}-1$	Number of conversion records
CONV_ID	10	N	Obl	1	$2^{32}-1$	CONV_ID: Conversion record which converts this line

⁵⁵ This pointer identifies Complex Features rendered by the Complex Feature Record for non-explicit topology (Rec54.03).

12.7.10 Area Feature Record (Full Rendering Area Topology sub-record) [ARFEREC.01]

Field name	Size	Type	No data	Min.	Max.	Description
REC_DESCR	2	N	Obl			Record Type Code (53)
REC_CODE	2	N	Obl			Record Subtype Code (01)
AREA_ID	10	N	Obl	1	$2^{32}-1$	Area Feature Identifier: ID-number of the Area Feature which is unique within the Section
DESC_ID	5	N	<S>	1	99999	Source Description Identifier
NW_ID	5	N	<S>	1	99999	Network Specification Identifier for the kind of (road) network the Feature is part of
FEAT_CODE	4	N	Obl	1000	9999	Feature Class Code: Code of the Feature Class to which the Feature belongs
SPLIT_IND	1	N	Obl	0	1	Split Indicator: 0 = Area represents an entire Feature 1 = Area represents part of a split Feature
NUM_FACE	10	N	Obl	0	$2^{32}-1$	Number of Faces. It is allowable to have a Face-less Area Feature.
FACE_ID	10	N	Obl	1	$2^{32}-1$	Face Identifier: ID-number of a Face which is a component of the Area Feature
NUM_ATT	5	N	Obl	0	99999	Number of Attribute sets
ID_SCOPE	1	A	Obl			Scope switch: whether the Attribute Record referred to by the subsequent field is published locally, semi-globally, or globally. S = locally within same Section L = semi-globally within the Layer this Section belongs to D = globally within Dataset this Section belongs to
ATT_ID	10	N	Obl	1	$2^{32}-1$	Attribute Identifier: ID-number of a [ATTREC] record which contains Attribute values for this Area Feature
NUM_COMPLX	10	N	Obl	0	$2^{32}-1$	Number of Complex Features
COMPLEX_ID	10	N	Obl	1	$2^{32}-1$	COMPLEX_ID: Complex Feature which uses this area as a component ⁵⁶
NUM_REL	10	N	Obl	0	$2^{32}-1$	Number of Relationships
REL_ID	10	N	Obl	1	$2^{32}-1$	REL_ID: Relationship which uses this area as a component
NUM_CONV	10	N	Obl	0	$2^{32}-1$	Number of conversion records
CONV_ID	10	N	Obl	1	$2^{32}-1$	CONV_ID: Conversion record which converts this area

⁵⁶ This pointer identifies Complex Features rendered by the Complex Feature Record for explicit topology (Rec54.01).

12.7.11 Area Feature (Connectivity Rendering Area Topology sub-record) [ARFEREC.02]

Field name	Size	Type	No data	Min.	Max.	Description
REC_DESCR	2	N	Obl			Record Type Code (53)
REC_CODE	2	N	Obl			Record Subtype Code (02)
AREA_ID	10	N	Obl	1	$2^{32}-1$	Area Feature Identifier: ID-number of the Area Feature which is unique within the Section
DESC_ID	5	N	<S>	1	99999	Source Description Identifier
NW_ID	5	N	<S>	1	99999	Network Specification Identifier for the kind of (road) network the Feature is part of
FEAT_CODE	4	N	Obl	1000	9999	Feature Class Code: Code of the Feature Class to which the Feature belongs
SPLIT_IND	1	N	Obl	0	1	Split Indicator: 0 = Area represents an entire Feature 1 = Area represents part of a split Feature
NUM_EDGE	10	N	Obl	0	$2^{32}-1$	Number of Edges. It is allowable to have a edge-less Area Feature.
EDGE_ID	10	N	Obl	1	$2^{32}-1$	ID-number of an Edge bounding the Area Feature
ORIENT	1	N	Obl	0	1	Edge Orientation: Indication of the orientation of the Edge on the Area border 0 = Clockwise 1 = Counterclockwise
NUM_ATT	5	N	Obl	0	99999	Number of Attribute sets
ID_SCOPE	1	A	Obl			Scope switch: whether the Attribute Record referred to by the subsequent field is published locally, semi-globally, or globally. S = locally within same Section L = semi-globally within the Layer this Section belongs to D = globally within Dataset this Section belongs to
ATT_ID	10	N	Obl	1	$2^{32}-1$	Attribute Identifier: ID-number of an [ATTREC] record which contains Attribute values for this Area Feature
NUM_COMPLX	10	N	Obl	0	$2^{32}-1$	Number of Complex Features
COMPLEX_ID	10	N	Obl	1	$2^{32}-1$	COMPLEX_ID: Complex Feature which uses this point as a component ⁵⁷
NUM_REL	10	N	Obl	0	$2^{32}-1$	Number of Relationships
REL_ID	10	N	Obl	1	$2^{32}-1$	REL_ID: Relationship which uses this area as a component

⁵⁷ This pointer identifies Complex Features rendered by the Complex Feature Record for explicit topology (Rec54.01).

NUM_CONV	10	N	Obl	0	$2^{32}-1$	Number of conversion records
CONV_ID	10	N	Obl	1	$2^{32}-1$	CONV_ID: Conversion record which converts this area

12.7.12 Area Feature (Non-explicit Area Topology sub-record) [ARFEREC.03]

Field name	Size	Type	No data	Min.	Max.	Description
REC_DESCR	2	N	Obl			Record Type Code (53)
REC_CODE	2	N	Obl			Record Subtype Code (03)
AREA_ID	10	N	Obl	1	$2^{32}-1$	Area Feature Identifier: ID-number of the Area Feature which is unique within the Section
DESC_ID	5	N	<S>	1	99999	Source Description Identifier
NW_ID	5	N	<S>	1	99999	Network Specification Identifier for the kind of (road) network the Feature is part of
FEAT_CODE	4	N	Obl	1000	9999	Feature Class Code: Code of the Feature Class to which the Feature belongs
SPLIT_IND	1	N	Obl	0	1	Split Indicator: 0 = Area represents an entire Feature 1 = Area represents part of a split Feature
COORD_MASK	4	N	Obl	0	3331	Coordinate Mask: ZHHT value, whereby Z=0 1 2 3; HH= 00 10 20 30 11 21 31 12 22 32 13 23 33; T=0 1.
TIME_MASK	2	N	<S>	1	16	Time Mask: decimal value representing SA/EA/SD/ED occurrence of 16 cases ($2*2*2*2$ combinations). If the fourth position of the COORD_MASK is set to '0', the TIME_MASK shall not be specified (leave field empty).
NUM_COORD	5	N	Obl	3	99999	Number of coordinate tuples of the XY geometry of the Polygon.
X_COORD	11	I	Obl	-2^{31}	$2^{31}-1$	X Coordinate
Y_COORD	11	I	Obl	-2^{31}	$2^{31}-1$	Y Coordinate
NUM_INTVAL	5	N	0	0	99999	Number of Coordinate Intervals for which Z and/or H1 and/or H2 are constant.
INT_FROM	5	N	Obl	1	99999	From position of begin of polygon interval within range of NUM_COORD shape points.
DD_NUM_Z	5	N	Obl	0	99999	Discrete Dynamic Counter of number of Z coordinates of the polygon geometry of this Area

Z_COORD	11	I	Obl	-2^{31}	$2^{31}-1$	<p>Feature. This counter can assume the following states:</p> <p>0 = no occurrence of Z coordinates</p> <p>1 = constant Z coordinate for whole polyline</p> <p>NUM_INTVAL* = constant Z coordinate per interval</p> <p>NUM_COORD* = individual Z coordinate per XY position</p> <p>(* NUM_INTVAL and NUM_COORD as instantiated in the record at hand)</p> <p>Z Coordinate</p>
DD_NUM_H1	5	N	Obl	0	99999	<p>Discrete Dynamic Counter of number of H1 coordinates of the polygon geometry of this Area Feature. This counter can assume the following states:</p> <p>0 = no occurrence of H1 coordinates</p> <p>1 = constant H1 coordinate for whole polyline</p> <p>NUM_INTVAL = constant H1 coordinate per interval</p> <p>NUM_COORD = individual H1 coordinate per XY position</p> <p>(* NUM_INTVAL and NUM_COORD as instantiated in the record at hand)</p>
H1_COORD	11	I	<S>	-2^{31}	$2^{31}-1$	<p>Upper Object Elevation</p>
DD_NUM_H2	5	N	Obl	0	99999	<p>Discrete Dynamic Counter of number of H2 coordinates of the polygon geometry of this Area Feature. This counter can assume the following states:</p> <p>0 = no occurrence of H2 coordinates</p> <p>1 = constant H2 coordinate for whole polyline</p> <p>NUM_INTVAL = constant H2 coordinate per interval</p> <p>NUM_COORD = individual H2 coordinate per XY position</p> <p>This counter must be '0' in case the counter for H1 coordinates is set to '0'.</p> <p>(* NUM_INTVAL and NUM_COORD as instantiated in the record at hand)</p>

H2_COORD	11	I	<S>	-2^{31}	$2^{31}-1$	Lower Object Elevation
NUM_TIME	1	N	Obl	0	1	Number of T coordinate tuples of the polygon geometry of this Area Feature, specifying whether T coordinates are present or not.
T_SA_COORD	10	N	<S>	1000010100	9999123123	T Coordinate SA (Start Appearance) (YYYYMMDDHH)
T_EA_COORD	10	N	<S>	1000010100	9999123123	T Coordinate EA (End Appearance) (YYYYMMDDHH)
T_SD_COORD	10	N	<S>	1000010100	9999123123	T Coordinate SD (Start Disappearance) (YYYYMMDDHH)
T_ED_COORD	10	N	<S>	1000010100	9999123123	T Coordinate ED (End Disappearance) (YYYYMMDDHH)
NUM_ATT	5	N	Obl	0	99999	Number of Attribute sets
ID_SCOPE	1	A	Obl			Scope switch: whether the Attribute Record referred to by the subsequent field is published locally, semi-globally, or globally. S = locally within same Section L = semi-globally within the Layer this Section belongs to D = globally within Dataset this Section belongs to
ATT_ID	10	N	Obl	1	$2^{32}-1$	Attribute Identifier: ID-number of a [ATTREC] record which contains Attribute values for this Area Feature
NUM_EXTGEO	1	N	Obl	0	1	Number flagging the presence of Extended area geometry information
GEO_TYPE	1	N	<S>	0	4	Geometrical Type of bounded area 3 = Triangular 4 = Quadrangular 0 = Other
OUT_LENGTH	10	N	<S>	0	$2^{32}-1$	Outline Length of bounded area, expressed in decimetres
SIZE	10	N	<S>	0	$2^{32}-1$	Size of bounded area, expressed in square metres
SLOPE	3	N	<S>	0	999	Slope of bounded area, representing the (maximum) inclination, expressed as positive percentage
ASPECT	4	N	<S>	0	3599	Aspect of bounded area, representing the horizontal bearing of slope vector

						(maximum inclination), expressed as clockwise angle against North measured in 1/10 of a degree
LIGHT_VAL	3	N	<S>	0	255	Light Value of bounded area, representing an artificial hill shade, expressed as a grey scale
NUM_COMPLX	10	N	Obl	0	$2^{32}-1$	Number of Complex Feature
COMPLEX_ID	10	N	Obl	1	$2^{32}-1$	COMPLEX_ID: Complex Feature which uses this point as a component ⁵⁸
NUM_REL	10	N	Obl	0	$2^{32}-1$	Number of Relationships
REL_ID	10	N	Obl	1	$2^{32}-1$	REL_ID: Relationship which uses this area as a component
NUM_CONV	10	N	Obl	0	$2^{32}-1$	Number of conversion records
CONV_ID	10	N	Obl	1	$2^{32}-1$	CONV_ID: Conversion record which converts this area

⁵⁸ This pointer identifies Complex Features rendered by the Complex Feature Record for non-explicit topology (Rec54.03).

12.7.13 Complex Feature Record (Explicit Complex Topology sub-record) [COFEREC.01]

Field name	Size	Type	No data	Min.	Max.	Description
REC_DESCR	2	N	Obl			Record Type Code (54)
REC_CODE	2	N	Obl			Record Subtype Code (01)
COMPLEX_ID	10	N	Obl	1	$2^{32}-1$	Complex Feature Identifier: ID-number of this Complex Feature
DESC_ID	5	N	<S>	1	99999	Source Description Identifier
NW_ID	5	N	<S>	1	99999	Network Specification Identifier for the kind of (road) network the Feature is part of
FEAT_CODE	4	N	Obl	1000	9999	Feature Class Code: Code of the Feature Class to which the Feature belongs
CMPSPLTIND	1	N	Obl	0	2	Split Indicator: 0 = Complex represents an entire Feature 1 = Complex represents part of a split Feature 2 = The definition is repeated in another Section
NUM_PARTS	5	N	Obl	0	99999	Number of Feature parts
FEAT_CAT	2	N	Obl	1	4	Feature Category Code: Feature Category of the Feature referred to in the next field 1 = Point 2 = Line 3 = Area 4 = Complex
FEAT_ID	10	N	Obl	1	$2^{32}-1$	Feature Identifier: ID-number of a Point, Line, Area or other Complex Feature which is an element of the Complex Feature in issue.
NUM_ATT_P	5	N	Obl	0	99999	Number of Attribute sets per part
ID_SCOPE_P	1	A	Obl			Scope switch: whether the Attribute Record referred to by the subsequent field is published locally, semi-globally, or globally. S = locally within same Section L = semi-globally within the Layer this Section belongs to D = globally within Dataset this Section belongs to
ATT_ID_P	10	N	Obl	1	$2^{32}-1$	Attribute Identifier of Feature part: ID-number of an [ATTREC] record which contains relevant Attribute values for this Feature part at hand within this Complex Feature

NUM_ATT	5	N	Obl	0	99999	Number of Attribute sets
ID_SCOPE	1	A	Obl			Scope switch: whether the Attribute Record referred to by the subsequent field is published locally, semi-globally, or globally. S = locally within same Section L = semi-globally within the Layer this Section belongs to D = globally within Dataset this Section belongs to
ATT_ID	10	N	Obl	1	$2^{32}-1$	Attribute Identifier: ID-number of an [ATTREC] record which contains relevant Attribute values for this Feature
FROM_ID	10	N	<S>	1	$2^{32}-1$	From Complex Feature Identifier: The ID-number of the first bounding Complex Feature of this Complex Feature
TO_ID	10	N	<S>	1	$2^{32}-1$	To Complex Feature Identifier: The ID-number of the last bounding Complex Feature
NUM_COMPLX	10	N	Obl	0	$2^{32}-1$	Number of Complex Features
COMPLEX_ID	10	N	Obl	1	$2^{32}-1$	COMPLEX_ID: Complex Feature which uses this Complex Feature as a component ⁵⁹
NUM_BP_FT	10	N	Obl	0	$2^{32}-1$	Number of reverse pointer Features
FEAT_ID_FT	10	N	Obl	1	$2^{32}-1$	Feature ID number of a Complex Feature (spoke) which uses this point as a boundary (hub), acting as reversed from/to pointer
NUM_REL	10	N	Obl	0	$2^{32}-1$	Number of Relationships
REL_ID	10	N	Obl	1	$2^{32}-1$	REL_ID: Relationship which uses this complex record is a component
NUM_CONV	10	N	Obl	0	$2^{32}-1$	Number of conversion records
CONV_ID	10	N	Obl	1	$2^{32}-1$	CONV_ID: Conversion record which converts this Complex Feature

⁵⁹This pointer identifies Complex Features rendered by the Complex Feature Record for explicit topology (Rec54.01).

12.7.14 Complex Feature Record (Non-explicit Complex Topology sub-record) [COFEREC.03]

Field name	Size	Type	No data	Min.	Max.	Description
REC_DESCR	2	N	Obl			Record Type Code (54)
REC_CODE	2	N	Obl			Record Subtype Code (03)
COMPLEX_ID	10	N	Obl	1	$2^{32}-1$	Complex Feature Identifier: ID-number of this Complex Feature
DESC_ID	5	N	<S>	1	99999	Source Description Identifier
NW_ID	5	N	<S>	1	99999	Network Specification Identifier for the kind of (road) network the Feature is part of
FEAT_CODE	4	N	Obl	1000	9999	Feature Class Code: Code of the Feature Class to which the Feature belongs
CMPSPILTIND	1	N	Obl	0	2	Split Indicator: 0 = Complex represents an entire Feature 1 = Complex represents part of a split Feature 2 = The definition is repeated in another Section
NUM_PARTS	5	N	Obl	0	99999	Number of Feature parts
FEAT_CAT	2	N	Obl	1	4	Feature Category Code: Feature Category of the Feature referred to in the next field 1 = Point 2 = Line 3 = Area 4 = Complex
FEAT_ID	10	N	Obl	1	$2^{32}-1$	Feature Identifier: ID-number of a Point, Line, Area or other Complex Feature which is an element of the Complex Feature in issue.
NUM_ATT_P	5	N	Obl	0	99999	Number of Attribute sets per part
ID_SCOPE_P	1	A	Obl			Scope switch: whether the Attribute Record referred to by the subsequent field is published locally, semi-globally, or globally. S = locally within same Section L = semi-globally within the Layer this Section belongs to D = globally within Dataset this Section belongs to
ATT_ID_P	10	N	Obl	1	$2^{32}-1$	Attribute Identifier of Feature part: ID-number of an [ATTREC] record which contains relevant Attribute values for this Feature part at hand within this Complex Feature
NUM_ATT	5	N	Obl	0	99999	Number of Attribute sets
ID_SCOPE	1	A	Obl			Scope switch: whether the Attribute Record referred to by the subsequent field is published locally, semi-globally, or globally.

						S = locally within same Section
						L = semi-globally within the Layer this Section belongs to
						D = globally within Dataset this Section belongs to
ATT_ID	10	N	Obl	1	$2^{32}-1$	Attribute Identifier: ID-number of an [ATTREC] record which contains relevant Attribute values for this Feature
NUM_COMPLX	10	N	Obl	0	$2^{32}-1$	Number of Complex Feature
COMPLEX_ID	10	N	Obl	1	$2^{32}-1$	COMPLEX_ID: Complex Feature which uses this Complex Feature as a component ⁶⁰
NUM_REL	10	N	Obl	0	$2^{32}-1$	Number of Relationships
REL_ID	10	N	Obl	1	$2^{32}-1$	REL_ID: Relationship which uses this complex record is a component
NUM_CONV	10	N	Obl	0	$2^{32}-1$	Number of conversion records
CONV_ID	10	N	Obl	1	$2^{32}-1$	CONV_ID: Conversion record which converts this Complex Feature

⁶⁰This pointer identifies Complex Features rendered by the Complex Feature Record for non-explicit topology (Rec54.03).

12.7.15 Conversion Record [CONVERTREC]

Field name	Size	Type	No data	Min.	Max.	Description
REC_DESCR	2	N	Obl			Record Type Code (46)
CONV_ID	10	N	Obl	1	$2^{32}-1$	Conversion Record Identifier: Identification number of this conversion record which is unique within the set of all Conversion Records in the Dataset
FEAT_CAT_I	2	N	Obl	1	4	Internal Feature Category Code: Feature Category of the Feature referred to by Internal Feature Identifier 1 = Point 2 = Line 3 = Area 4 = Complex
INT_ID	10	N	Obl	1	$2^{32}-1$	Internal Feature Identifier: ID-number of the Point, Line, Area or Complex Feature converted into the ID reference system of the present Section
NUM_FEAT	5	N	Obl	1	99999	Number of Features
DASET_ID	10	N	Obl	1	$2^{32}-1$	Dataset Identifier: ID-number of a foreign Dataset
LAY_ID	10	N	Obl	1	$2^{32}-1$	Layer Identifier: ID number of the foreign Layer
SECT_ID	10	N	Obl	1	$2^{32}-1$	Section Identifier: number of a foreign Section
FEAT_CAT_F	2	N	Obl	1	4	Foreign Feature Category Code: Feature Category of the Feature referred to by Foreign Feature Identifier 1 = Point 2 = Line 3 = Area 4 = Complex
EXT_ID	10	N	Obl	1	$2^{32}-1$	Foreign Feature Identifier: ID-number of a Point, Line, Area or Complex Feature within the system of the foreign Section

12.7.16 Attribute Record [ATTREC]

Field name	Size	Type	No data	Min.	Max.	Description
REC_DESCR	2	N	Obl			Record type code (44)
ATT_ID	10	N	Obl	1	$2^{32}-1$	Attribute Identifier: ID-number of this Attribute record which is unique within the Section
NUM_ATT	5	I	Obl	1	99999	Number of Attributes
COUNT_LF_(1	N	Obl	0	9	Count of left parentheses that logically would be needed to contain an Attribute or Composite Attribute, and all of their Restrictive Attributes
ATT_TYPE	2	G	Obl			Attribute Type Code
DESC_ID	5	N	<S>	1	99999	Source Description Identifier: ID-number of a source document
ID_SCOPE	1	A	<S> ⁶¹			Scope switch: whether the Record ⁶² referred to by the subsequent field is published locally, semi-globally, or globally ⁶³ . S = locally within same Section, when appropriate L = semi-globally within the Layer this Record belongs to, when appropriate D = globally within Dataset this Record belongs to
ATT_VAL	11	G	<S>			Attribute Value
COUNT_RT_)	1	N	Obl	0	9	Count of right parentheses that logically would be needed to contain an Attribute or Composite Attribute, and all of their Restrictive Attributes
NUM_FEAT	5	N	Obl	0	99999	Number of Features
FEAT_CAT	2	N	Obl	1	4	Feature Category Code: Feature Category of the Feature referred to in the next field 1 = Point 2 = Line 3 = Area 4 = Complex
LAY_ID	10	N	<S> ⁶⁴	1	$2^{32}-1$	Layer Identifier: ID number of the Layer within which the Section containing the Feature resides. The Layer ID has to be provided if the Attribute referring to the Feature resides at a scope level higher than the Layer.

⁶¹ ID_SCOPE is not applicable (and not to be specified) in case that ATT_VAL contains an actual attribute value and not a pointer

⁶² Pointer to Text Record or Time Domain Record

⁶³ Text Record and Time Domain Record have to be published at the same or a higher scope level as the attribute in question (e.g. an attribute on layer level must not refer to an text record specified within a particular section)

SECT_ID	10	N	<S> ⁶⁵	1	2 ³² -1	Section Identifier: ID number of the Section within which the Feature resides. The Section ID has to be provided if the Attribute referring to the Feature resides at a scope level higher than the Section.
FEAT_ID	10	N	Obl	1	2 ³² -1	Feature Identifier: ID-number of a Point, Line, Area or Complex Feature which uses this Attribute
NUM_TEXT	10	N	Obl	0	2 ³² -1	Number of text records
LAY_ID	10	N	<S> ⁶⁶	0	2 ³² -1	Layer Identifier: ID number of the Layer within which the text record referred to by the Attribute resides. The Layer ID has to be provided if the Attribute referring to the text record resides at a scope level higher than the text record, and this Attribute record resides at a scope level higher than the Layer (i.e. the Dataset level).
SECT_ID	10	N	<S> ⁶⁷	0	2 ³² -1	Section Identifier: ID number of the Section within which the text record referred to by the Attribute resides. The Section ID has to be provided if the Attribute referring to the text record resides at a scope level higher than the text record, and this Attribute record resides at a scope level higher than the Section (i.e. the Dataset level or the Layer level).
TEXT_ID	10	N	Obl	1	2 ³² -1	TEXT_ID: Text Record which uses this Attribute
NUM_REL	10	N	Obl	0	2 ³² -1	Number of Relationships
LAY_ID	10	N	<S> ⁶⁸	0	2 ³² -1	Layer Identifier: ID number of the Layer within which the Relationship referred to by the Attribute resides. The Layer ID has to be provided if the Attribute referring to the Relationship resides at a scope level higher than the Relationship, and this Attribute record resides at a scope level higher than the Layer (i.e. the Dataset level).

⁶⁴ Depending on the scope level of the attribute, the Layer Identifier is either specified if applicable (global attribute on Dataset level), or left empty if not applicable (local or semi-global attribute on Layer or Section level), respectively. In the latter case the Layer ID of the referring attribute and the referred-to feature are the same.

⁶⁵ Depending on the scope level of the attribute, the Section Identifier is either specified if applicable (global or semi-global attribute on Layer or Section level), or left empty if not applicable (local attribute on Section level), respectively. In the latter case the Section ID of the referring attribute and the referred-to feature are the same.

⁶⁶ Depending on the scope levels of the attribute and the text records which it back points to, the Layer Identifier is either specified (global attribute on Dataset level and a text record at a lower scope level), rendered as a 'zero' (attribute record and the referred-to text record residing on the Dataset level), or left empty if not applicable (local or semi-global attribute as well as text records on Layer or Section level, whereby the attribute scope level is higher or equal to the text record), respectively.

⁶⁷ Depending on the scope levels of the attribute and the text records which it back points to, the Section Identifier is either specified (global or semi-global attribute on Layer or Section level and a text record at the local scope level of the section level), rendered as a 'zero' (attribute record on and the referred-to text record residing on the Dataset or Layer level, whereby the attribute scope level is higher or equal to the text record), or left empty if not applicable (local attribute as well as text records on Section level), respectively.

SECT_ID	10	N	<S> ⁶⁹	0	$2^{32}-1$	Section Identifier: ID number of the Section within which the Relationship referred to by the Attribute resides. The Section ID has to be provided if the Attribute referring to the Relationship resides at a scope level higher than the Relationship, and this Attribute record resides at a scope level higher than the Section (i.e. the Dataset level or the Layer level).
REL_ID	10	N	Obl	1	$2^{32}-1$	REL_ID: Relationship which uses this Attribute

⁶⁸Depending on the scope levels of the attribute and the relationship which it back points to, the Layer Identifier is either specified (global attribute on Dataset level and a relationship at a lower scope level), rendered as a 'zero' (attribute record and the referred-to relationship residing on the Dataset level), or left empty if not applicable (local or semi-global attribute as well as relationship on Layer or Section level, whereby the attribute scope level is higher or equal to the relationship), respectively.

⁶⁹Depending on the scope levels of the attribute and the relationship which it back points to, the Section Identifier is either specified (global or semi-global attribute on Layer or Section level and a relationship at the local scope level of the section level), rendered as a 'zero' (attribute record on and the referred-to relationship residing on the Dataset or Layer level, whereby the attribute scope level is higher or equal to the relationship), or left empty if not applicable (local attribute as well as relationship on Section level), respectively.

12.7.17 Relationship Record [RELATREC]

Field name	Size	Type	No data	Min.	Max.	Description
REC_DESCR	2	N	Obl			Record Type Code (50)
REL_ID	10	N	Obl	1	$2^{32}-1$	Relationship Identifier: ID-number of this Relationship which is unique within the Section
DESC_ID	5	N	<S>	1	99999	Source Description Identifier: ID-number of a source document
REL_CODE	4	N	Obl	1000	9999	Relationship Code: Code of the Relationship Type to which the Relationship belongs
NUM_FEAT	5	N	Obl	2	99999	Number of Features
FEAT_CAT	2	N	<S>	1	4	Feature Category Code: Feature Category of the Feature referred to by the next field 1 = Point 2 = Line 3 = Area 4 = Complex
DASET_ID	10	N	<S>	1	$2^{32}-1$	Dataset Identifier: ID-number of the Dataset of the partner Feature. If Dataset ID is not provided the Feature resides in the current Dataset
LAY_ID	10	N	<S>	1	$2^{32}-1$	Layer Identifier: ID-number of the Layer of the partner Feature. If Layer ID is not provided the Feature resides in the current Layer. The Layer ID has to be provided if the Relationship at hand resides at a scope level higher than the Layer.
SECT_ID	10	N	<S>	1	$2^{32}-1$	Section Identifier: ID-number of the Section of the partner Feature. If Section ID is not provided the Feature resides in the current Section. The Section ID has to be provided if the Relationship at hand resides at a scope level higher than the Section.
FEAT_ID	10	N	<S>	1	$2^{32}-1$	Feature Identifier: ID-number of a Point, Line, Area or Complex Feature which is a partner in the Relationship in issue
FROLE_NUM	2	N	Obl	1	99	Declaration of the role that this Relationship partner (Feature) plays
NUM_ATT_P	5	N	Obl	0	99999	Number of Attribute sets per partner
ID_SCOPE_P	1	A	Obl			Scope switch: whether the Attribute Record referred to by the subsequent field is published locally, semi-globally, or globally ⁷⁰ .

⁷⁰ Attributes for a partner in the relationship have to be published at the same or a higher scope level as the relationship in question. Partner attributes are inseparable from the relationship itself and only meaningful to features as partners in said relationship within its appropriate scope level.

						S = locally within same Section
						L = semi-globally within the Layer this Section belongs to
						D = globally within Dataset this Section belongs to
ATT_ID_P	10	N	Obl	1	$2^{32}-1$	Attribute Identifier of Feature partner: ID-number of an [ATTREC] record which contains relevant Attribute values for Feature partner(s) in the role at hand within this Relationship
NUM_ATT	5	N	Obl	0	99999	Number of Attribute sets
ID_SCOPE	1	A	Obl			Scope switch: whether the Attribute Record referred to by the subsequent field is published locally, semi-globally, or globally ⁷¹ .
						S = locally within same Section, when appropriate
						L = semi-globally within the Layer this Section belongs to, when appropriate
						D = globally within Dataset this Section belongs to
ATT_ID	10	N	Obl	1	$2^{32}-1$	Attribute Identifier: ID-number of an [ATTREC] record which contains relevant Attribute values for this Relationship

⁷¹ Attributes for the entire relationship have to be published at the same or a higher scope level as the relationships in question (e.g. a relationship on layer level must not refer to an attribute specified within a particular section)

12.7.18 Text Record [TEXTREC]

Field name	Size	Type	No data	Min.	Max.	Description
REC_DESCR	2	N	Obl			Record Type Code (41)
TEXT_ID	10	N	Obl	1	$2^{32}-1$	Text Identifier: An identification number of this text record which is unique within a Section
DESC_ID	5	N	<S>	1	99999	Source Description Identifier: ID-number of a source document
NUM_ATT	5	N	Obl	0	99999	Number of Attribute sets
ID_SCOPE	1	A	Obl			Scope switch: whether the Attribute Record referred to by the subsequent field is published locally, semi-globally, or globally ⁷² . S = locally within same Section L = semi-globally within the Layer this Section belongs to D = globally within Dataset this Section belongs to
ATT_ID	10	N	Obl	1	$2^{32}-1$	Attribute ID ; ID number of an [ATTREC].record which contains relevant Attribute values for this text record
NUM_ATT_BP	10	N	Obl	0	$2^{32}-1$	Number of Attribute back pointers
LAY_ID	10	N	<S> ⁷³	0	$2^{32}-1$	Layer Identifier: ID number of the Layer within which the Attribute referred to by the text record resides. The Layer ID has to be provided if the text record referring to the Attribute resides at a scope level higher than the Attribute record, and this text record resides at a scope level higher than the Layer (i.e. the Dataset level).
SECT_ID	10	N	<S> ⁷⁴	0	$2^{32}-1$	Section Identifier: ID number of the Section within which the Attribute referred to by the text record resides. The Section ID has to be provided if the text record referring to the Attribute resides at a scope level higher than the Attribute record, and this text record resides at a scope level higher than the Section (i.e. the Dataset level or the Layer level).

⁷² Attributes have to be published at the same or a higher scope level as the text record in question (e.g. a text record on layer level must not refer to an attribute specified within a particular section)

⁷³ Depending on the scope levels of the text record and the attribute records which it back points to, the Layer Identifier is either specified (global text record on Dataset level and an attribute record at a lower scope level), rendered as a 'zero' (text record and the referred-to attribute record both residing on the Dataset level), or left empty if not applicable (local or semi-global text record as well as attribute records on Layer or Section level, whereby the text record level is higher or equal to the attribute record), respectively.

⁷⁴ Depending on the scope level of the text record and the attribute records which it back points to, the Section Identifier is either specified (global or semi-global text record on Layer or Section level and an attribute record at the local scope level of the Section level), rendered as a 'zero' (text record on and the referred-to attribute record residing on the Dataset or Layer scope levels, whereby the text record scope level is higher or equal to the attribute record), or left empty if not applicable (local text as well as attribute records on Section level), respectively.

ATT_ID_BP	10	N	Obl	1	$2^{32}-1$	ATT_ID: Attribute Identifier which points to an Attribute which uses this text record as a value
LAN_CODE	3	A	<S>			Language Code: ISO 639-2 language code [1] of the text specified in the next field
TEXT	*	L	<S>			Text

12.7.19 Time Domain Record [TIMEREC]

Field name	Size	Type	No data	Min.	Max.	Description
REC_DESCR	2	N	Obl			Record Type Code (45)
TIME_ID	10	N	Obl	1	$2^{32}-1$	Time Domain Identifier: An identification number of this time domain record which is unique within a Section
DESC_ID	5	N	<S>	1	99999	Description Identifier: ID-number of a source document
NUM_ATT_BP	10	N	Obl	0	$2^{32}-1$	Number of Attribute back pointers
LAY_ID	10	N	<S> ⁷⁵	0	$2^{32}-1$	Layer Identifier: ID number of the Layer within which the Attribute referred to by the time domain resides. The Layer ID has to be provided if the time domain referring to the Attribute resides at a scope level higher than the Attribute record, and this time domain record resides at a scope level higher than the Layer (i.e. the Dataset level).
SECT_ID	10	N	<S> ⁷⁶	0	$2^{32}-1$	Section Identifier: ID number of the Section within which the Attribute referred to by the time domain resides. The Section ID has to be provided if the time domain referring to the Attribute resides at a scope level higher than the Attribute record, and this time domain record resides at a scope level higher than the Section (i.e. the Dataset level or the Layer level).
ATT_ID	10	N	Obl	1	$2^{32}-1$	ATT_ID: Attribute which uses this time domain record
TIME_DOM	*	G	<S>			Time Domain Description

⁷⁵Depending on the scope levels of the time domain record and the attribute records which it back points to, the Layer Identifier is either specified (global time domain record on Dataset level and an attribute record at a lower scope level), rendered as a 'zero' (time domain record and the referred-to attribute record residing on the Dataset scope level), or left empty if not applicable (local or semi-global time domain as well as attribute records on Layer or Section level, whereby the time domain record level is higher or equal to the attribute record), respectively.

⁷⁶Depending on the scope level of the time domain record and the attribute records which it back points to, the Section Identifier is either specified (global or semi-global time domain record on Layer or Section level and an attribute record at the local scope level of the section level), rendered as a 'zero' (time domain record and the referred-to attribute record residing on the Dataset or Layer level, whereby the time domain scope level is higher or equal to the attribute record), or left empty if not applicable (local time domain as well as attribute records on Section level), respectively.

12.7.20 Object Reference Record [OBJREFREC]

Field name	Size	Type	No data	Min.	Max.	Description
REC_DESCR	2	N	Obl			Record Type Code (83)
OBJREF_ID	10	N	Obl	1	$2^{32}-1$	Object Reference Identifier: ID number of this Object Reference Record which is unique within this Section
REC_TYPE	2	N	Obl	1	99	Record Type of referenced record
REF_REC_ID	10	N	Obl	1	$2^{32}-1$	Record ID of referenced record ⁷⁷
OBJREF_TYP	1	A	<S>			User defined type of Object Reference
DATA_TYPE	2	A	Obl			Data Type of the Object Reference Allowed values are N, A, G, L, I and AN
OBJREF_LEN	5	N	Obl	1	99999	Field length of OBJREF
OBJREF	*	*	Obl			Object Reference value

⁷⁷ The Object Reference Record inherits the scope and scope level of the referenced record. In other words, the Object Reference Records resides in the same Section, Layer, or Dataset, respectively, as the object record it references.

12.8 Record Format Specifications: Update Information Records

12.8.1 Geo-topo Update Information Record [UPDIREC.01]

Field name	Size	Type	No data	Min.	Max.	Description
REC_DESCR	2	N	Obl			Record Type Code (89)
REC_CODE	2	N	Obl			Record Subtype Code (01)
UPD_GEO_ID	10	N	Obl	1	$2^{32}-1$	Geo-topo Update Identification Number, which is unique within the system of the producer (supplier) of this Dataset
P_CYCLE	2	N	<S>	0	99	Product Cycle
GEO_CAT	2	N	Obl	1	7	Geometry/Topology Object category: 1 = Node 2 = Edge 3 = Face 4 = Dot 5 = Polyline 6 = Polygon 7 = Coordinate tuple(s)
GEO_ID	10	N	Obl	1	$2^{32}-1$	Geometry/Topology Object Identifier
ACTION	2	N	Obl	0	3	Action Class: 0 = update of source only 1 = New 2 = Delete 3 = Modify
ACT_DATE	20	G	Obl			Action Time Stamp

12.8.2 Object Update Information Record [UPDIREC.02]

Field name	Size	Type	No data	Min.	Max.	Description
REC_DESCR	2	N	Obl			Record Type Code (89)
REC_CODE	2	N	Obl			Record Subtype Code (02)
UPD_OBJ_ID	10	N	Obl	1	$2^{32}-1$	Object Update Identification Number, which is unique within the system of the producer (supplier) of this Dataset
P_CYCLE	2	N	<S>	0	99	Product Cycle
OBJ_CAT	2	N	Obl	1	10	Object category: 1 = Point 2 = Line 3 = Area 4 = Complex 5 = Relationship 6 = Name 7 = Time Domain 8 = Other Text 9 = Geopolitical Structure 10 = Geopolitical Structure Component
OBJ_ID	10	N	Obl	1	$2^{32}-1$	Object Identifier
OBJ_CODE	4	N	<S>	1	9999	Object Class Code Where the object is a Feature the Feature Class Code shall be used. If not, use the following codes: Relationship: 0001 Name: 0002 Time Domain: 0003 Other Text: 0004 Geopolitical Structure: 0005 Geopolitical Structure Component: 0006
ACTION	2	N	Obl	0	3	Action Class: 0 = Update of source only 1 = New 2 = Delete 3 = Modify
ACT_DATE	20	G	Obl			Action Time Stamp

12.8.3 Object Attribute Update Information Record [UPDIREC.03]

Field name	Size	Type	No data	Min.	Max.	Description
REC_DESCR	2	N	Obl			Record Type Code (89)
REC_CODE	2	N	Obl			Record Subtype Code (03)
UPD_ATT_ID	10	N	Obl	1	$2^{32}-1$	Object Attribute Update Identification Number, which is unique within the system of the producer (supplier) of this Dataset
P_CYCLE	2	N	<S>	0	99	Product Cycle
OBJ_CAT	2	N	Obl	1	10	Object category: 1 = Point 2 = Line 3 = Area 4 = Complex 5 = Relationship 6 = Name 7 = Time Domain 8 = Other Text 9 = Geopolitical Structure 10 = Geopolitical Structure Component
OBJ_ID	10	N	Obl	1	$2^{32}-1$	Object Identifier
OBJ_CODE	4	N	<S>	1	9999	Object Class Code Where the object is a Feature the Feature Class Code shall be used. If not, use the following codes: Relationship: 0001 Name: 0002 Time Domain: 0003 Other Text: 0004 Geopolitical Structure: 0005 Geopolitical Structure Component: 0006
ACTION	2	N	Obl	0	3	Action Class: 0 = update of source only 1 = New 2 = Delete 3 = Modify
ACT_DATE	20	G	Obl			Action Time Stamp
NUM_ATT	5	N	Obl	1	99999	Number of Attributes
COUNT_LF_(1	N	Obl	0	9	Count of left parentheses that logically would be needed to contain an Attribute or Composite Attribute, and all of their restrictive Attributes
ATT_TYPE	2	G	Obl			Attribute Type Code
ATT_VAL	11	G	<S>			Attribute Value
COUNT_RT_)	1	N	Obl	0	9	Count of right parentheses that logically would be needed to contain an Attribute or Composite Attribute, and all of their restrictive Attributes

13 XML schema specifications

13.1 Introduction

This clause defines an XML schema for GDF. The schema supports the communication of complete GDF databases in XML form. Technically, the XML schema can be considered a translation of the Media Record Specifications (MRS; see clause 12); the MRS notion of records and fields is therefore reoccurring hereafter. The schema uses the applicable W3C XML references [52][53][54][55][56].

13.1.1 Background

XML (eXtensible Markup Language) is a relatively unstructured method of communicating data based on explicit 'tags' (names) of data elements. XML is an application profile of SGML, the Standard Generalized Markup Language [52]. XML is self-documenting via element tags; the document is expressed in character form. Both sender and receiver have the XML schema defining the tags and the data structures they describe. It is currently very popular and extensive for internet-based communications, and is growing quickly in popularity for both data communication and data structure definition, including within standards.

XML schemas define the structure, content and semantics of XML 'documents' (in this case GDF). Given a schema, data can be communicated automatically, without loss of semantic information. XML also has the very desirable property of being extensible, and hence can be standardized when desired by a user community. Since it was developed for internet use, it supports multiple platforms and languages, and is supported by multiple vendors of tools.

13.1.2 Schema design principles

13.1.2.1 Non-proliferation of global variables (Data Elements)

There is only one global Data Element, specifically a GDF (*gdf*). The primary benefit of this principle is that it ensures that a partial GDF cannot be published, only a complete GDF. It also makes the file easier to read and the root element (*gdf*) easier to find by inspection.

13.1.2.2 Lexical convention

A Lexical Convention was established for the schema, with the following principles:

- Data Elements begin with a lowercase letter;
- Data Types, both simple and complex, begin with an uppercase letter;
- Common abbreviations are used, defined in Table 1;
- Standard prefixes are used for records, defined in Table 2.

Table 1 — Common Abbreviations for GDF XML schema

Word	Abbreviation
album	alb
attribute	attr
border	brdr
category	cat
character	chr
character set	chrset
code	cod

Word	Abbreviation
complex	cmplx
control	cntrl
conversion	conv
coordinate	coord
country	cntry
dataset	dset
definition	def
descriptor	desc
directory	direc
domain	dom
feature	feat
field	fld
field data capture	fdc
global	glb
header	hdr
international	intl
latitude	lat
level	lvl
list	lst
local	lcl
longitude	long
magnetism	mag
name	nam
national	nat
network	netwk
object	obj
orientation	orient
projection	proj
record	rec
relationship	rel
section	sect
source	src
spatial	spat
structure	struct
survey	surv
text	txt
time	tim
type	typ
update	upd
value	val
vertical	vert
volume	vol

Table 2 — Standard Record Prefixes

Record Type	Prefix
Metadata records	MET_
Metadata Album subrecords	MET_ALB_
Metadata Dataset subrecords	MET_DSET_
Metadata Source subrecords	MET_SRC_
Metadata Section Header subrecords	MET_SHR_
Update records	UPD_
Data records are not prefixed	

13.1.2.3 Non-hierarchical structuring of Dataset, Layer, and Section

Elements *dataset_ID*, *layer_ID*, and *section_ID* are included in one mandatory, reusable structure (*DLS*) in order to avoid repetition of the same element in the various data records which use it. Source description identifier (*source_ID*) is a separate, optional element in all data records except for the *Conversion* record and *Attribute* record. This gives flexibility of the components of a GDF file for different uses and users.

13.1.2.4 Rich type-hierarchy

The GDF schema contains many new simple types in order to provide flexibility of design change (through isolation of changes to types), and in order to improve comprehension when reading the code. For example, all record identifiers have types explicit to the record name, but all of those types are of base type *Record_ID*, which is itself of base type *Ten_digit_ID*, an integer of minimum value 1. Future changes, e.g. to the size of identifiers, would entail changing *Record_ID* type only. An example of strong typing is that of the various record identifiers, which all have the base type *Rec_Id*, which is itself of type *Ten_digit_Id*.

13.1.2.5 Record types and sub-types (descriptors and codes) as Attributes

The field record descriptor (record type) is present for all records, and code (subtype) for all sub-records. They are specified as Attributes with fixed, assigned values, rather than as data elements, in order to achieve access efficiency.

13.1.2.6 All 'count' fields optional

In the Media Record Specification (Clause 12), explicit counters are used to specify the number of elements in a variable length list, for example, NUM_EDGE for the number (count) of Edges to follow in a *Face* record. Explicit counters are not necessary for XML, however, since the fields are self-describing via tags and can be easily counted. Therefore all counters were made optional.

13.1.2.7 Name/value pairs for enumerations

Enumerations in an XML schema are basic one-column vectors. A string type can be enumerated as a list of character strings, and an integer can be enumerated as a list of integers. There is no explicit two-column XML schema structure to link a vector of names with a vector of numbers, so that a particular code (value) must always occur with a particular enumerated name. Since such structures are common in GDF, the XML schema convention is to indicate that names and values belong together throughout an enumeration, and should be treated as linked by application software. The convention is that a complex data type is defined for the enumeration element, composed of a local *value.n* element and a *name.n* element, each of which is of defined type. For example, the element *feat_theme* is of type *Feat_theme*, which is composed of two local elements, *value.n* and *name.n*, which are of types *Feat_theme_val* and *Feat_theme_nam*, which are integer and string enumerations.

13.1.2.8 Comments

Within the schema, comments are not treated as records but as indigenous comments, that is, as XML comments.

13.1.2.9 Inclusion of back pointers

Back pointers are included in the schema to allow file content validation before the file is used and to speed up file compilation into another format.

13.1.2.10 Flexible tag ordering

In order to allow tagged elements to be processed in any order, the root *gdf* element is expressed as a CHOICE of optional and repeatable elements rather than as a SEQUENCE.

13.1.2.11 Attribute Grouping

A repeatable, recursive reference was introduced for grouping Attributes in the XML schema. Attribute information contains a choice of either Attribute codes of defined or user-defined types and an actual value, or an Attribute group structure, which is itself composed of Attribute information and Attribute group information, recursively. This approach necessitated the creation of one global element (*AttributeDescriptor*) in addition to the *gdf* global element.

13.1.2.12 Definition Choice Groups

User-defined codes are provided in the schema for Feature codes, Relationship Codes, and Attribute (and Attribute group) codes, in a separate file called *GDF_userDefined.xsd*. Within the schema, Feature, Relationship, and attributes are a choice between defined and user-defined types.

13.1.2.13 Volumes

Since the XML realization is not volumed unlike the Media Record Specification (clause 12), there is no volume information in the schema realization.

13.1.3 LDS Departures

Two departures from the Logical Data Structures (LDS) are found in the XML schema realization:

1. All count (*num*) fields are optional in the schema, even though they are mandatory in the Logical Data Structures (Clause 11). (13.1.2.6)
2. The concept of data volumes was dropped.

13.1.4 Schema subdivision

The GDF XML realization schema is split into three parts (files):

- *GDF_Main.xsd* – main GDF record structures
- *GDF_data_dict.xsd* – underlying data types and structures
- *GDF_userDefined.xsd* – user-defined enumerations

GDF_Main.xsd includes *GDF_userDefined.xsd* and *GDF_data_dict.xsd*. *GDF_userDefined.xsd* includes *GDF_data_dict.xsd*. In XML syntax “includes” means: reads definitions from, before continuing to make its own definitions, that is a file depends on the other files it includes.

13.2 Data content

13.2.1 General

The data contained in GDF can be either of two types: pre-defined content or map data. Pre-defined content is prescribed in this standard and applies to all GDF instances. Map data is the actual geographic data for a particular coverage area.

13.2.2 Pre-defined content

For pre-defined content, much of the data content appears in GDF Annexes. In certain situations, this content can be expanded by individual GDF suppliers as user-defined data.

Pre-defined content is cross-referenced to other sections in the standard by Table 3. Definitions and graphical descriptions of pre-defined content can be found in sub-clause 13.5, GDF_data_dict.xsd. Definitions and graphical descriptions of user-defined content can be found in sub-clause 13.6, GDF_userDefined.xsd.

Table 3 — Pre-Defined Content references

Entity	Definition Clause	Name	Value	Content
Action	13.5.16	13.5.135	13.5.136	
Attribute Data Type	13.5.15	13.5.133	13.5.134	
Attribute Data Unit	13.5.21	13.5.130	13.5.131	
Attribute Type Code	13.5.17	13.5.137	13.5.138	Annex A.2
Attribute Value Code	13.5.236	13.5.236	13.5.236	Annex A.2
Attribute Value Name	13.5.236	13.5.236	13.5.236	Annex A.2
Character Set	13.5.217	13.5.219	13.5.220	
Coordinate Type	13.5.18	13.5.143	xsd:boolean	
Country Code	13.5.19	13.5.144	13.5.145	Annex B.2
Data Use	13.5.20	13.5.146	13.5.147	
Datum	13.5.2	13.5.148	13.5.149	Annex B.3.1
Direction	13.5.22	13.5.150	xsd:boolean	
Ellipsoid Code	13.5.23	13.5.151	13.5.152	Annex B.3.5
ETA Connectivity	13.5.24	13.5.153	xsd:boolean	
Extended Character Set	13.5.218	13.5.221	13.5.222	
Feature Category	13.5.25	13.5.154	13.5.155	
Feature Code	13.5.26	13.5.215	13.5.216	Annex A.1
Feature Theme	13.5.25	13.5.156	13.5.157	Annex A.1
Geometry Object Category	13.5.28	13.5.158	13.5.159	
Geometry Type	13.5.7	13.5.9	13.5.8	
Grid	13.5.29	13.5.160	13.5.161	Annex B.3.2
Grid Orientation	13.5.44	13.5.191	xsd:boolean	
Height Reference Type	13.5.30	13.5.162	13.5.163	
Language Code	13.5.32	13.5.166	13.5.167	Annex B.1
Layer Topology	13.5.31	13.5.164	13.5.165	
Line Direction	13.5.35	13.5.171	xsd:boolean	
Object Category	13.5.33	13.5.168	13.5.169	
Orientation	13.5.34	13.5.170	xsd:boolean	
Projection Code	13.5.36	13.5.172	13.5.173	Annex B.3.6
Record Type	13.5.37	13.5.174	13.5.175	
Reference Type	13.5.229	13.5.227	13.5.228	Annex B.4.1
Relationship Code D	13.5.54	13.5.182	13.5.183	Annex A.3.1
Role Code	13.5.226	13.5.224	13.5.225	Annex B.4.2
Three Split Indicator	13.5.40	13.5.184	13.5.185	
Two Split Indicator	13.5.41	13.5.186	xsd:boolean	
Topic	13.5.232	13.5.230	13.5.231	Annex B.4.3

Entity	Definition Clause	Name	Value	Content
Unit System	13.5.235	13.5.233	13.5.234	
User-defined Attribute Type Code	13.6.4	13.6.9	13.6.10	
User-defined Feature Code	13.6.2	13.6.5	13.6.6	
User-defined Relationship Code	13.6.3	13.6.7	13.6.8	
Vertical Datum	13.5.42	13.5.187	13.5.188	Annex B.3.3
Z Reference	13.5.43	13.5.189	13.5.190	
Relationship Role Code Lists	13.5.237	13.5.237	13.5.237	Annex A.3.1

13.2.3 Map data

Only XML data structures are specified. Individual suppliers of the GDF map data will provide the content of these data structures, unlike the pre-defined data for which structures are actually filled.

13.3 GDF XML schema

The GDF XML schema contains one root element: *gdf* (cf 13.1.2.1). The *gdf* element has the following child elements:

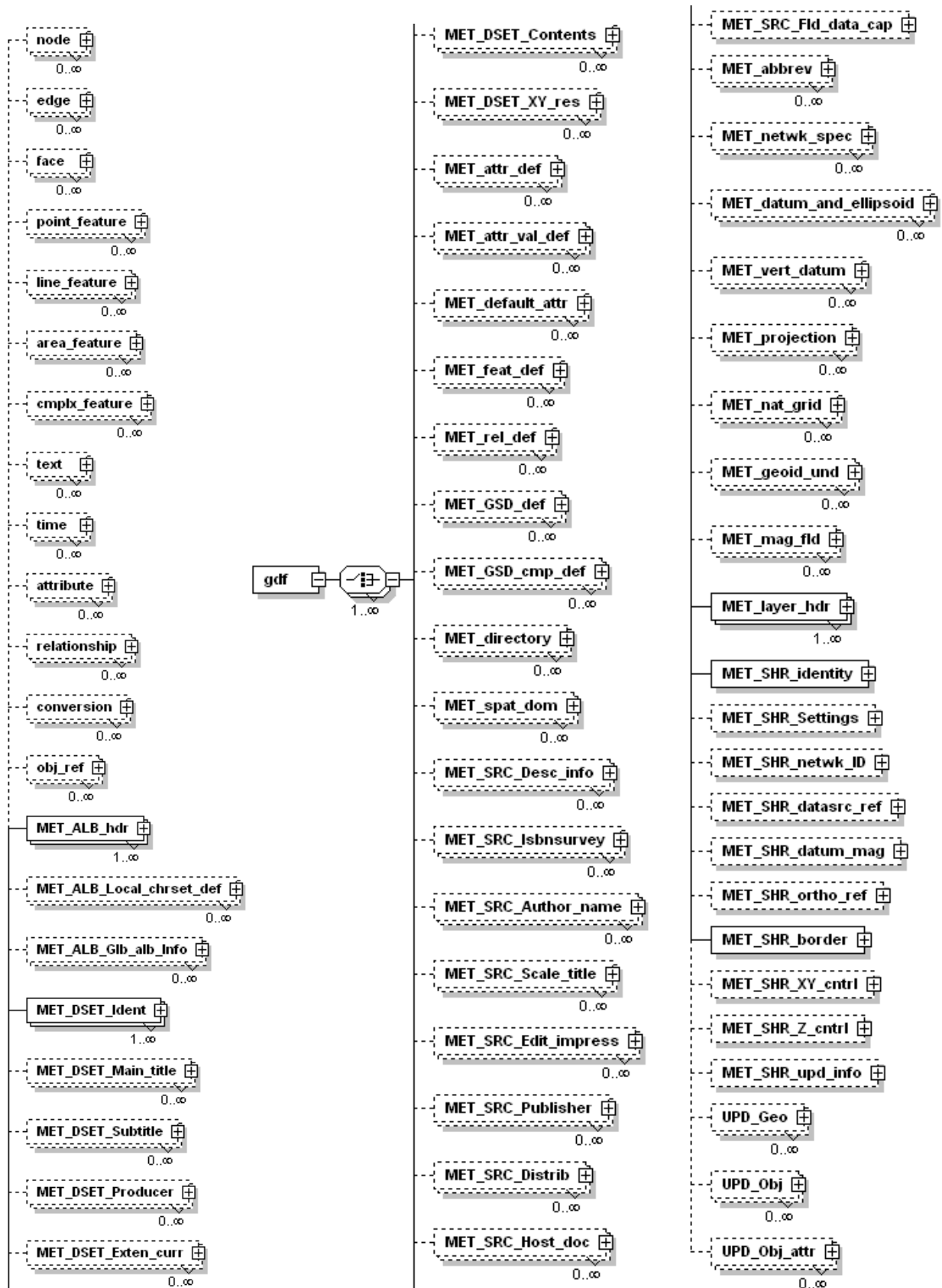

In the schema listings in sections 13.4, 13.5, and 13.6, diagrams are included for the complex types for the *gdf* child elements in GDF_Main and for other complex elements in the included GDF_data_dict and GDF_userDefined files. Diagrams precede the complex element names.

13.4 Schema GDF_Main.xsd

13.4.1 Header

```
<?xml version="1.0" encoding="UTF-8"?>
<xsd:schema xmlns="http://www.ukusa.org" xmlns:xlink="http://www.w3.org/1999/xlink"
xmlns:gdf="http://www.ukusa.org" xmlns:xsd="http://www.w3.org/2001/XMLSchema"
targetNamespace="http://www.ukusa.org" elementFormDefault="qualified">
  <xsd:include schemaLocation="GDF_data_dict.xsd"/>
  <xsd:include schemaLocation="GDF_userDefined.xsd"/>
  <xsd:element name="gdf">
    <xsd:complexType>
      <xsd:choice maxOccurs="unbounded">
        <xsd:element name="node" type="Node" minOccurs="0" maxOccurs="unbounded"/>
        <xsd:element name="edge" type="Edge" minOccurs="0" maxOccurs="unbounded"/>
        <xsd:element name="face" type="Face" minOccurs="0" maxOccurs="unbounded"/>
        <xsd:element name="point_feature" minOccurs="0" maxOccurs="unbounded">
          <xsd:complexType>
            <xsd:choice>
              <xsd:element name="explicit_point_feat" type="Point_feat_explicit"/>
              <xsd:element name="non-explicit_point_feat" type="Point_feat_non-
explicit"/>
            </xsd:choice>
          </xsd:complexType>
        </xsd:element>
        <xsd:element name="line_feature" minOccurs="0" maxOccurs="unbounded">
          <xsd:complexType>
            <xsd:choice>
              <xsd:element name="explicit_line_feat" type="Line_feat_explicit"/>
              <xsd:element name="non-explicit_line_feat" type="Line_feat_non-
explicit"/>
            </xsd:choice>
          </xsd:complexType>
        </xsd:element>
        <xsd:element name="area_feature" minOccurs="0" maxOccurs="unbounded">
          <xsd:complexType>
            <xsd:choice>
              <xsd:element name="full_area_feat" type="Area_feat_full"/>
              <xsd:element name="connectivity_area_feat"
type="Area_feat_connectivity"/>
              <xsd:element name="non-explicit_area_feat" type="Area_feat_non-
explicit"/>
            </xsd:choice>
          </xsd:complexType>
        </xsd:element>
        <xsd:element name="cmplx_feature" minOccurs="0" maxOccurs="unbounded">
          <xsd:complexType>
            <xsd:choice>
              <xsd:element name="explicit_cmplx_feat" type="Cmplx_feat_explicit"/>
              <xsd:element name="non-explicit_cmplx_feat" type="Cmplx_feat_non-
explicit"/>
            </xsd:choice>
          </xsd:complexType>
        </xsd:element>
        <xsd:element name="text" type="Text" minOccurs="0" maxOccurs="unbounded"/>
        <xsd:element name="time" type="Time_domain" minOccurs="0" maxOccurs="unbounded"/>
        <xsd:element name="attribute" type="Attribute" minOccurs="0" maxOccurs="unbounded"/>
        <xsd:element name="relationship" type="Relationship" minOccurs="0"
maxOccurs="unbounded"/>
        <xsd:element name="conversion" type="Conversion" minOccurs="0"
maxOccurs="unbounded"/>
        <xsd:element name="obj_ref" type="Obj_ref" minOccurs="0" maxOccurs="unbounded"/>
        <xsd:element name="MET_ALB_hdr" type="ALB_hdr" maxOccurs="unbounded"/>
        <xsd:element name="MET_ALB_Local_chrset_def" type="ALB_Local_chrset_def"
minOccurs="0"
maxOccurs="unbounded"/>
        <xsd:element name="MET_ALB_Glb_alb_Info" type="ALB_Glb_alb_info" minOccurs="0"
maxOccurs="unbounded"/>
        <xsd:element name="MET_DSET_Ident" type="DSET_Ident" maxOccurs="unbounded"/>
      </xsd:choice>
    </xsd:complexType>
  </xsd:element>
</xsd:schema>
```

```

<xsd:element name="MET_DSET_Main_title" type="DSET_Main_title" minOccurs="0"
maxOccurs="unbounded" />
<xsd:element name="MET_DSET_Subtitle" type="DSET_Subtitle" minOccurs="0"
maxOccurs="unbounded" />
<xsd:element name="MET_DSET_Producer" type="DSET_Producer" minOccurs="0"
maxOccurs="unbounded" />
<xsd:element name="MET_DSET_Exten_curr" type="DSET_Exten_curr" minOccurs="0"
maxOccurs="unbounded" />
<xsd:element name="MET_DSET_Contents" type="DSET_Contents" minOccurs="0"
maxOccurs="unbounded" />
<xsd:element name="MET_DSET_XY_res" type="DSET_XY_res" minOccurs="0"
maxOccurs="unbounded" />
<xsd:element name="MET_attr_def" type="Attr_def" minOccurs="0"
maxOccurs="unbounded" />
<xsd:element name="MET_attr_val_def" type="Attr_val_def" minOccurs="0"
maxOccurs="unbounded" />
<xsd:element name="MET_default_attr" type="Default_attr" minOccurs="0"
maxOccurs="unbounded" />
<xsd:element name="MET_feat_def" type="Feat_def" minOccurs="0"
maxOccurs="unbounded" />
<xsd:element name="MET_rel_def" type="Rel_def" minOccurs="0" maxOccurs="unbounded" />
<xsd:element name="MET_GSD_def" type="GeoPol_str_def" minOccurs="0"
maxOccurs="unbounded" />
<xsd:element name="MET_GSD_cmp_def" type="GeoPol_str_cmp_def" minOccurs="0"
maxOccurs="unbounded" />
<xsd:element name="MET_directory" type="Direc" minOccurs="0" maxOccurs="unbounded" />
<xsd:element name="MET_spat_dom" type="Spat_dom" minOccurs="0"
maxOccurs="unbounded" />
<xsd:element name="MET_SRC_Desc_info" type="SRC_Desc_info" minOccurs="0"
maxOccurs="unbounded" />
<xsd:element name="MET_SRC_Isbnsurvey" type="SRC_Isbnsurvey" minOccurs="0"
maxOccurs="unbounded" />
<xsd:element name="MET_SRC_Author_name" type="SRC_Author_name" minOccurs="0"
maxOccurs="unbounded" />
<xsd:element name="MET_SRC_Scale_title" type="SRC_Scale_title" minOccurs="0"
maxOccurs="unbounded" />
<xsd:element name="MET_SRC_Edit_impress" type="SRC_Edit_impress" minOccurs="0"
maxOccurs="unbounded" />
<xsd:element name="MET_SRC_Publisher" type="SRC_Publisher" minOccurs="0"
maxOccurs="unbounded" />
<xsd:element name="MET_SRC_Distrib" type="SRC_Distrib" minOccurs="0"
maxOccurs="unbounded" />
<xsd:element name="MET_SRC_Host_doc" type="SRC_Host_doc" minOccurs="0"
maxOccurs="unbounded" />
<xsd:element name="MET_SRC_Fld_data_cap" type="SRC_Fld_data_cap" minOccurs="0" />
<xsd:element name="MET_abbrev" type="Abbrev" minOccurs="0" maxOccurs="unbounded" />
<xsd:element name="MET_netwk_spec" type="Netwk_spec" minOccurs="0"
maxOccurs="unbounded" />
<xsd:element name="MET_datum_and_ellipsoid" type="Datum_and_ellipsoid" minOccurs="0"
maxOccurs="unbounded" />
<xsd:element name="MET_vert_datum" type="Vertical_datum" minOccurs="0"
maxOccurs="unbounded" />
<xsd:element name="MET_projection" type="Projection" minOccurs="0"
maxOccurs="unbounded" />
<xsd:element name="MET_nat_grid" type="National_grid" minOccurs="0"
maxOccurs="unbounded" />
<xsd:element name="MET_geoid_und" type="Geoid_undulation" minOccurs="0"
maxOccurs="unbounded" />
<xsd:element name="MET_mag fld" type="Magnetic fld" minOccurs="0"
maxOccurs="unbounded" />
<xsd:element name="MET_layer_hdr" type="Layer_hdr" maxOccurs="unbounded" />
<xsd:element name="MET_SHR_identity" type="SHR_identity" />
<xsd:element name="MET_SHR_Settings" type="SHR_settings" minOccurs="0" />
<xsd:element name="MET_SHR_netwk_ID" type="SHR_netwk_ID" minOccurs="0" />
<xsd:element name="MET_SHR_datasrc_ref" type="SHR_datasrc_ref" minOccurs="0" />
<xsd:element name="MET_SHR_datum_mag" type="SHR_datum_and_mag" minOccurs="0" />
<xsd:element name="MET_SHR_ortho_ref" type="SHR_ortho_ref" minOccurs="0" />
<xsd:element name="MET_SHR_border" type="SHR_border" />
<xsd:element name="MET_SHR_XY_cntrl" type="SHR_XY_cntrl" minOccurs="0" />
<xsd:element name="MET_SHR_Z_cntrl" type="SHR_Z_cntrl" minOccurs="0" />
<xsd:element name="MET_SHR_upd_info" type="SHR_upd_info" minOccurs="0" />
<xsd:element name="UPD_Geo" type="UPD_Geo" minOccurs="0" maxOccurs="unbounded" />
<xsd:element name="UPD_Obj" type="UPD_Obj" minOccurs="0" maxOccurs="unbounded" />
<xsd:element name="UPD_Obj_attr" type="UPD_Obj_attr" minOccurs="0"
maxOccurs="unbounded" />
</xsd:choice>

```

```
</xsd:complexType>
</xsd:element>
```

13.4.2 2-D Coordinates

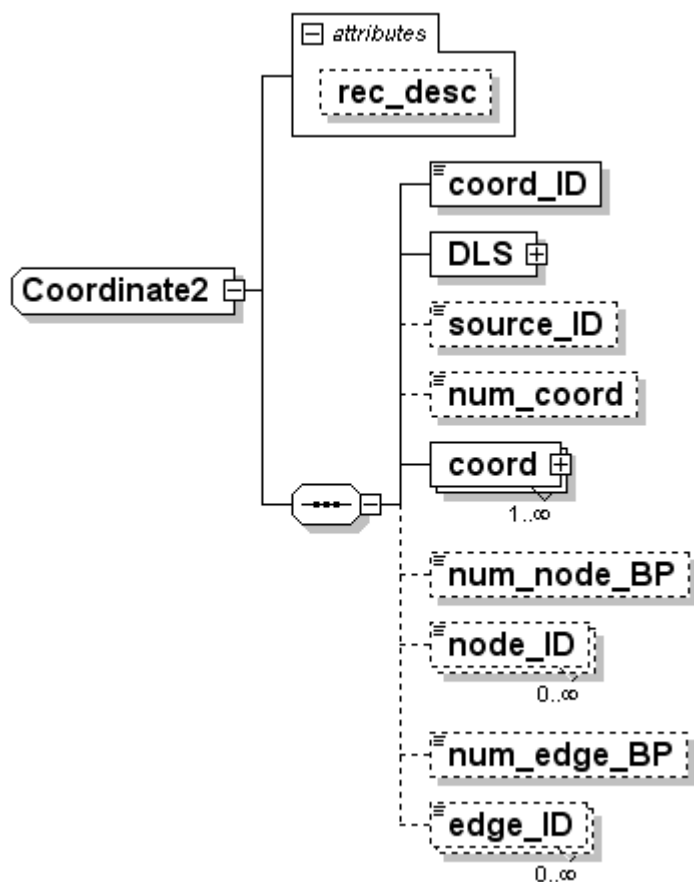

```
<xsd:complexType name="Coordinate2">
  <xsd:sequence>
    <xsd:element name="coord_ID" type="Coord_ID"/>
    <xsd:element name="DLS" type="DLS_ID"/>
    <xsd:element name="source_ID" type="Src_desc_ID" minOccurs="0"/>
    <xsd:element name="num_coord" type="Five_digit_int" minOccurs="0"/>
    <xsd:element name="coord" type="Coord2" maxOccurs="unbounded"/>
    <xsd:element name="num_node_BP" type="Five_digit_int" minOccurs="0"/>
    <xsd:element name="node_ID" type="Node_ID" minOccurs="0" maxOccurs="unbounded"/>
    <xsd:element name="num_edge_BP" type="Five_digit_int" minOccurs="0"/>
    <xsd:element name="edge_ID" type="Edge_ID" minOccurs="0" maxOccurs="unbounded"/>
  </xsd:sequence>
  <xsd:attribute name="rec_desc" type="Rec_typ" fixed="22"/>
</xsd:complexType>
```

13.4.3 3-D Coordinates

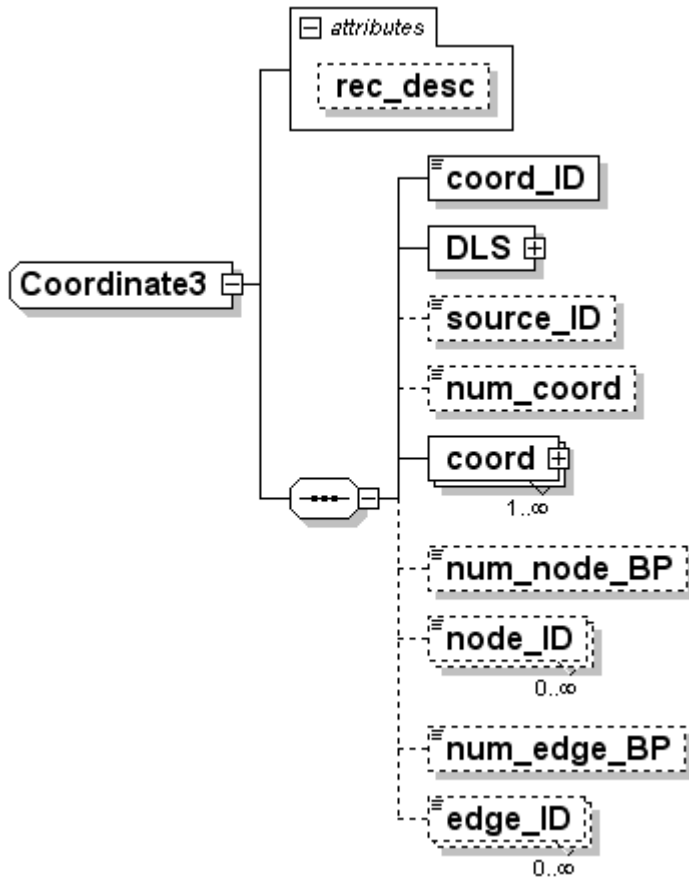

```

<xsd:complexType name="Coordinate3">
  <xsd:sequence>
    <xsd:element name="coord_ID" type="Coord_ID"/>
    <xsd:element name="DLS" type="DLS_ID"/>
    <xsd:element name="source_ID" type="Src_desc_ID" minOccurs="0"/>
    <xsd:element name="num_coord" type="Five_digit_int" minOccurs="0"/>
    <xsd:element name="coord" type="Coord" maxOccurs="unbounded"/>
    <xsd:element name="num_node_BP" type="Five_digit_int" minOccurs="0"/>
    <xsd:element name="node_ID" type="Node_ID" minOccurs="0" maxOccurs="unbounded"/>
    <xsd:element name="num_edge_BP" type="Five_digit_int" minOccurs="0"/>
    <xsd:element name="edge_ID" type="Edge_ID" minOccurs="0" maxOccurs="unbounded"/>
  </xsd:sequence>
  <xsd:attribute name="rec_desc" type="Rec_typ" fixed="23"/>
</xsd:complexType>

```

13.4.4 Node

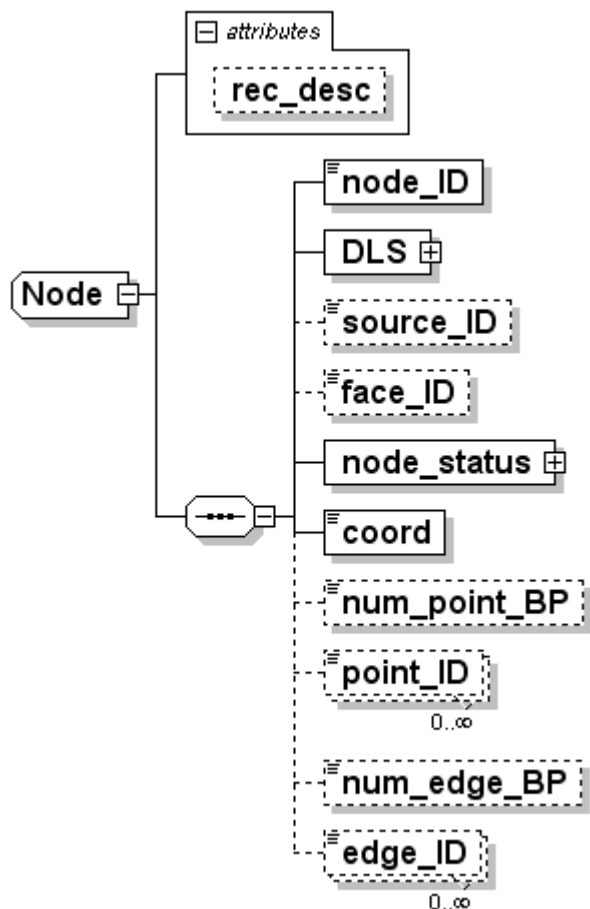

```

<xsd:complexType name="Node">
  <xsd:sequence>
    <xsd:element name="node_ID" type="Node_ID"/>
    <xsd:element name="DLS" type="DLS_ID"/>
    <xsd:element name="source_ID" type="Src_desc_ID" minOccurs="0"/>
    <xsd:element name="face_ID" type="Face_ID" minOccurs="0"/>
    <xsd:element name="node_status" type="Node_status"/>
    <xsd:element name="coord" type="Coord_ID"/>
    <xsd:element name="num_point_BP" type="Five_digit_int" minOccurs="0"/>
    <xsd:element name="point_ID" type="Point_feat_ID" minOccurs="0" maxOccurs="unbounded"/>
    <xsd:element name="num_edge_BP" type="Five_digit_int" minOccurs="0"/>
    <xsd:element name="edge_ID" type="Edge_ID" minOccurs="0" maxOccurs="unbounded"/>
  </xsd:sequence>
  <xsd:attribute name="rec_desc" type="Rec_typ" fixed="25"/>
</xsd:complexType>

```

13.4.5 Edge

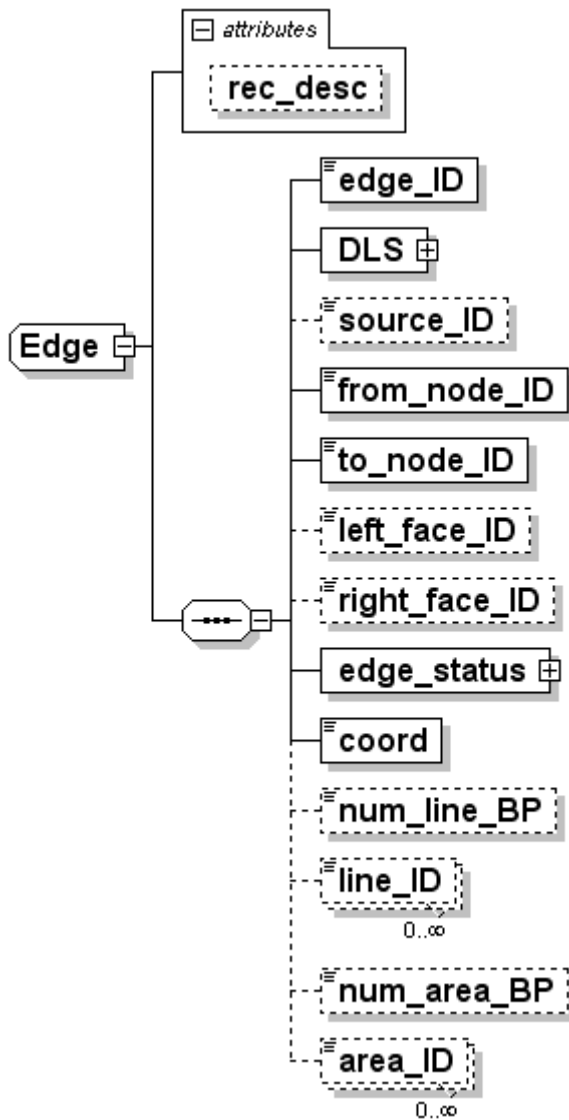

```

<xsd:complexType name="Edge">
  <xsd:sequence>
    <xsd:element name="edge_ID" type="Edge_ID"/>
    <xsd:element name="DLS" type="DLS_ID"/>
    <xsd:element name="source_ID" type="Src_desc_ID" minOccurs="0"/>
    <xsd:element name="from_node_ID" type="Node_ID"/>
    <xsd:element name="to_node_ID" type="Node_ID"/>
    <xsd:element name="left_face_ID" type="Face_ID" minOccurs="0"/>
    <xsd:element name="right_face_ID" type="Face_ID" minOccurs="0"/>
    <xsd:element name="edge_status" type="Edge_status"/>
    <xsd:element name="coord" type="Coord_ID"/>
    <xsd:element name="num_line_BP" type="Five_digit_int" minOccurs="0"/>
    <xsd:element name="line_ID" type="Line_feature_ID" minOccurs="0" maxOccurs="unbounded"/>
    <xsd:element name="num_area_BP" type="Five_digit_int" minOccurs="0"/>
    <xsd:element name="area_ID" type="Area_feature_ID" minOccurs="0" maxOccurs="unbounded"/>
  </xsd:sequence>
  <xsd:attribute name="rec_desc" type="Rec_typ" fixed="24"/>
</xsd:complexType>

```

13.4.6 Face

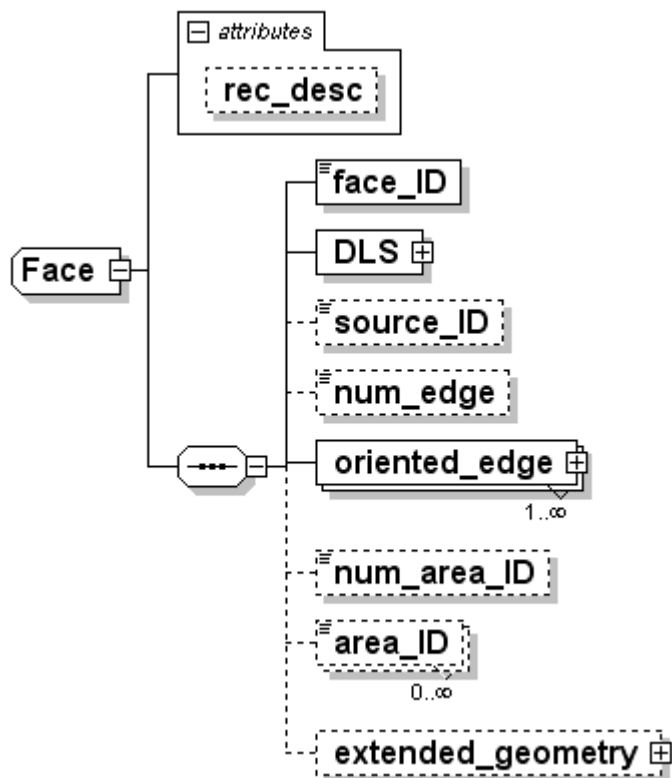

```

<xsd:complexType name="Face">
  <xsd:sequence>
    <xsd:element name="face_ID" type="Face_ID"/>
    <xsd:element name="DLS" type="DLS_ID"/>
    <xsd:element name="source_ID" type="Src_desc_ID" minOccurs="0"/>
    <xsd:element name="num_edge" type="Ten_digit_int" minOccurs="0"/>
    <xsd:element name="oriented_edge" type="Oriented_edge" maxOccurs="unbounded"/>
    <xsd:element name="num_area_ID" type="Five_digit_int" minOccurs="0"/>
    <xsd:element name="area_ID" type="Area_feature_ID" minOccurs="0" maxOccurs="unbounded"/>
    <xsd:element name="extended_geometry" type="Ext_geometry" minOccurs="0"/>
  </xsd:sequence>
  <xsd:attribute name="rec_desc" type="Rec_typ" fixed="29"/>
</xsd:complexType>

```

13.4.7 Explicit Point Feature

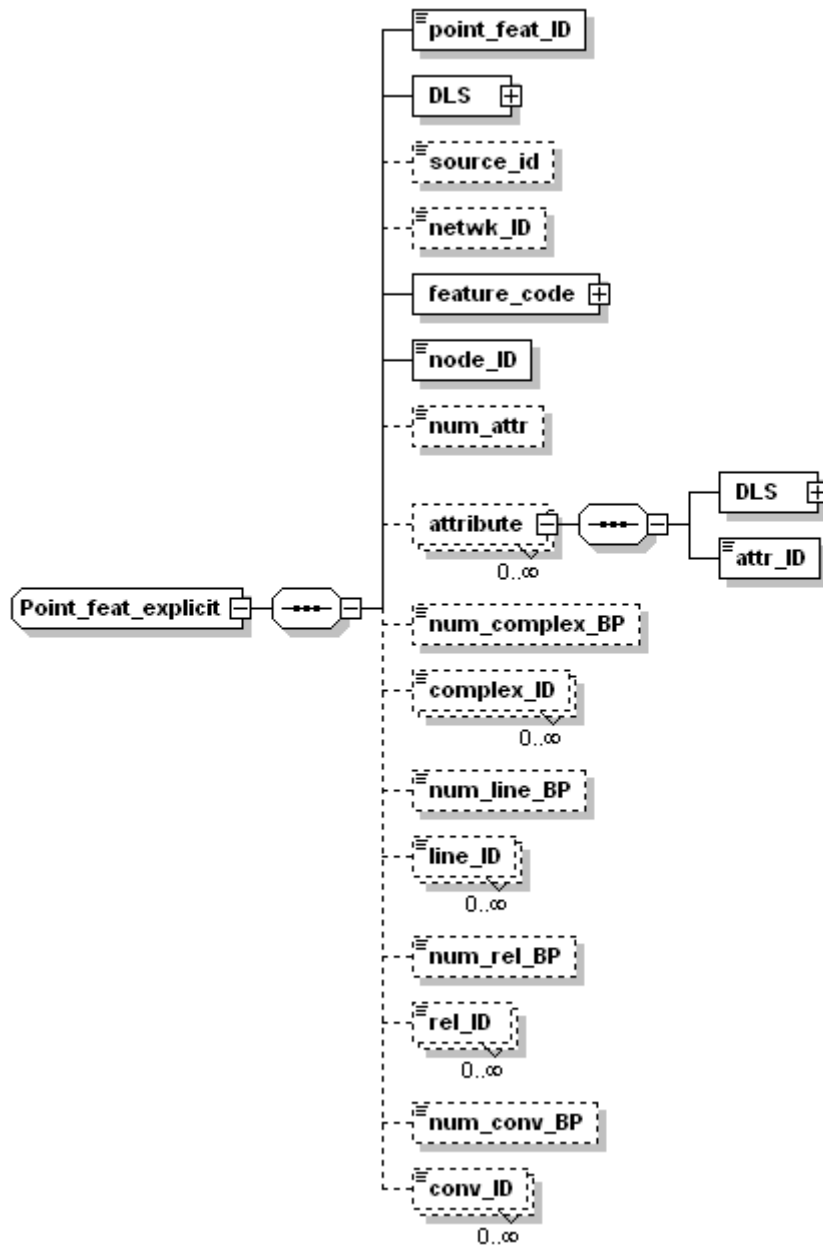

```

<xsd:complexType name="Point_feat_explicit">
  <xsd:sequence>
    <xsd:element name="point_feat_ID" type="Point_feat_ID"/>
    <xsd:element name="DLS" type="DLS_ID"/>
    <xsd:element name="source_id" type="Src_desc_ID" minOccurs="0"/>
    <xsd:element name="netwk_ID" type="Five_digit_ID" minOccurs="0"/>
    <xsd:element name="feature_code" type="Feat_code"/>
    <xsd:element name="node_ID" type="Node_ID"/>
    <xsd:element name="num_attr" type="Five_digit_int" minOccurs="0"/>
    <xsd:element name="attribute" minOccurs="0" maxOccurs="unbounded">
      <xsd:complexType>
        <xsd:sequence>
          <xsd:element name="DLS" type="Optional_DLS_ID"/>
          <xsd:element name="attr_ID" type="Attr_ID"/>
        </xsd:sequence>
      </xsd:complexType>
    </xsd:element>
    <xsd:element name="num_complex_BP" type="Ten_digit_int" minOccurs="0"/>
    <xsd:element name="complex_ID" type="Complex_ID" minOccurs="0" maxOccurs="unbounded"/>
    <xsd:element name="num_line_BP" type="Ten_digit_int" minOccurs="0"/>
    <xsd:element name="line_ID" type="Line_feature_ID" minOccurs="0" maxOccurs="unbounded"/>
  </xsd:sequence>
</xsd:complexType>

```

```

<xsd:element name="num_rel_BP" type="Ten_digit_int" minOccurs="0"/>
<xsd:element name="rel_ID" type="Relationship_ID" minOccurs="0" maxOccurs="unbounded"/>
<xsd:element name="num_conv_BP" type="Five_digit_int" minOccurs="0"/>
<xsd:element name="conv_ID" type="Conversion_ID" minOccurs="0" maxOccurs="unbounded"/>
</xsd:sequence>
<xsd:attribute name="rec_desc" type="Rec_typ" fixed="51"/>
<xsd:attribute name="rec_code" type="Rec_subtyp" fixed="1"/>
</xsd:complexType>

```

13.4.8 Non-explicit Point Feature

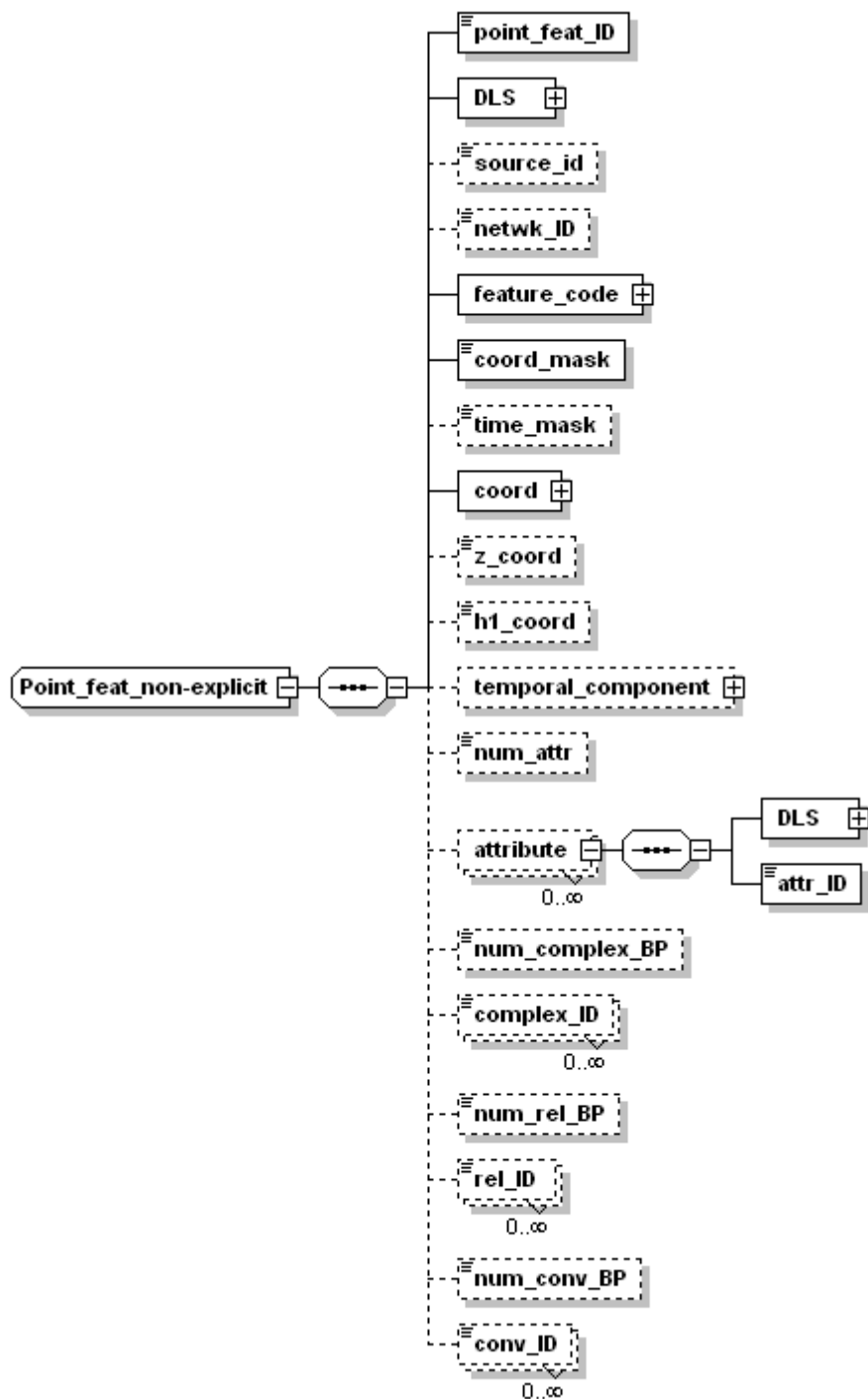

```

<xsd:complexType name="Point_feat_non-explicit">
  <xsd:sequence>
    <xsd:element name="point_feat_ID" type="Point_feat_ID"/>
    <xsd:element name="DLS" type="DLS_ID"/>

```

```
<xsd:element name="source_id" type="Src_desc_ID" minOccurs="0"/>
<xsd:element name="netwk_ID" type="Five_digit_ID" minOccurs="0"/>
<xsd:element name="feature_code" type="Feat_code"/>
<xsd:element name="coord_mask">
  <xsd:simpleType>
    <xsd:restriction base="xsd:integer">
      <xsd:minInclusive value="0"/>
      <xsd:maxInclusive value="15"/>
    </xsd:restriction>
  </xsd:simpleType>
</xsd:element>
<xsd:element name="time_mask" minOccurs="0">
  <xsd:simpleType>
    <xsd:restriction base="xsd:integer">
      <xsd:minInclusive value="0"/>
      <xsd:maxInclusive value="7"/>
    </xsd:restriction>
  </xsd:simpleType>
</xsd:element>
<xsd:element name="coord" type="Coord2"/>
<xsd:element name="z_coord" type="Eleven_digit_int" minOccurs="0"/>
<xsd:element name="hl_coord" type="Eleven_digit_int" minOccurs="0"/>
<xsd:element name="temporal_component" type="Time_coord" minOccurs="0"/>
<xsd:element name="num_attr" type="Five_digit_int" minOccurs="0"/>
<xsd:element name="attribute" minOccurs="0" maxOccurs="unbounded">
  <xsd:complexType>
    <xsd:sequence>
      <xsd:element name="DLS" type="Optional_DLS_ID"/>
      <xsd:element name="attr_ID" type="Attr_ID"/>
    </xsd:sequence>
  </xsd:complexType>
</xsd:element>
<xsd:element name="num_complex_BP" type="Ten_digit_int" minOccurs="0"/>
<xsd:element name="complex_ID" type="Complex_ID" minOccurs="0" maxOccurs="unbounded"/>
<xsd:element name="num_rel_BP" type="Ten_digit_int" minOccurs="0"/>
<xsd:element name="rel_ID" type="Relationship_ID" minOccurs="0" maxOccurs="unbounded"/>
<xsd:element name="num_conv_BP" type="Ten_digit_int" minOccurs="0"/>
<xsd:element name="conv_ID" type="Conversion_ID" minOccurs="0" maxOccurs="unbounded"/>
</xsd:sequence>
<xsd:attribute name="rec_desc" type="Rec_typ" fixed="51"/>
<xsd:attribute name="rec_code" type="Rec_subtyp" fixed="3"/>
</xsd:complexType>
```

13.4.9 Explicit Line Feature

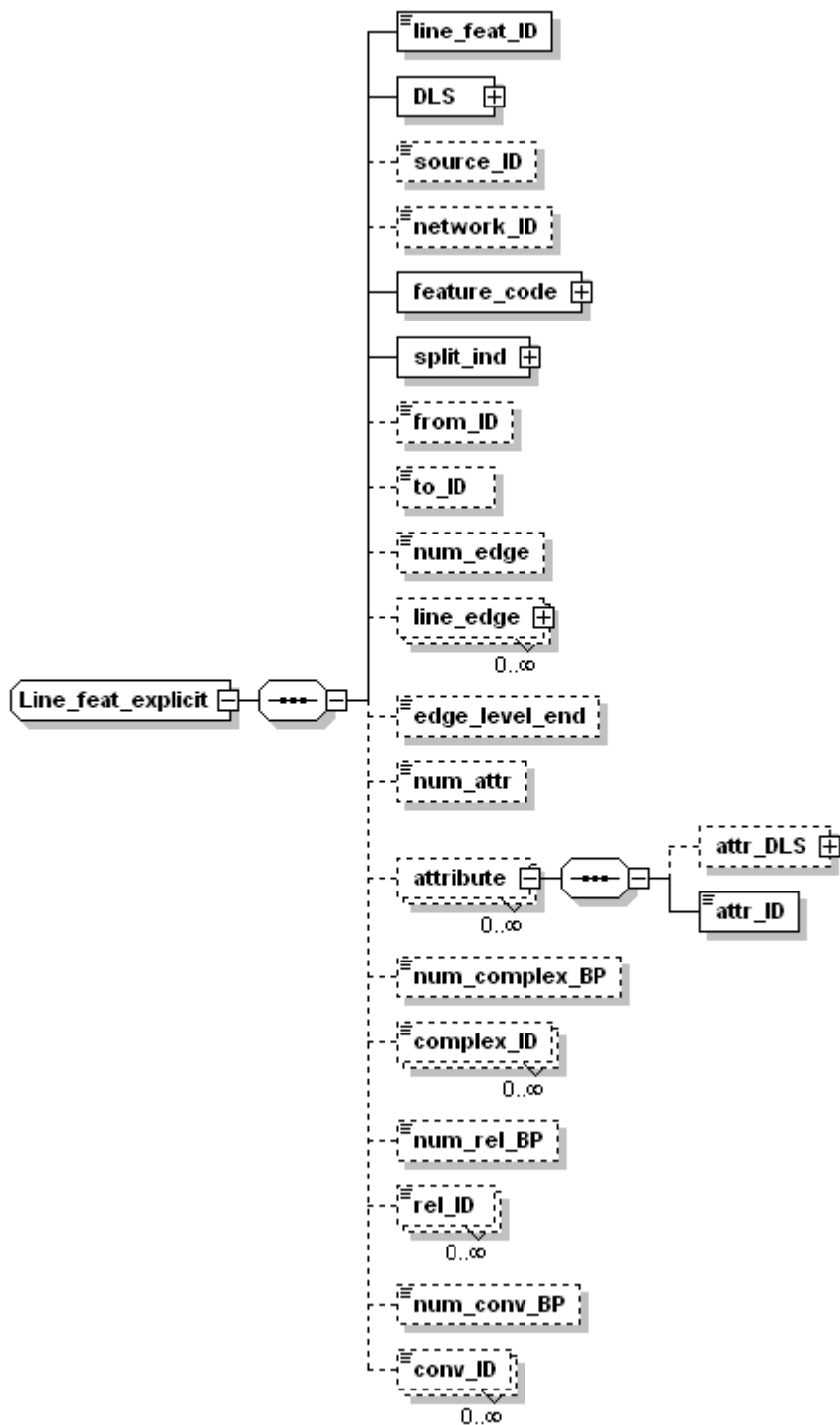

```

<xsd:complexType name="Line_feat_explicit">
  <xsd:sequence>
    <xsd:element name="line_feat_ID" type="Line_feature_ID" />
    <xsd:element name="DLS" type="DLS_ID" />
    <xsd:element name="source_ID" type="Src_desc_ID" minOccurs="0" />
    <xsd:element name="network_ID" type="Five_digit_ID" minOccurs="0" />
    <xsd:element name="feature_code" type="Feat_code" />
    <xsd:element name="split_ind" type="Two_split_ind" />
    <xsd:element name="from_ID" type="Point_feat_ID" minOccurs="0" />
    <xsd:element name="to_ID" type="Point_feat_ID" minOccurs="0" />
    <xsd:element name="num_edge" type="Ten_digit_int" minOccurs="0" />
    <xsd:element name="line_edge" type="Line_edge" minOccurs="0" maxOccurs="unbounded" />
    <xsd:element name="edge_level_end" type="Edge_level_end" />
    <xsd:element name="num_attr" type="Num_attr" />
    <xsd:element name="attribute" type="Attribute" minOccurs="0" maxOccurs="unbounded" />
    <xsd:element name="attr_DLS" type="Attr_DLS" />
    <xsd:element name="attr_ID" type="Attr_ID" />
    <xsd:element name="num_complex_BP" type="Num_complex_BP" />
    <xsd:element name="complex_ID" type="Complex_ID" minOccurs="0" maxOccurs="unbounded" />
    <xsd:element name="num_rel_BP" type="Num_rel_BP" />
    <xsd:element name="rel_ID" type="Rel_ID" minOccurs="0" maxOccurs="unbounded" />
    <xsd:element name="num_conv_BP" type="Num_conv_BP" />
    <xsd:element name="conv_ID" type="Conv_ID" minOccurs="0" maxOccurs="unbounded" />
  </xsd:sequence>
</xsd:complexType>

```

```

<xsd:element name="edge_level_end" type="Edge_level" minOccurs="0"/>
<xsd:element name="num_attr" type="Five_digit_int" minOccurs="0"/>
<xsd:element name="attribute" minOccurs="0" maxOccurs="unbounded">
  <xsd:complexType>
    <xsd:sequence>
      <xsd:element name="attr_DLS" type="Optional_DLS_ID" minOccurs="0"/>
      <xsd:element name="attr_ID" type="Attr_ID"/>
    </xsd:sequence>
  </xsd:complexType>
</xsd:element>
<xsd:element name="num_complex_BP" type="Ten_digit_int" minOccurs="0"/>
<xsd:element name="complex_ID" type="Complex_ID" minOccurs="0" maxOccurs="unbounded"/>
<xsd:element name="num_rel_BP" type="Ten_digit_int" minOccurs="0"/>
<xsd:element name="rel_ID" type="Relationship_ID" minOccurs="0" maxOccurs="unbounded"/>
<xsd:element name="num_conv_BP" type="Ten_digit_int" minOccurs="0"/>
<xsd:element name="conv_ID" type="Conversion_ID" minOccurs="0" maxOccurs="unbounded"/>
</xsd:sequence>
<xsd:attribute name="rec_desc" type="Rec_typ" fixed="52"/>
<xsd:attribute name="rec_code" type="Rec_subtyp" fixed="1"/>
</xsd:complexType>

```

13.4.10 Non-explicit Line Feature

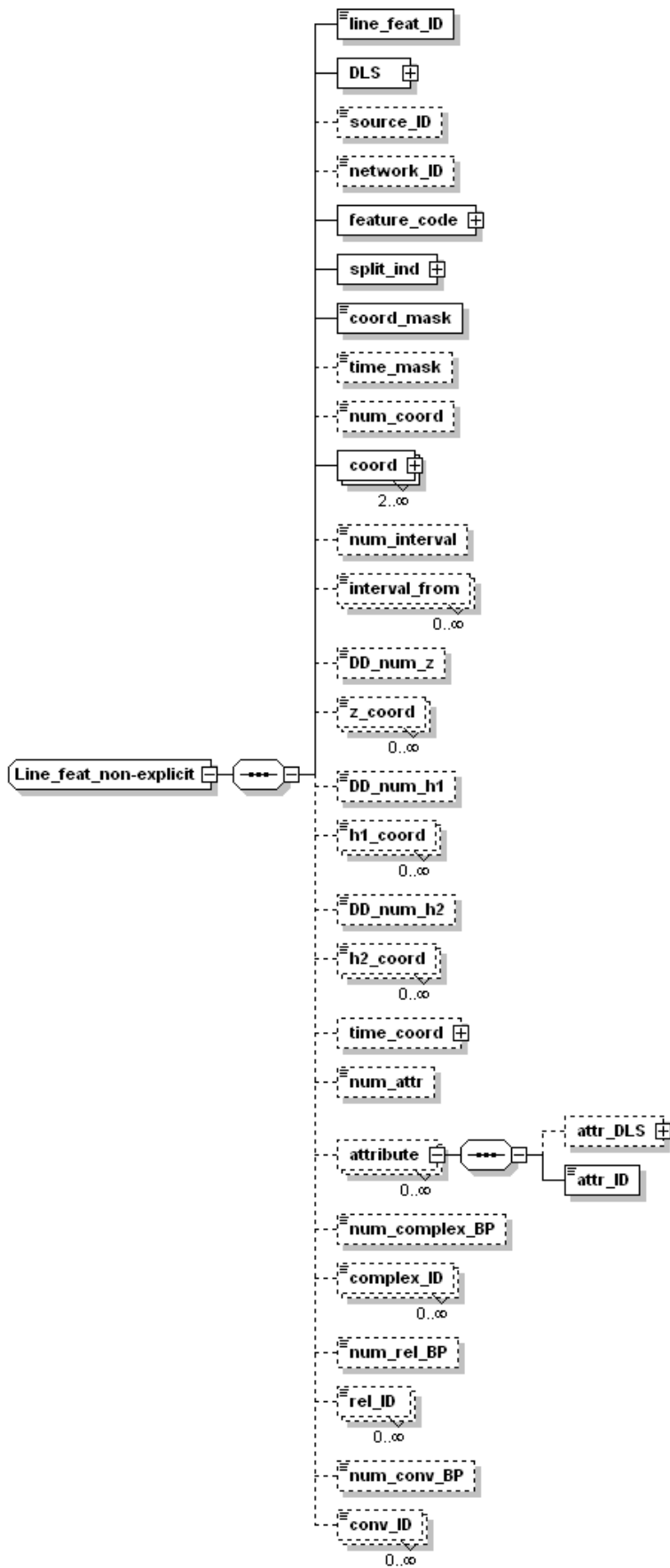



```

<xsd:complexType name="Line_feat_non-explicit">
  <xsd:sequence>
    <xsd:element name="line_feat_ID" type="Line_feature_ID"/>
    <xsd:element name="DLS" type="DLS_ID"/>
    <xsd:element name="source_ID" type="Src_desc_ID" minOccurs="0"/>
    <xsd:element name="network_ID" type="Five_digit_ID" minOccurs="0"/>
    <xsd:element name="feature_code" type="Feat_code"/>
    <xsd:element name="split_ind" type="Two_split_ind"/>
    <xsd:element name="coord_mask" type="Coord_mask"/>
    <xsd:element name="time_mask" type="Time_mask" minOccurs="0"/>
    <xsd:element name="num_coord" minOccurs="0">
      <xsd:simpleType>
        <xsd:restriction base="Five_digit_int">
          <xsd:minInclusive value="2"/>
        </xsd:restriction>
      </xsd:simpleType>
    </xsd:element>
    <xsd:element name="coord" type="Coord2" minOccurs="2" maxOccurs="unbounded"/>
    <xsd:element name="num_interval" type="Five_digit_int" minOccurs="0"/>
    <xsd:element name="interval_from" minOccurs="0" maxOccurs="unbounded">
      <xsd:simpleType>
        <xsd:restriction base="Five_digit_int">
          <xsd:minInclusive value="1"/>
        </xsd:restriction>
      </xsd:simpleType>
    </xsd:element>
    <xsd:element name="DD_num_z" type="Five_digit_int" minOccurs="0"/>
    <xsd:element name="z_coord" type="Eleven_digit_coord" minOccurs="0"
maxOccurs="unbounded"/>
    <xsd:element name="DD_num_h1" type="Five_digit_int" minOccurs="0"/>
    <xsd:element name="h1_coord" type="Eleven_digit_coord" minOccurs="0"
maxOccurs="unbounded"/>
    <xsd:element name="DD_num_h2" type="Five_digit_int" minOccurs="0"/>
    <xsd:element name="h2_coord" type="Eleven_digit_coord" minOccurs="0"
maxOccurs="unbounded"/>
    <xsd:element name="time_coord" type="Time_coord" minOccurs="0"/>
    <xsd:element name="num_attr" type="Five_digit_int" minOccurs="0"/>
    <xsd:element name="attribute" minOccurs="0" maxOccurs="unbounded">
      <xsd:complexType>
        <xsd:sequence>
          <xsd:element name="attr_DLS" type="Optional_DLS_ID" minOccurs="0"/>
          <xsd:element name="attr_ID" type="Attr_ID"/>
        </xsd:sequence>
      </xsd:complexType>
    </xsd:element>
    <xsd:element name="num_complex_BP" type="Ten_digit_int" minOccurs="0"/>
    <xsd:element name="complex_ID" type="Complex_ID" minOccurs="0" maxOccurs="unbounded"/>
    <xsd:element name="num_rel_BP" type="Ten_digit_int" minOccurs="0"/>
    <xsd:element name="rel_ID" type="Relationship_ID" minOccurs="0" maxOccurs="unbounded"/>
    <xsd:element name="num_conv_BP" type="Ten_digit_int" minOccurs="0"/>
    <xsd:element name="conv_ID" type="Conversion_ID" minOccurs="0" maxOccurs="unbounded"/>
  </xsd:sequence>
  <xsd:attribute name="rec_desc" type="Rec_typ" fixed="52"/>
  <xsd:attribute name="rec_code" type="Rec_subtyp" fixed="3"/>
</xsd:complexType>

```

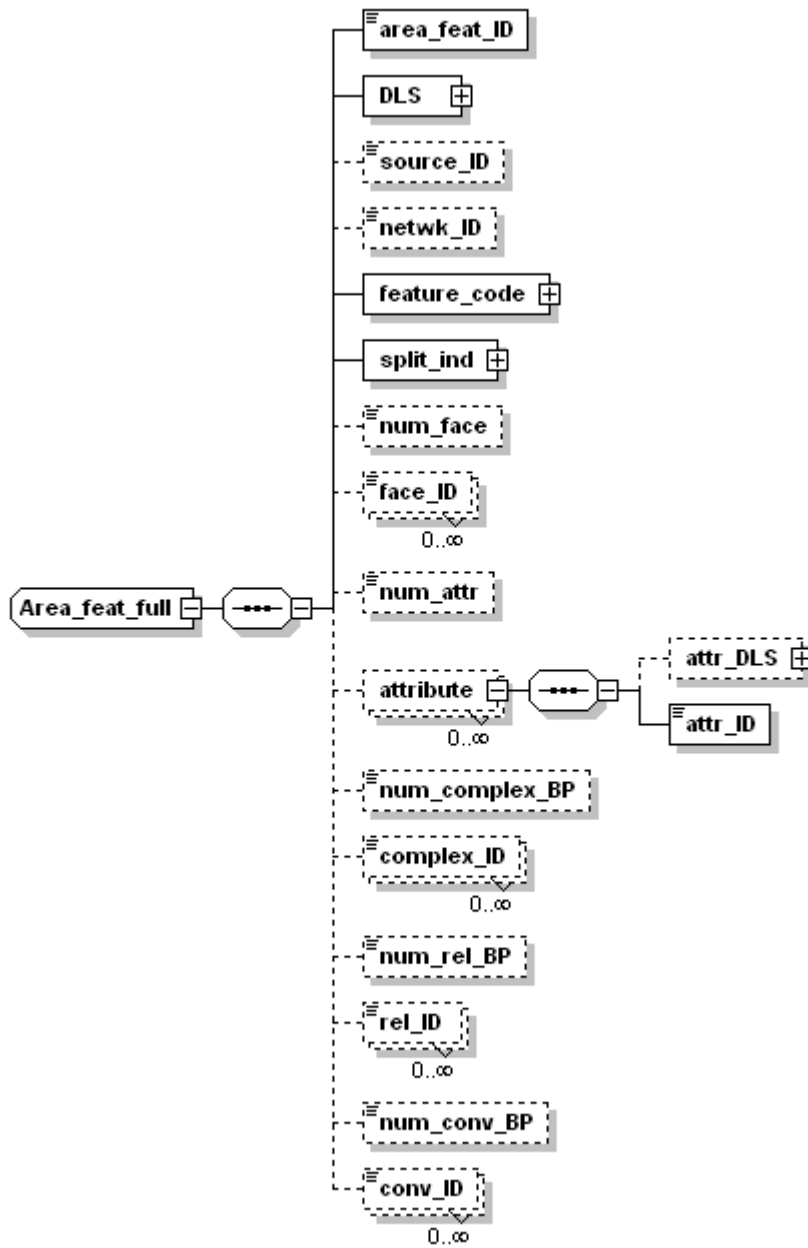
13.4.11 Full Topology Area Feature



```

<xsd:complexType name="Area_feat_full">
  <xsd:sequence>
    <xsd:element name="area_feat_ID" type="Area_feature_ID" />
    <xsd:element name="DLS" type="DLS_ID" />
    <xsd:element name="source_ID" type="Src_desc_ID" minOccurs="0" />
    <xsd:element name="netwk_ID" type="Five_digit_ID" minOccurs="0" />
    <xsd:element name="feature_code" type="Feat_code" />
    <xsd:element name="split_ind" type="Two_split_ind" />
    <xsd:element name="num_face" type="Ten_digit_int" minOccurs="0" />
    <xsd:element name="face_ID" type="Face_ID" minOccurs="0" maxOccurs="unbounded" />
    <xsd:element name="num_attr" type="Five_digit_int" minOccurs="0" />
    <xsd:element name="attribute" minOccurs="0" maxOccurs="unbounded">
      <xsd:complexType>
        <xsd:sequence>
          <xsd:element name="attr_DLS" type="Optional_DLS_ID" minOccurs="0" />
          <xsd:element name="attr_ID" type="Attr_ID" />
        </xsd:sequence>
      </xsd:complexType>
    </xsd:element>
    <xsd:element name="num_complex_BP" type="Ten_digit_int" minOccurs="0" />
    <xsd:element name="complex_ID" type="Complex_ID" minOccurs="0" maxOccurs="unbounded" />
    <xsd:element name="num_rel_BP" type="Ten_digit_int" minOccurs="0" />
    <xsd:element name="rel_ID" type="Five_digit_int" minOccurs="0" />
    <xsd:element name="num_conv_BP" type="Ten_digit_int" minOccurs="0" />
    <xsd:element name="conv_ID" type="Five_digit_int" minOccurs="0" />
  </xsd:sequence>
</xsd:complexType>
  
```

```

<xsd:element name="num_rel_BP" type="Ten_digit_int" minOccurs="0"/>
<xsd:element name="rel_ID" type="Relationship_ID" minOccurs="0" maxOccurs="unbounded"/>
<xsd:element name="num_conv_BP" type="Ten_digit_int" minOccurs="0"/>
<xsd:element name="conv_ID" type="Conversion_ID" minOccurs="0" maxOccurs="unbounded"/>
</xsd:sequence>
<xsd:attribute name="rec_desc" type="Rec_typ" fixed="53"/>
<xsd:attribute name="rec_code" type="Rec_subtyp" fixed="1"/>
</xsd:complexType>

```

13.4.12 Connectivity Topology Area Feature

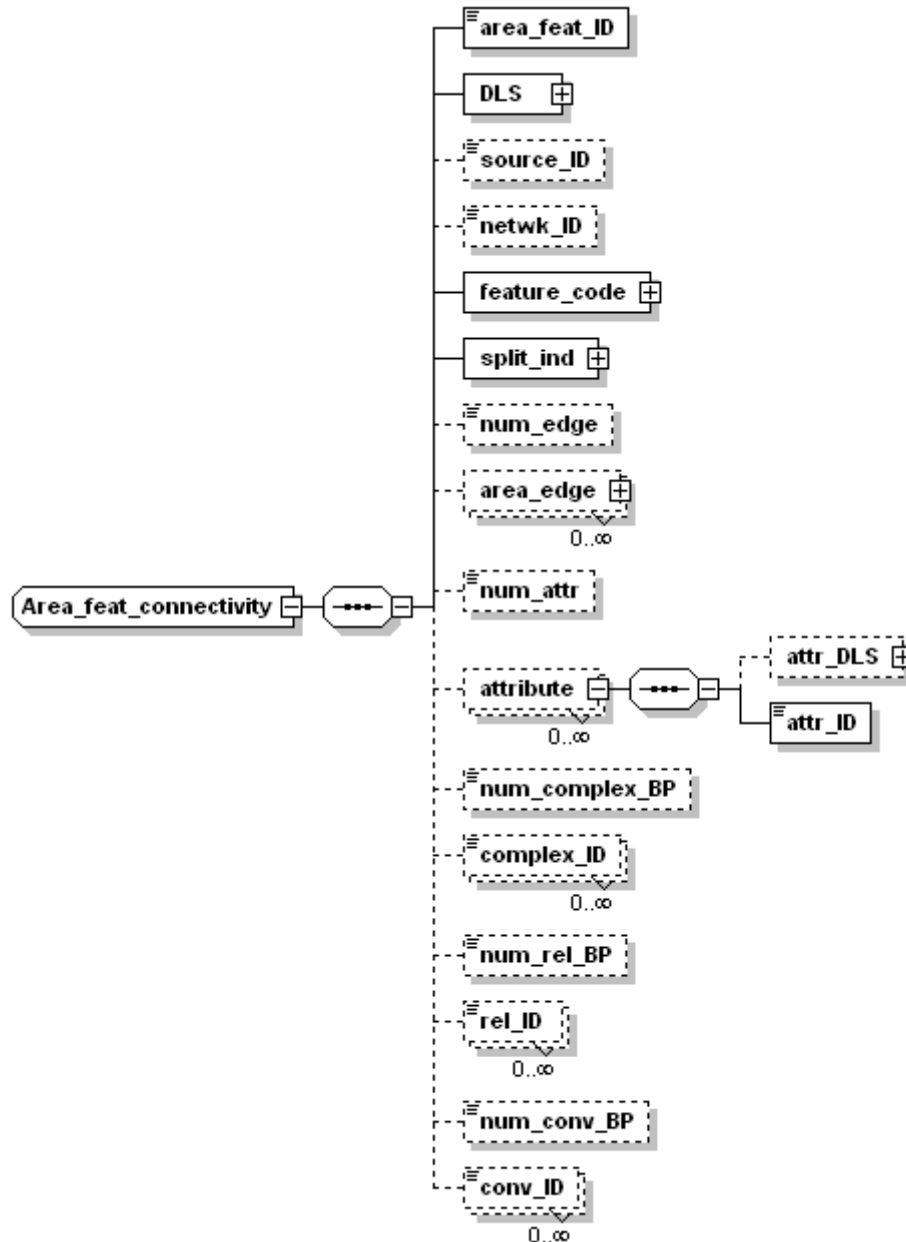

```

<xsd:complexType name="Area_feat_connectivity">
  <xsd:sequence>
    <xsd:element name="area_feat_ID" type="Area_feature_ID"/>
    <xsd:element name="DLS" type="DLS_ID"/>
    <xsd:element name="source_ID" type="Src_desc_ID" minOccurs="0"/>
    <xsd:element name="netwk_ID" type="Five_digit_ID" minOccurs="0"/>
    <xsd:element name="feature_code" type="Feat_code"/>
    <xsd:element name="split_ind" type="Two_split_ind"/>
    <xsd:element name="num_edge" type="Ten_digit_int" minOccurs="0"/>
    <xsd:element name="area_edge" type="Area_edge" minOccurs="0" maxOccurs="unbounded"/>
    <xsd:element name="num_attr" type="Five_digit_int" minOccurs="0"/>

```

```
<xsd:element name="attribute" minOccurs="0" maxOccurs="unbounded">
  <xsd:complexType>
    <xsd:sequence>
      <xsd:element name="attr_DLS" type="Optional_DLS_ID" minOccurs="0"/>
      <xsd:element name="attr_ID" type="Attr_ID"/>
    </xsd:sequence>
  </xsd:complexType>
</xsd:element>
<xsd:element name="num_complex_BP" type="Ten_digit_int" minOccurs="0"/>
<xsd:element name="complex_ID" type="Complex_ID" minOccurs="0" maxOccurs="unbounded"/>
<xsd:element name="num_rel_BP" type="Ten_digit_int" minOccurs="0"/>
<xsd:element name="rel_ID" type="Relationship_ID" minOccurs="0" maxOccurs="unbounded"/>
<xsd:element name="num_conv_BP" type="Ten_digit_int" minOccurs="0"/>
<xsd:element name="conv_ID" type="Conversion_ID" minOccurs="0" maxOccurs="unbounded"/>
</xsd:sequence>
<xsd:attribute name="rec_desc" type="Rec_typ" fixed="53"/>
<xsd:attribute name="rec_code" type="Rec_subtyp" fixed="2"/>
</xsd:complexType>
```

13.4.13 Non-explicit Topology Area Feature

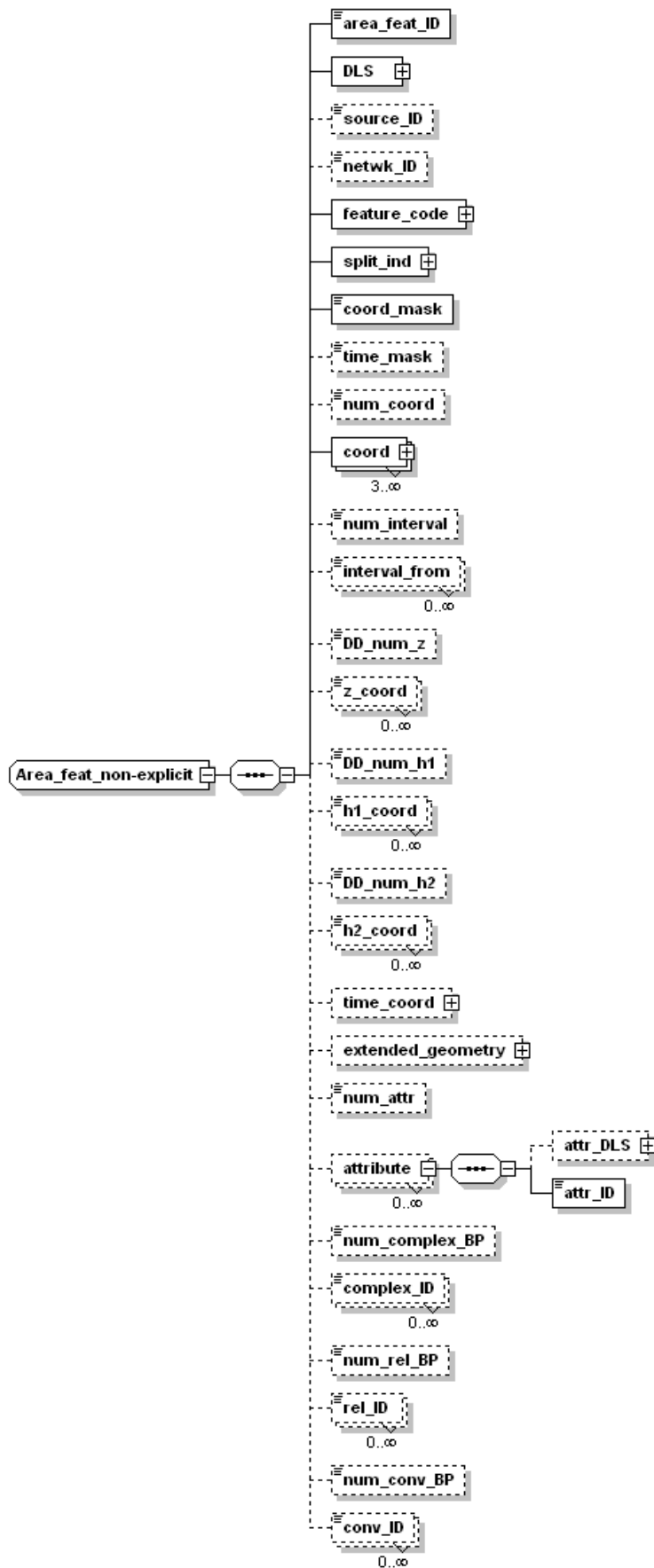

```

<xsd:complexType name="Area_feat_non-explicit">
  <xsd:sequence>
    <xsd:element name="area_feat_ID" type="Area_feature_ID"/>
    <xsd:element name="DLS" type="DLS_ID"/>
    <xsd:element name="source_ID" type="Src_desc_ID" minOccurs="0"/>
    <xsd:element name="netwk_ID" type="Five_digit_ID" minOccurs="0"/>
    <xsd:element name="feature_code" type="Feat_code"/>
    <xsd:element name="split_ind" type="Two_split_ind"/>
    <xsd:element name="coord_mask" type="Coord_mask"/>
    <xsd:element name="time_mask" type="Time_mask" minOccurs="0"/>
    <xsd:element name="num_coord" minOccurs="0">
      <xsd:simpleType>
        <xsd:restriction base="Five_digit_int">
          <xsd:minInclusive value="3"/>
        </xsd:restriction>
      </xsd:simpleType>
    </xsd:element>
    <xsd:element name="coord" type="Coord2" minOccurs="3" maxOccurs="unbounded"/>
    <xsd:element name="num_interval" type="Five_digit_int" minOccurs="0"/>
    <xsd:element name="interval_from" minOccurs="0" maxOccurs="unbounded">
      <xsd:simpleType>
        <xsd:restriction base="Five_digit_int">
          <xsd:minInclusive value="1"/>
        </xsd:restriction>
      </xsd:simpleType>
    </xsd:element>
    <xsd:element name="DD_num_z" type="Five_digit_int" minOccurs="0"/>
    <xsd:element name="z_coord" type="Eleven_digit_coord" minOccurs="0"
maxOccurs="unbounded"/>
    <xsd:element name="DD_num_h1" type="Five_digit_int" minOccurs="0"/>
    <xsd:element name="h1_coord" type="Eleven_digit_coord" minOccurs="0"
maxOccurs="unbounded"/>
    <xsd:element name="DD_num_h2" type="Five_digit_int" minOccurs="0"/>
    <xsd:element name="h2_coord" type="Eleven_digit_coord" minOccurs="0"
maxOccurs="unbounded"/>
    <xsd:element name="time_coord" type="Time_coord" minOccurs="0"/>
    <xsd:element name="extended_geometry" type="Ext_geometry" minOccurs="0"/>
    <xsd:element name="num_attr" type="Five_digit_int" minOccurs="0"/>
    <xsd:element name="attribute" minOccurs="0" maxOccurs="unbounded">
      <xsd:complexType>
        <xsd:sequence>
          <xsd:element name="attr_DLS" type="Optional_DLS_ID" minOccurs="0"/>
          <xsd:element name="attr_ID" type="Attr_ID"/>
        </xsd:sequence>
      </xsd:complexType>
    </xsd:element>
    <xsd:element name="num_complex_BP" type="Ten_digit_int" minOccurs="0"/>
    <xsd:element name="complex_ID" type="Complex_ID" minOccurs="0" maxOccurs="unbounded"/>
    <xsd:element name="num_rel_BP" type="Ten_digit_int" minOccurs="0"/>
    <xsd:element name="rel_ID" type="Relationship_ID" minOccurs="0" maxOccurs="unbounded"/>
    <xsd:element name="num_conv_BP" type="Ten_digit_int" minOccurs="0"/>
    <xsd:element name="conv_ID" type="Conversion_ID" minOccurs="0" maxOccurs="unbounded"/>
  </xsd:sequence>
  <xsd:attribute name="rec_desc" type="Rec_typ" fixed="53"/>
  <xsd:attribute name="rec_code" type="Rec_subtyp" fixed="3"/>
</xsd:complexType>

```

13.4.14 Explicit Topology Complex Feature

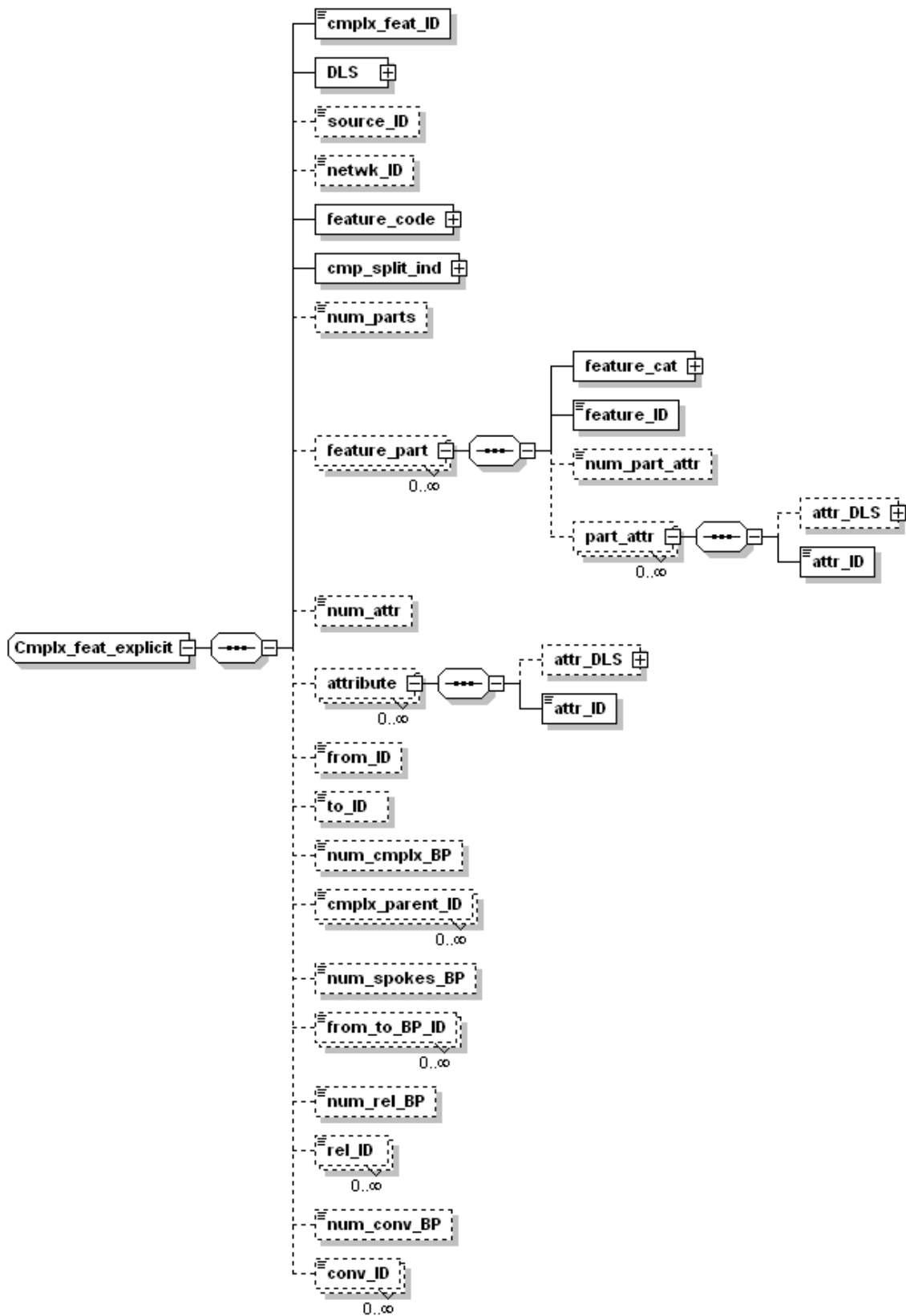

```

<xsd:complexType name="Cmplx_feat_explicit">
  <xsd:sequence>
    <xsd:element name="cmplx_feat_ID" type="Complex_ID"/>
    <xsd:element name="DLS" type="DLS_ID"/>
  
```

```

<xsd:element name="source_ID" type="Src_desc_ID" minOccurs="0"/>
<xsd:element name="netwk_ID" type="Five_digit_ID" minOccurs="0"/>
<xsd:element name="feature_code" type="Feat_code"/>
<xsd:element name="cmp_split_ind" type="Three_split_ind"/>
<xsd:element name="num_parts" type="Five_digit_int" minOccurs="0"/>
<xsd:element name="feature_part" minOccurs="0" maxOccurs="unbounded">
  <xsd:complexType>
    <xsd:sequence>
      <xsd:element name="feature_cat" type="Feat_cat"/>
      <xsd:element name="feature_ID" type="Rec_ID"/>
      <xsd:element name="num_part_attr" type="Five_digit_int" minOccurs="0"/>
      <xsd:element name="part_attr" minOccurs="0" maxOccurs="unbounded">
        <xsd:complexType>
          <xsd:sequence>
            <xsd:element name="attr_DLS" type="Optional_DLS_ID"
minOccurs="0"/>
              <xsd:element name="attr_ID" type="Attr_ID"/>
            </xsd:sequence>
          </xsd:complexType>
        </xsd:element>
      </xsd:sequence>
    </xsd:complexType>
  </xsd:element>
<xsd:element name="num_attr" type="Five_digit_int" minOccurs="0"/>
<xsd:element name="attribute" minOccurs="0" maxOccurs="unbounded">
  <xsd:complexType>
    <xsd:sequence>
      <xsd:element name="attr_DLS" type="Optional_DLS_ID" minOccurs="0"/>
      <xsd:element name="attr_ID" type="Attr_ID"/>
    </xsd:sequence>
  </xsd:complexType>
</xsd:element>
<xsd:element name="from_ID" type="Complex_ID" minOccurs="0"/>
<xsd:element name="to_ID" type="Complex_ID" minOccurs="0"/>
<xsd:element name="num_cmplx_BP" type="Ten_digit_int" minOccurs="0"/>
<xsd:element name="cmplx_parent_ID" type="Complex_ID" minOccurs="0"
maxOccurs="unbounded"/>
  <xsd:element name="num_spokes_BP" type="Five_digit_int" minOccurs="0"/>
  <xsd:element name="from_to_BP_ID" type="Complex_ID" minOccurs="0" maxOccurs="unbounded"/>
  <xsd:element name="num_rel_BP" type="Ten_digit_int" minOccurs="0"/>
  <xsd:element name="rel_ID" type="Relationship_ID" minOccurs="0" maxOccurs="unbounded"/>
  <xsd:element name="num_conv_BP" type="Ten_digit_int" minOccurs="0"/>
  <xsd:element name="conv_ID" type="Conversion_ID" minOccurs="0" maxOccurs="unbounded"/>
</xsd:sequence>
<xsd:attribute name="rec_desc" type="Rec_typ" fixed="54"/>
<xsd:attribute name="rec_code" type="Rec_subtyp" fixed="1"/>
</xsd:complexType>

```

13.4.15 Non-explicit Topology Complex Feature

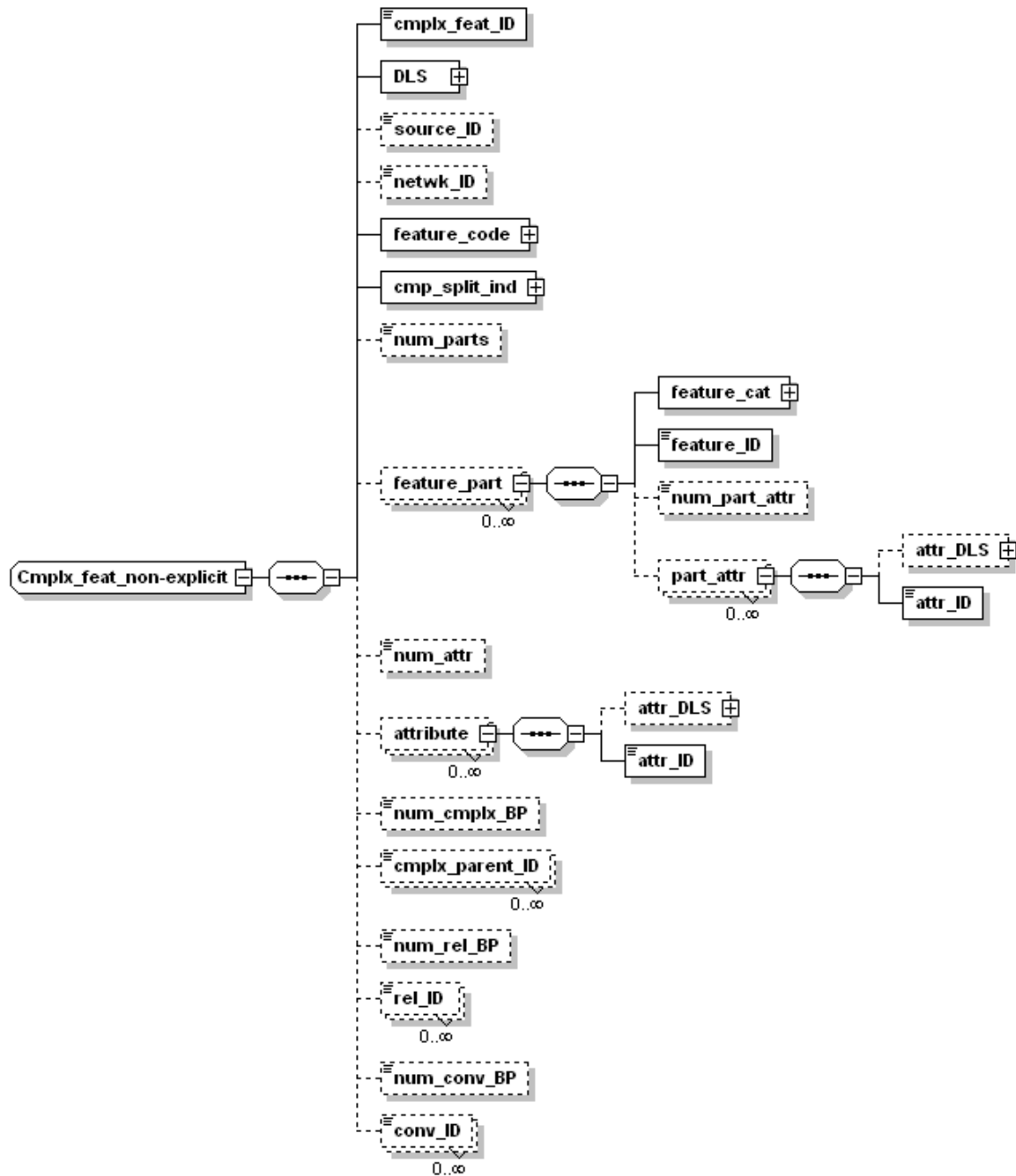

```

<xsd:complexType name="Cmplx_feat_non-explicit">
  <xsd:sequence>
    <xsd:element name="cmplx_feat_ID" type="Complex_ID"/>
    <xsd:element name="DLS" type="DLS_ID"/>
    <xsd:element name="source_ID" type="Src_desc_ID" minOccurs="0"/>
    <xsd:element name="netwk_ID" type="Five_digit_ID" minOccurs="0"/>
    <xsd:element name="feature_code" type="Feat_code"/>
    <xsd:element name="cmp_split_ind" type="Three_split_ind"/>
    <xsd:element name="num_parts" type="Five_digit_int" minOccurs="0"/>
    <xsd:element name="feature_part" minOccurs="0" maxOccurs="unbounded">
      <xsd:complexType>
        <xsd:sequence>
          <xsd:element name="feature_cat" type="Feat_cat"/>
          <xsd:element name="feature_ID" type="Rec_ID"/>
          <xsd:element name="num_part_attr" type="Five_digit_int" minOccurs="0"/>
          <xsd:element name="part_attr" minOccurs="0" maxOccurs="unbounded">
            <xsd:complexType>
              <xsd:sequence>

```

```

        <xsd:element name="attr_DLS" type="Optional_DLS_ID"
minOccurs="0" />
        <xsd:element name="attr_ID" type="Attr_ID" />
    </xsd:sequence>
</xsd:complexType>
</xsd:element>
</xsd:sequence>
</xsd:complexType>
</xsd:element>
<xsd:element name="num_attr" type="Five_digit_int" minOccurs="0" />
<xsd:element name="attribute" minOccurs="0" maxOccurs="unbounded">
    <xsd:complexType>
        <xsd:sequence>
            <xsd:element name="attr_DLS" type="Optional_DLS_ID" minOccurs="0" />
            <xsd:element name="attr_ID" type="Attr_ID" />
        </xsd:sequence>
    </xsd:complexType>
</xsd:element>
<xsd:element name="num_cmplx_BP" type="Ten_digit_int" minOccurs="0" />
<xsd:element name="cmplx_parent_ID" type="Complex_ID" minOccurs="0"
maxOccurs="unbounded" />
<xsd:element name="num_rel_BP" type="Ten_digit_int" minOccurs="0" />
<xsd:element name="rel_ID" type="Relationship_ID" minOccurs="0" maxOccurs="unbounded" />
<xsd:element name="num_conv_BP" type="Ten_digit_int" minOccurs="0" />
<xsd:element name="conv_ID" type="Conversion_ID" minOccurs="0" maxOccurs="unbounded" />
</xsd:sequence>
<xsd:attribute name="rec_desc" type="Rec_typ" fixed="54" />
<xsd:attribute name="rec_code" type="Rec_subtyp" fixed="3" />
</xsd:complexType>
    
```

13.4.16 Attribute

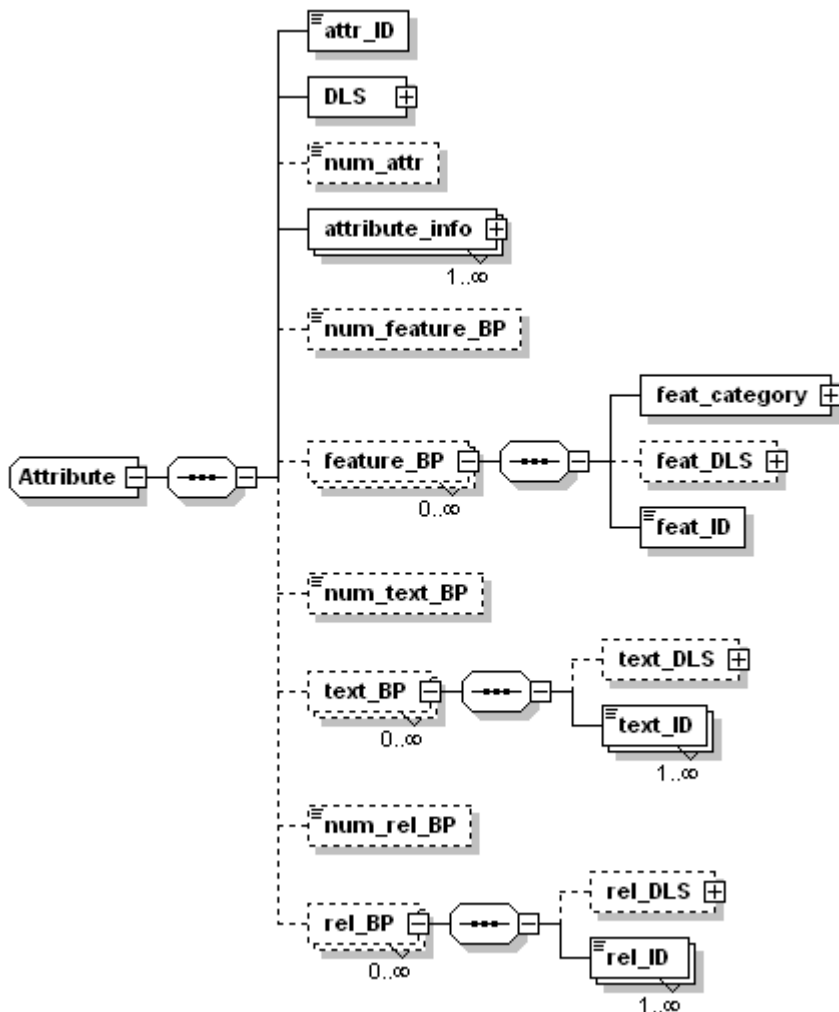

```

<xsd:complexType name="Attribute">
  <xsd:sequence>
    <xsd:element name="attr_ID" type="Attr_ID"/>
    <xsd:element name="DLS" type="DLS_ID"/>
    <xsd:element name="num_attr" type="Five_digit_int" minOccurs="0"/>
    <xsd:element name="attribute_info" maxOccurs="unbounded">
      <xsd:complexType>
        <xsd:sequence>
          <xsd:element ref="AttributeDescriptor"/>
        </xsd:sequence>
      </xsd:complexType>
    </xsd:element>
    <xsd:element name="num_feature_BP" type="Ten_digit_int" minOccurs="0"/>
    <xsd:element name="feature_BP" minOccurs="0" maxOccurs="unbounded">
      <xsd:complexType>
        <xsd:sequence>
          <xsd:element name="feat_category" type="Feat_cat"/>
          <xsd:element name="feat_DLS" type="Optional_DLS_ID" minOccurs="0"/>
          <xsd:element name="feat_ID" type="Rec_ID"/>
        </xsd:sequence>
      </xsd:complexType>
    </xsd:element>
    <xsd:element name="num_text_BP" type="Ten_digit_int" minOccurs="0"/>
    <xsd:element name="text_BP" minOccurs="0" maxOccurs="unbounded">
      <xsd:complexType>
        <xsd:sequence>
          <xsd:element name="text_DLS" type="Optional_DLS_ID" minOccurs="0"/>
          <xsd:element name="text_ID" type="Text_ID" maxOccurs="unbounded"/>
        </xsd:sequence>
      </xsd:complexType>
    </xsd:element>
    <xsd:element name="num_rel_BP" type="Ten_digit_int" minOccurs="0"/>
    <xsd:element name="rel_BP" minOccurs="0" maxOccurs="unbounded">
      <xsd:complexType>
        <xsd:sequence>
          <xsd:element name="rel_DLS" type="Optional_DLS_ID" minOccurs="0"/>
          <xsd:element name="rel_ID" type="Relationship_ID" maxOccurs="unbounded"/>
        </xsd:sequence>
      </xsd:complexType>
    </xsd:element>
    <xsd:attribute name="rec_desc" type="Rec_typ" fixed="44"/>
  </xsd:sequence>
</xsd:complexType>

```

13.4.17 Relationship

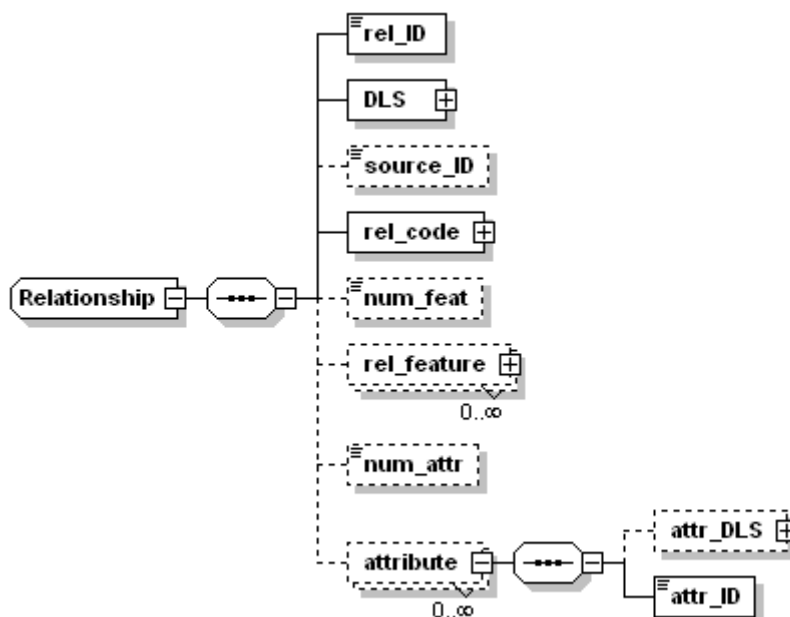

```

<xsd:complexType name="Relationship">
  <xsd:sequence>

```

```

<xsd:element name="rel_ID" type="Relationship_ID"/>
<xsd:element name="DLS" type="DLS_ID"/>
<xsd:element name="source_ID" type="Src_desc_ID" minOccurs="0"/>
<xsd:element name="rel_code" type="Rel_cod"/>
<xsd:element name="num_feat" minOccurs="0">
  <xsd:simpleType>
    <xsd:restriction base="xsd:integer">
      <xsd:minInclusive value="1"/>
      <xsd:maxInclusive value="99999"/>
    </xsd:restriction>
  </xsd:simpleType>
</xsd:element>
<xsd:element name="rel_feature" type="Rel_feature" minOccurs="0" maxOccurs="unbounded"/>
<xsd:element name="num_attr" type="Ten_digit_int" minOccurs="0"/>
<xsd:element name="attribute" minOccurs="0" maxOccurs="unbounded">
  <xsd:complexType>
    <xsd:sequence>
      <xsd:element name="attr_DLS" type="Optional_DLS_ID" minOccurs="0"/>
      <xsd:element name="attr_ID" type="Attr_ID"/>
    </xsd:sequence>
  </xsd:complexType>
</xsd:element>
</xsd:sequence>
<xsd:attribute name="rec_desc" type="Rec_typ" fixed="50"/>
</xsd:complexType>

```

13.4.18 Text

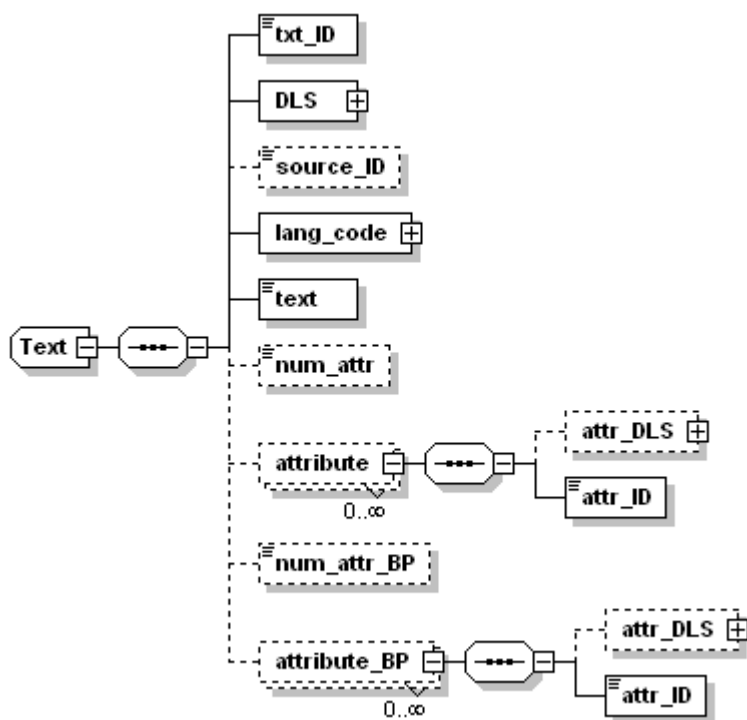

```

<xsd:complexType name="Text">
  <xsd:sequence>
    <xsd:element name="txt_ID" type="Text_ID"/>
    <xsd:element name="DLS" type="DLS_ID"/>
    <xsd:element name="source_ID" type="Src_desc_ID" minOccurs="0"/>
    <xsd:element name="lang_code" type="Lan_cod"/>
    <xsd:element name="text" type="xsd:string"/>
    <xsd:element name="num_attr" type="Ten_digit_int" minOccurs="0"/>
    <xsd:element name="attribute" minOccurs="0" maxOccurs="unbounded">
      <xsd:complexType>
        <xsd:sequence>
          <xsd:element name="attr_DLS" type="Optional_DLS_ID" minOccurs="0"/>
          <xsd:element name="attr_ID" type="Attr_ID"/>
        </xsd:sequence>
      </xsd:complexType>
    </xsd:element>
    <xsd:element name="num_attr_BP" type="Ten_digit_int" minOccurs="0"/>
    <xsd:element name="attribute_BP" minOccurs="0" maxOccurs="unbounded">
      <xsd:complexType>
        <xsd:sequence>
          <xsd:element name="attr_DLS" type="Optional_DLS_ID" minOccurs="0"/>
          <xsd:element name="attr_ID" type="Attr_ID"/>
        </xsd:sequence>
      </xsd:complexType>
    </xsd:element>
  </xsd:sequence>
</xsd:complexType>

```

```

<xsd:element name="num_attr_BP" type="Ten_digit_int" minOccurs="0"/>
<xsd:element name="attribute_BP" minOccurs="0" maxOccurs="unbounded">
  <xsd:complexType>
    <xsd:sequence>
      <xsd:element name="attr_DLS" type="Optional_DLS_ID" minOccurs="0"/>
      <xsd:element name="attr_ID" type="Attr_ID"/>
    </xsd:sequence>
  </xsd:complexType>
</xsd:element>
</xsd:sequence>
<xsd:attribute name="rec_desc" type="Rec_typ" fixed="41"/>
</xsd:complexType>

```

13.4.19 Conversion

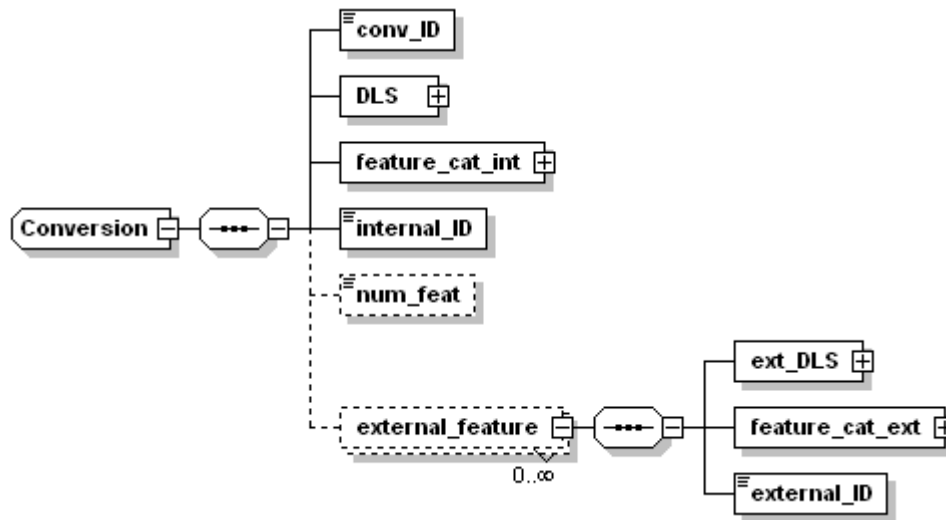

```

<xsd:complexType name="Conversion">
  <xsd:sequence>
    <xsd:element name="conv_ID" type="Conversion_ID"/>
    <xsd:element name="DLS" type="DLS_ID"/>
    <xsd:element name="feature_cat_int" type="Feat_cat"/>
    <xsd:element name="internal_ID" type="Feature_ID"/>
    <xsd:element name="num_feat" type="Five_digit_int" minOccurs="0"/>
    <xsd:element name="external_feature" minOccurs="0" maxOccurs="unbounded">
      <xsd:complexType>
        <xsd:sequence>
          <xsd:element name="ext_DLS" type="DLS_ID"/>
          <xsd:element name="feature_cat_ext" type="Feat_cat"/>
          <xsd:element name="external_ID" type="Feature_ID"/>
        </xsd:sequence>
      </xsd:complexType>
    </xsd:element>
  </xsd:sequence>
  <xsd:attribute name="rec_desc" type="Rec_typ" fixed="46"/>
</xsd:complexType>

```

13.4.20 Time Domain

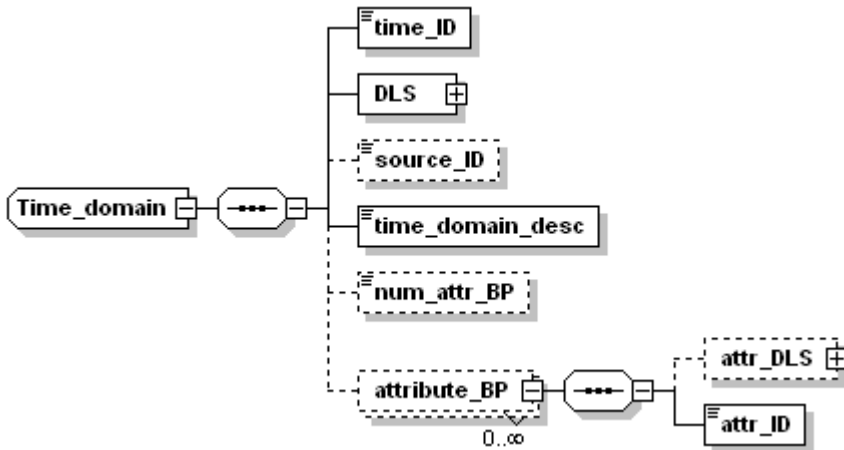

```

<xsd:complexType name="Time_domain">
  <xsd:sequence>
    <xsd:element name="time_ID" type="Time_ID"/>
    <xsd:element name="DLS" type="DLS_ID"/>
    <xsd:element name="source_ID" type="Src_desc_ID" minOccurs="0"/>
    <xsd:element name="time_domain_desc" type="xsd:string"/>
    <xsd:element name="num_attr_BP" type="Ten_digit_int" minOccurs="0"/>
    <xsd:element name="attribute_BP" minOccurs="0" maxOccurs="unbounded">
      <xsd:complexType>
        <xsd:sequence>
          <xsd:element name="attr_DLS" type="Optional_DLS_ID" minOccurs="0"/>
          <xsd:element name="attr_ID" type="Attr_ID"/>
        </xsd:sequence>
      </xsd:complexType>
    </xsd:element>
  </xsd:sequence>
  <xsd:attribute name="rec_desc" type="Rec_typ" fixed="45"/>
</xsd:complexType>
  
```

13.4.21 Object Reference

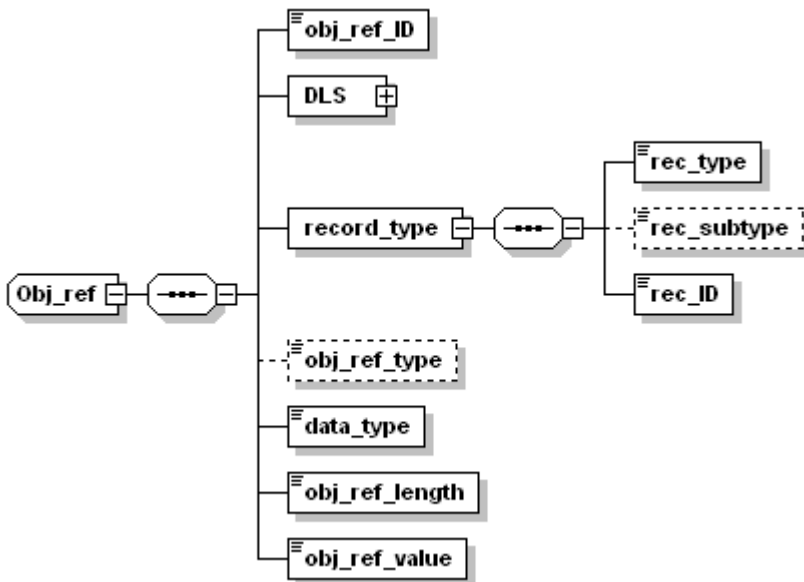

```

<xsd:complexType name="Obj_ref">
  <xsd:sequence>
    <xsd:element name="obj_ref_ID" type="Obj_ref_ID"/>
    <xsd:element name="DLS" type="DLS_ID"/>
    <xsd:element name="record_type">
      <xsd:complexType>
        <xsd:sequence>
          <xsd:element name="rec_type" type="Rec_typ" fixed="45"/>
          <xsd:element name="rec_subtype" type="xsd:string" minOccurs="0"/>
          <xsd:element name="rec_ID" type="Rec_ID"/>
        </xsd:sequence>
      </xsd:complexType>
    </xsd:element>
    <xsd:element name="obj_ref_type" type="xsd:string" minOccurs="0"/>
    <xsd:element name="data_type" type="Data_typ" fixed="45"/>
    <xsd:element name="obj_ref_length" type="Ten_digit_int" minOccurs="0"/>
    <xsd:element name="obj_ref_value" type="xsd:string"/>
  </xsd:sequence>
</xsd:complexType>
  
```

```

        <xsd:element name="rec_type" type="Record_type_val_reduced"/>
        <xsd:element name="rec_subtype" type="Rec_subtype" minOccurs="0"/>
        <xsd:element name="rec_ID" type="Rec_ID"/>
    </xsd:sequence>
</xsd:complexType>
</xsd:element>
<xsd:element name="obj_ref_type" type="Obj_ref_typ" minOccurs="0"/>
<xsd:element name="data_type" type="Data_typ"/>
<xsd:element name="obj_ref_length" type="Five_digit_ID"/>
<xsd:element name="obj_ref_value" type="xsd:string"/>
</xsd:sequence>
<xsd:attribute name="rec_desc" type="Rec_typ" fixed="83"/>
</xsd:complexType>

```

13.4.22 Album Header

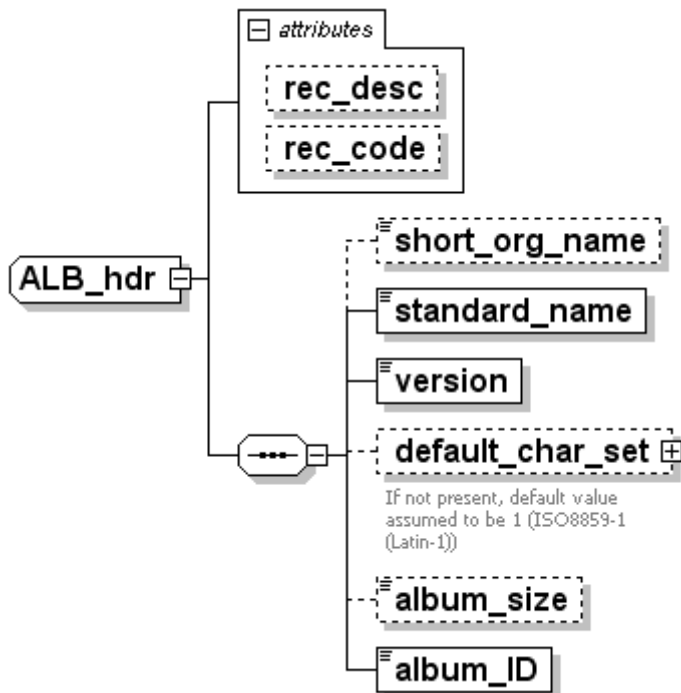

```

<xsd:complexType name="ALB_hdr">
  <xsd:sequence>
    <xsd:element name="short_org_name" minOccurs="0">
      <xsd:simpleType>
        <xsd:restriction base="xsd:string">
          <xsd:length value="18"/>
        </xsd:restriction>
      </xsd:simpleType>
    </xsd:element>
    <xsd:element name="standard_name">
      <xsd:simpleType>
        <xsd:restriction base="xsd:string">
          <xsd:length value="10"/>
        </xsd:restriction>
      </xsd:simpleType>
    </xsd:element>
    <xsd:element name="version">
      <xsd:simpleType>
        <xsd:restriction base="xsd:string">
          <xsd:length value="4"/>
        </xsd:restriction>
      </xsd:simpleType>
    </xsd:element>
    <xsd:element name="default_char_set" type="Char_set" minOccurs="0">
      <xsd:annotation>
        <xsd:documentation>If not present, default value assumed to be 1 (ISO8859-1 (Latin-1))</xsd:documentation>
      </xsd:annotation>
    </xsd:element>
    <xsd:element name="album_size" type="xsd:int" minOccurs="0"/>
  </xsd:sequence>
</complexType>

```

```

    <xsd:element name="album_ID" type="Alb_ID"/>
  </xsd:sequence>
  <xsd:attribute name="rec_desc" type="Rec_typ" fixed="1"/>
  <xsd:attribute name="rec_code" type="Rec_subtyp" fixed="1"/>
</xsd:complexType>

```

13.4.23 Local Character Set Definition

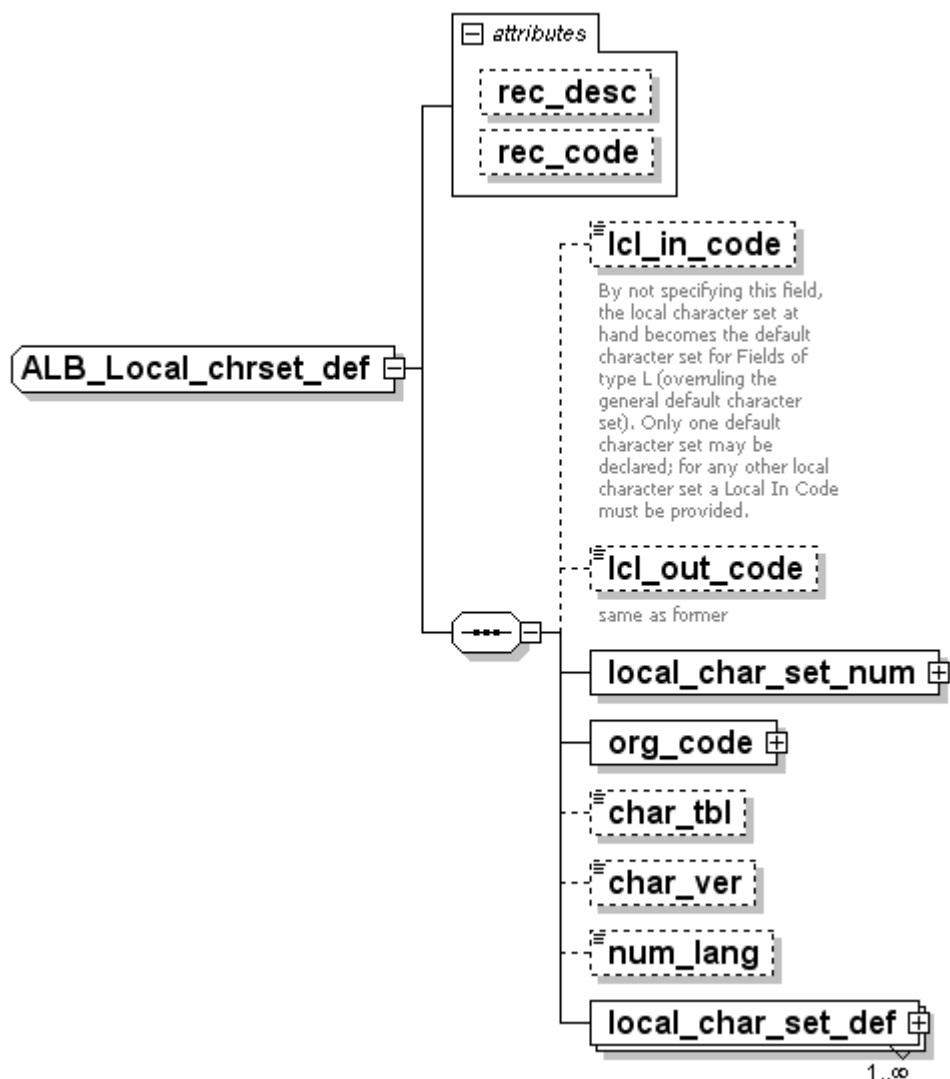

```

<xsd:complexType name="ALB_Local_chrset_def">
  <xsd:sequence>
    <xsd:element name="lcl_in_code" minOccurs="0">
      <xsd:annotation>
        <xsd:documentation>By not specifying this field, the local character set at hand
        becomes the default character set for Fields of type L (overruling the general
        default character set). Only one default character set may be declared; for any other
        local character set a Local In Code must be provided.</xsd:documentation>
      </xsd:annotation>
      <xsd:simpleType>
        <xsd:restriction base="xsd:string">
          <xsd:maxLength value="2"/>
        </xsd:restriction>
      </xsd:simpleType>
    </xsd:element>
    <xsd:element name="lcl_out_code" minOccurs="0">
      <xsd:annotation>
        <xsd:documentation>same as former</xsd:documentation>
      </xsd:annotation>

```



```

<xsd:simpleType>
  <xsd:restriction base="xsd:string">
    <xsd:maxLength value="2"/>
  </xsd:restriction>
</xsd:simpleType>
</xsd:element>
<xsd:element name="local_char_set_num" type="Extended_char_set"/>
<xsd:element name="org_code" type="Cntry_cod"/>
<xsd:element name="char_tbl" minOccurs="0">
  <xsd:simpleType>
    <xsd:restriction base="xsd:string">
      <xsd:length value="20"/>
    </xsd:restriction>
  </xsd:simpleType>
</xsd:element>
<xsd:element name="char_ver" minOccurs="0">
  <xsd:simpleType>
    <xsd:restriction base="xsd:string">
      <xsd:length value="10"/>
    </xsd:restriction>
  </xsd:simpleType>
</xsd:element>
<xsd:element name="num_lang" type="Three_digit_int" minOccurs="0"/>
<xsd:element name="local_char_set_def" type="LC_pair" maxOccurs="unbounded"/>
</xsd:sequence>
<xsd:attribute name="rec_desc" type="Rec_typ" fixed="1"/>
<xsd:attribute name="rec_code" type="Rec_subtyp" fixed="2"/>
</xsd:complexType>

```

13.4.24 Global Album Information

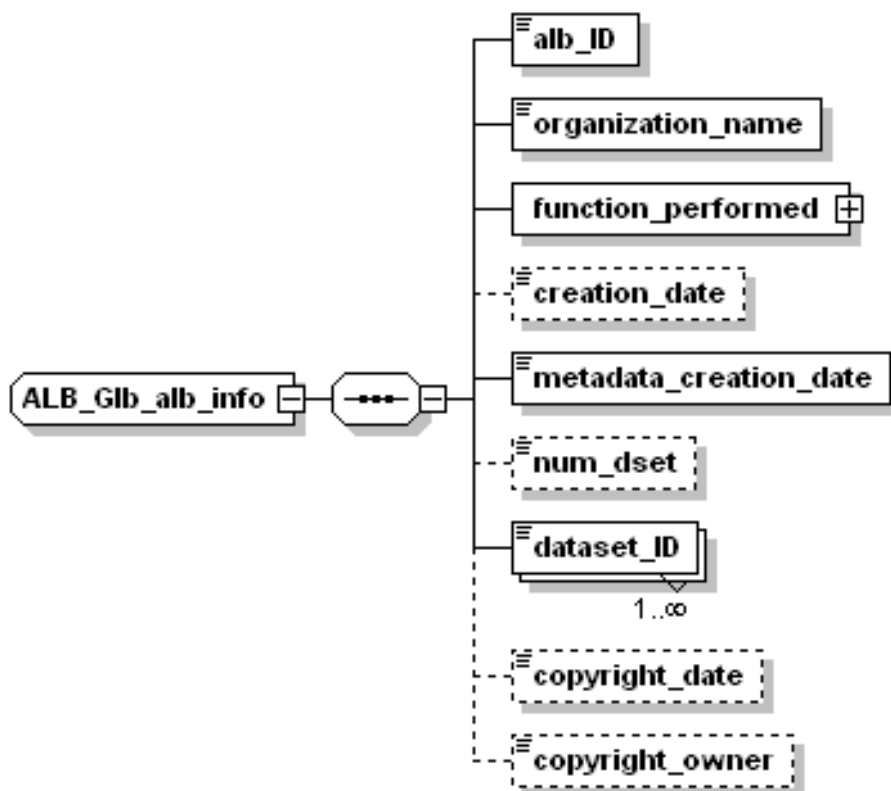

```

<xsd:complexType name="ALB_Glb_alb_info">
  <xsd:sequence>
    <xsd:element name="alb_ID" type="Alb_ID"/>
    <xsd:element name="organization_name">
      <xsd:simpleType>
        <xsd:restriction base="xsd:string">
          <xsd:maxLength value="40"/>
        </xsd:restriction>
      </xsd:simpleType>
    </xsd:element>

```

```

<xsd:element name="function_performed" type="Role_code"/>
<xsd:element name="creation_date" type="Eight_digit_t_coord" minOccurs="0"/>
<xsd:element name="metadata_creation_date" type="Eight_digit_t_coord"/>
<xsd:element name="num_dset" minOccurs="0">
  <xsd:simpleType>
    <xsd:restriction base="Two_digit_int">
      <xsd:minInclusive value="1"/>
      <xsd:maxInclusive value="99"/>
      <xsd:totalDigits value="2"/>
    </xsd:restriction>
  </xsd:simpleType>
</xsd:element>
<xsd:element name="dataset_ID" type="Dset_ID" maxOccurs="unbounded"/>
<xsd:element name="copyright_date" type="Eight_digit_t_coord" minOccurs="0"/>
<xsd:element name="copyright_owner" type="xsd:string" minOccurs="0"/>
</xsd:sequence>
<xsd:attribute name="rec_desc" type="Rec_typ" fixed="1"/>
<xsd:attribute name="rec_code" type="Rec_subtyp" fixed="3"/>
</xsd:complexType>

```

13.4.25 Dataset Identification

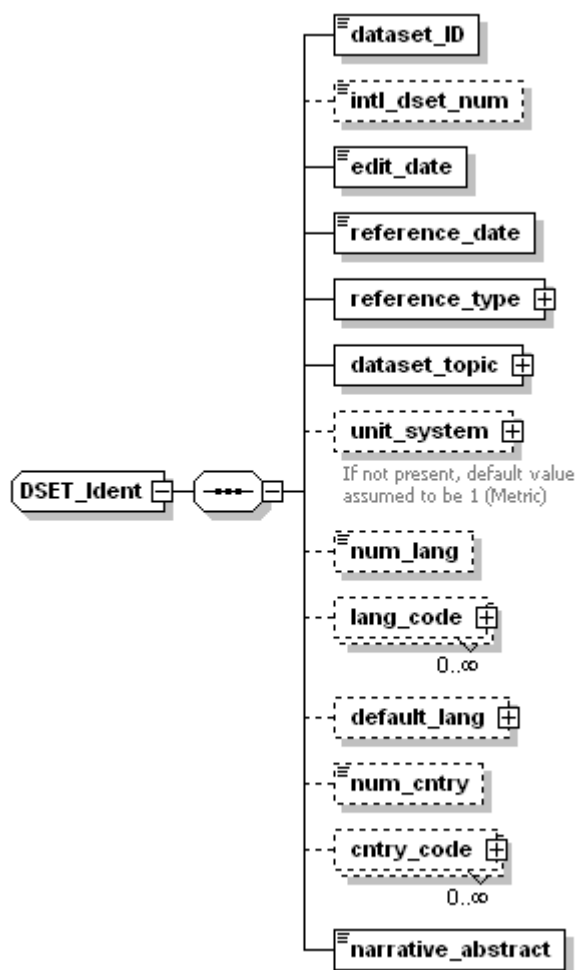

```

<xsd:complexType name="DSET_Ident">
  <xsd:sequence>
    <xsd:element name="dataset_ID" type="Dset_ID"/>
    <xsd:element name="intl_dset_num" minOccurs="0">
      <xsd:simpleType>
        <xsd:restriction base="xsd:string">
          <xsd:length value="13"/>
        </xsd:restriction>
      </xsd:simpleType>
    </xsd:element>
    <xsd:element name="edit_date">
      <xsd:simpleType>

```

```

        <xsd:restriction base="xsd:integer">
          <xsd:totalDigits value="10"/>
        </xsd:restriction>
      </xsd:simpleType>
    </xsd:element>
    <xsd:element name="reference_date">
      <xsd:simpleType>
        <xsd:restriction base="xsd:integer">
          <xsd:totalDigits value="10"/>
        </xsd:restriction>
      </xsd:simpleType>
    </xsd:element>
    <xsd:element name="reference_type" type="Ref_type" />
    <xsd:element name="dataset_topic" type="Topic" />
    <xsd:element name="unit_system" type="Unit_system" minOccurs="0">
      <xsd:annotation>
        <xsd:documentation>If not present, default value assumed to be 1
          (Metric)</xsd:documentation>
      </xsd:annotation>
    </xsd:element>
    <xsd:element name="num_lang" type="Three_digit_int" minOccurs="0" />
    <xsd:element name="lang_code" type="Lan_cod" minOccurs="0" maxOccurs="unbounded" />
    <xsd:element name="default_lang" type="Lan_cod" minOccurs="0" />
    <xsd:element name="num_centry" type="xsd:string" minOccurs="0" />
    <xsd:element name="centry_code" type="Centry_cod" minOccurs="0" maxOccurs="unbounded" />
    <xsd:element name="narrative_abstract" type="xsd:string" />
  </xsd:sequence>
  <xsd:attribute name="rec_desc" type="Rec_typ" fixed="2" />
  <xsd:attribute name="rec_code" type="Rec_subtyp" fixed="1" />
</xsd:complexType>

```

13.4.26 Dataset Main Title

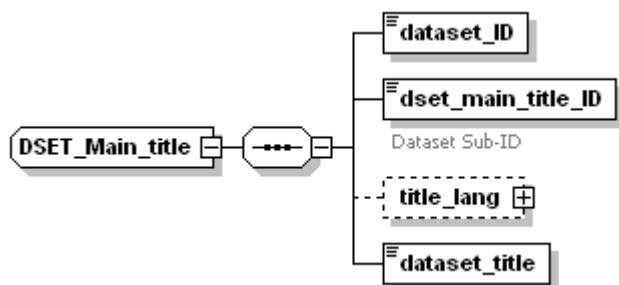

```

<xsd:complexType name="DSET_Main_title">
  <xsd:sequence>
    <xsd:element name="dataset_ID" type="Dset_ID" />
    <xsd:element name="dset_main_title_ID" type="Main_title_ID">
      <xsd:annotation>
        <xsd:documentation>Dataset Sub-ID</xsd:documentation>
      </xsd:annotation>
    </xsd:element>
    <xsd:element name="title_lang" type="Lan_cod" minOccurs="0" />
    <xsd:element name="dataset_title" type="xsd:string" />
  </xsd:sequence>
  <xsd:attribute name="rec_desc" type="Rec_typ" fixed="2" />
  <xsd:attribute name="rec_code" type="Rec_subtyp" fixed="2" />
</xsd:complexType>

```

13.4.27 Dataset Subtitle

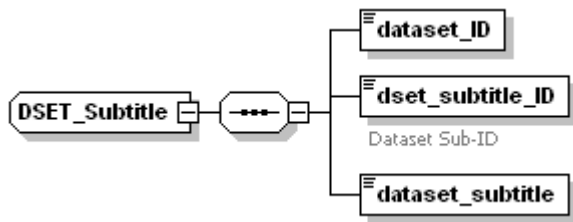

```
<xsd:complexType name="DSET_Subtitle">
  <xsd:sequence>
    <xsd:element name="dataset_ID" type="Dset_ID" />
    <xsd:element name="dset_subtitle_ID" type="Dset_subtitle_ID">
      <xsd:annotation>
        <xsd:documentation>Dataset Sub-ID</xsd:documentation>
      </xsd:annotation>
    </xsd:element>
    <xsd:element name="dataset_subtitle" type="xsd:string" />
  </xsd:sequence>
  <xsd:attribute name="rec_desc" type="Rec_typ" fixed="2" />
  <xsd:attribute name="rec_code" type="Rec_subtyp" fixed="3" />
</xsd:complexType>
```

13.4.28 Dataset Producer

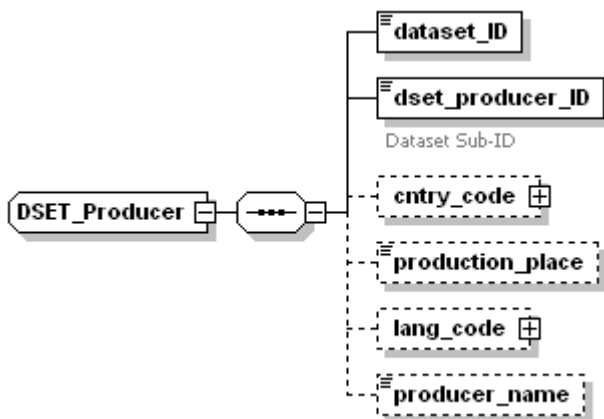

```
<xsd:complexType name="DSET_Producer">
  <xsd:sequence>
    <xsd:element name="dataset_ID" type="Dset_ID" />
    <xsd:element name="dset_producer_ID" type="Dset_producer_ID">
      <xsd:annotation>
        <xsd:documentation>Dataset Sub-ID</xsd:documentation>
      </xsd:annotation>
    </xsd:element>
    <xsd:element name="centry_code" type="Centry_cod" minOccurs="0" />
    <xsd:element name="production_place" minOccurs="0">
      <xsd:simpleType>
        <xsd:restriction base="xsd:string">
          <xsd:maxLength value="50" />
        </xsd:restriction>
      </xsd:simpleType>
    </xsd:element>
    <xsd:element name="lang_code" type="Lan_cod" minOccurs="0" />
    <xsd:element name="producer_name" type="xsd:string" minOccurs="0" />
  </xsd:sequence>
  <xsd:attribute name="rec_desc" type="Rec_typ" fixed="2" />
  <xsd:attribute name="rec_code" type="Rec_subtyp" fixed="4" />
</xsd:complexType>
```

13.4.29 Dataset Extension Currency

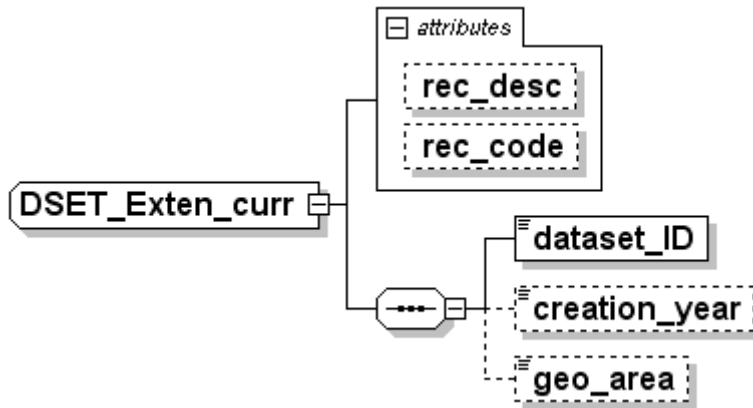

```

<xsd:complexType name="DSET_Exten_curr">
  <xsd:sequence>
    <xsd:element name="dataset_ID" type="Dset_ID"/>
    <xsd:element name="creation_year" minOccurs="0">
      <xsd:simpleType>
        <xsd:restriction base="xsd:integer">
          <xsd:totalDigits value="4"/>
        </xsd:restriction>
      </xsd:simpleType>
    </xsd:element>
    <xsd:element name="geo_area" type="xsd:string" minOccurs="0"/>
  </xsd:sequence>
  <xsd:attribute name="rec_desc" type="Rec_typ" fixed="2"/>
  <xsd:attribute name="rec_code" type="Rec_subtyp" fixed="5"/>
</xsd:complexType>

```

13.4.30 Dataset Contents

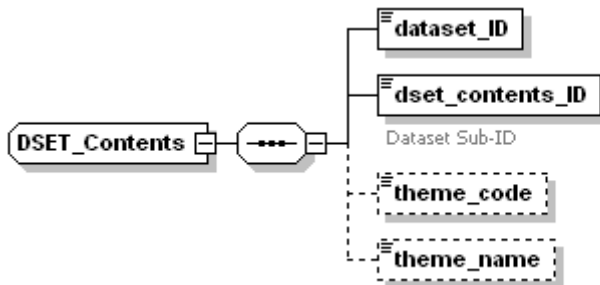

```

<xsd:complexType name="DSET_Contents">
  <xsd:sequence>
    <xsd:element name="dataset_ID" type="Dset_ID"/>
    <xsd:element name="dset_contents_ID" type="Dset_contents_ID">
      <xsd:annotation>
        <xsd:documentation>Dataset Sub-ID</xsd:documentation>
      </xsd:annotation>
    </xsd:element>
    <xsd:element name="theme_code" type="Feat_theme_val" minOccurs="0"/>
    <xsd:element name="theme_name" type="Feat_theme_nam" minOccurs="0"/>
  </xsd:sequence>
  <xsd:attribute name="rec_desc" type="Rec_typ" fixed="2"/>
  <xsd:attribute name="rec_code" type="Rec_subtyp" fixed="6"/>
</xsd:complexType>

```

13.4.31 Dataset XY Resolution

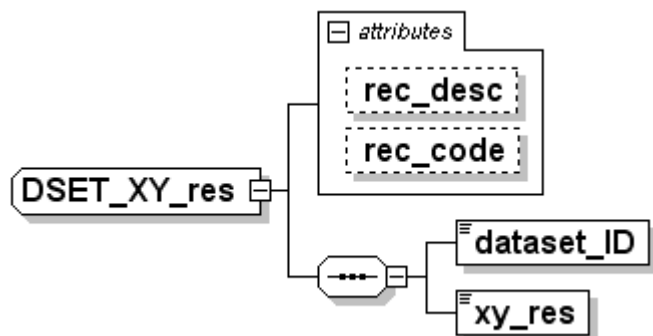

```

<xsd:complexType name="DSET_XY_res">
  <xsd:sequence>
    <xsd:element name="dataset_ID" type="Dset_ID" />
    <xsd:element name="xy_res">
      <xsd:simpleType>
        <xsd:restriction base="xsd:integer">
          <xsd:totalDigits value="3" />
        </xsd:restriction>
      </xsd:simpleType>
    </xsd:element>
  </xsd:sequence>
  <xsd:attribute name="rec_desc" type="Rec_typ" fixed="2" />
  <xsd:attribute name="rec_code" type="Rec_subtyp" fixed="7" />
</xsd:complexType>
  
```

13.4.32 Attribute Definition

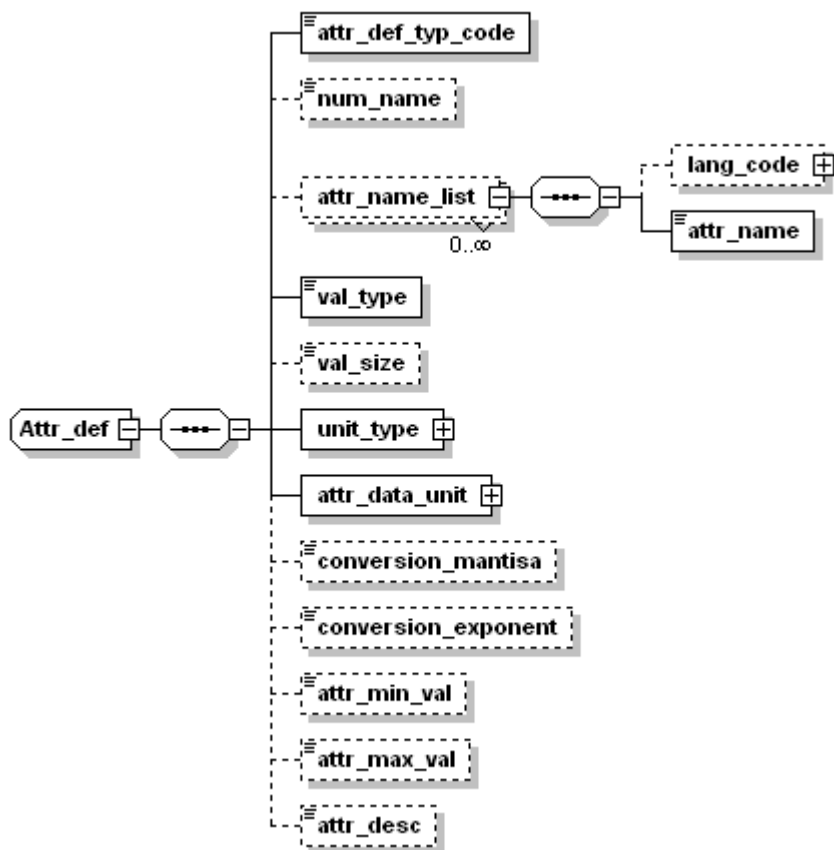

```

<xsd:complexType name="Attr_def">
  <xsd:sequence>
    <xsd:element name="attr_def_typ_code">
      <xsd:simpleType>
        <xsd:restriction base="xsd:string">
  
```

```

        <xsd:length value="2"/>
      </xsd:restriction>
    </xsd:simpleType>
  </xsd:element>
  <xsd:element name="num_name" type="Field_counter_2dig" minOccurs="0"/>
  <xsd:element name="attr_name_list" maxOccurs="unbounded">
    <xsd:complexType>
      <xsd:sequence>
        <xsd:element name="lang_code" type="Lan_cod" minOccurs="0"/>
        <xsd:element name="attr_name" type="Name" minOccurs="0"/>
      </xsd:sequence>
    </xsd:complexType>
  </xsd:element>
  <xsd:element name="val_type">
    <xsd:simpleType>
      <xsd:restriction base="xsd:string">
        <xsd:enumeration value="G"/>
        <xsd:enumeration value="A"/>
        <xsd:enumeration value="N"/>
        <xsd:enumeration value="I"/>
        <xsd:enumeration value="AN"/>
        <xsd:enumeration value="L"/>
      </xsd:restriction>
    </xsd:simpleType>
  </xsd:element>
  <xsd:element name="val_size" minOccurs="0">
    <xsd:simpleType>
      <xsd:restriction base="xsd:integer">
        <xsd:minInclusive value="1"/>
        <xsd:maxInclusive value="11"/>
        <xsd:totalDigits value="2"/>
      </xsd:restriction>
    </xsd:simpleType>
  </xsd:element>
  <xsd:element name="unit_type" type="Attr_data_type"/>
  <xsd:element name="attr_data_unit" type="Attr_data_unit"/>
  <xsd:element name="conversion_mantisa" minOccurs="0">
    <xsd:simpleType>
      <xsd:restriction base="Eleven_digit_int">
        <xsd:minInclusive value="1"/>
      </xsd:restriction>
    </xsd:simpleType>
  </xsd:element>
  <xsd:element name="conversion_exponent" type="One_digit_signed_int" minOccurs="0"/>
  <xsd:element name="attr_min_val" minOccurs="0">
    <xsd:simpleType>
      <xsd:restriction base="xsd:integer">
        <xsd:totalDigits value="11"/>
      </xsd:restriction>
    </xsd:simpleType>
  </xsd:element>
  <xsd:element name="attr_max_val" minOccurs="0">
    <xsd:simpleType>
      <xsd:restriction base="xsd:integer">
        <xsd:totalDigits value="11"/>
      </xsd:restriction>
    </xsd:simpleType>
  </xsd:element>
  <xsd:element name="attr_desc" type="xsd:string" minOccurs="0"/>
</xsd:sequence>
<xsd:attribute name="rec_desc" type="Rec_typ" fixed="5"/>
</xsd:complexType>

```

13.4.33 Directory

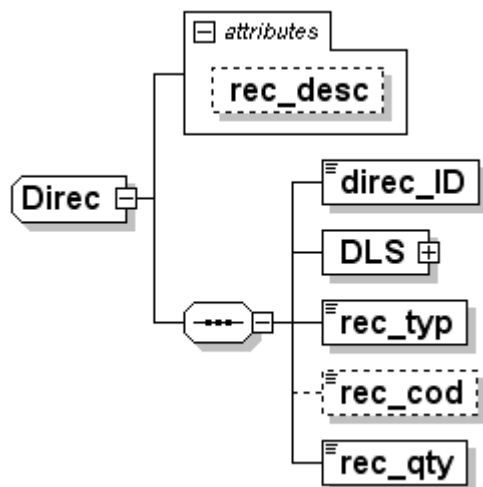

```

<xsd:complexType name="Direc">
  <xsd:sequence>
    <xsd:element name="direc_ID" type="Direc_ID"/>
    <xsd:element name="DLS" type="DLS_ID"/>
    <xsd:element name="rec_typ" type="Record_type_value"/>
    <xsd:element name="rec_code" type="Rec_subtyp" minOccurs="0"/>
    <xsd:element name="rec_qty">
      <xsd:simpleType>
        <xsd:restriction base="xsd:integer">
          <xsd:totalDigits value="8"/>
        </xsd:restriction>
      </xsd:simpleType>
    </xsd:element>
  </xsd:sequence>
  <xsd:attribute name="rec_desc" type="Rec_typ" fixed="6"/>
</xsd:complexType>

```

13.4.34 Feature Definition

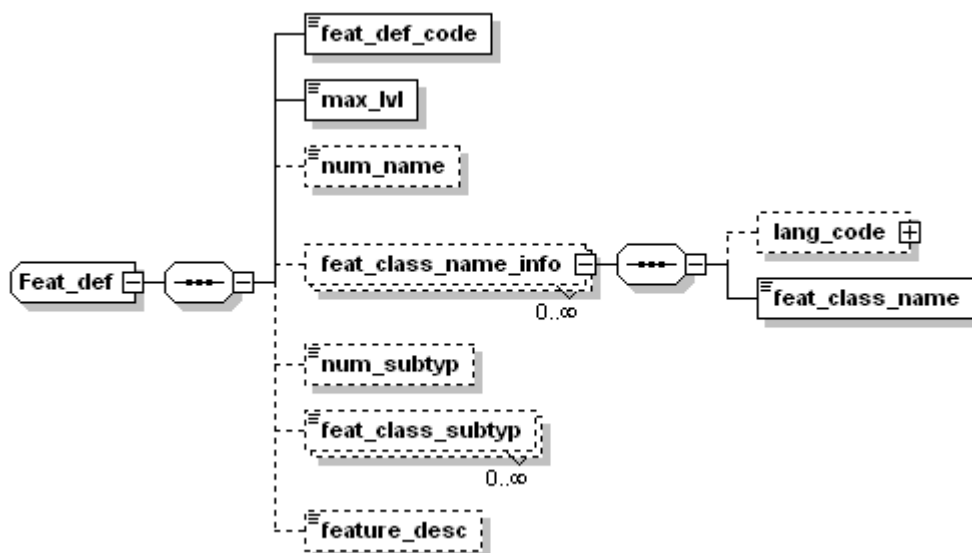

```

<xsd:complexType name="Feat_def">
  <xsd:sequence>
    <xsd:element name="feat_def_code">
      <xsd:simpleType>
        <xsd:restriction base="Four_digit_code">
          <xsd:minInclusive value="1100"/>
        </xsd:restriction>
      </xsd:simpleType>
    </xsd:element>
    <xsd:element name="max_lvl" type="Integer"/>
    <xsd:element name="num_name" type="Integer" minOccurs="0"/>
    <xsd:element name="feat_class_name_info" type="Feat_class_name_info" minOccurs="0"/>
    <xsd:element name="num_subtyp" type="Integer" minOccurs="0"/>
    <xsd:element name="feat_class_subtyp" type="Integer" minOccurs="0"/>
    <xsd:element name="feature_desc" type="Text" minOccurs="0"/>
  </xsd:sequence>

```



```

    </xsd:simpleType>
  </xsd:element>
  <xsd:element name="max_lvl">
    <xsd:simpleType>
      <xsd:restriction base="xsd:integer">
        <xsd:minInclusive value="1"/>
        <xsd:maxInclusive value="99"/>
        <xsd:totalDigits value="2"/>
      </xsd:restriction>
    </xsd:simpleType>
  </xsd:element>
  <xsd:element name="num_name" type="Field_counter_2dig" minOccurs="0"/>
  <xsd:element name="feat_class_name_info" minOccurs="0" maxOccurs="unbounded">
    <xsd:complexType>
      <xsd:sequence>
        <xsd:element name="lang_code" type="Lan_cod" minOccurs="0"/>
        <xsd:element name="feat_class_name" type="Name"/>
      </xsd:sequence>
    </xsd:complexType>
  </xsd:element>
  <xsd:element name="num_subtyp" type="Three_digit_int" minOccurs="0"/>
  <xsd:element name="feat_class_subtyp" minOccurs="0" maxOccurs="unbounded">
    <xsd:simpleType>
      <xsd:restriction base="Four_digit_code">
        <xsd:minInclusive value="7100"/>
      </xsd:restriction>
    </xsd:simpleType>
  </xsd:element>
  <xsd:element name="feature_desc" type="xsd:string" minOccurs="0"/>
</xsd:sequence>
<xsd:attribute name="rec_desc" type="Rec_typ" fixed="7"/>
</xsd:complexType>

```

13.4.35 Spatial Domain

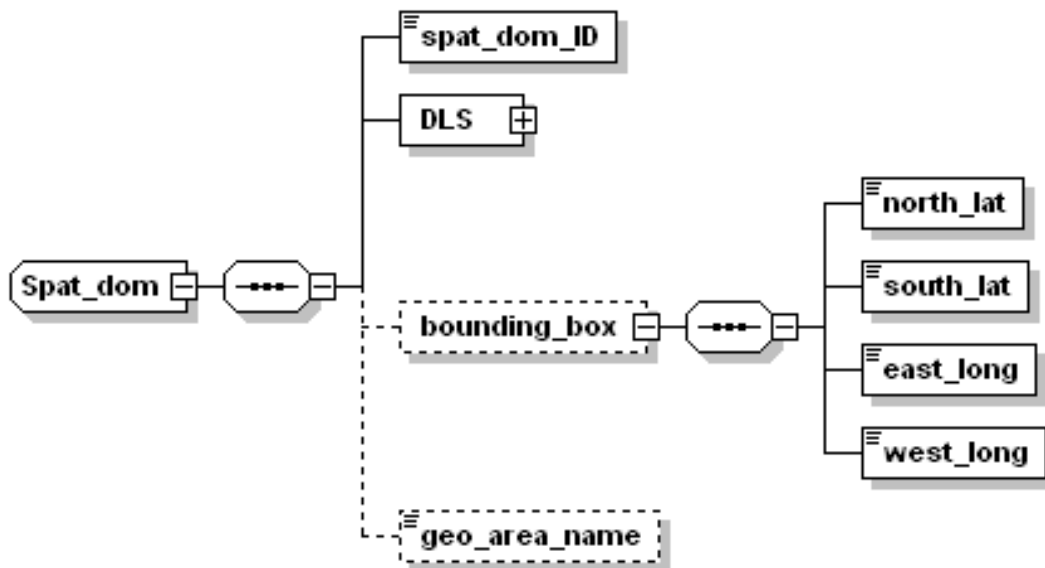

```

<xsd:complexType name="Spat_dom">
  <xsd:sequence>
    <xsd:element name="spat_dom_ID" type="Spat_dom_ID"/>
    <xsd:element name="DLS" type="DLS_ID"/>
    <xsd:element name="bounding_box" minOccurs="0">
      <xsd:complexType>
        <xsd:sequence>
          <xsd:element name="north_lat">
            <xsd:simpleType>
              <xsd:restriction base="xsd:integer">
                <xsd:minInclusive value="-90000"/>
                <xsd:maxInclusive value="+90000"/>
                <xsd:totalDigits value="7"/>
              </xsd:restriction>
            </xsd:simpleType>
          </xsd:element>

```

```

<xsd:element name="south_lat">
  <xsd:simpleType>
    <xsd:restriction base="xsd:integer">
      <xsd:minInclusive value="-90000"/>
      <xsd:maxInclusive value="+90000"/>
      <xsd:totalDigits value="7"/>
    </xsd:restriction>
  </xsd:simpleType>
</xsd:element>
<xsd:element name="east_long">
  <xsd:simpleType>
    <xsd:restriction base="xsd:integer">
      <xsd:minInclusive value="-180000"/>
      <xsd:maxInclusive value="+180000"/>
      <xsd:totalDigits value="7"/>
    </xsd:restriction>
  </xsd:simpleType>
</xsd:element>
<xsd:element name="west_long">
  <xsd:simpleType>
    <xsd:restriction base="xsd:integer">
      <xsd:minInclusive value="-180000"/>
      <xsd:maxInclusive value="+180000"/>
      <xsd:totalDigits value="7"/>
    </xsd:restriction>
  </xsd:simpleType>
</xsd:element>
</xsd:sequence>
</xsd:complexType>
</xsd:element>
<xsd:element name="geo_area_name" type="xsd:string" minOccurs="0"/>
</xsd:sequence>
<xsd:attribute name="rec_desc" type="Rec_typ" fixed="8"/>
</xsd:complexType>

```

13.4.36 Relationship Definition

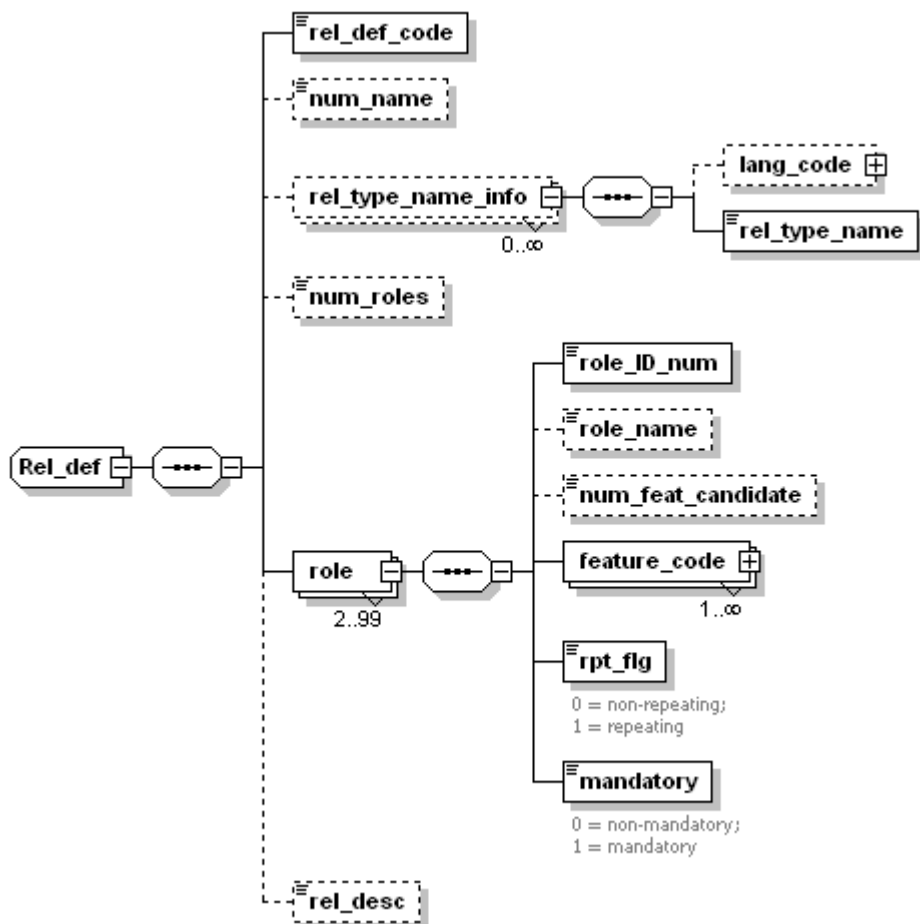

```

<xsd:complexType name="Rel_def">
  <xsd:sequence>
    <xsd:element name="rel_def_code">
      <xsd:simpleType>
        <xsd:restriction base="Four_digit_code">
          <xsd:minInclusive value="1000"/>
        </xsd:restriction>
      </xsd:simpleType>
    </xsd:element>
    <xsd:element name="num_name" type="Field_counter_2dig" minOccurs="0"/>
    <xsd:element name="rel_type_name_info" minOccurs="0" maxOccurs="unbounded">
      <xsd:complexType>
        <xsd:sequence>
          <xsd:element name="lang_code" type="Lan_cod" minOccurs="0"/>
          <xsd:element name="rel_type_name" type="Name"/>
        </xsd:sequence>
      </xsd:complexType>
    </xsd:element>
    <xsd:element name="num_roles" minOccurs="0">
      <xsd:simpleType>
        <xsd:restriction base="Two_digit_int">
          <xsd:minInclusive value="2"/>
        </xsd:restriction>
      </xsd:simpleType>
    </xsd:element>
    <xsd:element name="role" minOccurs="2" maxOccurs="99">
      <xsd:complexType>
        <xsd:sequence>
          <xsd:element name="role_ID_num">
            <xsd:simpleType>
              <xsd:restriction base="Two_digit_int">
                <xsd:minInclusive value="1"/>
              </xsd:restriction>
            </xsd:simpleType>
          </xsd:element>
          <xsd:element name="role_name" type="Name" minOccurs="0"/>
          <xsd:element name="num_feat_candidate" minOccurs="0">
            <xsd:simpleType>
              <xsd:restriction base="xsd:integer">
                <xsd:minInclusive value="1"/>
                <xsd:maxInclusive value="99"/>
              </xsd:restriction>
            </xsd:simpleType>
          </xsd:element>
          <xsd:element name="feature_code" type="Feat_code" maxOccurs="unbounded"/>
          <xsd:element name="rpt_flg" type="xsd:boolean">
            <xsd:annotation>
              <xsd:documentation>0 = non-repeating;          1 =
repeating</xsd:documentation>
            </xsd:annotation>
          </xsd:element>
          <xsd:element name="mandatory" type="xsd:boolean">
            <xsd:annotation>
              <xsd:documentation>0 = non-mandatory;        1 =
mandatory</xsd:documentation>
            </xsd:annotation>
          </xsd:element>
        </xsd:sequence>
      </xsd:complexType>
    </xsd:element>
    <xsd:element name="rel_desc" type="xsd:string" minOccurs="0"/>
  </xsd:sequence>
  <xsd:attribute name="rec_desc" type="Rec_typ" fixed="9"/>
</xsd:complexType>

```

13.4.37 Description Info

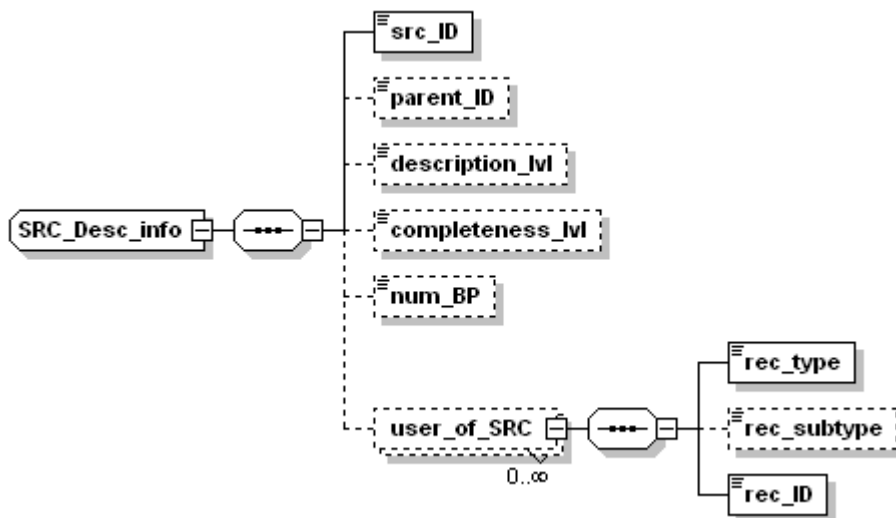

```

<xsd:complexType name="SRC_Desc_info">
  <xsd:sequence>
    <xsd:element name="src_ID" type="Src_desc_ID"/>
    <xsd:element name="parent_ID" type="Src_desc_ID" minOccurs="0"/>
    <xsd:element name="description_lvl" minOccurs="0">
      <xsd:simpleType>
        <xsd:restriction base="xsd:integer">
          <xsd:minInclusive value="1"/>
          <xsd:maxInclusive value="4"/>
          <xsd:totalDigits value="1"/>
        </xsd:restriction>
      </xsd:simpleType>
    </xsd:element>
    <xsd:element name="completeness_lvl" minOccurs="0">
      <xsd:simpleType>
        <xsd:restriction base="xsd:integer">
          <xsd:minInclusive value="1"/>
          <xsd:maxInclusive value="1"/>
          <xsd:totalDigits value="1"/>
        </xsd:restriction>
      </xsd:simpleType>
    </xsd:element>
    <xsd:element name="num_BP" type="Five_digit_int" minOccurs="0"/>
    <xsd:element name="user_of_SRC" minOccurs="0" maxOccurs="unbounded">
      <xsd:complexType>
        <xsd:sequence>
          <xsd:element name="rec_type" type="Record_type_val_reduced"/>
          <xsd:element name="rec_subtype" type="Rec_subtyp" minOccurs="0"/>
          <xsd:element name="rec_ID" type="Rec_ID"/>
        </xsd:sequence>
      </xsd:complexType>
    </xsd:element>
  </xsd:sequence>
  <xsd:attribute name="rec_desc" type="Rec_typ" fixed="14"/>
  <xsd:attribute name="rec_code" type="Rec_subtyp" fixed="1"/>
</xsd:complexType>
  
```

13.4.38 ISBN & Survey

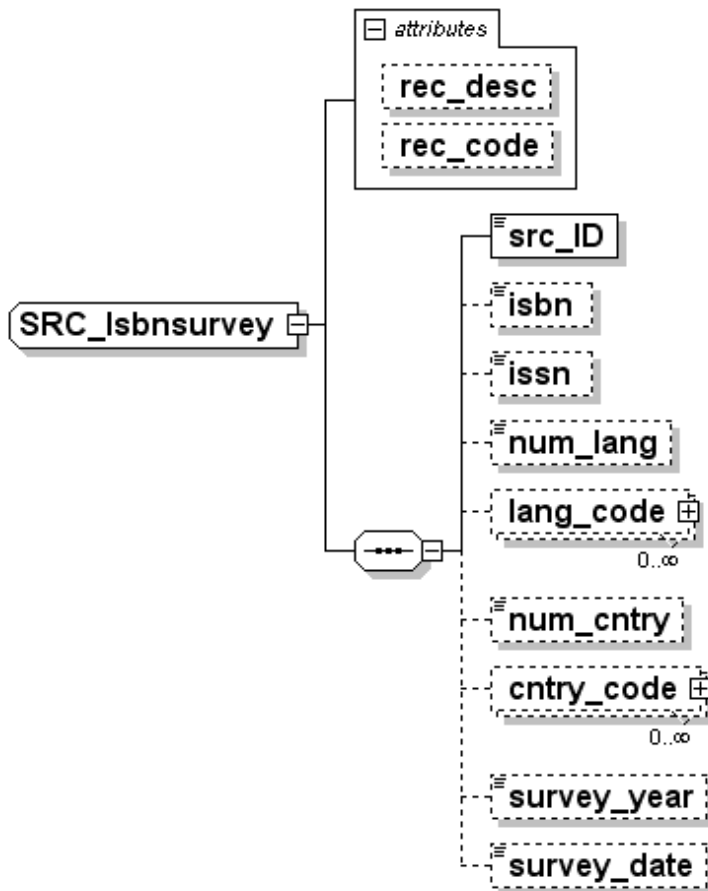

```

<xsd:complexType name="SRC_Isbnsurvey">
  <xsd:sequence>
    <xsd:element name="src_ID" type="Src_desc_ID"/>
    <xsd:element name="isbn" minOccurs="0">
      <xsd:simpleType>
        <xsd:restriction base="xsd:string">
          <xsd:length value="13"/>
        </xsd:restriction>
      </xsd:simpleType>
    </xsd:element>
    <xsd:element name="issn" minOccurs="0">
      <xsd:simpleType>
        <xsd:restriction base="xsd:string">
          <xsd:length value="10"/>
        </xsd:restriction>
      </xsd:simpleType>
    </xsd:element>
    <xsd:element name="num_lang" type="Three_digit_int" minOccurs="0"/>
    <xsd:element name="lang_code" type="Lan_cod" minOccurs="0" maxOccurs="unbounded"/>
    <xsd:element name="num_cntry" type="Three_digit_int" minOccurs="0"/>
    <xsd:element name="cntry_code" type="Cntry_cod" minOccurs="0" maxOccurs="unbounded"/>
    <xsd:element name="survey_year" minOccurs="0">
      <xsd:simpleType>
        <xsd:restriction base="xsd:integer">
          <xsd:totalDigits value="4"/>
        </xsd:restriction>
      </xsd:simpleType>
    </xsd:element>
    <xsd:element name="survey_date" minOccurs="0">
      <xsd:simpleType>
        <xsd:restriction base="xsd:string">
          <xsd:length value="6"/>
        </xsd:restriction>
      </xsd:simpleType>
    </xsd:element>
  </xsd:sequence>

```

```
<xsd:attribute name="rec_desc" type="Rec_typ" fixed="14"/>
<xsd:attribute name="rec_code" type="Rec_subtyp" fixed="2"/>
</xsd:complexType>
```

13.4.39 Author Name

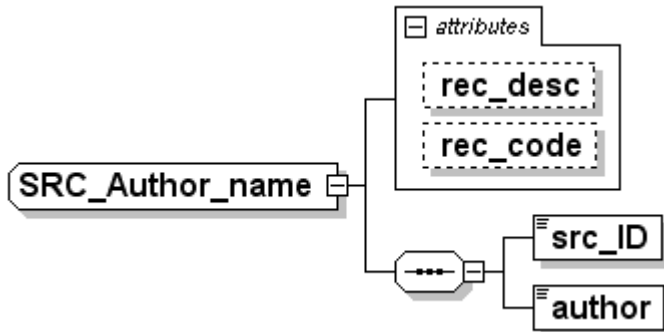

```
<xsd:complexType name="SRC_Author_name">
  <xsd:sequence>
    <xsd:element name="src_ID" type="Src_desc_ID"/>
    <xsd:element name="author" type="xsd:string"/>
  </xsd:sequence>
  <xsd:attribute name="rec_desc" type="Rec_typ" fixed="14"/>
  <xsd:attribute name="rec_code" type="Rec_subtyp" fixed="3"/>
</xsd:complexType>
```

13.4.40 Scale & Title

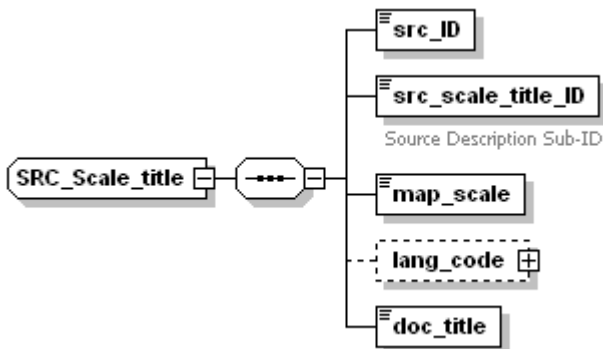

```
<xsd:complexType name="SRC_Scale_title">
  <xsd:sequence>
    <xsd:element name="src_ID" type="Src_desc_ID"/>
    <xsd:element name="src_scale_title_ID" type="Src_scale_title_ID">
      <xsd:annotation>
        <xsd:documentation>Source Description Sub-ID</xsd:documentation>
      </xsd:annotation>
    </xsd:element>
    <xsd:element name="map_scale">
      <xsd:simpleType>
        <xsd:restriction base="xsd:integer">
          <xsd:minInclusive value="1"/>
          <xsd:maxInclusive value="9999999"/>
        </xsd:restriction>
      </xsd:simpleType>
    </xsd:element>
    <xsd:element name="lang_code" type="Lan_cod" minOccurs="0"/>
    <xsd:element name="doc_title" type="xsd:string"/>
  </xsd:sequence>
  <xsd:attribute name="rec_desc" type="Rec_typ" fixed="14"/>
  <xsd:attribute name="rec_code" type="Rec_subtyp" fixed="4"/>
</xsd:complexType>
```

13.4.41 Edit & Impression

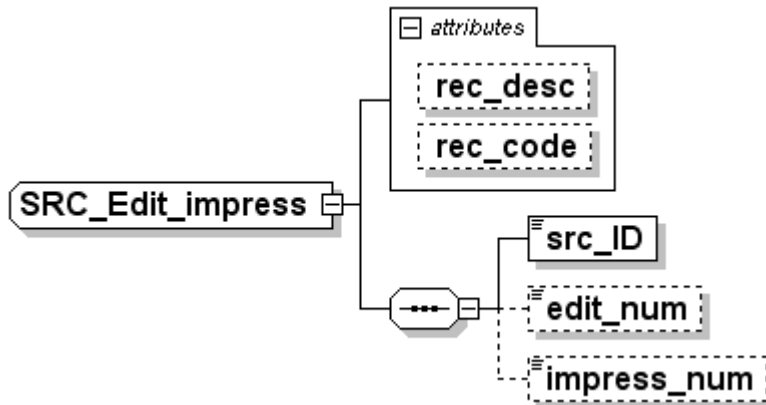

```

<xsd:complexType name="SRC_Edit_impress">
  <xsd:sequence>
    <xsd:element name="src_ID" type="Src_desc_ID"/>
    <xsd:element name="edit_num" minOccurs="0">
      <xsd:simpleType>
        <xsd:restriction base="xsd:string">
          <xsd:length value="20"/>
        </xsd:restriction>
      </xsd:simpleType>
    </xsd:element>
    <xsd:element name="impress_num" minOccurs="0">
      <xsd:simpleType>
        <xsd:restriction base="xsd:string">
          <xsd:length value="20"/>
        </xsd:restriction>
      </xsd:simpleType>
    </xsd:element>
  </xsd:sequence>
  <xsd:attribute name="rec_desc" type="Rec_typ" fixed="14"/>
  <xsd:attribute name="rec_code" type="Rec_subtyp" fixed="6"/>
</xsd:complexType>

```

13.4.42 Publisher

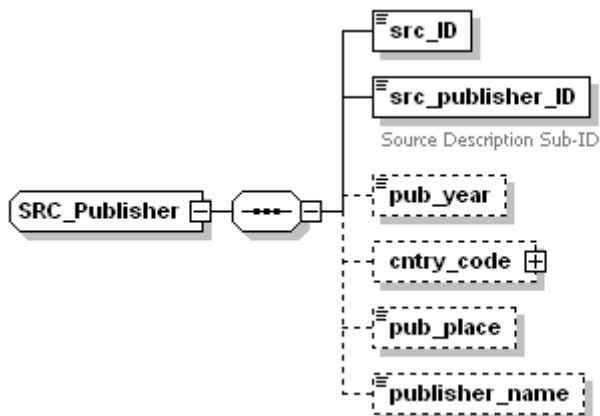

```

<xsd:complexType name="SRC_Publisher">
  <xsd:sequence>
    <xsd:element name="src_ID" type="Src_desc_ID"/>
    <xsd:element name="src_publisher_ID" type="Src_publisher_ID">
      <xsd:annotation>
        <xsd:documentation>Source Description Sub-ID</xsd:documentation>
      </xsd:annotation>
    </xsd:element>
    <xsd:element name="pub_year" minOccurs="0">
      <xsd:simpleType>
        <xsd:restriction base="xsd:integer">

```

```

        <xsd:totalDigits value="4" />
      </xsd:restriction>
    </xsd:simpleType>
  </xsd:element>
  <xsd:element name="cntry_cod" type="Cntry_cod" minOccurs="0" />
  <xsd:element name="pub_place" minOccurs="0">
    <xsd:simpleType>
      <xsd:restriction base="xsd:string">
        <xsd:maxLength value="50" />
      </xsd:restriction>
    </xsd:simpleType>
  </xsd:element>
  <xsd:element name="publisher_name" type="xsd:string" minOccurs="0" />
</xsd:sequence>
<xsd:attribute name="rec_desc" type="Rec_typ" fixed="14" />
<xsd:attribute name="rec_code" type="Rec_subtyp" fixed="7" />
</xsd:complexType>

```

13.4.43 Distribution

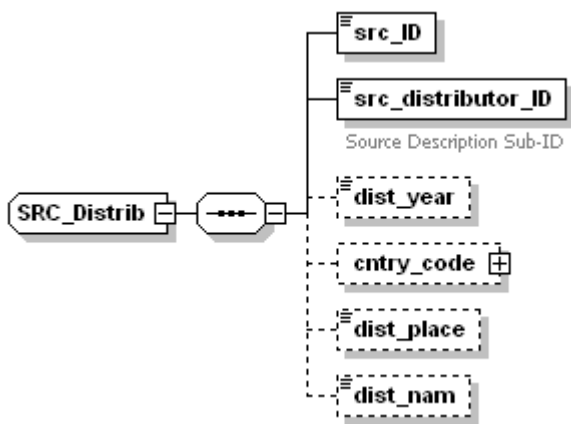

```

<xsd:complexType name="SRC_Distrib">
  <xsd:sequence>
    <xsd:element name="src_ID" type="Src_desc_ID" />
    <xsd:element name="src_distributor_ID" type="Src_distributor_ID">
      <xsd:annotation>
        <xsd:documentation>Source Description Sub-ID</xsd:documentation>
      </xsd:annotation>
    </xsd:element>
    <xsd:element name="dist_year" minOccurs="0">
      <xsd:simpleType>
        <xsd:restriction base="xsd:integer">
          <xsd:totalDigits value="4" />
        </xsd:restriction>
      </xsd:simpleType>
    </xsd:element>
    <xsd:element name="cntry_code" type="Cntry_cod" minOccurs="0" />
    <xsd:element name="dist_place" minOccurs="0">
      <xsd:simpleType>
        <xsd:restriction base="xsd:string">
          <xsd:length value="20" />
        </xsd:restriction>
      </xsd:simpleType>
    </xsd:element>
    <xsd:element name="dist_nam" type="xsd:string" minOccurs="0" />
  </xsd:sequence>
  <xsd:attribute name="rec_desc" type="Rec_typ" fixed="14" />
  <xsd:attribute name="rec_code" type="Rec_subtyp" fixed="8" />
</xsd:complexType>

```

13.4.44 Host Document

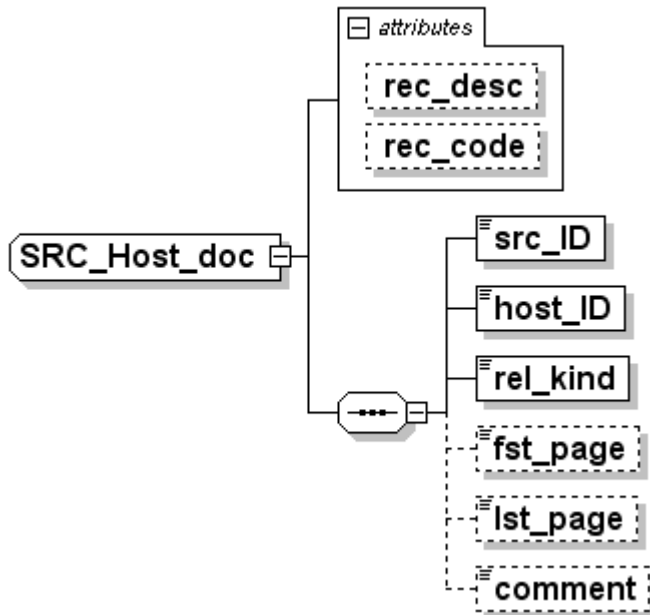

```
<xsd:complexType name="SRC_Host_doc">
  <xsd:sequence>
    <xsd:element name="src_ID" type="Src_desc_ID"/>
    <xsd:element name="host_ID" type="Five_digit_ID"/>
    <xsd:element name="rel_kind" type="Rel_kind"/>
    <xsd:element name="fst_page" minOccurs="0">
      <xsd:simpleType>
        <xsd:restriction base="xsd:integer"/>
      </xsd:simpleType>
    </xsd:element>
    <xsd:element name="lst_page" minOccurs="0">
      <xsd:simpleType>
        <xsd:restriction base="xsd:integer"/>
      </xsd:simpleType>
    </xsd:element>
    <xsd:element name="comment" type="xsd:string" minOccurs="0"/>
  </xsd:sequence>
  <xsd:attribute name="rec_desc" type="Rec_typ" fixed="14"/>
  <xsd:attribute name="rec_code" type="Rec_subtyp" fixed="9"/>
</xsd:complexType>
```

13.4.45 Field Data Capturing

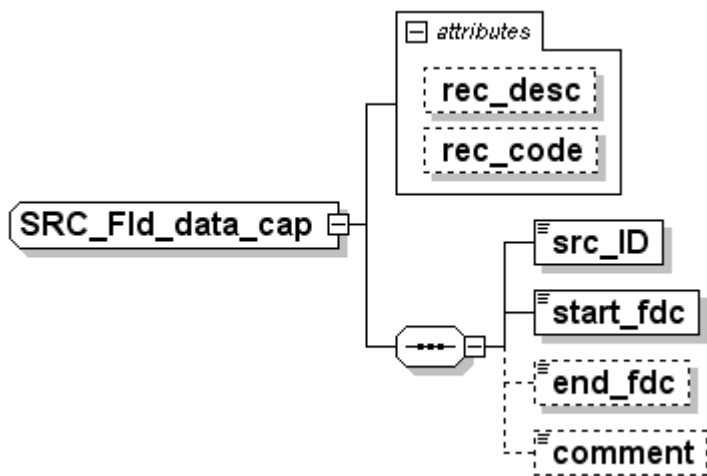

```
<xsd:complexType name="SRC_Fld_data_cap">
  <xsd:sequence>
    <xsd:element name="src_ID" type="Src_desc_ID"/>
```

```

<xsd:element name="start_fdc">
  <xsd:simpleType>
    <xsd:restriction base="xsd:string">
      <xsd:length value="8" />
    </xsd:restriction>
  </xsd:simpleType>
</xsd:element>
<xsd:element name="end_fdc" minOccurs="0">
  <xsd:simpleType>
    <xsd:restriction base="xsd:string">
      <xsd:length value="8" />
    </xsd:restriction>
  </xsd:simpleType>
</xsd:element>
<xsd:element name="comment" type="xsd:string" minOccurs="0"/>
</xsd:sequence>
<xsd:attribute name="rec_desc" type="Rec_typ" fixed="14"/>
<xsd:attribute name="rec_code" type="Rec_subtyp" fixed="10"/>
</xsd:complexType>

```

13.4.46 Abbreviation

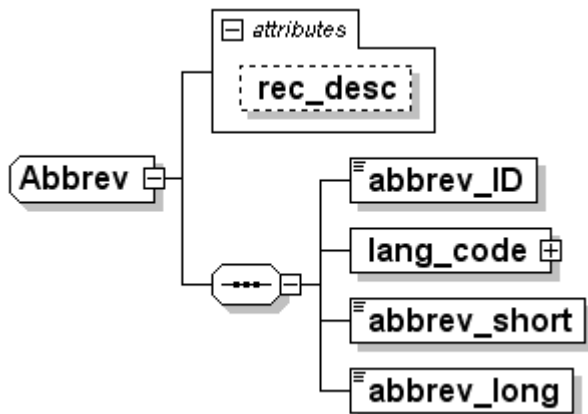

```

<xsd:complexType name="Abbrev">
  <xsd:sequence>
    <xsd:element name="abbrev_ID" type="Abbrev_ID" />
    <xsd:element name="lang_code" type="Lan_cod" />
    <xsd:element name="abbrev_short">
      <xsd:simpleType>
        <xsd:restriction base="xsd:string">
          <xsd:maxLength value="20" />
        </xsd:restriction>
      </xsd:simpleType>
    </xsd:element>
    <xsd:element name="abbrev_long">
      <xsd:simpleType>
        <xsd:restriction base="xsd:string">
          <xsd:maxLength value="50" />
        </xsd:restriction>
      </xsd:simpleType>
    </xsd:element>
  </xsd:sequence>
  <xsd:attribute name="rec_desc" type="Rec_typ" fixed="13"/>
</xsd:complexType>

```

13.4.47 Geopolitical Structure Definition

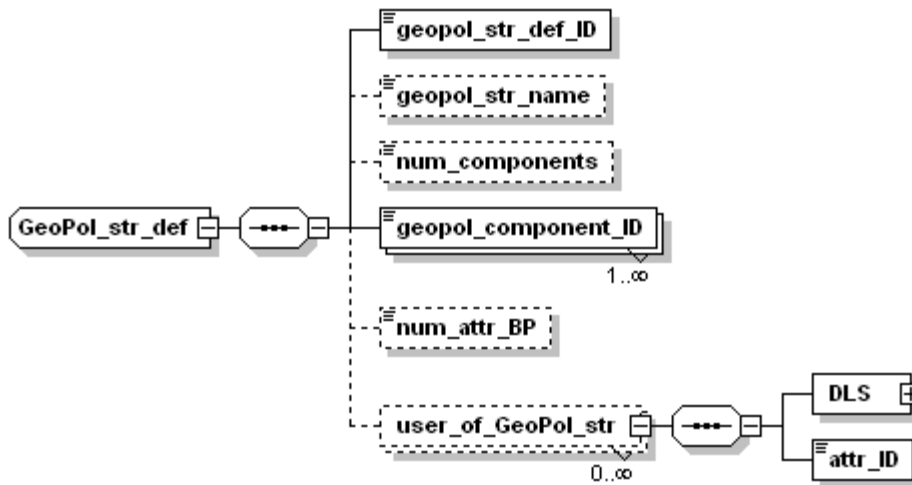

```

<xsd:complexType name="GeoPol_str_def">
  <xsd:sequence>
    <xsd:element name="geopol_str_def_ID" type="GeoPol_str_def_ID"/>
    <xsd:element name="geopol_str_name" type="Name" minOccurs="0"/>
    <xsd:element name="num_components" minOccurs="0">
      <xsd:simpleType>
        <xsd:restriction base="Field_counter_2dig">
          <xsd:minInclusive value="1"/>
        </xsd:restriction>
      </xsd:simpleType>
    </xsd:element>
    <xsd:element name="geopol_component_ID" type="GeoPol_str_cmp_def_ID"
maxOccurs="unbounded"/>
    <xsd:element name="num_attr_BP" type="Ten_digit_int" minOccurs="0"/>
    <xsd:element name="user_of_GeoPol_str" minOccurs="0" maxOccurs="unbounded">
      <xsd:complexType>
        <xsd:sequence>
          <xsd:element name="DLS" type="Optional_DLS_ID"/>
          <xsd:element name="attr_ID" type="Attr_ID"/>
        </xsd:sequence>
      </xsd:complexType>
    </xsd:element>
  </xsd:sequence>
  <xsd:attribute name="rec_desc" type="Rec_typ" fixed="10"/>
</xsd:complexType>

```

13.4.48 Geopolitical Structure Component Definition

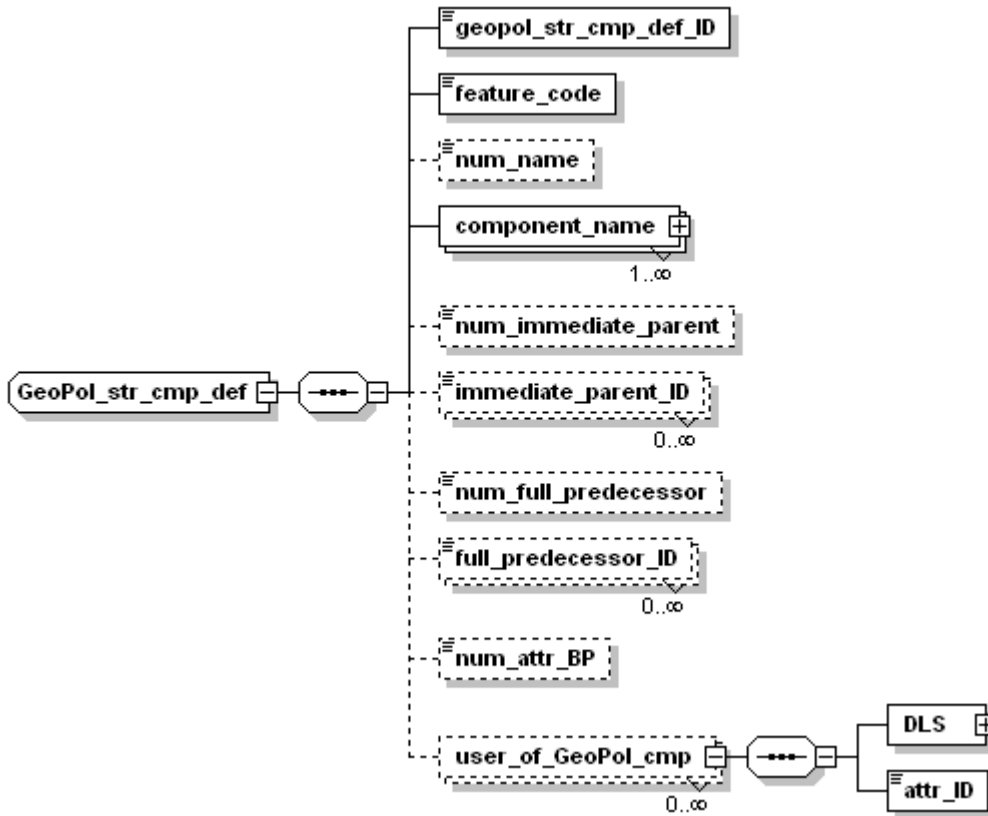

```

<xsd:complexType name="GeoPol_str_cmp_def">
  <xsd:sequence>
    <xsd:element name="geopol_str_cmp_def_ID" type="GeoPol_str_cmp_def_ID" />
    <xsd:element name="feature_code">
      <xsd:simpleType>
        <xsd:restriction base="Feature_code_value">
          <xsd:minInclusive value="1100"/>
          <xsd:maxInclusive value="3199"/>
        </xsd:restriction>
      </xsd:simpleType>
    </xsd:element>
    <xsd:element name="num_name" minOccurs="0">
      <xsd:simpleType>
        <xsd:restriction base="Field_counter_2dig">
          <xsd:minInclusive value="1"/>
        </xsd:restriction>
      </xsd:simpleType>
    </xsd:element>
    <xsd:element name="component_name" type="Lang_Name_pair" maxOccurs="unbounded"/>
    <xsd:element name="num_immediate_parent" type="Field_counter_2dig" minOccurs="0"/>
    <xsd:element name="immediate_parent_ID" type="GeoPol_str_cmp_def_ID" minOccurs="0"
      maxOccurs="unbounded"/>
    <xsd:element name="num_full_predecessor" type="Field_counter_2dig" minOccurs="0"/>
    <xsd:element name="full_predecessor_ID" type="GeoPol_str_cmp_def_ID" minOccurs="0"
      maxOccurs="unbounded"/>
    <xsd:element name="num_attr_BP" type="Ten_digit_int" minOccurs="0"/>
    <xsd:element name="user_of_GeoPol_cmp" minOccurs="0" maxOccurs="unbounded">
      <xsd:complexType>
        <xsd:sequence>
          <xsd:element name="DLS" type="Optional_DLS_ID"/>
          <xsd:element name="attr_ID" type="Attr_ID"/>
        </xsd:sequence>
      </xsd:complexType>
    </xsd:element>
  </xsd:sequence>
  <xsd:attribute name="rec_desc" type="Rec_typ" fixed="11"/>
</xsd:complexType>

```

13.4.49 Default Attribute

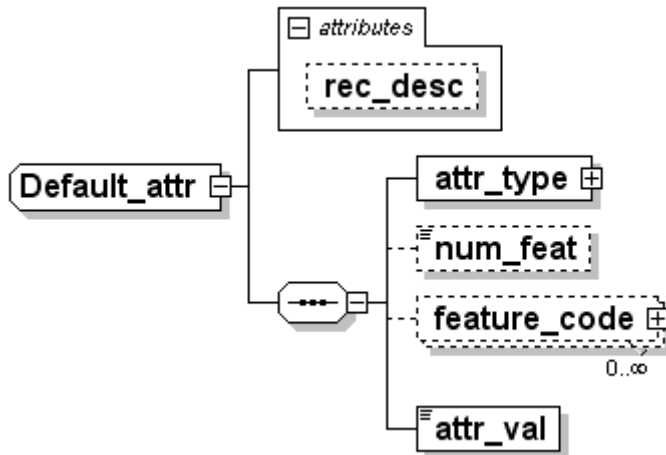

```

<xsd:complexType name="Default_attr">
  <xsd:sequence>
    <xsd:element name="attr_type" type="Attr_type_code"/>
    <xsd:element name="num_feat" type="Field_counter_5dig" minOccurs="0"/>
    <xsd:element name="feature_code" type="Feat_code" minOccurs="0" maxOccurs="unbounded"/>
    <xsd:element name="attr_val" type="Attr_val_string"/>
  </xsd:sequence>
  <xsd:attribute name="rec_desc" type="Rec_typ" fixed="15"/>
</xsd:complexType>

```

13.4.50 Attribute Value Definition

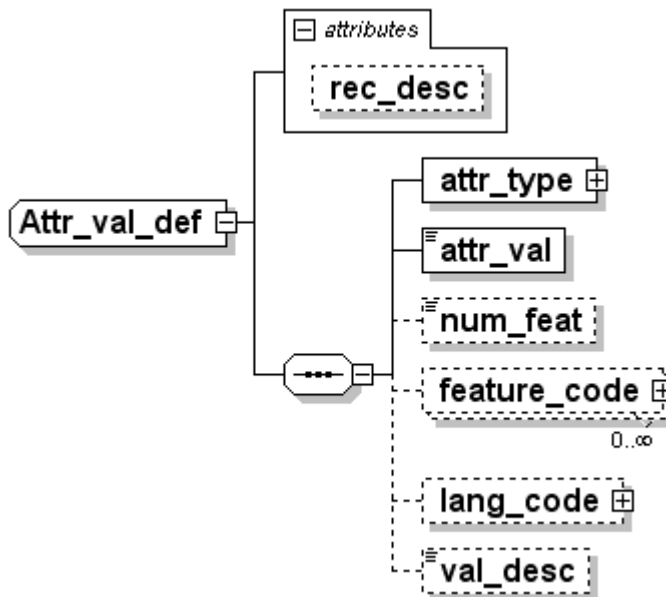

```

<xsd:complexType name="Attr_val_def">
  <xsd:sequence>
    <xsd:element name="attr_type" type="Attr_type_code"/>
    <xsd:element name="attr_val" type="Attr_val_string"/>
    <xsd:element name="num_feat" type="Field_counter_5dig" minOccurs="0"/>
    <xsd:element name="feature_code" type="Feat_code" minOccurs="0" maxOccurs="unbounded"/>
    <xsd:element name="lang_code" type="Lan_cod" minOccurs="0"/>
    <xsd:element name="val_desc" type="xsd:string" minOccurs="0"/>
  </xsd:sequence>
  <xsd:attribute name="rec_desc" type="Rec_typ" fixed="18"/>
</xsd:complexType>

```

13.4.51 Network Specification

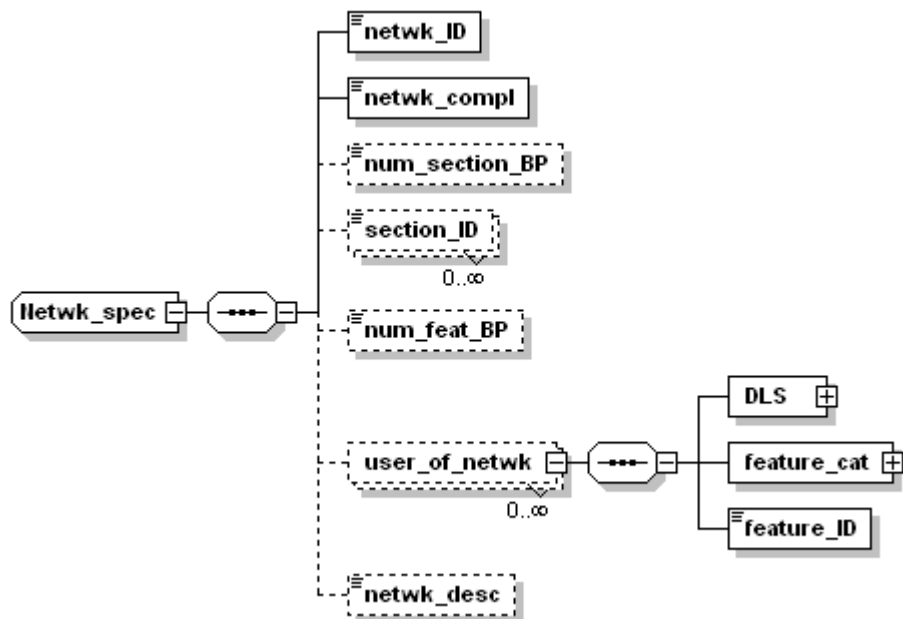

```

<xsd:complexType name="Netwk_spec">
  <xsd:sequence>
    <xsd:element name="netwk_ID" type="Five_digit_ID"/>
    <xsd:element name="netwk_compl" type="One_digit_int"/>
    <xsd:element name="num_section_BP" type="Five_digit_int" minOccurs="0"/>
    <xsd:element name="section_ID" type="Sect_ID" minOccurs="0" maxOccurs="unbounded"/>
    <xsd:element name="num_feat_BP" type="Ten_digit_int" minOccurs="0"/>
    <xsd:element name="user_of_netwk" minOccurs="0" maxOccurs="unbounded">
      <xsd:complexType>
        <xsd:sequence>
          <xsd:element name="DLS" type="DLS_ID"/>
          <xsd:element name="feature_cat" type="Feat_cat"/>
          <xsd:element name="feature_ID" type="Feature_ID"/>
        </xsd:sequence>
      </xsd:complexType>
    </xsd:element>
    <xsd:element name="netwk_desc" type="xsd:string" minOccurs="0"/>
  </xsd:sequence>
  <xsd:attribute name="rec_desc" type="Rec_typ" fixed="19"/>
</xsd:complexType>
  
```

13.4.52 Datum & Ellipsoid

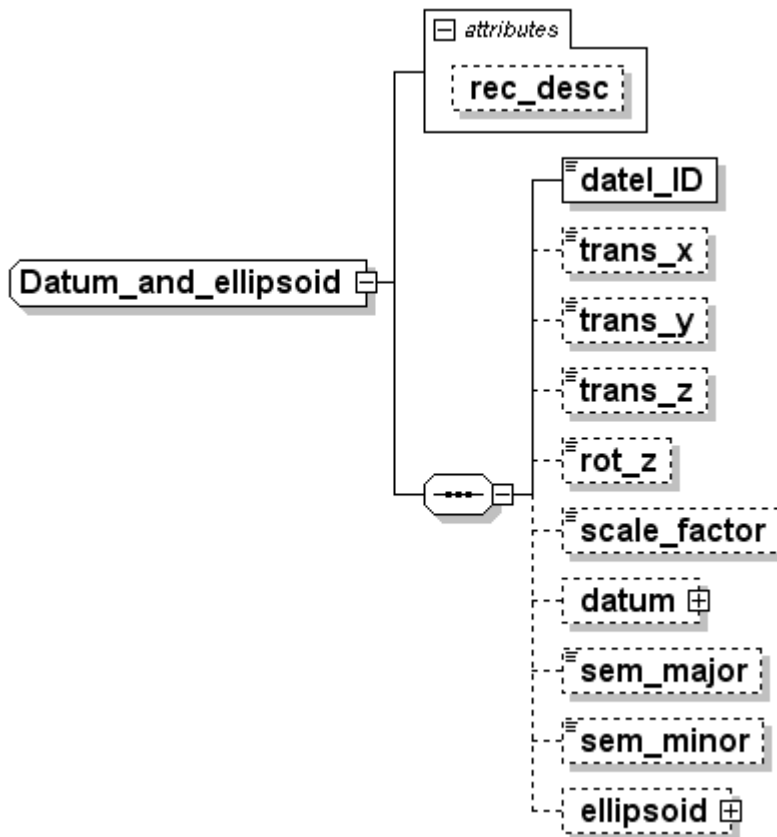

```

<xsd:complexType name="Datum_and_ellipsoid">
  <xsd:sequence>
    <xsd:element name="datel_ID" type="Datel_ID"/>
    <xsd:element name="trans_x" type="Four_digit_signed_int" minOccurs="0"/>
    <xsd:element name="trans_y" type="Four_digit_signed_int" minOccurs="0"/>
    <xsd:element name="trans_z" type="Four_digit_signed_int" minOccurs="0"/>
    <xsd:element name="rot_z" minOccurs="0">
      <xsd:simpleType>
        <xsd:restriction base="xsd:integer">
          <xsd:minInclusive value="0"/>
          <xsd:maxInclusive value="+40000000"/>
          <xsd:totalDigits value="9"/>
        </xsd:restriction>
      </xsd:simpleType>
    </xsd:element>
    <xsd:element name="scale_factor" type="Four_digit_signed_int" minOccurs="0"/>
    <xsd:element name="datum" type="Datum" minOccurs="0"/>
    <xsd:element name="sem_major" type="Eight_digit_int" minOccurs="0"/>
    <xsd:element name="sem_minor" type="Eight_digit_int" minOccurs="0"/>
    <xsd:element name="ellipsoid" type="Ellips_code" minOccurs="0"/>
  </xsd:sequence>
  <xsd:attribute name="rec_desc" type="Rec_typ" fixed="61"/>
</xsd:complexType>
  
```

13.4.53 Vertical Datum

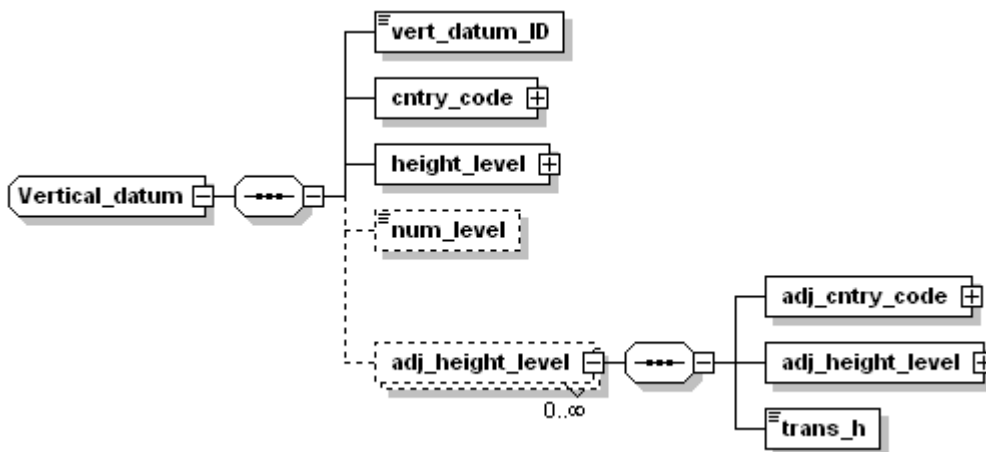

```

<xsd:complexType name="Vertical_datum">
  <xsd:sequence>
    <xsd:element name="vert_datum_ID" type="Vert_datum_ID"/>
    <xsd:element name="centry_code" type="Centry_cod"/>
    <xsd:element name="height_level" type="Vert_datum"/>
    <xsd:element name="num_level" type="Two_digit_ID" minOccurs="0"/>
    <xsd:element name="adj_height_level" minOccurs="0" maxOccurs="unbounded">
      <xsd:complexType>
        <xsd:sequence>
          <xsd:element name="adj_centry_code" type="Centry_cod"/>
          <xsd:element name="adj_height_level" type="Vert_datum"/>
          <xsd:element name="trans_h" type="Four_digit_signed_int"/>
        </xsd:sequence>
      </xsd:complexType>
    </xsd:element>
  </xsd:sequence>
  <xsd:attribute name="rec_desc" type="Rec_typ" fixed="62"/>
</xsd:complexType>

```

13.4.54 Projection

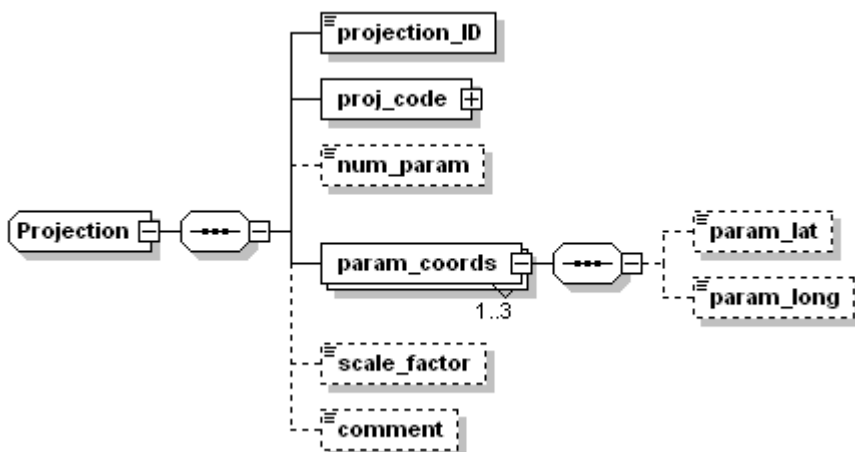

```

<xsd:complexType name="Projection">
  <xsd:sequence>
    <xsd:element name="projection_ID" type="Projection_ID"/>
    <xsd:element name="proj_code" type="Proj_code"/>
    <xsd:element name="num_param" minOccurs="0">
      <xsd:simpleType>
        <xsd:restriction base="xsd:integer">
          <xsd:minInclusive value="1"/>
          <xsd:maxInclusive value="3"/>
          <xsd:totalDigits value="2"/>
        </xsd:restriction>
      </xsd:simpleType>
    </xsd:element>
    <xsd:element name="param_coords" minOccurs="0" maxOccurs="3">
      <xsd:sequence>
        <xsd:element name="param_lat" type="Two_digit_ID" minOccurs="0"/>
        <xsd:element name="param_long" type="Two_digit_ID" minOccurs="0"/>
      </xsd:sequence>
    </xsd:element>
    <xsd:element name="scale_factor" type="Two_digit_ID" minOccurs="0"/>
    <xsd:element name="comment" type="Text" minOccurs="0"/>
  </xsd:sequence>

```



```

</xsd:element>
<xsd:element name="param_coords" maxOccurs="3">
  <xsd:complexType>
    <xsd:sequence>
      <xsd:element name="param_lat" type="Ten_digit_lat" minOccurs="0"/>
      <xsd:element name="param_long" type="Ten_digit_long" minOccurs="0"/>
    </xsd:sequence>
  </xsd:complexType>
</xsd:element>
<xsd:element name="scale_factor" type="Four_digit_signed_int" default="0" minOccurs="0"/>
<xsd:element name="comment" type="xsd:string" minOccurs="0"/>
</xsd:sequence>
<xsd:attribute name="rec_desc" type="Rec_typ" fixed="63"/>
</xsd:complexType>

```

13.4.55 National Grid

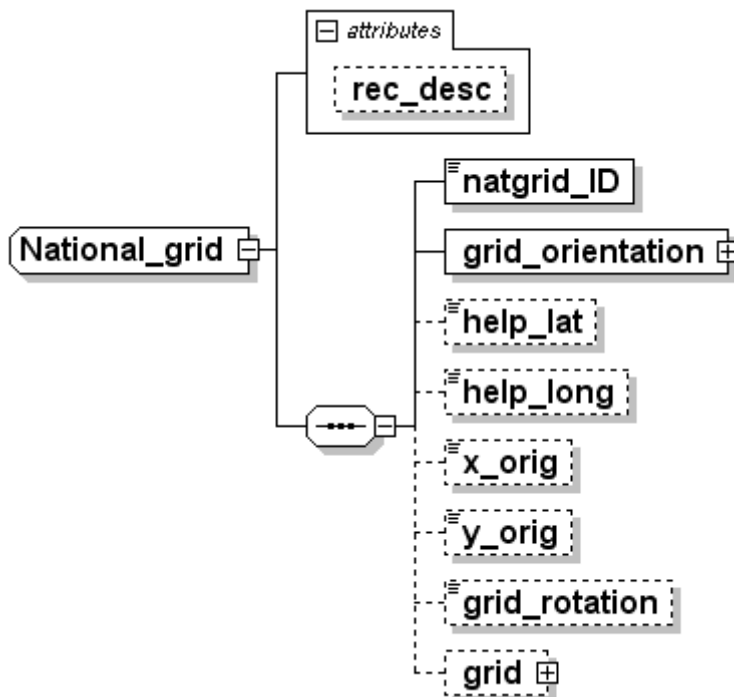

```

<xsd:complexType name="National_grid">
  <xsd:sequence>
    <xsd:element name="natgrid_ID" type="Natgrid_ID"/>
    <xsd:element name="grid_orientation" type="Grid_ort"/>
    <xsd:element name="help_lat" type="Ten_digit_lat" minOccurs="0"/>
    <xsd:element name="help_long" type="Ten_digit_long" minOccurs="0"/>
    <xsd:element name="x_orig" type="Nine_digit_signed_int" minOccurs="0"/>
    <xsd:element name="y_orig" type="Nine_digit_signed_int" minOccurs="0"/>
    <xsd:element name="grid_rotation" minOccurs="0">
      <xsd:simpleType>
        <xsd:restriction base="xsd:integer">
          <xsd:minInclusive value="0"/>
          <xsd:maxInclusive value="+400000000"/>
          <xsd:totalDigits value="10"/>
        </xsd:restriction>
      </xsd:simpleType>
    </xsd:element>
    <xsd:element name="grid" type="Grid" minOccurs="0"/>
  </xsd:sequence>
  <xsd:attribute name="rec_desc" type="Rec_typ" fixed="64"/>
</xsd:complexType>

```

13.4.56 Geoid Undulation

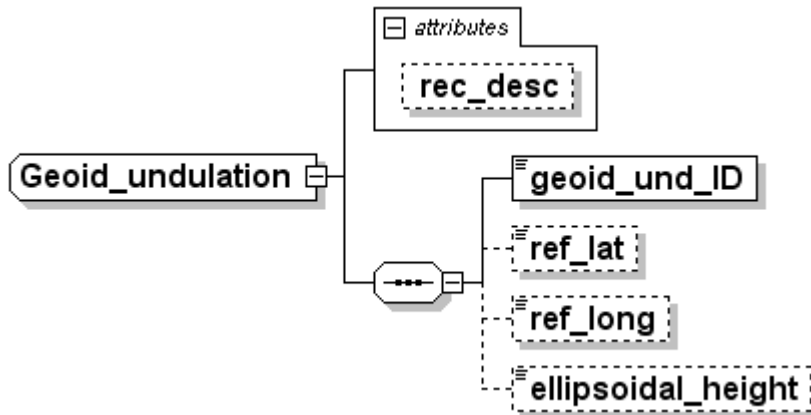

```
<xsd:complexType name="Geoid_undulation">
  <xsd:sequence>
    <xsd:element name="geoid_und_ID" type="Geoid_und_ID"/>
    <xsd:element name="ref_lat" type="Ten_digit_lat" minOccurs="0"/>
    <xsd:element name="ref_long" type="Ten_digit_long" minOccurs="0"/>
    <xsd:element name="ellipsoidal_height" type="Four_digit_signed_int" minOccurs="0"/>
  </xsd:sequence>
  <xsd:attribute name="rec_desc" type="Rec_typ" fixed="65"/>
</xsd:complexType>
```

13.4.57 Earth Magnetic Field

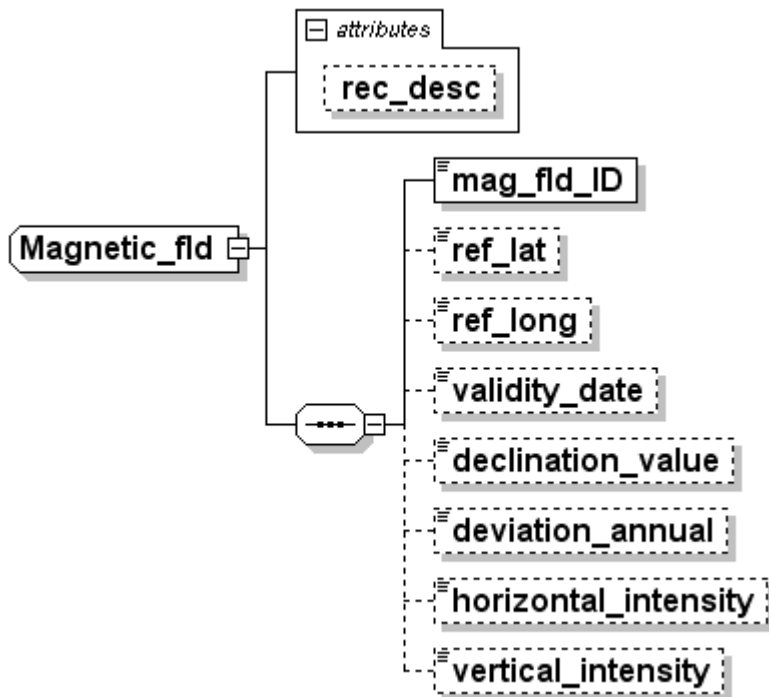

```
<xsd:complexType name="Magnetic_fld">
  <xsd:sequence>
    <xsd:element name="mag_fld_ID" type="Mag_fld_ID"/>
    <xsd:element name="ref_lat" type="Ten_digit_lat" minOccurs="0"/>
    <xsd:element name="ref_long" type="Ten_digit_long" minOccurs="0"/>
    <xsd:element name="validity_date" minOccurs="0">
      <xsd:simpleType>
        <xsd:restriction base="xsd:integer">
          <xsd:totalDigits value="8"/>
          <xsd:minInclusive value="10000101"/>
          <xsd:maxInclusive value="99991231"/>
        </xsd:restriction>
      </xsd:simpleType>
    </xsd:element>
    <xsd:element name="declination_value" type="Integer"/>
    <xsd:element name="deviation_annual" type="Integer"/>
    <xsd:element name="horizontal_intensity" type="Integer"/>
    <xsd:element name="vertical_intensity" type="Integer"/>
  </xsd:sequence>
  <xsd:attribute name="rec_desc" type="Rec_typ" fixed="65"/>
</xsd:complexType>
```

```

</xsd:element>
<xsd:element name="declination_value" type="Declination" minOccurs="0"/>
<xsd:element name="deviation_annual" type="Declination" minOccurs="0"/>
<xsd:element name="horizontal_intensity" type="Five_digit_int" minOccurs="0"/>
<xsd:element name="vertical_intensity" type="Five_digit_int" minOccurs="0"/>
</xsd:sequence>
<xsd:attribute name="rec_desc" type="Rec_typ" fixed="66"/>
</xsd:complexType>

```

13.4.58 Layer Header

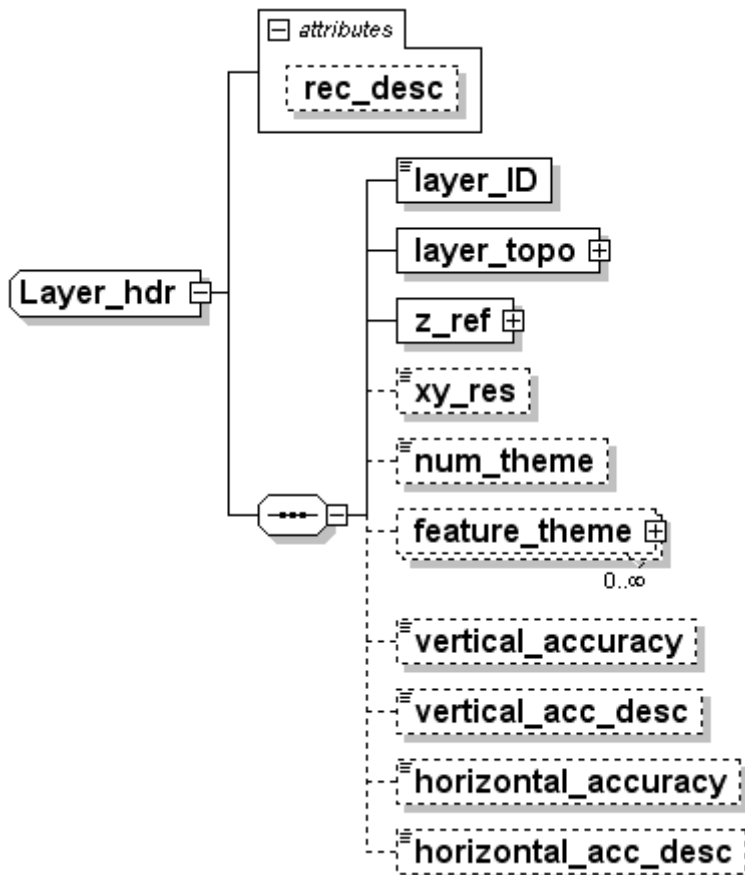

```

<xsd:complexType name="Layer_hdr">
  <xsd:sequence>
    <xsd:element name="layer_ID" type="Layer_ID"/>
    <xsd:element name="layer_topo" type="Layer_topo"/>
    <xsd:element name="z_ref" type="Z_ref"/>
    <xsd:element name="xy_res" type="Three_digit_int" minOccurs="0"/>
    <xsd:element name="num_theme" type="Field_counter_2dig" minOccurs="0"/>
    <xsd:element name="feature_theme" type="Feat_theme" minOccurs="0" maxOccurs="unbounded"/>
    <xsd:element name="vertical_accuracy" type="Five_digit_int" minOccurs="0"/>
    <xsd:element name="vertical_acc_desc" minOccurs="0">
      <xsd:simpleType>
        <xsd:restriction base="xsd:string">
          <xsd:maxLength value="40"/>
        </xsd:restriction>
      </xsd:simpleType>
    </xsd:element>
    <xsd:element name="horizontal_accuracy" type="Five_digit_int" minOccurs="0"/>
    <xsd:element name="horizontal_acc_desc" minOccurs="0">
      <xsd:simpleType>
        <xsd:restriction base="xsd:string">
          <xsd:maxLength value="40"/>
        </xsd:restriction>
      </xsd:simpleType>
    </xsd:element>
  </xsd:sequence>
  <xsd:attribute name="rec_desc" type="Rec_typ" fixed="17"/>
</xsd:complexType>

```

13.4.59 Section Identity

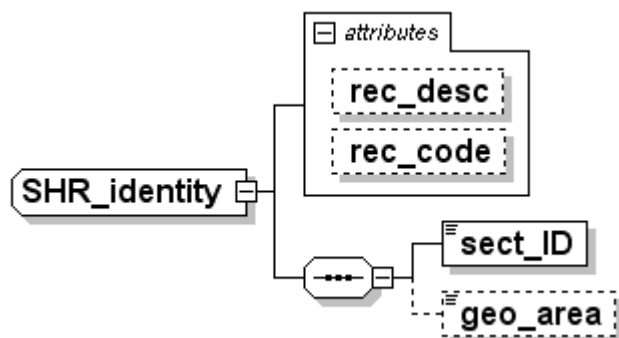

```
<xsd:complexType name="SHR_identity">
  <xsd:sequence>
    <xsd:element name="sect_ID" type="Sect_ID"/>
    <xsd:element name="geo_area" type="xsd:string" minOccurs="0"/>
  </xsd:sequence>
  <xsd:attribute name="rec_desc" type="Rec_typ" fixed="16"/>
  <xsd:attribute name="rec_code" type="Rec_subtyp" fixed="1"/>
</xsd:complexType>
```

13.4.60 Section Settings

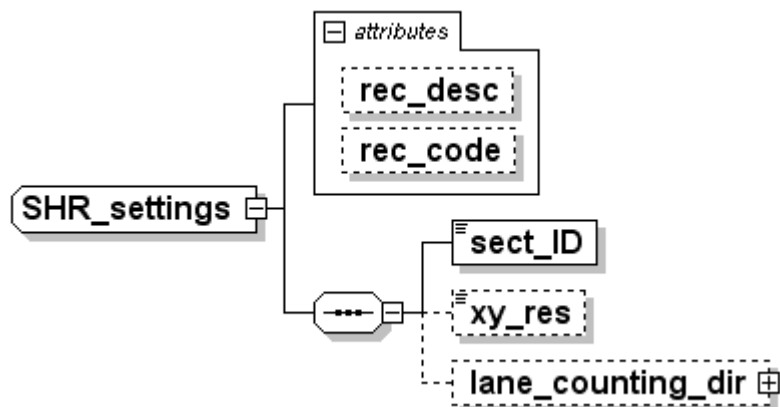

```
<xsd:complexType name="SHR_settings">
  <xsd:sequence>
    <xsd:element name="sect_ID" type="Sect_ID"/>
    <xsd:element name="xy_res" type="Three_digit_int" minOccurs="0"/>
    <xsd:element name="lane_counting_dir" type="Direction" minOccurs="0"/>
  </xsd:sequence>
  <xsd:attribute name="rec_desc" type="Rec_typ" fixed="16"/>
  <xsd:attribute name="rec_code" type="Rec_subtyp" fixed="2"/>
</xsd:complexType>
```

13.4.61 Network Identification

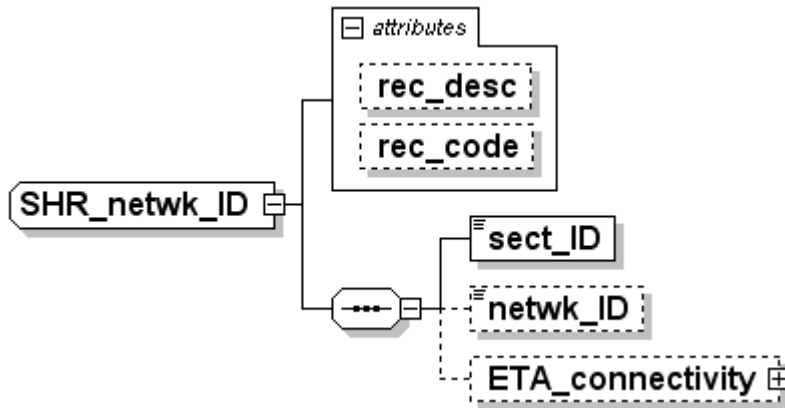

```
<xsd:complexType name="SHR_netwk_ID">
  <xsd:sequence>
    <xsd:element name="sect_ID" type="Sect_ID"/>
    <xsd:element name="netwk_ID" type="Netwk_ID" minOccurs="0"/>
    <xsd:element name="ETA_connectivity" type="ETA_conn" minOccurs="0"/>
  </xsd:sequence>
  <xsd:attribute name="rec_desc" type="Rec_typ" fixed="16"/>
  <xsd:attribute name="rec_code" type="Rec_subtyp" fixed="3"/>
</xsd:complexType>
```

13.4.62 Datasource Reference

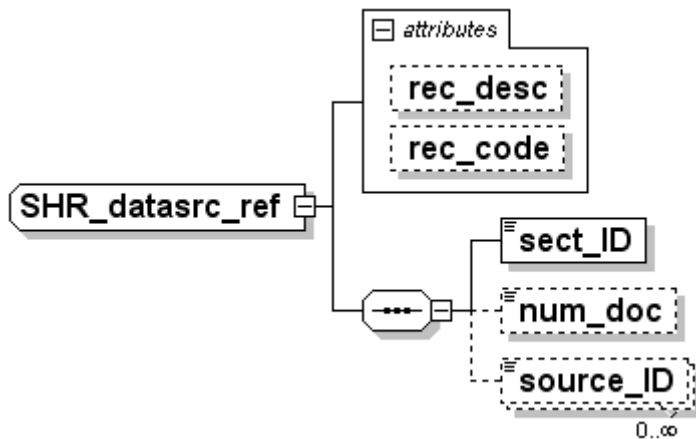

```
<xsd:complexType name="SHR_datasrc_ref">
  <xsd:sequence>
    <xsd:element name="sect_ID" type="Sect_ID"/>
    <xsd:element name="num_doc" type="Field_counter_2dig" minOccurs="0"/>
    <xsd:element name="source_ID" type="Src_desc_ID" minOccurs="0" maxOccurs="unbounded"/>
  </xsd:sequence>
  <xsd:attribute name="rec_desc" type="Rec_typ" fixed="16"/>
  <xsd:attribute name="rec_code" type="Rec_subtyp" fixed="4"/>
</xsd:complexType>
```

13.4.63 Datum & Magnetism

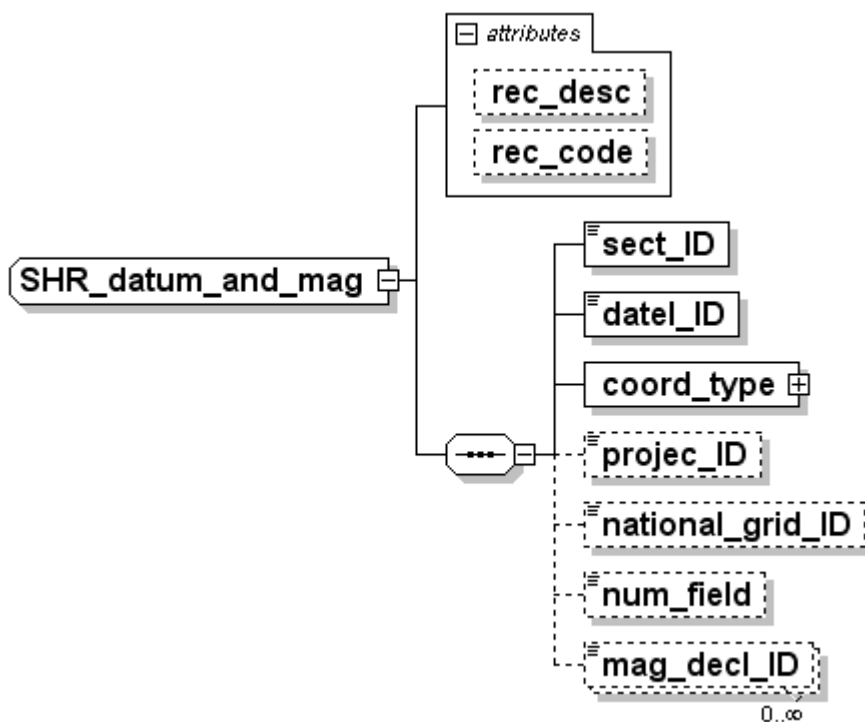

```

<xsd:complexType name="SHR_datum_and_mag">
  <xsd:sequence>
    <xsd:element name="sect_ID" type="Sect_ID"/>
    <xsd:element name="date1_ID" type="Date1_ID"/>
    <xsd:element name="coord_type" type="Coord_type"/>
    <xsd:element name="projec_ID" type="Projection_ID" minOccurs="0"/>
    <xsd:element name="national_grid_ID" type="Natgrid_ID" minOccurs="0"/>
    <xsd:element name="num_field" type="Field_counter_2dig" minOccurs="0"/>
    <xsd:element name="mag_decl_ID" type="Mag_flg_ID" minOccurs="0" maxOccurs="unbounded"/>
  </xsd:sequence>
  <xsd:attribute name="rec_desc" type="Rec_typ" fixed="16"/>
  <xsd:attribute name="rec_code" type="Rec_subtyp" fixed="5"/>
</xsd:complexType>
  
```

13.4.64 Orthometric Reference

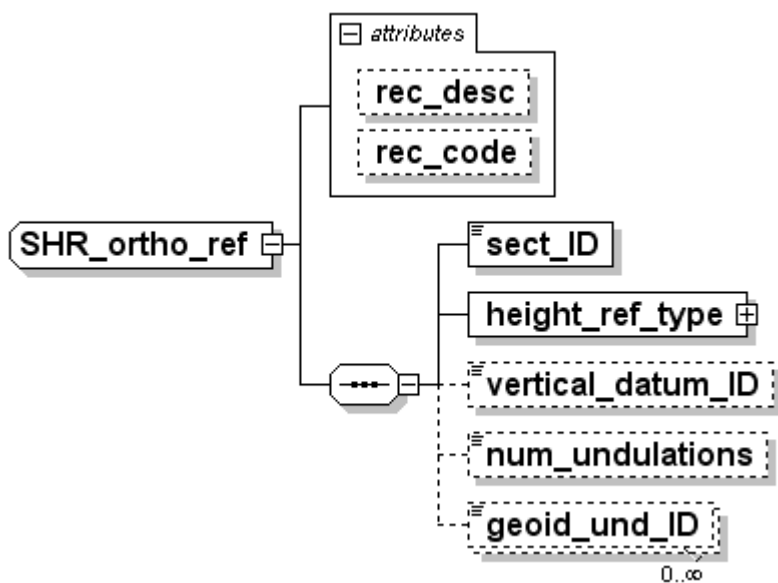

```

<xsd:complexType name="SHR_ortho_ref">
  <xsd:sequence>
  
```

```

<xsd:element name="sect_ID" type="Sect_ID"/>
<xsd:element name="height_ref_type" type="Height_ref_type"/>
<xsd:element name="vertical_datum_ID" type="Rec_ID" minOccurs="0"/>
<xsd:element name="num_undulations" type="Field_counter_2dig" minOccurs="0"/>
<xsd:element name="geoid_und_ID" type="Rec_ID" minOccurs="0" maxOccurs="unbounded"/>
</xsd:sequence>
<xsd:attribute name="rec_desc" type="Rec_typ" fixed="16"/>
<xsd:attribute name="rec_code" type="Rec_subtyp" fixed="6"/>
</xsd:complexType>

```

13.4.65 Section Border

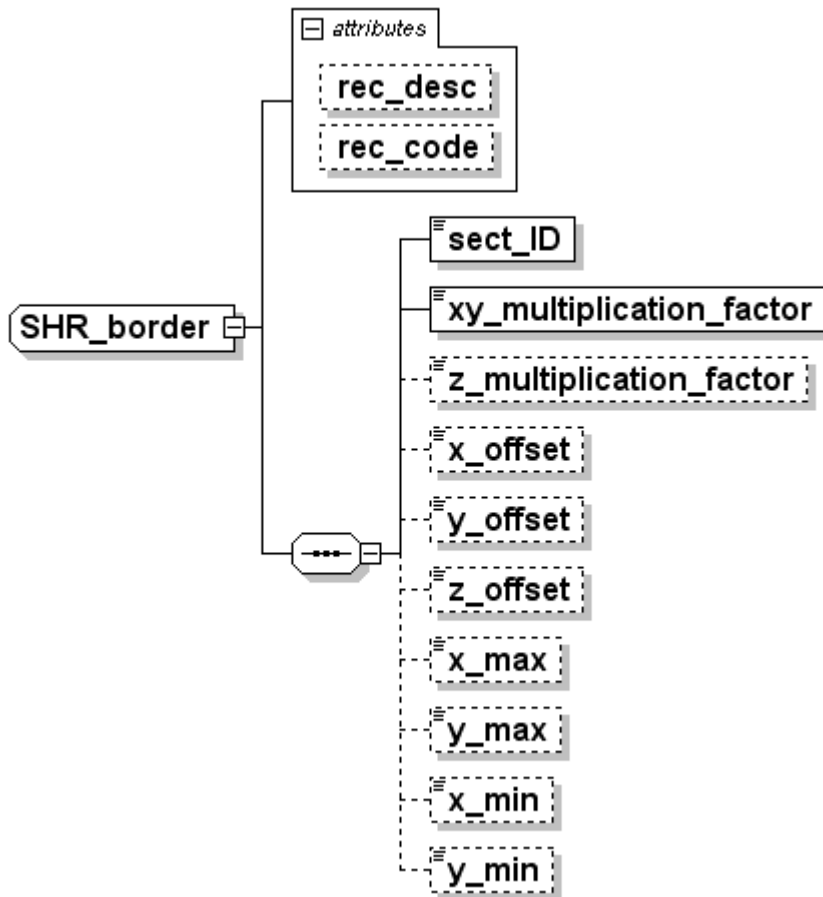

```

<xsd:complexType name="SHR_border">
  <xsd:sequence>
    <xsd:element name="sect_ID" type="Sect_ID"/>
    <xsd:element name="xy_multiplication_factor" type="Mult_factor"/>
    <xsd:element name="z_multiplication_factor" type="Mult_factor" minOccurs="0"/>
    <xsd:element name="x_offset" type="Eleven_digit_coord" minOccurs="0"/>
    <xsd:element name="y_offset" type="Eleven_digit_coord" minOccurs="0"/>
    <xsd:element name="z_offset" type="Eleven_digit_coord" minOccurs="0"/>
    <xsd:element name="x_max" type="Eleven_digit_coord" minOccurs="0"/>
    <xsd:element name="y_max" type="Eleven_digit_coord" minOccurs="0"/>
    <xsd:element name="x_min" type="Eleven_digit_coord" minOccurs="0"/>
    <xsd:element name="y_min" type="Eleven_digit_coord" minOccurs="0"/>
  </xsd:sequence>
  <xsd:attribute name="rec_desc" type="Rec_typ" fixed="16"/>
  <xsd:attribute name="rec_code" type="Rec_subtyp" fixed="7"/>
</xsd:complexType>

```

13.4.66 XY Control Point

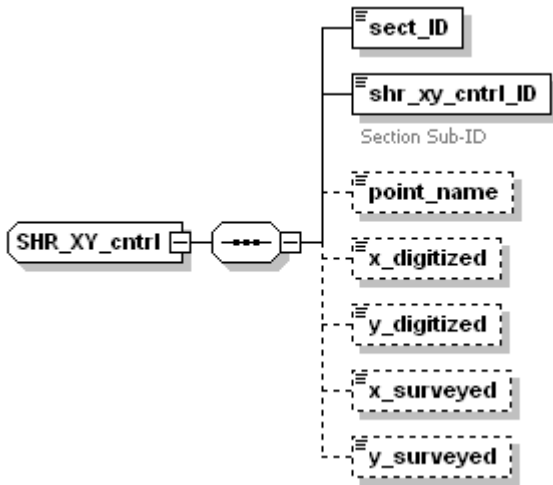

```

<xsd:complexType name="SHR_XY_cntrl">
  <xsd:sequence>
    <xsd:element name="sect_ID" type="Sect_ID"/>
    <xsd:element name="shr_xy_cntrl_ID" type="SHR_XY_cntrl_ID">
      <xsd:annotation>
        <xsd:documentation>Section Sub-ID</xsd:documentation>
      </xsd:annotation>
    </xsd:element>
    <xsd:element name="point_name" minOccurs="0">
      <xsd:simpleType>
        <xsd:restriction base="xsd:string">
          <xsd:maxLength value="20"/>
        </xsd:restriction>
      </xsd:simpleType>
    </xsd:element>
    <xsd:element name="x_digitized" type="Eleven_digit_coord" minOccurs="0"/>
    <xsd:element name="y_digitized" type="Eleven_digit_coord" minOccurs="0"/>
    <xsd:element name="x_surveyed" type="Eleven_digit_coord" minOccurs="0"/>
    <xsd:element name="y_surveyed" type="Eleven_digit_coord" minOccurs="0"/>
  </xsd:sequence>
  <xsd:attribute name="rec_desc" type="Rec_typ" fixed="16"/>
  <xsd:attribute name="rec_code" type="Rec_subtyp" fixed="8"/>
</xsd:complexType>

```

13.4.67 Z Control Point

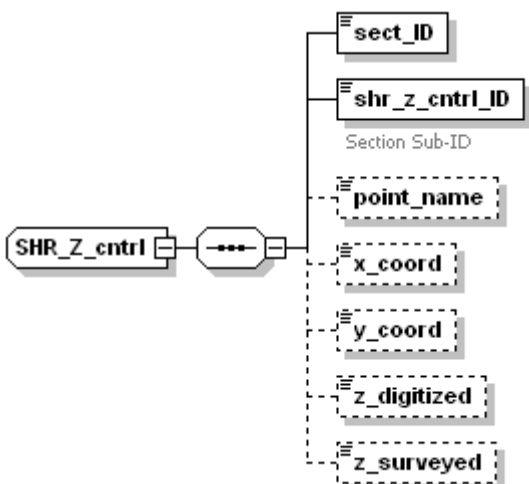

```

<xsd:complexType name="SHR_Z_cntrl">
  <xsd:sequence>
    <xsd:element name="sect_ID" type="Sect_ID"/>
    <xsd:element name="shr_z_cntrl_ID" type="SHR_Z_cntrl_ID">

```



```

        <xsd:annotation>
          <xsd:documentation>Section Sub-ID</xsd:documentation>
        </xsd:annotation>
      </xsd:element>
    <xsd:element name="point_name" minOccurs="0">
      <xsd:simpleType>
        <xsd:restriction base="xsd:string">
          <xsd:maxLength value="20"/>
        </xsd:restriction>
      </xsd:simpleType>
    </xsd:element>
    <xsd:element name="x_coord" type="Ten_digit_signed_int" minOccurs="0"/>
    <xsd:element name="y_coord" type="Ten_digit_signed_int" minOccurs="0"/>
    <xsd:element name="z_digitized" type="Ten_digit_signed_int" minOccurs="0"/>
    <xsd:element name="z_surveyed" type="Ten_digit_signed_int" minOccurs="0"/>
  </xsd:sequence>
  <xsd:attribute name="rec_desc" type="Rec_typ" fixed="16"/>
  <xsd:attribute name="rec_code" type="Rec_subtyp" fixed="9"/>
</xsd:complexType>

```

13.4.68 Update Information

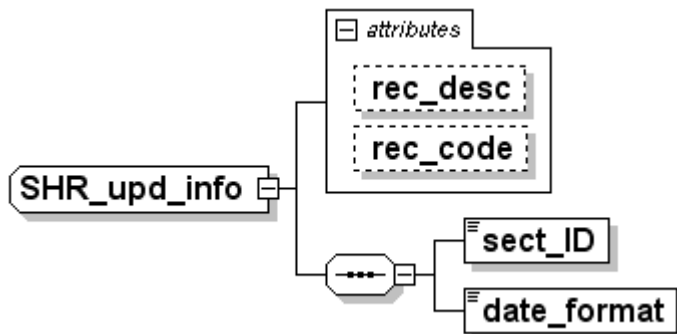

```

<xsd:complexType name="SHR_upd_info">
  <xsd:sequence>
    <xsd:element name="sect_ID" type="Sect_ID"/>
    <xsd:element name="date_format">
      <xsd:simpleType>
        <xsd:restriction base="xsd:string">
          <xsd:length value="20"/>
        </xsd:restriction>
      </xsd:simpleType>
    </xsd:element>
  </xsd:sequence>
  <xsd:attribute name="rec_desc" type="Rec_typ" fixed="16"/>
  <xsd:attribute name="rec_code" type="Rec_subtyp" fixed="10"/>
</xsd:complexType>

```

13.4.69 Geo Update Information

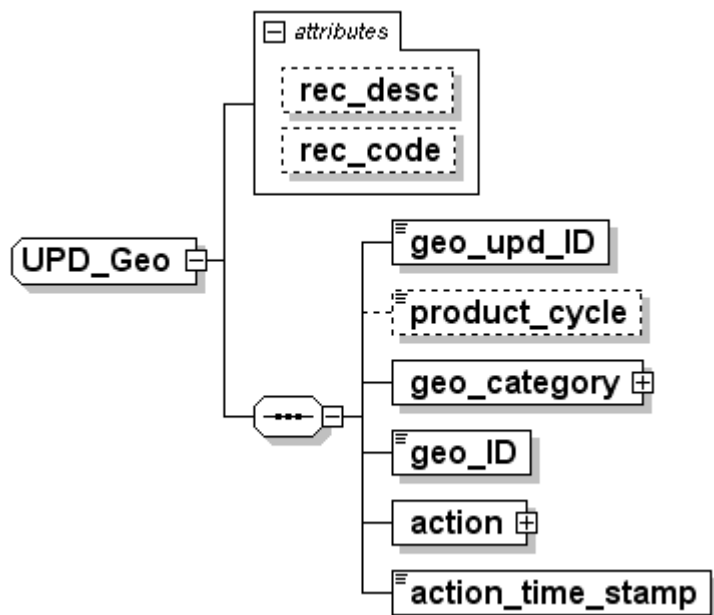

```

<xsd:complexType name="UPD_Geo">
  <xsd:sequence>
    <xsd:element name="geo_upd_ID" type="Geo_upd_ID"/>
    <xsd:element name="product_cycle" type="Two_digit_ID" minOccurs="0"/>
    <xsd:element name="geo_category" type="Geo_cat"/>
    <xsd:element name="geo_ID" type="Geo_ID"/>
    <xsd:element name="action" type="Action"/>
    <xsd:element name="action_time_stamp">
      <xsd:simpleType>
        <xsd:restriction base="xsd:string">
          <xsd:length value="20"/>
        </xsd:restriction>
      </xsd:simpleType>
    </xsd:element>
  </xsd:sequence>
  <xsd:attribute name="rec_desc" type="Rec_typ" fixed="89"/>
  <xsd:attribute name="rec_code" type="Rec_subtyp" fixed="1"/>
</xsd:complexType>

```

13.4.70 Object Update Information

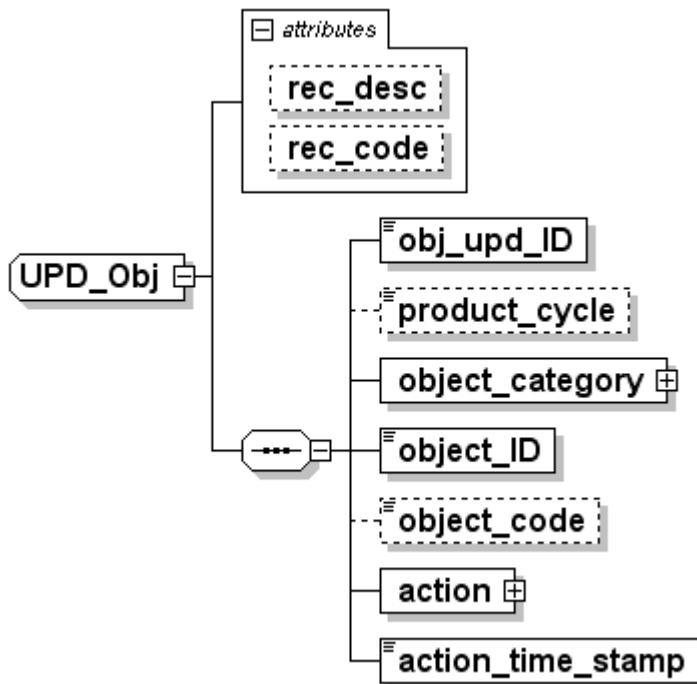

```

<xsd:complexType name="UPD_Obj">
  <xsd:sequence>
    <xsd:element name="obj_upd_ID" type="Obj_upd_ID"/>
    <xsd:element name="product_cycle" type="Two_digit_ID" minOccurs="0"/>
    <xsd:element name="object_category" type="Obj_cat"/>
    <xsd:element name="object_ID" type="Rec_ID"/>
    <xsd:element name="object_code" type="Obj_class_code" minOccurs="0"/>
    <xsd:element name="action" type="Action"/>
    <xsd:element name="action_time_stamp">
      <xsd:simpleType>
        <xsd:restriction base="xsd:string">
          <xsd:length value="20"/>
        </xsd:restriction>
      </xsd:simpleType>
    </xsd:element>
  </xsd:sequence>
  <xsd:attribute name="rec_desc" type="Rec_typ" fixed="89"/>
  <xsd:attribute name="rec_code" type="Rec_subtyp" fixed="2"/>
</xsd:complexType>

```

13.4.71 Object Attribute Update Information

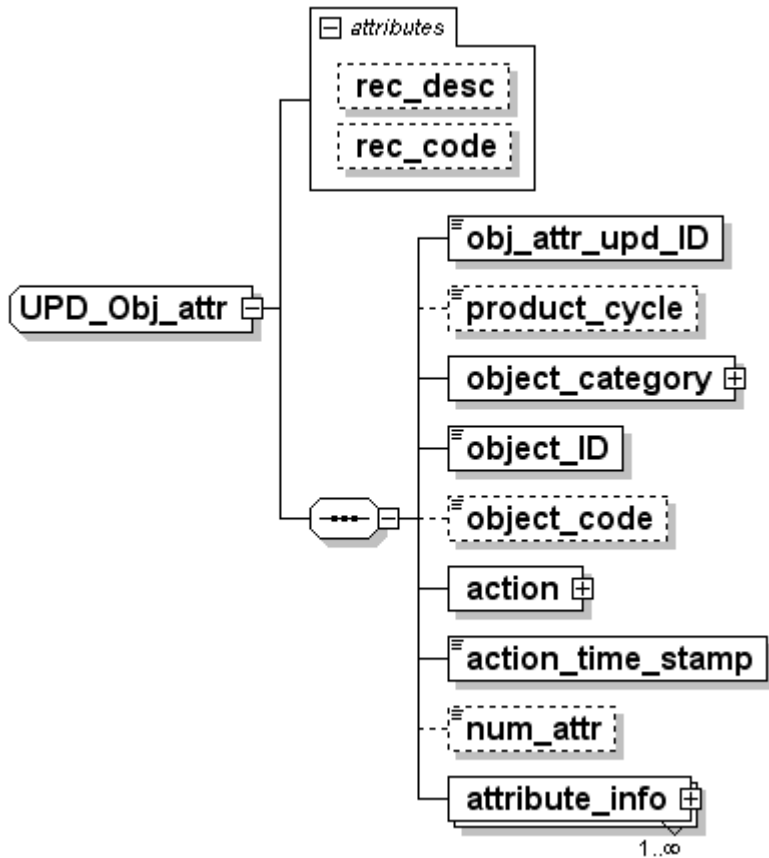

```

<xsd:complexType name="UPD_Obj_attr">
  <xsd:sequence>
    <xsd:element name="obj_attr_upd_ID" type="Obj_attr_upd_ID"/>
    <xsd:element name="product_cycle" type="Two_digit_ID" minOccurs="0"/>
    <xsd:element name="object_category" type="Obj_cat"/>
    <xsd:element name="object_ID" type="Rec_ID"/>
    <xsd:element name="object_code" type="Obj_class_code" minOccurs="0"/>
    <xsd:element name="action" type="Action"/>
    <xsd:element name="action_time_stamp">
      <xsd:simpleType>
        <xsd:restriction base="xsd:string">
          <xsd:length value="20"/>
        </xsd:restriction>
      </xsd:simpleType>
    </xsd:element>
    <xsd:element name="num_attr" type="Five_digit_int" minOccurs="0"/>
    <xsd:element name="attribute_info" maxOccurs="unbounded">
      <xsd:complexType>
        <xsd:sequence>
          <xsd:element ref="AttributeDescriptor"/>
        </xsd:sequence>
      </xsd:complexType>
    </xsd:element>
  </xsd:sequence>
  <xsd:attribute name="rec_desc" type="Rec_typ" fixed="89"/>
  <xsd:attribute name="rec_code" type="Rec_subtyp" fixed="3"/>
</xsd:complexType>
</xsd:schema>
  
```

13.5 Schema GDF_data_dict.xsd

13.5.1 Header

```

<xsd:schema xmlns="http://www.ukusa.org" xmlns:xlink="http://www.w3.org/1999/xlink"
  xmlns:gdf="http://www.ukusa.org" xmlns:xsd="http://www.w3.org/2001/XMLSchema"
  targetNamespace="http://www.ukusa.org" elementFormDefault="qualified">
  
```

13.5.2 Datum

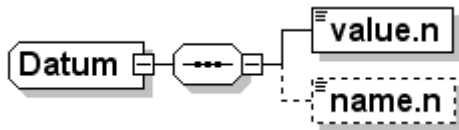

```
<xsd:complexType name="Datum">
  <xsd:sequence>
    <xsd:element name="value.n" type="Datum_value"/>
    <xsd:element name="name.n" type="Datum_name" minOccurs="0"/>
  </xsd:sequence>
</xsd:complexType>
```

13.5.3 3-D Coordinate

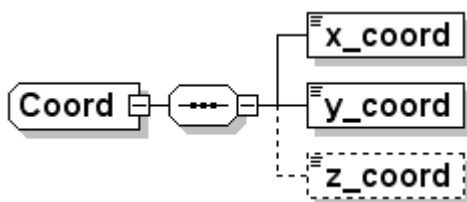

```
<xsd:complexType name="Coord">
  <xsd:sequence>
    <xsd:element name="x_coord" type="Eleven_digit_coord"/>
    <xsd:element name="y_coord" type="Eleven_digit_coord"/>
    <xsd:element name="z_coord" type="Eleven_digit_coord" minOccurs="0"/>
  </xsd:sequence>
</xsd:complexType>
```

13.5.4 2-D Coordinate

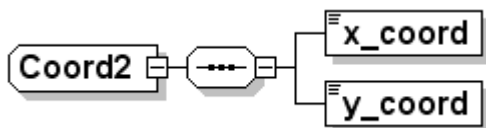

```
<xsd:complexType name="Coord2">
  <xsd:sequence>
    <xsd:element name="x_coord" type="Eleven_digit_coord"/>
    <xsd:element name="y_coord" type="Eleven_digit_coord"/>
  </xsd:sequence>
</xsd:complexType>
```

13.5.5 Time Coordinate

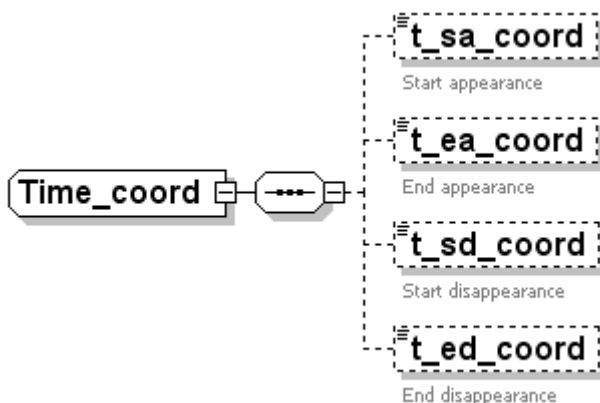

```
<xsd:complexType name="Time_coord">
  <xsd:sequence>
    <xsd:element name="t_sa_coord" type="Ten_digit_t_coord" minOccurs="0"/>
  </xsd:sequence>
</xsd:complexType>
```

```

        <xsd:annotation>
          <xsd:documentation>Start appearance</xsd:documentation>
        </xsd:annotation>
      </xsd:element>
      <xsd:element name="t_ea_coord" type="Ten_digit_t_coord" minOccurs="0">
        <xsd:annotation>
          <xsd:documentation>End appearance</xsd:documentation>
        </xsd:annotation>
      </xsd:element>
      <xsd:element name="t_sd_coord" type="Ten_digit_t_coord" minOccurs="0">
        <xsd:annotation>
          <xsd:documentation>Start disappearance</xsd:documentation>
        </xsd:annotation>
      </xsd:element>
      <xsd:element name="t_ed_coord" type="Ten_digit_t_coord" minOccurs="0">
        <xsd:annotation>
          <xsd:documentation>End disappearance</xsd:documentation>
        </xsd:annotation>
      </xsd:element>
    </xsd:sequence>
  </xsd:complexType>

```

13.5.6 Extended Geometry

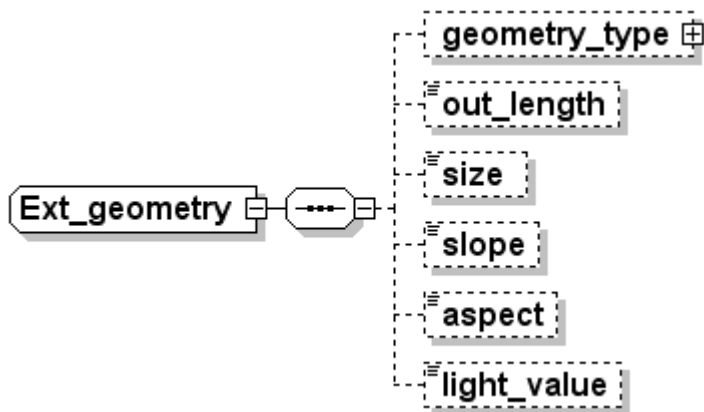

```

<xsd:complexType name="Ext_geometry">
  <xsd:sequence>
    <xsd:element name="geometry_type" type="Geometry_type" minOccurs="0"/>
    <xsd:element name="out_length" type="Ten_digit_int" minOccurs="0"/>
    <xsd:element name="size" type="Ten_digit_int" minOccurs="0"/>
    <xsd:element name="slope" type="Three_digit_int" minOccurs="0"/>
    <xsd:element name="aspect" minOccurs="0">
      <xsd:simpleType>
        <xsd:restriction base="Four_digit_int">
          <xsd:maxInclusive value="3599"/>
        </xsd:restriction>
      </xsd:simpleType>
    </xsd:element>
    <xsd:element name="light_value" minOccurs="0">
      <xsd:simpleType>
        <xsd:restriction base="Three_digit_int">
          <xsd:maxInclusive value="255"/>
        </xsd:restriction>
      </xsd:simpleType>
    </xsd:element>
  </xsd:sequence>
</xsd:complexType>

```

13.5.7 Geometry Type

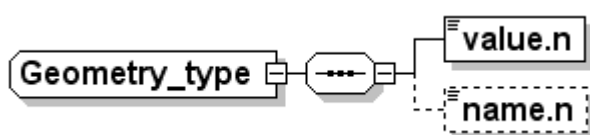

```

<xsd:complexType name="Geometry_type">
  <xsd:sequence>

```

```

    <xsd:element name="value.n" type="Geo_type_value"/>
    <xsd:element name="name.n" type="Geo_type_name" minOccurs="0"/>
  </xsd:sequence>
</xsd:complexType>

```

13.5.8 Geometry Type Value (Simple)

```

<xsd:simpleType name="Geo_type_value">
  <xsd:restriction base="xsd:integer">
    <xsd:enumeration value="0"/>
    <xsd:enumeration value="3"/>
    <xsd:enumeration value="4"/>
  </xsd:restriction>
</xsd:simpleType>

```

13.5.9 Geometry Type Name (Simple)

```

<xsd:simpleType name="Geo_type_name">
  <xsd:restriction base="xsd:string">
    <xsd:enumeration value="other"/>
    <xsd:enumeration value="Triangular"/>
    <xsd:enumeration value="Quadrangular"/>
  </xsd:restriction>
</xsd:simpleType>

```

13.5.10 Layer Section ID

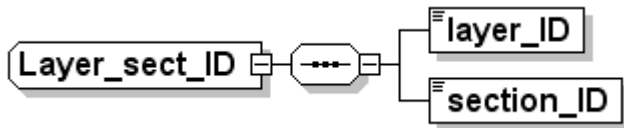

```

<xsd:complexType name="Layer_sect_ID">
  <xsd:sequence>
    <xsd:element name="layer_ID" type="Layer_ID"/>
    <xsd:element name="section_ID" type="Sect_ID"/>
  </xsd:sequence>
</xsd:complexType>

```

13.5.11 Dataset Layer Section ID

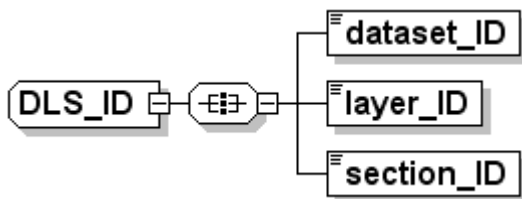

```

<xsd:complexType name="DLS_ID">
  <xsd:all>
    <xsd:element name="dataset_ID" type="Rec_ID"/>
    <xsd:element name="layer_ID" type="Layer_ID"/>
    <xsd:element name="section_ID" type="Rec_ID"/>
  </xsd:all>
</xsd:complexType>

```

13.5.12 Optional Dataset Layer Section ID

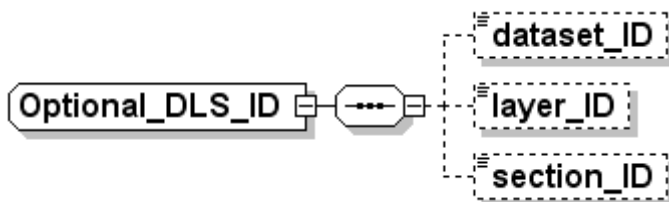

```

<xsd:complexType name="Optional_DLS_ID">
  <xsd:sequence>

```

```

<xsd:element name="dataset_ID" type="Ten_digit_int" minOccurs="0"/>
<xsd:element name="layer_ID" type="Ten_digit_int" minOccurs="0"/>
<xsd:element name="section_ID" type="Ten_digit_int" minOccurs="0"/>
</xsd:sequence>
</xsd:complexType>

```

13.5.13 Edge Status

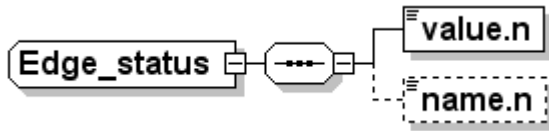

```

<xsd:complexType name="Edge_status">
  <xsd:sequence>
    <xsd:element name="value.n" type="Five_status_value"/>
    <xsd:element name="name.n" type="Edge_status_name" minOccurs="0"/>
  </xsd:sequence>
</xsd:complexType>

```

13.5.14 Node Status

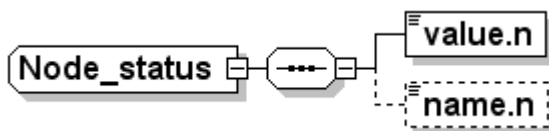

```

<xsd:complexType name="Node_status">
  <xsd:sequence>
    <xsd:element name="value.n" type="Five_status_value"/>
    <xsd:element name="name.n" type="Node_status_name" minOccurs="0"/>
  </xsd:sequence>
</xsd:complexType>

```

13.5.15 Attribute Data Type

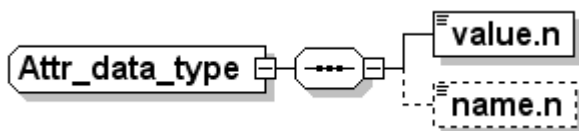

```

<xsd:complexType name="Attr_data_type">
  <xsd:sequence>
    <xsd:element name="value.n" type="Attr_data_type_value"/>
    <xsd:element name="name.n" type="Attr_data_type_name" minOccurs="0"/>
  </xsd:sequence>
</xsd:complexType>

```

13.5.16 Action

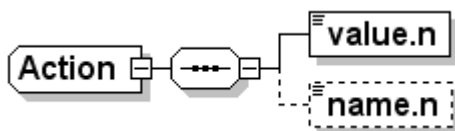

```

<xsd:complexType name="Action">
  <xsd:sequence>
    <xsd:element name="value.n" type="Action_value"/>
    <xsd:element name="name.n" type="Action_name" minOccurs="0"/>
  </xsd:sequence>
</xsd:complexType>

```

13.5.17 Attribute Type Code

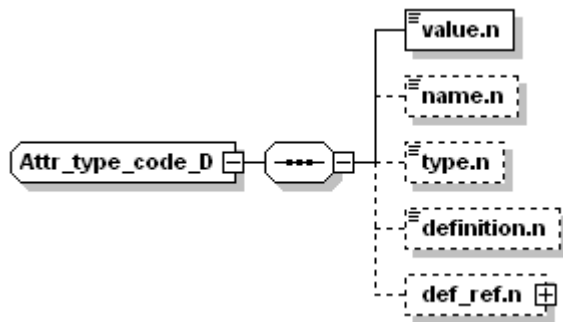

```
<xsd:complexType name="Attr_type_code_D">
  <xsd:sequence>
    <xsd:element name="value.n" type="Attr_type_code_val"/>
    <xsd:element name="name.n" type="Attr_type_code_name" minOccurs="0"/>
    <xsd:element name="type.n" type="Attr_type_code_type" minOccurs="0"/>
    <xsd:element name="definition.n" type="Attr_type_code_def" minOccurs="0"/>
    <xsd:element name="def_ref.n" type="Attr_typ_cod_def_ref" minOccurs="0"/>
  </xsd:sequence>
</xsd:complexType>
```

13.5.18 Coordinate Type

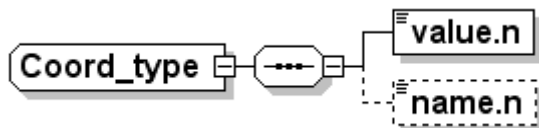

```
<xsd:complexType name="Coord_type">
  <xsd:sequence>
    <xsd:element name="value.n" type="xsd:boolean"/>
    <xsd:element name="name.n" type="Coord_type_name" minOccurs="0"/>
  </xsd:sequence>
</xsd:complexType>
```

13.5.19 Country Code

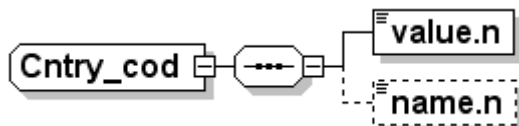

```
<xsd:complexType name="Cntry_cod">
  <xsd:sequence>
    <xsd:element name="value.n" type="Cntry_code_val"/>
    <xsd:element name="name.n" type="Cntry_code_name" minOccurs="0"/>
  </xsd:sequence>
</xsd:complexType>
```

13.5.20 Data Use

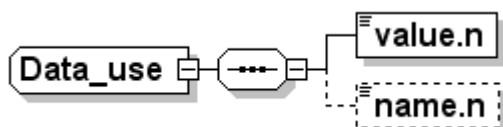

```
<xsd:complexType name="Data_use">
  <xsd:sequence>
    <xsd:element name="value.n" type="Data_use_value"/>
    <xsd:element name="name.n" type="Data_use_name" minOccurs="0"/>
  </xsd:sequence>
</xsd:complexType>
```

13.5.21 Attribute Data Unit

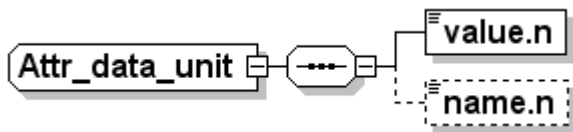

```
<xsd:complexType name="Attr_data_unit">
  <xsd:sequence>
    <xsd:element name="value.n" type="Attr_data_unit_code"/>
    <xsd:element name="name.n" type="Attr_data_unit_name" minOccurs="0"/>
  </xsd:sequence>
</xsd:complexType>
```

13.5.22 Direction

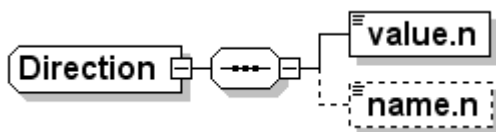

```
<xsd:complexType name="Direction">
  <xsd:sequence>
    <xsd:element name="value.n" type="xsd:boolean"/>
    <xsd:element name="name.n" type="Direction_name" minOccurs="0"/>
  </xsd:sequence>
</xsd:complexType>
```

13.5.23 Ellipsoid Code

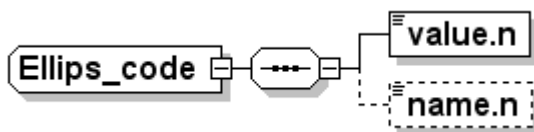

```
<xsd:complexType name="Ellips_code">
  <xsd:sequence>
    <xsd:element name="value.n" type="Ellipsoid_value"/>
    <xsd:element name="name.n" type="Ellipsoid_name" minOccurs="0"/>
  </xsd:sequence>
</xsd:complexType>
```

13.5.24 ETA Connectivity

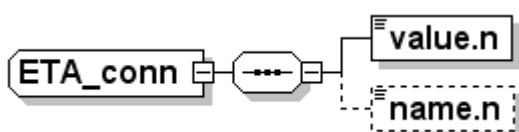

```
<xsd:complexType name="ETA_conn">
  <xsd:sequence>
    <xsd:element name="value.n" type="xsd:boolean"/>
    <xsd:element name="name.n" type="ETA_conn_name" minOccurs="0"/>
  </xsd:sequence>
</xsd:complexType>
```

13.5.25 Feature Category

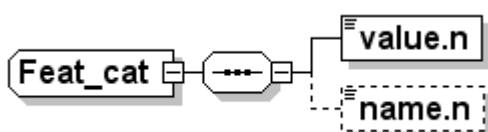

```
<xsd:complexType name="Feat_cat">
  <xsd:sequence>
    <xsd:element name="value.n" type="Feature_category_value"/>
  </xsd:sequence>
</xsd:complexType>
```

```
<xsd:element name="name.n" type="Feature_category_name" minOccurs="0" />
</xsd:sequence>
</xsd:complexType>
```

13.5.26 Feature Code

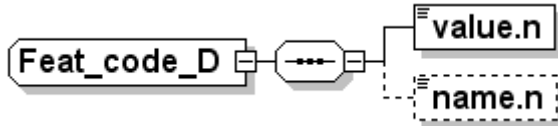

```
<xsd:complexType name="Feat_code_D">
  <xsd:sequence>
    <xsd:element name="value.n" type="Feature_code_value" />
    <xsd:element name="name.n" type="Feature_code_name" minOccurs="0" />
  </xsd:sequence>
</xsd:complexType>
```

13.5.27 Feature Theme

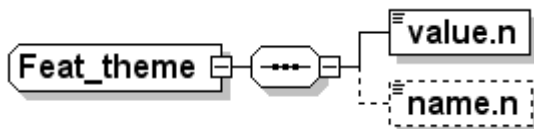

```
<xsd:complexType name="Feat_theme">
  <xsd:sequence>
    <xsd:element name="value.n" type="Feat_theme_val" />
    <xsd:element name="name.n" type="Feat_theme_nam" minOccurs="0" />
  </xsd:sequence>
</xsd:complexType>
```

13.5.28 Geometry Object Category

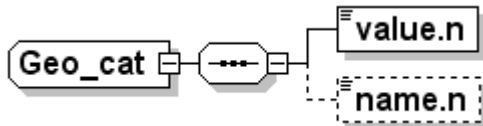

```
<xsd:complexType name="Geo_cat">
  <xsd:sequence>
    <xsd:element name="value.n" type="Geo_cat_value" />
    <xsd:element name="name.n" type="Geo_cat_name" minOccurs="0" />
  </xsd:sequence>
</xsd:complexType>
```

13.5.29 Grid

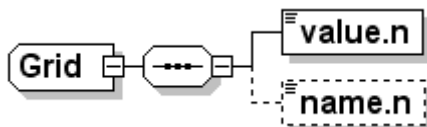

```
<xsd:complexType name="Grid">
  <xsd:sequence>
    <xsd:element name="value.n" type="Grid_value" />
    <xsd:element name="name.n" type="Grid_name" minOccurs="0" />
  </xsd:sequence>
</xsd:complexType>
```

13.5.30 Height Reference Type

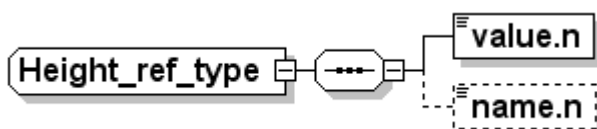

```
<xsd:complexType name="Height_ref_type">
  <xsd:sequence>
    <xsd:element name="value.n" type="Height_ref_type_value"/>
    <xsd:element name="name.n" type="Height_ref_type_name" minOccurs="0"/>
  </xsd:sequence>
</xsd:complexType>
```

13.5.31 Layer Topology

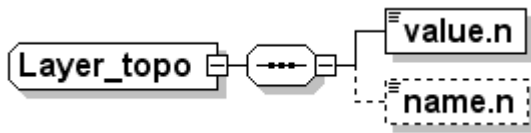

```
<xsd:complexType name="Layer_topo">
  <xsd:sequence>
    <xsd:element name="value.n" type="Layer_topo_value"/>
    <xsd:element name="name.n" type="Layer_topo_name" minOccurs="0"/>
  </xsd:sequence>
</xsd:complexType>
```

13.5.32 Language Code

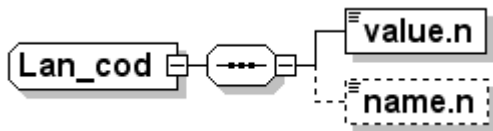

```
<xsd:complexType name="Lan_cod">
  <xsd:sequence>
    <xsd:element name="value.n" type="Lang_code_value"/>
    <xsd:element name="name.n" type="Lang_code_name" minOccurs="0"/>
  </xsd:sequence>
</xsd:complexType>
```

13.5.33 Object Category

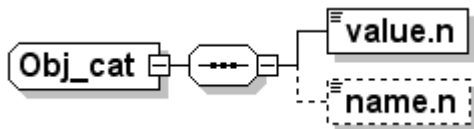

```
<xsd:complexType name="Obj_cat">
  <xsd:sequence>
    <xsd:element name="value.n" type="Obj_cat_val"/>
    <xsd:element name="name.n" type="Obj_cat_name" minOccurs="0"/>
  </xsd:sequence>
</xsd:complexType>
```

13.5.34 Orientation

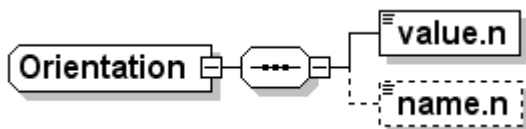

```
<xsd:complexType name="Orientation">
  <xsd:sequence>
    <xsd:element name="value.n" type="xsd:boolean"/>
    <xsd:element name="name.n" type="Orientation_name" minOccurs="0"/>
  </xsd:sequence>
</xsd:complexType>
```

13.5.35 Line Direction

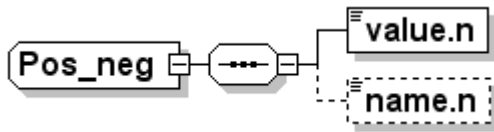

```
<xsd:complexType name="Pos_neg">
  <xsd:sequence>
    <xsd:element name="value.n" type="xsd:boolean"/>
    <xsd:element name="name.n" type="Pos_neg_name" minOccurs="0"/>
  </xsd:sequence>
</xsd:complexType>
```

13.5.36 Projection Code

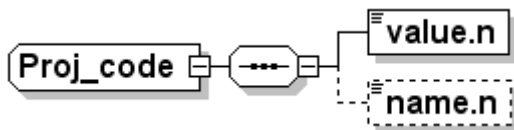

```
<xsd:complexType name="Proj_code">
  <xsd:sequence>
    <xsd:element name="value.n" type="Projection_value"/>
    <xsd:element name="name.n" type="Projection_name" minOccurs="0"/>
  </xsd:sequence>
</xsd:complexType>
```

13.5.37 Record Type

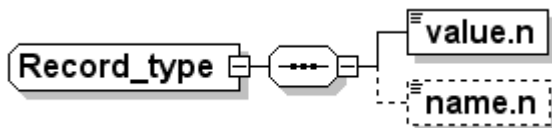

```
<xsd:complexType name="Record_type">
  <xsd:sequence>
    <xsd:element name="value.n" type="Record_type_value"/>
    <xsd:element name="name.n" type="Record_type_name" minOccurs="0"/>
  </xsd:sequence>
</xsd:complexType>
```

13.5.38 Record Type Code

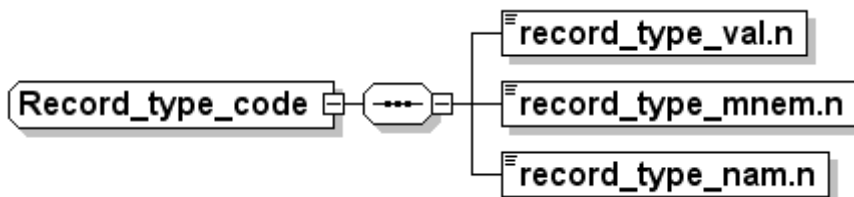

```
<xsd:complexType name="Record_type_code">
  <xsd:sequence>
    <xsd:element name="record_type_val.n" type="Record_type_value"/>
    <xsd:element name="record_type_mnem.n" type="Record_type_mnemonic"/>
    <xsd:element name="record_type_nam.n" type="Record_type_name"/>
  </xsd:sequence>
</xsd:complexType>
```

13.5.39 Record Subtype Code

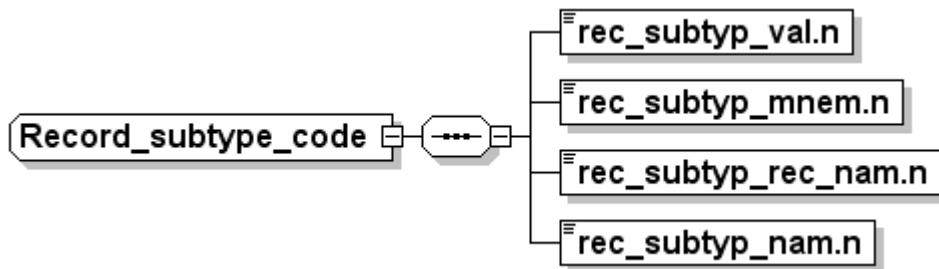

```
<xsd:complexType name="Record_subtype_code">
  <xsd:sequence>
    <xsd:element name="rec_subtyp_val.n" type="Record_subtype_value"/>
    <xsd:element name="rec_subtyp_mnem.n" type="Record_subtype_mnemonic"/>
    <xsd:element name="rec_subtyp_rec_nam.n" type="Record_subtype_rec_name"/>
    <xsd:element name="rec_subtyp_nam.n" type="Record_subtype_name"/>
  </xsd:sequence>
</xsd:complexType>
```

13.5.40 Three Split Indicator

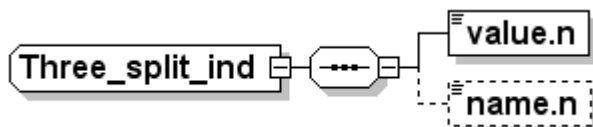

```
<xsd:complexType name="Three_split_ind">
  <xsd:sequence>
    <xsd:element name="value.n" type="Three_split_ind_value"/>
    <xsd:element name="name.n" type="Three_split_ind_name" minOccurs="0"/>
  </xsd:sequence>
</xsd:complexType>
```

13.5.41 Two Split Indicator

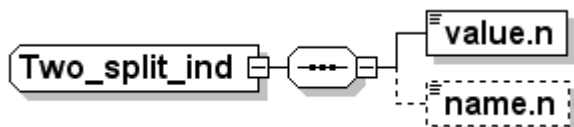

```
<xsd:complexType name="Two_split_ind">
  <xsd:sequence>
    <xsd:element name="value.n" type="xsd:boolean"/>
    <xsd:element name="name.n" type="Two_split_ind_name" minOccurs="0"/>
  </xsd:sequence>
</xsd:complexType>
```

13.5.42 Vertical Datum

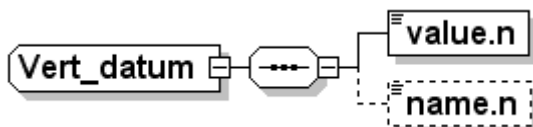

```
<xsd:complexType name="Vert_datum">
  <xsd:sequence>
    <xsd:element name="value.n" type="Vert_datum_value"/>
    <xsd:element name="name.n" type="Vert_datum_name" minOccurs="0"/>
  </xsd:sequence>
</xsd:complexType>
```

13.5.43 Z Reference

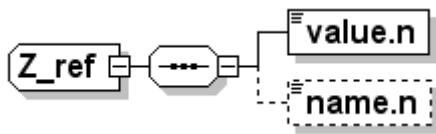

```
<xsd:complexType name="Z_ref">
  <xsd:sequence>
    <xsd:element name="value.n" type="Zref_value"/>
    <xsd:element name="name.n" type="Zref_name" minOccurs="0"/>
  </xsd:sequence>
</xsd:complexType>
```

13.5.44 Grid Orientation

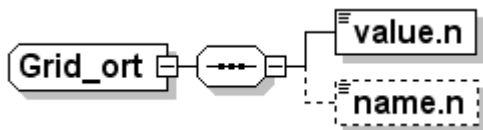

```
<xsd:complexType name="Grid_ort">
  <xsd:sequence>
    <xsd:element name="value.n" type="xsd:boolean"/>
    <xsd:element name="name.n" type="Grid_ort_name" minOccurs="0"/>
  </xsd:sequence>
</xsd:complexType>
```

13.5.45 Oriented Edge

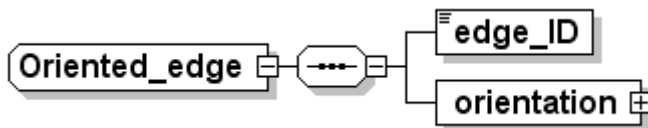

```
<xsd:complexType name="Oriented_edge">
  <xsd:sequence>
    <xsd:element name="edge_ID" type="Edge_ID"/>
    <xsd:element name="orientation" type="Orientation"/>
  </xsd:sequence>
</xsd:complexType>
```

13.5.46 Line Edge

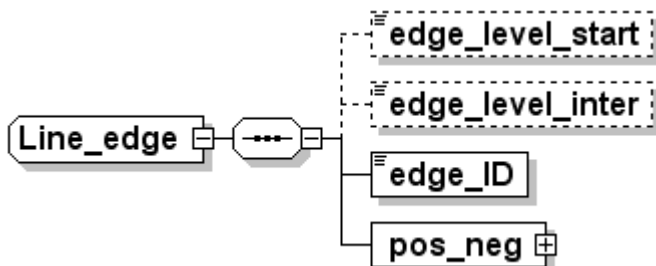

```
<xsd:complexType name="Line_edge">
  <xsd:sequence>
    <xsd:element name="edge_level_start" type="Edge_level" minOccurs="0"/>
    <xsd:element name="edge_level_inter" type="Edge_level" minOccurs="0"/>
    <xsd:element name="edge_ID" type="Edge_ID"/>
    <xsd:element name="pos_neg" type="Pos_neg"/>
  </xsd:sequence>
</xsd:complexType>
```

13.5.47 Area Edge

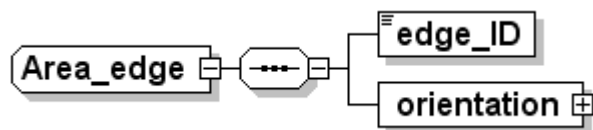

```
<xsd:complexType name="Area_edge">  
  <xsd:sequence>  
    <xsd:element name="edge_ID" type="Edge_ID"/>  
    <xsd:element name="orientation" type="Orientation"/>  
  </xsd:sequence>  
</xsd:complexType>
```

13.5.48 Feature Part

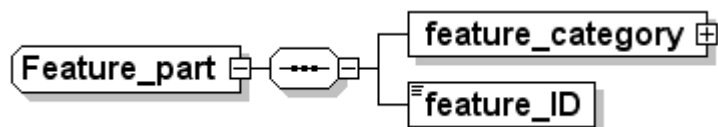

```
<xsd:complexType name="Feature_part">  
  <xsd:sequence>  
    <xsd:element name="feature_category" type="Feat_cat"/>  
    <xsd:element name="feature_ID" type="Feature_ID"/>  
  </xsd:sequence>  
</xsd:complexType>
```

13.5.49 Relationship Feature

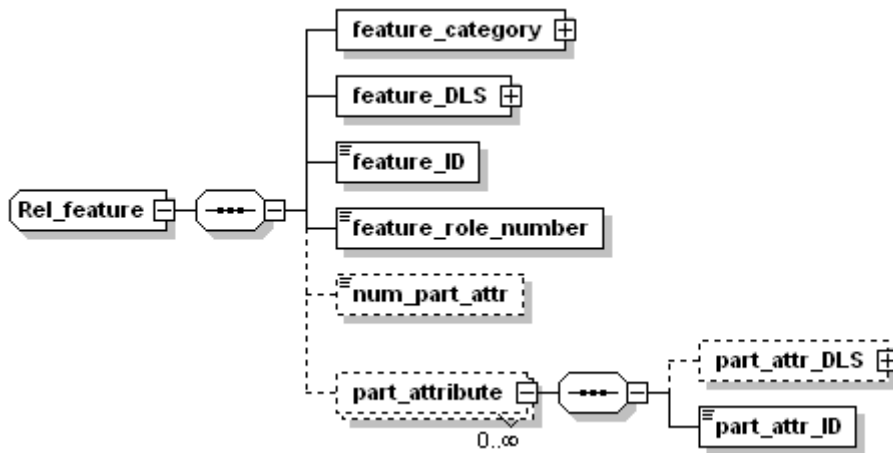

```

<xsd:complexType name="Rel_feature">
  <xsd:sequence>
    <xsd:element name="feature_category" type="Feat_cat"/>
    <xsd:element name="feature_DLS" type="DLS_ID"/>
    <xsd:element name="feature_ID" type="Feature_ID"/>
    <xsd:element name="feature_role_number" type="Two_digit_ID"/>
    <xsd:element name="num_part_attr" type="Five_digit_int" minOccurs="0"/>
    <xsd:element name="part_attribute" minOccurs="0" maxOccurs="unbounded">
      <xsd:complexType>
        <xsd:sequence>
          <xsd:element name="part_attr_DLS" type="Optional_DLS_ID" minOccurs="0"/>
          <xsd:element name="part_attr_ID" type="Attr_ID"/>
        </xsd:sequence>
      </xsd:complexType>
    </xsd:element>
  </xsd:sequence>
</xsd:complexType>

```

13.5.50 Name List

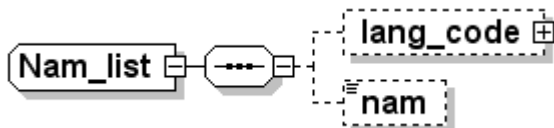

```

<xsd:complexType name="Nam_list">
  <xsd:sequence>
    <xsd:element name="lang_code" type="Lan_cod" minOccurs="0"/>
    <xsd:element name="nam" type="Name" minOccurs="0"/>
  </xsd:sequence>
</xsd:complexType>

```

13.5.51 Relationship kind

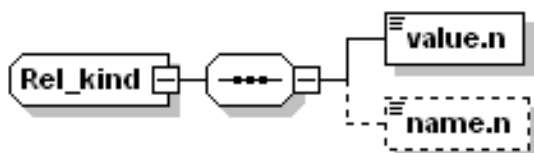

```

<xsd:complexType name="Rel_kind">
  <xsd:sequence>
    <xsd:element name="value.n" type="Rel_kind_value"/>
    <xsd:element name="name.n" type="Rel_kind_name" minOccurs="0"/>
  </xsd:sequence>
</xsd:complexType>

```

13.5.52 Relationship kind name

```
<xsd:simpleType name="Rel_kind_name">
  <xsd:restriction base="xsd:string">
    <xsd:enumeration value="Descended from"/>
    <xsd:enumeration value="Appendix to"/>
    <xsd:enumeration value="Published together with"/>
    <xsd:enumeration value="Additional map to"/>
    <xsd:enumeration value="Inset map to"/>
    <xsd:enumeration value="Is part of"/>
  </xsd:restriction>
</xsd:simpleType>
```

13.5.53 Relationship kind value

```
<xsd:simpleType name="Rel_kind_value">
  <xsd:restriction base="xsd:integer">
    <xsd:enumeration value="11"/>
    <xsd:enumeration value="12"/>
    <xsd:enumeration value="13"/>
    <xsd:enumeration value="14"/>
    <xsd:enumeration value="15"/>
    <xsd:enumeration value="16"/>
  </xsd:restriction>
</xsd:simpleType>
```

13.5.54 Relationship Code D

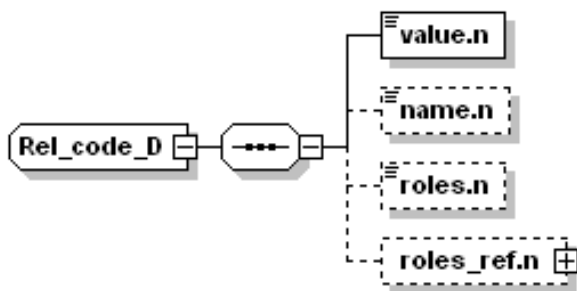

```
<xsd:complexType name="Rel_code_D">
  <xsd:sequence>
    <xsd:element name="value.n" type="Rel_code_value"/>
    <xsd:element name="name.n" type="Rel_code_name" minOccurs="0"/>
    <xsd:element name="roles.n" type="Rel_code_roles_def" minOccurs="0"/>
    <xsd:element name="roles_ref.n" type="Rel_code_roles_def_ref" minOccurs="0"/>
  </xsd:sequence>
</xsd:complexType>
```

13.5.55 Relationship Code Roles Definition (Simple)

```
<xsd:simpleType name="Rel_code_roles_def">
  <xsd:restriction base="xsd:string">
    <xsd:enumeration value="Rel_1001_ROLE"/>
    <xsd:enumeration value="Rel_1002_ROLE"/>
    <xsd:enumeration value="Rel_1003_ROLE"/>
    <xsd:enumeration value="Rel_1005_ROLE"/>
    <xsd:enumeration value="Rel_1006_ROLE"/>
    <xsd:enumeration value="Rel_1007_ROLE"/>
    <xsd:enumeration value="Rel_1008_ROLE"/>
    <xsd:enumeration value="Rel_1009_ROLE"/>
    <xsd:enumeration value="Rel_1010_ROLE"/>
    <xsd:enumeration value="Rel_1011_ROLE"/>
    <xsd:enumeration value="Rel_1012_ROLE"/>
    <xsd:enumeration value="Rel_1013_ROLE"/>
    <xsd:enumeration value="Rel_1014_ROLE"/>
    <xsd:enumeration value="Rel_1015_ROLE"/>
    <xsd:enumeration value="Rel_1016_ROLE"/>
    <xsd:enumeration value="Rel_1017_ROLE"/>
    <xsd:enumeration value="Rel_1018_ROLE"/>
    <xsd:enumeration value="Rel_1019_ROLE"/>
    <xsd:enumeration value="Rel_1020_ROLE"/>
  </xsd:restriction>
</xsd:simpleType>
```

```

<xsd:enumeration value="Rel_1021_ROLE" />
<xsd:enumeration value="Rel_1022_ROLE" />
<xsd:enumeration value="Rel_1023_ROLE" />
<xsd:enumeration value="Rel_1024_ROLE" />
<xsd:enumeration value="Rel_1025_ROLE" />
<xsd:enumeration value="Rel_1026_ROLE" />
<xsd:enumeration value="Rel_1027_ROLE" />
<xsd:enumeration value="Rel_1028_ROLE" />
<xsd:enumeration value="Rel_1029_ROLE" />
<xsd:enumeration value="Rel_1030_ROLE" />
<xsd:enumeration value="Rel_1040_ROLE" />
<xsd:enumeration value="Rel_1041_ROLE" />
<xsd:enumeration value="Rel_1042_ROLE" />
<xsd:enumeration value="Rel_1043_ROLE" />
<xsd:enumeration value="Rel_1044_ROLE" />
<xsd:enumeration value="Rel_2102_ROLE" />
<xsd:enumeration value="Rel_2103_ROLE" />
<xsd:enumeration value="Rel_2104_ROLE" />
<xsd:enumeration value="Rel_2105_ROLE" />
<xsd:enumeration value="Rel_2106_ROLE" />
<xsd:enumeration value="Rel_2108_ROLE" />
<xsd:enumeration value="Rel_2109_ROLE" />
<xsd:enumeration value="Rel_2110_ROLE" />
<xsd:enumeration value="Rel_2128_ROLE" />
<xsd:enumeration value="Rel_2129_ROLE" />
<xsd:enumeration value="Rel_2140_ROLE" />
<xsd:enumeration value="Rel_2200_ROLE" />
<xsd:enumeration value="Rel_2300_ROLE" />
<xsd:enumeration value="Rel_2305_ROLE" />
<xsd:enumeration value="Rel_2310_ROLE" />
<xsd:enumeration value="Rel_2315_ROLE" />
<xsd:enumeration value="Rel_2400_ROLE" />
<xsd:enumeration value="Rel_4800_ROLE" />
<xsd:enumeration value="Rel_4801_ROLE" />
<xsd:enumeration value="Rel_4802_ROLE" />
<xsd:enumeration value="Rel_6010_ROLE" />
<xsd:enumeration value="Rel_6020_ROLE" />
<xsd:enumeration value="Rel_7001_ROLE" />
<xsd:enumeration value="Rel_7002_ROLE" />
<xsd:enumeration value="Rel_7003_ROLE" />
<xsd:enumeration value="Rel_7004_ROLE" />
<xsd:enumeration value="Rel_7005_ROLE" />
<xsd:enumeration value="Rel_7006_ROLE" />
<xsd:enumeration value="Rel_7007_ROLE" />
</xsd:restriction>
</xsd:simpleType>

```

13.5.56 Declination

```

<xsd:complexType name="Rel_code_roles_def_ref">
  <xsd:choice>
    <xsd:element name="Rel_1001_ROLE" type="Rel_1001_ROLE" />
    <xsd:element name="Rel_1002_ROLE" type="Rel_1002_ROLE" />
    <xsd:element name="Rel_1003_ROLE" type="Rel_1003_ROLE" />
    <xsd:element name="Rel_1005_ROLE" type="Rel_1005_ROLE" />
    <xsd:element name="Rel_1006_ROLE" type="Rel_1006_ROLE" />
    <xsd:element name="Rel_1007_ROLE" type="Rel_1007_ROLE" />
    <xsd:element name="Rel_1008_ROLE" type="Rel_1008_ROLE" />
    <xsd:element name="Rel_1009_ROLE" type="Rel_1009_ROLE" />
    <xsd:element name="Rel_1010_ROLE" type="Rel_1010_ROLE" />
    <xsd:element name="Rel_1011_ROLE" type="Rel_1011_ROLE" />
    <xsd:element name="Rel_1012_ROLE" type="Rel_1012_ROLE" />
    <xsd:element name="Rel_1013_ROLE" type="Rel_1013_ROLE" />
    <xsd:element name="Rel_1014_ROLE" type="Rel_1014_ROLE" />
    <xsd:element name="Rel_1015_ROLE" type="Rel_1015_ROLE" />
    <xsd:element name="Rel_1016_ROLE" type="Rel_1016_ROLE" />
    <xsd:element name="Rel_1017_ROLE" type="Rel_1017_ROLE" />
    <xsd:element name="Rel_1018_ROLE" type="Rel_1018_ROLE" />
    <xsd:element name="Rel_1019_ROLE" type="Rel_1019_ROLE" />
    <xsd:element name="Rel_1020_ROLE" type="Rel_1020_ROLE" />
    <xsd:element name="Rel_1021_ROLE" type="Rel_1021_ROLE" />
    <xsd:element name="Rel_1022_ROLE" type="Rel_1022_ROLE" />
    <xsd:element name="Rel_1023_ROLE" type="Rel_1023_ROLE" />
    <xsd:element name="Rel_1024_ROLE" type="Rel_1024_ROLE" />
    <xsd:element name="Rel_1025_ROLE" type="Rel_1025_ROLE" />
  </xsd:choice>
</xsd:complexType>

```

```

<xsd:element name="Rel_1026_ROLE" type="Rel_1026_ROLE"/>
<xsd:element name="Rel_1027_ROLE" type="Rel_1027_ROLE"/>
<xsd:element name="Rel_1028_ROLE" type="Rel_1028_ROLE"/>
<xsd:element name="Rel_1029_ROLE" type="Rel_1029_ROLE"/>
<xsd:element name="Rel_1030_ROLE" type="Rel_1030_ROLE"/>
<xsd:element name="Rel_1040_ROLE" type="Rel_1040_ROLE"/>
<xsd:element name="Rel_1041_ROLE" type="Rel_1041_ROLE"/>
<xsd:element name="Rel_1042_ROLE" type="Rel_1042_ROLE"/>
<xsd:element name="Rel_1043_ROLE" type="Rel_1043_ROLE"/>
<xsd:element name="Rel_1044_ROLE" type="Rel_1044_ROLE"/>
<xsd:element name="Rel_2102_ROLE" type="Rel_2102_ROLE"/>
<xsd:element name="Rel_2103_ROLE" type="Rel_2103_ROLE"/>
<xsd:element name="Rel_2104_ROLE" type="Rel_2104_ROLE"/>
<xsd:element name="Rel_2105_ROLE" type="Rel_2105_ROLE"/>
<xsd:element name="Rel_2106_ROLE" type="Rel_2106_ROLE"/>
<xsd:element name="Rel_2108_ROLE" type="Rel_2108_ROLE"/>
<xsd:element name="Rel_2109_ROLE" type="Rel_2109_ROLE"/>
<xsd:element name="Rel_2110_ROLE" type="Rel_2110_ROLE"/>
<xsd:element name="Rel_2128_ROLE" type="Rel_2128_ROLE"/>
<xsd:element name="Rel_2129_ROLE" type="Rel_2129_ROLE"/>
<xsd:element name="Rel_2140_ROLE" type="Rel_2140_ROLE"/>
<xsd:element name="Rel_2200_ROLE" type="Rel_2200_ROLE"/>
<xsd:element name="Rel_2300_ROLE" type="Rel_2300_ROLE"/>
<xsd:element name="Rel_2305_ROLE" type="Rel_2305_ROLE"/>
<xsd:element name="Rel_2310_ROLE" type="Rel_2310_ROLE"/>
<xsd:element name="Rel_2315_ROLE" type="Rel_2315_ROLE"/>
<xsd:element name="Rel_2400_ROLE" type="Rel_2400_ROLE"/>
<xsd:element name="Rel_4800_ROLE" type="Rel_4800_ROLE"/>
<xsd:element name="Rel_4801_ROLE" type="Rel_4801_ROLE"/>
<xsd:element name="Rel_4802_ROLE" type="Rel_4802_ROLE"/>
<xsd:element name="Rel_6010_ROLE" type="Rel_6010_ROLE"/>
<xsd:element name="Rel_6020_ROLE" type="Rel_6020_ROLE"/>
<xsd:element name="Rel_7001_ROLE" type="Rel_7001_ROLE"/>
<xsd:element name="Rel_7002_ROLE" type="Rel_7002_ROLE"/>
<xsd:element name="Rel_7003_ROLE" type="Rel_7003_ROLE"/>
<xsd:element name="Rel_7004_ROLE" type="Rel_7004_ROLE"/>
<xsd:element name="Rel_7005_ROLE" type="Rel_7005_ROLE"/>
<xsd:element name="Rel_7006_ROLE" type="Rel_7006_ROLE"/>
<xsd:element name="Rel_7007_ROLE" type="Rel_7007_ROLE"/>
</xsd:choice>
</xsd:complexType>

```

13.5.57 Declination (Simple)

```

<xsd:simpleType name="Declination">
  <xsd:restriction base="xsd:integer">
    <xsd:minInclusive value="-400000"/>
    <xsd:maxInclusive value="400000"/>
    <xsd:totalDigits value="7"/>
  </xsd:restriction>
</xsd:simpleType>

```

13.5.58 Edge Level (Simple)

```

<xsd:simpleType name="Edge_level">
  <xsd:restriction base="xsd:integer">
    <xsd:minInclusive value="-9"/>
    <xsd:maxInclusive value="99"/>
  </xsd:restriction>
</xsd:simpleType>

```

13.5.59 Coordinate Mask (Simple)

```

<xsd:simpleType name="Coord_mask">
  <xsd:restriction base="xsd:integer">
    <xsd:minInclusive value="0"/>
    <xsd:maxInclusive value="3331"/>
  </xsd:restriction>
</xsd:simpleType>

```

13.5.60 Time Mask (Simple)

```

<xsd:simpleType name="Time_mask">

```

```

    <xsd:restriction base="xsd:integer">
      <xsd:minInclusive value="1"/>
      <xsd:maxInclusive value="16"/>
    </xsd:restriction>
  </xsd:simpleType>

```

13.5.61 Two Digit Field Counter (Simple)

```

<xsd:simpleType name="Field_counter_2dig">
  <xsd:restriction base="xsd:integer">
    <xsd:minInclusive value="0"/>
    <xsd:maxInclusive value="99"/>
  </xsd:restriction>
</xsd:simpleType>

```

13.5.62 Three Digit Field Counter (Simple)

```

<xsd:simpleType name="Field_counter_3dig">
  <xsd:restriction base="xsd:integer">
    <xsd:minInclusive value="0"/>
    <xsd:maxInclusive value="999"/>
  </xsd:restriction>
</xsd:simpleType>

```

13.5.63 Five Digit Field Counter (Simple)

```

<xsd:simpleType name="Field_counter_5dig">
  <xsd:restriction base="xsd:integer">
    <xsd:minInclusive value="0"/>
    <xsd:maxInclusive value="99999"/>
  </xsd:restriction>
</xsd:simpleType>

```

13.5.64 Multiplier Factor (Simple)

```

<xsd:simpleType name="Mult_factor">
  <xsd:restriction base="One_digit_signed_int"/>
</xsd:simpleType>

```

13.5.65 Name (Simple)

```

<xsd:simpleType name="Name">
  <xsd:restriction base="xsd:string">
    <xsd:maxLength value="40"/>
  </xsd:restriction>
</xsd:simpleType>

```

13.5.66 Language Name Pair

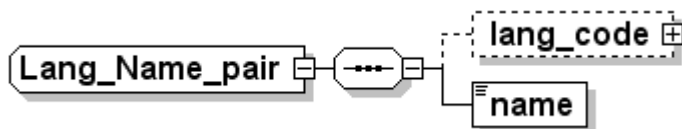

```

<xsd:complexType name="Lang_Name_pair">
  <xsd:sequence>
    <xsd:element name="lang_code" type="Lan_cod" minOccurs="0"/>
    <xsd:element name="name" type="Name"/>
  </xsd:sequence>
</xsd:complexType>

```

13.5.67 Five Digit Integer (Simple)

```

<xsd:simpleType name="Five_digit_int">
  <xsd:restriction base="xsd:integer">
    <xsd:minInclusive value="0"/>
    <xsd:maxInclusive value="99999"/>
  </xsd:restriction>
</xsd:simpleType>

```

13.5.68 Six Digit Integer (Simple)

```
<xsd:simpleType name="Six_digit_int">  
  <xsd:restriction base="xsd:integer">  
    <xsd:minInclusive value="0"/>  
    <xsd:maxInclusive value="999999"/>  
  </xsd:restriction>  
</xsd:simpleType>
```

13.5.69 Object Class Code (Simple)

```
<xsd:simpleType name="Obj_class_code">  
  <xsd:restriction base="xsd:string">  
    <xsd:enumeration value="0001"/>  
    <xsd:enumeration value="0002"/>  
    <xsd:enumeration value="0003"/>  
    <xsd:enumeration value="0004"/>  
    <xsd:enumeration value="0005"/>  
    <xsd:enumeration value="0006"/>  
  </xsd:restriction>  
</xsd:simpleType>
```

13.5.70 Two Digit ID (Simple)

```
<xsd:simpleType name="Two_digit_ID">  
  <xsd:restriction base="Two_digit_int">  
    <xsd:minInclusive value="1"/>  
  </xsd:restriction>  
</xsd:simpleType>
```

13.5.71 Three Digit ID (Simple)

```
<xsd:simpleType name="Three_digit_ID">  
  <xsd:restriction base="Three_digit_int">  
    <xsd:minInclusive value="1"/>  
  </xsd:restriction>  
</xsd:simpleType>
```

13.5.72 Four Digit ID (Simple)

```
<xsd:simpleType name="Four_digit_ID">  
  <xsd:restriction base="Four_digit_int">  
    <xsd:minInclusive value="1"/>  
  </xsd:restriction>  
</xsd:simpleType>
```

13.5.73 Five Digit ID (Simple)

```
<xsd:simpleType name="Five_digit_ID">  
  <xsd:restriction base="Five_digit_int">  
    <xsd:minInclusive value="1"/>  
  </xsd:restriction>  
</xsd:simpleType>
```

13.5.74 Six Digit ID (Simple)

```
<xsd:simpleType name="Six_digit_ID">  
  <xsd:restriction base="Six_digit_int">  
    <xsd:minInclusive value="1"/>  
  </xsd:restriction>  
</xsd:simpleType>
```

13.5.75 Ten Digit ID (Simple)

```
<xsd:simpleType name="Ten_digit_ID">  
  <xsd:restriction base="xsd:integer">  
    <xsd:minInclusive value="1"/>  
  </xsd:restriction>  
</xsd:simpleType>
```

```

        <xsd:totalDigits value="10"/>
    </xsd:restriction>
</xsd:simpleType>

```

13.5.76 SUBID (Simple)

```

<xsd:simpleType name="SUBID">
    <xsd:restriction base="Three_digit_ID"/>
</xsd:simpleType>

```

13.5.77 Record ID (Simple)

```

<xsd:simpleType name="Rec_ID">
    <xsd:restriction base="Ten_digit_ID"/>
</xsd:simpleType>

```

13.5.78 Geopolitical Structure Definition ID (Simple)

```

<xsd:simpleType name="GeoPol_str_def_ID">
    <xsd:restriction base="Four_digit_ID"/>
</xsd:simpleType>

```

13.5.79 Geopolitical Structure Definition Component ID (Simple)

```

<xsd:simpleType name="GeoPol_str_cmp_def_ID">
    <xsd:restriction base="Six_digit_ID"/>
</xsd:simpleType>

```

13.5.80 Album ID (Simple)

```

<xsd:simpleType name="Alb_ID">
    <xsd:restriction base="Rec_ID"/>
</xsd:simpleType>

```

13.5.81 Abbreviation ID (Simple)

```

<xsd:simpleType name="Abbrev_ID">
    <xsd:restriction base="Rec_ID"/>
</xsd:simpleType>

```

13.5.82 Area Feature ID (Simple)

```

<xsd:simpleType name="Area_feature_ID">
    <xsd:restriction base="Rec_ID"/>
</xsd:simpleType>

```

13.5.83 Attribute ID (Simple)

```

<xsd:simpleType name="Attr_ID">
    <xsd:restriction base="Rec_ID"/>
</xsd:simpleType>

```

13.5.84 Complex ID (Simple)

```

<xsd:simpleType name="Complex_ID">
    <xsd:restriction base="Rec_ID"/>
</xsd:simpleType>

```

13.5.85 Conversion ID (Simple)

```

<xsd:simpleType name="Conversion_ID">
    <xsd:restriction base="Rec_ID"/>
</xsd:simpleType>

```

13.5.86 Datum & Ellipsoid ID (Simple)

```
<xsd:simpleType name="Datel_ID">  
  <xsd:restriction base="Rec_ID"/>  
</xsd:simpleType>
```

13.5.87 Directory ID (Simple)

```
<xsd:simpleType name="Direc_ID">  
  <xsd:restriction base="Rec_ID"/>  
</xsd:simpleType>
```

13.5.88 Dataset ID (Simple)

```
<xsd:simpleType name="Dset_ID">  
  <xsd:restriction base="Rec_ID"/>  
</xsd:simpleType>
```

13.5.89 Dataset Subtitle ID (Simple)

```
<xsd:simpleType name="Dset_subtitle_ID">  
  <xsd:restriction base="SUBID"/>  
</xsd:simpleType>
```

13.5.90 Dataset Producer ID (Simple)

```
<xsd:simpleType name="Dset_producer_ID">  
  <xsd:restriction base="SUBID"/>  
</xsd:simpleType>
```

13.5.91 Dataset Contents ID (Simple)

```
<xsd:simpleType name="Dset_contents_ID">  
  <xsd:restriction base="SUBID"/>  
</xsd:simpleType>
```

13.5.92 Edge ID (Simple)

```
<xsd:simpleType name="Edge_ID">  
  <xsd:restriction base="Rec_ID"/>  
</xsd:simpleType>
```

13.5.93 Face ID (Simple)

```
<xsd:simpleType name="Face_ID">  
  <xsd:restriction base="Rec_ID"/>  
</xsd:simpleType>
```

13.5.94 Feature ID (Simple)

```
<xsd:simpleType name="Feature_ID">  
  <xsd:restriction base="Rec_ID"/>  
</xsd:simpleType>
```

13.5.95 Field Definition ID (Simple)

```
<xsd:simpleType name="Field_def_ID">  
  <xsd:restriction base="Rec_ID"/>  
</xsd:simpleType>
```

13.5.96 Geoid Undulation ID (Simple)

```
<xsd:simpleType name="Geoid_und_ID">  
  <xsd:restriction base="Rec_ID"/>  
</xsd:simpleType>
```

13.5.97 Geopolitical Update ID (Simple)

```
<xsd:simpleType name="Geo_upd_ID">  
  <xsd:restriction base="Rec_ID"/>  
</xsd:simpleType>
```

13.5.98 Line Feature ID (Simple)

```
<xsd:simpleType name="Line_feature_ID">  
  <xsd:restriction base="Rec_ID"/>  
</xsd:simpleType>
```

13.5.99 Main Title ID (Simple)

```
<xsd:simpleType name="Main_title_ID">  
  <xsd:restriction base="SUBID"/>  
</xsd:simpleType>
```

13.5.100 Magnetic Field ID (Simple)

```
<xsd:simpleType name="Mag fld_ID">  
  <xsd:restriction base="Rec_ID"/>  
</xsd:simpleType>
```

13.5.101 National Grid ID (Simple)

```
<xsd:simpleType name="Natgrid_ID">  
  <xsd:restriction base="Rec_ID"/>  
</xsd:simpleType>
```

13.5.102 Network ID (Simple)

```
<xsd:simpleType name="Netwk_ID">  
  <xsd:restriction base="Five_digit_ID"/>  
</xsd:simpleType>
```

13.5.103 Coordinate ID (Simple)

```
<xsd:simpleType name="Coord_ID">  
  <xsd:restriction base="Rec_ID"/>  
</xsd:simpleType>
```

13.5.104 Node ID (Simple)

```
<xsd:simpleType name="Node_ID">  
  <xsd:restriction base="Rec_ID"/>  
</xsd:simpleType>
```

13.5.105 Object Attribute Update ID (Simple)

```
<xsd:simpleType name="Obj_attr_upd_ID">  
  <xsd:restriction base="Rec_ID"/>  
</xsd:simpleType>
```

13.5.106 Object Reference ID (Simple)

```
<xsd:simpleType name="Obj_ref_ID">  
  <xsd:restriction base="Rec_ID"/>  
</xsd:simpleType>
```

13.5.107 Object Update ID (Simple)

```
<xsd:simpleType name="Obj_upd_ID">  
  <xsd:restriction base="Rec_ID"/>  
</xsd:simpleType>
```

13.5.108 Point Feature ID (Simple)

```
<xsd:simpleType name="Point_feat_ID">  
  <xsd:restriction base="Rec_ID"/>  
</xsd:simpleType>
```

13.5.109 Projection ID (Simple)

```
<xsd:simpleType name="Projection_ID">  
  <xsd:restriction base="Rec_ID"/>  
</xsd:simpleType>
```

13.5.110 Relationship ID (Simple)

```
<xsd:simpleType name="Relationship_ID">  
  <xsd:restriction base="Rec_ID"/>  
</xsd:simpleType>
```

13.5.111 Section ID (Simple)

```
<xsd:simpleType name="Sect_ID">  
  <xsd:restriction base="Rec_ID"/>  
</xsd:simpleType>
```

13.5.112 XY Control ID (Simple)

```
<xsd:simpleType name="SHR_XY_cntrl_ID">  
  <xsd:restriction base="SUBID"/>  
</xsd:simpleType>
```

13.5.113 Z Control ID (Simple)

```
<xsd:simpleType name="SHR_Z_cntrl_ID">  
  <xsd:restriction base="SUBID"/>  
</xsd:simpleType>
```

13.5.114 Spatial Domain ID (Simple)

```
<xsd:simpleType name="Spat_dom_ID">  
  <xsd:restriction base="Rec_ID"/>  
</xsd:simpleType>
```

13.5.115 Source Description ID (Simple)

```
<xsd:simpleType name="Src_desc_ID">  
  <xsd:restriction base="Five_digit_ID"/>  
</xsd:simpleType>
```

13.5.116 Source Scale & Title ID (Simple)

```
<xsd:simpleType name="Src_scale_title_ID">  
  <xsd:restriction base="SUBID"/>  
</xsd:simpleType>
```

13.5.117 Source Publisher ID (Simple)

```
<xsd:simpleType name="Src_publisher_ID">  
  <xsd:restriction base="SUBID"/>  
</xsd:simpleType>
```

13.5.118 Source Distributor ID (Simple)

```
<xsd:simpleType name="Src_distributor_ID">  
  <xsd:restriction base="SUBID"/>  
</xsd:simpleType>
```

13.5.119 Text ID (Simple)

```
<xsd:simpleType name="Text_ID">  
  <xsd:restriction base="Rec_ID" />  
</xsd:simpleType>
```

13.5.120 Time ID (Simple)

```
<xsd:simpleType name="Time_ID">  
  <xsd:restriction base="Rec_ID" />  
</xsd:simpleType>
```

13.5.121 Record Definition ID (Simple)

```
<xsd:simpleType name="Rec_def_ID">  
  <xsd:restriction base="Rec_ID" />  
</xsd:simpleType>
```

13.5.122 Vertical Datum ID (Simple)

```
<xsd:simpleType name="Vert_datum_ID">  
  <xsd:restriction base="Rec_ID" />  
</xsd:simpleType>
```

13.5.123 Record Type (Simple)

```
<xsd:simpleType name="Rec_typ">  
  <xsd:restriction base="Record_type_value" />  
</xsd:simpleType>
```

13.5.124 Record Subtype (Simple)

```
<xsd:simpleType name="Rec_subtyp">  
  <xsd:restriction base="Two_digit_ID" />  
</xsd:simpleType>
```

13.5.125 Geo ID (Simple)

```
<xsd:simpleType name="Geo_ID">  
  <xsd:restriction base="Rec_ID" />  
</xsd:simpleType>
```

13.5.126 Layer ID (Simple)

```
<xsd:simpleType name="Layer_ID">  
  <xsd:restriction base="Ten_digit_ID" />  
</xsd:simpleType>
```

13.5.127 Data Type (Simple)

```
<xsd:simpleType name="Data_typ">  
  <xsd:restriction base="xsd:string">  
    <xsd:enumeration value="N" />  
    <xsd:enumeration value="A" />  
    <xsd:enumeration value="G" />  
    <xsd:enumeration value="L" />  
    <xsd:enumeration value="I" />  
    <xsd:enumeration value="AN" />  
  </xsd:restriction>  
</xsd:simpleType>
```

13.5.128 Extended Data Type (Simple)

```
<xsd:simpleType name="Data_type_extended">  
  <xsd:restriction base="xsd:string">  
    <xsd:length value="2" />  
    <xsd:enumeration value="N" />  
  </xsd:restriction>  
</xsd:simpleType>
```

```
<xsd:enumeration value="A" />
<xsd:enumeration value="G" />
<xsd:enumeration value="L" />
<xsd:enumeration value="I" />
<xsd:enumeration value="AN" />
</xsd:restriction>
</xsd:simpleType>
```

13.5.129 Attribute Data Unit Code (Simple)

```
<xsd:simpleType name="Attr_data_unit_code">
  <xsd:restriction base="xsd:string">
    <xsd:length value="3" />
    <xsd:enumeration value="DEG" />
    <xsd:enumeration value="MTR" />
    <xsd:enumeration value="KMR" />
    <xsd:enumeration value="INC" />
    <xsd:enumeration value="FET" />
    <xsd:enumeration value="MIL" />
    <xsd:enumeration value="KGR" />
    <xsd:enumeration value="PND" />
    <xsd:enumeration value="KIP" />
    <xsd:enumeration value="TON" />
    <xsd:enumeration value="MIN" />
    <xsd:enumeration value="KPH" />
    <xsd:enumeration value="MPH" />
  </xsd:restriction>
</xsd:simpleType>
```

13.5.130 Attribute Data Unit Name (Simple)

```
<xsd:simpleType name="Attr_data_unit_name">
  <xsd:restriction base="xsd:string">
    <xsd:enumeration value="Degree" />
    <xsd:enumeration value="Metres" />
    <xsd:enumeration value="Kilometre" />
    <xsd:enumeration value="Inch" />
    <xsd:enumeration value="Feet" />
    <xsd:enumeration value="Mile" />
    <xsd:enumeration value="Kilogram" />
    <xsd:enumeration value="Pound (US pound)" />
    <xsd:enumeration value="Kilo Pound" />
    <xsd:enumeration value="Ton (metric ton)" />
    <xsd:enumeration value="Minute (of time)" />
    <xsd:enumeration value="Kilometres per hour" />
    <xsd:enumeration value="Miles per hour" />
  </xsd:restriction>
</xsd:simpleType>
```

13.5.131 Edge Status Name (Simple)

```
<xsd:simpleType name="Edge_status_name">
  <xsd:restriction base="xsd:string">
    <xsd:enumeration value="not available 1" />
    <xsd:enumeration value="normal edge" />
    <xsd:enumeration value="dataset border edge" />
    <xsd:enumeration value="not available 2" />
    <xsd:enumeration value="non-section border edge" />
  </xsd:restriction>
</xsd:simpleType>
```

13.5.132 Node Status Name (Simple)

```
<xsd:simpleType name="Node_status_name">
  <xsd:restriction base="xsd:string">
    <xsd:enumeration value="section border node" />
    <xsd:enumeration value="normal node" />
    <xsd:enumeration value="dataset border node" />
    <xsd:enumeration value="end of stubble" />
    <xsd:enumeration value="non-section border node" />
  </xsd:restriction>
</xsd:simpleType>
```

13.5.133 Attribute Data Type Name (Simple)

```

<xsd:simpleType name="Attr_data_type_name">
  <xsd:restriction base="xsd:string">
    <xsd:enumeration value="Code List" />
    <xsd:enumeration value="Enumeration" />
    <xsd:enumeration value="Number" />
    <xsd:enumeration value="Boolean" />
    <xsd:enumeration value="Bit Mask Register (binary number as binary)" />
    <xsd:enumeration value="Bit Mask Integer (binary number as decimal)" />
    <xsd:enumeration value="Time Domain" />
    <xsd:enumeration value="(Simple) Character String" />
    <xsd:enumeration value="(Language-Coded) Text" />
    <xsd:enumeration value="Percentage" />
    <xsd:enumeration value="Composite" />
    <xsd:enumeration value="Identifier" />
    <xsd:enumeration value="Geopolitical Structure Definition" />
    <xsd:enumeration value="Signed Percentage" />
    <xsd:enumeration value="Measure" />
  </xsd:restriction>
</xsd:simpleType>

```

13.5.134 Attribute Data Type Value (Simple)

```

<xsd:simpleType name="Attr_data_type_value">
  <xsd:restriction base="xsd:string">
    <xsd:enumeration value="COD" />
    <xsd:enumeration value="ENM" />
    <xsd:enumeration value="CNT" />
    <xsd:enumeration value="BOL" />
    <xsd:enumeration value="BMR" />
    <xsd:enumeration value="BMI" />
    <xsd:enumeration value="TMR" />
    <xsd:enumeration value="SCS" />
    <xsd:enumeration value="TXT" />
    <xsd:enumeration value="PRC" />
    <xsd:enumeration value="CMP" />
    <xsd:enumeration value="IDN" />
    <xsd:enumeration value="GSD" />
    <xsd:enumeration value="PRS" />
    <xsd:enumeration value="MSR" />
  </xsd:restriction>
</xsd:simpleType>

```

13.5.135 Action Name (Simple)

```

<xsd:simpleType name="Action_name">
  <xsd:restriction base="xsd:string">
    <xsd:enumeration value="update of source only" />
    <xsd:enumeration value="new" />
    <xsd:enumeration value="delete" />
    <xsd:enumeration value="modify" />
  </xsd:restriction>
</xsd:simpleType>

```

13.5.136 Action Value (Simple)

```

<xsd:simpleType name="Action_value">
  <xsd:restriction base="xsd:integer">
    <xsd:minInclusive value="0" />
    <xsd:maxInclusive value="3" />
    <xsd:enumeration value="0" />
    <xsd:enumeration value="1" />
    <xsd:enumeration value="2" />
    <xsd:enumeration value="3" />
  </xsd:restriction>
</xsd:simpleType>

```

13.5.137 Attribute Type Code Name (Simple)

```

<xsd:simpleType name="Attr_type_code_name">
  <xsd:restriction base="xsd:string">

```

```
<xsd:enumeration value="Infrastructure Accessibility Aids"/>
<xsd:enumeration value="Structure Abutment"/>
<xsd:enumeration value="Accident Identifier"/>
<xsd:enumeration value="Departure/Arrival"/>
<xsd:enumeration value="Wheelchair Limitation"/>
<xsd:enumeration value="Hearing Limitation"/>
<xsd:enumeration value="Airport Code"/>
<xsd:enumeration value="Alternate Street Name Text"/>
<xsd:enumeration value="Alternate Name Text"/>
<xsd:enumeration value="Positional Accuracy"/>
<xsd:enumeration value="International Railway Station"/>
<xsd:enumeration value="Average Vehicle Speed"/>
<xsd:enumeration value="Accident Date"/>
<xsd:enumeration value="Vision Limitation"/>
<xsd:enumeration value="Maximum Weight per Axle Allowed"/>
<xsd:enumeration value="Association Type"/>
<xsd:enumeration value="Breakfast Available"/>
<xsd:enumeration value="Building Class Name"/>
<xsd:enumeration value="Building Detail Type"/>
<xsd:enumeration value="Blocked Passage Type"/>
<xsd:enumeration value="Building Storey"/>
<xsd:enumeration value="Block Grouping"/>
<xsd:enumeration value="Upper Building Elevation"/>
<xsd:enumeration value="Lower Building Elevation"/>
<xsd:enumeration value="Block Class Name"/>
<xsd:enumeration value="Business Lunch"/>
<xsd:enumeration value="Brand Name"/>
<xsd:enumeration value="Block Type"/>
<xsd:enumeration value="Blocked Passage Location"/>
<xsd:enumeration value="Urban Railway Station"/>
<xsd:enumeration value="Building Storey Count"/>
<xsd:enumeration value="Structure Type"/>
<xsd:enumeration value="Administrative Boundary Type"/>
<xsd:enumeration value="Boundary Type"/>
<xsd:enumeration value="Accepted Credit Cards"/>
<xsd:enumeration value="City Centre Administrative Class"/>
<xsd:enumeration value="Car Dealer Type"/>
<xsd:enumeration value="Start End Flag"/>
<xsd:enumeration value="Conditional Traffic Flow"/>
<xsd:enumeration value="Distance Measure"/>
<xsd:enumeration value="Distance Measure Referent"/>
<xsd:enumeration value="Assignment Order"/>
<xsd:enumeration value="Commercial Airline Service"/>
<xsd:enumeration value="Continuation Type"/>
<xsd:enumeration value="Correspondence Order"/>
<xsd:enumeration value="Commuter/Regional Railway Station"/>
<xsd:enumeration value="Construction Status"/>
<xsd:enumeration value="Other Textual Content on a Traffic Sign"/>
<xsd:enumeration value="Currency"/>
<xsd:enumeration value="Scope"/>
<xsd:enumeration value="Destination of Flight Connection"/>
<xsd:enumeration value="Divider Height"/>
<xsd:enumeration value="Direction Category"/>
<xsd:enumeration value="Destination Location"/>
<xsd:enumeration value="Divider Marking"/>
<xsd:enumeration value="Directional Prefix"/>
<xsd:enumeration value="Divided Road Element"/>
<xsd:enumeration value="Directional Suffix"/>
<xsd:enumeration value="Divider Type"/>
<xsd:enumeration value="Divider Width"/>
<xsd:enumeration value="Divider Impact"/>
<xsd:enumeration value="Display Class"/>
<xsd:enumeration value="Divider Colour"/>
<xsd:enumeration value="Enclosed Traffic Area Type"/>
<xsd:enumeration value="External Identifier"/>
<xsd:enumeration value="Exit Number"/>
<xsd:enumeration value="Equipment Identifier"/>
<xsd:enumeration value="Entry Point Type"/>
<xsd:enumeration value="Lane Type"/>
<xsd:enumeration value="Functional Road Class"/>
<xsd:enumeration value="Façade Fabric Type"/>
<xsd:enumeration value="Façade Colour"/>
<xsd:enumeration value="Road Furniture Position"/>
<xsd:enumeration value="Façade Component Placement"/>
<xsd:enumeration value="Frequency of a Traffic Connection"/>
<xsd:enumeration value="Facilities en Suite"/>
```

```

<xsd:enumeration value="Ferry Type"/>
<xsd:enumeration value="Form of Way"/>
<xsd:enumeration value="Freeway"/>
<xsd:enumeration value="General Aviation"/>
<xsd:enumeration value="Government Type"/>
<xsd:enumeration value="Give Way Type"/>
<xsd:enumeration value="Intermediate House Number"/>
<xsd:enumeration value="Last House Number"/>
<xsd:enumeration value="House Number"/>
<xsd:enumeration value="Height Label"/>
<xsd:enumeration value="House Number Structure"/>
<xsd:enumeration value="Pedestrian Type"/>
<xsd:enumeration value="ID of Flight Connection"/>
<xsd:enumeration value="Interchange Type"/>
<xsd:enumeration value="Importance"/>
<xsd:enumeration value="Road Inclination"/>
<xsd:enumeration value="Junction Type"/>
<xsd:enumeration value="Phonetic Alphabet"/>
<xsd:enumeration value="Location Reference Code"/>
<xsd:enumeration value="Lane Dependent Validity"/>
<xsd:enumeration value="Measured Length"/>
<xsd:enumeration value="Lateral Offset"/>
<xsd:enumeration value="Pronunciation Language"/>
<xsd:enumeration value="Length of a Road Element"/>
<xsd:enumeration value="Linear Referencing Method"/>
<xsd:enumeration value="Location Reference Type"/>
<xsd:enumeration value="Location Description"/>
<xsd:enumeration value="Pronunciation Variant"/>
<xsd:enumeration value="Magnetic Anomalies"/>
<xsd:enumeration value="Multi-Media Action"/>
<xsd:enumeration value="Multi-Media Description"/>
<xsd:enumeration value="Maximum Height Allowed"/>
<xsd:enumeration value="Minimum Number of Lanes"/>
<xsd:enumeration value="Maximum Length Allowed"/>
<xsd:enumeration value="Multi-Media Time Domain"/>
<xsd:enumeration value="Multi-Media File Attachment Name"/>
<xsd:enumeration value="Minimum Number of Occupants"/>
<xsd:enumeration value="Military Airport"/>
<xsd:enumeration value="Multi-Media File Attachment Type"/>
<xsd:enumeration value="Main Railway Station"/>
<xsd:enumeration value="Maximum Total Weight Allowed"/>
<xsd:enumeration value="Maximum Width Allowed"/>
<xsd:enumeration value="Notation Anomaly"/>
<xsd:enumeration value="Name Component Length"/>
<xsd:enumeration value="Notation Alphabet"/>
<xsd:enumeration value="Domestic/International"/>
<xsd:enumeration value="Name Component Offset"/>
<xsd:enumeration value="Name Prefix"/>
<xsd:enumeration value="National Road Class"/>
<xsd:enumeration value="Name Component Type"/>
<xsd:enumeration value="Notation Variant"/>
<xsd:enumeration value="Notation Version"/>
<xsd:enumeration value="Paved Road Surface Type"/>
<xsd:enumeration value="Official Code"/>
<xsd:enumeration value="Official Street Name Type Text"/>
<xsd:enumeration value="Official Name Text"/>
<xsd:enumeration value="Opening Period"/>
<xsd:enumeration value="Ownership"/>
<xsd:enumeration value="One-way"/>
<xsd:enumeration value="Pass"/>
<xsd:enumeration value="Pronunciation"/>
<xsd:enumeration value="Population Class"/>
<xsd:enumeration value="Route Direction"/>
<xsd:enumeration value="Place Name"/>
<xsd:enumeration value="Parking Facilities Available"/>
<xsd:enumeration value="Pathway Type"/>
<xsd:enumeration value="Percentage of International Traffic"/>
<xsd:enumeration value="Pathway Safety Indicator"/>
<xsd:enumeration value="Park and Ride Facility"/>
<xsd:enumeration value="Place within Place Classification"/>
<xsd:enumeration value="Public Transport Mode"/>
<xsd:enumeration value="Population"/>
<xsd:enumeration value="Post Office Type"/>
<xsd:enumeration value="Public Transport Operator"/>
<xsd:enumeration value="Price band"/>
<xsd:enumeration value="Postal Code"/>

```

```
<xsd:enumeration value="Park Type"/>
<xsd:enumeration value="Pavement Status"/>
<xsd:enumeration value="Not Crossable by Pedestrians"/>
<xsd:enumeration value="Parking Type Charged"/>
<xsd:enumeration value="Rating"/>
<xsd:enumeration value="Removable Blockage"/>
<xsd:enumeration value="Region Code"/>
<xsd:enumeration value="Route Type Prefix"/>
<xsd:enumeration value="Restaurant Facilities Available"/>
<xsd:enumeration value="Road Gradient"/>
<xsd:enumeration value="Route Type Suffix"/>
<xsd:enumeration value="Road with Parking Lane"/>
<xsd:enumeration value="Road with Bicycle Lane"/>
<xsd:enumeration value="Road with Sidewalk"/>
<xsd:enumeration value="Route Number Body"/>
<xsd:enumeration value="Number of Rooms"/>
<xsd:enumeration value="Passing Restrictions"/>
<xsd:enumeration value="Road Surface Condition"/>
<xsd:enumeration value="Routing Identifier"/>
<xsd:enumeration value="Routing Type"/>
<xsd:enumeration value="Routing Sequence Number"/>
<xsd:enumeration value="Route Number on Sign"/>
<xsd:enumeration value="Railway Type"/>
<xsd:enumeration value="Road and Rail Network and Associated Land Type"/>
<xsd:enumeration value="Sand Area Type"/>
<xsd:enumeration value="Structure Category"/>
<xsd:enumeration value="Suitable for Disabled or Challenged"/>
<xsd:enumeration value="Separator"/>
<xsd:enumeration value="Structure Identifier"/>
<xsd:enumeration value="Street Lighted"/>
<xsd:enumeration value="Side of Line"/>
<xsd:enumeration value="Sign Text"/>
<xsd:enumeration value="Slip Road Type"/>
<xsd:enumeration value="Settlement Type"/>
<xsd:enumeration value="Street Name"/>
<xsd:enumeration value="Speed Restrictions"/>
<xsd:enumeration value="Publicly Accessible"/>
<xsd:enumeration value="Snack Served"/>
<xsd:enumeration value="Street Type Suffix"/>
<xsd:enumeration value="Summer Time"/>
<xsd:enumeration value="Scenic Value"/>
<xsd:enumeration value="Street Type Prefix"/>
<xsd:enumeration value="Symbol on Traffic Sign"/>
<xsd:enumeration value="Time of Arrival of Flight Connection"/>
<xsd:enumeration value="Toll Point Type"/>
<xsd:enumeration value="Toll Charge"/>
<xsd:enumeration value="Time of Departure of Flight Connection"/>
<xsd:enumeration value="Time Difference of Flight Connection"/>
<xsd:enumeration value="Trailing Spaces"/>
<xsd:enumeration value="Traffic Jam Sensitivity"/>
<xsd:enumeration value="Telephone Number"/>
<xsd:enumeration value="Traffic Flow Measurement"/>
<xsd:enumeration value="Transition"/>
<xsd:enumeration value="Type of Public Transport Point"/>
<xsd:enumeration value="Toll Road"/>
<xsd:enumeration value="Traffic Sign Class"/>
<xsd:enumeration value="Travel Time"/>
<xsd:enumeration value="Traffic Flow Measurement Unit"/>
<xsd:enumeration value="Telefax Number"/>
<xsd:enumeration value="Traffic Flow Measurement Type"/>
<xsd:enumeration value="Time Zone"/>
<xsd:enumeration value="Underground Flag"/>
<xsd:enumeration value="Unpaved Road Surface Type"/>
<xsd:enumeration value="Value on traffic Sign"/>
<xsd:enumeration value="Validity Direction"/>
<xsd:enumeration value="Validity Period"/>
<xsd:enumeration value="Value on Referent"/>
<xsd:enumeration value="Vehicle Type"/>
<xsd:enumeration value="Water Boundary Element Type"/>
<xsd:enumeration value="Width"/>
<xsd:enumeration value="Water Body Type"/>
</xsd:restriction>
</xsd:simpleType>
```

13.5.138 Attribute Type Code Value (Simple)

```
<xsd:simpleType name="Attr_type_code_val">  
  <xsd:restriction base="Attr_type_code_string">  
    <xsd:enumeration value="AA"/>  
    <xsd:enumeration value="AB"/>  
    <xsd:enumeration value="AC"/>  
    <xsd:enumeration value="AD"/>  
    <xsd:enumeration value="AE"/>  
    <xsd:enumeration value="AH"/>  
    <xsd:enumeration value="AI"/>  
    <xsd:enumeration value="AL"/>  
    <xsd:enumeration value="AN"/>  
    <xsd:enumeration value="AP"/>  
    <xsd:enumeration value="AR"/>  
    <xsd:enumeration value="AS"/>  
    <xsd:enumeration value="AT"/>  
    <xsd:enumeration value="AV"/>  
    <xsd:enumeration value="AW"/>  
    <xsd:enumeration value="AY"/>  
    <xsd:enumeration value="BA"/>  
    <xsd:enumeration value="BC"/>  
    <xsd:enumeration value="BD"/>  
    <xsd:enumeration value="BE"/>  
    <xsd:enumeration value="BF"/>  
    <xsd:enumeration value="BG"/>  
    <xsd:enumeration value="BH"/>  
    <xsd:enumeration value="BI"/>  
    <xsd:enumeration value="BK"/>  
    <xsd:enumeration value="BL"/>  
    <xsd:enumeration value="BN"/>  
    <xsd:enumeration value="BO"/>  
    <xsd:enumeration value="BP"/>  
    <xsd:enumeration value="BR"/>  
    <xsd:enumeration value="BS"/>  
    <xsd:enumeration value="BT"/>  
    <xsd:enumeration value="BX"/>  
    <xsd:enumeration value="BY"/>  
    <xsd:enumeration value="CA"/>  
    <xsd:enumeration value="CC"/>  
    <xsd:enumeration value="CD"/>  
    <xsd:enumeration value="CE"/>  
    <xsd:enumeration value="CF"/>  
    <xsd:enumeration value="CH"/>  
    <xsd:enumeration value="CI"/>  
    <xsd:enumeration value="CK"/>  
    <xsd:enumeration value="CM"/>  
    <xsd:enumeration value="CP"/>  
    <xsd:enumeration value="CQ"/>  
    <xsd:enumeration value="CR"/>  
    <xsd:enumeration value="CS"/>  
    <xsd:enumeration value="CT"/>  
    <xsd:enumeration value="CU"/>  
    <xsd:enumeration value="CY"/>  
    <xsd:enumeration value="DC"/>  
    <xsd:enumeration value="DH"/>  
    <xsd:enumeration value="DI"/>  
    <xsd:enumeration value="DL"/>  
    <xsd:enumeration value="DM"/>  
    <xsd:enumeration value="DP"/>  
    <xsd:enumeration value="DR"/>  
    <xsd:enumeration value="DS"/>  
    <xsd:enumeration value="DT"/>  
    <xsd:enumeration value="DW"/>  
    <xsd:enumeration value="DX"/>  
    <xsd:enumeration value="DY"/>  
    <xsd:enumeration value="DZ"/>  
    <xsd:enumeration value="EA"/>  
    <xsd:enumeration value="EI"/>  
    <xsd:enumeration value="EN"/>  
    <xsd:enumeration value="EQ"/>  
    <xsd:enumeration value="ET"/>  
    <xsd:enumeration value="EV"/>  
    <xsd:enumeration value="FC"/>  
    <xsd:enumeration value="FF"/>  
    <xsd:enumeration value="FL"/>
```

```
<xsd:enumeration value="FP"/>
<xsd:enumeration value="FQ"/>
<xsd:enumeration value="FR"/>
<xsd:enumeration value="FS"/>
<xsd:enumeration value="FT"/>
<xsd:enumeration value="FW"/>
<xsd:enumeration value="FY"/>
<xsd:enumeration value="GA"/>
<xsd:enumeration value="GT"/>
<xsd:enumeration value="GW"/>
<xsd:enumeration value="HI"/>
<xsd:enumeration value="HL"/>
<xsd:enumeration value="HN"/>
<xsd:enumeration value="HP"/>
<xsd:enumeration value="HS"/>
<xsd:enumeration value="HT"/>
<xsd:enumeration value="ID"/>
<xsd:enumeration value="IF"/>
<xsd:enumeration value="IM"/>
<xsd:enumeration value="IR"/>
<xsd:enumeration value="JT"/>
<xsd:enumeration value="LA"/>
<xsd:enumeration value="LC"/>
<xsd:enumeration value="LD"/>
<xsd:enumeration value="LM"/>
<xsd:enumeration value="LO"/>
<xsd:enumeration value="LP"/>
<xsd:enumeration value="LR"/>
<xsd:enumeration value="LS"/>
<xsd:enumeration value="LT"/>
<xsd:enumeration value="LU"/>
<xsd:enumeration value="LV"/>
<xsd:enumeration value="MA"/>
<xsd:enumeration value="MC"/>
<xsd:enumeration value="MD"/>
<xsd:enumeration value="MH"/>
<xsd:enumeration value="MI"/>
<xsd:enumeration value="ML"/>
<xsd:enumeration value="MM"/>
<xsd:enumeration value="MN"/>
<xsd:enumeration value="MO"/>
<xsd:enumeration value="MP"/>
<xsd:enumeration value="MQ"/>
<xsd:enumeration value="MR"/>
<xsd:enumeration value="MT"/>
<xsd:enumeration value="MW"/>
<xsd:enumeration value="NA"/>
<xsd:enumeration value="NC"/>
<xsd:enumeration value="NE"/>
<xsd:enumeration value="NI"/>
<xsd:enumeration value="NO"/>
<xsd:enumeration value="NP"/>
<xsd:enumeration value="NR"/>
<xsd:enumeration value="NT"/>
<xsd:enumeration value="NV"/>
<xsd:enumeration value="NW"/>
<xsd:enumeration value="OA"/>
<xsd:enumeration value="OC"/>
<xsd:enumeration value="OF"/>
<xsd:enumeration value="ON"/>
<xsd:enumeration value="OP"/>
<xsd:enumeration value="OW"/>
<xsd:enumeration value="OY"/>
<xsd:enumeration value="PA"/>
<xsd:enumeration value="PB"/>
<xsd:enumeration value="PC"/>
<xsd:enumeration value="PD"/>
<xsd:enumeration value="PE"/>
<xsd:enumeration value="PF"/>
<xsd:enumeration value="PH"/>
<xsd:enumeration value="PI"/>
<xsd:enumeration value="PJ"/>
<xsd:enumeration value="PK"/>
<xsd:enumeration value="PL"/>
<xsd:enumeration value="PM"/>
<xsd:enumeration value="PO"/>
```

```

<xsd:enumeration value="PP"/>
<xsd:enumeration value="PQ"/>
<xsd:enumeration value="PR"/>
<xsd:enumeration value="PS"/>
<xsd:enumeration value="PT"/>
<xsd:enumeration value="PV"/>
<xsd:enumeration value="PX"/>
<xsd:enumeration value="PY"/>
<xsd:enumeration value="RA"/>
<xsd:enumeration value="RB"/>
<xsd:enumeration value="RC"/>
<xsd:enumeration value="RE"/>
<xsd:enumeration value="RF"/>
<xsd:enumeration value="RG"/>
<xsd:enumeration value="RI"/>
<xsd:enumeration value="RK"/>
<xsd:enumeration value="RL"/>
<xsd:enumeration value="RM"/>
<xsd:enumeration value="RN"/>
<xsd:enumeration value="RO"/>
<xsd:enumeration value="RP"/>
<xsd:enumeration value="RR"/>
<xsd:enumeration value="RS"/>
<xsd:enumeration value="RT"/>
<xsd:enumeration value="RU"/>
<xsd:enumeration value="RX"/>
<xsd:enumeration value="RY"/>
<xsd:enumeration value="RZ"/>
<xsd:enumeration value="SA"/>
<xsd:enumeration value="SC"/>
<xsd:enumeration value="SD"/>
<xsd:enumeration value="SE"/>
<xsd:enumeration value="SF"/>
<xsd:enumeration value="SG"/>
<xsd:enumeration value="SI"/>
<xsd:enumeration value="SJ"/>
<xsd:enumeration value="SL"/>
<xsd:enumeration value="SM"/>
<xsd:enumeration value="SN"/>
<xsd:enumeration value="SP"/>
<xsd:enumeration value="SR"/>
<xsd:enumeration value="SS"/>
<xsd:enumeration value="ST"/>
<xsd:enumeration value="SU"/>
<xsd:enumeration value="SV"/>
<xsd:enumeration value="SX"/>
<xsd:enumeration value="SY"/>
<xsd:enumeration value="TA"/>
<xsd:enumeration value="TB"/>
<xsd:enumeration value="TC"/>
<xsd:enumeration value="TD"/>
<xsd:enumeration value="TF"/>
<xsd:enumeration value="TI"/>
<xsd:enumeration value="TJ"/>
<xsd:enumeration value="TL"/>
<xsd:enumeration value="TM"/>
<xsd:enumeration value="TN"/>
<xsd:enumeration value="TP"/>
<xsd:enumeration value="TR"/>
<xsd:enumeration value="TS"/>
<xsd:enumeration value="TT"/>
<xsd:enumeration value="TU"/>
<xsd:enumeration value="TX"/>
<xsd:enumeration value="TY"/>
<xsd:enumeration value="TZ"/>
<xsd:enumeration value="UF"/>
<xsd:enumeration value="UR"/>
<xsd:enumeration value="VA"/>
<xsd:enumeration value="VD"/>
<xsd:enumeration value="VP"/>
<xsd:enumeration value="VR"/>
<xsd:enumeration value="VT"/>
<xsd:enumeration value="WB"/>
<xsd:enumeration value="WI"/>
<xsd:enumeration value="WT"/>
</xsd:restriction>
</xsd:simpleType>

```

13.5.139 Attribute Type Data Type Code (Simple)

```
<xsd:simpleType name="Attr_type_code_type">  
  <xsd:restriction base="xsd:string">  
    <xsd:enumeration value="COD"/>  
    <xsd:enumeration value="BMI"/>  
    <xsd:enumeration value="TXT"/>  
    <xsd:enumeration value="COD"/>  
    <xsd:enumeration value="BOL"/>  
    <xsd:enumeration value="BOL"/>  
    <xsd:enumeration value="COD_external"/>  
    <xsd:enumeration value="TXT"/>  
    <xsd:enumeration value="TXT"/>  
    <xsd:enumeration value="MSR"/>  
    <xsd:enumeration value="BOL"/>  
    <xsd:enumeration value="MSR"/>  
    <xsd:enumeration value="TMR"/>  
    <xsd:enumeration value="BOL"/>  
    <xsd:enumeration value="MSR"/>  
    <xsd:enumeration value="COD"/>  
    <xsd:enumeration value="BOL"/>  
    <xsd:enumeration value="TXT"/>  
    <xsd:enumeration value="COD"/>  
    <xsd:enumeration value="COD"/>  
    <xsd:enumeration value="TXT"/>  
    <xsd:enumeration value="COD"/>  
    <xsd:enumeration value="MSR"/>  
    <xsd:enumeration value="MSR"/>  
    <xsd:enumeration value="TXT"/>  
    <xsd:enumeration value="BOL"/>  
    <xsd:enumeration value="TXT"/>  
    <xsd:enumeration value="COD"/>  
    <xsd:enumeration value="COD"/>  
    <xsd:enumeration value="BOL"/>  
    <xsd:enumeration value="CNT"/>  
    <xsd:enumeration value="COD"/>  
    <xsd:enumeration value="ENM"/>  
    <xsd:enumeration value="ENM"/>  
    <xsd:enumeration value="BMR"/>  
    <xsd:enumeration value="ENM"/>  
    <xsd:enumeration value="COD"/>  
    <xsd:enumeration value="ENM"/>  
    <xsd:enumeration value="ENM"/>  
    <xsd:enumeration value="MSR"/>  
    <xsd:enumeration value="CNT"/>  
    <xsd:enumeration value="CNT"/>  
    <xsd:enumeration value="BOL"/>  
    <xsd:enumeration value="COD"/>  
    <xsd:enumeration value="CNT"/>  
    <xsd:enumeration value="BOL"/>  
    <xsd:enumeration value="COD"/>  
    <xsd:enumeration value="TXT"/>  
    <xsd:enumeration value="TXT"/>  
    <xsd:enumeration value="ENM"/>  
    <xsd:enumeration value="TXT"/>  
    <xsd:enumeration value="MSR"/>  
    <xsd:enumeration value="BMI"/>  
    <xsd:enumeration value="TXT"/>  
    <xsd:enumeration value="COD"/>  
    <xsd:enumeration value="TXT"/>  
    <xsd:enumeration value="BOL"/>  
    <xsd:enumeration value="TXT"/>  
    <xsd:enumeration value="COD"/>  
    <xsd:enumeration value="MSR"/>  
    <xsd:enumeration value="COD"/>  
    <xsd:enumeration value="COD"/>  
    <xsd:enumeration value="COD"/>  
    <xsd:enumeration value="COD"/>  
    <xsd:enumeration value="TXT"/>  
    <xsd:enumeration value="SCS"/>  
    <xsd:enumeration value="TXT"/>  
    <xsd:enumeration value="COD"/>  
    <xsd:enumeration value="COD"/>  
    <xsd:enumeration value="COD"/>  
    <xsd:enumeration value="COD"/>  
    <xsd:enumeration value="SCS"/>
```

```

<xsd:enumeration value="BMI" />
<xsd:enumeration value="COD" />
<xsd:enumeration value="TMR" />
<xsd:enumeration value="CNT" />
<xsd:enumeration value="COD" />
<xsd:enumeration value="COD" />
<xsd:enumeration value="BOL" />
<xsd:enumeration value="BOL" />
<xsd:enumeration value="COD" />
<xsd:enumeration value="COD" />
<xsd:enumeration value="SCS" />
<xsd:enumeration value="SCS" />
<xsd:enumeration value="SCS" />
<xsd:enumeration value="MSR" />
<xsd:enumeration value="COD" />
<xsd:enumeration value="COD" />
<xsd:enumeration value="SCS" />
<xsd:enumeration value="COD" />
<xsd:enumeration value="COD" />
<xsd:enumeration value="PRS" />
<xsd:enumeration value="COD" />
<xsd:enumeration value="COD" />
<xsd:enumeration value="TXT" />
<xsd:enumeration value="SCS" />
<xsd:enumeration value="MSR" />
<xsd:enumeration value="CNT" />
<xsd:enumeration value="COD" />
<xsd:enumeration value="MSR" />
<xsd:enumeration value="COD" />
<xsd:enumeration value="COD" />
<xsd:enumeration value="TXT" />
<xsd:enumeration value="COD" />
<xsd:enumeration value="BOL" />
<xsd:enumeration value="COD_user_defined" />
<xsd:enumeration value="COD" />
<xsd:enumeration value="MSR" />
<xsd:enumeration value="CNT" />
<xsd:enumeration value="MSR" />
<xsd:enumeration value="TMR" />
<xsd:enumeration value="TXT" />
<xsd:enumeration value="CNT" />
<xsd:enumeration value="BOL" />
<xsd:enumeration value="COD_external" />
<xsd:enumeration value="BOL" />
<xsd:enumeration value="MSR" />
<xsd:enumeration value="MSR" />
<xsd:enumeration value="COD" />
<xsd:enumeration value="CNT" />
<xsd:enumeration value="TXT" />
<xsd:enumeration value="COD" />
<xsd:enumeration value="CNT" />
<xsd:enumeration value="TXT" />
<xsd:enumeration value="COD" />
<xsd:enumeration value="COD" />
<xsd:enumeration value="COD" />
<xsd:enumeration value="COD" />
<xsd:enumeration value="COD" />
<xsd:enumeration value="SCS" />
<xsd:enumeration value="TXT" />
<xsd:enumeration value="TXT" />
<xsd:enumeration value="TMR" />
<xsd:enumeration value="COD" />
<xsd:enumeration value="ENM" />
<xsd:enumeration value="BOL" />
<xsd:enumeration value="TXT" />
<xsd:enumeration value="COD" />
<xsd:enumeration value="ENM" />
<xsd:enumeration value="TXT" />
<xsd:enumeration value="CNT" />
<xsd:enumeration value="COD" />
<xsd:enumeration value="PRC" />
<xsd:enumeration value="COD" />
<xsd:enumeration value="BOL" />
<xsd:enumeration value="COD" />
<xsd:enumeration value="COD" />
<xsd:enumeration value="CNT" />

```

```
<xsd:enumeration value="COD"/>
<xsd:enumeration value="TXT"/>
<xsd:enumeration value="COD"/>
<xsd:enumeration value="SCS"/>
<xsd:enumeration value="COD"/>
<xsd:enumeration value="COD"/>
<xsd:enumeration value="COD"/>
<xsd:enumeration value="BOL"/>
<xsd:enumeration value="COD"/>
<xsd:enumeration value="COD"/>
<xsd:enumeration value="COD"/>
<xsd:enumeration value="TXT"/>
<xsd:enumeration value="BOL"/>
<xsd:enumeration value="PRS"/>
<xsd:enumeration value="TXT"/>
<xsd:enumeration value="BOL"/>
<xsd:enumeration value="BOL"/>
<xsd:enumeration value="BOL"/>
<xsd:enumeration value="TXT"/>
<xsd:enumeration value="CNT"/>
<xsd:enumeration value="BOL"/>
<xsd:enumeration value="COD"/>
<xsd:enumeration value="TXT"/>
<xsd:enumeration value="COD"/>
<xsd:enumeration value="CNT"/>
<xsd:enumeration value="TXT"/>
<xsd:enumeration value="COD"/>
<xsd:enumeration value="COD"/>
<xsd:enumeration value="COD"/>
<xsd:enumeration value="COD"/>
<xsd:enumeration value="BOL"/>
<xsd:enumeration value="SCS"/>
<xsd:enumeration value="TXT"/>
<xsd:enumeration value="BOL"/>
<xsd:enumeration value="ENM"/>
<xsd:enumeration value="TXT"/>
<xsd:enumeration value="COD"/>
<xsd:enumeration value="COD"/>
<xsd:enumeration value="TXT"/>
<xsd:enumeration value="MSR"/>
<xsd:enumeration value="BOL"/>
<xsd:enumeration value="BOL"/>
<xsd:enumeration value="TXT"/>
<xsd:enumeration value="MSR"/>
<xsd:enumeration value="BOL"/>
<xsd:enumeration value="TXT"/>
<xsd:enumeration value="COD"/>
<xsd:enumeration value="TMR"/>
<xsd:enumeration value="COD"/>
<xsd:enumeration value="CNT"/>
<xsd:enumeration value="TMR"/>
<xsd:enumeration value="TMR"/>
<xsd:enumeration value="ENM"/>
<xsd:enumeration value="COD"/>
<xsd:enumeration value="SCS"/>
<xsd:enumeration value="CNT"/>
<xsd:enumeration value="COD"/>
<xsd:enumeration value="COD"/>
<xsd:enumeration value="BOL"/>
<xsd:enumeration value="COD"/>
<xsd:enumeration value="TMR"/>
<xsd:enumeration value="TMR"/>
<xsd:enumeration value="SCS"/>
<xsd:enumeration value="COD"/>
<xsd:enumeration value="CNT"/>
<xsd:enumeration value="COD"/>
<xsd:enumeration value="COD"/>
<xsd:enumeration value="MSR"/>
<xsd:enumeration value="ENM"/>
<xsd:enumeration value="TMR"/>
<xsd:enumeration value="TXT"/>
<xsd:enumeration value="COD"/>
<xsd:enumeration value="COD"/>
<xsd:enumeration value="MSR"/>
<xsd:enumeration value="COD"/>
</xsd:restriction>
</xsd:simpleType>
```

13.5.140 Attribute Type Code Definition (Simple)

```
<xsd:simpleType name="Attr_type_code_def">
  <xsd:restriction base="xsd:string">
    <xsd:enumeration value="Attr_AA_CODE"/>
    <xsd:enumeration value="Attr_AB_BMI"/>
    <xsd:enumeration value="03"/>
    <xsd:enumeration value="Attr_AD_CODE"/>
    <xsd:enumeration value="05"/>
    <xsd:enumeration value="06"/>
    <xsd:enumeration value="07"/>
    <xsd:enumeration value="08"/>
    <xsd:enumeration value="09"/>
    <xsd:enumeration value="10"/>
    <xsd:enumeration value="11"/>
    <xsd:enumeration value="12"/>
    <xsd:enumeration value="13"/>
    <xsd:enumeration value="14"/>
    <xsd:enumeration value="15"/>
    <xsd:enumeration value="Attr_AY_CODE"/>
    <xsd:enumeration value="17"/>
    <xsd:enumeration value="18"/>
    <xsd:enumeration value="Attr_BD_CODE"/>
    <xsd:enumeration value="Attr_BE_CODE"/>
    <xsd:enumeration value="21"/>
    <xsd:enumeration value="Attr_BG_CODE"/>
    <xsd:enumeration value="23"/>
    <xsd:enumeration value="24"/>
    <xsd:enumeration value="25"/>
    <xsd:enumeration value="26"/>
    <xsd:enumeration value="27"/>
    <xsd:enumeration value="Attr_BO_CODE"/>
    <xsd:enumeration value="Attr_BP_CODE"/>
    <xsd:enumeration value="30"/>
    <xsd:enumeration value="31"/>
    <xsd:enumeration value="Attr_BT_CODE"/>
    <xsd:enumeration value="Attr_BX_ENUM"/>
    <xsd:enumeration value="Attr_BY_ENUM"/>
    <xsd:enumeration value="35"/>
    <xsd:enumeration value="Attr_CC_ENUM"/>
    <xsd:enumeration value="Attr_CD_CODE"/>
    <xsd:enumeration value="Attr_CE_ENUM"/>
    <xsd:enumeration value="Attr_CF_ENUM"/>
    <xsd:enumeration value="40"/>
    <xsd:enumeration value="41"/>
    <xsd:enumeration value="42"/>
    <xsd:enumeration value="43"/>
    <xsd:enumeration value="Attr_CP_CODE"/>
    <xsd:enumeration value="45"/>
    <xsd:enumeration value="46"/>
    <xsd:enumeration value="Attr_CS_CODE"/>
    <xsd:enumeration value="48"/>
    <xsd:enumeration value="49"/>
    <xsd:enumeration value="Attr_CY_ENUM"/>
    <xsd:enumeration value="51"/>
    <xsd:enumeration value="52"/>
    <xsd:enumeration value="Attr_DI_BMI"/>
    <xsd:enumeration value="54"/>
    <xsd:enumeration value="Attr_DM_CODE"/>
    <xsd:enumeration value="56"/>
    <xsd:enumeration value="57"/>
    <xsd:enumeration value="58"/>
    <xsd:enumeration value="Attr_DT_CODE"/>
    <xsd:enumeration value="60"/>
    <xsd:enumeration value="Attr_DX_CODE"/>
    <xsd:enumeration value="Attr_DY_CODE"/>
    <xsd:enumeration value="Attr_DZ_CODE"/>
    <xsd:enumeration value="Attr_EA_CODE"/>
    <xsd:enumeration value="65"/>
    <xsd:enumeration value="66"/>
    <xsd:enumeration value="67"/>
    <xsd:enumeration value="Attr_ET_CODE"/>
    <xsd:enumeration value="Attr_EV_CODE"/>
    <xsd:enumeration value="Attr_FC_CODE"/>
    <xsd:enumeration value="Attr_FF_CODE"/>
    <xsd:enumeration value="72"/>
  </xsd:restriction>
</xsd:simpleType>
```



```
<xsd:enumeration value="Attr_FP_BMI" />
<xsd:enumeration value="Attr_FQ_CODE" />
<xsd:enumeration value="75" />
<xsd:enumeration value="76" />
<xsd:enumeration value="Attr_FT_CODE" />
<xsd:enumeration value="Attr_FW_CODE" />
<xsd:enumeration value="79" />
<xsd:enumeration value="80" />
<xsd:enumeration value="Attr_GT_CODE" />
<xsd:enumeration value="Attr_GW_CODE" />
<xsd:enumeration value="83" />
<xsd:enumeration value="84" />
<xsd:enumeration value="85" />
<xsd:enumeration value="86" />
<xsd:enumeration value="Attr_HS_CODE" />
<xsd:enumeration value="Attr_HT_CODE" />
<xsd:enumeration value="89" />
<xsd:enumeration value="Attr_IF_CODE" />
<xsd:enumeration value="Attr_IM_CODE" />
<xsd:enumeration value="92" />
<xsd:enumeration value="Attr_JT_CODE" />
<xsd:enumeration value="Attr_LA_CODE" />
<xsd:enumeration value="95" />
<xsd:enumeration value="96" />
<xsd:enumeration value="97" />
<xsd:enumeration value="98" />
<xsd:enumeration value="Lang_code_value" />
<xsd:enumeration value="100" />
<xsd:enumeration value="Attr_LS_CODE" />
<xsd:enumeration value="Attr_LT_CODE" />
<xsd:enumeration value="103" />
<xsd:enumeration value="Attr_LV_CODE" />
<xsd:enumeration value="105" />
<xsd:enumeration value="106" />
<xsd:enumeration value="Attr_MD_CODE" />
<xsd:enumeration value="108" />
<xsd:enumeration value="109" />
<xsd:enumeration value="110" />
<xsd:enumeration value="111" />
<xsd:enumeration value="112" />
<xsd:enumeration value="113" />
<xsd:enumeration value="114" />
<xsd:enumeration value="115" />
<xsd:enumeration value="116" />
<xsd:enumeration value="117" />
<xsd:enumeration value="118" />
<xsd:enumeration value="Attr_NA_CODE" />
<xsd:enumeration value="120" />
<xsd:enumeration value="121" />
<xsd:enumeration value="Attr_NI_CODE" />
<xsd:enumeration value="123" />
<xsd:enumeration value="124" />
<xsd:enumeration value="Attr_NR_CODE" />
<xsd:enumeration value="Attr_NT_CODE" />
<xsd:enumeration value="Attr_NV_CODE" />
<xsd:enumeration value="Attr_NW_CODE" />
<xsd:enumeration value="Attr_OA_CODE" />
<xsd:enumeration value="130" />
<xsd:enumeration value="131" />
<xsd:enumeration value="132" />
<xsd:enumeration value="133" />
<xsd:enumeration value="Attr_OW_CODE" />
<xsd:enumeration value="Attr_OY_ENUM" />
<xsd:enumeration value="136" />
<xsd:enumeration value="137" />
<xsd:enumeration value="Attr_PC_CODE" />
<xsd:enumeration value="Attr_PD_ENUM" />
<xsd:enumeration value="140" />
<xsd:enumeration value="141" />
<xsd:enumeration value="Attr_PH_CODE" />
<xsd:enumeration value="143" />
<xsd:enumeration value="Attr_PJ_CODE" />
<xsd:enumeration value="145" />
<xsd:enumeration value="Attr_PL_CODE" />
<xsd:enumeration value="Attr_PM_CODE" />
<xsd:enumeration value="148" />
```



```
<xsd:enumeration value="Attr_PP_CODE"/>
<xsd:enumeration value="150"/>
<xsd:enumeration value="Attr_PR_CODE"/>
<xsd:enumeration value="152"/>
<xsd:enumeration value="Attr_PT_CODE"/>
<xsd:enumeration value="Attr_PV_CODE"/>
<xsd:enumeration value="Attr_PX_CODE"/>
<xsd:enumeration value="156"/>
<xsd:enumeration value="Attr_RA_CODE"/>
<xsd:enumeration value="Attr_RB_CODE"/>
<xsd:enumeration value="Attr_RC_CODE"/>
<xsd:enumeration value="160"/>
<xsd:enumeration value="161"/>
<xsd:enumeration value="162"/>
<xsd:enumeration value="163"/>
<xsd:enumeration value="164"/>
<xsd:enumeration value="165"/>
<xsd:enumeration value="166"/>
<xsd:enumeration value="167"/>
<xsd:enumeration value="168"/>
<xsd:enumeration value="169"/>
<xsd:enumeration value="Attr_RR_CODE"/>
<xsd:enumeration value="171"/>
<xsd:enumeration value="Attr_RT_CODE"/>
<xsd:enumeration value="173"/>
<xsd:enumeration value="174"/>
<xsd:enumeration value="Attr_RY_CODE"/>
<xsd:enumeration value="Attr_RZ_CODE"/>
<xsd:enumeration value="Attr_SA_CODE"/>
<xsd:enumeration value="Attr_SC_CODE"/>
<xsd:enumeration value="179"/>
<xsd:enumeration value="180"/>
<xsd:enumeration value="181"/>
<xsd:enumeration value="182"/>
<xsd:enumeration value="Attr_SI_ENUM"/>
<xsd:enumeration value="184"/>
<xsd:enumeration value="Attr_SL_CODE"/>
<xsd:enumeration value="Attr_SM_CODE"/>
<xsd:enumeration value="187"/>
<xsd:enumeration value="188"/>
<xsd:enumeration value="189"/>
<xsd:enumeration value="190"/>
<xsd:enumeration value="191"/>
<xsd:enumeration value="192"/>
<xsd:enumeration value="193"/>
<xsd:enumeration value="194"/>
<xsd:enumeration value="Attr_SY_CODE"/>
<xsd:enumeration value="196"/>
<xsd:enumeration value="Attr_TB_CODE"/>
<xsd:enumeration value="198"/>
<xsd:enumeration value="199"/>
<xsd:enumeration value="200"/>
<xsd:enumeration value="Attr_TI_ENUM"/>
<xsd:enumeration value="Attr_TJ_CODE"/>
<xsd:enumeration value="203"/>
<xsd:enumeration value="204"/>
<xsd:enumeration value="Attr_TN_CODE"/>
<xsd:enumeration value="Attr_TP_CODE"/>
<xsd:enumeration value="207"/>
<xsd:enumeration value="Attr_TP_CODE"/>
<xsd:enumeration value="209"/>
<xsd:enumeration value="210"/>
<xsd:enumeration value="211"/>
<xsd:enumeration value="Attr_TY_CODE"/>
<xsd:enumeration value="213"/>
<xsd:enumeration value="Attr_UF_CODE"/>
<xsd:enumeration value="Attr_UR_CODE"/>
<xsd:enumeration value="216"/>
<xsd:enumeration value="Attr_VD_ENUM"/>
<xsd:enumeration value="218"/>
<xsd:enumeration value="219"/>
<xsd:enumeration value="Attr_VT_CODE"/>
<xsd:enumeration value="Attr_WB_CODE"/>
<xsd:enumeration value="222"/>
<xsd:enumeration value="Attr_WT_CODE"/>
</xsd:restriction>
</xsd:simpleType>
```

13.5.141 Attribute Type Code Definition Reference

```
<xsd:complexType name="Attr_typ_cod_def_ref">
  <xsd:choice>
    <xsd:element name="Attr_AA_CODE" type="Attr_AA_CODE" />
    <xsd:element name="Attr_AB_BMI" type="Attr_AB_BMI" />
    <xsd:element name="AC_TXT" />
    <xsd:element name="Attr_AD_CODE" type="Attr_AD_CODE" />
    <xsd:element name="AE_BOL" />
    <xsd:element name="AH_BOL" />
    <xsd:element name="AI_CODE_external" />
    <xsd:element name="AL_TXT" />
    <xsd:element name="AN_TXT" />
    <xsd:element name="AP_MSR" />
    <xsd:element name="AR_BOL" />
    <xsd:element name="AS_MSR" />
    <xsd:element name="AT_TMR" />
    <xsd:element name="AV_BOL" />
    <xsd:element name="AW_MSR" />
    <xsd:element name="Attr_AY_CODE" type="Attr_AY_CODE" />
    <xsd:element name="BA_BOL" />
    <xsd:element name="BC_TXT" />
    <xsd:element name="Attr_BD_CODE" type="Attr_BD_CODE" />
    <xsd:element name="Attr_BE_CODE" type="Attr_BE_CODE" />
    <xsd:element name="BF_TXT" />
    <xsd:element name="Attr_BG_CODE" type="Attr_BG_CODE" />
    <xsd:element name="BH_MSR" />
    <xsd:element name="BI_MSR" />
    <xsd:element name="BK_TXT" />
    <xsd:element name="BL_BOL" />
    <xsd:element name="BN_TXT" />
    <xsd:element name="Attr_BO_CODE" type="Attr_BO_CODE" />
    <xsd:element name="Attr_BP_CODE" type="Attr_BP_CODE" />
    <xsd:element name="BR_BOL" />
    <xsd:element name="BS_CNT" />
    <xsd:element name="Attr_BT_CODE" type="Attr_BT_CODE" />
    <xsd:element name="Attr_BX_ENUM" type="Attr_BX_ENUM" />
    <xsd:element name="Attr_BY_ENUM" type="Attr_BY_ENUM" />
    <xsd:element name="CA_BMR" />
    <xsd:element name="Attr_CC_ENUM" type="Attr_CC_ENUM" />
    <xsd:element name="Attr_CD_CODE" type="Attr_CD_CODE" />
    <xsd:element name="Attr_CE_ENUM" type="Attr_CE_ENUM" />
    <xsd:element name="Attr_CF_ENUM" type="Attr_CF_ENUM" />
    <xsd:element name="CH_MSR" />
    <xsd:element name="CI_CNT" />
    <xsd:element name="CK_CNT" />
    <xsd:element name="CM_BOL" />
    <xsd:element name="Attr_CP_CODE" type="Attr_CP_CODE" />
    <xsd:element name="CQ_CNT" />
    <xsd:element name="CR_BOL" />
    <xsd:element name="Attr_CS_CODE" type="Attr_CS_CODE" />
    <xsd:element name="CT_TXT" />
    <xsd:element name="CU_TXT" />
    <xsd:element name="Attr_CY_ENUM" type="Attr_CY_ENUM" />
    <xsd:element name="DC_TXT" />
    <xsd:element name="DH_MSR" />
    <xsd:element name="Attr_DI_BMI" type="Attr_DI_BMI" />
    <xsd:element name="DL_TXT" />
    <xsd:element name="Attr_DM_CODE" type="Attr_DM_CODE" />
    <xsd:element name="DP_TXT" />
    <xsd:element name="DR_BOL" />
    <xsd:element name="DS_TXT" />
    <xsd:element name="Attr_DT_CODE" type="Attr_DT_CODE" />
    <xsd:element name="DW_MSR" />
    <xsd:element name="Attr_DX_CODE" type="Attr_DX_CODE" />
    <xsd:element name="Attr_DY_CODE" type="Attr_DY_CODE" />
    <xsd:element name="Attr_DZ_CODE" type="Attr_DZ_CODE" />
    <xsd:element name="Attr_EA_CODE" type="Attr_EA_CODE" />
    <xsd:element name="EI_TXT" />
    <xsd:element name="EN_SCS" />
    <xsd:element name="EQ_TXT" />
    <xsd:element name="Attr_ET_CODE" type="Attr_ET_CODE" />
    <xsd:element name="Attr_EV_CODE" type="Attr_EV_CODE" />
    <xsd:element name="Attr_FC_CODE" type="Attr_FC_CODE" />
    <xsd:element name="Attr_FF_CODE" type="Attr_FF_CODE" />
    <xsd:element name="FL_SCS" />
  </xsd:choice>
</xsd:complexType>
```

```

<xsd:element name="Attr_FP_BMI" type="Attr_FP_BMI" />
<xsd:element name="Attr_FQ_CODE" type="Attr_FQ_CODE" />
<xsd:element name="FR_TMR" />
<xsd:element name="FS_CNT" />
<xsd:element name="Attr_FT_CODE" type="Attr_FT_CODE" />
<xsd:element name="Attr_FW_CODE" type="Attr_FW_CODE" />
<xsd:element name="FY_BOL" />
<xsd:element name="GA_BOL" />
<xsd:element name="Attr_GT_CODE" type="Attr_GT_CODE" />
<xsd:element name="Attr_GW_CODE" type="Attr_GW_CODE" />
<xsd:element name="HI_SCS" />
<xsd:element name="HL_SCS" />
<xsd:element name="HN_SCS" />
<xsd:element name="HP_MSR" />
<xsd:element name="Attr_HS_CODE" type="Attr_HS_CODE" />
<xsd:element name="Attr_HT_CODE" type="Attr_HT_CODE" />
<xsd:element name="ID_SCS" />
<xsd:element name="Attr_IF_CODE" type="Attr_IF_CODE" />
<xsd:element name="Attr_IM_CODE" type="Attr_IM_CODE" />
<xsd:element name="IR_PRS" />
<xsd:element name="Attr_JT_CODE" type="Attr_JT_CODE" />
<xsd:element name="Attr_LA_CODE" type="Attr_LA_CODE" />
<xsd:element name="LC_TXT" />
<xsd:element name="LD_SCS" />
<xsd:element name="LM_MSR" />
<xsd:element name="LO_CNT" />
<xsd:element name="LP_Lang_code_value" type="Lan_cod" />
<xsd:element name="LR_MSR" />
<xsd:element name="Attr_LS_CODE" type="Attr_LS_CODE" />
<xsd:element name="Attr_LT_CODE" type="Attr_LT_CODE" />
<xsd:element name="LU_TXT" />
<xsd:element name="Attr_LV_CODE" type="Attr_LV_CODE" />
<xsd:element name="MA_BOL" />
<xsd:element name="MC_CODE_external" />
<xsd:element name="Attr_MD_CODE" type="Attr_MD_CODE" />
<xsd:element name="MH_MSR" />
<xsd:element name="MI_CNT" />
<xsd:element name="ML_MSR" />
<xsd:element name="MM_TMR" />
<xsd:element name="MN_TXT" />
<xsd:element name="MO_CNT" />
<xsd:element name="MP_BOL" />
<xsd:element name="MQ_CODE_external" />
<xsd:element name="MR_BOL" />
<xsd:element name="MT_MSR" />
<xsd:element name="MW_MSR" />
<xsd:element name="Attr_NA_CODE" type="Attr_NA_CODE" />
<xsd:element name="NC_CNT" />
<xsd:element name="NE_TXT" />
<xsd:element name="Attr_NI_CODE" type="Attr_NI_CODE" />
<xsd:element name="NO_CNT" />
<xsd:element name="NP_TXT" />
<xsd:element name="Attr_NR_CODE" type="Attr_NR_CODE" />
<xsd:element name="Attr_NT_CODE" type="Attr_NT_CODE" />
<xsd:element name="Attr_NV_CODE" type="Attr_NV_CODE" />
<xsd:element name="Attr_NW_CODE" type="Attr_NW_CODE" />
<xsd:element name="Attr_OA_CODE" type="Attr_OA_CODE" />
<xsd:element name="OC_SCS" />
<xsd:element name="OF_TXT" />
<xsd:element name="ON_TXT" />
<xsd:element name="OP_TMR" />
<xsd:element name="Attr_OW_CODE" type="Attr_OW_CODE" />
<xsd:element name="Attr_OY_ENUM" type="Attr_OY_ENUM" />
<xsd:element name="PA_BOL" />
<xsd:element name="PB_TXT" />
<xsd:element name="Attr_PC_CODE" type="Attr_PC_CODE" />
<xsd:element name="Attr_PD_ENUM" type="Attr_PD_ENUM" />
<xsd:element name="PE_TXT" />
<xsd:element name="PF_CNT" />
<xsd:element name="Attr_PH_CODE" type="Attr_PH_CODE" />
<xsd:element name="PF_PRC" />
<xsd:element name="Attr_PJ_CODE" type="Attr_PJ_CODE" />
<xsd:element name="PK_BOL" />
<xsd:element name="Attr_PL_CODE" type="Attr_PL_CODE" />
<xsd:element name="Attr_PM_CODE" type="Attr_PM_CODE" />
<xsd:element name="PO_CNT" />
<xsd:element name="Attr_PP_CODE" type="Attr_PP_CODE" />

```

```

<xsd:element name="PQ_TXT" />
<xsd:element name="Attr_PR_CODE" type="Attr_PR_CODE" />
<xsd:element name="PS_SCS" />
<xsd:element name="Attr_PT_CODE" type="Attr_PT_CODE" />
<xsd:element name="Attr_PV_CODE" type="Attr_PV_CODE" />
<xsd:element name="Attr_PX_CODE" type="Attr_PX_CODE" />
<xsd:element name="PY_BOL" />
<xsd:element name="Attr_RA_CODE" type="Attr_RA_CODE" />
<xsd:element name="Attr_RB_CODE" type="Attr_RB_CODE" />
<xsd:element name="Attr_RC_CODE" type="Attr_RC_CODE" />
<xsd:element name="RE_TXT" />
<xsd:element name="RF_BOL" />
<xsd:element name="RG_PRS" />
<xsd:element name="RI_TXT" />
<xsd:element name="RK_BOL" />
<xsd:element name="RL_BOL" />
<xsd:element name="RM_BOL" />
<xsd:element name="RN_TXT" />
<xsd:element name="RO_CNT" />
<xsd:element name="RP_BOL" />
<xsd:element name="Attr_RR_CODE" type="Attr_RR_CODE" />
<xsd:element name="RS_TXT" />
<xsd:element name="Attr_RT_CODE" type="Attr_RT_CODE" />
<xsd:element name="RU_CNT" />
<xsd:element name="RX_TXT" />
<xsd:element name="Attr_RY_CODE" type="Attr_RY_CODE" />
<xsd:element name="Attr_RZ_CODE" type="Attr_RZ_CODE" />
<xsd:element name="Attr_SA_CODE" type="Attr_SA_CODE" />
<xsd:element name="Attr_SC_CODE" type="Attr_SC_CODE" />
<xsd:element name="SD_BOL" />
<xsd:element name="SE_SCS" />
<xsd:element name="SF_TXT" />
<xsd:element name="SG_BOL" />
<xsd:element name="Attr_SI_ENUM" type="Attr_SI_ENUM" />
<xsd:element name="SJ_TXT" />
<xsd:element name="Attr_SL_CODE" type="Attr_SL_CODE" />
<xsd:element name="Attr_SM_CODE" type="Attr_SM_CODE" />
<xsd:element name="SN_TXT" />
<xsd:element name="SN_MSR" />
<xsd:element name="SP_BOL" />
<xsd:element name="SR_BOL" />
<xsd:element name="SS_TXT" />
<xsd:element name="ST_MSR" />
<xsd:element name="SU_BOL" />
<xsd:element name="SV_BOL" />
<xsd:element name="SX_TXT" />
<xsd:element name="Attr_SY_CODE" type="Attr_SY_CODE" />
<xsd:element name="TA_TMR" />
<xsd:element name="Attr_TB_CODE" type="Attr_TB_CODE" />
<xsd:element name="TC_CNT" />
<xsd:element name="TD_TMR" />
<xsd:element name="TF_TMR" />
<xsd:element name="Attr_TI_ENUM" type="Attr_TI_ENUM" />
<xsd:element name="Attr_TJ_CODE" type="Attr_TJ_CODE" />
<xsd:element name="TL_SCS" />
<xsd:element name="TM_CNT" />
<xsd:element name="Attr_TN_CODE" type="Attr_TN_CODE" />
<xsd:element name="Attr_TP_CODE" type="Attr_TP_CODE" />
<xsd:element name="TR_BOL" />
<xsd:element name="Attr_TS_CODE" type="Attr_TS_CODE" />
<xsd:element name="TT_TMR" />
<xsd:element name="TU_TMR" />
<xsd:element name="TX_SCS" />
<xsd:element name="Attr_TY_CODE" type="Attr_TY_CODE" />
<xsd:element name="TZ_CNT" />
<xsd:element name="Attr_UF_CODE" type="Attr_UF_CODE" />
<xsd:element name="Attr_UR_CODE" type="Attr_UR_CODE" />
<xsd:element name="VA_MSR" />
<xsd:element name="Attr_VD_ENUM" type="Attr_VD_ENUM" />
<xsd:element name="VP_TMR" />
<xsd:element name="VR_TXT" />
<xsd:element name="Attr_VT_CODE" type="Attr_VT_CODE" />
<xsd:element name="Attr_WB_CODE" type="Attr_WB_CODE" />
<xsd:element name="WI_MSR" />
<xsd:element name="Attr_WT_CODE" type="Attr_WT_CODE" />
</xsd:choice>
</xsd:complexType>

```

13.5.142 Boolean Name (Simple)

```
<xsd:simpleType name="Bool_name">
  <xsd:restriction base="xsd:string">
    <xsd:enumeration value="false"/>
    <xsd:enumeration value="true"/>
  </xsd:restriction>
</xsd:simpleType>
```

13.5.143 Coordinate Type Name (Simple)

```
<xsd:simpleType name="Coord_type_name">
  <xsd:restriction base="xsd:string">
    <xsd:enumeration value="lat/long"/>
    <xsd:enumeration value="x/y"/>
  </xsd:restriction>
</xsd:simpleType>
```

13.5.144 Country Code Name (Simple)

```
<xsd:simpleType name="Cntry_code_name">
  <xsd:restriction base="xsd:string">
    <xsd:enumeration value="Afghanistan"/>
    <xsd:enumeration value="Albania"/>
    <xsd:enumeration value="Algeria"/>
    <xsd:enumeration value="American Samoa"/>
    <xsd:enumeration value="Andorra"/>
    <xsd:enumeration value="Angola"/>
    <xsd:enumeration value="Anguilla"/>
    <xsd:enumeration value="Antigua and Barbuda"/>
    <xsd:enumeration value="Argentina"/>
    <xsd:enumeration value="Armenia"/>
    <xsd:enumeration value="Aruba"/>
    <xsd:enumeration value="Australia"/>
    <xsd:enumeration value="Austria"/>
    <xsd:enumeration value="Azerbaijan"/>
    <xsd:enumeration value="Bahamas"/>
    <xsd:enumeration value="Bahrain"/>
    <xsd:enumeration value="Bangladesh"/>
    <xsd:enumeration value="Barbados"/>
    <xsd:enumeration value="Belarus"/>
    <xsd:enumeration value="Belgium"/>
    <xsd:enumeration value="Belize"/>
    <xsd:enumeration value="Benin"/>
    <xsd:enumeration value="Bermuda"/>
    <xsd:enumeration value="Bhutan"/>
    <xsd:enumeration value="Bolivia"/>
    <xsd:enumeration value="Bosnia and Herzegovina"/>
    <xsd:enumeration value="Botswana"/>
    <xsd:enumeration value="Brazil"/>
    <xsd:enumeration value="British Virgin Islands"/>
    <xsd:enumeration value="Brunei Darussalam"/>
    <xsd:enumeration value="Bulgaria"/>
    <xsd:enumeration value="Burkina Faso"/>
    <xsd:enumeration value="Burundi"/>
    <xsd:enumeration value="Cambodia"/>
    <xsd:enumeration value="Cameroon"/>
    <xsd:enumeration value="Canada"/>
    <xsd:enumeration value="Cape Verde"/>
    <xsd:enumeration value="Cayman Islands"/>
    <xsd:enumeration value="Central African Republic"/>
    <xsd:enumeration value="Chad"/>
    <xsd:enumeration value="Chile"/>
    <xsd:enumeration value="China"/>
    <xsd:enumeration value="Hong Kong Special Administrative Region of China"/>
    <xsd:enumeration value="Macao Special Administrative Region of China"/>
    <xsd:enumeration value="Colombia"/>
    <xsd:enumeration value="Comoros"/>
    <xsd:enumeration value="Congo"/>
    <xsd:enumeration value="Cook Islands"/>
    <xsd:enumeration value="Costa Rica"/>
    <xsd:enumeration value="Cote d'Ivoire"/>
```

```
<xsd:enumeration value="Croatia"/>
<xsd:enumeration value="Cuba"/>
<xsd:enumeration value="Cyprus"/>
<xsd:enumeration value="Czech Republic"/>
<xsd:enumeration value="Democratic People's Republic of Korea"/>
<xsd:enumeration value="Democratic Republic of the Congo"/>
<xsd:enumeration value="Denmark"/>
<xsd:enumeration value="Djibouti"/>
<xsd:enumeration value="Dominica"/>
<xsd:enumeration value="Dominican Republic"/>
<xsd:enumeration value="East Timor"/>
<xsd:enumeration value="Ecuador"/>
<xsd:enumeration value="Egypt"/>
<xsd:enumeration value="El Salvador"/>
<xsd:enumeration value="Equatorial Guinea"/>
<xsd:enumeration value="Eritrea"/>
<xsd:enumeration value="Estonia"/>
<xsd:enumeration value="Ethiopia"/>
<xsd:enumeration value="Faeroe Islands"/>
<xsd:enumeration value="Falkland Islands (Malvinas)"/>
<xsd:enumeration value="Fiji"/>
<xsd:enumeration value="Finland"/>
<xsd:enumeration value="France"/>
<xsd:enumeration value="French Guiana"/>
<xsd:enumeration value="French Polynesia"/>
<xsd:enumeration value="Gabon"/>
<xsd:enumeration value="Gambia"/>
<xsd:enumeration value="Georgia"/>
<xsd:enumeration value="Germany"/>
<xsd:enumeration value="Ghana"/>
<xsd:enumeration value="Gibraltar"/>
<xsd:enumeration value="Greece"/>
<xsd:enumeration value="Greenland"/>
<xsd:enumeration value="Grenada"/>
<xsd:enumeration value="Guadeloupe"/>
<xsd:enumeration value="Guam"/>
<xsd:enumeration value="Guatemala"/>
<xsd:enumeration value="Guinea"/>
<xsd:enumeration value="Guinea-Bissau"/>
<xsd:enumeration value="Guyana"/>
<xsd:enumeration value="Haiti"/>
<xsd:enumeration value="Holy See"/>
<xsd:enumeration value="Honduras"/>
<xsd:enumeration value="Hungary"/>
<xsd:enumeration value="Iceland"/>
<xsd:enumeration value="India"/>
<xsd:enumeration value="Indonesia"/>
<xsd:enumeration value="Iran (Islamic Republic of)"/>
<xsd:enumeration value="Iraq"/>
<xsd:enumeration value="Ireland"/>
<xsd:enumeration value="Isle of Man"/>
<xsd:enumeration value="Israel"/>
<xsd:enumeration value="Italy"/>
<xsd:enumeration value="Jamaica"/>
<xsd:enumeration value="Japan"/>
<xsd:enumeration value="Jordan"/>
<xsd:enumeration value="Kazakhstan"/>
<xsd:enumeration value="Kenya"/>
<xsd:enumeration value="Kiribati"/>
<xsd:enumeration value="Kuwait"/>
<xsd:enumeration value="Kyrgyzstan"/>
<xsd:enumeration value="Lao People's Democratic Republic"/>
<xsd:enumeration value="Latvia"/>
<xsd:enumeration value="Lebanon"/>
<xsd:enumeration value="Lesotho"/>
<xsd:enumeration value="Liberia"/>
<xsd:enumeration value="Libyan Arab Jamahiriya"/>
<xsd:enumeration value="Liechtenstein"/>
<xsd:enumeration value="Lithuania"/>
<xsd:enumeration value="Luxembourg"/>
<xsd:enumeration value="Madagascar"/>
<xsd:enumeration value="Malawi"/>
<xsd:enumeration value="Malaysia"/>
<xsd:enumeration value="Maldives"/>
<xsd:enumeration value="Mali"/>
<xsd:enumeration value="Malta"/>
```

```
<xsd:enumeration value="Marshall Islands"/>
<xsd:enumeration value="Martinique"/>
<xsd:enumeration value="Mauritania"/>
<xsd:enumeration value="Mauritius"/>
<xsd:enumeration value="Mexico"/>
<xsd:enumeration value="Micronesia, Federated States of"/>
<xsd:enumeration value="Monaco"/>
<xsd:enumeration value="Mongolia"/>
<xsd:enumeration value="Montserrat"/>
<xsd:enumeration value="Morocco"/>
<xsd:enumeration value="Mozambique"/>
<xsd:enumeration value="Myanmar"/>
<xsd:enumeration value="Namibia"/>
<xsd:enumeration value="Nauru"/>
<xsd:enumeration value="Nepal"/>
<xsd:enumeration value="Netherlands"/>
<xsd:enumeration value="Netherlands Antilles"/>
<xsd:enumeration value="New Caledonia"/>
<xsd:enumeration value="New Zealand"/>
<xsd:enumeration value="Nicaragua"/>
<xsd:enumeration value="Niger"/>
<xsd:enumeration value="Nigeria"/>
<xsd:enumeration value="Niue"/>
<xsd:enumeration value="Norfolk Island"/>
<xsd:enumeration value="Northern Mariana Islands"/>
<xsd:enumeration value="Norway"/>
<xsd:enumeration value="Occupied Palestinian Territory"/>
<xsd:enumeration value="Oman"/>
<xsd:enumeration value="Pakistan"/>
<xsd:enumeration value="Palau"/>
<xsd:enumeration value="Panama"/>
<xsd:enumeration value="Papua New Guinea"/>
<xsd:enumeration value="Paraguay"/>
<xsd:enumeration value="Peru"/>
<xsd:enumeration value="Philippines"/>
<xsd:enumeration value="Pitcairn"/>
<xsd:enumeration value="Poland"/>
<xsd:enumeration value="Portugal"/>
<xsd:enumeration value="Puerto Rico"/>
<xsd:enumeration value="Qatar"/>
<xsd:enumeration value="Republic of Korea"/>
<xsd:enumeration value="Republic of Moldova"/>
<xsd:enumeration value="Réunion"/>
<xsd:enumeration value="Romania"/>
<xsd:enumeration value="Russian Federation"/>
<xsd:enumeration value="Rwanda"/>
<xsd:enumeration value="Saint Helena"/>
<xsd:enumeration value="Saint Kitts and Nevis"/>
<xsd:enumeration value="Saint Lucia"/>
<xsd:enumeration value="Saint Pierre and Miquelon"/>
<xsd:enumeration value="Saint Vincent and the Grenadines"/>
<xsd:enumeration value="Samoa"/>
<xsd:enumeration value="San Marino"/>
<xsd:enumeration value="Sao Tome and Principe"/>
<xsd:enumeration value="Saudi Arabia"/>
<xsd:enumeration value="Senegal"/>
<xsd:enumeration value="Seychelles"/>
<xsd:enumeration value="Sierra Leone"/>
<xsd:enumeration value="Singapore"/>
<xsd:enumeration value="Slovakia"/>
<xsd:enumeration value="Slovenia"/>
<xsd:enumeration value="Solomon Islands"/>
<xsd:enumeration value="Somalia"/>
<xsd:enumeration value="South Africa"/>
<xsd:enumeration value="Spain"/>
<xsd:enumeration value="Sri Lanka"/>
<xsd:enumeration value="Sudan"/>
<xsd:enumeration value="Suriname"/>
<xsd:enumeration value="Svalbard and Jan Mayen Islands"/>
<xsd:enumeration value="Swaziland"/>
<xsd:enumeration value="Sweden"/>
<xsd:enumeration value="Switzerland"/>
<xsd:enumeration value="Syrian Arab Republic"/>
<xsd:enumeration value="Taiwan Province of China"/>
<xsd:enumeration value="Tajikistan"/>
<xsd:enumeration value="Thailand"/>
```



```
<xsd:enumeration value="The former Yugoslav Republic of Macedonia" />
<xsd:enumeration value="Togo" />
<xsd:enumeration value="Tokelau" />
<xsd:enumeration value="Tonga" />
<xsd:enumeration value="Trinidad and Tobago" />
<xsd:enumeration value="Tunisia" />
<xsd:enumeration value="Turkey" />
<xsd:enumeration value="Turkmenistan" />
<xsd:enumeration value="Turks and Caicos Islands" />
<xsd:enumeration value="Tuvalu" />
<xsd:enumeration value="Uganda" />
<xsd:enumeration value="Ukraine" />
<xsd:enumeration value="United Arab Emirates" />
<xsd:enumeration value="United Kingdom" />
<xsd:enumeration value="United Republic of Tanzania" />
<xsd:enumeration value="United States" />
<xsd:enumeration value="United States Virgin Islands" />
<xsd:enumeration value="Uruguay" />
<xsd:enumeration value="Uzbekistan" />
<xsd:enumeration value="Vanuatu" />
<xsd:enumeration value="Venezuela" />
<xsd:enumeration value="Viet Nam" />
<xsd:enumeration value="Wallis and Futuna Islands" />
<xsd:enumeration value="Western Sahara" />
<xsd:enumeration value="Yemen" />
<xsd:enumeration value="Yugoslavia" />
<xsd:enumeration value="Zambia" />
<xsd:enumeration value="Zimbabwe" />
</xsd:restriction>
</xsd:simpleType>
```

13.5.145 Country Code Value (Simple)

```
<xsd:simpleType name="Cntry_code_val">
  <xsd:restriction base="xsd:string">
    <xsd:enumeration value="AFG" />
    <xsd:enumeration value="ALB" />
    <xsd:enumeration value="DZA" />
    <xsd:enumeration value="ASM" />
    <xsd:enumeration value="AND" />
    <xsd:enumeration value="AGO" />
    <xsd:enumeration value="AIA" />
    <xsd:enumeration value="ATG" />
    <xsd:enumeration value="ARG" />
    <xsd:enumeration value="ARM" />
    <xsd:enumeration value="ABW" />
    <xsd:enumeration value="AUS" />
    <xsd:enumeration value="AUT" />
    <xsd:enumeration value="AZE" />
    <xsd:enumeration value="BHS" />
    <xsd:enumeration value="BHR" />
    <xsd:enumeration value="BGD" />
    <xsd:enumeration value="BRB" />
    <xsd:enumeration value="BLR" />
    <xsd:enumeration value="BEL" />
    <xsd:enumeration value="BLZ" />
    <xsd:enumeration value="BEN" />
    <xsd:enumeration value="BMU" />
    <xsd:enumeration value="BTN" />
    <xsd:enumeration value="BOL" />
    <xsd:enumeration value="BIH" />
    <xsd:enumeration value="BWA" />
    <xsd:enumeration value="BRA" />
    <xsd:enumeration value="VGB" />
    <xsd:enumeration value="BRN" />
    <xsd:enumeration value="BGR" />
    <xsd:enumeration value="BFA" />
    <xsd:enumeration value="BDI" />
    <xsd:enumeration value="KHM" />
    <xsd:enumeration value="CMR" />
    <xsd:enumeration value="CAN" />
    <xsd:enumeration value="CPV" />
    <xsd:enumeration value="CYM" />
    <xsd:enumeration value="CAF" />
    <xsd:enumeration value="TCD" />
```



```

<xsd:enumeration value="CHL" />
<xsd:enumeration value="CHN" />
<xsd:enumeration value="HKG" />
<xsd:enumeration value="MAC" />
<xsd:enumeration value="COL" />
<xsd:enumeration value="COM" />
<xsd:enumeration value="COG" />
<xsd:enumeration value="COK" />
<xsd:enumeration value="CRI" />
<xsd:enumeration value="CIV" />
<xsd:enumeration value="HRV" />
<xsd:enumeration value="CUB" />
<xsd:enumeration value="CYP" />
<xsd:enumeration value="CZE" />
<xsd:enumeration value="PRK" />
<xsd:enumeration value="COD" />
<xsd:enumeration value="DNK" />
<xsd:enumeration value="DJI" />
<xsd:enumeration value="DMA" />
<xsd:enumeration value="DOM" />
<xsd:enumeration value="TMP" />
<xsd:enumeration value="ECU" />
<xsd:enumeration value="EGY" />
<xsd:enumeration value="SLV" />
<xsd:enumeration value="GNQ" />
<xsd:enumeration value="ERI" />
<xsd:enumeration value="EST" />
<xsd:enumeration value="ETH" />
<xsd:enumeration value="FRO" />
<xsd:enumeration value="FLK" />
<xsd:enumeration value="FJI" />
<xsd:enumeration value="FIN" />
<xsd:enumeration value="FRA" />
<xsd:enumeration value="GUF" />
<xsd:enumeration value="PYF" />
<xsd:enumeration value="GAB" />
<xsd:enumeration value="GMB" />
<xsd:enumeration value="GEO" />
<xsd:enumeration value="DEU" />
<xsd:enumeration value="GHA" />
<xsd:enumeration value="GIB" />
<xsd:enumeration value="GRC" />
<xsd:enumeration value="GRL" />
<xsd:enumeration value="GRD" />
<xsd:enumeration value="GLP" />
<xsd:enumeration value="GUM" />
<xsd:enumeration value="GTM" />
<xsd:enumeration value="GIN" />
<xsd:enumeration value="GNB" />
<xsd:enumeration value="GUY" />
<xsd:enumeration value="HTI" />
<xsd:enumeration value="VAT" />
<xsd:enumeration value="HND" />
<xsd:enumeration value="HUN" />
<xsd:enumeration value="ISL" />
<xsd:enumeration value="IND" />
<xsd:enumeration value="IDN" />
<xsd:enumeration value="IRN" />
<xsd:enumeration value="IRQ" />
<xsd:enumeration value="IRL" />
<xsd:enumeration value="IMY" />
<xsd:enumeration value="ISR" />
<xsd:enumeration value="ITA" />
<xsd:enumeration value="JAM" />
<xsd:enumeration value="JPN" />
<xsd:enumeration value="JOR" />
<xsd:enumeration value="KAZ" />
<xsd:enumeration value="KEN" />
<xsd:enumeration value="KIR" />
<xsd:enumeration value="KWT" />
<xsd:enumeration value="KGZ" />
<xsd:enumeration value="LAO" />
<xsd:enumeration value="LVA" />
<xsd:enumeration value="LBN" />
<xsd:enumeration value="LSO" />
<xsd:enumeration value="LBR" />

```

```
<xsd:enumeration value="LBY"/>
<xsd:enumeration value="LIE"/>
<xsd:enumeration value="LTU"/>
<xsd:enumeration value="LUX"/>
<xsd:enumeration value="MDG"/>
<xsd:enumeration value="MWI"/>
<xsd:enumeration value="MYS"/>
<xsd:enumeration value="MDV"/>
<xsd:enumeration value="MLI"/>
<xsd:enumeration value="MLT"/>
<xsd:enumeration value="MHL"/>
<xsd:enumeration value="MTQ"/>
<xsd:enumeration value="MRT"/>
<xsd:enumeration value="MUS"/>
<xsd:enumeration value="MEX"/>
<xsd:enumeration value="FSM"/>
<xsd:enumeration value="MCO"/>
<xsd:enumeration value="MNG"/>
<xsd:enumeration value="MSR"/>
<xsd:enumeration value="MAR"/>
<xsd:enumeration value="MOZ"/>
<xsd:enumeration value="MMR"/>
<xsd:enumeration value="NAM"/>
<xsd:enumeration value="NRU"/>
<xsd:enumeration value="NPL"/>
<xsd:enumeration value="NLD"/>
<xsd:enumeration value="ANT"/>
<xsd:enumeration value="NCL"/>
<xsd:enumeration value="NZL"/>
<xsd:enumeration value="NIC"/>
<xsd:enumeration value="NER"/>
<xsd:enumeration value="NGA"/>
<xsd:enumeration value="NIU"/>
<xsd:enumeration value="NFK"/>
<xsd:enumeration value="MNP"/>
<xsd:enumeration value="NOR"/>
<xsd:enumeration value="PSE"/>
<xsd:enumeration value="OMN"/>
<xsd:enumeration value="PAK"/>
<xsd:enumeration value="PLW"/>
<xsd:enumeration value="PAN"/>
<xsd:enumeration value="PNG"/>
<xsd:enumeration value="PRY"/>
<xsd:enumeration value="PER"/>
<xsd:enumeration value="PHL"/>
<xsd:enumeration value="PCN"/>
<xsd:enumeration value="POL"/>
<xsd:enumeration value="PRT"/>
<xsd:enumeration value="PRI"/>
<xsd:enumeration value="QAT"/>
<xsd:enumeration value="KOR"/>
<xsd:enumeration value="MDA"/>
<xsd:enumeration value="REU"/>
<xsd:enumeration value="ROM"/>
<xsd:enumeration value="RUS"/>
<xsd:enumeration value="RWA"/>
<xsd:enumeration value="SHN"/>
<xsd:enumeration value="KNA"/>
<xsd:enumeration value="LCA"/>
<xsd:enumeration value="SPM"/>
<xsd:enumeration value="VCT"/>
<xsd:enumeration value="WSM"/>
<xsd:enumeration value="SMR"/>
<xsd:enumeration value="STP"/>
<xsd:enumeration value="SAU"/>
<xsd:enumeration value="SEN"/>
<xsd:enumeration value="SYC"/>
<xsd:enumeration value="SLE"/>
<xsd:enumeration value="SGP"/>
<xsd:enumeration value="SVK"/>
<xsd:enumeration value="SVN"/>
<xsd:enumeration value="SLB"/>
<xsd:enumeration value="SOM"/>
<xsd:enumeration value="ZAF"/>
<xsd:enumeration value="ESP"/>
<xsd:enumeration value="LKA"/>
```

```

<xsd:enumeration value="SDN" />
<xsd:enumeration value="SUR" />
<xsd:enumeration value="SJM" />
<xsd:enumeration value="SWZ" />
<xsd:enumeration value="SWE" />
<xsd:enumeration value="CHE" />
<xsd:enumeration value="SYR" />
<xsd:enumeration value="TWN" />
<xsd:enumeration value="TJK" />
<xsd:enumeration value="THA" />
<xsd:enumeration value="MKD" />
<xsd:enumeration value="TGO" />
<xsd:enumeration value="TKL" />
<xsd:enumeration value="TON" />
<xsd:enumeration value="TTO" />
<xsd:enumeration value="TUN" />
<xsd:enumeration value="TUR" />
<xsd:enumeration value="TKM" />
<xsd:enumeration value="TCA" />
<xsd:enumeration value="TUV" />
<xsd:enumeration value="UGA" />
<xsd:enumeration value="UKR" />
<xsd:enumeration value="ARE" />
<xsd:enumeration value="GBR" />
<xsd:enumeration value="TZA" />
<xsd:enumeration value="USA" />
<xsd:enumeration value="VIR" />
<xsd:enumeration value="URY" />
<xsd:enumeration value="UZB" />
<xsd:enumeration value="VUT" />
<xsd:enumeration value="VEN" />
<xsd:enumeration value="VNM" />
<xsd:enumeration value="WLF" />
<xsd:enumeration value="ESH" />
<xsd:enumeration value="YEM" />
<xsd:enumeration value="YUG" />
<xsd:enumeration value="ZMB" />
<xsd:enumeration value="ZWE" />
</xsd:restriction>
</xsd:simpleType>

```

13.5.146 Data Use Name (Simple)

```

<xsd:simpleType name="Data_use_name">
  <xsd:restriction base="xsd:string">
    <xsd:enumeration value="Entity" />
    <xsd:enumeration value="Foreign Identifier" />
    <xsd:enumeration value="Field Counter" />
    <xsd:enumeration value="Other" />
  </xsd:restriction>
</xsd:simpleType>

```

13.5.147 Data Use Value (Simple)

```

<xsd:simpleType name="Data_use_value">
  <xsd:restriction base="xsd:integer">
    <xsd:minInclusive value="1" />
    <xsd:maxInclusive value="4" />
  </xsd:restriction>
</xsd:simpleType>

```

13.5.148 Datum Name (Simple)

```

<xsd:simpleType name="Datum_name">
  <xsd:restriction base="xsd:string">
    <xsd:maxLength value="50" />
    <xsd:enumeration value="Adindan" />
    <xsd:enumeration value="Adindan (Ethiopia)" />
    <xsd:enumeration value="Adindan (Sudan)" />
    <xsd:enumeration value="Adindan (Mali)" />
    <xsd:enumeration value="Adindan (Senegal)" />
    <xsd:enumeration value="Adindan (Burkina Faso)" />
    <xsd:enumeration value="Adindan (Cameroon)" />
  </xsd:restriction>
</xsd:simpleType>

```

```
<xsd:enumeration value="Adindan (Mean value: Ethiopia and Sudan)"/>
<xsd:enumeration value="Afgooye (Somalia)"/>
<xsd:enumeration value="Antigua Island Astro 1943"/>
<xsd:enumeration value="Ain el Abd 1970"/>
<xsd:enumeration value="Ain el Abd 1970 (Bahrain Island)"/>
<xsd:enumeration value="Ain el Abd 1970 (Saudi Arabia)"/>
<xsd:enumeration value="American Samoa Datum 1962"/>
<xsd:enumeration value="Amersfoort 1885/1903 (Netherlands)"/>
<xsd:enumeration value="Anna 1 Astro 1965 (Cocos Islands)"/>
<xsd:enumeration value="Approximate Luzon Datum (Philippines)"/>
<xsd:enumeration value="Arc 1950"/>
<xsd:enumeration value="Arc 1950 (Botswana)"/>
<xsd:enumeration value="Arc 1950 (Lesotho)"/>
<xsd:enumeration value="Arc 1950 (Malawi)"/>
<xsd:enumeration value="Arc 1950 (Swaziland)"/>
<xsd:enumeration value="Arc 1950 (Zaire)"/>
<xsd:enumeration value="Arc 1950 (Zambia)"/>
<xsd:enumeration value="Arc 1950 (Zimbabwe)"/>
<xsd:enumeration value="Arc 1950 (Burundi)"/>
<xsd:enumeration value="Arc 1950 (Mean value: Botswana, Lesotho, Malawi, Swaziland,
Zaire,
Zambia, and Zimbabwe)"/>
<xsd:enumeration value="Arc 1960"/>
<xsd:enumeration value="Arc 1960 (Kenya)"/>
<xsd:enumeration value="Arc 1960 (Tanzania)"/>
<xsd:enumeration value="Arc 1960 (Mean value: Kenya, Tanzania)"/>
<xsd:enumeration value="Arc 1935 (Africa)"/>
<xsd:enumeration value="Ascension Island 1958 (Ascension Island)"/>
<xsd:enumeration value="Montserrat Island Astro 1958"/>
<xsd:enumeration value="Astro Station 1952 (Marcus Island)"/>
<xsd:enumeration value="Astro Beacon &quot;E&quot; (Iwo Jima Island)"/>
<xsd:enumeration value="Average Terrestrial System 1977, New Brunswick"/>
<xsd:enumeration value="Australian Geod. 1966 (Australia and Tasmania Is.)"/>
<xsd:enumeration value="Australian Geod. 1984 (Australia and Tasmania Is.)"/>
<xsd:enumeration value="Djakarta (Batavia) (Sumatra Island, Indonesia)"/>
<xsd:enumeration value="Djakarta (Batavia) (Sumatra Island, Indonesia) with Zero Meridian
Djakarta"/>
<xsd:enumeration value="Bekaa Base South End (Lebanon)"/>
<xsd:enumeration value="Belgium 1950 System (Lommel Signal, Belgium)"/>
<xsd:enumeration value="Bermuda 1957 (Bermuda Islands)"/>
<xsd:enumeration value="Bissau (Guinea-Bissau)"/>
<xsd:enumeration value="Modified BJZ54 (China)"/>
<xsd:enumeration value="BJZ54 (A954 Beijing Coordinates) (China)"/>
<xsd:enumeration value="Bogota Observatory (Colombia)"/>
<xsd:enumeration value="Bogota Observatory (Colombia) with Zero Meridian Bogota"/>
<xsd:enumeration value="Bern 1898 (Switzerland)"/>
<xsd:enumeration value="Bern 1898 (Switzerland) with Zero Meridian Bern"/>
<xsd:enumeration value="Bukit Rimpah (Bangka &amp; Belitung Islands, Indonesia)"/>
<xsd:enumeration value="Cape Canaveral (Mean value: Florida and Bahama Islands)"/>
<xsd:enumeration value="Campo Inchauspe (Argentina)"/>
<xsd:enumeration value="Camacupa Base SW End (Campo De Aviacao, Angola)"/>
<xsd:enumeration value="Canton Astro 1966 (Phoenix Islands)"/>
<xsd:enumeration value="Cape (South Africa)"/>
<xsd:enumeration value="Camp Area Astro (Camp McMurdo Area, Antarctica)"/>
<xsd:enumeration value="S-JTSK, Czechoslovakia (prior to 1 Jan 1993)"/>
<xsd:enumeration value="Carthage (Tunisia)"/>
<xsd:enumeration value="Compensation Géodétique du Québec 1977"/>
<xsd:enumeration value="Chatham 1971 (Chatham Island, New Zealand)"/>
<xsd:enumeration value="Chua Astro (Paraguay)"/>
<xsd:enumeration value="Corrego Alegre (Brazil)"/>
<xsd:enumeration value="Conakry Pyramid of the Service Geographique (Guinea)"/>
<xsd:enumeration value="Guyana CSG67"/>
<xsd:enumeration value="Dabola (Guinea)"/>
<xsd:enumeration value="DCS-3 Lighthouse, Saint Lucia, Lesser Antilles"/>
<xsd:enumeration value="Deception Island, Antarctica"/>
<xsd:enumeration value="GUX 1 Astro (Guadacanal Island)"/>
<xsd:enumeration value="Dominica Astro M-12, Dominica, Lesser Antilles"/>
<xsd:enumeration value="Easter Island 1967 (Easter Island)"/>
<xsd:enumeration value="Wake-Eniwetok 1960 (Marshall Islands)"/>
<xsd:enumeration value="European 1950"/>
<xsd:enumeration value="European 1950 (Western Europe: Austria, Denmark, France, Federal
Republic of Germany, Netherlands, and Switzerland)"/>
<xsd:enumeration value="European 1950 (Greece)"/>
<xsd:enumeration value="European 1950 (Norway and Finland)"/>
<xsd:enumeration value="European 1950 (Portugal and Spain)"/>
<xsd:enumeration value="European 1950 (Cyprus)"/>
```

```

<xsd:enumeration value="European 1950 (Egypt)"/>
<xsd:enumeration value="European 1950 (England, Channel Islands, Scotland, and Shetland
Islands)"/>
<xsd:enumeration value="European 1950 (Iran)"/>
<xsd:enumeration value="European 1950 (Sardinia)"/>
<xsd:enumeration value="European 1950 (Sicily)"/>
<xsd:enumeration value="European 1950 (England, Channel Islands, Ireland, Northern
Ireland,
Scotland, Shetland Islands, and Wales)"/>
<xsd:enumeration value="European 1950 (Malta)"/>
<xsd:enumeration value="European 1950 (Mean value: Austria, Belgium, Denmark, Finland,
France,
Federal Republic of Germany, Gibraltar, Greece, Italy, Luxembourg,
Netherlands, Norway,
Portugal, Spain, Sweden, & Switzerland)"/>
<xsd:enumeration value="European 1950 (Iraq, Israel, Jordan, Kuwait, Lebanon, Saudi
Arabia, and
Syria)"/>
<xsd:enumeration value="European 1950 (Tunisia)"/>
<xsd:enumeration value="European 1979 (Mean value: Austria, Finland, Netherlands, Norway,
Spain,
Sweden, and Switzerland)"/>
<xsd:enumeration value="European Terrestrial Reference System 1989 (ETRS89)"/>
<xsd:enumeration value="Oman (Oman)"/>
<xsd:enumeration value="Observatorio Meteorologico 1939 (Corvo and Flores Islands,
Azores)"/>
<xsd:enumeration value="Fort Thomas 1955 (Nevis, St Kitts, Leeward Islands)"/>
<xsd:enumeration value="Gan 1970 (Addu Atoll, Republic of Maldives)"/>
<xsd:enumeration value="Gandajika Base (Zaire)"/>
<xsd:enumeration value="Geocentric Datum of Australia (GDA)"/>
<xsd:enumeration value="GDZ80 (China)"/>
<xsd:enumeration value="Geodetic Datum 1949 (New Zealand)"/>
<xsd:enumeration value="DOS 1968 (Gizo Island, New Georgia Islands)"/>
<xsd:enumeration value="Graciosa Base SW (Faial, Graciosa, Pico, Sao Jorge, and Terceira
Island,
Azores)"/>
<xsd:enumeration value="Greek Datum, Greece"/>
<xsd:enumeration value="Greek Geodetic Reference System 1987 (GGRS 87)"/>
<xsd:enumeration value="Gunong Segara (Kalimantan Island, Indonesia)"/>
<xsd:enumeration value="Gunong Serindung"/>
<xsd:enumeration value="Guam 1963"/>
<xsd:enumeration value="Herat North (Afganistan)"/>
<xsd:enumeration value="Hermannskogel"/>
<xsd:enumeration value="Provisional South Chilean 1963 (or Hito XVIII 1963) (S. Chile,
53°S)"/>
<xsd:enumeration value="Hjörsey 1955 (Iceland)"/>
<xsd:enumeration value="Hong Kong 1963 (Hong Kong)"/>
<xsd:enumeration value="Hong Kong 1929"/>
<xsd:enumeration value="Hu-Tzu-Shan"/>
<xsd:enumeration value="Hungarian 1972"/>
<xsd:enumeration value="Bellevue (IGN) (Efate and Erromango Islands)"/>
<xsd:enumeration value="Indonesian 1974"/>
<xsd:enumeration value="Indian"/>
<xsd:enumeration value="Indian (Thailand and Vietnam)"/>
<xsd:enumeration value="Indian (Bangladesh)"/>
<xsd:enumeration value="Indian (India and Nepal)"/>
<xsd:enumeration value="Indian (Pakistan)"/>
<xsd:enumeration value="Indian (1954)"/>
<xsd:enumeration value="Indian 1954 (Thailand)"/>
<xsd:enumeration value="Indian 1960"/>
<xsd:enumeration value="Indian 1960 (Vietnam: near 16°N)"/>
<xsd:enumeration value="Indian 1960 (Con Son Island (Vietnam))"/>
<xsd:enumeration value="Indian 1975"/>
<xsd:enumeration value="Indian 1975 (Thailand)"/>
<xsd:enumeration value="Ireland 1965 (Ireland and Northern Ireland)"/>
<xsd:enumeration value="ISTS 061 Astro 1968 (South Georgia Islands)"/>
<xsd:enumeration value="ISTS 073 Astro 1969 (Diego Garcia)"/>
<xsd:enumeration value="Johnston Island 1961 (Johnston Island)"/>
<xsd:enumeration value="Kalianpur (India)"/>
<xsd:enumeration value="Kandawala (Sri Lanka)"/>
<xsd:enumeration value="Kertau 1948 (or Revised Kertau) (West Malaysia and Singapore)"/>
<xsd:enumeration value="KCS 2, Sierra Leone"/>
<xsd:enumeration value="Kerguelen Island 1949 (Kerguelen Island)"/>
<xsd:enumeration value="Korean Geodetic System 1995 (South Korea)"/>
<xsd:enumeration value="KKJ (or Kartastokoordinaattijarjestelmä), Finland"/>
<xsd:enumeration value="Kusaie Astro 1951"/>

```

```

<xsd:enumeration value="Kuwait Oil Company (K28)"/>
<xsd:enumeration value="L.C. 5 Astro 1961 (Cayman Brac Island)"/>
<xsd:enumeration value="Leigon (Ghana)"/>
<xsd:enumeration value="Liberia 1964 (Liberia)"/>
<xsd:enumeration value="Lisbon (Castelo di São Jorge), Portugal"/>
<xsd:enumeration value="Local Astro."/>
<xsd:enumeration value="Loma Quintana (Venezuela)"/>
<xsd:enumeration value="Luzon"/>
<xsd:enumeration value="Luzon (Philippines except Mindanao Island)"/>
<xsd:enumeration value="Luzon (Mindanao Island)"/>
<xsd:enumeration value="Marco Astro (Salvage Islands)"/>
<xsd:enumeration value="Martinique Fort-Desaix"/>
<xsd:enumeration value="Massawa (Eritrea, Ethiopia)"/>
<xsd:enumeration value="Manokwari (West Irian)"/>
<xsd:enumeration value="Mayotte Combani"/>
<xsd:enumeration value="Mount Dillon, Tobago"/>
<xsd:enumeration value="Merchich (Morocco)"/>
<xsd:enumeration value="Midway Astro 1961 (Midway Island)"/>
<xsd:enumeration value="Mahe 1971 (Mahe Island)"/>
<xsd:enumeration value="Minna"/>
<xsd:enumeration value="Minna (Cameroon)"/>
<xsd:enumeration value="Minna (Nigeria)"/>
<xsd:enumeration value="Rome 1940 (or Monte Mario 1940), Italy"/>
Rome"/>
<xsd:enumeration value="Rome 1940 (or Monte Mario 1940), Italy, with Zero Meridian

<xsd:enumeration value="Montjong Lowe"/>
<xsd:enumeration value="M'Poraloko (Gabon)"/>
<xsd:enumeration value="Viti Levu 1916 (Viti Levu Island, Fiji Islands)"/>
<xsd:enumeration value="Nahrwan"/>
<xsd:enumeration value="Nahrwan (Masirah Island, Oman)"/>
<xsd:enumeration value="Nahrwan (United Arab Emirates)"/>
<xsd:enumeration value="Nahrwan (Saudi Arabia)"/>
<xsd:enumeration value="Naparima (BWI, Trinidad and Tobago)"/>
<xsd:enumeration value="North American 1983"/>
<xsd:enumeration value="North American 1983 (Alaska, excluding Aleutian Islands)"/>
<xsd:enumeration value="North American 1983 (Canada)"/>
<xsd:enumeration value="North American 1983 (CONUS)"/>
<xsd:enumeration value="North American 1983 (Mexico and Central America)"/>
<xsd:enumeration value="North American 1983 (Aleutian Islands)"/>
<xsd:enumeration value="North American 1983 (Hawaii)"/>
<xsd:enumeration value="North American 1927"/>
<xsd:enumeration value="North American 1927 (Eastern US)"/>
<xsd:enumeration value="North American 1927 (Western US)"/>
<xsd:enumeration value="North American 1927 (Mean value: CONUS)"/>
<xsd:enumeration value="North American 1927 (Alaska)"/>
<xsd:enumeration value="North American 1927 (Mean value: Canada)"/>
<xsd:enumeration value="North American 1927 (Alberta and British Columbia)"/>
<xsd:enumeration value="North American 1927 (Newfoundland, New Brunswick, Nova Scotia and
Quebec)"/>
<xsd:enumeration value="North American 1927 (Manitoba and Ontario)"/>
<xsd:enumeration value="North American 1927 (Northwest Territories and Saskatchewan)"/>
<xsd:enumeration value="North American 1927 (Yukon)"/>
<xsd:enumeration value="North American 1927 (Mexico)"/>
Salvador,
<xsd:enumeration value="North American 1927 (Central America - Belize, Costa Rica, El
Guatemala, Honduras, and Nicaragua)"/>
<xsd:enumeration value="North American 1927 (Canal Zone)"/>
<xsd:enumeration value="North American 1927 (Caribbean, Barbados, Caicos Islands, Cuba,
Dominican Republic, Grand Cayman, Jamaica, Leeward Islands, and
Turks Islands)"/>
<xsd:enumeration value="North American 1927 (Bahamas, except San Salvador Island)"/>
<xsd:enumeration value="North American 1927 (San Salvador Island)"/>
<xsd:enumeration value="North American 1927 (Cuba)"/>
<xsd:enumeration value="North American 1927 (Hayes Peninsula, Greenland)"/>
<xsd:enumeration value="North American 1927 (Aleutian Islands East of 180°W)"/>
<xsd:enumeration value="North American 1927 (Aleutian Islands West of 180°W)"/>
<xsd:enumeration value="Revised Nahrwan"/>
Meridian
<xsd:enumeration value="New French or Nouvelle Triangulation Française (NTF) with Zero
Paris"/>
<xsd:enumeration value="North Sahara 1959"/>
<xsd:enumeration value="Ocotopeque, Guatemala"/>
<xsd:enumeration value="Belgium 1972 (Observatoire d'Uccle)"/>
<xsd:enumeration value="Old Egyptian (Egypt)"/>
<xsd:enumeration value="Ordnance Survey of Great Britain 1936"/>
<xsd:enumeration value="Ordnance Survey G.B. 1936 (England)"/>

```



```

<xsd:enumeration value="Ordnance Survey G.B. 1936 (England, Isle of Man, and Wales)"/>
<xsd:enumeration value="Ordnance Survey G.B. 1936 (Scotland and Shetland Islands)"/>
<xsd:enumeration value="Ordnance Survey G.B. 1936 (Wales)"/>
<xsd:enumeration value="Ordnance Survey G.B. 1936 (Mean value: England, Isle of Man,
Scotland,
                Shetland, and Wales)"/>
<xsd:enumeration value="Old Hawaiian"/>
<xsd:enumeration value="Old Hawaiian (Hawaii)"/>
<xsd:enumeration value="Old Hawaiian (Kauai)"/>
<xsd:enumeration value="Old Hawaiian (Maui)"/>
<xsd:enumeration value="Old Hawaiian (Oahu)"/>
<xsd:enumeration value="Old Hawaiian (Mean value)"/>
<xsd:enumeration value="Oslo Observatory (Old), Norway"/>
<xsd:enumeration value="Padang Base West End (Sumatra, Indonesia)"/>
<xsd:enumeration value="Padang Base West End (Sumatra, Indonesia) with Zero Meridian
Djakarta"/>
<xsd:enumeration value="Palestine 1928 (Israel, Jordan)"/>
<xsd:enumeration value="Potsdam or Helmerdturm (Germany)"/>
<xsd:enumeration value="Ayabelle Lighthouse (Djibouti)"/>
<xsd:enumeration value="Pitcairn Astro 1967 (Pitcairn Island)"/>
<xsd:enumeration value="Pico de las Nieves (Canary Islands)"/>
<xsd:enumeration value="SE Base (Porto Santo) (Porto Santo & Madeira Islands)"/>
<xsd:enumeration value="Provisional South American 1956"/>
<xsd:enumeration value="Prov. S. American 1956 (Bolivia)"/>
<xsd:enumeration value="Prov. S. American 1956 (Northern Chile near 19°S)"/>
<xsd:enumeration value="Prov. S. American 1956 (Southern Chile near 43°S)"/>
<xsd:enumeration value="Prov. S. American 1956 (Columbia)"/>
<xsd:enumeration value="Prov. S. American 1956 (Ecuador)"/>
<xsd:enumeration value="Prov. S. American 1956 (Guyana)"/>
<xsd:enumeration value="Prov. S. American 1956 (Peru)"/>
<xsd:enumeration value="Prov. S. American 1956 (Venezuela)"/>
<xsd:enumeration value="Prov. S. American 1956 (Mean value: Bolivia, Chile, Colombia,
Ecuador,
                Guyana, Peru, & Venezuela)"/>
<xsd:enumeration value="Point 58 Mean Solution (Burkina Faso and Niger)"/>
<xsd:enumeration value="Pointe Noire 1948"/>
<xsd:enumeration value="Pulkovo 1942 (Russia)"/>
<xsd:enumeration value="Puerto Rico (Puerto Rico and Virgin Islands)"/>
<xsd:enumeration value="Qatar National (Qatar)"/>
<xsd:enumeration value="Qornoq (South Greenland)"/>
<xsd:enumeration value="Rauenberg (Berlin, Germany)"/>
<xsd:enumeration value="Reconnaissance Triangulation, Morocco"/>
<xsd:enumeration value="Reunion 1947"/>
<xsd:enumeration value="RT90, Stockholm, Sweden"/>
<xsd:enumeration value="Santo (DOS) 1965 (Espirito Santo Island)"/>
<xsd:enumeration value="South African (South Africa)"/>
<xsd:enumeration value="Sainte Anne I 1984 (Guadeloupe)"/>
<xsd:enumeration value="South American 1969"/>
<xsd:enumeration value="South American 1969 (Argentina)"/>
<xsd:enumeration value="South American 1969 (Bolivia)"/>
<xsd:enumeration value="South American 1969 (Brazil)"/>
<xsd:enumeration value="South American 1969 (Chile)"/>
<xsd:enumeration value="South American 1969 (Columbia)"/>
<xsd:enumeration value="South American 1969 (Ecuador)"/>
<xsd:enumeration value="South American 1969 (Guyana)"/>
<xsd:enumeration value="South American 1969 (Paraguay)"/>
<xsd:enumeration value="South American 1969 (Peru)"/>
<xsd:enumeration value="South American 1969 (Baltra, Galapagos Islands)"/>
<xsd:enumeration value="South American 1969 (Trinidad and Tobago)"/>
<xsd:enumeration value="South American 1969 (Venezuela)"/>
<xsd:enumeration value="South American 1969 (Mean value: Argentina, Bolivia, Brazil,
Chile,
                Columbia, Ecuador, Guyana, Paraguay, Peru, Trinidad and Tobago, and
Venezuela)"/>
<xsd:enumeration value="Sao Braz (Sao Miguel, Santa Maria Islands, Azores)"/>
<xsd:enumeration value="Sapper Hill 1943 (East Falkland Islands)"/>
<xsd:enumeration value="Schwarzeck (Namibia)"/>
<xsd:enumeration value="Soviet Geodetic System 1985"/>
<xsd:enumeration value="Soviet Geodetic System 1990"/>
<xsd:enumeration value="Selvagem Grande 1938 (Salvage Islands)"/>
<xsd:enumeration value="Astro Dos 71/4 (St. Helena Island)"/>
<xsd:enumeration value="Sierra Leone 1960"/>
<xsd:enumeration value="South Asia (Southeast Asia, Singapore)"/>
<xsd:enumeration value="S-42 (Pulkovo 1942)"/>
<xsd:enumeration value="St. Pierre et Miquelon 1950"/>
<xsd:enumeration value="Stockholm 1938 (Sweden)"/>

```

```

<xsd:enumeration value="Sydney Observatory, New South Wales, Australia"/>
<xsd:enumeration value="Tananarive Observatory 1925"/>
<xsd:enumeration value="Tananarive Observatory 1925, with Zero Meridian Paris"/>
<xsd:enumeration value="Tristan Astro 1968 (Tristan da Cunha)"/>
<xsd:enumeration value="Timbalai 1948 (Brunei and East Malaysia - Sarawak and Sabah)"/>
<xsd:enumeration value="Timbali 1968"/>
<xsd:enumeration value="Tokyo"/>
<xsd:enumeration value="Tokyo (Japan)"/>
<xsd:enumeration value="Tokyo (Korea)"/>
<xsd:enumeration value="Tokyo (Okinawa)"/>
<xsd:enumeration value="Tokyo (Mean value: Japan, Korea, and Okinawa)"/>
<xsd:enumeration value="Trinidad 1903"/>
<xsd:enumeration value="Astro Tern Is. 1961 (Tern Island, Hawaii)"/>
<xsd:enumeration value="Undetermined or Unknown"/>
<xsd:enumeration value="Voirol 1875"/>
<xsd:enumeration value="Voirol 1875 with Zero Meridian Paris"/>
<xsd:enumeration value="Voirol 1960, Algeria"/>
<xsd:enumeration value="Voirol 1960, Algeria, with Zero Meridian Paris"/>
<xsd:enumeration value="Wake Island Astro 1952"/>
<xsd:enumeration value="World Geodetic System 1960"/>
<xsd:enumeration value="World Geodetic System 1966"/>
<xsd:enumeration value="World Geodetic System 1972"/>
<xsd:enumeration value="World Geodetic System 1984"/>
<xsd:enumeration value="Yacare (Uruguay)"/>
<xsd:enumeration value="Zanderij (Surinam)"/>
<xsd:enumeration value="Other Known Datum"/>
</xsd:restriction>
</xsd:simpleType>

```

13.5.149 Datum Value (Simple)

```

<xsd:simpleType name="Datum_value">
  <xsd:restriction base="xsd:string">
    <xsd:maxLength value="4"/>
    <xsd:enumeration value="ADI"/>
    <xsd:enumeration value="ADIA"/>
    <xsd:enumeration value="ADIB"/>
    <xsd:enumeration value="ADIC"/>
    <xsd:enumeration value="ADID"/>
    <xsd:enumeration value="ADIE"/>
    <xsd:enumeration value="ADIF"/>
    <xsd:enumeration value="ADIM"/>
    <xsd:enumeration value="AFG"/>
    <xsd:enumeration value="AIA"/>
    <xsd:enumeration value="AIN"/>
    <xsd:enumeration value="AINA"/>
    <xsd:enumeration value="AINB"/>
    <xsd:enumeration value="AMA"/>
    <xsd:enumeration value="AME"/>
    <xsd:enumeration value="ANO"/>
    <xsd:enumeration value="APL"/>
    <xsd:enumeration value="ARF"/>
    <xsd:enumeration value="ARFA"/>
    <xsd:enumeration value="ARFB"/>
    <xsd:enumeration value="ARFC"/>
    <xsd:enumeration value="ARFD"/>
    <xsd:enumeration value="ARFE"/>
    <xsd:enumeration value="ARFF"/>
    <xsd:enumeration value="ARFG"/>
    <xsd:enumeration value="ARFH"/>
    <xsd:enumeration value="ARFM"/>
    <xsd:enumeration value="ARS"/>
    <xsd:enumeration value="ARSA"/>
    <xsd:enumeration value="ARSB"/>
    <xsd:enumeration value="ARSM"/>
    <xsd:enumeration value="ART"/>
    <xsd:enumeration value="ASC"/>
    <xsd:enumeration value="ASM"/>
    <xsd:enumeration value="ASQ"/>
    <xsd:enumeration value="ATF"/>
    <xsd:enumeration value="ATX"/>
    <xsd:enumeration value="AUA"/>
    <xsd:enumeration value="AUG"/>
    <xsd:enumeration value="BAT"/>
    <xsd:enumeration value="BAT1"/>
  </xsd:restriction>
</xsd:simpleType>

```



```

<xsd:enumeration value="BEK" />
<xsd:enumeration value="BEL" />
<xsd:enumeration value="BER" />
<xsd:enumeration value="BID" />
<xsd:enumeration value="BJM" />
<xsd:enumeration value="BJZ" />
<xsd:enumeration value="BOO" />
<xsd:enumeration value="BOO1" />
<xsd:enumeration value="BRE" />
<xsd:enumeration value="BRE1" />
<xsd:enumeration value="BUR" />
<xsd:enumeration value="CAC" />
<xsd:enumeration value="CAI" />
<xsd:enumeration value="CAM" />
<xsd:enumeration value="CAO" />
<xsd:enumeration value="CAP" />
<xsd:enumeration value="CAZ" />
<xsd:enumeration value="CCD" />
<xsd:enumeration value="CGE" />
<xsd:enumeration value="CGX" />
<xsd:enumeration value="CHI" />
<xsd:enumeration value="CHU" />
<xsd:enumeration value="COA" />
<xsd:enumeration value="COV" />
<xsd:enumeration value="CSG" />
<xsd:enumeration value="DAL" />
<xsd:enumeration value="DCS" />
<xsd:enumeration value="DID" />
<xsd:enumeration value="DOB" />
<xsd:enumeration value="DOM" />
<xsd:enumeration value="EAS" />
<xsd:enumeration value="ENW" />
<xsd:enumeration value="EUR" />
<xsd:enumeration value="EURA" />
<xsd:enumeration value="EURB" />
<xsd:enumeration value="EURC" />
<xsd:enumeration value="EURD" />
<xsd:enumeration value="EURE" />
<xsd:enumeration value="EURF" />
<xsd:enumeration value="EURG" />
<xsd:enumeration value="EURH" />
<xsd:enumeration value="EURI" />
<xsd:enumeration value="EURJ" />
<xsd:enumeration value="EURK" />
<xsd:enumeration value="EURL" />
<xsd:enumeration value="EURM" />
<xsd:enumeration value="EURS" />
<xsd:enumeration value="EURT" />
<xsd:enumeration value="EUS" />
<xsd:enumeration value="EUT" />
<xsd:enumeration value="FAH" />
<xsd:enumeration value="FLO" />
<xsd:enumeration value="FOT" />
<xsd:enumeration value="GAA" />
<xsd:enumeration value="GAN" />
<xsd:enumeration value="GDS" />
<xsd:enumeration value="GDZ" />
<xsd:enumeration value="GEO" />
<xsd:enumeration value="GIZ" />
<xsd:enumeration value="GRA" />
<xsd:enumeration value="GRK" />
<xsd:enumeration value="GRX" />
<xsd:enumeration value="GSE" />
<xsd:enumeration value="GSF" />
<xsd:enumeration value="GUA" />
<xsd:enumeration value="HEN" />
<xsd:enumeration value="HER" />
<xsd:enumeration value="HIT" />
<xsd:enumeration value="HJO" />
<xsd:enumeration value="HKD" />
<xsd:enumeration value="HKO" />
<xsd:enumeration value="HTN" />
<xsd:enumeration value="HUY" />
<xsd:enumeration value="IBE" />
<xsd:enumeration value="IDN" />
<xsd:enumeration value="IND" />

```

```
<xsd:enumeration value="INDA"/>
<xsd:enumeration value="INDB"/>
<xsd:enumeration value="INDI"/>
<xsd:enumeration value="INDP"/>
<xsd:enumeration value="INF"/>
<xsd:enumeration value="INFA"/>
<xsd:enumeration value="ING"/>
<xsd:enumeration value="INGA"/>
<xsd:enumeration value="INGB"/>
<xsd:enumeration value="INH"/>
<xsd:enumeration value="INHA"/>
<xsd:enumeration value="IRL"/>
<xsd:enumeration value="ISG"/>
<xsd:enumeration value="IST"/>
<xsd:enumeration value="JOH"/>
<xsd:enumeration value="KAB"/>
<xsd:enumeration value="KAN"/>
<xsd:enumeration value="KEA"/>
<xsd:enumeration value="KCS"/>
<xsd:enumeration value="KEG"/>
<xsd:enumeration value="KGS"/>
<xsd:enumeration value="KKX"/>
<xsd:enumeration value="KUS"/>
<xsd:enumeration value="KUW"/>
<xsd:enumeration value="LCF"/>
<xsd:enumeration value="LEH"/>
<xsd:enumeration value="LIB"/>
<xsd:enumeration value="LIS"/>
<xsd:enumeration value="LOC"/>
<xsd:enumeration value="LOM"/>
<xsd:enumeration value="LUZ"/>
<xsd:enumeration value="LUZA"/>
<xsd:enumeration value="LUZB"/>
<xsd:enumeration value="MAA"/>
<xsd:enumeration value="MAR"/>
<xsd:enumeration value="MAS"/>
<xsd:enumeration value="MAW"/>
<xsd:enumeration value="MCX"/>
<xsd:enumeration value="MDT"/>
<xsd:enumeration value="MER"/>
<xsd:enumeration value="MID"/>
<xsd:enumeration value="MIK"/>
<xsd:enumeration value="MIN"/>
<xsd:enumeration value="MINA"/>
<xsd:enumeration value="MINB"/>
<xsd:enumeration value="MOD"/>
<xsd:enumeration value="MOD1"/>
<xsd:enumeration value="MOL"/>
<xsd:enumeration value="MPO"/>
<xsd:enumeration value="MVS"/>
<xsd:enumeration value="NAH"/>
<xsd:enumeration value="NAHA"/>
<xsd:enumeration value="NAHB"/>
<xsd:enumeration value="NAHC"/>
<xsd:enumeration value="NAP"/>
<xsd:enumeration value="NAR"/>
<xsd:enumeration value="NARA"/>
<xsd:enumeration value="NARB"/>
<xsd:enumeration value="NARC"/>
<xsd:enumeration value="NARD"/>
<xsd:enumeration value="NARE"/>
<xsd:enumeration value="NARH"/>
<xsd:enumeration value="NAS"/>
<xsd:enumeration value="NASA"/>
<xsd:enumeration value="NASB"/>
<xsd:enumeration value="NASC"/>
<xsd:enumeration value="NASD"/>
<xsd:enumeration value="NASE"/>
<xsd:enumeration value="NASF"/>
<xsd:enumeration value="NASG"/>
<xsd:enumeration value="NASH"/>
<xsd:enumeration value="NASI"/>
<xsd:enumeration value="NASJ"/>
<xsd:enumeration value="NASL"/>
<xsd:enumeration value="NASN"/>
<xsd:enumeration value="NASO"/>
```

```

<xsd:enumeration value="NASP" />
<xsd:enumeration value="NASQ" />
<xsd:enumeration value="NASR" />
<xsd:enumeration value="NAST" />
<xsd:enumeration value="NASU" />
<xsd:enumeration value="NASV" />
<xsd:enumeration value="NASW" />
<xsd:enumeration value="NAX" />
<xsd:enumeration value="NFR1" />
<xsd:enumeration value="Alt: FDA" />
<xsd:enumeration value="NSD" />
<xsd:enumeration value="OCO" />
<xsd:enumeration value="ODU" />
<xsd:enumeration value="OEG" />
<xsd:enumeration value="OGB" />
<xsd:enumeration value="OGBA" />
<xsd:enumeration value="OGBB" />
<xsd:enumeration value="OGBC" />
<xsd:enumeration value="OGBD" />
<xsd:enumeration value="OGBM" />
<xsd:enumeration value="OHA" />
<xsd:enumeration value="OHAA" />
<xsd:enumeration value="OHAB" />
<xsd:enumeration value="OHAC" />
<xsd:enumeration value="OHAD" />
<xsd:enumeration value="OHAM" />
<xsd:enumeration value="OSL" />
<xsd:enumeration value="PAD" />
<xsd:enumeration value="PAD1" />
<xsd:enumeration value="PAL" />
<xsd:enumeration value="PDM" />
<xsd:enumeration value="PHA" />
<xsd:enumeration value="PIT" />
<xsd:enumeration value="PLN" />
<xsd:enumeration value="POS" />
<xsd:enumeration value="PRP" />
<xsd:enumeration value="PRPA" />
<xsd:enumeration value="PRPB" />
<xsd:enumeration value="PRPC" />
<xsd:enumeration value="PRPD" />
<xsd:enumeration value="PRPE" />
<xsd:enumeration value="PRPF" />
<xsd:enumeration value="PRPG" />
<xsd:enumeration value="PRPH" />
<xsd:enumeration value="PRPM" />
<xsd:enumeration value="PTB" />
<xsd:enumeration value="PTN" />
<xsd:enumeration value="PUK" />
<xsd:enumeration value="PUR" />
<xsd:enumeration value="QAT" />
<xsd:enumeration value="QUO" />
<xsd:enumeration value="RAU" />
<xsd:enumeration value="REC" />
<xsd:enumeration value="REU" />
<xsd:enumeration value="RTS" />
<xsd:enumeration value="SAE" />
<xsd:enumeration value="SAF" />
<xsd:enumeration value="SAG" />
<xsd:enumeration value="SAN" />
<xsd:enumeration value="SANA" />
<xsd:enumeration value="SANB" />
<xsd:enumeration value="SANC" />
<xsd:enumeration value="SAND" />
<xsd:enumeration value="SANE" />
<xsd:enumeration value="SANF" />
<xsd:enumeration value="SANG" />
<xsd:enumeration value="SANH" />
<xsd:enumeration value="SANI" />
<xsd:enumeration value="SANJ" />
<xsd:enumeration value="SANK" />
<xsd:enumeration value="SANL" />
<xsd:enumeration value="SANM" />
<xsd:enumeration value="SAO" />
<xsd:enumeration value="SAP" />
<xsd:enumeration value="SCK" />
<xsd:enumeration value="SGA" />

```

```

<xsd:enumeration value="SGB"/>
<xsd:enumeration value="SGM"/>
<xsd:enumeration value="SHB"/>
<xsd:enumeration value="SIB"/>
<xsd:enumeration value="SOA"/>
<xsd:enumeration value="SPK"/>
<xsd:enumeration value="SPX"/>
<xsd:enumeration value="STO"/>
<xsd:enumeration value="SYO"/>
<xsd:enumeration value="TAN"/>
<xsd:enumeration value="TAN1"/>
<xsd:enumeration value="TDC"/>
<xsd:enumeration value="TIL"/>
<xsd:enumeration value="TIN"/>
<xsd:enumeration value="TOY"/>
<xsd:enumeration value="TOYA"/>
<xsd:enumeration value="TOYB"/>
<xsd:enumeration value="TOYC"/>
<xsd:enumeration value="TOYM"/>
<xsd:enumeration value="TRI"/>
<xsd:enumeration value="TRN"/>
<xsd:enumeration value="UND"/>
<xsd:enumeration value="VOI"/>
<xsd:enumeration value="VOI1"/>
<xsd:enumeration value="VOR"/>
<xsd:enumeration value="VOR1"/>
<xsd:enumeration value="WAK"/>
<xsd:enumeration value="WGA"/>
<xsd:enumeration value="WGB"/>
<xsd:enumeration value="WGC"/>
<xsd:enumeration value="WGE"/>
<xsd:enumeration value="YAC"/>
<xsd:enumeration value="ZAN"/>
<xsd:enumeration value="ZYX"/>
</xsd:restriction>
</xsd:simpleType>

```

13.5.150 Direction Name (Simple)

```

<xsd:simpleType name="Direction_name">
  <xsd:restriction base="xsd:string">
    <xsd:enumeration value="right"/>
    <xsd:enumeration value="left"/>
  </xsd:restriction>
</xsd:simpleType>

```

13.5.151 Ellipsoid Name (Simple)

```

<xsd:simpleType name="Ellipsoid_name">
  <xsd:restriction base="xsd:string">
    <xsd:enumeration value="Airy (1830)"/>
    <xsd:enumeration value="US- Modified Airy or UK- Airy Modified"/>
    <xsd:enumeration value="Australian National (1966)"/>
    <xsd:enumeration value="APL 4.5 (1968)"/>
    <xsd:enumeration value="Average Terrestrial System 1977"/>
    <xsd:enumeration value="Airy (War Office)"/>
    <xsd:enumeration value="Bessel (Modified)"/>
    <xsd:enumeration value="Bessel 1841 (Namibia)"/>
    <xsd:enumeration value="US - Bessel 1841 (Ethiopia, Indonesia, Japan, Korea); UK - Bessel
(1841)
    Revised)"/>
    <xsd:enumeration value="Clarke 1858"/>
    <xsd:enumeration value="Clarke 1858 (Modified)"/>
    <xsd:enumeration value="Clarke 1866"/>
    <xsd:enumeration value="US - Clarke 1880; UK - Clarke 1880 Modified"/>
    <xsd:enumeration value="Clarke 1880 (Cape)"/>
    <xsd:enumeration value="Clarke 1880 (Palestine)"/>
    <xsd:enumeration value="Clarke 1880 (IGN)"/>
    <xsd:enumeration value="Clarke 1880 (Syria)"/>
    <xsd:enumeration value="Clarke 1880 (Fiji)"/>
    <xsd:enumeration value="Clarke 1880 (Unspecified)"/>
    <xsd:enumeration value="Danish (1876) or Andrae"/>
    <xsd:enumeration value="Delambre 1810"/>
    <xsd:enumeration value="Delambre (Carte de France)"/>

```

```

<xsd:enumeration value="US - Everest (India 1830); UK - Everest (1830)"/>
<xsd:enumeration value="US - Everest (Brunei and E. Malaysia (Sabah and Sarawak)); UK -
Everest
        (Borneo)"/>
<xsd:enumeration value="US - Everest (India 1956); UK - Everest (India)"/>
<xsd:enumeration value="US - Everest (W. Malaysia 1969); UK - Everest (Malaya RSO)"/>
(Malaya
        RKT)"/>
<xsd:enumeration value="Everest (Pakistan)"/>
<xsd:enumeration value="Everest (Unspecified)"/>
<xsd:enumeration value="US - Modified Fischer 1960 (South Asia); UK - Fischer 1960 (South
        Asia)"/>
<xsd:enumeration value="Fischer 1968"/>
<xsd:enumeration value="Fischer 1960 (Mercury)"/>
<xsd:enumeration value="Germaine (Djibouti)"/>
<xsd:enumeration value="Hayford 1909"/>
<xsd:enumeration value="Helmert 1906"/>
<xsd:enumeration value="Hough 1960"/>
<xsd:enumeration value="IAG Best Estimate 1975"/>
<xsd:enumeration value="Indonesian National (1974)"/>
<xsd:enumeration value="US - International 1924"/>
<xsd:enumeration value="Krassovsky (1940)"/>
<xsd:enumeration value="Krayenhoff 1827"/>
<xsd:enumeration value="No ellipsoid"/>
<xsd:enumeration value="NWL-8E"/>
<xsd:enumeration value="Plessis Modified"/>
<xsd:enumeration value="Plessis Reconstituted"/>
<xsd:enumeration value="Geodetic Reference System 1967"/>
<xsd:enumeration value="Geodetic Reference System 1980"/>
<xsd:enumeration value="South American"/>
<xsd:enumeration value="Soviet Geodetic System 1985"/>
<xsd:enumeration value="Ellipsoid Junction"/>
<xsd:enumeration value="Soviet Geodetic System 1990"/>
<xsd:enumeration value="Struve 1860"/>
<xsd:enumeration value="Svanberg"/>
<xsd:enumeration value="Walbeck 1819 (Planheft 1942)"/>
<xsd:enumeration value="Walbeck 1819 (AMS 1963)"/>
<xsd:enumeration value="World Geodetic System 1966"/>
<xsd:enumeration value="World Geodetic System 1972"/>
<xsd:enumeration value="World Geodetic System 1984"/>
<xsd:enumeration value="World Geodetic System (Unspecified)"/>
<xsd:enumeration value="US - War Office 1924 (McCaw); UK - War Office 1924"/>
<xsd:enumeration value="World Geodetic System 1960"/>
<xsd:enumeration value="Other Known Ellipsoid"/>
<xsd:enumeration value="Unknown Ellipsoid"/>
</xsd:restriction>
</xsd:simpleType>

```

13.5.152 Ellipsoid Value (Simple)

```

<xsd:simpleType name="Ellipsoid_value">
  <xsd:restriction base="xsd:string">
    <xsd:enumeration value="AA"/>
    <xsd:enumeration value="AM"/>
    <xsd:enumeration value="AN"/>
    <xsd:enumeration value="AP"/>
    <xsd:enumeration value="AT"/>
    <xsd:enumeration value="AW"/>
    <xsd:enumeration value="BM"/>
    <xsd:enumeration value="BN"/>
    <xsd:enumeration value="BR"/>
    <xsd:enumeration value="CA"/>
    <xsd:enumeration value="CB"/>
    <xsd:enumeration value="CC"/>
    <xsd:enumeration value="CD"/>
    <xsd:enumeration value="CE"/>
    <xsd:enumeration value="CF"/>
    <xsd:enumeration value="CG"/>
    <xsd:enumeration value="CI"/>
    <xsd:enumeration value="CJ"/>
    <xsd:enumeration value="CL"/>
    <xsd:enumeration value="DA"/>
    <xsd:enumeration value="DB"/>
    <xsd:enumeration value="DC"/>
  </xsd:restriction>
</xsd:simpleType>

```

```
<xsd:enumeration value="EA"/>
<xsd:enumeration value="EB"/>
<xsd:enumeration value="EC"/>
<xsd:enumeration value="ED"/>
<xsd:enumeration value="EE"/>
<xsd:enumeration value="EF"/>
<xsd:enumeration value="EV"/>
<xsd:enumeration value="FA"/>
<xsd:enumeration value="FC"/>
<xsd:enumeration value="FM"/>
<xsd:enumeration value="GE"/>
<xsd:enumeration value="HA"/>
<xsd:enumeration value="HE"/>
<xsd:enumeration value="HO"/>
<xsd:enumeration value="IA"/>
<xsd:enumeration value="ID"/>
<xsd:enumeration value="IN"/>
<xsd:enumeration value="KA"/>
<xsd:enumeration value="KB"/>
<xsd:enumeration value="NO"/>
<xsd:enumeration value="NW"/>
<xsd:enumeration value="PM"/>
<xsd:enumeration value="PR"/>
<xsd:enumeration value="RE"/>
<xsd:enumeration value="RF"/>
<xsd:enumeration value="SA"/>
<xsd:enumeration value="SG"/>
<xsd:enumeration value="SJ"/>
<xsd:enumeration value="SN"/>
<xsd:enumeration value="ST"/>
<xsd:enumeration value="SV"/>
<xsd:enumeration value="WA"/>
<xsd:enumeration value="WB"/>
<xsd:enumeration value="WC"/>
<xsd:enumeration value="WD"/>
<xsd:enumeration value="WE"/>
<xsd:enumeration value="WF"/>
<xsd:enumeration value="WO"/>
<xsd:enumeration value="WS"/>
<xsd:enumeration value="ZY"/>
<xsd:enumeration value="ZZ"/>
</xsd:restriction>
</xsd:simpleType>
```

13.5.153 ETA Connectivity Name (Simple)

```
<xsd:simpleType name="ETA_conn_name">
  <xsd:restriction base="xsd:string">
    <xsd:enumeration value="Artificial ETA connectivity not present"/>
    <xsd:enumeration value="Artificial ETA connectivity present"/>
  </xsd:restriction>
</xsd:simpleType>
```

13.5.154 Feature Category Name (Simple)

```
<xsd:simpleType name="Feature_category_name">
  <xsd:restriction base="xsd:string">
    <xsd:enumeration value="missing"/>
    <xsd:enumeration value="point"/>
    <xsd:enumeration value="line"/>
    <xsd:enumeration value="area"/>
    <xsd:enumeration value="complex"/>
  </xsd:restriction>
</xsd:simpleType>
```

13.5.155 Feature Category Value (Simple)

```
<xsd:simpleType name="Feature_category_value">
  <xsd:restriction base="xsd:integer">
    <xsd:minInclusive value="0"/>
    <xsd:maxInclusive value="4"/>
  </xsd:restriction>
</xsd:simpleType>
```



```
<xsd:enumeration value="94"/>
<xsd:enumeration value="95"/>
<xsd:enumeration value="96"/>
<xsd:enumeration value="97"/>
<xsd:enumeration value="98"/>
<xsd:enumeration value="99"/>
</xsd:restriction>
</xsd:simpleType>
```

13.5.158 Geometry Category Name (Simple)

```
<xsd:simpleType name="Geo_cat_name">
  <xsd:restriction base="xsd:string">
    <xsd:enumeration value="node"/>
    <xsd:enumeration value="edge"/>
    <xsd:enumeration value="face"/>
    <xsd:enumeration value="dot"/>
    <xsd:enumeration value="polyline"/>
    <xsd:enumeration value="polygon"/>
    <xsd:enumeration value="coordinate tuple{s}"/>
  </xsd:restriction>
</xsd:simpleType>
```

13.5.159 Geometry Category Value (Simple)

```
<xsd:simpleType name="Geo_cat_value">
  <xsd:restriction base="xsd:integer">
    <xsd:minInclusive value="1"/>
    <xsd:maxInclusive value="7"/>
    <xsd:enumeration value="1"/>
    <xsd:enumeration value="2"/>
    <xsd:enumeration value="3"/>
    <xsd:enumeration value="4"/>
    <xsd:enumeration value="5"/>
    <xsd:enumeration value="6"/>
    <xsd:enumeration value="7"/>
  </xsd:restriction>
</xsd:simpleType>
```

13.5.160 Grid Name (Simple)

```
<xsd:simpleType name="Grid_name">
  <xsd:restriction base="xsd:string">
    <xsd:maxLength value="50"/>
    <xsd:enumeration value="Aden Zone"/>
    <xsd:enumeration value="Afghanistan Gauss-Krüger Grid"/>
    <xsd:enumeration value="Air Defense Grid"/>
    <xsd:enumeration value="Air Support Grid"/>
    <xsd:enumeration value="Alabama Coordinate System"/>
    <xsd:enumeration value="Alaska Coordinate System"/>
    <xsd:enumeration value="Algeria Zone"/>
    <xsd:enumeration value="Albania Bonne Grid"/>
    <xsd:enumeration value="Alpha-Numeric (Atlas) Grid"/>
    <xsd:enumeration value="Arbitrary Grid"/>
    <xsd:enumeration value="American Samoa Coordinate System"/>
    <xsd:enumeration value="Argentine Gauss-Krüger Conformal Grid"/>
    <xsd:enumeration value="Artillery Referencing System"/>
    <xsd:enumeration value="Arizona Coordinate System"/>
    <xsd:enumeration value="Map Grid of Australia 1994 (MGA94)"/>
    <xsd:enumeration value="Australia Belt"/>
    <xsd:enumeration value="Arkansas Coordinate System"/>
    <xsd:enumeration value="Australian Map Grid"/>
    <xsd:enumeration value="Azores Gauss Conformal Grid"/>
    <xsd:enumeration value="Azores Zone"/>
    <xsd:enumeration value="Baku 1927 Coordinate System"/>
    <xsd:enumeration value="Bavaria Soldner Coordinate System"/>
    <xsd:enumeration value="Belgium Lambert Grid"/>
    <xsd:enumeration value="Baltic Region Transverse Mercator Grid"/>
    <xsd:enumeration value="Belgium Bonne Grid"/>
    <xsd:enumeration value="Brazil Gauss Conformal Grid"/>
    <xsd:enumeration value="Soldner-Berlin (Müggelberg) Grid"/>
    <xsd:enumeration value="Borneo Rectified Skew Orthomorphic Grid"/>
    <xsd:enumeration value="British West Indies Grid"/>
  </xsd:restriction>
</xsd:simpleType>
```



```
<xsd:enumeration value="California Coordinate System"/>
<xsd:enumeration value="Canada British Modified Grid"/>
<xsd:enumeration value="Ceylon Belt (Transverse Mercator)"/>
<xsd:enumeration value="Canary Islands (Spanish Lambert Grid)"/>
<xsd:enumeration value="Chile Gauss Conformal Grid"/>
<xsd:enumeration value="China Belt"/>
<xsd:enumeration value="Canary Islands Zone"/>
<xsd:enumeration value="China Lambert Zone"/>
<xsd:enumeration value="Colorado Coordinate Zone"/>
<xsd:enumeration value="Connecticut Coordinate System"/>
<xsd:enumeration value="Caspian Zone"/>
<xsd:enumeration value="Costa Rica Lambert Grid"/>
<xsd:enumeration value="Crimea Grid"/>
<xsd:enumeration value="Crete Zone"/>
<xsd:enumeration value="Cuba Lambert Grid"/>
<xsd:enumeration value="Caucasus Zone"/>
<xsd:enumeration value="Cape Verde Islands Zone"/>
<xsd:enumeration value="British Cassini Grid"/>
<xsd:enumeration value="Czechoslovak Uniform Cadastral Coordinate System"/>
<xsd:enumeration value="Cyprus Grid"/>
<xsd:enumeration value="Czechoslovak Military Grid"/>
<xsd:enumeration value="Danube Zone"/>
<xsd:enumeration value="Dahomey Belt"/>
<xsd:enumeration value="Denmark General Staff Grid"/>
<xsd:enumeration value="Delaware Coordinate System"/>
<xsd:enumeration value="Dominican Lambert Grid"/>
<xsd:enumeration value="Denmark Geodetic Institute System 1934"/>
<xsd:enumeration value="Cape Verde Peninsula Grid"/>
<xsd:enumeration value="East Africa Belt"/>
<xsd:enumeration value="English Belt"/>
<xsd:enumeration value="Egypt Gauss Conformal Grid"/>
<xsd:enumeration value="El Salvador Lambert Grid"/>
<xsd:enumeration value="Estonian Grid"/>
<xsd:enumeration value="Estonian Lambert Conformal Grid"/>
<xsd:enumeration value="Hungarian Unified National Mapping System (EOTR)"/>
<xsd:enumeration value="Egypt Purple Belt"/>
<xsd:enumeration value="Egypt Red Belt"/>
<xsd:enumeration value="Egypt 35 Degree Belt"/>
<xsd:enumeration value="Fernando Poo Gauss Grid"/>
<xsd:enumeration value="Fiji Grid"/>
<xsd:enumeration value="Florida Coordinate System"/>
<xsd:enumeration value="French Bonne Grid"/>
<xsd:enumeration value="French Guiana Gauss Grid"/>
<xsd:enumeration value="French Somaliland Gauss-Laborde Grid"/>
<xsd:enumeration value="French Indochina Grid"/>
<xsd:enumeration value="Franz Josef Land Zone"/>
<xsd:enumeration value="French Lambert Grid"/>
<xsd:enumeration value="Formosa (Taiwan) Gauss-Schreiber Coordinate System"/>
<xsd:enumeration value="French Equatorial Africa Grid"/>
<xsd:enumeration value="Gabon Belt"/>
<xsd:enumeration value="Gauss-Boaga Grid (Transverse Mercator)"/>
<xsd:enumeration value="Gabon Gauss Conformal Grid"/>
<xsd:enumeration value="Geographic Reference System (GEOREF)"/>
<xsd:enumeration value="Guadeloupe Gauss-Laborde Grid"/>
<xsd:enumeration value="Colombia Gauss Conformal Grid"/>
<xsd:enumeration value="Sweden Gauss-Hannover Grid"/>
<xsd:enumeration value="Georgia Coordinate System"/>
<xsd:enumeration value="Gauss-KrÄuer Grid (Transverse Mercator)"/>
<xsd:enumeration value="Greece Azimuthal Grid"/>
<xsd:enumeration value="German Army Grid (DHG)"/>
<xsd:enumeration value="Ghana National Grid"/>
<xsd:enumeration value="Greece Bonne Grid"/>
<xsd:enumeration value="Greece Conical Mecklenburg Coordinates"/>
<xsd:enumeration value="Greece Conical Mecklenburg Coordinate (New Numbering)"/>
<xsd:enumeration value="Greenland Lambert Grid"/>
<xsd:enumeration value="Guinea Zone"/>
<xsd:enumeration value="Guam Coordinate System"/>
<xsd:enumeration value="Guatemala Lambert Grid"/>
<xsd:enumeration value="Guyana Transverse Mercator Grid"/>
<xsd:enumeration value="Haiti Lambert Grid"/>
<xsd:enumeration value="Hawaii Coordinate System"/>
<xsd:enumeration value="Hawaii Grid"/>
<xsd:enumeration value="Honduras Lambert Grid"/>
<xsd:enumeration value="Hong Kong New System Cassini Grid"/>
<xsd:enumeration value="Hungary Stereographic Grid"/>
<xsd:enumeration value="Hong Kong Colony Grid"/>
```

```
<xsd:enumeration value="Idaho Coordinate System"/>
<xsd:enumeration value="Illinois Coordinate System"/>
<xsd:enumeration value="Indiana Coordinate System"/>
<xsd:enumeration value="Indonesia Mercator Grid"/>
<xsd:enumeration value="Indonesia Polyhedral Grid"/>
<xsd:enumeration value="Iowa Coordinate System"/>
<xsd:enumeration value="Ivory Coast Azimuthal Grid"/>
<xsd:enumeration value="Irish Cassini Grid"/>
<xsd:enumeration value="Ivory Coast Belt"/>
<xsd:enumeration value="Irish Transverse Mercator Grid"/>
<xsd:enumeration value="Iceland New Lambert Zone"/>
<xsd:enumeration value="India Zone"/>
<xsd:enumeration value="Iberian Peninsula Zone"/>
<xsd:enumeration value="Iraq Zone"/>
<xsd:enumeration value="Iraq National Grid"/>
<xsd:enumeration value="Italy Zone"/>
<xsd:enumeration value="Ivy - Found on an HA in Marshall Islands"/>
<xsd:enumeration value="Iceland Zone"/>
<xsd:enumeration value="Jamaica Foot Grid"/>
<xsd:enumeration value="Japan Plane-Rectangular Coordinate System"/>
<xsd:enumeration value="Japan Gauss-Schreiber Grid"/>
<xsd:enumeration value="Jamaica National Grid (metric)"/>
<xsd:enumeration value="Johore Grid"/>
<xsd:enumeration value="Austria Gauss-Krüger Grid"/>
<xsd:enumeration value="Bulgaria Gauss-Krüger Grid"/>
<xsd:enumeration value="Katanga Grid"/>
<xsd:enumeration value="Kansas Coordinate System"/>
<xsd:enumeration value="Kentucky Coordinate System"/>
<xsd:enumeration value="Finland Gauss-Krüger Grid"/>
<xsd:enumeration value="German Gauss-Krüger Grid"/>
<xsd:enumeration value="Kenya Colony Grid"/>
<xsd:enumeration value="Korea Gauss-Schreiber Coordinate System"/>
<xsd:enumeration value="Louisiana Coordinate System"/>
<xsd:enumeration value="Lithuania Gauss-Krüger Grid"/>
<xsd:enumeration value="Kwantung Province Grid"/>
<xsd:enumeration value="Turkey Gauss-Krüger Grid"/>
<xsd:enumeration value="Kwangsi Province Grid"/>
<xsd:enumeration value="Luxembourg Gauss-Krüger Grid"/>
<xsd:enumeration value="Lambert Conformal Conic Grid"/>
<xsd:enumeration value="Latvia Coordinate System"/>
<xsd:enumeration value="Levant Zone"/>
<xsd:enumeration value="Levant Stereographic Grid"/>
<xsd:enumeration value="Liberia Rectified Skew Orthomorphic Grid"/>
<xsd:enumeration value="Libya Zone"/>
<xsd:enumeration value="Lithuanian LKS-94 Grid"/>
<xsd:enumeration value="Sirte (Libya) Lambert Grid"/>
<xsd:enumeration value="Malaya Grid"/>
<xsd:enumeration value="Malta Belt"/>
<xsd:enumeration value="Maldives-Chagos Belt"/>
<xsd:enumeration value="Madiera Zone"/>
<xsd:enumeration value="Mediterranean Zone"/>
<xsd:enumeration value="Maine Coordinate System"/>
<xsd:enumeration value="Malaya Rectified Skew Orthomorphic (Yard) Grid"/>
<xsd:enumeration value="Martinique Gauss Grid"/>
<xsd:enumeration value="Maryland Coordinate System"/>
<xsd:enumeration value="Massachusetts Coordinate System"/>
<xsd:enumeration value="Mexican Lambert Grid"/>
<xsd:enumeration value="Michigan Coordinate System"/>
<xsd:enumeration value="Mecca-Muscat Zone"/>
<xsd:enumeration value="Minnesota Coordinate System"/>
<xsd:enumeration value="Madagascar Grid (Laborde)"/>
<xsd:enumeration value="Mississippi Coordinate System"/>
<xsd:enumeration value="Morocco Zone"/>
<xsd:enumeration value="Other Known Grid"/>
<xsd:enumeration value="Missouri Coordinate System"/>
<xsd:enumeration value="Mauritius Zone"/>
<xsd:enumeration value="Montana Coordinate System"/>
<xsd:enumeration value="Mozambique Lambert Grid"/>
<xsd:enumeration value="Mozambique Polyconic Grid"/>
<xsd:enumeration value="Northwest Africa Zone"/>
<xsd:enumeration value="New Jersey Coordinate System"/>
<xsd:enumeration value="Nigeria Colony Belt"/>
<xsd:enumeration value="National Grid of Great Britain"/>
<xsd:enumeration value="Northern European Zone"/>
<xsd:enumeration value="Nebraska Coordinate System"/>
<xsd:enumeration value="Numeric Grid"/>
```

```

<xsd:enumeration value="New Hampshire Coordinate System"/>
<xsd:enumeration value="Niger Zone"/>
<xsd:enumeration value="Netherlands Stereographic Grid (Old Numbering)"/>
<xsd:enumeration value="North Korea Gauss-Krüger Grid"/>
<xsd:enumeration value="Netherlands Stereographic Grid (New Numbering)"/>
(Lambert)"/>
<xsd:enumeration value="Netherlands East Indies Equatorial Zone British Metric Grid
<xsd:enumeration value="Nord de Guerre Zone"/>
<xsd:enumeration value="New Mexico Coordinate System"/>
<xsd:enumeration value="Nevada Coordinate System"/>
<xsd:enumeration value="New Sierra Leone Colony Grid"/>
<xsd:enumeration value="New York Coordinate System"/>
<xsd:enumeration value="Netherlands East Indies Southern Zone"/>
<xsd:enumeration value="New Zealand Map Grid (NZMG)"/>
<xsd:enumeration value="Nicaragua Lambert Grid"/>
<xsd:enumeration value="Niger Belt"/>
<xsd:enumeration value="North Carolina Coordinate System"/>
<xsd:enumeration value="North Dakota Coordinate System"/>
<xsd:enumeration value="Netherlands East Indies Equatorial Zone U.S. Yard Grid"/>
<xsd:enumeration value="New Zealand Belt"/>
<xsd:enumeration value="Northern Malaya Grid"/>
<xsd:enumeration value="Norway Gauss-Krüger Grid"/>
<xsd:enumeration value="Ohio Coordinate System"/>
<xsd:enumeration value="Oklahoma Coordinate System"/>
<xsd:enumeration value="Orange Report Net"/>
<xsd:enumeration value="Oregon Coordinate System"/>
<xsd:enumeration value="Palestine Belt"/>
<xsd:enumeration value="Panama Lambert Grid"/>
<xsd:enumeration value="Palestine Civil Grid (Cassini)"/>
<xsd:enumeration value="Paraguay Gauss-Krüger Grid"/>
<xsd:enumeration value="Peiping Coordinate System of 1954"/>
<xsd:enumeration value="Pennsylvania Coordinate System"/>
<xsd:enumeration value="Polish PSWG 1992 Grid"/>
<xsd:enumeration value="Peru Polyconic Grid"/>
<xsd:enumeration value="Philippine Plane Coordinate System"/>
<xsd:enumeration value="Poland Gauss-Krüger Grid"/>
<xsd:enumeration value="Poland Quasi-Stereographic Grid"/>
<xsd:enumeration value="Philippine Polyconic Grid"/>
<xsd:enumeration value="Portugal Bonne Grid, Old"/>
<xsd:enumeration value="Portugal Bonne Grid, New"/>
<xsd:enumeration value="Portugal Gauss Grid"/>
<xsd:enumeration value="Puerto Rico & Virgin Islands Coordinate System"/>
<xsd:enumeration value="Puerto Rico Lambert Grid"/>
<xsd:enumeration value="Qatar Cassini Grid"/>
<xsd:enumeration value="Qatar Peninsula Grid (or Qatar National Grid (TM))"/>
<xsd:enumeration value="Russian Belt"/>
<xsd:enumeration value="Reunion Gauss Grid"/>
<xsd:enumeration value="Rhode Island Coordinate System"/>
<xsd:enumeration value="Romania Bonne Grid"/>
<xsd:enumeration value="Soviet Coordinate System of 1942"/>
<xsd:enumeration value="Romania Lambert-Cholesky Grid"/>
<xsd:enumeration value="Rikets National Grid"/>
<xsd:enumeration value="Romania Stereographic Grid"/>
<xsd:enumeration value="Pulkovo Coordinate System of 1932"/>
<xsd:enumeration value="South Africa Belt (yards)"/>
<xsd:enumeration value="Senegal Gauss Conformal Grid (Belt)"/>
feet)"/>
<xsd:enumeration value="South Africa Coordinate System (South Africa Belt (English
<xsd:enumeration value="Senegal Belt"/>
<xsd:enumeration value="South Carolina Coordinate System"/>
<xsd:enumeration value="Sahara Zone"/>
<xsd:enumeration value="South Dakota Coordinate System"/>
<xsd:enumeration value="South Libya Zone"/>
<xsd:enumeration value="Sarawak Grid"/>
<xsd:enumeration value="Spain Lambert Grid"/>
<xsd:enumeration value="Southern New Guinea Grid"/>
<xsd:enumeration value="South Georgia Lambert Grid"/>
<xsd:enumeration value="South Syria Lambert Grid"/>
<xsd:enumeration value="Spanish North-Morocco Lambert Grid"/>
<xsd:enumeration value="Svalbard Gauss-Krüger Grid"/>
<xsd:enumeration value="Svobodny 1935 Coordinate System"/>
<xsd:enumeration value="Seychelles Belt"/>
<xsd:enumeration value="Spitzbergen Zone"/>
<xsd:enumeration value="Tanganyika Territorial Grid"/>
<xsd:enumeration value="Tashkent 1875 Coordinate System"/>
<xsd:enumeration value="Tennessee Coordinate System"/>

```

```
<xsd:enumeration value="Texas Coordinate System"/>
<xsd:enumeration value="Tobago Grid"/>
<xsd:enumeration value="Trinidad Grid"/>
<xsd:enumeration value="Trucial Coast Cassini Grid"/>
<xsd:enumeration value="Trucial Coast Transverse Mercator Grid"/>
<xsd:enumeration value="Turkey Bonne Grid"/>
<xsd:enumeration value="Tunisia Zone"/>
<xsd:enumeration value="Uganda Cassini Coordinate System"/>
<xsd:enumeration value="Unidentified Grid"/>
<xsd:enumeration value="Uruguay Gauss-Krüger Grid"/>
<xsd:enumeration value="Utah Coordinate System"/>
<xsd:enumeration value="Universal Polar Stereographic System"/>
<xsd:enumeration value="U.S. Polyconic Grid System"/>
<xsd:enumeration value="Universal Transverse Mercator"/>
<xsd:enumeration value="Vermont Coordinate System"/>
<xsd:enumeration value="Virginia Coordinate System"/>
<xsd:enumeration value="Venezuela Modified Lambert Grid"/>
<xsd:enumeration value="Vietnam Azimuthal Grid"/>
<xsd:enumeration value="West Malaysia Rectified Skew Orthomorphic (Metric) Grid"/>
<xsd:enumeration value="Switzerland Bonne Grid"/>
<xsd:enumeration value="Switzerland Conformal Oblique Cylindrical Grid"/>
<xsd:enumeration value="West Virginia Coordinate System"/>
<xsd:enumeration value="Wisconsin Coordinate System"/>
<xsd:enumeration value="Wyoming Coordinate System"/>
<xsd:enumeration value="Washington Coordinate System"/>
<xsd:enumeration value="World Polyconic System"/>
<xsd:enumeration value="Yugoslavia Gauss-Krüger Grid (Not Reduced)"/>
<xsd:enumeration value="Yugoslavia Reduced Gauss-Krüger Grid"/>
<xsd:enumeration value="Yunnan Province Grid"/>
</xsd:restriction>
</xsd:simpleType>
```

13.5.161 Grid Value (Simple)

```
<xsd:simpleType name="Grid_value">
  <xsd:restriction base="xsd:string">
    <xsd:length value="2"/>
    <xsd:enumeration value="AD"/>
    <xsd:enumeration value="AF"/>
    <xsd:enumeration value="AG"/>
    <xsd:enumeration value="AI"/>
    <xsd:enumeration value="AJ"/>
    <xsd:enumeration value="AK"/>
    <xsd:enumeration value="AL"/>
    <xsd:enumeration value="AM"/>
    <xsd:enumeration value="AN"/>
    <xsd:enumeration value="AO"/>
    <xsd:enumeration value="AP"/>
    <xsd:enumeration value="AQ"/>
    <xsd:enumeration value="AR"/>
    <xsd:enumeration value="AS"/>
    <xsd:enumeration value="AT"/>
    <xsd:enumeration value="AU"/>
    <xsd:enumeration value="AV"/>
    <xsd:enumeration value="AW"/>
    <xsd:enumeration value="AX"/>
    <xsd:enumeration value="AZ"/>
    <xsd:enumeration value="BA"/>
    <xsd:enumeration value="BB"/>
    <xsd:enumeration value="BC"/>
    <xsd:enumeration value="BD"/>
    <xsd:enumeration value="BE"/>
    <xsd:enumeration value="BF"/>
    <xsd:enumeration value="BL"/>
    <xsd:enumeration value="BO"/>
    <xsd:enumeration value="BW"/>
    <xsd:enumeration value="CB"/>
    <xsd:enumeration value="CD"/>
    <xsd:enumeration value="CE"/>
    <xsd:enumeration value="CF"/>
    <xsd:enumeration value="CG"/>
    <xsd:enumeration value="CH"/>
    <xsd:enumeration value="CI"/>
    <xsd:enumeration value="CJ"/>
    <xsd:enumeration value="CK"/>
  </xsd:restriction>
</xsd:simpleType>
```



```
<xsd:enumeration value="UP"/>
<xsd:enumeration value="US"/>
<xsd:enumeration value="UT"/>
<xsd:enumeration value="VA"/>
<xsd:enumeration value="VB"/>
<xsd:enumeration value="VE"/>
<xsd:enumeration value="VI"/>
<xsd:enumeration value="WA"/>
<xsd:enumeration value="WB"/>
<xsd:enumeration value="WC"/>
<xsd:enumeration value="WD"/>
<xsd:enumeration value="WE"/>
<xsd:enumeration value="WF"/>
<xsd:enumeration value="WH"/>
<xsd:enumeration value="WP"/>
<xsd:enumeration value="YA"/>
<xsd:enumeration value="YG"/>
<xsd:enumeration value="YU"/>
</xsd:restriction>
</xsd:simpleType>
```

13.5.162 Height Reference Type Name (Simple)

```
<xsd:simpleType name="Height_ref_type_name">
  <xsd:restriction base="xsd:string">
    <xsd:enumeration value="ellipsoidal"/>
    <xsd:enumeration value="orthometric"/>
    <xsd:enumeration value="relative"/>
  </xsd:restriction>
</xsd:simpleType>
```

13.5.163 Height Reference Type Value (Simple)

```
<xsd:simpleType name="Height_ref_type_value">
  <xsd:restriction base="xsd:integer">
    <xsd:minInclusive value="0"/>
    <xsd:maxInclusive value="2"/>
  </xsd:restriction>
</xsd:simpleType>
```

13.5.164 Layer Topology Name (Simple)

```
<xsd:simpleType name="Layer_topo_name">
  <xsd:restriction base="xsd:string">
    <xsd:maxLength value="40"/>
    <xsd:enumeration value="non-explicit"/>
    <xsd:enumeration value="connectivity"/>
    <xsd:enumeration value="full"/>
  </xsd:restriction>
</xsd:simpleType>
```

13.5.165 Layer Topology Value (Simple)

```
<xsd:simpleType name="Layer_topo_value">
  <xsd:restriction base="xsd:int">
    <xsd:minInclusive value="1"/>
    <xsd:maxInclusive value="3"/>
  </xsd:restriction>
</xsd:simpleType>
```

13.5.166 Language Code Name (Simple)

```
<xsd:simpleType name="Lang_code_name">
  <xsd:restriction base="xsd:string">
    <xsd:enumeration value="Afar"/>
    <xsd:enumeration value="Abkhaz"/>
    <xsd:enumeration value="Achinese"/>
    <xsd:enumeration value="Acoli"/>
    <xsd:enumeration value="Adangme"/>
    <xsd:enumeration value="Adygei"/>
    <xsd:enumeration value="Afroasiatic (Other)"/>
    <xsd:enumeration value="Afrihili (Artificial language)"/>
  </xsd:restriction>
</xsd:simpleType>
```



```
<xsd:enumeration value="Afrikaans" />
<xsd:enumeration value="Akan" />
<xsd:enumeration value="Akkadian" />
<xsd:enumeration value="Albanian" />
<xsd:enumeration value="Aleut" />
<xsd:enumeration value="Algonquian (Other)" />
<xsd:enumeration value="Amharic" />
<xsd:enumeration value="English, Old (ca. 450-1100)" />
<xsd:enumeration value="Apache languages" />
<xsd:enumeration value="Arabic" />
<xsd:enumeration value="Aramaic" />
<xsd:enumeration value="Aragonese Spanish" />
<xsd:enumeration value="Armenian" />
<xsd:enumeration value="Mapuche" />
<xsd:enumeration value="Arapaho" />
<xsd:enumeration value="Artificial (Other)" />
<xsd:enumeration value="Arawak" />
<xsd:enumeration value="Assamese" />
<xsd:enumeration value="Bable" />
<xsd:enumeration value="Athapascan (Other)" />
<xsd:enumeration value="Australian languages" />
<xsd:enumeration value="Avaric" />
<xsd:enumeration value="Avestan" />
<xsd:enumeration value="Awadhi" />
<xsd:enumeration value="Aymara" />
<xsd:enumeration value="Azerbaijani" />
<xsd:enumeration value="Banda" />
<xsd:enumeration value="Bamileke languages" />
<xsd:enumeration value="Bashkir" />
<xsd:enumeration value="Baluchi" />
<xsd:enumeration value="Bambara" />
<xsd:enumeration value="Balinese" />
<xsd:enumeration value="Basque" />
<xsd:enumeration value="Basa" />
<xsd:enumeration value="Baltic (Other)" />
<xsd:enumeration value="Beja" />
<xsd:enumeration value="Belarusian" />
<xsd:enumeration value="Bemba" />
<xsd:enumeration value="Bengali" />
<xsd:enumeration value="Berber (Other)" />
<xsd:enumeration value="Bhojpuri" />
<xsd:enumeration value="Bihari" />
<xsd:enumeration value="Bikol" />
<xsd:enumeration value="Edo" />
<xsd:enumeration value="Bislama" />
<xsd:enumeration value="Siksika" />
<xsd:enumeration value="Bantu (Other)" />
<xsd:enumeration value="Bosnian" />
<xsd:enumeration value="Braj" />
<xsd:enumeration value="Breton" />
<xsd:enumeration value="Batak" />
<xsd:enumeration value="Buriat" />
<xsd:enumeration value="Bugis" />
<xsd:enumeration value="Bulgarian" />
<xsd:enumeration value="Burmese" />
<xsd:enumeration value="Caddo" />
<xsd:enumeration value="Central American Indian (Other)" />
<xsd:enumeration value="Carib" />
<xsd:enumeration value="Catalan" />
<xsd:enumeration value="Caucasian (Other)" />
<xsd:enumeration value="Cebuano" />
<xsd:enumeration value="Celtic (Other)" />
<xsd:enumeration value="Chamorro" />
<xsd:enumeration value="Chibcha" />
<xsd:enumeration value="Chechen" />
<xsd:enumeration value="Chagatai" />
<xsd:enumeration value="Chinese" />
<xsd:enumeration value="Truk" />
<xsd:enumeration value="Mari" />
<xsd:enumeration value="Chinook jargon" />
<xsd:enumeration value="Choctaw" />
<xsd:enumeration value="Chipewyan" />
<xsd:enumeration value="Cherokee" />
<xsd:enumeration value="Church Slavic" />
<xsd:enumeration value="Chuvash" />
<xsd:enumeration value="Cheyenne" />
```

```
<xsd:enumeration value="Chamic languages" />
<xsd:enumeration value="Coptic" />
<xsd:enumeration value="Cornish" />
<xsd:enumeration value="Corsican" />
<xsd:enumeration value="Creoles and Pidgins, English-based (Other)" />
<xsd:enumeration value="Creoles and Pidgins, French-based (Other)" />
<xsd:enumeration value="Creoles and Pidgins, Portuguese-based (Other)" />
<xsd:enumeration value="Cree" />
<xsd:enumeration value="Crimean Tatar" />
<xsd:enumeration value="Creoles and Pidgins (Other)" />
<xsd:enumeration value="Cushitic (Other)" />
<xsd:enumeration value="Czech" />
<xsd:enumeration value="Dakota" />
<xsd:enumeration value="Danish" />
<xsd:enumeration value="Dargwa" />
<xsd:enumeration value="Dayak" />
<xsd:enumeration value="Delaware" />
<xsd:enumeration value="Slave" />
<xsd:enumeration value="Dogrib" />
<xsd:enumeration value="Dinka" />
<xsd:enumeration value="Divehi" />
<xsd:enumeration value="Dogri" />
<xsd:enumeration value="Dravidian (Other)" />
<xsd:enumeration value="Duala" />
<xsd:enumeration value="Dutch, Middle (ca. 1050-1350)" />
<xsd:enumeration value="Dutch" />
<xsd:enumeration value="Dyula" />
<xsd:enumeration value="Dzongkha" />
<xsd:enumeration value="Efik" />
<xsd:enumeration value="Egyptian" />
<xsd:enumeration value="Ekajuk" />
<xsd:enumeration value="Elamite" />
<xsd:enumeration value="English" />
<xsd:enumeration value="English, Middle (1100-1500)" />
<xsd:enumeration value="Esperanto" />
<xsd:enumeration value="Estonian" />
<xsd:enumeration value="Ewe" />
<xsd:enumeration value="Ewondo" />
<xsd:enumeration value="Fang" />
<xsd:enumeration value="Faroese" />
<xsd:enumeration value="Fanti" />
<xsd:enumeration value="Fijian" />
<xsd:enumeration value="Finnish" />
<xsd:enumeration value="Finno-Ugrian (Other)" />
<xsd:enumeration value="Fon" />
<xsd:enumeration value="French" />
<xsd:enumeration value="French, Middle (ca. 1400-1600)" />
<xsd:enumeration value="French, Old (ca. 842-1400)" />
<xsd:enumeration value="Frisian" />
<xsd:enumeration value="Fula" />
<xsd:enumeration value="Friulian" />
<xsd:enumeration value="Gä" />
<xsd:enumeration value="Gayo" />
<xsd:enumeration value="Gbaya" />
<xsd:enumeration value="Germanic (Other)" />
<xsd:enumeration value="Georgian" />
<xsd:enumeration value="German" />
<xsd:enumeration value="Ethiopic" />
<xsd:enumeration value="Gilbertese" />
<xsd:enumeration value="Scottish Gaelic" />
<xsd:enumeration value="Irish" />
<xsd:enumeration value="Galician" />
<xsd:enumeration value="Manx" />
<xsd:enumeration value="German, Middle High (ca. 1050-1500)" />
<xsd:enumeration value="German, Old High (ca. 750-1050)" />
<xsd:enumeration value="Gondi" />
<xsd:enumeration value="Gorontalo" />
<xsd:enumeration value="Gothic" />
<xsd:enumeration value="Grebo" />
<xsd:enumeration value="Greek, Ancient (to 1453)" />
<xsd:enumeration value="Greek, Modern (1453- )" />
<xsd:enumeration value="Guarani" />
<xsd:enumeration value="Gujarati" />
<xsd:enumeration value="Gwich'in" />
<xsd:enumeration value="Haida" />
<xsd:enumeration value="Haitian French Creole" />
```

```

<xsd:enumeration value="Hausa" />
<xsd:enumeration value="Hawaiian" />
<xsd:enumeration value="Hebrew" />
<xsd:enumeration value="Herero" />
<xsd:enumeration value="Hiligaynon" />
<xsd:enumeration value="Himachali" />
<xsd:enumeration value="Hindi" />
<xsd:enumeration value="Hittite" />
<xsd:enumeration value="Hmong" />
<xsd:enumeration value="Hiri Motu" />
<xsd:enumeration value="Hungarian" />
<xsd:enumeration value="Hupa" />
<xsd:enumeration value="Iban" />
<xsd:enumeration value="Igbo" />
<xsd:enumeration value="Icelandic" />
<xsd:enumeration value="Ido" />
<xsd:enumeration value="Sichuan Yi" />
<xsd:enumeration value="Ijo" />
<xsd:enumeration value="Inuktitut" />
<xsd:enumeration value="Interlingue" />
<xsd:enumeration value="Iloko" />
<xsd:enumeration value="Interlingua (International Auxiliary Language Association)" />
<xsd:enumeration value="Indic (Other)" />
<xsd:enumeration value="Indonesian" />
<xsd:enumeration value="Indo-European (Other)" />
<xsd:enumeration value="Ingush" />
<xsd:enumeration value="Inupiaq" />
<xsd:enumeration value="Iranian (Other)" />
<xsd:enumeration value="Iroquoian (Other)" />
<xsd:enumeration value="Italian" />
<xsd:enumeration value="Javanese" />
<xsd:enumeration value="Japanese" />
<xsd:enumeration value="Judeo-Persian" />
<xsd:enumeration value="Judeo-Arabic" />
<xsd:enumeration value="Kara-Kalpak" />
<xsd:enumeration value="Kabyle" />
<xsd:enumeration value="Kachin" />
<xsd:enumeration value="Kalâtdlisut" />
<xsd:enumeration value="Kamba" />
<xsd:enumeration value="Kannada" />
<xsd:enumeration value="Karen" />
<xsd:enumeration value="Kashmiri" />
<xsd:enumeration value="Kanuri" />
<xsd:enumeration value="Kawi" />
<xsd:enumeration value="Kazakh" />
<xsd:enumeration value="Kabardian" />
<xsd:enumeration value="Khasi" />
<xsd:enumeration value="Khoisan (Other)" />
<xsd:enumeration value="Khmer" />
<xsd:enumeration value="Khotanese" />
<xsd:enumeration value="Kikuyu" />
<xsd:enumeration value="Kinyarwanda" />
<xsd:enumeration value="Kyrgyz" />
<xsd:enumeration value="Kimbundu" />
<xsd:enumeration value="Konkani" />
<xsd:enumeration value="Komi" />
<xsd:enumeration value="Kongo" />
<xsd:enumeration value="Korean" />
<xsd:enumeration value="Kusaie" />
<xsd:enumeration value="Kpelle" />
<xsd:enumeration value="Kru" />
<xsd:enumeration value="KuruKh" />
<xsd:enumeration value="Kuanyama" />
<xsd:enumeration value="Kumyk" />
<xsd:enumeration value="Kurdish" />
<xsd:enumeration value="Kutenai" />
<xsd:enumeration value="Ladino" />
<xsd:enumeration value="Lahnda" />
<xsd:enumeration value="Lamba" />
<xsd:enumeration value="Lao" />
<xsd:enumeration value="Latin" />
<xsd:enumeration value="Latvian" />
<xsd:enumeration value="Lezgian" />
<xsd:enumeration value="Limburgish" />
<xsd:enumeration value="Lingala" />
<xsd:enumeration value="Lithuanian" />

```

```
<xsd:enumeration value="Mongo-Nkundu"/>
<xsd:enumeration value="Lozi"/>
<xsd:enumeration value="Letzeburgesch"/>
<xsd:enumeration value="Luba-Lulua"/>
<xsd:enumeration value="Luba-Katanga"/>
<xsd:enumeration value="Ganda"/>
<xsd:enumeration value="Luiseño"/>
<xsd:enumeration value="Lunda"/>
<xsd:enumeration value="Luo (Kenya and Tanzania)"/>
<xsd:enumeration value="Lushai"/>
<xsd:enumeration value="Macedonian"/>
<xsd:enumeration value="Madurese"/>
<xsd:enumeration value="Magahi"/>
<xsd:enumeration value="Marshallese"/>
<xsd:enumeration value="Maithili"/>
<xsd:enumeration value="Makasar"/>
<xsd:enumeration value="Malayalam"/>
<xsd:enumeration value="Mandingo"/>
<xsd:enumeration value="Maori"/>
<xsd:enumeration value="Austronesian (Other)"/>
<xsd:enumeration value="Marathi"/>
<xsd:enumeration value="Masai"/>
<xsd:enumeration value="Malay"/>
<xsd:enumeration value="Mandar"/>
<xsd:enumeration value="Mende"/>
<xsd:enumeration value="Irish, Middle (ca. 1100-1550)"/>
<xsd:enumeration value="Micmac"/>
<xsd:enumeration value="Minangkabau"/>
<xsd:enumeration value="Miscellaneous languages"/>
<xsd:enumeration value="Mon-Khmer (Other)"/>
<xsd:enumeration value="Malagasy"/>
<xsd:enumeration value="Maltese"/>
<xsd:enumeration value="Manchu"/>
<xsd:enumeration value="Manipuri"/>
<xsd:enumeration value="Manobo languages"/>
<xsd:enumeration value="Mohawk"/>
<xsd:enumeration value="Moldavian"/>
<xsd:enumeration value="Mongolian"/>
<xsd:enumeration value="Mooré"/>
<xsd:enumeration value="Multiple languages"/>
<xsd:enumeration value="Munda (Other)"/>
<xsd:enumeration value="Creek"/>
<xsd:enumeration value="Marwari"/>
<xsd:enumeration value="Mayan languages"/>
<xsd:enumeration value="Nahuatl"/>
<xsd:enumeration value="North American Indian (Other)"/>
<xsd:enumeration value="Neapolitan Italian"/>
<xsd:enumeration value="Nauru"/>
<xsd:enumeration value="Navajo"/>
<xsd:enumeration value="Ndebele (South Africa)"/>
<xsd:enumeration value="Ndebele (Zimbabwe)"/>
<xsd:enumeration value="Ndonga"/>
<xsd:enumeration value="Low German"/>
<xsd:enumeration value="Nepali"/>
<xsd:enumeration value="Newari"/>
<xsd:enumeration value="Nias"/>
<xsd:enumeration value="Niger-Kordofanian (Other)"/>
<xsd:enumeration value="Niuean"/>
<xsd:enumeration value="Norwegian (Nynorsk)"/>
<xsd:enumeration value="Norwegian (Bokmål)"/>
<xsd:enumeration value="Nogai"/>
<xsd:enumeration value="Old Norse"/>
<xsd:enumeration value="Norwegian"/>
<xsd:enumeration value="Northern Sotho"/>
<xsd:enumeration value="Nubian languages"/>
<xsd:enumeration value="Nyanja"/>
<xsd:enumeration value="Nyamwezi"/>
<xsd:enumeration value="Nyankole"/>
<xsd:enumeration value="Nyoro"/>
<xsd:enumeration value="Nzima"/>
<xsd:enumeration value="Occitan (post-1500)"/>
<xsd:enumeration value="Ojibwa"/>
<xsd:enumeration value="Oriya"/>
<xsd:enumeration value="Oromo"/>
<xsd:enumeration value="Osage"/>
<xsd:enumeration value="Ossetic"/>
```

```

<xsd:enumeration value="Turkish, Ottoman"/>
<xsd:enumeration value="Otomian languages"/>
<xsd:enumeration value="Papuan (Other)"/>
<xsd:enumeration value="Pangasinan"/>
<xsd:enumeration value="Pahlavi"/>
<xsd:enumeration value="Pampang"/>
<xsd:enumeration value="Panjabi"/>
<xsd:enumeration value="Papiamento"/>
<xsd:enumeration value="Palauan"/>
<xsd:enumeration value="Old Persian (ca. 600-400 B.C.)"/>
<xsd:enumeration value="Persian"/>
<xsd:enumeration value="Philippine (Other)"/>
<xsd:enumeration value="Phoenician"/>
<xsd:enumeration value="Pali"/>
<xsd:enumeration value="Polish"/>
<xsd:enumeration value="Ponape"/>
<xsd:enumeration value="Portuguese"/>
<xsd:enumeration value="Prakrit languages"/>
<xsd:enumeration value="Provençal (to 1500)"/>
<xsd:enumeration value="Pushto"/>
<xsd:enumeration value="Quechua"/>
<xsd:enumeration value="Rajasthani"/>
<xsd:enumeration value="Rapanui"/>
<xsd:enumeration value="Rarotongan"/>
<xsd:enumeration value="Romance (Other)"/>
<xsd:enumeration value="Raeto-Romance"/>
<xsd:enumeration value="Romani"/>
<xsd:enumeration value="Romanian"/>
<xsd:enumeration value="Rundi"/>
<xsd:enumeration value="Russian"/>
<xsd:enumeration value="Sandawe"/>
<xsd:enumeration value="Sango (Ubangi Creole)"/>
<xsd:enumeration value="Yakut"/>
<xsd:enumeration value="South American Indian (Other)"/>
<xsd:enumeration value="Salishan languages"/>
<xsd:enumeration value="Samaritan Aramaic"/>
<xsd:enumeration value="Sanskrit"/>
<xsd:enumeration value="Sasak"/>
<xsd:enumeration value="Santali"/>
<xsd:enumeration value="Serbian"/>
<xsd:enumeration value="Scots"/>
<xsd:enumeration value="Croatian"/>
<xsd:enumeration value="Selkup"/>
<xsd:enumeration value="Semitic (Other)"/>
<xsd:enumeration value="Irish, Old (to 1100)"/>
<xsd:enumeration value="Sign languages"/>
<xsd:enumeration value="Shan"/>
<xsd:enumeration value="Sidamo"/>
<xsd:enumeration value="Sinhalese"/>
<xsd:enumeration value="Siouan (Other)"/>
<xsd:enumeration value="Sino-Tibetan (Other)"/>
<xsd:enumeration value="Slavic (Other)"/>
<xsd:enumeration value="Slovak"/>
<xsd:enumeration value="Slovenian"/>
<xsd:enumeration value="Southern Sami"/>
<xsd:enumeration value="Northern Sami"/>
<xsd:enumeration value="Sami"/>
<xsd:enumeration value="Lule Sami"/>
<xsd:enumeration value="Inari Sami"/>
<xsd:enumeration value="Samoan"/>
<xsd:enumeration value="Skolt Sami"/>
<xsd:enumeration value="Shona"/>
<xsd:enumeration value="Sindhi"/>
<xsd:enumeration value="Soninke"/>
<xsd:enumeration value="Sogdian"/>
<xsd:enumeration value="Somali"/>
<xsd:enumeration value="Songhai"/>
<xsd:enumeration value="Sotho"/>
<xsd:enumeration value="Spanish"/>
<xsd:enumeration value="Sardinian"/>
<xsd:enumeration value="Serer"/>
<xsd:enumeration value="Nilo-Saharan (Other)"/>
<xsd:enumeration value="Swazi"/>
<xsd:enumeration value="Sukuma"/>
<xsd:enumeration value="Sundanese"/>
<xsd:enumeration value="Susu"/>

```

```
<xsd:enumeration value="Sumerian"/>
<xsd:enumeration value="Swahili"/>
<xsd:enumeration value="Swedish"/>
<xsd:enumeration value="Syriac"/>
<xsd:enumeration value="Tahitian"/>
<xsd:enumeration value="Tai (Other)"/>
<xsd:enumeration value="Tamil"/>
<xsd:enumeration value="Tatar"/>
<xsd:enumeration value="Telugu"/>
<xsd:enumeration value="Temne"/>
<xsd:enumeration value="Terena"/>
<xsd:enumeration value="Tetum"/>
<xsd:enumeration value="Tajik"/>
<xsd:enumeration value="Tagalog"/>
<xsd:enumeration value="Thai"/>
<xsd:enumeration value="Tibetan"/>
<xsd:enumeration value="Tigré"/>
<xsd:enumeration value="Tigrinya"/>
<xsd:enumeration value="Tiv"/>
<xsd:enumeration value="Tokelauan"/>
<xsd:enumeration value="Tlingit"/>
<xsd:enumeration value="Tamashek"/>
<xsd:enumeration value="Tonga (Nyasa)"/>
<xsd:enumeration value="Tongan"/>
<xsd:enumeration value="Tok Pisin"/>
<xsd:enumeration value="Tsimshian"/>
<xsd:enumeration value="Tswana"/>
<xsd:enumeration value="Tsonga"/>
<xsd:enumeration value="Turkmen"/>
<xsd:enumeration value="Tumbuka"/>
<xsd:enumeration value="Tupi languages"/>
<xsd:enumeration value="Turkish"/>
<xsd:enumeration value="Altaic (Other)"/>
<xsd:enumeration value="Tuvaluan"/>
<xsd:enumeration value="Twi"/>
<xsd:enumeration value="Tuvinian"/>
<xsd:enumeration value="Udmurt"/>
<xsd:enumeration value="Ugaritic"/>
<xsd:enumeration value="Uighur"/>
<xsd:enumeration value="Ukrainian"/>
<xsd:enumeration value="Umbundu"/>
<xsd:enumeration value="Undetermined"/>
<xsd:enumeration value="Urdu"/>
<xsd:enumeration value="Uzbek"/>
<xsd:enumeration value="Vai"/>
<xsd:enumeration value="Venda"/>
<xsd:enumeration value="Vietnamese"/>
<xsd:enumeration value="Volapük"/>
<xsd:enumeration value="Votic"/>
<xsd:enumeration value="Wakashan languages"/>
<xsd:enumeration value="Walamo"/>
<xsd:enumeration value="Waray"/>
<xsd:enumeration value="Washo"/>
<xsd:enumeration value="Welsh"/>
<xsd:enumeration value="Sorbian languages"/>
<xsd:enumeration value="Walloon"/>
<xsd:enumeration value="Wolof"/>
<xsd:enumeration value="Kalmyk"/>
<xsd:enumeration value="Xhosa"/>
<xsd:enumeration value="Yao (Africa)"/>
<xsd:enumeration value="Yapese"/>
<xsd:enumeration value="Yiddish"/>
<xsd:enumeration value="Yoruba"/>
<xsd:enumeration value="Yupik languages"/>
<xsd:enumeration value="Zapotec"/>
<xsd:enumeration value="Zenaga"/>
<xsd:enumeration value="Zhuang"/>
<xsd:enumeration value="Zande"/>
<xsd:enumeration value="Zulu"/>
<xsd:enumeration value="Zuni"/>
</xsd:restriction>
</xsd:simpleType>
```

13.5.167 Language Code Value (Simple)

```
<xsd:simpleType name="Lang_code_value">
  <xsd:restriction base="xsd:string">
    <xsd:enumeration value="AAR" />
    <xsd:enumeration value="ABK" />
    <xsd:enumeration value="ACE" />
    <xsd:enumeration value="ACH" />
    <xsd:enumeration value="ADA" />
    <xsd:enumeration value="ADY" />
    <xsd:enumeration value="AFA" />
    <xsd:enumeration value="AFH" />
    <xsd:enumeration value="AFR" />
    <xsd:enumeration value="AKA" />
    <xsd:enumeration value="AKK" />
    <xsd:enumeration value="ALB" />
    <xsd:enumeration value="ALE" />
    <xsd:enumeration value="ALG" />
    <xsd:enumeration value="AMH" />
    <xsd:enumeration value="ANG" />
    <xsd:enumeration value="APA" />
    <xsd:enumeration value="ARA" />
    <xsd:enumeration value="ARC" />
    <xsd:enumeration value="ARG" />
    <xsd:enumeration value="ARM" />
    <xsd:enumeration value="ARN" />
    <xsd:enumeration value="ARP" />
    <xsd:enumeration value="ART" />
    <xsd:enumeration value="ARW" />
    <xsd:enumeration value="ASM" />
    <xsd:enumeration value="AST" />
    <xsd:enumeration value="ATH" />
    <xsd:enumeration value="AUS" />
    <xsd:enumeration value="AVA" />
    <xsd:enumeration value="AVE" />
    <xsd:enumeration value="AWA" />
    <xsd:enumeration value="AYM" />
    <xsd:enumeration value="AZE" />
    <xsd:enumeration value="BAD" />
    <xsd:enumeration value="BAI" />
    <xsd:enumeration value="BAK" />
    <xsd:enumeration value="BAL" />
    <xsd:enumeration value="BAM" />
    <xsd:enumeration value="BAN" />
    <xsd:enumeration value="BAQ" />
    <xsd:enumeration value="BAS" />
    <xsd:enumeration value="BAT" />
    <xsd:enumeration value="BEJ" />
    <xsd:enumeration value="BEL" />
    <xsd:enumeration value="BEM" />
    <xsd:enumeration value="BEN" />
    <xsd:enumeration value="BER" />
    <xsd:enumeration value="BHO" />
    <xsd:enumeration value="BIH" />
    <xsd:enumeration value="BIK" />
    <xsd:enumeration value="BIN" />
    <xsd:enumeration value="BIS" />
    <xsd:enumeration value="BLA" />
    <xsd:enumeration value="BNT" />
    <xsd:enumeration value="BOS" />
    <xsd:enumeration value="BRA" />
    <xsd:enumeration value="BRE" />
    <xsd:enumeration value="BTK" />
    <xsd:enumeration value="BUA" />
    <xsd:enumeration value="BUG" />
    <xsd:enumeration value="BUL" />
    <xsd:enumeration value="BUR" />
    <xsd:enumeration value="CAD" />
    <xsd:enumeration value="CAI" />
    <xsd:enumeration value="CAR" />
    <xsd:enumeration value="CAT" />
    <xsd:enumeration value="CAU" />
    <xsd:enumeration value="CEB" />
    <xsd:enumeration value="CEL" />
    <xsd:enumeration value="CHA" />
    <xsd:enumeration value="CHB" />
```



```
<xsd:enumeration value="CHE"/>
<xsd:enumeration value="CHG"/>
<xsd:enumeration value="CHI"/>
<xsd:enumeration value="CHK"/>
<xsd:enumeration value="CHM"/>
<xsd:enumeration value="CHN"/>
<xsd:enumeration value="CHO"/>
<xsd:enumeration value="CHP"/>
<xsd:enumeration value="CHR"/>
<xsd:enumeration value="CHU"/>
<xsd:enumeration value="CHV"/>
<xsd:enumeration value="CHY"/>
<xsd:enumeration value="CMC"/>
<xsd:enumeration value="COP"/>
<xsd:enumeration value="COR"/>
<xsd:enumeration value="COS"/>
<xsd:enumeration value="CPE"/>
<xsd:enumeration value="CPF"/>
<xsd:enumeration value="CPP"/>
<xsd:enumeration value="CRE"/>
<xsd:enumeration value="CRH"/>
<xsd:enumeration value="CRP"/>
<xsd:enumeration value="CUS"/>
<xsd:enumeration value="CZE"/>
<xsd:enumeration value="DAK"/>
<xsd:enumeration value="DAN"/>
<xsd:enumeration value="DAR"/>
<xsd:enumeration value="DAY"/>
<xsd:enumeration value="DEL"/>
<xsd:enumeration value="DEN"/>
<xsd:enumeration value="DGR"/>
<xsd:enumeration value="DIN"/>
<xsd:enumeration value="DIV"/>
<xsd:enumeration value="DOI"/>
<xsd:enumeration value="DRA"/>
<xsd:enumeration value="DUA"/>
<xsd:enumeration value="DUM"/>
<xsd:enumeration value="DUT"/>
<xsd:enumeration value="DYU"/>
<xsd:enumeration value="DZO"/>
<xsd:enumeration value="EFI"/>
<xsd:enumeration value="EGY"/>
<xsd:enumeration value="EKA"/>
<xsd:enumeration value="ELX"/>
<xsd:enumeration value="ENG"/>
<xsd:enumeration value="ENM"/>
<xsd:enumeration value="EPO"/>
<xsd:enumeration value="EST"/>
<xsd:enumeration value="EWE"/>
<xsd:enumeration value="EWO"/>
<xsd:enumeration value="FAN"/>
<xsd:enumeration value="FAO"/>
<xsd:enumeration value="FAT"/>
<xsd:enumeration value="FIJ"/>
<xsd:enumeration value="FIN"/>
<xsd:enumeration value="FIU"/>
<xsd:enumeration value="FON"/>
<xsd:enumeration value="FRE"/>
<xsd:enumeration value="FRM"/>
<xsd:enumeration value="FRO"/>
<xsd:enumeration value="FRY"/>
<xsd:enumeration value="FUL"/>
<xsd:enumeration value="FUR"/>
<xsd:enumeration value="GAA"/>
<xsd:enumeration value="GAY"/>
<xsd:enumeration value="GBA"/>
<xsd:enumeration value="GEM"/>
<xsd:enumeration value="GEO"/>
<xsd:enumeration value="GER"/>
<xsd:enumeration value="GEZ"/>
<xsd:enumeration value="GIL"/>
<xsd:enumeration value="GLA"/>
<xsd:enumeration value="GLE"/>
<xsd:enumeration value="GLG"/>
<xsd:enumeration value="GLV"/>
<xsd:enumeration value="GMH"/>
```



```

<xsd:enumeration value="GOH" />
<xsd:enumeration value="GON" />
<xsd:enumeration value="GOR" />
<xsd:enumeration value="GOT" />
<xsd:enumeration value="GRB" />
<xsd:enumeration value="GRC" />
<xsd:enumeration value="GRE" />
<xsd:enumeration value="GRN" />
<xsd:enumeration value="GUJ" />
<xsd:enumeration value="GWI" />
<xsd:enumeration value="HAI" />
<xsd:enumeration value="HAT" />
<xsd:enumeration value="HAU" />
<xsd:enumeration value="HAW" />
<xsd:enumeration value="HEB" />
<xsd:enumeration value="HER" />
<xsd:enumeration value="HIL" />
<xsd:enumeration value="HIM" />
<xsd:enumeration value="HIN" />
<xsd:enumeration value="HIT" />
<xsd:enumeration value="HMN" />
<xsd:enumeration value="HMO" />
<xsd:enumeration value="HUN" />
<xsd:enumeration value="HUP" />
<xsd:enumeration value="IBA" />
<xsd:enumeration value="IBO" />
<xsd:enumeration value="ICE" />
<xsd:enumeration value="IDO" />
<xsd:enumeration value="III" />
<xsd:enumeration value="IJO" />
<xsd:enumeration value="IKU" />
<xsd:enumeration value="ILE" />
<xsd:enumeration value="ILO" />
<xsd:enumeration value="INA" />
<xsd:enumeration value="INC" />
<xsd:enumeration value="IND" />
<xsd:enumeration value="INE" />
<xsd:enumeration value="INH" />
<xsd:enumeration value="IPK" />
<xsd:enumeration value="IRA" />
<xsd:enumeration value="IRO" />
<xsd:enumeration value="ITA" />
<xsd:enumeration value="JAV" />
<xsd:enumeration value="JPN" />
<xsd:enumeration value="JPR" />
<xsd:enumeration value="JRB" />
<xsd:enumeration value="KAA" />
<xsd:enumeration value="KAB" />
<xsd:enumeration value="KAC" />
<xsd:enumeration value="KAL" />
<xsd:enumeration value="KAM" />
<xsd:enumeration value="KAN" />
<xsd:enumeration value="KAR" />
<xsd:enumeration value="KAS" />
<xsd:enumeration value="KAU" />
<xsd:enumeration value="KAW" />
<xsd:enumeration value="KAZ" />
<xsd:enumeration value="KBD" />
<xsd:enumeration value="KHA" />
<xsd:enumeration value="KHI" />
<xsd:enumeration value="KHM" />
<xsd:enumeration value="KHO" />
<xsd:enumeration value="KIK" />
<xsd:enumeration value="KIN" />
<xsd:enumeration value="KIR" />
<xsd:enumeration value="KMB" />
<xsd:enumeration value="KOK" />
<xsd:enumeration value="KOM" />
<xsd:enumeration value="KON" />
<xsd:enumeration value="KOR" />
<xsd:enumeration value="KOS" />
<xsd:enumeration value="KPE" />
<xsd:enumeration value="KRO" />
<xsd:enumeration value="KRU" />
<xsd:enumeration value="KUA" />
<xsd:enumeration value="KUM" />

```

```
<xsd:enumeration value="KUR"/>
<xsd:enumeration value="KUT"/>
<xsd:enumeration value="LAD"/>
<xsd:enumeration value="LAH"/>
<xsd:enumeration value="LAM"/>
<xsd:enumeration value="LAO"/>
<xsd:enumeration value="LAT"/>
<xsd:enumeration value="LAV"/>
<xsd:enumeration value="LEZ"/>
<xsd:enumeration value="LIM"/>
<xsd:enumeration value="LIN"/>
<xsd:enumeration value="LIT"/>
<xsd:enumeration value="LOL"/>
<xsd:enumeration value="LOZ"/>
<xsd:enumeration value="LTZ"/>
<xsd:enumeration value="LUA"/>
<xsd:enumeration value="LUB"/>
<xsd:enumeration value="LUG"/>
<xsd:enumeration value="LUI"/>
<xsd:enumeration value="LUN"/>
<xsd:enumeration value="LUO"/>
<xsd:enumeration value="LUS"/>
<xsd:enumeration value="MAC"/>
<xsd:enumeration value="MAD"/>
<xsd:enumeration value="MAG"/>
<xsd:enumeration value="MAH"/>
<xsd:enumeration value="MAI"/>
<xsd:enumeration value="MAK"/>
<xsd:enumeration value="MAL"/>
<xsd:enumeration value="MAN"/>
<xsd:enumeration value="MAO"/>
<xsd:enumeration value="MAP"/>
<xsd:enumeration value="MAR"/>
<xsd:enumeration value="MAS"/>
<xsd:enumeration value="MAY"/>
<xsd:enumeration value="MDR"/>
<xsd:enumeration value="MEN"/>
<xsd:enumeration value="MGA"/>
<xsd:enumeration value="MIC"/>
<xsd:enumeration value="MIN"/>
<xsd:enumeration value="MIS"/>
<xsd:enumeration value="MKH"/>
<xsd:enumeration value="MLG"/>
<xsd:enumeration value="MLT"/>
<xsd:enumeration value="MNC"/>
<xsd:enumeration value="MNI"/>
<xsd:enumeration value="MNO"/>
<xsd:enumeration value="MOH"/>
<xsd:enumeration value="MOL"/>
<xsd:enumeration value="MON"/>
<xsd:enumeration value="MOS"/>
<xsd:enumeration value="MUL"/>
<xsd:enumeration value="MUN"/>
<xsd:enumeration value="MUS"/>
<xsd:enumeration value="MWR"/>
<xsd:enumeration value="MYN"/>
<xsd:enumeration value="NAH"/>
<xsd:enumeration value="NAI"/>
<xsd:enumeration value="NAP"/>
<xsd:enumeration value="NAU"/>
<xsd:enumeration value="NAV"/>
<xsd:enumeration value="NBL"/>
<xsd:enumeration value="NDE"/>
<xsd:enumeration value="NDO"/>
<xsd:enumeration value="NDS"/>
<xsd:enumeration value="NEP"/>
<xsd:enumeration value="NEW"/>
<xsd:enumeration value="NIA"/>
<xsd:enumeration value="NIC"/>
<xsd:enumeration value="NIU"/>
<xsd:enumeration value="NNO"/>
<xsd:enumeration value="NOB"/>
<xsd:enumeration value="NOG"/>
<xsd:enumeration value="NON"/>
<xsd:enumeration value="NOR"/>
<xsd:enumeration value="NSO"/>
```

```

<xsd:enumeration value="NUB" />
<xsd:enumeration value="NYA" />
<xsd:enumeration value="NYM" />
<xsd:enumeration value="NYN" />
<xsd:enumeration value="NYO" />
<xsd:enumeration value="NZI" />
<xsd:enumeration value="OCI" />
<xsd:enumeration value="OJI" />
<xsd:enumeration value="ORI" />
<xsd:enumeration value="ORM" />
<xsd:enumeration value="OSA" />
<xsd:enumeration value="OSS" />
<xsd:enumeration value="OTA" />
<xsd:enumeration value="OTO" />
<xsd:enumeration value="PAA" />
<xsd:enumeration value="PAG" />
<xsd:enumeration value="PAL" />
<xsd:enumeration value="PAM" />
<xsd:enumeration value="PAN" />
<xsd:enumeration value="PAP" />
<xsd:enumeration value="PAU" />
<xsd:enumeration value="PEO" />
<xsd:enumeration value="PER" />
<xsd:enumeration value="PHI" />
<xsd:enumeration value="PHN" />
<xsd:enumeration value="PLI" />
<xsd:enumeration value="POL" />
<xsd:enumeration value="PON" />
<xsd:enumeration value="POR" />
<xsd:enumeration value="PRA" />
<xsd:enumeration value="PRO" />
<xsd:enumeration value="PUS" />
<xsd:enumeration value="QUE" />
<xsd:enumeration value="RAJ" />
<xsd:enumeration value="RAP" />
<xsd:enumeration value="RAR" />
<xsd:enumeration value="ROA" />
<xsd:enumeration value="ROH" />
<xsd:enumeration value="ROM" />
<xsd:enumeration value="RUM" />
<xsd:enumeration value="RUN" />
<xsd:enumeration value="RUS" />
<xsd:enumeration value="SAD" />
<xsd:enumeration value="SAG" />
<xsd:enumeration value="SAH" />
<xsd:enumeration value="SAI" />
<xsd:enumeration value="SAL" />
<xsd:enumeration value="SAM" />
<xsd:enumeration value="SAN" />
<xsd:enumeration value="SAS" />
<xsd:enumeration value="SAT" />
<xsd:enumeration value="SCC" />
<xsd:enumeration value="SCO" />
<xsd:enumeration value="SCR" />
<xsd:enumeration value="SEL" />
<xsd:enumeration value="SEM" />
<xsd:enumeration value="SGA" />
<xsd:enumeration value="SGN" />
<xsd:enumeration value="SHN" />
<xsd:enumeration value="SID" />
<xsd:enumeration value="SIN" />
<xsd:enumeration value="SIO" />
<xsd:enumeration value="SIT" />
<xsd:enumeration value="SLA" />
<xsd:enumeration value="SLO" />
<xsd:enumeration value="SLV" />
<xsd:enumeration value="SMA" />
<xsd:enumeration value="SME" />
<xsd:enumeration value="SMI" />
<xsd:enumeration value="SMJ" />
<xsd:enumeration value="SMN" />
<xsd:enumeration value="SMO" />
<xsd:enumeration value="SMS" />
<xsd:enumeration value="SNA" />
<xsd:enumeration value="SND" />
<xsd:enumeration value="SNK" />

```

```
<xsd:enumeration value="SOG"/>
<xsd:enumeration value="SOM"/>
<xsd:enumeration value="SON"/>
<xsd:enumeration value="SOT"/>
<xsd:enumeration value="SPA"/>
<xsd:enumeration value="SRD"/>
<xsd:enumeration value="SRR"/>
<xsd:enumeration value="SSA"/>
<xsd:enumeration value="SSW"/>
<xsd:enumeration value="SUK"/>
<xsd:enumeration value="SUN"/>
<xsd:enumeration value="SUS"/>
<xsd:enumeration value="SUX"/>
<xsd:enumeration value="SWA"/>
<xsd:enumeration value="SWE"/>
<xsd:enumeration value="SYR"/>
<xsd:enumeration value="TAH"/>
<xsd:enumeration value="TAI"/>
<xsd:enumeration value="TAM"/>
<xsd:enumeration value="TAT"/>
<xsd:enumeration value="TEL"/>
<xsd:enumeration value="TEM"/>
<xsd:enumeration value="TER"/>
<xsd:enumeration value="TET"/>
<xsd:enumeration value="TGK"/>
<xsd:enumeration value="TGL"/>
<xsd:enumeration value="THA"/>
<xsd:enumeration value="TIB"/>
<xsd:enumeration value="TIG"/>
<xsd:enumeration value="TIR"/>
<xsd:enumeration value="TIV"/>
<xsd:enumeration value="TKL"/>
<xsd:enumeration value="TLI"/>
<xsd:enumeration value="TMH"/>
<xsd:enumeration value="TOG"/>
<xsd:enumeration value="TON"/>
<xsd:enumeration value="TPI"/>
<xsd:enumeration value="TSI"/>
<xsd:enumeration value="TSN"/>
<xsd:enumeration value="TSO"/>
<xsd:enumeration value="TUK"/>
<xsd:enumeration value="TUM"/>
<xsd:enumeration value="TUP"/>
<xsd:enumeration value="TUR"/>
<xsd:enumeration value="TUT"/>
<xsd:enumeration value="TVL"/>
<xsd:enumeration value="TWI"/>
<xsd:enumeration value="TYV"/>
<xsd:enumeration value="UDM"/>
<xsd:enumeration value="UGA"/>
<xsd:enumeration value="UIG"/>
<xsd:enumeration value="UKR"/>
<xsd:enumeration value="UMB"/>
<xsd:enumeration value="UND"/>
<xsd:enumeration value="URD"/>
<xsd:enumeration value="UZB"/>
<xsd:enumeration value="VAI"/>
<xsd:enumeration value="VEN"/>
<xsd:enumeration value="VIE"/>
<xsd:enumeration value="VOL"/>
<xsd:enumeration value="VOT"/>
<xsd:enumeration value="WAK"/>
<xsd:enumeration value="WAL"/>
<xsd:enumeration value="WAR"/>
<xsd:enumeration value="WAS"/>
<xsd:enumeration value="WEL"/>
<xsd:enumeration value="WEN"/>
<xsd:enumeration value="WLN"/>
<xsd:enumeration value="WOL"/>
<xsd:enumeration value="XAL"/>
<xsd:enumeration value="XHO"/>
<xsd:enumeration value="YAO"/>
<xsd:enumeration value="YAP"/>
<xsd:enumeration value="YID"/>
<xsd:enumeration value="YOR"/>
<xsd:enumeration value="YPK"/>
```

```

        <xsd:enumeration value="ZAP" />
        <xsd:enumeration value="ZEN" />
        <xsd:enumeration value="ZHA" />
        <xsd:enumeration value="ZND" />
        <xsd:enumeration value="ZUL" />
        <xsd:enumeration value="ZUN" />
    </xsd:restriction>
</xsd:simpleType>

```

13.5.168 Object Category Name (Simple)

```

<xsd:simpleType name="Obj_cat_name">
  <xsd:restriction base="xsd:string">
    <xsd:enumeration value="point" />
    <xsd:enumeration value="line" />
    <xsd:enumeration value="area" />
    <xsd:enumeration value="complex" />
    <xsd:enumeration value="relationship" />
    <xsd:enumeration value="name" />
    <xsd:enumeration value="time domain" />
    <xsd:enumeration value="other text" />
    <xsd:enumeration value="geopolitical structure" />
    <xsd:enumeration value="geopolitical structure component" />
  </xsd:restriction>
</xsd:simpleType>

```

13.5.169 Object Category Value (Simple)

```

<xsd:simpleType name="Obj_cat_val">
  <xsd:restriction base="xsd:integer">
    <xsd:minInclusive value="1" />
    <xsd:maxInclusive value="10" />
    <xsd:enumeration value="1" />
    <xsd:enumeration value="2" />
    <xsd:enumeration value="3" />
    <xsd:enumeration value="4" />
    <xsd:enumeration value="5" />
    <xsd:enumeration value="6" />
    <xsd:enumeration value="7" />
    <xsd:enumeration value="8" />
    <xsd:enumeration value="9" />
    <xsd:enumeration value="10" />
  </xsd:restriction>
</xsd:simpleType>

```

13.5.170 Orientation Name (Simple)

```

<xsd:simpleType name="Orientation_name">
  <xsd:restriction base="xsd:string">
    <xsd:enumeration value="clockwise" />
    <xsd:enumeration value="counterclockwise" />
  </xsd:restriction>
</xsd:simpleType>

```

13.5.171 Positive Negative Name (Simple)

```

<xsd:simpleType name="Pos_neg_name">
  <xsd:restriction base="xsd:string">
    <xsd:enumeration value="positive" />
    <xsd:enumeration value="negative" />
  </xsd:restriction>
</xsd:simpleType>

```

13.5.172 Projection Name (Simple)

```

<xsd:simpleType name="Projection_name">
  <xsd:restriction base="xsd:string">
    <xsd:maxLength value="50" />
    <xsd:enumeration value="Albers Equal-Area Conic" />
    <xsd:enumeration value="(Lambert) Azimuthal Equal-Area" />
    <xsd:enumeration value="Azimuthal Equidistant" />
    <xsd:enumeration value="Bonne" />
  </xsd:restriction>
</xsd:simpleType>

```

```
<xsd:enumeration value="Equidistant Conic with 1 Standard Parallel"/>
<xsd:enumeration value="Equirectangular (La Carte Parallélogramatique)"/>
<xsd:enumeration value="Cassini-Soldner"/>
<xsd:enumeration value="Gnomonic"/>
<xsd:enumeration value="Hotine Oblique Mercator based on 2 Points"/>
<xsd:enumeration value="Equidistant Conic with 2 Standard Parallels"/>
<xsd:enumeration value="Laborde"/>
<xsd:enumeration value="Lambert Conformal Conic"/>
<xsd:enumeration value="Lambert Equal-Area Meridional"/>
<xsd:enumeration value="Mercator"/>
<xsd:enumeration value="Miller Cylindrical"/>
<xsd:enumeration value="French Lambert"/>
<xsd:enumeration value="New Zealand Map Grid"/>
<xsd:enumeration value="Oblique Mercator"/>
<xsd:enumeration value="Orthographic"/>
<xsd:enumeration value="Polar Stereographic"/>
<xsd:enumeration value="Polyconic"/>
<xsd:enumeration value="Relative Coordinates"/>
<xsd:enumeration value="Hotine Oblique Mercator (Rectified Skew Orthomorphic)"/>
<xsd:enumeration value="Robinson"/>
<xsd:enumeration value="Sinusoidal"/>
<xsd:enumeration value="Oblique Stereographic"/>
<xsd:enumeration value="Space Oblique Mercator"/>
<xsd:enumeration value="Transverse Mercator"/>
<xsd:enumeration value="Van der Grinten"/>
<xsd:enumeration value="General Vertical Near-Side Perspective"/>
<xsd:enumeration value="Other Known Projection"/>
</xsd:restriction>
</xsd:simpleType>
```

13.5.173 Projection Value (Simple)

```
<xsd:simpleType name="Projection_value">
  <xsd:restriction base="xsd:string">
    <xsd:length value="2"/>
    <xsd:enumeration value="AC"/>
    <xsd:enumeration value="AK"/>
    <xsd:enumeration value="AL"/>
    <xsd:enumeration value="BF"/>
    <xsd:enumeration value="CC"/>
    <xsd:enumeration value="CP"/>
    <xsd:enumeration value="CS"/>
    <xsd:enumeration value="GN"/>
    <xsd:enumeration value="HX"/>
    <xsd:enumeration value="KA"/>
    <xsd:enumeration value="LA"/>
    <xsd:enumeration value="LE"/>
    <xsd:enumeration value="LJ"/>
    <xsd:enumeration value="MC"/>
    <xsd:enumeration value="MH"/>
    <xsd:enumeration value="MJ"/>
    <xsd:enumeration value="NT"/>
    <xsd:enumeration value="OC"/>
    <xsd:enumeration value="OD"/>
    <xsd:enumeration value="PG"/>
    <xsd:enumeration value="PH"/>
    <xsd:enumeration value="RC"/>
    <xsd:enumeration value="RS"/>
    <xsd:enumeration value="RX"/>
    <xsd:enumeration value="SA"/>
    <xsd:enumeration value="SD"/>
    <xsd:enumeration value="SX"/>
    <xsd:enumeration value="TC"/>
    <xsd:enumeration value="VA"/>
    <xsd:enumeration value="VX"/>
    <xsd:enumeration value="ZY"/>
  </xsd:restriction>
</xsd:simpleType>
```

13.5.174 Record Type Name (Simple)

```
<xsd:simpleType name="Record_type_name">
  <xsd:restriction base="xsd:string">
    <xsd:enumeration value="Continuation Record"/>
  </xsd:restriction>
</xsd:simpleType>
```

```

<xsd:enumeration value="Album Header Record"/>
<xsd:enumeration value="Dataset Header Record"/>
<xsd:enumeration value="Field Definition Record"/>
<xsd:enumeration value="Record Definition Record"/>
<xsd:enumeration value="Attribute Definition Record"/>
<xsd:enumeration value="Directory Record"/>
<xsd:enumeration value="Feature Definition Record"/>
<xsd:enumeration value="Spatial Domain Record"/>
<xsd:enumeration value="Relationship Definition Record"/>
<xsd:enumeration value="GeoPolitical Structure Definition Record"/>
<xsd:enumeration value="GeoPolitical Component Structure Definition Record"/>
<xsd:enumeration value="Abbreviation Record"/>
<xsd:enumeration value="Source Record"/>
<xsd:enumeration value="Default Attribute Value Record"/>
<xsd:enumeration value="Section Header Record"/>
<xsd:enumeration value="Layer Header Record"/>
<xsd:enumeration value="Attribute Value Definition Record"/>
<xsd:enumeration value="Network Specification Record"/>
<xsd:enumeration value="Datum & Ellipsoid Record"/>
<xsd:enumeration value="Vertical Datum Record"/>
<xsd:enumeration value="Projection Record"/>
<xsd:enumeration value="National Grid Record"/>
<xsd:enumeration value="Geoid Undulation Record"/>
<xsd:enumeration value="Earth Magnetic Field Record"/>
<xsd:enumeration value="Comment Record"/>
<xsd:enumeration value="2D Coordinate Record "/>
<xsd:enumeration value="3D Coordinate Record "/>
<xsd:enumeration value="Edge Record"/>
<xsd:enumeration value="Node Record"/>
<xsd:enumeration value="Face Record"/>
<xsd:enumeration value="Text Record"/>
<xsd:enumeration value="Attribute Record"/>
<xsd:enumeration value="Time Domain Record"/>
<xsd:enumeration value="Conversion Record"/>
<xsd:enumeration value="Relationship Record"/>
<xsd:enumeration value="Point Feature Record"/>
<xsd:enumeration value="Line Feature Record"/>
<xsd:enumeration value="Area Feature Record"/>
<xsd:enumeration value="Complex Feature Record"/>
<xsd:enumeration value="Object Reference Record"/>
<xsd:enumeration value="Update Information Record"/>
</xsd:restriction>
</xsd:simpleType>

```

13.5.175 Record Type Value (Simple)

```

<xsd:simpleType name="Record_type_value">
  <xsd:restriction base="xsd:integer">
    <xsd:enumeration value="0"/>
    <xsd:enumeration value="1"/>
    <xsd:enumeration value="2"/>
    <xsd:enumeration value="3"/>
    <xsd:enumeration value="4"/>
    <xsd:enumeration value="5"/>
    <xsd:enumeration value="6"/>
    <xsd:enumeration value="7"/>
    <xsd:enumeration value="8"/>
    <xsd:enumeration value="9"/>
    <xsd:enumeration value="10"/>
    <xsd:enumeration value="11"/>
    <xsd:enumeration value="13"/>
    <xsd:enumeration value="14"/>
    <xsd:enumeration value="15"/>
    <xsd:enumeration value="16"/>
    <xsd:enumeration value="17"/>
    <xsd:enumeration value="18"/>
    <xsd:enumeration value="19"/>
    <xsd:enumeration value="61"/>
    <xsd:enumeration value="62"/>
    <xsd:enumeration value="63"/>
    <xsd:enumeration value="64"/>
    <xsd:enumeration value="65"/>
    <xsd:enumeration value="66"/>
    <xsd:enumeration value="90"/>
    <xsd:enumeration value="22"/>
  </xsd:restriction>
</xsd:simpleType>

```



```
<xsd:enumeration value="23"/>
<xsd:enumeration value="24"/>
<xsd:enumeration value="25"/>
<xsd:enumeration value="29"/>
<xsd:enumeration value="41"/>
<xsd:enumeration value="44"/>
<xsd:enumeration value="45"/>
<xsd:enumeration value="46"/>
<xsd:enumeration value="50"/>
<xsd:enumeration value="51"/>
<xsd:enumeration value="52"/>
<xsd:enumeration value="53"/>
<xsd:enumeration value="54"/>
<xsd:enumeration value="83"/>
<xsd:enumeration value="89"/>
</xsd:restriction>
</xsd:simpleType>
```

13.5.176 Reduced Record Type Value (Simple)

```
<xsd:simpleType name="Record_type_val_reduced">
  <xsd:restriction base="xsd:integer">
    <xsd:enumeration value="24"/>
    <xsd:enumeration value="25"/>
    <xsd:enumeration value="29"/>
    <xsd:enumeration value="41"/>
    <xsd:enumeration value="44"/>
    <xsd:enumeration value="45"/>
    <xsd:enumeration value="50"/>
    <xsd:enumeration value="51"/>
    <xsd:enumeration value="52"/>
    <xsd:enumeration value="53"/>
    <xsd:enumeration value="54"/>
  </xsd:restriction>
</xsd:simpleType>
```

13.5.177 Record Type Mnemonic (Simple)

```
<xsd:simpleType name="Record_type_mnemonic">
  <xsd:restriction base="xsd:string">
    <xsd:enumeration value="[CONTREC]"/>
    <xsd:enumeration value="[ALHDREC]"/>
    <xsd:enumeration value="[DSHDREC]"/>
    <xsd:enumeration value="[FIELDREC]"/>
    <xsd:enumeration value="[RECDEFREC]"/>
    <xsd:enumeration value="[ATDEFREC]"/>
    <xsd:enumeration value="[DIREC]"/>
    <xsd:enumeration value="[FEATDEFREC]"/>
    <xsd:enumeration value="[SPADOREC]"/>
    <xsd:enumeration value="[RELDEFREC]"/>
    <xsd:enumeration value="[GPLSTRDREC]"/>
    <xsd:enumeration value="[GPLCOMDREC]"/>
    <xsd:enumeration value="[ABBRREC]"/>
    <xsd:enumeration value="[SRCEREC]"/>
    <xsd:enumeration value="[DATTVLREC]"/>
    <xsd:enumeration value="[SECHREC]"/>
    <xsd:enumeration value="[LAYHREC]"/>
    <xsd:enumeration value="[ATTVALREC]"/>
    <xsd:enumeration value="[NWSPECSREC]"/>
    <xsd:enumeration value="[DATELREC]"/>
    <xsd:enumeration value="[VERDATREC]"/>
    <xsd:enumeration value="[PROJCREC]"/>
    <xsd:enumeration value="[NATGRIDREC]"/>
    <xsd:enumeration value="[GEOIDREC]"/>
    <xsd:enumeration value="[MAGNETREC]"/>
    <xsd:enumeration value="[COMMENTREC]"/>
    <xsd:enumeration value="[VOLTERMREC]"/>
    <xsd:enumeration value="[XYREC]"/>
    <xsd:enumeration value="[XYZREC]"/>
    <xsd:enumeration value="[EDGEREC]"/>
    <xsd:enumeration value="[NODEREC]"/>
    <xsd:enumeration value="[FACEREC]"/>
    <xsd:enumeration value="[TEXTREC]"/>
    <xsd:enumeration value="[ATTREC]"/>
  </xsd:restriction>
</xsd:simpleType>
```



```

    <xsd:enumeration value=" [TIMEREC] " />
    <xsd:enumeration value=" [CONVERTREC] " />
    <xsd:enumeration value=" [RELATREC] " />
    <xsd:enumeration value=" [POFEREC] " />
    <xsd:enumeration value=" [LIFEREC] " />
    <xsd:enumeration value=" [ARFEREC] " />
    <xsd:enumeration value=" [COFEREC] " />
    <xsd:enumeration value=" [OBJREFREC] " />
    <xsd:enumeration value=" [UPDIREC] " />
  </xsd:restriction>
</xsd:simpleType>

```

13.5.178 Record Subtype Name (Simple)

```

<xsd:simpleType name="Record_subtype_name">
  <xsd:restriction base="xsd:string">
    <xsd:enumeration value="Album Header Subrecord"/>
    <xsd:enumeration value="Local Character Set Definition Subrecord"/>
    <xsd:enumeration value="Global Album Information Subrecord"/>
    <xsd:enumeration value="Dataset Identification Subrecord"/>
    <xsd:enumeration value="Dataset Main Title Subrecord"/>
    <xsd:enumeration value="Dataset Subtitle Subrecord"/>
    <xsd:enumeration value="Dataset Producer Subrecord"/>
    <xsd:enumeration value="Dataset Extensiveness & Currency Subrecord"/>
    <xsd:enumeration value="Dataset Contents Subrecord"/>
    <xsd:enumeration value="Dataset XY Resolution Subrecord"/>
    <xsd:enumeration value="Description Info Subrecord"/>
    <xsd:enumeration value="ISBN & Survey Subrecord"/>
    <xsd:enumeration value="Author Name Subrecord"/>
    <xsd:enumeration value="Scale and Title Subrecord"/>
    <xsd:enumeration value="Edition & Impression Subrecord"/>
    <xsd:enumeration value="Publisher Subrecord"/>
    <xsd:enumeration value="Distribution Subrecord"/>
    <xsd:enumeration value="Host Document Subrecord"/>
    <xsd:enumeration value="Field Data Capturing Subrecord"/>
    <xsd:enumeration value="Section Identification Subrecord"/>
    <xsd:enumeration value="Section XY Resolution Subrecord"/>
    <xsd:enumeration value="Network Identification Subrecord"/>
    <xsd:enumeration value="Datasource Reference Subrecord"/>
    <xsd:enumeration value="Datum & Magnetism Subrecord"/>
    <xsd:enumeration value="Orthometric Reference Subrecord"/>
    <xsd:enumeration value="Section Border Subrecord"/>
    <xsd:enumeration value="XY Control Point Subrecord"/>
    <xsd:enumeration value="Z Control Point Subrecord"/>
    <xsd:enumeration value="GEO Update Information Subrecord"/>
    <xsd:enumeration value="Object Update Information Subrecord"/>
    <xsd:enumeration value="Object Attribute Update Information Subrecord"/>
  </xsd:restriction>
</xsd:simpleType>

```

13.5.179 Record Subtype Value (Simple)

```

<xsd:simpleType name="Record_subtype_value">
  <xsd:restriction base="xsd:decimal">
    <xsd:enumeration value="01.01"/>
    <xsd:enumeration value="01.02"/>
    <xsd:enumeration value="01.03"/>
    <xsd:enumeration value="02.01"/>
    <xsd:enumeration value="02.02"/>
    <xsd:enumeration value="02.03"/>
    <xsd:enumeration value="02.04"/>
    <xsd:enumeration value="02.05"/>
    <xsd:enumeration value="02.06"/>
    <xsd:enumeration value="02.07"/>
    <xsd:enumeration value="14.01"/>
    <xsd:enumeration value="14.02"/>
    <xsd:enumeration value="14.03"/>
    <xsd:enumeration value="14.04"/>
    <xsd:enumeration value="14.06"/>
    <xsd:enumeration value="14.07"/>
    <xsd:enumeration value="14.08"/>
    <xsd:enumeration value="14.09"/>
    <xsd:enumeration value="14.10"/>
    <xsd:enumeration value="16.01"/>
  </xsd:restriction>
</xsd:simpleType>

```

```
<xsd:enumeration value="16.02" />
<xsd:enumeration value="16.03" />
<xsd:enumeration value="16.04" />
<xsd:enumeration value="16.05" />
<xsd:enumeration value="16.06" />
<xsd:enumeration value="16.07" />
<xsd:enumeration value="16.08" />
<xsd:enumeration value="16.09" />
<xsd:enumeration value="89.01" />
<xsd:enumeration value="89.02" />
<xsd:enumeration value="89.03" />
</xsd:restriction>
</xsd:simpleType>
```

13.5.180 Record Subtype Mnemonic (Simple)

```
<xsd:simpleType name="Record_subtype_mnemonic">
  <xsd:restriction base="xsd:string">
    <xsd:enumeration value="[ALHDREC.01]" />
    <xsd:enumeration value="[ALHDREC.02]" />
    <xsd:enumeration value="[ALHDREC.03]" />
    <xsd:enumeration value="[DSHDREC.01]" />
    <xsd:enumeration value="[DSHDREC.02]" />
    <xsd:enumeration value="[DSHDREC.03]" />
    <xsd:enumeration value="[DSHDREC.04]" />
    <xsd:enumeration value="[DSHDREC.05]" />
    <xsd:enumeration value="[DSHDREC.06]" />
    <xsd:enumeration value="[DSHDREC.07]" />
    <xsd:enumeration value="[SRCEREC.01]" />
    <xsd:enumeration value="[SRCEREC.02]" />
    <xsd:enumeration value="[SRCEREC.03]" />
    <xsd:enumeration value="[SRCEREC.04]" />
    <xsd:enumeration value="[SRCEREC.06]" />
    <xsd:enumeration value="[SRCEREC.07]" />
    <xsd:enumeration value="[SRCEREC.08]" />
    <xsd:enumeration value="[SRCEREC.09]" />
    <xsd:enumeration value="[SRCEREC.10]" />
    <xsd:enumeration value="[SECHREC.01]" />
    <xsd:enumeration value="[SECHREC.02]" />
    <xsd:enumeration value="[SECHREC.03]" />
    <xsd:enumeration value="[SECHREC.04]" />
    <xsd:enumeration value="[SECHREC.05]" />
    <xsd:enumeration value="[SECHREC.06]" />
    <xsd:enumeration value="[SECHREC.07]" />
    <xsd:enumeration value="[SECHREC.08]" />
    <xsd:enumeration value="[SECHREC.09]" />
    <xsd:enumeration value="[UPDIREC.01]" />
    <xsd:enumeration value="[UPDIREC.02]" />
    <xsd:enumeration value="[UPDIREC.03]" />
  </xsd:restriction>
</xsd:simpleType>
```

13.5.181 Record Subtype Record Name (Simple)

```
<xsd:simpleType name="Record_subtype_rec_name">
  <xsd:restriction base="xsd:string">
    <xsd:enumeration value="Album Header Record" />
    <xsd:enumeration value="Album Header Record" />
    <xsd:enumeration value="Album Header Record" />
    <xsd:enumeration value="Dataset Header Record" />
    <xsd:enumeration value="Dataset Header Record" />
    <xsd:enumeration value="Dataset Header Record" />
    <xsd:enumeration value="Dataset Header Record" />
    <xsd:enumeration value="Dataset Header Record" />
    <xsd:enumeration value="Dataset Header Record" />
    <xsd:enumeration value="Dataset Header Record" />
    <xsd:enumeration value="Source Record" />
    <xsd:enumeration value="Source Record" />
    <xsd:enumeration value="Source Record" />
    <xsd:enumeration value="Source Record" />
    <xsd:enumeration value="Source Record" />
    <xsd:enumeration value="Source Record" />
    <xsd:enumeration value="Source Record" />
  </xsd:restriction>
</xsd:simpleType>
```

```

<xsd:enumeration value="Source Record"/>
<xsd:enumeration value="Section Header Record"/>
<xsd:enumeration value="Section Header Record"/>
<xsd:enumeration value="Section Header Record"/>
<xsd:enumeration value="Section Header Record"/>
<xsd:enumeration value="Section Header Record"/>
<xsd:enumeration value="Section Header Record"/>
<xsd:enumeration value="Section Header Record"/>
<xsd:enumeration value="Section Header Record"/>
<xsd:enumeration value="Section Header Record"/>
<xsd:enumeration value="Update Information Record"/>
<xsd:enumeration value="Update Information Record"/>
<xsd:enumeration value="Update Information Record"/>
</xsd:restriction>
</xsd:simpleType>

```

13.5.182 Relationship Code Name (Simple)

```

<xsd:simpleType name="Rel_code_name">
  <xsd:restriction base="xsd:string">
    <xsd:enumeration value="Road Element Associated with Administrative Area"/>
    <xsd:enumeration value="Junction Associated with Administrative Area"/>
    <xsd:enumeration value="Road Element Associated with Named Area"/>
    <xsd:enumeration value="Building Associated with Administrative Area"/>
    <xsd:enumeration value="Service Associated with Administrative Area"/>
    <xsd:enumeration value="Built-up Area Associated with Administrative Area"/>
    <xsd:enumeration value="Ferry Connection Associated with Administrative Area"/>
    <xsd:enumeration value="District Associated with Administrative Area"/>
    <xsd:enumeration value="Enclosed Traffic Area Associated with Administrative Area"/>
    <xsd:enumeration value="Road Element Associated with Built-up Area"/>
    <xsd:enumeration value="Junction Associated with Built-up Area"/>
    <xsd:enumeration value="Ferry Connection Associated with Named Area"/>
    <xsd:enumeration value="Service Associated with Named Area"/>
    <xsd:enumeration value="Building Associated with Built-up Area"/>
    <xsd:enumeration value="Service Associated with Built-up Area"/>
    <xsd:enumeration value="Enclosed Traffic Area Associated with Built-up Area"/>
    <xsd:enumeration value="District Associated with Built-up Area"/>
    <xsd:enumeration value="Road Element Associated with District"/>
    <xsd:enumeration value="Ferry Connection Associated with Built-up Area"/>
    <xsd:enumeration value="Building along Road Element"/>
    <xsd:enumeration value="Service along Road Element"/>
    <xsd:enumeration value="Service along Road"/>
    <xsd:enumeration value="Service at Junction"/>
    <xsd:enumeration value="Service at Intersection"/>
    <xsd:enumeration value="Service related to Service"/>
    <xsd:enumeration value="Road Element leading to Enclosed Traffic Area"/>
    <xsd:enumeration value="Road Element belonging to Service"/>
    <xsd:enumeration value="Centre Point of Feature belonging to Feature"/>
    <xsd:enumeration value="Divided Junction"/>
    <xsd:enumeration value="Building associated with Service"/>
    <xsd:enumeration value="Building Façade associated with Building"/>
    <xsd:enumeration value="Building Unit associated with Building"/>
    <xsd:enumeration value="Building Unit linked to Street"/>
    <xsd:enumeration value="Building related to building"/>
    <xsd:enumeration value="Restricted Manoeuvre"/>
    <xsd:enumeration value="Prohibited Manoeuvre"/>
    <xsd:enumeration value="Priority Manoeuvre"/>
    <xsd:enumeration value="Right of Way Regulation"/>
    <xsd:enumeration value="Through Route"/>
    <xsd:enumeration value="Fork"/>
    <xsd:enumeration value="Give Way Regulation"/>
    <xsd:enumeration value="Traffic Light Regulation"/>
    <xsd:enumeration value="Connectivity"/>
    <xsd:enumeration value="Signpost Information"/>
    <xsd:enumeration value="Exit at Interchange"/>
    <xsd:enumeration value="Toll Route"/>
    <xsd:enumeration value="Grade Separated Crossing"/>
    <xsd:enumeration value="Traffic Sign along Road Element"/>
    <xsd:enumeration value="Traffic Light along Road Element"/>
    <xsd:enumeration value="Overhead Structure along Road Element"/>
    <xsd:enumeration value="Pedestrian Crossing along Road Element"/>
    <xsd:enumeration value="Place within Place"/>
    <xsd:enumeration value="Linear Assignment"/>
    <xsd:enumeration value="Multi-Point Assignment"/>
    <xsd:enumeration value="Exclusive Multi-Pont Assignment"/>
  </xsd:restriction>
</xsd:simpleType>

```

```
<xsd:enumeration value="Pedestrian Square Connected to Pedestrian Crossing"/>
<xsd:enumeration value="Pedestrian Crossing Has Entry Point"/>
<xsd:enumeration value="Route Link along Road Element"/>
<xsd:enumeration value="Stop Point along Route"/>
<xsd:enumeration value="Stop Point along Road Element"/>
<xsd:enumeration value="Stop Point at Junction"/>
<xsd:enumeration value="Stop Point located near Service"/>
<xsd:enumeration value="Public Transport Point along Route Link"/>
<xsd:enumeration value="Public Transport Connection"/>
</xsd:restriction>
</xsd:simpleType>
```

13.5.183 Relationship Code Value (Simple)

```
<xsd:simpleType name="Rel_code_value">
  <xsd:restriction base="Four_digit_int">
    <xsd:minInclusive value="1000"/>
    <xsd:maxInclusive value="8999"/>
    <xsd:enumeration value="1001"/>
    <xsd:enumeration value="1002"/>
    <xsd:enumeration value="1003"/>
    <xsd:enumeration value="1005"/>
    <xsd:enumeration value="1006"/>
    <xsd:enumeration value="1007"/>
    <xsd:enumeration value="1008"/>
    <xsd:enumeration value="1009"/>
    <xsd:enumeration value="1010"/>
    <xsd:enumeration value="1011"/>
    <xsd:enumeration value="1012"/>
    <xsd:enumeration value="1013"/>
    <xsd:enumeration value="1014"/>
    <xsd:enumeration value="1015"/>
    <xsd:enumeration value="1016"/>
    <xsd:enumeration value="1017"/>
    <xsd:enumeration value="1018"/>
    <xsd:enumeration value="1019"/>
    <xsd:enumeration value="1020"/>
    <xsd:enumeration value="1021"/>
    <xsd:enumeration value="1022"/>
    <xsd:enumeration value="1023"/>
    <xsd:enumeration value="1024"/>
    <xsd:enumeration value="1025"/>
    <xsd:enumeration value="1026"/>
    <xsd:enumeration value="1027"/>
    <xsd:enumeration value="1028"/>
    <xsd:enumeration value="1029"/>
    <xsd:enumeration value="1030"/>
    <xsd:enumeration value="1040"/>
    <xsd:enumeration value="1041"/>
    <xsd:enumeration value="1042"/>
    <xsd:enumeration value="1043"/>
    <xsd:enumeration value="1044"/>
    <xsd:enumeration value="2102"/>
    <xsd:enumeration value="2103"/>
    <xsd:enumeration value="2104"/>
    <xsd:enumeration value="2105"/>
    <xsd:enumeration value="2106"/>
    <xsd:enumeration value="2108"/>
    <xsd:enumeration value="2109"/>
    <xsd:enumeration value="2110"/>
    <xsd:enumeration value="2128"/>
    <xsd:enumeration value="2129"/>
    <xsd:enumeration value="2140"/>
    <xsd:enumeration value="2200"/>
    <xsd:enumeration value="2300"/>
    <xsd:enumeration value="2305"/>
    <xsd:enumeration value="2310"/>
    <xsd:enumeration value="2315"/>
    <xsd:enumeration value="2400"/>
    <xsd:enumeration value="4800"/>
    <xsd:enumeration value="4801"/>
    <xsd:enumeration value="4802"/>
    <xsd:enumeration value="6010"/>
    <xsd:enumeration value="6020"/>
    <xsd:enumeration value="7001"/>
  </xsd:restriction>
</xsd:simpleType>
```

```

    <xsd:enumeration value="7002" />
    <xsd:enumeration value="7003" />
    <xsd:enumeration value="7004" />
    <xsd:enumeration value="7005" />
    <xsd:enumeration value="7006" />
    <xsd:enumeration value="7007" />
  </xsd:restriction>
</xsd:simpleType>

```

13.5.184 Three Split Indicator Name (Simple)

```

<xsd:simpleType name="Three_split_ind_name">
  <xsd:restriction base="xsd:string">
    <xsd:enumeration value="entire feature" />
    <xsd:enumeration value="part of split feature" />
    <xsd:enumeration value="repeated definition" />
  </xsd:restriction>
</xsd:simpleType>

```

13.5.185 Three Split Indicator Value (Simple)

```

<xsd:simpleType name="Three_split_ind_value">
  <xsd:restriction base="xsd:integer">
    <xsd:minInclusive value="0" />
    <xsd:maxInclusive value="2" />
  </xsd:restriction>
</xsd:simpleType>

```

13.5.186 Two Split Indicator Name (Simple)

```

<xsd:simpleType name="Two_split_ind_name">
  <xsd:restriction base="xsd:string">
    <xsd:enumeration value="entire feature" />
    <xsd:enumeration value="part of split feature" />
  </xsd:restriction>
</xsd:simpleType>

```

13.5.187 Vertical Datum Name (Simple)

```

<xsd:simpleType name="Vert_datum_name">
  <xsd:restriction base="xsd:string">
    <xsd:maxLength value="50" />
    <xsd:enumeration value="Adjusted MSL 1891, Denmark" />
    <xsd:enumeration value="Alicante, 187072, Spain" />
    <xsd:enumeration value="Belfast, Ireland" />
    <xsd:enumeration value="Berlin, Germany" />
    <xsd:enumeration value="Brussels, Belgium" />
    <xsd:enumeration value="Cagliari 1956, Sardinia" />
    <xsd:enumeration value="Cascais 18811938, Portugal" />
    <xsd:enumeration value="Constanta, Rumania" />
    <xsd:enumeration value="Dansk N.N., Denmark" />
    <xsd:enumeration value="Dublin Bay, Ireland" />
    <xsd:enumeration value="Durrës, Albania" />
    <xsd:enumeration value="Errits, Denmark" />
    <xsd:enumeration value="Genoa 1942, Italy" />
    <xsd:enumeration value="Helsinki, Finland" />
    <xsd:enumeration value="Irish Ordnance Datum (Poolbeg), Ireland" />
    <xsd:enumeration value="Isle of Man Ordnance Datum, Great Britain" />
    <xsd:enumeration value="Kavala, Greece" />
    <xsd:enumeration value="Klaipėda (Memel), Lithuania" />
    <xsd:enumeration value="Malin Head, Ireland" />
    <xsd:enumeration value="Marseille 188596, France" />
    <xsd:enumeration value="Jeddah 1972, Saudi Arabia" />
    <xsd:enumeration value="Mediterranean, Italy (oldnet)" />
    <xsd:enumeration value="NADAP I, Hungary" />
    <xsd:enumeration value="NADAP II, Hungary" />
    <xsd:enumeration value="Narvik, Norway" />
    <xsd:enumeration value="Nord Norges Normal Null (NNN), Norway" />
    <xsd:enumeration value="Norges Normal Null, Norway" />
    <xsd:enumeration value="Normaal Amsterdams Peil (NAP), Netherlands" />
    <xsd:enumeration value="Normal Null (NN), Germany" />
    <xsd:enumeration value="Normalh*hen (NH) System 1960, East Germany" />
    <xsd:enumeration value="Ordnance Datum (Lerwick), Shetland Islands, Gr. Britain" />
  </xsd:restriction>
</xsd:simpleType>

```

```
<xsd:enumeration value="Ordnance Datum (Liverpool), Great Britain"/>
<xsd:enumeration value="Ordnance Datum (Newlyn), 1921 Great Britain"/>
<xsd:enumeration value="Ordnance Datum (Stornoway), Outer Herbrides, GR. Britain"/>
<xsd:enumeration value="Ostende, Belgium"/>
<xsd:enumeration value="Pierre du Niton, geneva, Switzerland"/>
<xsd:enumeration value="Reykjavik, Iceland"/>
<xsd:enumeration value="Split, Yugoslavia"/>
<xsd:enumeration value="Stockholm, Sweden"/>
<xsd:enumeration value="Tallin (Reval), Estonia"/>
<xsd:enumeration value="Thessaloniki, Greece"/>
<xsd:enumeration value="Torun, Poland"/>
<xsd:enumeration value="Tregde, Norway"/>
<xsd:enumeration value="Trieste 1875 (Italy), Austria, Czechosl., Hung., Yugosl."/>
<xsd:enumeration value="Varna, Bulgaria"/>
<xsd:enumeration value="General levelling, France"/>
<xsd:enumeration value="Relative Ordinal"/>
<xsd:enumeration value="Relative Metric"/>
</xsd:restriction>
</xsd:simpleType>
```

13.5.188 Vertical Datum Value (Simple)

```
<xsd:simpleType name="Vert_datum_value">
  <xsd:restriction base="xsd:string">
    <xsd:length value="2"/>
    <xsd:enumeration value="AE"/>
    <xsd:enumeration value="AK"/>
    <xsd:enumeration value="BK"/>
    <xsd:enumeration value="BO"/>
    <xsd:enumeration value="CA"/>
    <xsd:enumeration value="CE"/>
    <xsd:enumeration value="CM"/>
    <xsd:enumeration value="DD"/>
    <xsd:enumeration value="DI"/>
    <xsd:enumeration value="DS"/>
    <xsd:enumeration value="EA"/>
    <xsd:enumeration value="ED"/>
    <xsd:enumeration value="EI"/>
    <xsd:enumeration value="EP"/>
    <xsd:enumeration value="FN"/>
    <xsd:enumeration value="FP"/>
    <xsd:enumeration value="GA"/>
    <xsd:enumeration value="GF"/>
    <xsd:enumeration value="HQ"/>
    <xsd:enumeration value="HT"/>
    <xsd:enumeration value="JD"/>
    <xsd:enumeration value="JG"/>
    <xsd:enumeration value="KI"/>
    <xsd:enumeration value="KJ"/>
    <xsd:enumeration value="KL"/>
    <xsd:enumeration value="KP"/>
    <xsd:enumeration value="KQ"/>
    <xsd:enumeration value="KR"/>
    <xsd:enumeration value="KS"/>
    <xsd:enumeration value="KT"/>
    <xsd:enumeration value="LE"/>
    <xsd:enumeration value="LF"/>
    <xsd:enumeration value="LG"/>
    <xsd:enumeration value="LH"/>
    <xsd:enumeration value="LI"/>
    <xsd:enumeration value="LL"/>
    <xsd:enumeration value="NC"/>
    <xsd:enumeration value="PB"/>
    <xsd:enumeration value="PF"/>
    <xsd:enumeration value="PO"/>
    <xsd:enumeration value="QA"/>
    <xsd:enumeration value="QG"/>
    <xsd:enumeration value="QI"/>
    <xsd:enumeration value="QJ"/>
    <xsd:enumeration value="QO"/>
    <xsd:enumeration value="RG"/>
    <xsd:enumeration value="RO"/>
    <xsd:enumeration value="RM"/>
  </xsd:restriction>
</xsd:simpleType>
```

13.5.189 Z Reference Name (Simple)

```

<xsd:simpleType name="Zref_name">
  <xsd:restriction base="xsd:string">
    <xsd:maxLength value="50"/>
    <xsd:enumeration value="implied by coordinates"/>
    <xsd:enumeration value="achieved via edge levels"/>
    <xsd:enumeration value="achieved via relationship Grade-separated crossing"/>
    <xsd:enumeration value="no height level referencing"/>
  </xsd:restriction>
</xsd:simpleType>

```

13.5.190 Z Reference Value (Simple)

```

<xsd:simpleType name="Zref_value">
  <xsd:restriction base="xsd:integer">
    <xsd:minInclusive value="0"/>
    <xsd:maxInclusive value="3"/>
  </xsd:restriction>
</xsd:simpleType>

```

13.5.191 Grid Orientation Name ID (Simple)

```

<xsd:simpleType name="Grid_ort_name">
  <xsd:restriction base="xsd:string">
    <xsd:enumeration value="normal Cartesian"/>
    <xsd:enumeration value="reverse Cartesian"/>
  </xsd:restriction>
</xsd:simpleType>

```

13.5.192 One Digit Integer (Simple)

```

<xsd:simpleType name="One_digit_int">
  <xsd:restriction base="xsd:integer">
    <xsd:minInclusive value="0"/>
    <xsd:maxInclusive value="9"/>
  </xsd:restriction>
</xsd:simpleType>

```

13.5.193 One Digit Signed Integer (Simple)

```

<xsd:simpleType name="One_digit_signed_int">
  <xsd:restriction base="xsd:integer">
    <xsd:minInclusive value="-9"/>
    <xsd:maxInclusive value="9"/>
  </xsd:restriction>
</xsd:simpleType>

```

13.5.194 Two Digit Integer (Simple)

```

<xsd:simpleType name="Two_digit_int">
  <xsd:restriction base="xsd:integer">
    <xsd:minInclusive value="0"/>
    <xsd:maxInclusive value="99"/>
  </xsd:restriction>
</xsd:simpleType>

```

13.5.195 Three Digit Integer (Simple)

```

<xsd:simpleType name="Three_digit_int">
  <xsd:restriction base="xsd:integer">
    <xsd:minInclusive value="0"/>
    <xsd:maxInclusive value="999"/>
  </xsd:restriction>
</xsd:simpleType>

```

13.5.196 Four Digit Integer (Simple)

```
<xsd:simpleType name="Four_digit_int">  
  <xsd:restriction base="xsd:integer">  
    <xsd:minInclusive value="0"/>  
    <xsd:maxInclusive value="9999"/>  
  </xsd:restriction>  
</xsd:simpleType>
```

13.5.197 Four Digit Signed Integer (Simple)

```
<xsd:simpleType name="Four_digit_signed_int">  
  <xsd:restriction base="xsd:integer">  
    <xsd:minInclusive value="-9999"/>  
    <xsd:maxInclusive value="9999"/>  
  </xsd:restriction>  
</xsd:simpleType>
```

13.5.198 Four Digit Code (Simple)

```
<xsd:simpleType name="Four_digit_code">  
  <xsd:restriction base="Four_digit_int">  
    <xsd:totalDigits value="4"/>  
  </xsd:restriction>  
</xsd:simpleType>
```

13.5.199 Five Status Value (Simple)

```
<xsd:simpleType name="Five_status_value">  
  <xsd:restriction base="xsd:integer">  
    <xsd:minInclusive value="1"/>  
    <xsd:maxInclusive value="5"/>  
  </xsd:restriction>  
</xsd:simpleType>
```

13.5.200 Eight Digit Integer (Simple)

```
<xsd:simpleType name="Eight_digit_int">  
  <xsd:restriction base="xsd:integer">  
    <xsd:minInclusive value="0"/>  
    <xsd:maxInclusive value="99999999"/>  
  </xsd:restriction>  
</xsd:simpleType>
```

13.5.201 Nine Digit Signed Integer (Simple)

```
<xsd:simpleType name="Nine_digit_signed_int">  
  <xsd:restriction base="xsd:integer">  
    <xsd:minInclusive value="-999999999"/>  
    <xsd:maxInclusive value="999999999"/>  
  </xsd:restriction>  
</xsd:simpleType>
```

13.5.202 Ten Digit Latitude (Simple)

```
<xsd:simpleType name="Ten_digit_lat">  
  <xsd:restriction base="xsd:integer">  
    <xsd:minInclusive value="-90000000"/>  
    <xsd:maxInclusive value="+90000000"/>  
    <xsd:totalDigits value="10"/>  
  </xsd:restriction>  
</xsd:simpleType>
```

13.5.203 Ten Digit Longitude (Simple)

```
<xsd:simpleType name="Ten_digit_long">  
  <xsd:restriction base="xsd:integer">  
    <xsd:minInclusive value="-180000000"/>  
    <xsd:maxInclusive value="+180000000"/>  
  </xsd:restriction>  
</xsd:simpleType>
```



```

        <xsd:totalDigits value="10"/>
      </xsd:restriction>
    </xsd:simpleType>

```

13.5.204 Ten Digit Integer (Simple)

```

<xsd:simpleType name="Ten_digit_int">
  <xsd:restriction base="xsd:integer">
    <xsd:minInclusive value="0"/>
    <xsd:maxInclusive value="9999999999"/>
  </xsd:restriction>
</xsd:simpleType>

```

13.5.205 Ten Digit Signed Integer (Simple)

```

<xsd:simpleType name="Ten_digit_signed_int">
  <xsd:restriction base="xsd:integer">
    <xsd:minInclusive value="-9999999999"/>
    <xsd:maxInclusive value="9999999999"/>
  </xsd:restriction>
</xsd:simpleType>

```

13.5.206 Ten Digit Time Coordinate (Simple)

```

<xsd:simpleType name="Ten_digit_t_coord">
  <xsd:restriction base="xsd:integer">
    <xsd:minInclusive value="1000010100"/>
    <xsd:maxInclusive value="9999123123"/>
  </xsd:restriction>
</xsd:simpleType>

```

13.5.207 Eight Digit Time Coordinate (Simple)

```

<xsd:simpleType name="Eight_digit_t_coord">
  <xsd:restriction base="xsd:integer">
    <xsd:minInclusive value="10000101"/>
    <xsd:maxInclusive value="99991231"/>
  </xsd:restriction>
</xsd:simpleType>

```

13.5.208 Eleven Digit Integer (Simple)

```

<xsd:simpleType name="Eleven_digit_int">
  <xsd:restriction base="xsd:integer">
    <xsd:minInclusive value="0"/>
    <xsd:maxInclusive value="99999999999"/>
  </xsd:restriction>
</xsd:simpleType>

```

13.5.209 Eleven Digit Coordinate (Simple)

```

<xsd:simpleType name="Eleven_digit_coord">
  <xsd:restriction base="xsd:integer">
    <xsd:minInclusive value="-9999999999"/>
    <xsd:maxInclusive value="9999999999"/>
  </xsd:restriction>
</xsd:simpleType>

```

13.5.210 Twelve Digit Integer (Simple)

```

<xsd:simpleType name="Twelve_digit_int">
  <xsd:restriction base="xsd:integer">
    <xsd:minInclusive value="0"/>
    <xsd:maxInclusive value="999999999999"/>
  </xsd:restriction>
</xsd:simpleType>

```

13.5.211 Object Reference Type (Simple)

```
<xsd:simpleType name="Obj_ref_typ">  
  <xsd:restriction base="xsd:string">  
    <xsd:length value="1"/>  
  </xsd:restriction>  
</xsd:simpleType>
```

13.5.212 Relationship Code (Simple)

```
<xsd:simpleType name="Rel_code">  
  <xsd:restriction base="Four_digit_int">  
    <xsd:minInclusive value="1000"/>  
  </xsd:restriction>  
</xsd:simpleType>
```

13.5.213 Attribute Type Code String (Simple)

```
<xsd:simpleType name="Attr_type_code_string">  
  <xsd:restriction base="xsd:string">  
    <xsd:length value="2"/>  
  </xsd:restriction>  
</xsd:simpleType>
```

13.5.214 Attribute Value String (Simple)

```
<xsd:simpleType name="Attr_val_string">  
  <xsd:restriction base="xsd:string">  
    <xsd:length value="11"/>  
  </xsd:restriction>  
</xsd:simpleType>
```

13.5.215 Feature Code Name (Simple)

```
<xsd:simpleType name="Feature_code_name">  
  <xsd:restriction base="xsd:string">  
    <xsd:enumeration value="Supra-National Area"/>  
    <xsd:enumeration value="Country"/>  
    <xsd:enumeration value="Order-1 Area"/>  
    <xsd:enumeration value="Order-2 Area"/>  
    <xsd:enumeration value="Order-3 Area"/>  
    <xsd:enumeration value="Order-4 Area"/>  
    <xsd:enumeration value="Order-5 Area"/>  
    <xsd:enumeration value="Order-6 Area"/>  
    <xsd:enumeration value="Order-7 Area"/>  
    <xsd:enumeration value="Order-8 Area"/>  
    <xsd:enumeration value="Order-9 Area"/>  
    <xsd:enumeration value="Administrative Place A"/>  
    <xsd:enumeration value="Administrative Place B"/>  
    <xsd:enumeration value="Administrative Place C"/>  
    <xsd:enumeration value="Administrative Place D"/>  
    <xsd:enumeration value="Administrative Place E"/>  
    <xsd:enumeration value="Administrative Place F"/>  
    <xsd:enumeration value="Administrative Place G"/>  
    <xsd:enumeration value="Administrative Place H"/>  
    <xsd:enumeration value="Administrative Place I"/>  
    <xsd:enumeration value="Administrative Place J"/>  
    <xsd:enumeration value="Administrative Place K"/>  
    <xsd:enumeration value="Administrative Place L"/>  
    <xsd:enumeration value="Administrative Place M"/>  
    <xsd:enumeration value="Administrative Place N"/>  
    <xsd:enumeration value="Administrative Place O"/>  
    <xsd:enumeration value="Administrative Place P"/>  
    <xsd:enumeration value="Administrative Place Q"/>  
    <xsd:enumeration value="Administrative Place R"/>  
    <xsd:enumeration value="Administrative Place S"/>  
    <xsd:enumeration value="Administrative Place T"/>  
    <xsd:enumeration value="Administrative Place U"/>  
    <xsd:enumeration value="Administrative Place V"/>  
    <xsd:enumeration value="Administrative Place W"/>  
    <xsd:enumeration value="Administrative Place X"/>  
    <xsd:enumeration value="Administrative Place Y"/>
```

```

<xsd:enumeration value="Administrative Place Z"/>
<xsd:enumeration value="Administrative Boundary Junction"/>
<xsd:enumeration value="Administrative Boundary Element"/>
<xsd:enumeration value="Built-up Area"/>
<xsd:enumeration value="Named Area"/>
<xsd:enumeration value="Police District"/>
<xsd:enumeration value="Emergency Medical Dispatch District"/>
<xsd:enumeration value="School District"/>
<xsd:enumeration value="Census District"/>
<xsd:enumeration value="Fire Dispatch District"/>
<xsd:enumeration value="Postal District"/>
<xsd:enumeration value="Phone District"/>
<xsd:enumeration value="Electoral District"/>
<xsd:enumeration value="Boundary Junction"/>
<xsd:enumeration value="Boundary Element"/>
<xsd:enumeration value="Road Element"/>
<xsd:enumeration value="Pathway"/>
<xsd:enumeration value="Junction"/>
<xsd:enumeration value="Ferry Connection"/>
<xsd:enumeration value="Enclosed Traffic Area"/>
<xsd:enumeration value="Road"/>
<xsd:enumeration value="Intersection"/>
<xsd:enumeration value="Ferry"/>
<xsd:enumeration value="Address Area"/>
<xsd:enumeration value="Address Area Boundary Element"/>
<xsd:enumeration value="Aggregated Way"/>
<xsd:enumeration value="Interchange"/>
<xsd:enumeration value="Roundabout"/>
<xsd:enumeration value="Railway Element"/>
<xsd:enumeration value="Railway Element Junction"/>
<xsd:enumeration value="Water Body"/>
<xsd:enumeration value="Water Boundary Element"/>
<xsd:enumeration value="Water Boundary Junction"/>
<xsd:enumeration value="Inland Water"/>
<xsd:enumeration value="Reservoir"/>
<xsd:enumeration value="Lake"/>
<xsd:enumeration value="Water Course"/>
<xsd:enumeration value="Canal"/>
<xsd:enumeration value="River"/>
<xsd:enumeration value="Marine Water"/>
<xsd:enumeration value="Coastal Lagoon"/>
<xsd:enumeration value="Estuary"/>
<xsd:enumeration value="Sea and Ocean"/>
<xsd:enumeration value="Linear Datum"/>
<xsd:enumeration value="Anchor Point"/>
<xsd:enumeration value="Anchor Section"/>
<xsd:enumeration value="Path"/>
<xsd:enumeration value="Referent"/>
<xsd:enumeration value="Route Link"/>
<xsd:enumeration value="Route Point"/>
<xsd:enumeration value="Stop Point"/>
<xsd:enumeration value="Public Transport Point"/>
<xsd:enumeration value="Stop Area"/>
<xsd:enumeration value="Route"/>
<xsd:enumeration value="Line"/>
<xsd:enumeration value="Taxi Stand"/>
<xsd:enumeration value="TIN Surface"/>
<xsd:enumeration value="TIN Triangle"/>
<xsd:enumeration value="TIN Node"/>
<xsd:enumeration value="TIN Breakline"/>
<xsd:enumeration value="TIN Stopline"/>
<xsd:enumeration value="Contour Line"/>
<xsd:enumeration value="Contour Line Area"/>
<xsd:enumeration value="Contour Line Point"/>
<xsd:enumeration value="Gridded Surface"/>
<xsd:enumeration value="Sidewalk"/>
<xsd:enumeration value="Building Façade"/>
<xsd:enumeration value="Town Block"/>
<xsd:enumeration value="Block Detail"/>
<xsd:enumeration value="Building Unit"/>
<xsd:enumeration value="Building Detail"/>
<xsd:enumeration value="Schematic Building"/>
<xsd:enumeration value="Building"/>
<xsd:enumeration value="Artificial Surface"/>
<xsd:enumeration value="Urban Fabric"/>
<xsd:enumeration value="Industrial, Commercial and Transport Unit"/>

```

```

<xsd:enumeration value="Mine, Dump and Construction Site"/>
<xsd:enumeration value="Artificial, Non-Agricultural Vegetation Area"/>
<xsd:enumeration value="Continuous Urban Fabric"/>
<xsd:enumeration value="Discontinuous Urban Fabric"/>
<xsd:enumeration value="Industrial or Commercial Unit"/>
<xsd:enumeration value="Road and Rail Network and Associated Land"/>
<xsd:enumeration value="Wetland"/>
<xsd:enumeration value="Inland Wetland"/>
<xsd:enumeration value="Inland Marsh"/>
<xsd:enumeration value="Peatbog"/>
<xsd:enumeration value="Forested Wetland"/>
<xsd:enumeration value="Coastal Wetland"/>
<xsd:enumeration value="Salt Marsh"/>
<xsd:enumeration value="Saline"/>
<xsd:enumeration value="Intertidal Flat"/>
<xsd:enumeration value="Pasture and Rangeland"/>
<xsd:enumeration value="Port Area"/>
<xsd:enumeration value="Airport Area"/>
<xsd:enumeration value="Mineral Extraction Site"/>
<xsd:enumeration value="Dump Site"/>
<xsd:enumeration value="Construction Site"/>
<xsd:enumeration value="Green Urban Area"/>
<xsd:enumeration value="Sport And Leisure Facility"/>
<xsd:enumeration value="Agricultural Area"/>
<xsd:enumeration value="Arable Land"/>
<xsd:enumeration value="Permanent Crop"/>
<xsd:enumeration value="Pasture"/>
<xsd:enumeration value="Rangeland"/>
<xsd:enumeration value="Heterogeneous Agricultural Area"/>
<xsd:enumeration value="Non-irrigated Arable Land"/>
<xsd:enumeration value="Permanently Irrigated Land"/>
<xsd:enumeration value="Rice Field"/>
<xsd:enumeration value="Vineyard"/>
<xsd:enumeration value="Forest"/>
<xsd:enumeration value="Fruit Tree And Berry Plantation"/>
<xsd:enumeration value="Olive Grove"/>
<xsd:enumeration value="Annual Crop Associated With Permanent Crop"/>
<xsd:enumeration value="Complex Cultivation Pattern"/>
<xsd:enumeration value="Land Principally Occupied By Agriculture, With Significant Area

```

Of

```

    Natural Vegetation"/>
<xsd:enumeration value="Agro-Forestry Area"/>
<xsd:enumeration value="Forest And Semi-Natural Area"/>
<xsd:enumeration value="Forest"/>
<xsd:enumeration value="Scrub And/Or Herbaceous Vegetation Association"/>
<xsd:enumeration value="Open Space With Little Or No Vegetation"/>
<xsd:enumeration value="Broad-Leaved Forest"/>
<xsd:enumeration value="Coniferous Forest"/>
<xsd:enumeration value="Mixed Forest"/>
<xsd:enumeration value="Natural Grassland"/>
<xsd:enumeration value="Moor And Heathland"/>
<xsd:enumeration value="Sclerophyllous Vegetation"/>
<xsd:enumeration value="Transitional Woodland Scrub"/>
<xsd:enumeration value="Beach, Dune And Sand Plain"/>
<xsd:enumeration value="Bare Rock"/>
<xsd:enumeration value="Sparsely Vegetated Area"/>
<xsd:enumeration value="Burnt Area"/>
<xsd:enumeration value="Glaciers And Perpetual Snow"/>
<xsd:enumeration value="Park/Garden"/>
<xsd:enumeration value="Island"/>
<xsd:enumeration value="Signpost"/>
<xsd:enumeration value="Traffic Sign"/>
<xsd:enumeration value="Traffic Light"/>
<xsd:enumeration value="Pedestrian Crossing"/>
<xsd:enumeration value="Complex Pedestrian Crossing"/>
<xsd:enumeration value="Environmental Equipment"/>
<xsd:enumeration value="Lighting"/>
<xsd:enumeration value="Measurement Device"/>
<xsd:enumeration value="Road Markings"/>
<xsd:enumeration value="Safety Equipment"/>
<xsd:enumeration value="Entry Point of Service"/>
<xsd:enumeration value="Structure"/>
<xsd:enumeration value="Centre Point of Feature"/>
<xsd:enumeration value="Traffic Location"/>
<xsd:enumeration value="Entry Point"/>
</xsd:restriction>
</xsd:simpleType>

```

13.5.216 Feature Code Value (Simple)

```
<xsd:simpleType name="Feature_code_value">  
  <xsd:restriction base="Four_digit_code">  
    <xsd:minInclusive value="1000"/>  
    <xsd:maxExclusive value="8100"/>  
    <xsd:enumeration value="1110"/>  
    <xsd:enumeration value="1111"/>  
    <xsd:enumeration value="1112"/>  
    <xsd:enumeration value="1113"/>  
    <xsd:enumeration value="1114"/>  
    <xsd:enumeration value="1115"/>  
    <xsd:enumeration value="1116"/>  
    <xsd:enumeration value="1117"/>  
    <xsd:enumeration value="1118"/>  
    <xsd:enumeration value="1119"/>  
    <xsd:enumeration value="1120"/>  
    <xsd:enumeration value="1165"/>  
    <xsd:enumeration value="1166"/>  
    <xsd:enumeration value="1167"/>  
    <xsd:enumeration value="1168"/>  
    <xsd:enumeration value="1169"/>  
    <xsd:enumeration value="1170"/>  
    <xsd:enumeration value="1171"/>  
    <xsd:enumeration value="1172"/>  
    <xsd:enumeration value="1173"/>  
    <xsd:enumeration value="1174"/>  
    <xsd:enumeration value="1175"/>  
    <xsd:enumeration value="1176"/>  
    <xsd:enumeration value="1177"/>  
    <xsd:enumeration value="1178"/>  
    <xsd:enumeration value="1179"/>  
    <xsd:enumeration value="1180"/>  
    <xsd:enumeration value="1181"/>  
    <xsd:enumeration value="1182"/>  
    <xsd:enumeration value="1183"/>  
    <xsd:enumeration value="1184"/>  
    <xsd:enumeration value="1185"/>  
    <xsd:enumeration value="1186"/>  
    <xsd:enumeration value="1187"/>  
    <xsd:enumeration value="1188"/>  
    <xsd:enumeration value="1189"/>  
    <xsd:enumeration value="1190"/>  
    <xsd:enumeration value="1198"/>  
    <xsd:enumeration value="1199"/>  
    <xsd:enumeration value="3110"/>  
    <xsd:enumeration value="3120"/>  
    <xsd:enumeration value="3131"/>  
    <xsd:enumeration value="3132"/>  
    <xsd:enumeration value="3133"/>  
    <xsd:enumeration value="3134"/>  
    <xsd:enumeration value="3135"/>  
    <xsd:enumeration value="3136"/>  
    <xsd:enumeration value="3137"/>  
    <xsd:enumeration value="3138"/>  
    <xsd:enumeration value="3198"/>  
    <xsd:enumeration value="3199"/>  
    <xsd:enumeration value="4110"/>  
    <xsd:enumeration value="4115"/>  
    <xsd:enumeration value="4120"/>  
    <xsd:enumeration value="4130"/>  
    <xsd:enumeration value="4135"/>  
    <xsd:enumeration value="4140"/>  
    <xsd:enumeration value="4145"/>  
    <xsd:enumeration value="4150"/>  
    <xsd:enumeration value="4160"/>  
    <xsd:enumeration value="4165"/>  
    <xsd:enumeration value="4170"/>  
    <xsd:enumeration value="4180"/>  
    <xsd:enumeration value="4190"/>  
    <xsd:enumeration value="4210"/>  
    <xsd:enumeration value="4220"/>  
    <xsd:enumeration value="4310"/>  
    <xsd:enumeration value="4330"/>  
  </xsd:restriction>  
</xsd:simpleType>
```



```

<xsd:enumeration value="7146" />
<xsd:enumeration value="7147" />
<xsd:enumeration value="7148" />
<xsd:enumeration value="7149" />
<xsd:enumeration value="7150" />
<xsd:enumeration value="7152" />
<xsd:enumeration value="7153" />
<xsd:enumeration value="7154" />
<xsd:enumeration value="7155" />
<xsd:enumeration value="7156" />
<xsd:enumeration value="7157" />
<xsd:enumeration value="7158" />
<xsd:enumeration value="7159" />
<xsd:enumeration value="7160" />
<xsd:enumeration value="7161" />
<xsd:enumeration value="7162" />
<xsd:enumeration value="7163" />
<xsd:enumeration value="7164" />
<xsd:enumeration value="7165" />
<xsd:enumeration value="7166" />
<xsd:enumeration value="7167" />
<xsd:enumeration value="7168" />
<xsd:enumeration value="7169" />
<xsd:enumeration value="7170" />
<xsd:enumeration value="7180" />
<xsd:enumeration value="7210" />
<xsd:enumeration value="7220" />
<xsd:enumeration value="7230" />
<xsd:enumeration value="7240" />
<xsd:enumeration value="7245" />
<xsd:enumeration value="7251" />
<xsd:enumeration value="7252" />
<xsd:enumeration value="7253" />
<xsd:enumeration value="7254" />
<xsd:enumeration value="7255" />
<xsd:enumeration value="7300" />
<xsd:enumeration value="7500" />
<xsd:enumeration value="8000" />
<xsd:enumeration value="8001" />
<xsd:enumeration value="8002" />
</xsd:restriction>
</xsd:simpleType>

```

13.5.217 Character Set

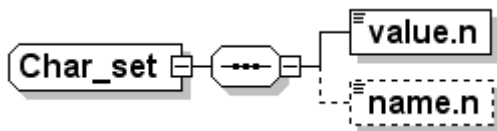

```

<xsd:complexType name="Char_set">
  <xsd:sequence>
    <xsd:element name="value.n" type="Char_set_value" />
    <xsd:element name="name.n" type="Char_set_name" minOccurs="0" />
  </xsd:sequence>
</xsd:complexType>

```

13.5.218 Extended Character Set

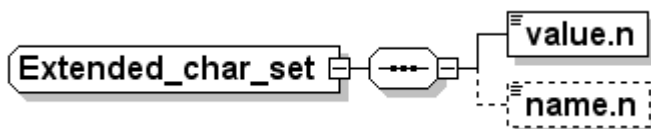

```

<xsd:complexType name="Extended_char_set">
  <xsd:sequence>
    <xsd:element name="value.n" type="Ext_char_set_value" />
    <xsd:element name="name.n" type="Ext_char_set_name" minOccurs="0" />
  </xsd:sequence>
</xsd:complexType>

```

13.5.219 Character Set Name (Simple)

```
<xsd:simpleType name="Char_set_name">
  <xsd:restriction base="xsd:string">
    <xsd:enumeration value="ISO8859-1 (Latin-1: Western European)"/>
    <xsd:enumeration value="ISO8859-2 (Latin-2: Central European)"/>
    <xsd:enumeration value="ISO8859-3 (Latin-3: South European)"/>
    <xsd:enumeration value="ISO8859-4 (Latin-4: North European)"/>
    <xsd:enumeration value="ISO8859-5 (Cyrillic)"/>
    <xsd:enumeration value="ISO8859-6 (Arabic)"/>
    <xsd:enumeration value="ISO8859-7 (Greek)"/>
    <xsd:enumeration value="ISO8859-8 (Hebrew)"/>
    <xsd:enumeration value="ISO8859-9 (Latin-5: Turkish)"/>
    <xsd:enumeration value="ISO8859-10 (Latin-6: Nordic)"/>
    <xsd:enumeration value="ISO8859-11 (Thai)"/>
    <xsd:enumeration value="ISO8859-13 (Latin-7: Baltic Rim)"/>
    <xsd:enumeration value="ISO8859-14 (Latin-8: Celtic)"/>
    <xsd:enumeration value="ISO8859-15 (Latin-9: later rework of Latin-1)"/>
    <xsd:enumeration value="ISO8859-16 (Latin-10: South-Eastern European)"/>
    <xsd:enumeration value="ISO/IEC10646 Annex D (Unicode - UTF-8)"/>
  </xsd:restriction>
</xsd:simpleType>
```

13.5.220 Character Set Value (Simple)

```
<xsd:simpleType name="Char_set_value">
  <xsd:restriction base="xsd:integer">
    <xsd:enumeration value="1"/>
    <xsd:enumeration value="2"/>
    <xsd:enumeration value="3"/>
    <xsd:enumeration value="4"/>
    <xsd:enumeration value="5"/>
    <xsd:enumeration value="6"/>
    <xsd:enumeration value="7"/>
    <xsd:enumeration value="8"/>
    <xsd:enumeration value="9"/>
    <xsd:enumeration value="10"/>
    <xsd:enumeration value="11"/>
    <xsd:enumeration value="12"/>
    <xsd:enumeration value="13"/>
    <xsd:enumeration value="14"/>
    <xsd:enumeration value="15"/>
    <xsd:enumeration value="16"/>
    <xsd:enumeration value="30"/>
  </xsd:restriction>
</xsd:simpleType>
```

13.5.221 Extended Character Set Name (Simple)

```
<xsd:simpleType name="Ext_char_set_name">
  <xsd:restriction base="xsd:string">
    <xsd:enumeration value="ISO8859-1 (Latin-1: Western European)"/>
    <xsd:enumeration value="ISO8859-2 (Latin-2: Central European)"/>
    <xsd:enumeration value="ISO8859-3 (Latin-3: South European)"/>
    <xsd:enumeration value="ISO8859-4 (Latin-4: North European)"/>
    <xsd:enumeration value="ISO8859-5 (Cyrillic)"/>
    <xsd:enumeration value="ISO8859-6 (Arabic)"/>
    <xsd:enumeration value="ISO8859-7 (Greek)"/>
    <xsd:enumeration value="ISO8859-8 (Hebrew)"/>
    <xsd:enumeration value="ISO8859-9 (Latin-5: Turkish)"/>
    <xsd:enumeration value="ISO8859-10 (Latin-6: Nordic)"/>
    <xsd:enumeration value="ISO8859-11 (Thai)"/>
    <xsd:enumeration value="ISO8859-13 (Latin-7: Baltic Rim)"/>
    <xsd:enumeration value="ISO8859-14 (Latin-8: Celtic)"/>
    <xsd:enumeration value="ISO8859-15 (Latin-9: later rework of Latin-1)"/>
    <xsd:enumeration value="ISO8859-16 (Latin-10: South-Eastern European)"/>
    <xsd:enumeration value="ISO/IEC10646 Annex D (Unicode - UTF-8)"/>
    <xsd:enumeration value="ISO/IEC10646 (Unicode - UCS-2)"/>
    <xsd:enumeration value="ISO/IEC10646 (Unicode - UCS-2, big endian)"/>
    <xsd:enumeration value="Shift-JIS (Japanese)"/>
    <xsd:enumeration value="KSC-5601 (Korean)"/>
  </xsd:restriction>
</xsd:simpleType>
```



13.5.222 Extended Character Set Value (Simple)

```

<xsd:simpleType name="Ext_char_set_value">
  <xsd:restriction base="xsd:integer">
    <xsd:enumeration value="1"/>
    <xsd:enumeration value="2"/>
    <xsd:enumeration value="3"/>
    <xsd:enumeration value="4"/>
    <xsd:enumeration value="5"/>
    <xsd:enumeration value="6"/>
    <xsd:enumeration value="7"/>
    <xsd:enumeration value="8"/>
    <xsd:enumeration value="9"/>
    <xsd:enumeration value="10"/>
    <xsd:enumeration value="11"/>
    <xsd:enumeration value="12"/>
    <xsd:enumeration value="13"/>
    <xsd:enumeration value="14"/>
    <xsd:enumeration value="15"/>
    <xsd:enumeration value="16"/>
    <xsd:enumeration value="30"/>
    <xsd:enumeration value="31"/>
    <xsd:enumeration value="32"/>
    <xsd:enumeration value="50"/>
    <xsd:enumeration value="51"/>
  </xsd:restriction>
</xsd:simpleType>

```

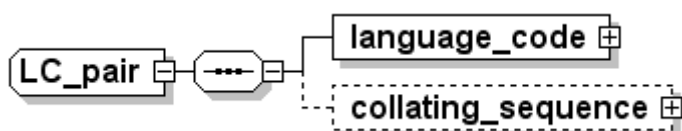
13.5.223 Language Code Pair



```

<xsd:complexType name="LC_pair">
  <xsd:sequence>
    <xsd:element name="language_code" type="Lan_cod"/>
    <xsd:element name="collating_sequence" type="Lan_cod" minOccurs="0"/>
  </xsd:sequence>
</xsd:complexType>

```

13.5.224 Role Code Name (Simple)

```

<xsd:simpleType name="Role_code_name">
  <xsd:restriction base="xsd:string">
    <xsd:enumeration value="resource provider"/>
    <xsd:enumeration value="custodian"/>
    <xsd:enumeration value="owner"/>
    <xsd:enumeration value="user"/>
    <xsd:enumeration value="distributor"/>
    <xsd:enumeration value="originator"/>
    <xsd:enumeration value="point of contact"/>
    <xsd:enumeration value="principal investigator"/>
    <xsd:enumeration value="processor"/>
    <xsd:enumeration value="publisher"/>
    <xsd:enumeration value="author"/>
  </xsd:restriction>
</xsd:simpleType>

```

13.5.225 Role Code Value (Simple)

```

<xsd:simpleType name="Role_code_value">
  <xsd:restriction base="xsd:integer">
    <xsd:minInclusive value="1"/>
    <xsd:maxInclusive value="11"/>
    <xsd:enumeration value="1"/>
    <xsd:enumeration value="2"/>
    <xsd:enumeration value="3"/>
    <xsd:enumeration value="4"/>
    <xsd:enumeration value="5"/>
    <xsd:enumeration value="6"/>
  </xsd:restriction>
</xsd:simpleType>

```

```

    <xsd:enumeration value="7" />
    <xsd:enumeration value="8" />
    <xsd:enumeration value="9" />
    <xsd:enumeration value="10" />
    <xsd:enumeration value="11" />
  </xsd:restriction>
</xsd:simpleType>

```

13.5.226 Role Code

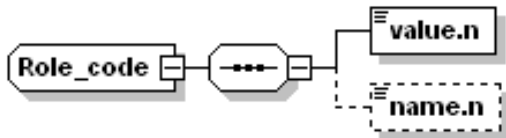

```

<xsd:complexType name="Role_code">
  <xsd:sequence>
    <xsd:element name="value.n" type="Role_code_value" />
    <xsd:element name="name.n" type="Role_code_name" minOccurs="0" />
  </xsd:sequence>
</xsd:complexType>

```

13.5.227 Reference Type Name (Simple)

```

<xsd:simpleType name="Ref_type_name">
  <xsd:restriction base="xsd:string">
    <xsd:enumeration value="Creation" />
    <xsd:enumeration value="Publication" />
    <xsd:enumeration value="Revision" />
  </xsd:restriction>
</xsd:simpleType>

```

13.5.228 Reference Type Value (Simple)

```

<xsd:simpleType name="Ref_type_value">
  <xsd:restriction base="xsd:integer">
    <xsd:minInclusive value="1" />
    <xsd:maxInclusive value="3" />
  </xsd:restriction>
</xsd:simpleType>

```

13.5.229 Reference Type

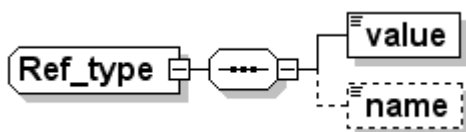

```

<xsd:complexType name="Ref_type">
  <xsd:sequence>
    <xsd:element name="value" type="Ref_type_value" />
    <xsd:element name="name" type="Ref_type_name" minOccurs="0" />
  </xsd:sequence>
</xsd:complexType>

```

13.5.230 Topic Name (Simple)

```

<xsd:simpleType name="Topic_name">
  <xsd:restriction base="xsd:string">
    <xsd:enumeration value="farming" />
    <xsd:enumeration value="biota" />
    <xsd:enumeration value="boundaries" />
    <xsd:enumeration value="climatology/meteorology/atmosphere" />
    <xsd:enumeration value="economy" />
    <xsd:enumeration value="elevation" />
    <xsd:enumeration value="environment" />
    <xsd:enumeration value="geoscientific information" />
    <xsd:enumeration value="health" />
    <xsd:enumeration value="imagery base maps earth cover" />
  </xsd:restriction>
</xsd:simpleType>

```

```

        <xsd:enumeration value="intelligenceMilitary"/>
        <xsd:enumeration value="inlandWaters"/>
        <xsd:enumeration value="location"/>
        <xsd:enumeration value="oceans"/>
        <xsd:enumeration value="planning cadastre"/>
        <xsd:enumeration value="society"/>
        <xsd:enumeration value="structure"/>
        <xsd:enumeration value="transportation"/>
        <xsd:enumeration value="utilities communication"/>
    </xsd:restriction>
</xsd:simpleType>

```

13.5.231 Topic Value (Simple)

```

<xsd:simpleType name="Topic_value">
  <xsd:restriction base="xsd:integer">
    <xsd:minInclusive value="1"/>
    <xsd:maxInclusive value="19"/>
  </xsd:restriction>
</xsd:simpleType>

```

13.5.232 Topic

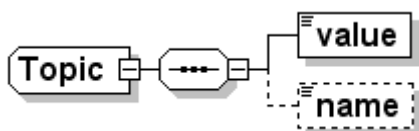

```

<xsd:complexType name="Topic">
  <xsd:sequence>
    <xsd:element name="value" type="Topic_value"/>
    <xsd:element name="name" type="Topic_name" minOccurs="0"/>
  </xsd:sequence>
</xsd:complexType>

```

13.5.233 Unit System Name (Simple)

```

<xsd:simpleType name="Unit_system_name">
  <xsd:restriction base="xsd:string">
    <xsd:enumeration value="Metric"/>
    <xsd:enumeration value="English"/>
  </xsd:restriction>
</xsd:simpleType>

```

13.5.234 Unit System Value (Simple)

```

<xsd:simpleType name="Unit_system_value">
  <xsd:restriction base="xsd:integer">
    <xsd:enumeration value="1"/>
    <xsd:enumeration value="2"/>
  </xsd:restriction>
</xsd:simpleType>

```

13.5.235 Unit System

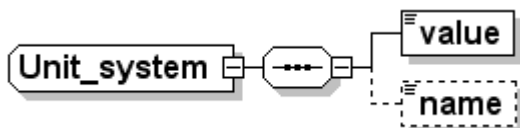

```

<xsd:complexType name="Unit_system">
  <xsd:sequence>
    <xsd:element name="value" type="Unit_system_value"/>
    <xsd:element name="name" type="Unit_system_name" minOccurs="0"/>
  </xsd:sequence>
</xsd:complexType>

```

13.5.236 Attribute Code Lists

13.5.236.1 Administrative Boundary Type

13.5.236.1.1 Administrative Boundary Type Structure

```
<xsd:complexType name="Attr_BX_ENUM">  
<!-- Administrative Boundary Type -->  
  <xsd:sequence>  
    <xsd:element name="value" type="Attr_BX_ENM_value"/>  
    <xsd:element name="name" type="Attr_BX_ENM_name" minOccurs="0"/>  
  </xsd:sequence>  
</xsd:complexType>
```

13.5.236.1.2 Administrative Boundary Type Name

```
<xsd:simpleType name="Attr_BX_ENM_name">  
  <xsd:restriction base="xsd:string">  
    <xsd:enumeration value="Database Coverage Area Edge"/>  
    <xsd:enumeration value="Supra-National"/>  
    <xsd:enumeration value="Country"/>  
    <xsd:enumeration value="Order-1 Administrative Area"/>  
    <xsd:enumeration value="Order-2 Administrative Area"/>  
    <xsd:enumeration value="Order-3 Administrative Area"/>  
    <xsd:enumeration value="Order-4 Administrative Area"/>  
    <xsd:enumeration value="Order-5 Administrative Area"/>  
    <xsd:enumeration value="Order-6 Administrative Area"/>  
    <xsd:enumeration value="Order-7 Administrative Area"/>  
    <xsd:enumeration value="Order-8 Administrative Area"/>  
    <xsd:enumeration value="Order-9 Administrative Area"/>  
    <xsd:enumeration value="Administrative Place A"/>  
    <xsd:enumeration value="Administrative Place B"/>  
    <xsd:enumeration value="Administrative Place C"/>  
    <xsd:enumeration value="Administrative Place D"/>  
    <xsd:enumeration value="Administrative Place E"/>  
    <xsd:enumeration value="Administrative Place F"/>  
    <xsd:enumeration value="Administrative Place G"/>  
    <xsd:enumeration value="Administrative Place H"/>  
    <xsd:enumeration value="Administrative Place I"/>  
    <xsd:enumeration value="Administrative Place J"/>  
    <xsd:enumeration value="Administrative Place K"/>  
    <xsd:enumeration value="Administrative Place L"/>  
    <xsd:enumeration value="Administrative Place M"/>  
    <xsd:enumeration value="Administrative Place N"/>  
    <xsd:enumeration value="Administrative Place O"/>  
    <xsd:enumeration value="Administrative Place P"/>  
    <xsd:enumeration value="Administrative Place Q"/>  
    <xsd:enumeration value="Administrative Place R"/>  
    <xsd:enumeration value="Administrative Place S"/>  
    <xsd:enumeration value="Administrative Place T"/>  
    <xsd:enumeration value="Administrative Place U"/>  
    <xsd:enumeration value="Administrative Place V"/>  
    <xsd:enumeration value="Administrative Place W"/>  
    <xsd:enumeration value="Administrative Place X"/>  
    <xsd:enumeration value="Administrative Place Y"/>  
    <xsd:enumeration value="Administrative Place Z"/>  
  </xsd:restriction>  
</xsd:simpleType>
```

13.5.236.1.3 Administrative Boundary Type Value

```
<xsd:simpleType name="Attr_BX_ENM_value">  
  <xsd:restriction base="xsd:integer">  
    <xsd:enumeration value="5"/>  
    <xsd:enumeration value="10"/>  
    <xsd:enumeration value="20"/>  
    <xsd:enumeration value="21"/>  
    <xsd:enumeration value="22"/>  
    <xsd:enumeration value="23"/>  
    <xsd:enumeration value="24"/>  
    <xsd:enumeration value="25"/>  
    <xsd:enumeration value="26"/>  
  </xsd:restriction>  
</xsd:simpleType>
```

```

    <xsd:enumeration value="27"/>
    <xsd:enumeration value="28"/>
    <xsd:enumeration value="29"/>
    <xsd:enumeration value="65"/>
    <xsd:enumeration value="66"/>
    <xsd:enumeration value="67"/>
    <xsd:enumeration value="68"/>
    <xsd:enumeration value="69"/>
    <xsd:enumeration value="70"/>
    <xsd:enumeration value="71"/>
    <xsd:enumeration value="72"/>
    <xsd:enumeration value="73"/>
    <xsd:enumeration value="74"/>
    <xsd:enumeration value="75"/>
    <xsd:enumeration value="76"/>
    <xsd:enumeration value="77"/>
    <xsd:enumeration value="78"/>
    <xsd:enumeration value="79"/>
    <xsd:enumeration value="80"/>
    <xsd:enumeration value="81"/>
    <xsd:enumeration value="82"/>
    <xsd:enumeration value="83"/>
    <xsd:enumeration value="84"/>
    <xsd:enumeration value="85"/>
    <xsd:enumeration value="86"/>
    <xsd:enumeration value="87"/>
    <xsd:enumeration value="88"/>
    <xsd:enumeration value="89"/>
    <xsd:enumeration value="90"/>
  </xsd:restriction>
</xsd:simpleType>

```

13.5.236.2 Association Type

13.5.236.2.1 Association Type Structure

```

  <xsd:complexType name="Attr_AY_CODE">
<!-- Association Type -->
    <xsd:sequence>
      <xsd:element name="value" type="Attr_AY_COD_value"/>
      <xsd:element name="name" type="Attr_AY_COD_name" minOccurs="0"/>
    </xsd:sequence>
  </xsd:complexType>

```

13.5.236.2.2 Association Type Name

```

  <xsd:simpleType name="Attr_AY_COD_name">
    <xsd:restriction base="xsd:string">
      <xsd:enumeration value="Geographically Located In"/>
      <xsd:enumeration value="Commonly Associated With"/>
    </xsd:restriction>
  </xsd:simpleType>

```

13.5.236.2.3 Association Type Value

```

  <xsd:simpleType name="Attr_AY_COD_value">
    <xsd:restriction base="xsd:integer">
      <xsd:enumeration value="1"/>
      <xsd:enumeration value="2"/>
    </xsd:restriction>
  </xsd:simpleType>

```

13.5.236.3 Block Grouping

13.5.236.3.1 Block Grouping Structure

```

  <xsd:complexType name="Attr_BG_CODE">
<!-- Block Grouping -->
    <xsd:sequence>
      <xsd:element name="value" type="Attr_BG_COD_value"/>
      <xsd:element name="name" type="Attr_BG_COD_name" minOccurs="0"/>
    </xsd:sequence>
  </xsd:complexType>

```

```
</xsd:sequence>  
</xsd:complexType>
```

13.5.236.3.2 Block Grouping Name

```
<xsd:simpleType name="Attr_BG_COD_name">  
  <xsd:restriction base="xsd:string">  
    <xsd:enumeration value="Group 1"/>  
    <xsd:enumeration value="Group 2"/>  
    <xsd:enumeration value="Group 3"/>  
    <xsd:enumeration value="Group 4"/>  
    <xsd:enumeration value="Group 5"/>  
    <xsd:enumeration value="Group 6"/>  
    <xsd:enumeration value="Group 7"/>  
    <xsd:enumeration value="Group 8"/>  
    <xsd:enumeration value="Group 9"/>  
    <xsd:enumeration value="Group 10"/>  
    <!-- a break in the sequence occurs in the middle... -->  
    <xsd:enumeration value="Group 90"/>  
    <xsd:enumeration value="Group 91"/>  
    <xsd:enumeration value="Group 92"/>  
    <xsd:enumeration value="Group 93"/>  
    <xsd:enumeration value="Group 94"/>  
    <xsd:enumeration value="Group 95"/>  
    <xsd:enumeration value="Group 96"/>  
    <xsd:enumeration value="Group 97"/>  
    <xsd:enumeration value="Group 98"/>  
    <xsd:enumeration value="Group 99"/>  
  </xsd:restriction>  
</xsd:simpleType>
```

13.5.236.3.3 Block Grouping Value

```
<xsd:simpleType name="Attr_BG_COD_value">  
  <xsd:restriction base="xsd:integer">  
    <xsd:enumeration value="1"/>  
    <xsd:enumeration value="2"/>  
    <xsd:enumeration value="3"/>  
    <xsd:enumeration value="4"/>  
    <xsd:enumeration value="5"/>  
    <xsd:enumeration value="6"/>  
    <xsd:enumeration value="7"/>  
    <xsd:enumeration value="8"/>  
    <xsd:enumeration value="9"/>  
    <xsd:enumeration value="10"/>  
    <!-- a break in the sequence occurs in the middle... -->  
    <xsd:enumeration value="90"/>  
    <xsd:enumeration value="91"/>  
    <xsd:enumeration value="92"/>  
    <xsd:enumeration value="93"/>  
    <xsd:enumeration value="94"/>  
    <xsd:enumeration value="95"/>  
    <xsd:enumeration value="96"/>  
    <xsd:enumeration value="97"/>  
    <xsd:enumeration value="98"/>  
    <xsd:enumeration value="99"/>  
  </xsd:restriction>  
</xsd:simpleType>
```

13.5.236.4 Block Type

13.5.236.4.1 Block Type Structure

```
<xsd:complexType name="Attr_BO_CODE">  
<!-- Block Type -->  
  <xsd:sequence>  
    <xsd:element name="value" type="Attr_BO_COD_value"/>  
    <xsd:element name="name" type="Attr_BO_COD_name" minOccurs="0"/>  
  </xsd:sequence>  
</xsd:complexType>
```

13.5.236.4.2 Block Type Name

```
<xsd:simpleType name="Attr_BO_COD_name">
  <xsd:restriction base="xsd:string">
    <xsd:enumeration value="Sub-divisions Line"/>
    <xsd:enumeration value="Crossing Line"/>
  </xsd:restriction>
</xsd:simpleType>
```

13.5.236.4.3 Block Type Value

```
<xsd:simpleType name="Attr_BO_COD_value">
  <xsd:restriction base="xsd:integer">
    <xsd:enumeration value="1"/>
    <xsd:enumeration value="2"/>
  </xsd:restriction>
</xsd:simpleType>
```

13.5.236.5 Blocked Passage Location

13.5.236.5.1 Blocked Passage Location Structure

```
<xsd:complexType name="Attr_BP_CODE">
<!-- Blocked Passage Location -->
  <xsd:sequence>
    <xsd:element name="value" type="Attr_BP_COD_value"/>
    <xsd:element name="name" type="Attr_BP_COD_name" minOccurs="0"/>
  </xsd:sequence>
</xsd:complexType>
```

13.5.236.5.2 Blocked Passage Location Name

```
<xsd:simpleType name="Attr_BP_COD_name">
  <xsd:restriction base="xsd:string">
    <xsd:enumeration value="Physically Blocked at Start Junction"/>
    <xsd:enumeration value="Physically Blocked at End Junction"/>
    <xsd:enumeration value="Physically Blocked between Start and End Junction"/>
  </xsd:restriction>
</xsd:simpleType>
```

13.5.236.5.3 Blocked Passage Location Value

```
<xsd:simpleType name="Attr_BP_COD_value">
  <xsd:restriction base="xsd:integer">
    <xsd:enumeration value="1"/>
    <xsd:enumeration value="2"/>
    <xsd:enumeration value="3"/>
  </xsd:restriction>
</xsd:simpleType>
```

13.5.236.6 Blocked Passage Type

13.5.236.6.1 Blocked Passage Type Structure

```
<xsd:complexType name="Attr_BE_CODE">
<!-- Blocked Passage Type -->
  <xsd:sequence>
    <xsd:element name="value" type="Attr_BE_COD_value"/>
    <xsd:element name="name" type="Attr_BE_COD_name" minOccurs="0"/>
  </xsd:sequence>
</xsd:complexType>
```

13.5.236.6.2 Blocked Passage Type Name

```
<xsd:simpleType name="Attr_BE_COD_name">
  <xsd:restriction base="xsd:string">
    <xsd:enumeration value="Permanently fixed"/>
    <xsd:enumeration value="Removable"/>
  </xsd:restriction>
</xsd:simpleType>
```

```
</xsd:restriction>  
</xsd:simpleType>
```

13.5.236.6.3 Blocked Passage Type Value

```
<xsd:simpleType name="Attr_BE_COD_value">  
  <xsd:restriction base="xsd:integer">  
    <xsd:enumeration value="1"/>  
    <xsd:enumeration value="2"/>  
  </xsd:restriction>  
</xsd:simpleType>
```

13.5.236.7 Boundary Type

13.5.236.7.1 Boundary Type Structure

```
<xsd:complexType name="Attr_BY_ENUM">  
<!-- Boundary Type -->  
  <xsd:sequence>  
    <xsd:element name="value" type="Attr_BY_ENM_value"/>  
    <xsd:element name="name" type="Attr_BY_ENM_name" minOccurs="0"/>  
  </xsd:sequence>  
</xsd:complexType>
```

13.5.236.7.2 Boundary Type Name

```
<xsd:simpleType name="Attr_BY_ENM_name">  
  <xsd:restriction base="xsd:string">  
    <xsd:enumeration value="Database Coverage Area Edge"/>  
    <xsd:enumeration value="Built-up Area"/>  
    <xsd:enumeration value="Named Area"/>  
    <xsd:enumeration value="Police District"/>  
    <xsd:enumeration value="Emergency Medical Dispatch District"/>  
    <xsd:enumeration value="School District"/>  
    <xsd:enumeration value="Census District"/>  
    <xsd:enumeration value="Fire Dispatch District"/>  
    <xsd:enumeration value="Postal District"/>  
    <xsd:enumeration value="Phone District"/>  
    <xsd:enumeration value="Electoral District"/>  
  </xsd:restriction>  
</xsd:simpleType>
```

13.5.236.7.3 Boundary Type Value

```
<xsd:simpleType name="Attr_BY_ENM_value">  
  <xsd:restriction base="xsd:integer">  
    <xsd:enumeration value="5"/>  
    <xsd:enumeration value="10"/>  
    <xsd:enumeration value="20"/>  
    <xsd:enumeration value="31"/>  
    <xsd:enumeration value="32"/>  
    <xsd:enumeration value="33"/>  
    <xsd:enumeration value="34"/>  
    <xsd:enumeration value="35"/>  
    <xsd:enumeration value="36"/>  
    <xsd:enumeration value="37"/>  
    <xsd:enumeration value="38"/>  
  </xsd:restriction>  
</xsd:simpleType>
```

13.5.236.8 Building Detail Type

13.5.236.8.1 Building Detail Type Structure

```
<xsd:complexType name="Attr_BD_CODE">  
<!-- Building Detail Type -->  
  <xsd:sequence>  
    <xsd:element name="value" type="Attr_BD_COD_value"/>  
    <xsd:element name="name" type="Attr_BD_COD_name" minOccurs="0"/>  
  </xsd:sequence>  
</xsd:complexType>
```

13.5.236.8.2 Building Detail Type Name

```

<xsd:simpleType name="Attr_BD_COD_name">
  <xsd:restriction base="xsd:string">
    <xsd:enumeration value="Soft Line"/>
    <xsd:enumeration value="Hard Line"/>
  </xsd:restriction>
</xsd:simpleType>

```

13.5.236.8.3 Building Detail Type Value

```

<xsd:simpleType name="Attr_BD_COD_value">
  <xsd:restriction base="xsd:integer">
    <xsd:enumeration value="1"/>
    <xsd:enumeration value="2"/>
  </xsd:restriction>
</xsd:simpleType>

```

13.5.236.9 Car Dealer Type

13.5.236.9.1 Car Dealer Type Structure

```

<xsd:complexType name="Attr_CD_CODE">
<!-- Car Dealer Type -->
  <xsd:sequence>
    <xsd:element name="value" type="Attr_CD_COD_value"/>
    <xsd:element name="name" type="Attr_CD_COD_name" minOccurs="0"/>
  </xsd:sequence>
</xsd:complexType>

```

13.5.236.9.2 Car Dealer Type Name

```

<xsd:simpleType name="Attr_CD_COD_name">
  <xsd:restriction base="xsd:string">
    <xsd:enumeration value="Sales Facility"/>
    <xsd:enumeration value="Repair Facility"/>
    <xsd:enumeration value="Sales and Repair Facility"/>
  </xsd:restriction>
</xsd:simpleType>

```

13.5.236.9.3 Car Dealer Type Value

```

<xsd:simpleType name="Attr_CD_COD_value">
  <xsd:restriction base="xsd:integer">
    <xsd:enumeration value="1"/>
    <xsd:enumeration value="2"/>
    <xsd:enumeration value="3"/>
  </xsd:restriction>
</xsd:simpleType>

```

13.5.236.10 City Center Administrative Class

13.5.236.10.1 City Center Administrative Class Structure

```

<xsd:complexType name="Attr_CC_ENUM">
<!-- City Center Administrative Class -->
  <xsd:sequence>
    <xsd:element name="value" type="Attr_CC_ENM_value"/>
    <xsd:element name="name" type="Attr_CC_ENM_name" minOccurs="0"/>
  </xsd:sequence>
</xsd:complexType>

```

13.5.236.10.2 City Center Administrative Class Name

```

<xsd:simpleType name="Attr_CC_ENM_name">
  <xsd:restriction base="xsd:string">
    <xsd:enumeration value="Class 0"/>
  </xsd:restriction>
</xsd:simpleType>

```

```
<xsd:enumeration value="Class 1"/>
<xsd:enumeration value="Class 2"/>
<xsd:enumeration value="Class 3"/>
<xsd:enumeration value="Class 4"/>
<xsd:enumeration value="Class 5"/>
<xsd:enumeration value="Class 6"/>
<xsd:enumeration value="Class 7"/>
<xsd:enumeration value="Class 8"/>
<xsd:enumeration value="Class 9"/>
<xsd:enumeration value="Others"/>
</xsd:restriction>
</xsd:simpleType>
```

13.5.236.10.3 City Center Administrative Class Value

```
<xsd:simpleType name="Attr_CC_ENM_value">
  <xsd:restriction base="xsd:integer">
    <xsd:enumeration value="0"/>
    <xsd:enumeration value="1"/>
    <xsd:enumeration value="2"/>
    <xsd:enumeration value="3"/>
    <xsd:enumeration value="4"/>
    <xsd:enumeration value="5"/>
    <xsd:enumeration value="6"/>
    <xsd:enumeration value="7"/>
    <xsd:enumeration value="8"/>
    <xsd:enumeration value="9"/>
    <xsd:enumeration value="10"/>
  </xsd:restriction>
</xsd:simpleType>
```

13.5.236.11 Construction Status

13.5.236.11.1 Construction Status Structure

```
<xsd:complexType name="Attr_CS_CODE">
<!-- Construction Status -->
  <xsd:sequence>
    <xsd:element name="value" type="Attr_CS_COD_value"/>
    <xsd:element name="name" type="Attr_CS_COD_name" minOccurs="0"/>
  </xsd:sequence>
</xsd:complexType>
```

13.5.236.11.2 Construction Status Name

```
<xsd:simpleType name="Attr_CS_COD_name">
  <xsd:restriction base="xsd:string">
    <xsd:enumeration value="Planned"/>
    <xsd:enumeration value="Under Construction - closed"/>
    <xsd:enumeration value="Under Construction - open"/>
  </xsd:restriction>
</xsd:simpleType>
```

13.5.236.11.3 Construction Status Value

```
<xsd:simpleType name="Attr_CS_COD_value">
  <xsd:restriction base="xsd:integer">
    <xsd:enumeration value="1"/>
    <xsd:enumeration value="2"/>
    <xsd:enumeration value="3"/>
  </xsd:restriction>
</xsd:simpleType>
```

13.5.236.12 Continuation Type

13.5.236.12.1 Continuation Type Structure

```
<xsd:complexType name="Attr_CP_CODE">
<!-- Continuation Type -->
  <xsd:sequence>
```

```

    <xsd:element name="value" type="Attr_CP_COD_value"/>
    <xsd:element name="name" type="Attr_CP_COD_name" minOccurs="0"/>
  </xsd:sequence>
</xsd:complexType>

```

13.5.236.12.2 Continuation Type Name

```

<xsd:simpleType name="Attr_CP_COD_name">
  <xsd:restriction base="xsd:string">
    <xsd:enumeration value="Natural"/>
    <xsd:enumeration value="Other type of lane transition"/>
  </xsd:restriction>
</xsd:simpleType>

```

13.5.236.12.3 Continuation Type Value

```

<xsd:simpleType name="Attr_CP_COD_value">
  <xsd:restriction base="xsd:integer">
    <xsd:enumeration value="0"/>
    <xsd:enumeration value="1"/>
  </xsd:restriction>
</xsd:simpleType>

```

13.5.236.13 Departure/Arrival

13.5.236.13.1 Departure/Arrival Structure

```

<xsd:complexType name="Attr_AD_CODE">
<!-- Departure/Arrival -->
  <xsd:sequence>
    <xsd:element name="value" type="Attr_AD_COD_value"/>
    <xsd:element name="name" type="Attr_AD_COD_name" minOccurs="0"/>
  </xsd:sequence>
</xsd:complexType>

```

13.5.236.13.2 Departure/Arrival Name

```

<xsd:simpleType name="Attr_AD_COD_name">
  <xsd:restriction base="xsd:string">
    <xsd:enumeration value="Departure"/>
    <xsd:enumeration value="Arrival"/>
    <xsd:enumeration value="Departure and Arrival"/>
  </xsd:restriction>
</xsd:simpleType>

```

13.5.236.13.3 Departure/Arrival Value

```

<xsd:simpleType name="Attr_AD_COD_value">
  <xsd:restriction base="xsd:integer">
    <xsd:enumeration value="1"/>
    <xsd:enumeration value="2"/>
    <xsd:enumeration value="3"/>
  </xsd:restriction>
</xsd:simpleType>

```

13.5.236.14 Direction Category

13.5.236.14.1 Direction Category Structure

```

<xsd:complexType name="Attr_DI_BMI">
<!-- Direction Category -->
  <xsd:sequence>
    <xsd:element name="value" type="Attr_DI_BMI_value"/>
    <xsd:element name="name" type="Attr_DI_BMI_name" minOccurs="0"/>
  </xsd:sequence>
</xsd:complexType>

```

13.5.236.14.2 Direction Category Name

```
<xsd:simpleType name="Attr_DI_BMI_name">  
  <xsd:restriction base="xsd:string">  
    <xsd:enumeration value="Ahead"/>  
    <xsd:enumeration value="Between ahead and right"/>  
    <xsd:enumeration value="Right"/>  
    <xsd:enumeration value="Between right and backward"/>  
    <xsd:enumeration value="Backward (u-turn)"/>  
    <xsd:enumeration value="Between left and backward"/>  
    <xsd:enumeration value="Left"/>  
    <xsd:enumeration value="Between ahead and left"/>  
    <xsd:enumeration value="Merge into right lane (lane ends)"/>  
    <xsd:enumeration value="Merge into left lane (lane ends)"/>  
    <xsd:enumeration value="Merge lanes (no priority lane)"/>  
  </xsd:restriction>  
</xsd:simpleType>
```

13.5.236.14.3 Direction Category Value

```
<xsd:simpleType name="Attr_DI_BMI_value">  
  <xsd:restriction base="xsd:integer">  
    <!-- Values 1-7 reserved for future use -->  
    <xsd:enumeration value="8"/>  
    <xsd:enumeration value="16"/>  
    <xsd:enumeration value="32"/>  
    <xsd:enumeration value="64"/>  
    <xsd:enumeration value="128"/>  
    <xsd:enumeration value="256"/>  
    <xsd:enumeration value="512"/>  
    <xsd:enumeration value="1024"/>  
    <xsd:enumeration value="2048"/>  
    <xsd:enumeration value="4096"/>  
    <xsd:enumeration value="8192"/>  
  </xsd:restriction>  
</xsd:simpleType>
```

13.5.236.15 Display Class

13.5.236.15.1 Display Class Structure

```
<xsd:complexType name="Attr_DY_CODE">  
<!-- Display Class -->  
  <xsd:sequence>  
    <xsd:element name="value" type="Attr_DY_COD_value"/>  
    <xsd:element name="name" type="Attr_DY_COD_name" minOccurs="0"/>  
  </xsd:sequence>  
</xsd:complexType>
```

13.5.236.15.2 Display Class Name

```
<xsd:simpleType name="Attr_DY_COD_name">  
  <xsd:restriction base="xsd:string">  
    <xsd:enumeration value="First Class"/>  
    <xsd:enumeration value="Second Class"/>  
    <xsd:enumeration value="Third Class"/>  
    <xsd:enumeration value="Fourth Class"/>  
    <xsd:enumeration value="Fifth Class"/>  
    <xsd:enumeration value="Sixth Class"/>  
    <xsd:enumeration value="Seventh Class"/>  
    <xsd:enumeration value="Eighth Class"/>  
    <xsd:enumeration value="Ninth Class"/>  
    <xsd:enumeration value="Tenth Class"/>  
  </xsd:restriction>  
</xsd:simpleType>
```

13.5.236.15.3 Display Class Value

```
<xsd:simpleType name="Attr_DY_COD_value">  
  <xsd:restriction base="xsd:integer">  
    <xsd:enumeration value="1"/>  
  </xsd:restriction>  
</xsd:simpleType>
```

```

        <xsd:enumeration value="2"/>
        <xsd:enumeration value="3"/>
        <xsd:enumeration value="4"/>
        <xsd:enumeration value="5"/>
        <xsd:enumeration value="6"/>
        <xsd:enumeration value="7"/>
        <xsd:enumeration value="8"/>
        <xsd:enumeration value="9"/>
        <xsd:enumeration value="10"/>
    </xsd:restriction>
</xsd:simpleType>

```

13.5.236.16 Divider Colour

13.5.236.16.1 Divider Colour Structure

```

<xsd:complexType name="Attr_DZ_CODE">
<!-- Divider Colour -->
    <xsd:sequence>
        <xsd:element name="value" type="Attr_DZ_COD_value"/>
        <xsd:element name="name" type="Attr_DZ_COD_name" minOccurs="0"/>
    </xsd:sequence>
</xsd:complexType>

```

13.5.236.16.2 Divider Colour Name

```

<xsd:simpleType name="Attr_DZ_COD_name">
    <xsd:restriction base="xsd:string">
        <xsd:enumeration value="White"/>
        <xsd:enumeration value="Yellow"/>
    </xsd:restriction>
</xsd:simpleType>

```

13.5.236.16.3 Divider Colour Value

```

<xsd:simpleType name="Attr_DZ_COD_value">
    <xsd:restriction base="xsd:integer">
        <xsd:enumeration value="1"/>
        <xsd:enumeration value="2"/>
    </xsd:restriction>
</xsd:simpleType>

```

13.5.236.17 Divider Impact

13.5.236.17.1 Divider Impact Structure

```

<xsd:complexType name="Attr_DX_CODE">
<!-- Divider Impact -->
    <xsd:sequence>
        <xsd:element name="value" type="Attr_DX_COD_value"/>
        <xsd:element name="name" type="Attr_DX_COD_name" minOccurs="0"/>
    </xsd:sequence>
</xsd:complexType>

```

13.5.236.17.2 Divider Impact Name

```

<xsd:simpleType name="Attr_DX_COD_name">
    <xsd:restriction base="xsd:string">
        <xsd:enumeration value="Traversable"/>
        <xsd:enumeration value="Traversable from right only"/>
        <xsd:enumeration value="Traversable from left only"/>
        <xsd:enumeration value="Not Traversable"/>
    </xsd:restriction>
</xsd:simpleType>

```

13.5.236.17.3 Divider Impact Value

```

<xsd:simpleType name="Attr_DX_COD_value">
    <xsd:restriction base="xsd:integer">

```

```
<xsd:enumeration value="1" />
<xsd:enumeration value="2" />
<xsd:enumeration value="3" />
<xsd:enumeration value="4" />
</xsd:restriction>
</xsd:simpleType>
```

13.5.236.18 Divider Marking

13.5.236.18.1 Divider Marking Structure

```
<xsd:complexType name="Attr_DM_CODE">
<!-- Divider Marking -->
  <xsd:sequence>
    <xsd:element name="value" type="Attr_DM_COD_value" />
    <xsd:element name="name" type="Attr_DM_COD_name" minOccurs="0" />
  </xsd:sequence>
</xsd:complexType>
```

13.5.236.18.2 Divider Marking Name

```
<xsd:simpleType name="Attr_DM_COD_name">
  <xsd:restriction base="xsd:string">
    <xsd:enumeration value="No line marking (i.e. no divider)" />
    <xsd:enumeration value="Dashed Line (long line sections)" />
    <xsd:enumeration value="Double solid line" />
    <xsd:enumeration value="Single solid line" />
    <xsd:enumeration value="Double line: combination of (inner) single solid line and (outer)
dashed
                                line" />
    <xsd:enumeration value="Double line: combination of (inner) dashed line and (outer) single
solid
                                line" />
    <xsd:enumeration value="Dashed line (short line sections)" />
    <xsd:enumeration value="Shaded area marking" />
  </xsd:restriction>
</xsd:simpleType>
```

13.5.236.18.3 Divider Marking Value

```
<xsd:simpleType name="Attr_DM_COD_value">
  <xsd:restriction base="xsd:integer">
    <xsd:enumeration value="0" />
    <xsd:enumeration value="1" />
    <xsd:enumeration value="2" />
    <xsd:enumeration value="3" />
    <xsd:enumeration value="4" />
    <xsd:enumeration value="5" />
    <xsd:enumeration value="6" />
    <xsd:enumeration value="7" />
  </xsd:restriction>
</xsd:simpleType>
```

13.5.236.19 Divider Type

13.5.236.19.1 Divider Type Structure

```
<xsd:complexType name="Attr_DT_CODE">
<!-- Divider Type -->
  <xsd:sequence>
    <xsd:element name="value" type="Attr_DT_COD_value" />
    <xsd:element name="name" type="Attr_DT_COD_name" minOccurs="0" />
  </xsd:sequence>
</xsd:complexType>
```

13.5.236.19.2 Divider Type Name

```
<xsd:simpleType name="Attr_DT_COD_name">
  <xsd:restriction base="xsd:string">
    <xsd:enumeration value="Legal Divider (not physical)" />
  </xsd:restriction>
</xsd:simpleType>
```

```

        <xsd:enumeration value="Physical Divider"/>
    </xsd:restriction>
</xsd:simpleType>

```

13.5.236.19.3 Divider Type Value

```

<xsd:simpleType name="Attr_DT_COD_value">
  <xsd:restriction base="xsd:integer">
    <!-- Values 1-2 reserved for future use -->
    <xsd:enumeration value="3"/>
    <xsd:enumeration value="4"/>
    <!-- Values 1-2 reserved for future use -->
  </xsd:restriction>
</xsd:simpleType>

```

13.5.236.20 Domestic/Internations

13.5.236.20.1 Domestic/Internations Structure

```

<xsd:complexType name="Attr_NI_CODE">
<!-- Domestic/International -->
  <xsd:sequence>
    <xsd:element name="value" type="Attr_NI_COD_value"/>
    <xsd:element name="name" type="Attr_NI_COD_name" minOccurs="0"/>
  </xsd:sequence>
</xsd:complexType>

```

13.5.236.20.2 Domestic/International Name

```

<xsd:simpleType name="Attr_NI_COD_name">
  <xsd:restriction base="xsd:string">
    <xsd:enumeration value="Domestic"/>
    <xsd:enumeration value="International"/>
    <xsd:enumeration value="Domestic and International"/>
  </xsd:restriction>
</xsd:simpleType>

```

13.5.236.20.3 Domestic/International Value

```

<xsd:simpleType name="Attr_NI_COD_value">
  <xsd:restriction base="xsd:integer">
    <xsd:enumeration value="1"/>
    <xsd:enumeration value="2"/>
    <xsd:enumeration value="3"/>
  </xsd:restriction>
</xsd:simpleType>

```

13.5.236.21 Enclosed Traffic Area

13.5.236.21.1 Enclosed Traffic Area Structure

```

<xsd:complexType name="Attr_EA_CODE">
<!-- Enclosed Traffic Area -->
  <xsd:sequence>
    <xsd:element name="value" type="Attr_EA_COD_value"/>
    <xsd:element name="name" type="Attr_EA_COD_name" minOccurs="0"/>
  </xsd:sequence>
</xsd:complexType>

```

13.5.236.21.2 Enclosed Traffic Area Name

```

<xsd:simpleType name="Attr_EA_COD_name">
  <xsd:restriction base="xsd:string">
    <xsd:enumeration value="Parking Place"/>
    <xsd:enumeration value="Parking building"/>
    <xsd:enumeration value="Another Type of Enclosed Traffic Area"/>
    <xsd:enumeration value="Unstructured Traffic Square"/>
    <xsd:enumeration value="Pedestrian Square"/>
  </xsd:restriction>

```

```
</xsd:simpleType>
```

13.5.236.21.3 Enclosed Traffic Area Value

```
<xsd:simpleType name="Attr_EA_COD_value">  
  <xsd:restriction base="xsd:integer">  
    <xsd:enumeration value="1"/>  
    <xsd:enumeration value="2"/>  
    <xsd:enumeration value="3"/>  
    <xsd:enumeration value="4"/>  
    <xsd:enumeration value="5"/>  
  </xsd:restriction>  
</xsd:simpleType>
```

13.5.236.22 Entry Point Type

13.5.236.22.1 Entry Point Type Structure

```
<xsd:complexType name="Attr_ET_CODE">  
<!-- Entry Point Type -->  
  <xsd:sequence>  
    <xsd:element name="value" type="Attr_ET_COD_value"/>  
    <xsd:element name="name" type="Attr_ET_COD_name" minOccurs="0"/>  
  </xsd:sequence>  
</xsd:complexType>
```

13.5.236.22.2 Entry Point Type Name

```
<xsd:simpleType name="Attr_ET_COD_name">  
  <xsd:restriction base="xsd:string">  
    <xsd:enumeration value="Main"/>  
    <xsd:enumeration value="Minor"/>  
  </xsd:restriction>  
</xsd:simpleType>
```

13.5.236.22.3 Entry Point Type Value

```
<xsd:simpleType name="Attr_ET_COD_value">  
  <xsd:restriction base="xsd:integer">  
    <xsd:enumeration value="1"/>  
    <xsd:enumeration value="2"/>  
  </xsd:restriction>  
</xsd:simpleType>
```

13.5.236.23 Façade Component Placement

13.5.236.23.1 Façade Component Placement Structure

```
<xsd:complexType name="Attr_FQ_CODE">  
<!-- Façade Component Placement -->  
  <xsd:sequence>  
    <xsd:element name="value" type="Attr_FQ_COD_value"/>  
    <xsd:element name="name" type="Attr_FQ_COD_name" minOccurs="0"/>  
  </xsd:sequence>  
</xsd:complexType>
```

13.5.236.23.2 Façade Component Placement Name

```
<xsd:simpleType name="Attr_FQ_COD_name">  
  <xsd:restriction base="xsd:string">  
    <xsd:enumeration value="Aligned at the Bottom"/>  
    <xsd:enumeration value="Spanning Bottom to Center"/>  
    <xsd:enumeration value="Centered"/>  
    <xsd:enumeration value="Spanning Center to Top"/>  
    <xsd:enumeration value="Aligned at the Top"/>  
    <xsd:enumeration value="Spanning Bottom to Top"/>  
    <xsd:enumeration value="Spanning whole façade"/>  
  </xsd:restriction>  
</xsd:simpleType>
```

13.5.236.23.3 Façade Component Placement Value

```

<xsd:simpleType name="Attr_FQ_COD_value">
  <xsd:restriction base="xsd:integer">
    <xsd:enumeration value="1"/>
    <xsd:enumeration value="2"/>
    <xsd:enumeration value="3"/>
    <xsd:enumeration value="4"/>
    <xsd:enumeration value="5"/>
    <xsd:enumeration value="6"/>
    <xsd:enumeration value="7"/>
  </xsd:restriction>
</xsd:simpleType>

```

13.5.236.24 Façade Fabric Type

13.5.236.24.1 Façade Fabric Type Structure

```

<xsd:complexType name="Attr_FF_CODE">
  <!-- Façade Fabric type -->
  <xsd:sequence>
    <xsd:element name="value" type="Attr_FF_COD_value"/>
    <xsd:element name="name" type="Attr_FF_COD_name" minOccurs="0"/>
  </xsd:sequence>
</xsd:complexType>

```

13.5.236.24.2 Façade Fabric Type Name

```

<xsd:simpleType name="Attr_FF_COD_name">
  <xsd:restriction base="xsd:string">
    <xsd:enumeration value="Façade Fabric type 1"/>
    <xsd:enumeration value="Façade Fabric type 2"/>
    <xsd:enumeration value="Façade Fabric type 3"/>
<!-- a large break in the sequence occurs in the middle... -->
    <xsd:enumeration value="Façade Fabric type 999"/>
  </xsd:restriction>
</xsd:simpleType>

```

13.5.236.24.3 Façade Fabric Type Value

```

<xsd:simpleType name="Attr_FF_COD_value">
  <xsd:restriction base="xsd:integer">
    <xsd:enumeration value="1"/>
    <xsd:enumeration value="2"/>
    <xsd:enumeration value="3"/>
<!-- a large break in the sequence occurs in the middle... -->
    <xsd:enumeration value="999"/>
  </xsd:restriction>
</xsd:simpleType>

```

13.5.236.25 Ferry Type

13.5.236.25.1 Ferry Type Structure

```

<xsd:complexType name="Attr_FT_CODE">
<!-- Ferry Type -->
  <xsd:sequence>
    <xsd:element name="value" type="Attr_FT_COD_value"/>
    <xsd:element name="name" type="Attr_FT_COD_name" minOccurs="0"/>
  </xsd:sequence>
</xsd:complexType>

```

13.5.236.25.2 Ferry Type Name

```

<xsd:simpleType name="Attr_FT_COD_name">
  <xsd:restriction base="xsd:string">
    <xsd:enumeration value="Operated by ship or hovercraft"/>
    <xsd:enumeration value="Operated by train"/>
  </xsd:restriction>
</xsd:simpleType>

```

```
</xsd:restriction>  
</xsd:simpleType>
```

13.5.236.25.3 Ferry Type Value

```
<xsd:simpleType name="Attr_FT_COD_value">  
  <xsd:restriction base="xsd:integer">  
    <xsd:enumeration value="1"/>  
    <xsd:enumeration value="2"/>  
  </xsd:restriction>  
</xsd:simpleType>
```

13.5.236.26 Form of Way

13.5.236.26.1 Form of Way Structure

```
<xsd:complexType name="Attr_FW_CODE">  
<!-- Form of Way -->  
  <xsd:sequence>  
    <xsd:element name="value" type="Attr_FW_COD_value"/>  
    <xsd:element name="name" type="Attr_FW_COD_name" minOccurs="0"/>  
  </xsd:sequence>  
</xsd:complexType>
```

13.5.236.26.2 Form of Way Name

```
<xsd:simpleType name="Attr_FW_COD_name">  
  <xsd:restriction base="xsd:string">  
    <xsd:enumeration value="Part of a motorway"/>  
    <xsd:enumeration value="Part of a multiple carriageway which is not a Motorway"/>  
    <xsd:enumeration value="Part of a single carriageway"/>  
    <xsd:enumeration value="Part of a roundabout circle"/>  
    <xsd:enumeration value="Part of a traffic square"/>  
    <xsd:enumeration value="Part of an Enclosed Traffic Area"/>  
    <xsd:enumeration value="Part of a slip road"/>  
    <xsd:enumeration value="Part of a service road"/>  
    <xsd:enumeration value="Entrance/exit to/from a car park"/>  
    <xsd:enumeration value="Entrance/exit to/from a service"/>  
    <xsd:enumeration value="Part of a pedestrian zone"/>  
    <xsd:enumeration value="Part of Runaway Vehicle Ramp"/>  
  </xsd:restriction>  
</xsd:simpleType>
```

13.5.236.26.3 Form of Way Value

```
<xsd:simpleType name="Attr_FW_COD_value">  
  <xsd:restriction base="xsd:integer">  
    <xsd:enumeration value="1"/>  
    <xsd:enumeration value="2"/>  
    <xsd:enumeration value="3"/>  
    <xsd:enumeration value="4"/>  
    <xsd:enumeration value="5"/>  
    <xsd:enumeration value="9"/>  
    <xsd:enumeration value="10"/>  
    <xsd:enumeration value="11"/>  
    <xsd:enumeration value="12"/>  
    <xsd:enumeration value="13"/>  
    <xsd:enumeration value="14"/>  
    <xsd:enumeration value="16"/>  
  </xsd:restriction>  
</xsd:simpleType>
```

13.5.236.27 Functional Road Class

13.5.236.27.1 Functional Road Class Structure

```
<xsd:complexType name="Attr_FC_CODE">  
<!-- Functional Road Class -->  
  <xsd:sequence>  
    <xsd:element name="value" type="Attr_FC_COD_value"/>  
  </xsd:sequence>  
</xsd:complexType>
```

```

    <xsd:element name="name" type="Attr_FC_COD_name" minOccurs="0"/>
  </xsd:sequence>
</xsd:complexType>

```

13.5.236.27.2 Functional Road Class Name

```

<xsd:simpleType name="Attr_FC_COD_name">
  <xsd:restriction base="xsd:string">
    <xsd:enumeration value="Main road"/>
    <xsd:enumeration value="First class road"/>
    <xsd:enumeration value="Second class road"/>
    <xsd:enumeration value="Third class road"/>
    <xsd:enumeration value="Fourth class road"/>
    <xsd:enumeration value="Fifth class road"/>
    <xsd:enumeration value="Sixth class road"/>
    <xsd:enumeration value="Seventh class road"/>
    <xsd:enumeration value="Eighth class road"/>
    <xsd:enumeration value="Ninth class road"/>
  </xsd:restriction>
</xsd:simpleType>

```

13.5.236.27.3 Functional Road Class Value

```

<xsd:simpleType name="Attr_FC_COD_value">
  <xsd:restriction base="xsd:integer">
    <xsd:enumeration value="0"/>
    <xsd:enumeration value="1"/>
    <xsd:enumeration value="2"/>
    <xsd:enumeration value="3"/>
    <xsd:enumeration value="4"/>
    <xsd:enumeration value="5"/>
    <xsd:enumeration value="6"/>
    <xsd:enumeration value="7"/>
    <xsd:enumeration value="8"/>
    <xsd:enumeration value="9"/>
  </xsd:restriction>
</xsd:simpleType>

```

13.5.236.28 Give Way Type

13.5.236.28.1 Give Way Type Structure

```

<xsd:complexType name="Attr_GW_CODE">
<!-- Give Way Type -->
  <xsd:sequence>
    <xsd:element name="value" type="Attr_GW_COD_value"/>
    <xsd:element name="name" type="Attr_GW_COD_name" minOccurs="0"/>
  </xsd:sequence>
</xsd:complexType>

```

13.5.236.28.2 Give Way Type Name

```

<xsd:simpleType name="Attr_GW_COD_name">
  <xsd:restriction base="xsd:string">
    <xsd:enumeration value="Give Way (Yield)"/>
    <xsd:enumeration value="Stop"/>
    <xsd:enumeration value="All Way stop (example: 4-Way Stop)"/>
    <xsd:enumeration value="Caution Sign 'Unmarked Intersection Ahead'"/>
  </xsd:restriction>
</xsd:simpleType>

```

13.5.236.28.3 Give Way Type Value

```

<xsd:simpleType name="Attr_GW_COD_value">
  <xsd:restriction base="xsd:integer">
    <xsd:enumeration value="1"/>
    <xsd:enumeration value="2"/>
    <xsd:enumeration value="3"/>
    <xsd:enumeration value="4"/>
  </xsd:restriction>
</xsd:simpleType>

```

13.5.236.29 Government Type

13.5.236.29.1 Government Type Structure

```
<xsd:complexType name="Attr_GT_CODE">  
<!-- Government Type -->  
  <xsd:sequence>  
    <xsd:element name="value" type="Attr_GT_COD_value"/>  
    <xsd:element name="name" type="Attr_GT_COD_name" minOccurs="0"/>  
  </xsd:sequence>  
</xsd:complexType>
```

13.5.236.29.2 Government Type Name

```
<xsd:simpleType name="Attr_GT_COD_name">  
  <xsd:restriction base="xsd:string">  
    <xsd:enumeration value="National"/>  
    <xsd:enumeration value="Order-1"/>  
    <xsd:enumeration value="Order-2"/>  
    <xsd:enumeration value="Order-3"/>  
    <xsd:enumeration value="Order-4"/>  
    <xsd:enumeration value="Order-5"/>  
    <xsd:enumeration value="Order-6"/>  
    <xsd:enumeration value="Order-7"/>  
    <xsd:enumeration value="Municipality"/>  
  </xsd:restriction>  
</xsd:simpleType>
```

13.5.236.29.3 Government Type Value

```
<xsd:simpleType name="Attr_GT_COD_value">  
  <xsd:restriction base="xsd:integer">  
    <xsd:enumeration value="0"/>  
    <xsd:enumeration value="1"/>  
    <xsd:enumeration value="2"/>  
    <xsd:enumeration value="3"/>  
    <xsd:enumeration value="4"/>  
    <xsd:enumeration value="5"/>  
    <xsd:enumeration value="6"/>  
    <xsd:enumeration value="7"/>  
    <xsd:enumeration value="8"/>  
  </xsd:restriction>  
</xsd:simpleType>
```

13.5.236.30 House Number Structure

13.5.236.30.1 House Number Structure Structure

```
<xsd:complexType name="Attr_HS_CODE">  
<!-- House Number Structure -->  
  <xsd:sequence>  
    <xsd:element name="value" type="Attr_HS_COD_value"/>  
    <xsd:element name="name" type="Attr_HS_COD_name" minOccurs="0"/>  
  </xsd:sequence>  
</xsd:complexType>
```

13.5.236.30.2 House Number Structure Name

```
<xsd:simpleType name="Attr_HS_COD_name">  
  <xsd:restriction base="xsd:string">  
    <xsd:enumeration value="No House Numbers"/>  
    <xsd:enumeration value="Regular, odd numbers"/>  
    <xsd:enumeration value="Regular, even numbers"/>  
    <xsd:enumeration value="Regular, odd and even"/>  
    <xsd:enumeration value="Irregular"/>  
  </xsd:restriction>  
</xsd:simpleType>
```

13.5.236.30.3 House Number Structure Value

```

<xsd:simpleType name="Attr_HS_COD_value">
  <xsd:restriction base="xsd:integer">
    <xsd:enumeration value="1"/>
    <xsd:enumeration value="2"/>
    <xsd:enumeration value="3"/>
    <xsd:enumeration value="4"/>
    <xsd:enumeration value="5"/>
  </xsd:restriction>
</xsd:simpleType>

```

13.5.236.31 Importance

13.5.236.31.1 Importance Structure

```

<xsd:complexType name="Attr_IM_CODE">
<!-- Importance -->
  <xsd:sequence>
    <xsd:element name="value" type="Attr_IM_COD_value"/>
    <xsd:element name="name" type="Attr_IM_COD_name" minOccurs="0"/>
  </xsd:sequence>
</xsd:complexType>

```

13.5.236.31.2 Importance Name

```

<xsd:simpleType name="Attr_IM_COD_name">
  <xsd:restriction base="xsd:string">
    <xsd:enumeration value="National"/>
    <xsd:enumeration value="Local"/>
  </xsd:restriction>
</xsd:simpleType>

```

13.5.236.31.3 Importance Value

```

<xsd:simpleType name="Attr_IM_COD_value">
  <xsd:restriction base="xsd:integer">
    <xsd:enumeration value="1"/>
    <xsd:enumeration value="2"/>
  </xsd:restriction>
</xsd:simpleType>

```

13.5.236.32 Infrastructure Accessibility Aids

13.5.236.32.1 Infrastructure Accessibility Aids Structure

```

<xsd:complexType name="Attr_AA_CODE">
<!-- Infrastructure Accessibility Aids -->
  <xsd:sequence>
    <xsd:element name="value" type="Attr_AA_COD_value"/>
    <xsd:element name="name" type="Attr_AA_COD_name" minOccurs="0"/>
  </xsd:sequence>
</xsd:complexType>

```

13.5.236.32.2 Infrastructure Accessibility Aids Name

```

<xsd:simpleType name="Attr_AA_COD_name">
  <xsd:restriction base="xsd:string">
    <xsd:enumeration value="Textured surface available"/>
    <xsd:enumeration value="Audible signal available"/>
    <xsd:enumeration value="Visual signal available"/>
    <xsd:enumeration value="Care provider available"/>
<!-- a large break in the sequence occurs in the middle for User Defined entries -->
    <xsd:enumeration value="User Defined"/>
  </xsd:restriction>
</xsd:simpleType>

```

13.5.236.32.3 Infrastructure Accessibility Aids Value

```
<xsd:simpleType name="Attr_AA_COD_value">
  <xsd:restriction base="xsd:integer">
    <xsd:enumeration value="1"/>
    <xsd:enumeration value="2"/>
    <xsd:enumeration value="3"/>
    <xsd:enumeration value="4"/>
<!-- a large break in the sequence occurs in the middle for User Defined entries -->
    <xsd:enumeration value="999"/>
  </xsd:restriction>
</xsd:simpleType>
```

13.5.236.33 Interchange Type

13.5.236.33.1 Interchange Type Structure

```
<xsd:complexType name="Attr_IF_CODE">
<!-- Interchange Type -->
  <xsd:sequence>
    <xsd:element name="value" type="Attr_IF_COD_value"/>
    <xsd:element name="name" type="Attr_IF_COD_name" minOccurs="0"/>
  </xsd:sequence>
</xsd:complexType>
```

13.5.236.33.2 Interchange Type Name

```
<xsd:simpleType name="Attr_IF_COD_name">
  <xsd:restriction base="xsd:string">
    <xsd:enumeration value="Crossing between Freeways only"/>
    <xsd:enumeration value="Crossing between a Freeway and a Non-Freeway"/>
    <xsd:enumeration value="Crossing between Non-Freeways only"/>
  </xsd:restriction>
</xsd:simpleType>
```

13.5.236.33.3 Interchange Type Value

```
<xsd:simpleType name="Attr_IF_COD_value">
  <xsd:restriction base="xsd:integer">
    <xsd:enumeration value="1"/>
    <xsd:enumeration value="2"/>
    <xsd:enumeration value="3"/>
  </xsd:restriction>
</xsd:simpleType>
```

13.5.236.34 Junction Type

13.5.236.34.1 Junction Type Structure

```
<xsd:complexType name="Attr_JT_CODE">
<!-- Junction Type -->
  <xsd:sequence>
    <xsd:element name="value" type="Attr_JT_COD_value"/>
    <xsd:element name="name" type="Attr_JT_COD_name" minOccurs="0"/>
  </xsd:sequence>
</xsd:complexType>
```

13.5.236.34.2 Junction Type Name

```
<xsd:simpleType name="Attr_JT_COD_name">
  <xsd:restriction base="xsd:string">
    <xsd:enumeration value="Mini roundabout"/>
    <xsd:enumeration value="Railway Crossing"/>
    <xsd:enumeration value="Border Crossing"/>
    <xsd:enumeration value="Fixed Guideway Vehicle Crossing"/>
  </xsd:restriction>
</xsd:simpleType>
```

13.5.236.34.3 Junction Type Value

```

<xsd:simpleType name="Attr_JT_COD_value">
  <xsd:restriction base="xsd:integer">
    <xsd:enumeration value="1"/>
    <!-- Value 2 reserved for future use -->
    <xsd:enumeration value="3"/>
    <xsd:enumeration value="4"/>
    <xsd:enumeration value="5"/>
  </xsd:restriction>
</xsd:simpleType>

```

13.5.236.35 Lane Type

13.5.236.35.1 Lane Type Structure

```

<xsd:complexType name="Attr_EV_CODE">
<!-- Lane Type -->
  <xsd:sequence>
    <xsd:element name="value" type="Attr_EV_COD_value"/>
    <xsd:element name="name" type="Attr_EV_COD_name" minOccurs="0"/>
  </xsd:sequence>
</xsd:complexType>

```

13.5.236.35.2 Lane Type Name

```

<xsd:simpleType name="Attr_EV_COD_name">
  <xsd:restriction base="xsd:string">
    <xsd:enumeration value="Normal lane"/>
    <xsd:enumeration value="Emergency lane"/>
    <xsd:enumeration value="Exit/Entrance lane"/>
    <xsd:enumeration value="Shoulder lane"/>
    <xsd:enumeration value="Lay-by lane"/>
    <xsd:enumeration value="Overtaking lane"/>
  </xsd:restriction>
</xsd:simpleType>

```

13.5.236.35.3 Lane Type Value

```

<xsd:simpleType name="Attr_EV_COD_value">
  <xsd:restriction base="xsd:integer">
    <xsd:enumeration value="0"/>
    <xsd:enumeration value="1"/>
    <xsd:enumeration value="2"/>
    <xsd:enumeration value="3"/>
    <xsd:enumeration value="4"/>
    <xsd:enumeration value="5"/>
  </xsd:restriction>
</xsd:simpleType>

```

13.5.236.36 Linear Referencing Method

13.5.236.36.1 Linear Referencing Method Structure

```

<xsd:complexType name="Attr_LS_CODE">
<!-- Linear Referencing Method -->
  <xsd:sequence>
    <xsd:element name="value" type="Attr_LS_COD_value"/>
    <xsd:element name="name" type="Attr_LS_COD_name" minOccurs="0"/>
  </xsd:sequence>
</xsd:complexType>

```

13.5.236.36.2 Linear Referencing Method Name

```

<xsd:simpleType name="Attr_LS_COD_name">
  <xsd:restriction base="xsd:string">
    <xsd:enumeration value="Milepoint"/>
    <xsd:enumeration value="Kilopoint"/>
    <xsd:enumeration value="Milepost"/>
  </xsd:restriction>
</xsd:simpleType>

```

```
<xsd:enumeration value="Kilopost"/>
<xsd:enumeration value="Mile Reference Post"/>
<xsd:enumeration value="Kilometre Reference Post"/>
<xsd:enumeration value="Percentage"/>
<xsd:enumeration value="Normalized"/>
<xsd:enumeration value="Stationing"/>
<xsd:enumeration value="Metric Stationing"/>
<xsd:enumeration value="Reverse Milepoint"/>
<xsd:enumeration value="Reverse Kilopoint"/>
<xsd:enumeration value="Reverse Percentage"/>
</xsd:restriction>
</xsd:simpleType>
```

13.5.236.36.3 Linear Referencing Method Value

```
<xsd:simpleType name="Attr_LS_COD_value">
  <xsd:restriction base="xsd:integer">
    <xsd:enumeration value="1"/>
    <xsd:enumeration value="2"/>
    <xsd:enumeration value="3"/>
    <xsd:enumeration value="4"/>
    <xsd:enumeration value="5"/>
    <xsd:enumeration value="6"/>
    <xsd:enumeration value="7"/>
    <xsd:enumeration value="8"/>
    <xsd:enumeration value="9"/>
    <xsd:enumeration value="10"/>
    <xsd:enumeration value="-1"/>
    <xsd:enumeration value="-2"/>
    <xsd:enumeration value="-7"/>
  </xsd:restriction>
</xsd:simpleType>
```

13.5.236.37 Location Reference Type

13.5.236.37.1 Location Reference Type Structure

```
<xsd:complexType name="Attr_LT_CODE">
<!-- Location Reference Type -->
  <xsd:sequence>
    <xsd:element name="value" type="Attr_LT_COD_value"/>
    <xsd:element name="name" type="Attr_LT_COD_name" minOccurs="0"/>
  </xsd:sequence>
</xsd:complexType>
```

13.5.236.37.2 Location Reference Type Name

```
<xsd:simpleType name="Attr_LT_COD_name">
  <xsd:restriction base="xsd:string">
    <xsd:enumeration value="RDS/TMC"/>
    <xsd:enumeration value="VICS"/>
  </xsd:restriction>
</xsd:simpleType>
```

13.5.236.37.3 Location Reference Type Value

```
<xsd:simpleType name="Attr_LT_COD_value">
  <xsd:restriction base="xsd:integer">
    <xsd:enumeration value="1"/>
    <xsd:enumeration value="2"/>
  </xsd:restriction>
</xsd:simpleType>
```

13.5.236.38 Multi-Media Description

13.5.236.38.1 Multi-Media Description Structure

```
<xsd:complexType name="Attr_MD_CODE">
<!-- Multi-Media Description -->
  <xsd:sequence>
```



```

    <xsd:element name="value" type="Attr_MD_COD_value"/>
    <xsd:element name="name" type="Attr_MD_COD_name" minOccurs="0"/>
  </xsd:sequence>
</xsd:complexType>

```

13.5.236.38.2 Multi-Media Description Name

```

<xsd:simpleType name="Attr_MD_COD_name">
  <xsd:restriction base="xsd:string">
    <xsd:enumeration value="Unknown"/>
    <xsd:enumeration value="Building Roof Object"/>
    <xsd:enumeration value="Façade Component Object"/>
    <xsd:enumeration value="Façade Fabric Object"/>
    <xsd:enumeration value="3-D Landmark Object"/>
    <xsd:enumeration value="Elevation Point Grid Object"/>
    <!-- codes 6-50000 are reserved for future GDF defined values -->
    <xsd:enumeration value="User Defined 50001"/>
    <xsd:enumeration value="User Defined 50002"/>
    <xsd:enumeration value="User Defined 50003"/>
    <xsd:enumeration value="User Defined 50004"/>
    <xsd:enumeration value="User Defined 50005"/>
    <xsd:enumeration value="User Defined 50006"/>
    <xsd:enumeration value="User Defined 50007"/>
    <xsd:enumeration value="User Defined 50008"/>
    <xsd:enumeration value="User Defined 50009"/>
    <xsd:enumeration value="User Defined 50010"/>
    <!-- a large break in the sequence occurs for User Defineds (50001 - 99999 -->
    <xsd:enumeration value="User Defined 99990"/>
    <xsd:enumeration value="User Defined 99991"/>
    <xsd:enumeration value="User Defined 99992"/>
    <xsd:enumeration value="User Defined 99993"/>
    <xsd:enumeration value="User Defined 99994"/>
    <xsd:enumeration value="User Defined 99995"/>
    <xsd:enumeration value="User Defined 99996"/>
    <xsd:enumeration value="User Defined 99997"/>
    <xsd:enumeration value="User Defined 99998"/>
    <xsd:enumeration value="User Defined 99999"/>
  </xsd:restriction>
</xsd:simpleType>

```

13.5.236.38.3 Multi-Media Description Value

```

<xsd:simpleType name="Attr_MD_COD_value">
  <xsd:restriction base="xsd:integer">
    <xsd:enumeration value="0"/>
    <xsd:enumeration value="1"/>
    <xsd:enumeration value="2"/>
    <xsd:enumeration value="3"/>
    <xsd:enumeration value="4"/>
    <xsd:enumeration value="5"/>
    <xsd:enumeration value="50001"/>
    <xsd:enumeration value="50002"/>
    <xsd:enumeration value="50003"/>
    <xsd:enumeration value="50004"/>
    <xsd:enumeration value="50005"/>
    <xsd:enumeration value="50006"/>
    <xsd:enumeration value="50007"/>
    <xsd:enumeration value="50008"/>
    <xsd:enumeration value="50009"/>
    <xsd:enumeration value="50010"/>
    <!-- a large break in the sequence occurs in the middle... -->
    <xsd:enumeration value="99990"/>
    <xsd:enumeration value="99991"/>
    <xsd:enumeration value="99992"/>
    <xsd:enumeration value="99993"/>
    <xsd:enumeration value="99994"/>
    <xsd:enumeration value="99995"/>
    <xsd:enumeration value="99996"/>
    <xsd:enumeration value="99997"/>
    <xsd:enumeration value="99998"/>
    <xsd:enumeration value="99999"/>
  </xsd:restriction>
</xsd:simpleType>

```

13.5.236.39 Name Component Type

13.5.236.39.1 Name Component Type Structure

```
<xsd:complexType name="Attr_NT_CODE">  
<!-- Name Component Type -->  
  <xsd:sequence>  
    <xsd:element name="value" type="Attr_NT_COD_value"/>  
    <xsd:element name="name" type="Attr_NT_COD_name" minOccurs="0"/>  
  </xsd:sequence>  
</xsd:complexType>
```

13.5.236.39.2 Name Component Type Name

```
<xsd:simpleType name="Attr_NT_COD_name">  
  <xsd:restriction base="xsd:string">  
    <xsd:enumeration value="Name Component Type 1"/>  
    <xsd:enumeration value="Name Component Type 2"/>  
    <xsd:enumeration value="Name Component Type 3"/>  
    <xsd:enumeration value="Name Component Type 4"/>  
    <xsd:enumeration value="Name Component Type 5"/>  
    <xsd:enumeration value="Name Component Type 6"/>  
    <xsd:enumeration value="Name Component Type 7"/>  
    <xsd:enumeration value="Name Component Type 8"/>  
    <xsd:enumeration value="Name Component Type 9"/>  
    <xsd:enumeration value="Name Component Type 10"/>  
    <xsd:enumeration value="Name Component Type 11"/>  
    <xsd:enumeration value="Name Component Type 12"/>  
    <xsd:enumeration value="Name Component Type 13"/>  
    <xsd:enumeration value="Name Component Type 14"/>  
    <xsd:enumeration value="Name Component Type 15"/>  
    <xsd:enumeration value="Name Component Type 16"/>  
    <xsd:enumeration value="Name Component Type 17"/>  
    <xsd:enumeration value="Name Component Type 18"/>  
    <xsd:enumeration value="Name Component Type 19"/>  
    <xsd:enumeration value="Name Component Type 20"/>  
<!-- a large break in the sequence occurs at the end -->  
  </xsd:restriction>  
</xsd:simpleType>
```

13.5.236.39.3 Name Component Type Value

```
<xsd:simpleType name="Attr_NT_COD_value">  
  <xsd:restriction base="xsd:integer">  
    <xsd:enumeration value="1"/>  
    <xsd:enumeration value="2"/>  
    <xsd:enumeration value="3"/>  
    <xsd:enumeration value="4"/>  
    <xsd:enumeration value="5"/>  
    <xsd:enumeration value="6"/>  
    <xsd:enumeration value="7"/>  
    <xsd:enumeration value="8"/>  
    <xsd:enumeration value="9"/>  
    <xsd:enumeration value="10"/>  
    <xsd:enumeration value="11"/>  
    <xsd:enumeration value="12"/>  
    <xsd:enumeration value="13"/>  
    <xsd:enumeration value="14"/>  
    <xsd:enumeration value="15"/>  
    <xsd:enumeration value="16"/>  
    <xsd:enumeration value="17"/>  
    <xsd:enumeration value="18"/>  
    <xsd:enumeration value="19"/>  
    <xsd:enumeration value="20"/>  
<!-- a large break in the sequence occurs at the end... -->  
  </xsd:restriction>  
</xsd:simpleType>
```

13.5.236.40 National Road Class

13.5.236.40.1 National Road Class Structure

```

<xsd:complexType name="Attr_NR_CODE">
<!-- National Road Class -->
  <xsd:sequence>
    <xsd:element name="value" type="Attr_NR_COD_value"/>
    <xsd:element name="name" type="Attr_NR_COD_name" minOccurs="0"/>
  </xsd:sequence>
</xsd:complexType>

```

13.5.236.40.2 National Road Class Name

```

<xsd:simpleType name="Attr_NR_COD_name">
  <xsd:restriction base="xsd:string">
    <xsd:enumeration value="Main road"/>
    <xsd:enumeration value="First class road"/>
    <xsd:enumeration value="Second class road"/>
    <xsd:enumeration value="Third class road"/>
    <xsd:enumeration value="Fourth class road"/>
    <xsd:enumeration value="Fifth class road"/>
    <xsd:enumeration value="Sixth class road"/>
    <xsd:enumeration value="Seventh class road"/>
    <xsd:enumeration value="Eighth class road"/>
    <xsd:enumeration value="Ninth class road"/>
  </xsd:restriction>
</xsd:simpleType>

```

13.5.236.40.3 National Road Class Value

```

<xsd:simpleType name="Attr_NR_COD_value">
  <xsd:restriction base="xsd:integer">
    <xsd:enumeration value="0"/>
    <xsd:enumeration value="1"/>
    <xsd:enumeration value="2"/>
    <xsd:enumeration value="3"/>
    <xsd:enumeration value="4"/>
    <xsd:enumeration value="5"/>
    <xsd:enumeration value="6"/>
    <xsd:enumeration value="7"/>
    <xsd:enumeration value="8"/>
    <xsd:enumeration value="9"/>
  </xsd:restriction>
</xsd:simpleType>

```

13.5.236.41 Not Crossable by Pedestrians

13.5.236.41.1 Not Crossable by Pedestrians Structure

```

<xsd:complexType name="Attr_PX_CODE">
<!-- Not Crossable by Pedestrians -->
  <xsd:sequence>
    <xsd:element name="value" type="Attr_PX_COD_value"/>
    <xsd:element name="name" type="Attr_PX_COD_name" minOccurs="0"/>
  </xsd:sequence>
</xsd:complexType>

```

13.5.236.41.2 Not Crossable by Pedestrians Name

```

<xsd:simpleType name="Attr_PX_COD_name">
  <xsd:restriction base="xsd:string">
    <xsd:enumeration value="No crossing advised (prohibited)"/>
    <xsd:enumeration value="No crossing advised (dangerous)"/>
    <xsd:enumeration value="No crossing not advised"/>
  </xsd:restriction>
</xsd:simpleType>

```

13.5.236.41.3 Not Crossable by Pedestrians Value

```
<xsd:simpleType name="Attr_PX_COD_value">  
  <xsd:restriction base="xsd:integer">  
    <xsd:enumeration value="1" />  
    <xsd:enumeration value="2" />  
    <xsd:enumeration value="3" />  
  </xsd:restriction>  
</xsd:simpleType>
```

13.5.236.42 Notation Anomaly

13.5.236.42.1 Notation Anomaly Structure

```
<xsd:complexType name="Attr_NA_CODE">  
<!-- Notation Anomaly -->  
  <xsd:sequence>  
    <xsd:element name="value" type="Attr_NA_COD_value" />  
    <xsd:element name="name" type="Attr_NA_COD_name" minOccurs="0" />  
  </xsd:sequence>  
</xsd:complexType>
```

13.5.236.42.2 Notation Anomaly Name

```
<xsd:simpleType name="Attr_NA_COD_name">  
  <xsd:restriction base="xsd:string">  
    <xsd:enumeration value="Usual form" />  
    <xsd:enumeration value="Non-literal form" />  
    <xsd:enumeration value="Synonym" />  
  </xsd:restriction>  
</xsd:simpleType>
```

13.5.236.42.3 Notation Anomaly Value

```
<xsd:simpleType name="Attr_NA_COD_value">  
  <xsd:restriction base="xsd:integer">  
    <xsd:enumeration value="1" />  
    <xsd:enumeration value="2" />  
    <xsd:enumeration value="3" />  
  </xsd:restriction>  
</xsd:simpleType>
```

13.5.236.43 Notation Variant

13.5.236.43.1 Notation Variant Structure

```
<xsd:complexType name="Attr_NV_CODE">  
<!-- Notation Variation -->  
  <xsd:sequence>  
    <xsd:element name="value" type="Attr_NV_COD_value" />  
    <xsd:element name="name" type="Attr_NV_COD_name" minOccurs="0" />  
  </xsd:sequence>  
</xsd:complexType>
```

13.5.236.43.2 Notation Variant Name

```
<xsd:simpleType name="Attr_NV_COD_name">  
  <xsd:restriction base="xsd:string">  
    <xsd:enumeration value="Given form" />  
    <xsd:enumeration value="Long form" />  
    <xsd:enumeration value="Short form" />  
    <xsd:enumeration value="Alternate spelling" />  
  </xsd:restriction>  
</xsd:simpleType>
```

13.5.236.43.3 Notation Variant Value

```
<xsd:simpleType name="Attr_NV_COD_value">  
  <xsd:restriction base="xsd:integer">
```

```

        <xsd:enumeration value="1"/>
        <xsd:enumeration value="2"/>
        <xsd:enumeration value="3"/>
        <xsd:enumeration value="4"/>
    </xsd:restriction>
</xsd:simpleType>

```

13.5.236.44 Notation Version

13.5.236.44.1 Notation Version Structure

```

<xsd:complexType name="Attr_NW_CODE">
<!-- Notation Version -->
    <xsd:sequence>
        <xsd:element name="value" type="Attr_NW_COD_value"/>
        <xsd:element name="name" type="Attr_NW_COD_name" minOccurs="0"/>
    </xsd:sequence>
</xsd:complexType>

```

13.5.236.44.2 Notation Version Name

```

<xsd:simpleType name="Attr_NW_COD_name">
    <xsd:restriction base="xsd:string">
        <xsd:enumeration value="Original"/>
        <xsd:enumeration value="Exonym"/>
    </xsd:restriction>
</xsd:simpleType>

```

13.5.236.44.3 Notation Version Value

```

<xsd:simpleType name="Attr_NW_COD_value">
    <xsd:restriction base="xsd:integer">
        <xsd:enumeration value="1"/>
        <xsd:enumeration value="2"/>
    </xsd:restriction>
</xsd:simpleType>

```

13.5.236.45 One Way

13.5.236.45.1 One Way Structure

```

<xsd:complexType name="Attr_OY_ENUM">
<!-- One Way -->
    <xsd:sequence>
        <xsd:element name="value" type="Attr_OY_ENM_value"/>
        <xsd:element name="name" type="Attr_OY_ENM_name" minOccurs="0"/>
    </xsd:sequence>
</xsd:complexType>

```

13.5.236.45.2 One-way Name

```

<xsd:simpleType name="Attr_OY_ENM_name">
    <xsd:restriction base="xsd:string">
        <xsd:enumeration value="In positive direction"/>
        <xsd:enumeration value="In negative direction"/>
    </xsd:restriction>
</xsd:simpleType>

```

13.5.236.45.3 One-way Value

```

<xsd:simpleType name="Attr_OY_ENM_value">
    <xsd:restriction base="xsd:integer">
        <xsd:enumeration value="0"/>
        <xsd:enumeration value="1"/>
    </xsd:restriction>
</xsd:simpleType>

```

13.5.236.46 Ownership

13.5.236.46.1 Ownership Structure

```
<xsd:complexType name="Attr_OW_CODE">  
<!-- Ownership -->  
  <xsd:sequence>  
    <xsd:element name="value" type="Attr_OW_COD_value" />  
    <xsd:element name="name" type="Attr_OW_COD_name" minOccurs="0" />  
  </xsd:sequence>  
</xsd:complexType>
```

13.5.236.46.2 Ownership Name

```
<xsd:simpleType name="Attr_OW_COD_name">  
  <xsd:restriction base="xsd:string">  
    <xsd:enumeration value="Publicly owned" />  
    <xsd:enumeration value="Privately owned" />  
  </xsd:restriction>  
</xsd:simpleType>
```

13.5.236.46.3 Ownership Value

```
<xsd:simpleType name="Attr_OW_COD_value">  
  <xsd:restriction base="xsd:integer">  
    <xsd:enumeration value="1" />  
    <xsd:enumeration value="2" />  
  </xsd:restriction>  
</xsd:simpleType>
```

13.5.236.47 Park Type

13.5.236.47.1 Park Type Structure

```
<xsd:complexType name="Attr_PT_CODE">  
<!-- Park Type -->  
  <xsd:sequence>  
    <xsd:element name="value" type="Attr_PT_COD_value" />  
    <xsd:element name="name" type="Attr_PT_COD_name" minOccurs="0" />  
  </xsd:sequence>  
</xsd:complexType>
```

13.5.236.47.2 Park Type Name

```
<xsd:simpleType name="Attr_PT_COD_name">  
  <xsd:restriction base="xsd:string">  
    <xsd:enumeration value="City Park" />  
    <xsd:enumeration value="Regional Park" />  
    <xsd:enumeration value="County Park" />  
    <xsd:enumeration value="State/Provincial Park" />  
    <xsd:enumeration value="National Park" />  
  </xsd:restriction>  
</xsd:simpleType>
```

13.5.236.47.3 Park Type Value

```
<xsd:simpleType name="Attr_PT_COD_value">  
  <xsd:restriction base="xsd:integer">  
    <xsd:enumeration value="1" />  
    <xsd:enumeration value="2" />  
    <xsd:enumeration value="3" />  
    <xsd:enumeration value="4" />  
    <xsd:enumeration value="5" />  
  </xsd:restriction>  
</xsd:simpleType>
```

13.5.236.48 Pathway Safety Indicator

13.5.236.48.1 Pathway Safety Indicator Structure

```

<xsd:complexType name="Attr_PJ_CODE">
<!-- Pathway Safety Indicator -->
  <xsd:sequence>
    <xsd:element name="value" type="Attr_PJ_COD_value"/>
    <xsd:element name="name" type="Attr_PJ_COD_name" minOccurs="0"/>
  </xsd:sequence>
</xsd:complexType>

```

13.5.236.48.2 Pathway Safety Indicator Name

```

<xsd:simpleType name="Attr_PJ_COD_name">
  <xsd:restriction base="xsd:string">
    <xsd:enumeration value="Uncritical"/>
    <xsd:enumeration value="To be avoided"/>
    <xsd:enumeration value="Barred"/>
  </xsd:restriction>
</xsd:simpleType>

```

13.5.236.48.3 Pathway Safety Indicator Value

```

<xsd:simpleType name="Attr_PJ_COD_value">
  <xsd:restriction base="xsd:integer">
    <xsd:enumeration value="1"/>
    <xsd:enumeration value="2"/>
    <xsd:enumeration value="3"/>
  </xsd:restriction>
</xsd:simpleType>

```

13.5.236.49 Pathway Type

13.5.236.49.1 Pathway Type Structure

```

<xsd:complexType name="Attr_PH_CODE">
<!-- Pathway Type -->
  <xsd:sequence>
    <xsd:element name="value" type="Attr_PH_COD_value"/>
    <xsd:element name="name" type="Attr_PH_COD_name" minOccurs="0"/>
  </xsd:sequence>
</xsd:complexType>

```

13.5.236.49.2 Pathway Type Name

```

<xsd:simpleType name="Attr_PH_COD_name">
  <xsd:restriction base="xsd:string">
    <xsd:enumeration value="Surface Passageway"/>
    <xsd:enumeration value="Stairs"/>
    <xsd:enumeration value="Escalator"/>
    <xsd:enumeration value="Elevator"/>
    <xsd:enumeration value="Gallery"/>
    <xsd:enumeration value="Underpass"/>
    <xsd:enumeration value="Overpass"/>
    <xsd:enumeration value="Platform"/>
  </xsd:restriction>
</xsd:simpleType>

```

13.5.236.49.3 Pathway Type Value

```

<xsd:simpleType name="Attr_PH_COD_value">
  <xsd:restriction base="xsd:integer">
    <xsd:enumeration value="1"/>
    <xsd:enumeration value="2"/>
    <xsd:enumeration value="3"/>
    <xsd:enumeration value="4"/>
    <xsd:enumeration value="5"/>
    <xsd:enumeration value="6"/>
  </xsd:restriction>
</xsd:simpleType>

```

```
        <xsd:enumeration value="7" />
        <xsd:enumeration value="8" />
    </xsd:restriction>
</xsd:simpleType>
```

13.5.236.50 Pavement Road Surface Type

13.5.236.50.1 Pavement Road Surface Type Structure

```
<xsd:complexType name="Attr_OA_CODE">
<!-- Pavement Road Surface Type -->
    <xsd:sequence>
        <xsd:element name="value" type="Attr_OA_COD_value" />
        <xsd:element name="name" type="Attr_OA_COD_name" minOccurs="0" />
    </xsd:sequence>
</xsd:complexType>
```

13.5.236.50.2 Paved Road Surface Type Name

```
<xsd:simpleType name="Attr_OA_COD_name">
    <xsd:restriction base="xsd:string">
        <xsd:enumeration value="Rigid" />
        <xsd:enumeration value="Flexible" />
        <xsd:enumeration value="Blocks" />
    </xsd:restriction>
</xsd:simpleType>
```

13.5.236.50.3 Paved Road Surface Type Value

```
<xsd:simpleType name="Attr_OA_COD_value">
    <xsd:restriction base="xsd:integer">
        <xsd:enumeration value="11" />
        <xsd:enumeration value="12" />
        <xsd:enumeration value="13" />
    </xsd:restriction>
</xsd:simpleType>
```

13.5.236.51 Pavement Status

13.5.236.51.1 Pavement Status Structure

```
<xsd:complexType name="Attr_PV_CODE">
<!-- Pavement Status -->
    <xsd:sequence>
        <xsd:element name="value" type="Attr_PV_COD_value" />
        <xsd:element name="name" type="Attr_PV_COD_name" minOccurs="0" />
    </xsd:sequence>
</xsd:complexType>
```

13.5.236.51.2 Pavement Status Name

```
<xsd:simpleType name="Attr_PV_COD_name">
    <xsd:restriction base="xsd:string">
        <xsd:enumeration value="Paved" />
        <xsd:enumeration value="Unpaved" />
    </xsd:restriction>
</xsd:simpleType>
```

13.5.236.51.3 Pavement Status Value

```
<xsd:simpleType name="Attr_PV_COD_value">
    <xsd:restriction base="xsd:integer">
        <xsd:enumeration value="1" />
        <xsd:enumeration value="2" />
    </xsd:restriction>
</xsd:simpleType>
```

13.5.236.52 Pedestrian Crossing Level

13.5.236.52.1 Pedestrian Crossing Level Structure

```

<xsd:complexType name="Attr_XD_CODE">
<!-- Pedestrian Crossing Level -->
  <xsd:sequence>
    <xsd:element name="value" type="Attr_XD_COD_value"/>
    <xsd:element name="name" type="Attr_XD_COD_name" minOccurs="0"/>
  </xsd:sequence>
</xsd:complexType>

```

13.5.236.52.2 Pedestrian Crossing Level Name

```

<xsd:simpleType name="Attr_XD_COD_name">
  <xsd:restriction base="xsd:string">
    <xsd:enumeration value="Street level crossing"/>
    <xsd:enumeration value="Overpass"/>
    <xsd:enumeration value="Underpass"/>
  </xsd:restriction>
</xsd:simpleType>

```

13.5.236.52.3 Pedestrian Crossing Level Value

```

<xsd:simpleType name="Attr_XD_COD_value">
  <xsd:restriction base="xsd:integer">
    <xsd:enumeration value="1"/>
    <xsd:enumeration value="2"/>
    <xsd:enumeration value="3"/>
  </xsd:restriction>
</xsd:simpleType>

```

13.5.236.53 Pedestrian Crossing Priority

13.5.236.53.1 Pedestrian Crossing Priority Structure

```

<xsd:complexType name="Attr_XC_CODE">
<!-- Pedestrian Crossing Priority -->
  <xsd:sequence>
    <xsd:element name="value" type="Attr_XC_COD_value"/>
    <xsd:element name="name" type="Attr_XC_COD_name" minOccurs="0"/>
  </xsd:sequence>
</xsd:complexType>

```

13.5.236.53.2 Pedestrian Crossing Priority Name

```

<xsd:simpleType name="Attr_XC_COD_name">
  <xsd:restriction base="xsd:string">
    <xsd:enumeration value="Pedestrians over road traffic"/>
    <xsd:enumeration value="Pedestrians over road traffic on request"/>
    <xsd:enumeration value="Road traffic over pedestrians"/>
  </xsd:restriction>
</xsd:simpleType>

```

13.5.236.53.3 Pedestrian Crossing Priority Value

```

<xsd:simpleType name="Attr_XC_COD_value">
  <xsd:restriction base="xsd:integer">
    <xsd:enumeration value="1"/>
    <xsd:enumeration value="2"/>
    <xsd:enumeration value="3"/>
  </xsd:restriction>
</xsd:simpleType>

```

13.5.236.54 Pedestrian Crossing Signage

13.5.236.54.1 Pedestrian Crossing Signage Structure

```
<xsd:complexType name="Attr_XB_CODE">
<!-- Pedestrian Crossing Signage -->
  <xsd:sequence>
    <xsd:element name="value" type="Attr_XB_COD_value"/>
    <xsd:element name="name" type="Attr_XB_COD_name" minOccurs="0"/>
  </xsd:sequence>
</xsd:complexType>
```

13.5.236.54.2 Pedestrian Crossing Signage Name

```
<xsd:simpleType name="Attr_XB_COD_name">
  <xsd:restriction base="xsd:string">
    <xsd:enumeration value="No traffic signs"/>
    <xsd:enumeration value="(Passive) Traffic signs"/>
    <xsd:enumeration value="Traffic signs with warning lights"/>
    <xsd:enumeration value="Traffic light regulated"/>
  </xsd:restriction>
</xsd:simpleType>
```

13.5.236.54.3 Pedestrian Crossing Signage Value

```
<xsd:simpleType name="Attr_XB_COD_value">
  <xsd:restriction base="xsd:integer">
    <xsd:enumeration value="0"/>
    <xsd:enumeration value="1"/>
    <xsd:enumeration value="2"/>
    <xsd:enumeration value="3"/>
  </xsd:restriction>
</xsd:simpleType>
```

13.5.236.55 Pedestrian Crossing Type

13.5.236.55.1 Pedestrian Crossing Type Structure

```
<xsd:complexType name="Attr_XA_CODE">
<!-- Pedestrian Crossing Type -->
  <xsd:sequence>
    <xsd:element name="value" type="Attr_XA_COD_value"/>
    <xsd:element name="name" type="Attr_XA_COD_name" minOccurs="0"/>
  </xsd:sequence>
</xsd:complexType>
```

13.5.236.55.2 Pedestrian Crossing Type Name

```
<xsd:simpleType name="Attr_XA_COD_name">
  <xsd:restriction base="xsd:string">
    <xsd:enumeration value="No road markings"/>
    <xsd:enumeration value="Refuge island in the middle of road, no markings"/>
    <xsd:enumeration value="Zebra crossing, with or without additional constructive aids"/>
    <xsd:enumeration value="Other type"/>
  </xsd:restriction>
</xsd:simpleType>
```

13.5.236.55.3 Pedestrian Crossing Type Value

```
<xsd:simpleType name="Attr_XA_COD_value">
  <xsd:restriction base="xsd:integer">
    <xsd:enumeration value="0"/>
    <xsd:enumeration value="1"/>
    <xsd:enumeration value="2"/>
    <xsd:enumeration value="3"/>
  </xsd:restriction>
</xsd:simpleType>
```

13.5.236.56 Pedestrian Type

13.5.236.56.1 Pedestrian Type Structure

```

<xsd:complexType name="Attr_HT_CODE">
<!-- Pedestrian Type -->
  <xsd:sequence>
    <xsd:element name="value" type="Attr_HT_COD_value"/>
    <xsd:element name="name" type="Attr_HT_COD_name" minOccurs="0"/>
  </xsd:sequence>
</xsd:complexType>

```

13.5.236.56.2 Pedestrian Type Name

```

<xsd:simpleType name="Attr_HT_COD_name">
  <xsd:restriction base="xsd:string">
    <xsd:enumeration value="All pedestrian type "/>
    <xsd:enumeration value="Pedestrian with Stroller"/>
    <xsd:enumeration value="Pedestrian with Luggage cart "/>
    <xsd:enumeration value="Visually challenged pedestrian"/>
    <xsd:enumeration value="Aurally challenged pedestrian"/>
    <xsd:enumeration value="Mobility challenged Pedestrian (like Wheelchair)"/>
    <xsd:enumeration value="Mobility challenged Pedestrian with Care provider"/>
    <xsd:enumeration value="User defined 51"/>
    <xsd:enumeration value="User defined 52"/>
    <xsd:enumeration value="User defined 53"/>
    <xsd:enumeration value="User defined 54"/>
    <xsd:enumeration value="User defined 55"/>
    <xsd:enumeration value="User defined 56"/>
    <xsd:enumeration value="User defined 57"/>
    <xsd:enumeration value="User defined 58"/>
    <xsd:enumeration value="User defined 59"/>
    <xsd:enumeration value="User defined 60"/>
<!-- a large break in the sequence occurs in the middle... -->
    <xsd:enumeration value="User defined 90"/>
    <xsd:enumeration value="User defined 91"/>
    <xsd:enumeration value="User defined 92"/>
    <xsd:enumeration value="User defined 93"/>
    <xsd:enumeration value="User defined 94"/>
    <xsd:enumeration value="User defined 95"/>
    <xsd:enumeration value="User defined 96"/>
    <xsd:enumeration value="User defined 97"/>
    <xsd:enumeration value="User defined 98"/>
    <xsd:enumeration value="User defined 99"/>
  </xsd:restriction>
</xsd:simpleType>

```

13.5.236.56.3 Pedestrian Type Value

```

<xsd:simpleType name="Attr_HT_COD_value">
  <xsd:restriction base="xsd:integer">
    <xsd:enumeration value="0"/>
    <xsd:enumeration value="1"/>
    <xsd:enumeration value="2"/>
    <xsd:enumeration value="3"/>
    <xsd:enumeration value="4"/>
    <xsd:enumeration value="5"/>
    <xsd:enumeration value="6"/>
    <xsd:enumeration value="51"/>
    <xsd:enumeration value="52"/>
    <xsd:enumeration value="53"/>
    <xsd:enumeration value="54"/>
    <xsd:enumeration value="55"/>
    <xsd:enumeration value="56"/>
    <xsd:enumeration value="57"/>
    <xsd:enumeration value="58"/>
    <xsd:enumeration value="59"/>
    <xsd:enumeration value="60"/>
<!-- a break in the sequence occurs in the middle... -->
    <xsd:enumeration value="90"/>
    <xsd:enumeration value="91"/>
    <xsd:enumeration value="92"/>
    <xsd:enumeration value="93"/>
  </xsd:restriction>
</xsd:simpleType>

```

```
<xsd:enumeration value="94"/>
<xsd:enumeration value="95"/>
<xsd:enumeration value="96"/>
<xsd:enumeration value="97"/>
<xsd:enumeration value="98"/>
<xsd:enumeration value="99"/>
</xsd:restriction>
</xsd:simpleType>
```

13.5.236.57 Phonetic Alphabet

13.5.236.57.1 Phonetic Alphabet Structure

```
<xsd:complexType name="Attr_LA_CODE">
<!-- Phonetic Alphabet -->
  <xsd:sequence>
    <xsd:element name="value" type="Attr_LA_COD_value"/>
    <xsd:element name="name" type="Attr_LA_COD_name" minOccurs="0"/>
  </xsd:sequence>
</xsd:complexType>
```

13.5.236.57.2 Phonetic Alphabet Name

```
<xsd:simpleType name="Attr_LA_COD_name">
  <xsd:restriction base="xsd:string">
    <xsd:enumeration value="IPA"/>
    <xsd:enumeration value="SAMPA"/>
    <xsd:enumeration value="SAMPA-SAMPROSA"/>
    <xsd:enumeration value="X-SAMPA"/>
  </xsd:restriction>
</xsd:simpleType>
```

13.5.236.57.3 Phonetic Alphabet Value

```
<xsd:simpleType name="Attr_LA_COD_value">
  <xsd:restriction base="xsd:integer">
    <xsd:enumeration value="1"/>
    <xsd:enumeration value="2"/>
    <xsd:enumeration value="3"/>
    <xsd:enumeration value="4"/>
  </xsd:restriction>
</xsd:simpleType>
```

13.5.236.58 Place within Place Classification

13.5.236.58.1 Place within Place Classification Structure

```
<xsd:complexType name="Attr_PL_CODE">
<!-- Place within Place Classification -->
  <xsd:sequence>
    <xsd:element name="value" type="Attr_PL_COD_value"/>
    <xsd:element name="name" type="Attr_PL_COD_name" minOccurs="0"/>
  </xsd:sequence>
</xsd:complexType>
```

13.5.236.58.2 Place within Place Classification Name

```
<xsd:simpleType name="Attr_PL_COD_name">
  <xsd:restriction base="xsd:string">
    <xsd:enumeration value="Administrative"/>
    <xsd:enumeration value="Postal"/>
    <xsd:enumeration value="Address-significant"/>
    <xsd:enumeration value="Useful for reverse-geocoding"/>
  </xsd:restriction>
</xsd:simpleType>
```

13.5.236.58.3 Place within Place Classification Value

```
<xsd:simpleType name="Attr_PL_COD_value">
```

```

    <xsd:restriction base="xsd:integer">
      <xsd:enumeration value="1"/>
      <xsd:enumeration value="2"/>
      <xsd:enumeration value="3"/>
      <xsd:enumeration value="4"/>
    </xsd:restriction>
  </xsd:simpleType>

```

13.5.236.59 Population Class

13.5.236.59.1 Population Class Structure

```

<xsd:complexType name="Attr_PC_CODE">
  <!-- Population Class -->
  <xsd:sequence>
    <xsd:element name="value" type="Attr_PC_COD_value"/>
    <xsd:element name="name" type="Attr_PC_COD_name" minOccurs="0"/>
  </xsd:sequence>
</xsd:complexType>

```

13.5.236.59.2 Population Class Name

```

<xsd:simpleType name="Attr_PC_COD_name">
  <xsd:restriction base="xsd:string">
    <xsd:enumeration value="Population Class 1"/>
    <xsd:enumeration value="Population Class 2"/>
    <xsd:enumeration value="Population Class 3"/>
    <xsd:enumeration value="Population Class 4"/>
    <xsd:enumeration value="Population Class 5"/>
    <xsd:enumeration value="Population Class 6"/>
    <xsd:enumeration value="Population Class 7"/>
    <xsd:enumeration value="Population Class 8"/>
    <xsd:enumeration value="Population Class 9"/>
    <xsd:enumeration value="Population Class 10"/>
    <xsd:enumeration value="Population Class 11"/>
    <xsd:enumeration value="Population Class 12"/>
    <xsd:enumeration value="Population Class 13"/>
    <xsd:enumeration value="Population Class 14"/>
    <xsd:enumeration value="Population Class 15"/>
    <xsd:enumeration value="Population Class 16"/>
    <xsd:enumeration value="Population Class 17"/>
    <xsd:enumeration value="Population Class 18"/>
    <xsd:enumeration value="Population Class 19"/>
    <xsd:enumeration value="Population Class 20"/>
  </xsd:restriction>
<!-- User-Defined Classes can be any number. -->
<!-- Restricted here to 20 for illustration. -->
</xsd:simpleType>

```

13.5.236.59.3 Population Class Value

```

<xsd:simpleType name="Attr_PC_COD_value">
  <xsd:restriction base="xsd:integer">
    <xsd:enumeration value="1"/>
    <xsd:enumeration value="2"/>
    <xsd:enumeration value="3"/>
    <xsd:enumeration value="4"/>
    <xsd:enumeration value="5"/>
    <xsd:enumeration value="6"/>
    <xsd:enumeration value="7"/>
    <xsd:enumeration value="8"/>
    <xsd:enumeration value="9"/>
    <xsd:enumeration value="10"/>
    <xsd:enumeration value="11"/>
    <xsd:enumeration value="12"/>
    <xsd:enumeration value="13"/>
    <xsd:enumeration value="14"/>
    <xsd:enumeration value="15"/>
    <xsd:enumeration value="16"/>
    <xsd:enumeration value="17"/>
    <xsd:enumeration value="18"/>
    <xsd:enumeration value="19"/>
    <xsd:enumeration value="20"/>
  </xsd:restriction>

```

```
        </xsd:restriction>
<!-- User-Defined Classes can be any number. -->
<!-- Values restricted here to 20 for illustration. -->
</xsd:simpleType>
```

13.5.236.60 Post Office Type

13.5.236.60.1 Post Office Type Structure

```
<xsd:complexType name="Attr_PP_CODE">
<!-- Post Office Type -->
  <xsd:sequence>
    <xsd:element name="value" type="Attr_PP_COD_value"/>
    <xsd:element name="name" type="Attr_PP_COD_name" minOccurs="0"/>
  </xsd:sequence>
</xsd:complexType>
```

13.5.236.60.2 Post Office Type Name

```
<xsd:simpleType name="Attr_PP_COD_name">
  <xsd:restriction base="xsd:string">
    <xsd:enumeration value="Main Post Office"/>
    <xsd:enumeration value="Minor Post Office"/>
  </xsd:restriction>
</xsd:simpleType>
```

13.5.236.60.3 Post Office Type Value

```
<xsd:simpleType name="Attr_PP_COD_value">
  <xsd:restriction base="xsd:integer">
    <xsd:enumeration value="1"/>
    <xsd:enumeration value="2"/>
  </xsd:restriction>
</xsd:simpleType>
```

13.5.236.61 Price Band

13.5.236.61.1 Price Band Structure

```
<xsd:complexType name="Attr_PR_CODE">
<!-- Price Band -->
  <xsd:sequence>
    <xsd:element name="value" type="Attr_PR_COD_value"/>
    <xsd:element name="name" type="Attr_PR_COD_name" minOccurs="0"/>
  </xsd:sequence>
</xsd:complexType>
```

13.5.236.61.2 Price Band Name

```
<xsd:simpleType name="Attr_PR_COD_name">
  <xsd:restriction base="xsd:string">
    <xsd:enumeration value="Highest Cost Category"/>
    <xsd:enumeration value="Second Highest Cost Category"/>
    <xsd:enumeration value="Third Highest Cost Category"/>
    <xsd:enumeration value="Fourth Highest Cost Category"/>
    <xsd:enumeration value="Fifth Highest Cost Category"/>
    <xsd:enumeration value="Sixth Highest Cost Category"/>
    <xsd:enumeration value="Seventh Highest Cost Category"/>
    <xsd:enumeration value="Eighth Highest Cost Category"/>
    <xsd:enumeration value="Lowest Cost Category"/>
  </xsd:restriction>
</xsd:simpleType>
```

13.5.236.61.3 Price Band Value

```
<xsd:simpleType name="Attr_PR_COD_value">
  <xsd:restriction base="xsd:integer">
    <xsd:enumeration value="1"/>
    <xsd:enumeration value="2"/>
  </xsd:restriction>
</xsd:simpleType>
```

```

        <xsd:enumeration value="3"/>
        <xsd:enumeration value="4"/>
        <xsd:enumeration value="5"/>
        <xsd:enumeration value="6"/>
        <xsd:enumeration value="7"/>
        <xsd:enumeration value="8"/>
        <xsd:enumeration value="9"/>
    </xsd:restriction>
</xsd:simpleType>

```

13.5.236.62 Pronunciation Variant

13.5.236.62.1 Pronunciation Variant Structure

```

<xsd:complexType name="Attr_LV_CODE">
<!-- Pronunciation Variant -->
    <xsd:sequence>
        <xsd:element name="value" type="Attr_LV_COD_value"/>
        <xsd:element name="name" type="Attr_LV_COD_name" minOccurs="0"/>
    </xsd:sequence>
</xsd:complexType>

```

13.5.236.62.2 Pronunciation Variant Name

```

<xsd:simpleType name="Attr_LV_COD_name">
    <xsd:restriction base="xsd:string">
        <xsd:enumeration value="sub-standard"/>
        <xsd:enumeration value="local"/>
        <xsd:enumeration value="literal"/>
    </xsd:restriction>
</xsd:simpleType>

```

13.5.236.62.3 Pronunciation Variant Value

```

<xsd:simpleType name="Attr_LV_COD_value">
    <xsd:restriction base="xsd:integer">
        <xsd:enumeration value="1"/>
        <xsd:enumeration value="2"/>
        <xsd:enumeration value="3"/>
    </xsd:restriction>
</xsd:simpleType>

```

13.5.236.63 Public Transport Mode

13.5.236.63.1 Public Transport Mode Structure

```

<xsd:complexType name="Attr_PM_CODE">
<!-- Public Transport Mode -->
    <xsd:sequence>
        <xsd:element name="value" type="Attr_PM_COD_value"/>
        <xsd:element name="name" type="Attr_PM_COD_name" minOccurs="0"/>
    </xsd:sequence>
</xsd:complexType>

```

13.5.236.63.2 Public Transport Mode Name

```

<xsd:simpleType name="Attr_PM_COD_name">
    <xsd:restriction base="xsd:string">
        <xsd:enumeration value="Bus"/>
        <xsd:enumeration value="Light Rail"/>
        <xsd:enumeration value="Underground"/>
        <xsd:enumeration value="Rail"/>
        <xsd:enumeration value="Passenger Ferry"/>
    </xsd:restriction>
</xsd:simpleType>

```

13.5.236.63.3 Public Transport Mode Value

```
<xsd:simpleType name="Attr_PM_COD_value">  
  <xsd:restriction base="xsd:integer">  
    <xsd:enumeration value="1" />  
    <xsd:enumeration value="2" />  
    <xsd:enumeration value="3" />  
    <xsd:enumeration value="4" />  
    <xsd:enumeration value="5" />  
  </xsd:restriction>  
</xsd:simpleType>
```

13.5.236.64 Railway Type

13.5.236.64.1 Railway Type Structure

```
<xsd:complexType name="Attr_RY_CODE">  
<!-- Railway Type -->  
  <xsd:sequence>  
    <xsd:element name="value" type="Attr_RY_COD_value" />  
    <xsd:element name="name" type="Attr_RY_COD_name" minOccurs="0" />  
  </xsd:sequence>  
</xsd:complexType>
```

13.5.236.64.2 Railway Type Name

```
<xsd:simpleType name="Attr_RY_COD_name">  
  <xsd:restriction base="xsd:string">  
    <xsd:enumeration value="Main/National Railway" />  
    <xsd:enumeration value="Minor/Regional Railway" />  
    <xsd:enumeration value="Underground/Metro" />  
  </xsd:restriction>  
</xsd:simpleType>
```

13.5.236.64.3 Railway Type Value

```
<xsd:simpleType name="Attr_RY_COD_value">  
  <xsd:restriction base="xsd:integer">  
    <xsd:enumeration value="1" />  
    <xsd:enumeration value="2" />  
    <xsd:enumeration value="3" />  
  </xsd:restriction>  
</xsd:simpleType>
```

13.5.236.65 Rating Name

13.5.236.65.1 Rating Name Structure

```
<xsd:complexType name="Attr_RA_CODE">  
<!-- Rating Name -->  
  <xsd:sequence>  
    <xsd:element name="value" type="Attr_RA_COD_value" />  
    <xsd:element name="name" type="Attr_RA_COD_name" minOccurs="0" />  
  </xsd:sequence>  
</xsd:complexType>
```

13.5.236.65.2 Rating Name

```
<xsd:simpleType name="Attr_RA_COD_name">  
  <xsd:restriction base="xsd:string">  
    <xsd:enumeration value="Unclassified" />  
    <xsd:enumeration value="1st category" />  
    <xsd:enumeration value="2nd category" />  
    <xsd:enumeration value="3rd category" />  
    <xsd:enumeration value="4th category" />  
    <xsd:enumeration value="5th (lowest) category" />  
  </xsd:restriction>  
</xsd:simpleType>
```

13.5.236.65.3 Rating Value

```

<xsd:simpleType name="Attr_RA_COD_value">
  <xsd:restriction base="xsd:integer">
    <xsd:enumeration value="0"/>
    <xsd:enumeration value="1"/>
    <xsd:enumeration value="2"/>
    <xsd:enumeration value="3"/>
    <xsd:enumeration value="4"/>
    <xsd:enumeration value="5"/>
  </xsd:restriction>
</xsd:simpleType>

```

13.5.236.66 Region Code

13.5.236.66.1 Region Code Structure

```

<xsd:complexType name="Attr_RC_CODE">
  <!-- Region Code -->
  <xsd:sequence>
    <xsd:element name="value" type="Attr_RC_COD_value"/>
    <xsd:element name="name" type="Attr_RC_COD_name" minOccurs="0"/>
  </xsd:sequence>
</xsd:complexType>

```

13.5.236.66.2 Region Code Name

```

<xsd:simpleType name="Attr_RC_COD_name">
  <xsd:restriction base="xsd:string">
    <xsd:enumeration value="Region code 1"/>
    <xsd:enumeration value="Region code 2"/>
    <xsd:enumeration value="Region code 3"/>
    <xsd:enumeration value="Region code 4"/>
    <xsd:enumeration value="Region code 5"/>
    <xsd:enumeration value="Region code 6"/>
    <xsd:enumeration value="Region code 7"/>
    <xsd:enumeration value="Region code 8"/>
    <xsd:enumeration value="Region code 9"/>
    <xsd:enumeration value="Region code 10"/>
    <xsd:enumeration value="Region code 11"/>
    <xsd:enumeration value="Region code 12"/>
    <xsd:enumeration value="Region code 13"/>
    <xsd:enumeration value="Region code 14"/>
    <xsd:enumeration value="Region code 15"/>
    <xsd:enumeration value="Region code 16"/>
    <xsd:enumeration value="Region code 17"/>
    <xsd:enumeration value="Region code 18"/>
    <xsd:enumeration value="Region code 19"/>
    <xsd:enumeration value="Region code 20"/>
  </xsd:restriction>
  <!-- There can be any number of official or user-defined codes. -->
  <!-- Restricted here to 20 for illustration. -->
</xsd:simpleType>

```

13.5.236.66.3 Region Code Value

```

<xsd:simpleType name="Attr_RC_COD_value">
  <xsd:restriction base="xsd:integer">
    <xsd:enumeration value="1"/>
    <xsd:enumeration value="2"/>
    <xsd:enumeration value="3"/>
    <xsd:enumeration value="4"/>
    <xsd:enumeration value="5"/>
    <xsd:enumeration value="6"/>
    <xsd:enumeration value="7"/>
    <xsd:enumeration value="8"/>
    <xsd:enumeration value="9"/>
    <xsd:enumeration value="10"/>
    <xsd:enumeration value="11"/>
    <xsd:enumeration value="12"/>
    <xsd:enumeration value="13"/>
    <xsd:enumeration value="14"/>
  </xsd:restriction>
</xsd:simpleType>

```

```
        <xsd:enumeration value="15"/>
        <xsd:enumeration value="16"/>
        <xsd:enumeration value="17"/>
        <xsd:enumeration value="18"/>
        <xsd:enumeration value="19"/>
        <xsd:enumeration value="20"/>
    </xsd:restriction>
<!-- There can be any number of official or user-defined codes. -->
<!-- Restricted here to 20 for illustration. -->
</xsd:simpleType>
```

13.5.236.67 Removable Blockage

13.5.236.67.1 Removable Blockage Structure

```
<xsd:complexType name="Attr_RB_CODE">
<!-- Removable Blockage -->
    <xsd:sequence>
        <xsd:element name="value" type="Attr_RB_COD_value"/>
        <xsd:element name="name" type="Attr_RB_COD_name" minOccurs="0"/>
    </xsd:sequence>
</xsd:complexType>
```

13.5.236.67.2 Removable Blockage Name

```
<xsd:simpleType name="Attr_RB_COD_name">
    <xsd:restriction base="xsd:string">
        <xsd:enumeration value="Accessible for Emergency Vehicles"/>
        <xsd:enumeration value="Keyed Access"/>
        <xsd:enumeration value="Guard Controlled"/>
    </xsd:restriction>
</xsd:simpleType>
```

13.5.236.67.3 Removable Blockage Value

```
<xsd:simpleType name="Attr_RB_COD_value">
    <xsd:restriction base="xsd:integer">
        <xsd:enumeration value="1"/>
        <xsd:enumeration value="2"/>
        <xsd:enumeration value="3"/>
    </xsd:restriction>
</xsd:simpleType>
```

13.5.236.68 Road and Rail Network and Associated Land Type

13.5.236.68.1 Road and Rail Network and Associated Land Type Structure

```
<xsd:complexType name="Attr_RZ_CODE">
<!-- Road and Rail Network and Associated Land Type -->
    <xsd:sequence>
        <xsd:element name="value" type="Attr_RZ_COD_value"/>
        <xsd:element name="name" type="Attr_RZ_COD_name" minOccurs="0"/>
    </xsd:sequence>
</xsd:complexType>
```

13.5.236.68.2 Road and Rail Network and Associated Land Type Name

```
<xsd:simpleType name="Attr_RZ_COD_name">
    <xsd:restriction base="xsd:string">
        <xsd:enumeration value="Road and Rail Network And Associated Land Type 1"/>
        <xsd:enumeration value="Road and Rail Network And Associated Land Type 2"/>
        <xsd:enumeration value="Road and Rail Network And Associated Land Type 3"/>
        <xsd:enumeration value="Road and Rail Network And Associated Land Type 4"/>
        <xsd:enumeration value="Road and Rail Network And Associated Land Type 5"/>
        <xsd:enumeration value="Road and Rail Network And Associated Land Type 6"/>
        <xsd:enumeration value="Road and Rail Network And Associated Land Type 7"/>
        <xsd:enumeration value="Road and Rail Network And Associated Land Type 8"/>
        <xsd:enumeration value="Road and Rail Network And Associated Land Type 9"/>
        <xsd:enumeration value="Road and Rail Network And Associated Land Type 10"/>
<!-- a break in the sequence occurs in the middle... -->
```

```

    <xsd:enumeration value="Road and Rail Network And Associated Land Type 41"/>
    <xsd:enumeration value="Road and Rail Network And Associated Land Type 42"/>
    <xsd:enumeration value="Road and Rail Network And Associated Land Type 43"/>
    <xsd:enumeration value="Road and Rail Network And Associated Land Type 44"/>
    <xsd:enumeration value="Road and Rail Network And Associated Land Type 45"/>
    <xsd:enumeration value="Road and Rail Network And Associated Land Type 46"/>
    <xsd:enumeration value="Road and Rail Network And Associated Land Type 47"/>
    <xsd:enumeration value="Road and Rail Network And Associated Land Type 48"/>
    <xsd:enumeration value="Road and Rail Network And Associated Land Type 49"/>
    <xsd:enumeration value="Road and Rail Network And Associated Land Type 50"/>
  </xsd:restriction>
</xsd:simpleType>

```

13.5.236.68.3 Road and Rail Network and Associated Land Type Value

```

<xsd:simpleType name="Attr_RZ_COD_value">
  <xsd:restriction base="xsd:integer">
    <xsd:enumeration value="1"/>
    <xsd:enumeration value="2"/>
    <xsd:enumeration value="3"/>
    <xsd:enumeration value="4"/>
    <xsd:enumeration value="5"/>
    <xsd:enumeration value="6"/>
    <xsd:enumeration value="8"/>
    <xsd:enumeration value="9"/>
    <xsd:enumeration value="10"/>
    <!-- a break in the sequence occurs in the middle... -->
    <xsd:enumeration value="41"/>
    <xsd:enumeration value="42"/>
    <xsd:enumeration value="43"/>
    <xsd:enumeration value="44"/>
    <xsd:enumeration value="45"/>
    <xsd:enumeration value="46"/>
    <xsd:enumeration value="47"/>
    <xsd:enumeration value="48"/>
    <xsd:enumeration value="49"/>
    <xsd:enumeration value="50"/>
  </xsd:restriction>
</xsd:simpleType>

```

13.5.236.69 Road Furniture Position

13.5.236.69.1 Road Furniture Position Structure

```

<xsd:complexType name="Attr_FP_BMI">
  <!-- Road Furniture Position -->
  <xsd:sequence>
    <xsd:element name="value" type="Attr_FP_BMI_value"/>
    <xsd:element name="name" type="Attr_FP_BMI_name" minOccurs="0"/>
  </xsd:sequence>
</xsd:complexType>

```

13.5.236.69.2 Road Furniture Position Name

```

<xsd:simpleType name="Attr_FP_BMI_name">
  <xsd:restriction base="xsd:string">
    <xsd:enumeration value="To the right of the road"/>
    <xsd:enumeration value="To the left of the road"/>
    <xsd:enumeration value="Overhead"/>
  </xsd:restriction>
</xsd:simpleType>

```

13.5.236.69.3 Road Furniture Position Value

```

<xsd:simpleType name="Attr_FP_BMI_value">
  <xsd:restriction base="xsd:integer">
    <xsd:enumeration value="1"/>
    <xsd:enumeration value="2"/>
    <xsd:enumeration value="3"/>
  </xsd:restriction>
</xsd:simpleType>

```

13.5.236.70 Road Surface Condition

13.5.236.70.1 Road Surface Condition Structure

```
<xsd:complexType name="Attr_RR_CODE">  
<!-- Road Surface Condition -->  
  <xsd:sequence>  
    <xsd:element name="value" type="Attr_RR_COD_value"/>  
    <xsd:element name="name" type="Attr_RR_COD_name" minOccurs="0"/>  
  </xsd:sequence>  
</xsd:complexType>
```

13.5.236.70.2 Road Surface Condition Name

```
<xsd:simpleType name="Attr_RR_COD_name">  
  <xsd:restriction base="xsd:string">  
    <xsd:enumeration value="Good"/>  
    <xsd:enumeration value="Poor"/>  
  </xsd:restriction>  
</xsd:simpleType>
```

13.5.236.70.3 Road Surface Condition Value

```
<xsd:simpleType name="Attr_RR_COD_value">  
  <xsd:restriction base="xsd:integer">  
    <xsd:enumeration value="1"/>  
    <xsd:enumeration value="2"/>  
  </xsd:restriction>  
</xsd:simpleType>
```

13.5.236.71 Route Direction

13.5.236.71.1 Route Direction Structure

```
<xsd:complexType name="Attr_PD_ENUM">  
<!-- Route Direction -->  
  <xsd:sequence>  
    <xsd:element name="value" type="Attr_PD_ENM_value"/>  
    <xsd:element name="name" type="Attr_PD_ENM_name" minOccurs="0"/>  
  </xsd:sequence>  
</xsd:complexType>
```

13.5.236.71.2 Route Direction Name

```
<xsd:simpleType name="Attr_PD_ENM_name">  
  <xsd:restriction base="xsd:string">  
    <xsd:enumeration value="Negative"/>  
    <xsd:enumeration value="Positive"/>  
  </xsd:restriction>  
</xsd:simpleType>
```

13.5.236.71.3 Route Direction Value

```
<xsd:simpleType name="Attr_PD_ENM_value">  
  <xsd:restriction base="xsd:integer">  
    <xsd:enumeration value="0"/>  
    <xsd:enumeration value="1"/>  
  </xsd:restriction>  
</xsd:simpleType>
```

13.5.236.72 Routing Type

13.5.236.72.1 Routing Type Structure

```
<xsd:complexType name="Attr_RT_CODE">  
<!-- Routing Type -->  
  <xsd:sequence>
```

```

    <xsd:element name="value" type="Attr_RT_COD_value"/>
    <xsd:element name="name" type="Attr_RT_COD_name" minOccurs="0"/>
  </xsd:sequence>
</xsd:complexType>

```

13.5.236.72.2 Routing Type Name

```

<xsd:simpleType name="Attr_RT_COD_name">
  <xsd:restriction base="xsd:string">
    <xsd:enumeration value="Restricted Vehicle Road"/>
    <xsd:enumeration value="Dangerous Load Route"/>
    <xsd:enumeration value="Precautionary Salting Route"/>
    <xsd:enumeration value="Transcontinental Route"/>
    <xsd:enumeration value="Designated Truck Route"/>
    <xsd:enumeration value="Other Route"/>
  </xsd:restriction>
</xsd:simpleType>

```

13.5.236.72.3 Routing Type Value

```

<xsd:simpleType name="Attr_RT_COD_value">
  <xsd:restriction base="xsd:integer">
    <xsd:enumeration value="1"/>
    <xsd:enumeration value="2"/>
    <xsd:enumeration value="3"/>
    <xsd:enumeration value="4"/>
    <xsd:enumeration value="5"/>
    <xsd:enumeration value="99"/>
  </xsd:restriction>
</xsd:simpleType>

```

13.5.236.73 Sand Area Type

13.5.236.73.1 Sand Area Type Structure

```

  <xsd:complexType name="Attr_SA_CODE">
<!-- Sand Area Type -->
    <xsd:sequence>
      <xsd:element name="value" type="Attr_SA_COD_value"/>
      <xsd:element name="name" type="Attr_SA_COD_name" minOccurs="0"/>
    </xsd:sequence>
  </xsd:complexType>

```

13.5.236.73.2 Sand Area Type Name

```

<xsd:simpleType name="Attr_SA_COD_name">
  <xsd:restriction base="xsd:string">
    <xsd:enumeration value="Beach/Dune"/>
    <xsd:enumeration value="Desert"/>
    <xsd:enumeration value="Other"/>
  </xsd:restriction>
</xsd:simpleType>

```

13.5.236.73.3 Sand Area Type Value

```

<xsd:simpleType name="Attr_SA_COD_value">
  <xsd:restriction base="xsd:integer">
    <xsd:enumeration value="1"/>
    <xsd:enumeration value="2"/>
    <xsd:enumeration value="99"/>
  </xsd:restriction>
</xsd:simpleType>

```

13.5.236.74 Scope

13.5.236.74.1 Scope Structure

```

  <xsd:complexType name="Attr_CY_ENUM">

```

```
<!-- Scope -->
  <xsd:sequence>
    <xsd:element name="value" type="Attr_CY_ENM_value"/>
    <xsd:element name="name" type="Attr_CY_ENM_name" minOccurs="0"/>
  </xsd:sequence>
</xsd:complexType>
```

13.5.236.74.2 Scope Name

```
<xsd:simpleType name="Attr_CY_ENM_name">
  <xsd:restriction base="xsd:string">
    <xsd:enumeration value="Full"/>
    <xsd:enumeration value="Partial"/>
  </xsd:restriction>
</xsd:simpleType>
```

13.5.236.74.3 Scope Value

```
<xsd:simpleType name="Attr_CY_ENM_value">
  <xsd:restriction base="xsd:integer">
    <xsd:enumeration value="1"/>
    <xsd:enumeration value="2"/>
  </xsd:restriction>
</xsd:simpleType>
```

13.5.236.75 Settlement Type

13.5.236.75.1 Settlement Type Structure

```
<xsd:complexType name="Attr_SM_CODE">
<!-- Settlement Type -->
  <xsd:sequence>
    <xsd:element name="value" type="Attr_SM_COD_value"/>
    <xsd:element name="name" type="Attr_SM_COD_name" minOccurs="0"/>
  </xsd:sequence>
</xsd:complexType>
```

13.5.236.75.2 Settlement Type Name

```
<xsd:simpleType name="Attr_SM_COD_name">
  <xsd:restriction base="xsd:string">
    <xsd:enumeration value="Residential"/>
    <xsd:enumeration value="Recreational"/>
    <xsd:enumeration value="Industrial"/>
    <xsd:enumeration value="Military"/>
  </xsd:restriction>
</xsd:simpleType>
```

13.5.236.75.3 Settlement Type Value

```
<xsd:simpleType name="Attr_SM_COD_value">
  <xsd:restriction base="xsd:integer">
    <xsd:enumeration value="1"/>
    <xsd:enumeration value="2"/>
    <xsd:enumeration value="3"/>
    <xsd:enumeration value="4"/>
  </xsd:restriction>
</xsd:simpleType>
```

13.5.236.76 Side of Line

13.5.236.76.1 Side of Line Structure

```
<xsd:complexType name="Attr_SI_ENUM">
<!-- Side of Line -->
  <xsd:sequence>
    <xsd:element name="value" type="Attr_SI_ENM_value"/>
    <xsd:element name="name" type="Attr_SI_ENM_name" minOccurs="0"/>
  </xsd:sequence>
</xsd:complexType>
```

13.5.236.76.2 Side of Line Name

```

<xsd:simpleType name="Attr_SI_ENM_name">
  <xsd:restriction base="xsd:string">
    <xsd:enumeration value="Left Side"/>
    <xsd:enumeration value="Right Side"/>
  </xsd:restriction>
</xsd:simpleType>

```

13.5.236.76.3 Side of Line Value

```

<xsd:simpleType name="Attr_SI_ENM_value">
  <xsd:restriction base="xsd:integer">
    <xsd:enumeration value="1"/>
    <xsd:enumeration value="2"/>
  </xsd:restriction>
</xsd:simpleType>

```

13.5.236.77 Slip Road Type**13.5.236.77.1 Slip Road Type Structure**

```

<xsd:complexType name="Attr_SL_CODE">
<!-- Slip Road Type -->
  <xsd:sequence>
    <xsd:element name="value" type="Attr_SL_COD_value"/>
    <xsd:element name="name" type="Attr_SL_COD_name" minOccurs="0"/>
  </xsd:sequence>
</xsd:complexType>

```

13.5.236.77.2 Slip Road Type Name

```

<xsd:simpleType name="Attr_SL_COD_name">
  <xsd:restriction base="xsd:string">
    <xsd:enumeration value="Parallel Road"/>
    <xsd:enumeration value="Slip Road of a grade separated crossing"/>
    <xsd:enumeration value="Slip Road of a crossing at grade"/>
    <xsd:enumeration value="Other"/>
  </xsd:restriction>
</xsd:simpleType>

```

13.5.236.77.3 Slip Road Type Value

```

<xsd:simpleType name="Attr_SL_COD_value">
  <xsd:restriction base="xsd:integer">
    <xsd:enumeration value="1"/>
    <xsd:enumeration value="2"/>
    <xsd:enumeration value="3"/>
    <xsd:enumeration value="10"/>
  </xsd:restriction>
</xsd:simpleType>

```

13.5.236.78 Start End Flag**13.5.236.78.1 Start End Flag Structure**

```

<xsd:complexType name="Attr_CE_ENUM">
<!-- Start End Flag -->
  <xsd:sequence>
    <xsd:element name="value" type="Attr_CE_ENM_value"/>
    <xsd:element name="name" type="Attr_CE_ENM_name" minOccurs="0"/>
  </xsd:sequence>
</xsd:complexType>

```

13.5.236.78.2 Start End Flag Name

```

<xsd:simpleType name="Attr_CE_ENM_name">
  <xsd:restriction base="xsd:string">

```

```
        <xsd:enumeration value="Start"/>
        <xsd:enumeration value="End"/>
    </xsd:restriction>
</xsd:simpleType>
```

13.5.236.78.3 Start End Flag Value

```
<xsd:simpleType name="Attr_CE_ENM_value">
  <xsd:restriction base="xsd:integer">
    <xsd:enumeration value="1"/>
    <xsd:enumeration value="2"/>
  </xsd:restriction>
</xsd:simpleType>
```

13.5.236.79 Start End Flag

13.5.236.79.1 Conditional Traffic Flow Structure

```
<xsd:complexType name="Attr_CF_ENUM">
  <!-- Open/Closed Conditional Traffic Flow values -->
  <xsd:sequence>
    <xsd:element name="value" type="Attr_CF_ENM_value"/>
    <xsd:element name="name" type="Attr_CF_ENM_name" minOccurs="0"/>
  </xsd:sequence>
</xsd:complexType>
```

13.5.236.79.2 Conditional Traffic Flow Name

```
<xsd:simpleType name="Attr_CF_ENM_name">
  <xsd:restriction base="xsd:string">
    <xsd:enumeration value="Closed"/>
    <xsd:enumeration value="Open"/>
  </xsd:restriction>
</xsd:simpleType>
```

13.5.236.79.3 Conditional Traffic Flow Value

```
<xsd:simpleType name="Attr_CF_ENM_value">
  <xsd:restriction base="xsd:integer">
    <xsd:enumeration value="0"/>
    <xsd:enumeration value="1"/>
  </xsd:restriction>
```

13.5.236.80 Structure Abutment

13.5.236.80.1 Structure Abutment Structure

```
<xsd:complexType name="Attr_AB_BMI">
<!-- Structure Abutment -->
  <xsd:sequence>
    <xsd:element name="value" type="Attr_AB_BMI_value"/>
    <xsd:element name="name" type="Attr_AB_BMI_name" minOccurs="0"/>
  </xsd:sequence>
</xsd:complexType>
```

13.5.236.80.2 Structure Abutment Name

```
<xsd:simpleType name="Attr_AB_BMI_name">
  <xsd:restriction base="xsd:string">
    <xsd:enumeration value="Structure abutment on the left of Road Element"/>
    <xsd:enumeration value="Structure abutment on the right of Road Element"/>
    <xsd:enumeration value="Structure abutment in the middle of the Road Element"/>
  </xsd:restriction>
</xsd:simpleType>
```

13.5.236.80.3 Structure Abutment Value

```

<xsd:simpleType name="Attr_AB_BMI_value">
  <xsd:restriction base="xsd:integer">
    <xsd:enumeration value="1"/>
    <xsd:enumeration value="2"/>
    <xsd:enumeration value="4"/>
  </xsd:restriction>
</xsd:simpleType>

```

13.5.236.81 Structure Category

13.5.236.81.1 Structure Category Structure

```

<xsd:complexType name="Attr_SC_CODE">
<!-- Structure Category -->
  <xsd:sequence>
    <xsd:element name="value" type="Attr_SC_COD_value"/>
    <xsd:element name="name" type="Attr_SC_COD_name" minOccurs="0"/>
  </xsd:sequence>
</xsd:complexType>

```

13.5.236.81.2 Structure Category Name

```

<xsd:simpleType name="Attr_SC_COD_name">
  <xsd:restriction base="xsd:string">
    <xsd:enumeration value="Over"/>
    <xsd:enumeration value="Under"/>
    <xsd:enumeration value="Other"/>
  </xsd:restriction>
</xsd:simpleType>

```

13.5.236.81.3 Structure Category Value

```

<xsd:simpleType name="Attr_SC_COD_value">
  <xsd:restriction base="xsd:integer">
    <xsd:enumeration value="1"/>
    <xsd:enumeration value="2"/>
    <xsd:enumeration value="3"/>
  </xsd:restriction>
</xsd:simpleType>

```

13.5.236.82 Structure Type

13.5.236.82.1 Structure Type Structure

```

<xsd:complexType name="Attr_BT_CODE">
<!-- Structure Type -->
  <xsd:sequence>
    <xsd:element name="value" type="Attr_BT_COD_value"/>
    <xsd:element name="name" type="Attr_BT_COD_name" minOccurs="0"/>
  </xsd:sequence>
</xsd:complexType>

```

13.5.236.82.2 Structure Type Name

```

<xsd:simpleType name="Attr_BT_COD_name">
  <xsd:restriction base="xsd:string">
    <xsd:enumeration value="Bridge"/>
    <xsd:enumeration value="Viaduct"/>
    <xsd:enumeration value="Aqueduct"/>
    <xsd:enumeration value="Tunnel"/>
    <xsd:enumeration value="Cutting"/>
    <xsd:enumeration value="Gallery"/>
    <xsd:enumeration value="Retaining wall"/>
    <xsd:enumeration value="Embankment"/>
    <xsd:enumeration value="Not classified"/>
  </xsd:restriction>
</xsd:simpleType>

```

13.5.236.82.3 Structure Type Value

```
<xsd:simpleType name="Attr_BT_COD_value">  
  <xsd:restriction base="xsd:integer">  
    <xsd:enumeration value="1"/>  
    <xsd:enumeration value="2"/>  
    <xsd:enumeration value="3"/>  
    <xsd:enumeration value="4"/>  
    <xsd:enumeration value="11"/>  
    <xsd:enumeration value="12"/>  
    <xsd:enumeration value="13"/>  
    <xsd:enumeration value="14"/>  
    <xsd:enumeration value="5"/>  
  </xsd:restriction>  
</xsd:simpleType>
```

13.5.236.83 Symbol on Traffic Sign

13.5.236.83.1 Symbol on Traffic Sign Structure

```
<xsd:complexType name="Attr_SY_CODE">  
<!-- Symbol on Traffic Sign -->  
  <xsd:sequence>  
    <xsd:element name="value" type="Attr_SY_COD_value"/>  
    <xsd:element name="name" type="Attr_SY_COD_name" minOccurs="0"/>  
  </xsd:sequence>  
</xsd:complexType>
```

13.5.236.83.2 Symbol on Traffic Sign Name

```
<xsd:simpleType name="Attr_SY_COD_name">  
  <xsd:restriction base="xsd:string">  
    <xsd:enumeration value="All traffic"/>  
    <xsd:enumeration value="Motorcycle"/>  
    <xsd:enumeration value="Private car"/>  
    <xsd:enumeration value="Private car with trailer"/>  
    <xsd:enumeration value="Heavy Goods Vehicle"/>  
    <xsd:enumeration value="Heavy Goods Vehicle with trailer"/>  
    <xsd:enumeration value="Bus"/>  
    <xsd:enumeration value="Motor vehicle, having a maximum speed of 25 km/h"/>  
    <xsd:enumeration value="Vehicle with dangerous goods other than explosive or water  
polluting  
goods"/>  
    <xsd:enumeration value="Vehicle with explosive goods"/>  
    <xsd:enumeration value="Vehicle with water polluting goods"/>  
    <xsd:enumeration value="Tram"/>  
    <xsd:enumeration value="Train"/>  
    <xsd:enumeration value="Bicycle"/>  
    <xsd:enumeration value="Moped"/>  
    <xsd:enumeration value="Horse-drawn vehicle"/>  
    <xsd:enumeration value="Rider"/>  
    <xsd:enumeration value="Pedestrian"/>  
    <xsd:enumeration value="Pedestrian with hand-drawn vehicle"/>  
    <xsd:enumeration value="Speed"/>  
    <xsd:enumeration value="Total Weight"/>  
    <xsd:enumeration value="Weight per axle"/>  
    <xsd:enumeration value="Width"/>  
    <xsd:enumeration value="Height"/>  
    <xsd:enumeration value="Length"/>  
  </xsd:restriction>  
</xsd:simpleType>
```

13.5.236.83.3 Symbol on Traffic Sign Value

```
<xsd:simpleType name="Attr_SY_COD_value">  
  <xsd:restriction base="xsd:integer">  
    <xsd:enumeration value="0"/>  
    <xsd:enumeration value="1"/>  
    <xsd:enumeration value="2"/>  
    <xsd:enumeration value="3"/>  
    <xsd:enumeration value="4"/>  
  </xsd:restriction>  
</xsd:simpleType>
```

```

        <xsd:enumeration value="5"/>
        <xsd:enumeration value="6"/>
        <xsd:enumeration value="7"/>
        <xsd:enumeration value="8"/>
        <xsd:enumeration value="9"/>
        <xsd:enumeration value="10"/>
        <xsd:enumeration value="11"/>
        <xsd:enumeration value="12"/>
        <xsd:enumeration value="15"/>
        <xsd:enumeration value="16"/>
        <xsd:enumeration value="17"/>
        <xsd:enumeration value="18"/>
        <xsd:enumeration value="19"/>
        <xsd:enumeration value="20"/>
        <xsd:enumeration value="40"/>
        <xsd:enumeration value="50"/>
        <xsd:enumeration value="51"/>
        <xsd:enumeration value="52"/>
        <xsd:enumeration value="53"/>
        <xsd:enumeration value="54"/>
    </xsd:restriction>
</xsd:simpleType>

```

13.5.236.84 Toll Point Type

13.5.236.84.1 Toll Point Type Structure

```

<xsd:complexType name="Attr_TB_CODE">
<!-- Toll Point Type -->
    <xsd:sequence>
        <xsd:element name="value" type="Attr_TB_COD_value"/>
        <xsd:element name="name" type="Attr_TB_COD_name" minOccurs="0"/>
    </xsd:sequence>
</xsd:complexType>

```

13.5.236.84.2 Toll Point Type Name

```

<xsd:simpleType name="Attr_TB_COD_name">
    <xsd:restriction base="xsd:string">
        <xsd:enumeration value="Physical Toll Booth"/>
        <xsd:enumeration value="Virtual Toll Booth"/>
        <xsd:enumeration value="Hybrid"/>
    </xsd:restriction>
</xsd:simpleType>

```

13.5.236.84.3 Toll Point Type Value

```

<xsd:simpleType name="Attr_TB_COD_value">
    <xsd:restriction base="xsd:integer">
        <xsd:enumeration value="1"/>
        <xsd:enumeration value="2"/>
        <xsd:enumeration value="3"/>
    </xsd:restriction>
</xsd:simpleType>

```

13.5.236.85 Traffic Flow Measurement Type

13.5.236.85.1 Traffic Flow Measurement Type Structure

```

<xsd:complexType name="Attr_TY_CODE">
<!-- Traffic Flow Measurement Type -->
    <xsd:sequence>
        <xsd:element name="value" type="Attr_TY_COD_value"/>
        <xsd:element name="name" type="Attr_TY_COD_name" minOccurs="0"/>
    </xsd:sequence>
</xsd:complexType>

```

13.5.236.85.2 Traffic Flow Measurement Type Name

```
<xsd:simpleType name="Attr_TY_COD_name">  
  <xsd:restriction base="xsd:string">  
    <xsd:enumeration value="Average Traffic"/>  
    <xsd:enumeration value="Averag Flow during Peak Periods"/>  
    <xsd:enumeration value="Maximum Flow"/>  
  </xsd:restriction>  
</xsd:simpleType>
```

13.5.236.85.3 Traffic Flow Measurement Type Value

```
<xsd:simpleType name="Attr_TY_COD_value">  
  <xsd:restriction base="xsd:integer">  
    <xsd:enumeration value="1"/>  
    <xsd:enumeration value="2"/>  
    <xsd:enumeration value="3"/>  
  </xsd:restriction>  
</xsd:simpleType>
```

13.5.236.86 Traffic Jam Sensitivity

13.5.236.86.1 Traffic Jam Sensitivity Structure

```
<xsd:complexType name="Attr_TJ_CODE">  
<!-- Traffic Jam Sensitivity -->  
  <xsd:sequence>  
    <xsd:element name="value" type="Attr_TJ_COD_value"/>  
    <xsd:element name="name" type="Attr_TJ_COD_name" minOccurs="0"/>  
  </xsd:sequence>  
</xsd:complexType>
```

13.5.236.86.2 Traffic Jam Sensitivity Name

```
<xsd:simpleType name="Attr_TJ_COD_name">  
  <xsd:restriction base="xsd:string">  
    <xsd:enumeration value="No or low probability"/>  
    <xsd:enumeration value="High probability"/>  
  </xsd:restriction>  
</xsd:simpleType>
```

13.5.236.86.3 Traffic Jam Sensitivity Value

```
<xsd:simpleType name="Attr_TJ_COD_value">  
  <xsd:restriction base="xsd:integer">  
    <xsd:enumeration value="0"/>  
    <xsd:enumeration value="1"/>  
  </xsd:restriction>  
</xsd:simpleType>
```

13.5.236.87 Traffic Sign Class

13.5.236.87.1 Traffic Sign Class Structure

```
<xsd:complexType name="Attr_TS_CODE">  
<!-- Traffic Sign Class -->  
  <xsd:sequence>  
    <xsd:element name="value" type="Attr_TS_COD_value"/>  
    <xsd:element name="name" type="Attr_TS_COD_name" minOccurs="0"/>  
  </xsd:sequence>  
</xsd:complexType>
```

13.5.236.87.2 Traffic Sign Class Name

```
<xsd:simpleType name="Attr_TS_COD_name">  
  <xsd:restriction base="xsd:string">  
    <xsd:enumeration value="Right of Way"/>  
    <xsd:enumeration value="Directional"/>  
  </xsd:restriction>  
</xsd:simpleType>
```

```

        <xsd:enumeration value="Right of Passage"/>
        <xsd:enumeration value="Signpost"/>
        <xsd:enumeration value="Route prohibition"/>
        <xsd:enumeration value="Stopping prohibition"/>
        <xsd:enumeration value="Warning sign"/>
        <xsd:enumeration value="Directional sign"/>
        <xsd:enumeration value="Variable Speed Sign"/>
    </xsd:restriction>
</xsd:simpleType>

```

13.5.236.87.3 Traffic Sign Class Value

```

<xsd:simpleType name="Attr_TS_COD_value">
  <xsd:restriction base="xsd:integer">
    <xsd:enumeration value="50"/>
    <xsd:enumeration value="51"/>
    <xsd:enumeration value="52"/>
    <xsd:enumeration value="53"/>
    <xsd:enumeration value="54"/>
    <xsd:enumeration value="55"/>
    <xsd:enumeration value="56"/>
    <xsd:enumeration value="57"/>
    <xsd:enumeration value="99"/>
  </xsd:restriction>
</xsd:simpleType>

```

13.5.236.88 Trailing Spaces

13.5.236.88.1 Trailing Spaces Structure

```

<xsd:complexType name="Attr_TI_ENUM">
<!-- Trailing Spaces -->
  <xsd:sequence>
    <xsd:element name="value" type="Attr_TI_ENM_value"/>
    <xsd:element name="name" type="Attr_TI_ENM_name" minOccurs="0"/>
  </xsd:sequence>
</xsd:complexType>

```

13.5.236.88.2 Trailing Spaces Name

```

<xsd:simpleType name="Attr_TI_ENM_name">
  <xsd:restriction base="xsd:string">
    <xsd:enumeration value="None"/>
    <xsd:enumeration value="Between preceding part and Street Name Body"/>
    <xsd:enumeration value="Between Street Name Body and succeeding part"/>
    <xsd:enumeration value="Between preceding part and the Street Name Body, and between the
Street Name Body and the succeeding part"/>
  </xsd:restriction>
</xsd:simpleType>

```

13.5.236.88.3 Trailing Spaces Value

```

<xsd:simpleType name="Attr_TI_ENM_value">
  <xsd:restriction base="xsd:integer">
    <xsd:enumeration value="0"/>
    <xsd:enumeration value="1"/>
    <xsd:enumeration value="2"/>
    <xsd:enumeration value="3"/>
  </xsd:restriction>
</xsd:simpleType>

```

13.5.236.89 Transition

13.5.236.89.1 Transition Structure

```

<xsd:complexType name="Attr_TN_CODE">
<!-- Transition -->
  <xsd:sequence>
    <xsd:element name="value" type="Attr_TN_COD_value"/>
    <xsd:element name="name" type="Attr_TN_COD_name" minOccurs="0"/>
  </xsd:sequence>
</xsd:complexType>

```

```
</xsd:sequence>  
</xsd:complexType>
```

13.5.236.89.2 Transition Name

```
<xsd:simpleType name="Attr_TN_COD_name">  
  <xsd:restriction base="xsd:string">  
    <xsd:enumeration value="Regular Geometry"/>  
    <xsd:enumeration value="Transitional Geometry"/>  
  </xsd:restriction>  
</xsd:simpleType>
```

13.5.236.89.3 Transition Value

```
<xsd:simpleType name="Attr_TN_COD_value">  
  <xsd:restriction base="xsd:integer">  
    <xsd:enumeration value="0"/>  
    <xsd:enumeration value="1"/>  
  </xsd:restriction>  
</xsd:simpleType>
```

13.5.236.90 Type of Public Transport Point

13.5.236.90.1 Type of Public Transport Point Structure

```
<xsd:complexType name="Attr_TP_CODE">  
<!-- Type of Public Transport Point -->  
  <xsd:sequence>  
    <xsd:element name="value" type="Attr_TP_COD_value"/>  
    <xsd:element name="name" type="Attr_TP_COD_name" minOccurs="0"/>  
  </xsd:sequence>  
</xsd:complexType>
```

13.5.236.90.2 Type of Public Transport Point Name

```
<xsd:simpleType name="Attr_TP_COD_name">  
  <xsd:restriction base="xsd:string">  
    <xsd:enumeration value="Timing Point"/>  
    <xsd:enumeration value="Traffic Control Point"/>  
    <xsd:enumeration value="Activation Point"/>  
    <xsd:enumeration value="Turn Station"/>  
    <xsd:enumeration value="Break Facility"/>  
    <xsd:enumeration value="Parking Point"/>  
    <xsd:enumeration value="Relief Point"/>  
  </xsd:restriction>  
</xsd:simpleType>
```

13.5.236.90.3 Type of Public Transport Point Value

```
<xsd:simpleType name="Attr_TP_COD_value">  
  <xsd:restriction base="xsd:integer">  
    <xsd:enumeration value="1"/>  
    <xsd:enumeration value="2"/>  
    <xsd:enumeration value="3"/>  
    <xsd:enumeration value="4"/>  
    <xsd:enumeration value="5"/>  
    <xsd:enumeration value="6"/>  
    <xsd:enumeration value="7"/>  
  </xsd:restriction>  
</xsd:simpleType>
```

13.5.236.91 Underground Flag

13.5.236.91.1 Underground Flag Structure

```
<xsd:complexType name="Attr_UF_CODE">  
<!-- Underground Flag -->  
  <xsd:sequence>  
    <xsd:element name="value" type="Attr_UF_COD_value"/>
```

```

    <xsd:element name="name" type="Attr_UF_COD_name" minOccurs="0"/>
  </xsd:sequence>
</xsd:complexType>

```

13.5.236.91.2 Underground Flag Name

```

<xsd:simpleType name="Attr_UF_COD_name">
  <xsd:restriction base="xsd:string">
    <xsd:enumeration value="Aboveground"/>
    <xsd:enumeration value="Underground"/>
  </xsd:restriction>
</xsd:simpleType>

```

13.5.236.91.3 Underground Flag Value

```

<xsd:simpleType name="Attr_UF_COD_value">
  <xsd:restriction base="xsd:integer">
    <xsd:enumeration value="0"/>
    <xsd:enumeration value="1"/>
  </xsd:restriction>
</xsd:simpleType>

```

13.5.236.92 Unpaved Road Surface Type

13.5.236.92.1 Unpaved Road Surface Type Structure

```

<xsd:complexType name="Attr_UR_CODE">
  <!-- Unpaved Road Surface Type -->
  <xsd:sequence>
    <xsd:element name="value" type="Attr_UR_COD_value"/>
    <xsd:element name="name" type="Attr_UR_COD_name" minOccurs="0"/>
  </xsd:sequence>
</xsd:complexType>

```

13.5.236.92.2 Unpaved Road Surface Type Name

```

<xsd:simpleType name="Attr_UR_COD_name">
  <xsd:restriction base="xsd:string">
    <xsd:enumeration value="Gravel"/>
    <xsd:enumeration value="Dirt"/>
  </xsd:restriction>
</xsd:simpleType>

```

13.5.236.92.3 Unpaved Road Surface Type Value

```

<xsd:simpleType name="Attr_UR_COD_value">
  <xsd:restriction base="xsd:integer">
    <xsd:enumeration value="21"/>
    <xsd:enumeration value="22"/>
  </xsd:restriction>
</xsd:simpleType>

```

13.5.236.93 Validity Direction

13.5.236.93.1 Validity Direction Structure

```

<xsd:complexType name="Attr_VD_ENUM">
  <!-- Validity Direction -->
  <xsd:sequence>
    <xsd:element name="value" type="Attr_VD_ENM_value"/>
    <xsd:element name="name" type="Attr_VD_ENM_name" minOccurs="0"/>
  </xsd:sequence>
</xsd:complexType>

```

13.5.236.93.2 Validity Direction Name

```

<xsd:simpleType name="Attr_VD_ENM_name">
  <xsd:restriction base="xsd:string">

```

```
        <xsd:enumeration value="Same direction"/>
        <xsd:enumeration value="Opposite direction"/>
    </xsd:restriction>
</xsd:simpleType>
```

13.5.236.93.3 Validity Direction Value

```
<xsd:simpleType name="Attr_VD_ENM_value">
  <xsd:restriction base="xsd:integer">
    <xsd:enumeration value="1"/>
    <xsd:enumeration value="2"/>
  </xsd:restriction>
</xsd:simpleType>
```

13.5.236.94 Vehicle Type

13.5.236.94.1 icle Type Structure

```
<xsd:complexType name="Attr_VT_CODE">
  <!-- Vehicle Type -->
  <xsd:sequence>
    <xsd:element name="value" type="Attr_VT_COD_value"/>
    <xsd:element name="name" type="Attr_VT_COD_name" minOccurs="0"/>
  </xsd:sequence>
</xsd:complexType>
```

13.5.236.94.2 Vehicle Type Name

```
<xsd:simpleType name="Attr_VT_COD_name">
  <xsd:restriction base="xsd:string">
    <xsd:enumeration value="All Vehicles"/>
    <xsd:enumeration value="Passenger Cars"/>
    <xsd:enumeration value="Residential Vehicle"/>
    <xsd:enumeration value="High Occupancy Vehicle"/>
    <xsd:enumeration value="Car with Trailer"/>
    <xsd:enumeration value="Emergency Vehicle"/>
    <xsd:enumeration value="Taxi"/>
    <xsd:enumeration value="Public Bus"/>
    <xsd:enumeration value="Private Bus"/>
    <xsd:enumeration value="Military vehicle"/>
    <xsd:enumeration value="Delivery Truck"/>
    <xsd:enumeration value="Transport Truck"/>
    <xsd:enumeration value="Motorcycle"/>
    <xsd:enumeration value="Moped"/>
    <xsd:enumeration value="Bicycle"/>
    <xsd:enumeration value="Pedestrian"/>
    <xsd:enumeration value="Farm Vehicle"/>
    <xsd:enumeration value="Vehicle with water polluting load"/>
    <xsd:enumeration value="Vehicle with explosive load"/>
    <xsd:enumeration value="Vehicle with other dangerous load"/>
    <xsd:enumeration value="Trolley Bus"/>
    <xsd:enumeration value="Employee Vehicle"/>
    <xsd:enumeration value="Light Rail"/>
    <xsd:enumeration value="Facility Vehicle"/>
    <xsd:enumeration value="School Bus"/>
    <xsd:enumeration value="4 Wheel Drive Vehicle"/>
    <xsd:enumeration value="Vehicle carrying snow chains"/>
    <xsd:enumeration value="Mail Vehicle"/>
    <xsd:enumeration value="Tanker"/>
    <xsd:enumeration value="Vehicle for disabled persons"/>
    <xsd:enumeration value="Snowmobile"/>
  </xsd:restriction>
</xsd:simpleType>
```

13.5.236.94.3 Vehicle Type Value

```
<xsd:simpleType name="Attr_VT_COD_value">
  <xsd:restriction base="xsd:integer">
    <xsd:enumeration value="0"/>
    <xsd:enumeration value="11"/>
    <xsd:enumeration value="12"/>
  </xsd:restriction>
</xsd:simpleType>
```



```

<xsd:enumeration value="13"/>
<xsd:enumeration value="14"/>
<xsd:enumeration value="15"/>
<xsd:enumeration value="16"/>
<xsd:enumeration value="17"/>
<xsd:enumeration value="18"/>
<xsd:enumeration value="19"/>
<xsd:enumeration value="20"/>
<xsd:enumeration value="21"/>
<xsd:enumeration value="22"/>
<xsd:enumeration value="23"/>
<xsd:enumeration value="24"/>
<xsd:enumeration value="25"/>
<xsd:enumeration value="26"/>
<xsd:enumeration value="28"/>
<xsd:enumeration value="29"/>
<xsd:enumeration value="30"/>
<xsd:enumeration value="31"/>
<xsd:enumeration value="32"/>
<xsd:enumeration value="33"/>
<xsd:enumeration value="34"/>
<xsd:enumeration value="35"/>
<xsd:enumeration value="36"/>
<xsd:enumeration value="37"/>
<xsd:enumeration value="38"/>
<xsd:enumeration value="39"/>
<xsd:enumeration value="40"/>
<xsd:enumeration value="41"/>
</xsd:restriction>
</xsd:simpleType>

```

13.5.236.95 Water Boundary Element Type

13.5.236.95.1 Water Boundary Element Type Structure

```

<xsd:complexType name="Attr_WB_CODE">
<!-- Water Boundary Element Type -->
  <xsd:sequence>
    <xsd:element name="value" type="Attr_WB_COD_value"/>
    <xsd:element name="name" type="Attr_WB_COD_name" minOccurs="0"/>
  </xsd:sequence>
</xsd:complexType>

```

13.5.236.95.2 Water Boundary Element Type Name

```

<xsd:simpleType name="Attr_WB_COD_name">
  <xsd:restriction base="xsd:string">
    <xsd:enumeration value="Ocean or Sea shore line"/>
    <xsd:enumeration value="Lake shore line"/>
    <xsd:enumeration value="River side"/>
    <xsd:enumeration value="Canal side"/>
    <xsd:enumeration value="Wetland side"/>
    <xsd:enumeration value="Harbour side"/>
    <xsd:enumeration value="Water side of Pier or Dock"/>
    <xsd:enumeration value="Bay side"/>
    <xsd:enumeration value="Others"/>
  </xsd:restriction>
</xsd:simpleType>

```

13.5.236.95.3 Water Boundary Element Type Value

```

<xsd:simpleType name="Attr_WB_COD_value">
  <xsd:restriction base="xsd:integer">
    <xsd:enumeration value="1"/>
    <xsd:enumeration value="2"/>
    <xsd:enumeration value="3"/>
    <xsd:enumeration value="4"/>
    <xsd:enumeration value="5"/>
    <xsd:enumeration value="6"/>
    <xsd:enumeration value="7"/>
    <xsd:enumeration value="8"/>
    <xsd:enumeration value="99"/>
  </xsd:restriction>

```

```
</xsd:simpleType>
```

13.5.236.96 Water Body Type

13.5.236.96.1 Water Body Typ Structure

```
<xsd:complexType name="Attr_WT_CODE">  
<!-- Water Body Type -->  
  <xsd:sequence>  
    <xsd:element name="value" type="Attr_WT_COD_value"/>  
    <xsd:element name="name" type="Attr_WT_COD_name" minOccurs="0"/>  
  </xsd:sequence>  
</xsd:complexType>
```

13.5.236.96.2 Water Body Type Name

```
<xsd:simpleType name="Attr_WT_COD_name">  
  <xsd:restriction base="xsd:string">  
    <xsd:enumeration value="Harbour/Port"/>  
    <xsd:enumeration value="Bay"/>  
    <xsd:enumeration value="Marina"/>  
    <xsd:enumeration value="Unspecified"/>  
  </xsd:restriction>  
</xsd:simpleType>
```

13.5.236.96.3 Water Body Type Value

```
<xsd:simpleType name="Attr_WT_COD_value">  
  <xsd:restriction base="xsd:integer">  
    <xsd:enumeration value="6"/>  
    <xsd:enumeration value="8"/>  
    <xsd:enumeration value="9"/>  
    <xsd:enumeration value="99"/>  
  </xsd:restriction>  
</xsd:simpleType>
```

13.5.237 Relationship Role Code Lists

13.5.237.1 Road Element Associated with Administrative Area

13.5.237.1.1 Road Element Associated with Administrative Area Structure

```
<xsd:complexType name="Rel_1001_ROLE">  
  <!-- Road Element Associated with Administrative Area -->  
  <xsd:sequence>  
    <xsd:element name="value" type="Rel_1001_ROLE_value"/>  
    <xsd:element name="name" type="Rel_1001_ROLE_name" minOccurs="0"/>  
  </xsd:sequence>  
</xsd:complexType>
```

13.5.237.1.2 Road Element Associated with Administrative Area Name

```
<xsd:simpleType name="Rel_1001_ROLE_name">  
  <xsd:restriction base="xsd:string">  
    <xsd:enumeration value="Order-8 Area"/>  
    <xsd:enumeration value="Road Element"/>  
  </xsd:restriction>  
</xsd:simpleType>
```

13.5.237.1.3 Road Element Associated with Administrative Area Value

```
<xsd:simpleType name="Rel_1001_ROLE_value">  
  <xsd:restriction base="xsd:integer">  
    <xsd:enumeration value="1"/>  
    <xsd:enumeration value="2"/>  
  </xsd:restriction>  
</xsd:simpleType>
```

13.5.237.2 Junction Associated with Administrative Area

13.5.237.2.1 Junction Associated with Administrative Area Structure

```

<xsd:complexType name="Rel_1002_ROLE">
  <!-- Junction Associated with Administrative Area -->
  <xsd:sequence>
    <xsd:element name="value" type="Rel_1002_ROLE_value"/>
    <xsd:element name="name" type="Rel_1002_ROLE_name" minOccurs="0"/>
  </xsd:sequence>
</xsd:complexType>

```

13.5.237.2.2 Junction Associated with Administrative Area Name

```

<xsd:simpleType name="Rel_1002_ROLE_name">
  <xsd:restriction base="xsd:string">
    <xsd:enumeration value="Order-8 Area"/>
    <xsd:enumeration value="Junction"/>
  </xsd:restriction>
</xsd:simpleType>

```

13.5.237.2.3 Junction Associated with Administrative Area Value

```

<xsd:simpleType name="Rel_1002_ROLE_value">
  <xsd:restriction base="xsd:integer">
    <xsd:enumeration value="1"/>
    <xsd:enumeration value="2"/>
  </xsd:restriction>
</xsd:simpleType>

```

13.5.237.3 Road Element Associated with Named Area

13.5.237.3.1 Road Element Associated with Named Area Structure

```

<xsd:complexType name="Rel_1003_ROLE">
  <!-- Road Element Associated with Named Area -->
  <xsd:sequence>
    <xsd:element name="value" type="Rel_1003_ROLE_value"/>
    <xsd:element name="name" type="Rel_1003_ROLE_name" minOccurs="0"/>
  </xsd:sequence>
</xsd:complexType>

```

13.5.237.3.2 Road Element Associated with Named Area Name

```

<xsd:simpleType name="Rel_1003_ROLE_name">
  <xsd:restriction base="xsd:string">
    <xsd:enumeration value="Named Area"/>
    <xsd:enumeration value="Road Element"/>
  </xsd:restriction>
</xsd:simpleType>

```

13.5.237.3.3 Road Element Associated with Named Area Value

```

<xsd:simpleType name="Rel_1003_ROLE_value">
  <xsd:restriction base="xsd:integer">
    <xsd:enumeration value="1"/>
    <xsd:enumeration value="2"/>
  </xsd:restriction>
</xsd:simpleType>

```

13.5.237.4 Building Associated with Administrative Area

13.5.237.4.1 Building Associated with Administrative Area Structure

```

<xsd:complexType name="Rel_1005_ROLE">
  <!-- Building Associated with Administrative Area -->
  <xsd:sequence>

```

```
<xsd:element name="value" type="Rel_1005_ROLE_value" />
<xsd:element name="name" type="Rel_1005_ROLE_name" minOccurs="0"/>
</xsd:sequence>
</xsd:complexType>
```

13.5.237.4.2 Building Associated with Administrative Area Name

```
<xsd:simpleType name="Rel_1005_ROLE_name">
  <xsd:restriction base="xsd:string">
    <xsd:enumeration value="Order-8 Area"/>
    <xsd:enumeration value="Building Feature"/>
  </xsd:restriction>
</xsd:simpleType>
```

13.5.237.4.3 Building Associated with Administrative Area Value

```
<xsd:simpleType name="Rel_1005_ROLE_value">
  <xsd:restriction base="xsd:integer">
    <xsd:enumeration value="1"/>
    <xsd:enumeration value="2"/>
  </xsd:restriction>
</xsd:simpleType>
```

13.5.237.5 Service Associated with Administrative Area

13.5.237.5.1 Service Associated with Administrative Area Structure

```
<xsd:complexType name="Rel_1006_ROLE">
<!-- Service Associated with Administrative Area -->
  <xsd:sequence>
    <xsd:element name="value" type="Rel_1006_ROLE_value" />
    <xsd:element name="name" type="Rel_1006_ROLE_name" minOccurs="0"/>
  </xsd:sequence>
</xsd:complexType>
```

13.5.237.5.2 Service Associated with Administrative Area Name

```
<xsd:simpleType name="Rel_1006_ROLE_name">
  <xsd:restriction base="xsd:string">
    <xsd:enumeration value="Order-8 Area"/>
    <xsd:enumeration value="Service"/>
  </xsd:restriction>
</xsd:simpleType>
```

13.5.237.5.3 Service Associated with Administrative Area Value

```
<xsd:simpleType name="Rel_1006_ROLE_value">
  <xsd:restriction base="xsd:integer">
    <xsd:enumeration value="1"/>
    <xsd:enumeration value="2"/>
  </xsd:restriction>
</xsd:simpleType>
```

13.5.237.6 Built-up Area Associated with Administrative Area

13.5.237.6.1 Built-up Area Associated with Administrative Area Structure

```
<xsd:complexType name="Rel_1007_ROLE">
<!-- Build-up Area Associated with Administrative Area -->
  <xsd:sequence>
    <xsd:element name="value" type="Rel_1007_ROLE_value" />
    <xsd:element name="name" type="Rel_1007_ROLE_name" minOccurs="0"/>
  </xsd:sequence>
</xsd:complexType>
```

13.5.237.6.2 Built-up Area Associated with Administrative Area Name

```
<xsd:simpleType name="Rel_1007_ROLE_name">
```

```

    <xsd:restriction base="xsd:string">
      <xsd:enumeration value="Order-8 Area"/>
      <xsd:enumeration value="Built-up Area"/>
    </xsd:restriction>
  </xsd:simpleType>

```

13.5.237.6.3 Built-up Area Associated with Administrative Area Value

```

<xsd:simpleType name="Rel_1007_ROLE_value">
  <xsd:restriction base="xsd:integer">
    <xsd:enumeration value="1"/>
    <xsd:enumeration value="2"/>
  </xsd:restriction>
</xsd:simpleType>

```

13.5.237.7 Ferry Connection Associated with Administrative Area

13.5.237.7.1 Ferry Connection Associated with Administrative Area Structure

```

<xsd:complexType name="Rel_1008_ROLE">
  <!-- Ferry Connection Associated with Administrative Area -->
  <xsd:sequence>
    <xsd:element name="value" type="Rel_1008_ROLE_value"/>
    <xsd:element name="name" type="Rel_1008_ROLE_name" minOccurs="0"/>
  </xsd:sequence>
</xsd:complexType>

```

13.5.237.7.2 Ferry Connection Associated with Administrative Area Name

```

<xsd:simpleType name="Rel_1008_ROLE_name">
  <xsd:restriction base="xsd:string">
    <xsd:enumeration value="Order-8 Area"/>
    <xsd:enumeration value="Ferry Connection"/>
  </xsd:restriction>
</xsd:simpleType>

```

13.5.237.7.3 Ferry Connection Associated with Administrative Area Value

```

<xsd:simpleType name="Rel_1008_ROLE_value">
  <xsd:restriction base="xsd:integer">
    <xsd:enumeration value="1"/>
    <xsd:enumeration value="2"/>
  </xsd:restriction>
</xsd:simpleType>

```

13.5.237.8 District Associated with Administrative Area

13.5.237.8.1 District Associated with Administrative Area Structure

```

<xsd:complexType name="Rel_1009_ROLE">
  <!-- District Associated with Administrative Area -->
  <xsd:sequence>
    <xsd:element name="value" type="Rel_1009_ROLE_value"/>
    <xsd:element name="name" type="Rel_1009_ROLE_name" minOccurs="0"/>
  </xsd:sequence>
</xsd:complexType>

```

13.5.237.8.2 District Associated with Administrative Area Name

```

<xsd:simpleType name="Rel_1009_ROLE_name">
  <xsd:restriction base="xsd:string">
    <xsd:enumeration value="Order-8 Area"/>
    <xsd:enumeration value="District"/>
  </xsd:restriction>
</xsd:simpleType>

```

13.5.237.8.3 District Associated with Administrative Area Value

```
<xsd:simpleType name="Rel_1009_ROLE_value">  
  <xsd:restriction base="xsd:integer">  
    <xsd:enumeration value="1"/>  
    <xsd:enumeration value="2"/>  
  </xsd:restriction>  
</xsd:simpleType>
```

13.5.237.9 Enclosed Traffic Area Associated with Administrative Area

13.5.237.9.1 Enclosed Traffic Area Associated with Administrative Area Structure

```
<xsd:complexType name="Rel_1010_ROLE">  
<!-- Enclosed Traffic Area Associated with Administrative Area -->  
  <xsd:sequence>  
    <xsd:element name="value" type="Rel_1010_ROLE_value"/>  
    <xsd:element name="name" type="Rel_1010_ROLE_name" minOccurs="0"/>  
  </xsd:sequence>  
</xsd:complexType>
```

13.5.237.9.2 Enclosed Traffic Area Associated with Administrative Area Name

```
<xsd:simpleType name="Rel_1010_ROLE_name">  
  <xsd:restriction base="xsd:string">  
    <xsd:enumeration value="Order-8 Area"/>  
    <xsd:enumeration value="Enclosed Traffic Area"/>  
  </xsd:restriction>  
</xsd:simpleType>
```

13.5.237.9.3 Enclosed Traffic Area Associated with Administrative Area Value

```
<xsd:simpleType name="Rel_1010_ROLE_value">  
  <xsd:restriction base="xsd:integer">  
    <xsd:enumeration value="1"/>  
    <xsd:enumeration value="2"/>  
  </xsd:restriction>  
</xsd:simpleType>
```

13.5.237.10 Road Element Associated with Built-up Area

13.5.237.10.1 Road Element Associated with Built-up Area Structure

```
<xsd:complexType name="Rel_1011_ROLE">  
<!-- Road Element Associated with Built-up Area -->  
  <xsd:sequence>  
    <xsd:element name="value" type="Rel_1011_ROLE_value"/>  
    <xsd:element name="name" type="Rel_1011_ROLE_name" minOccurs="0"/>  
  </xsd:sequence>  
</xsd:complexType>
```

13.5.237.10.2 Road Element Associated with Built-up Area Name

```
<xsd:simpleType name="Rel_1011_ROLE_name">  
  <xsd:restriction base="xsd:string">  
    <xsd:enumeration value="Built-up Area"/>  
    <xsd:enumeration value="Road Element"/>  
  </xsd:restriction>  
</xsd:simpleType>
```

13.5.237.10.3 Road Element Associated with Built-up Area Value

```
<xsd:simpleType name="Rel_1011_ROLE_value">  
  <xsd:restriction base="xsd:integer">  
    <xsd:enumeration value="1"/>  
    <xsd:enumeration value="2"/>  
  </xsd:restriction>  
</xsd:simpleType>
```

13.5.237.11 Junction Associated with Built-up Area

13.5.237.11.1 Junction Associated with Built-up Area Structure

```

<xsd:complexType name="Rel_1012_ROLE">
  <!-- Junction Associated with Built-up Area -->
  <xsd:sequence>
    <xsd:element name="value" type="Rel_1012_ROLE_value"/>
    <xsd:element name="name" type="Rel_1012_ROLE_name" minOccurs="0"/>
  </xsd:sequence>
</xsd:complexType>

```

13.5.237.11.2 Junction Associated with Built-up Area Name

```

<xsd:simpleType name="Rel_1012_ROLE_name">
  <xsd:restriction base="xsd:string">
    <xsd:enumeration value="Built-up Area"/>
    <xsd:enumeration value="Junction"/>
  </xsd:restriction>
</xsd:simpleType>

```

13.5.237.11.3 Junction Associated with Built-up Area Value

```

<xsd:simpleType name="Rel_1012_ROLE_value">
  <xsd:restriction base="xsd:integer">
    <xsd:enumeration value="1"/>
    <xsd:enumeration value="2"/>
  </xsd:restriction>
</xsd:simpleType>

```

13.5.237.12 Ferry Connection Associated with Named Area

13.5.237.12.1 Ferry Connection Associated with Named Area Structure

```

<xsd:complexType name="Rel_1013_ROLE">
  <!-- Ferry Connection Associated with Named Area -->
  <xsd:sequence>
    <xsd:element name="value" type="Rel_1013_ROLE_value"/>
    <xsd:element name="name" type="Rel_1013_ROLE_name" minOccurs="0"/>
  </xsd:sequence>
</xsd:complexType>

```

13.5.237.12.2 Ferry Connection Associated with Named Area Name

```

<xsd:simpleType name="Rel_1013_ROLE_name">
  <xsd:restriction base="xsd:string">
    <xsd:enumeration value="Named Area"/>
    <xsd:enumeration value="Ferry Connection"/>
  </xsd:restriction>
</xsd:simpleType>

```

13.5.237.12.3 Ferry Connection Associated with Named Area Value

```

<xsd:simpleType name="Rel_1013_ROLE_value">
  <xsd:restriction base="xsd:integer">
    <xsd:enumeration value="1"/>
    <xsd:enumeration value="2"/>
  </xsd:restriction>
</xsd:simpleType>

```

13.5.237.13 Service Associated with Named Area

13.5.237.13.1 Service Associated with Named Area Structure

```

<xsd:complexType name="Rel_1014_ROLE">
  <!-- Service Associated with Named Area -->
  <xsd:sequence>
    <xsd:element name="value" type="Rel_1014_ROLE_value"/>
  </xsd:sequence>
</xsd:complexType>

```

```
        <xsd:element name="name" type="Rel_1014_ROLE_name" minOccurs="0"/>
    </xsd:sequence>
</xsd:complexType>
```

13.5.237.13.2 Service Associated with Named Area Name

```
<xsd:simpleType name="Rel_1014_ROLE_name">
  <xsd:restriction base="xsd:string">
    <xsd:enumeration value="Named Area"/>
    <xsd:enumeration value="Service"/>
  </xsd:restriction>
</xsd:simpleType>
```

13.5.237.13.3 Service Associated with Named Area Value

```
<xsd:simpleType name="Rel_1014_ROLE_value">
  <xsd:restriction base="xsd:integer">
    <xsd:enumeration value="1"/>
    <xsd:enumeration value="2"/>
  </xsd:restriction>
</xsd:simpleType>
```

13.5.237.14 Building Associated with Built-up Area

13.5.237.14.1 Building Associated with Built-up Area Structure

```
<xsd:complexType name="Rel_1015_ROLE">
  <!-- Building Associated with Built-up Area -->
  <xsd:sequence>
    <xsd:element name="value" type="Rel_1015_ROLE_value"/>
    <xsd:element name="name" type="Rel_1015_ROLE_name" minOccurs="0"/>
  </xsd:sequence>
</xsd:complexType>
```

13.5.237.14.2 Building Associated with Built-up Area Name

```
<xsd:simpleType name="Rel_1015_ROLE_name">
  <xsd:restriction base="xsd:string">
    <xsd:enumeration value="Built-up Area"/>
    <xsd:enumeration value="Building Feature"/>
  </xsd:restriction>
</xsd:simpleType>
```

13.5.237.14.3 Building Associated with Built-up Area Value

```
<xsd:simpleType name="Rel_1015_ROLE_value">
  <xsd:restriction base="xsd:integer">
    <xsd:enumeration value="1"/>
    <xsd:enumeration value="2"/>
  </xsd:restriction>
</xsd:simpleType>
```

13.5.237.15 Service Associated with Built-up Area

13.5.237.15.1 Service Associated with Built-up Area Structure

```
<xsd:complexType name="Rel_1016_ROLE">
  <!-- Service Associated with Built-up Area -->
  <xsd:sequence>
    <xsd:element name="value" type="Rel_1016_ROLE_value"/>
    <xsd:element name="name" type="Rel_1016_ROLE_name" minOccurs="0"/>
  </xsd:sequence>
</xsd:complexType>
```

13.5.237.15.2 Service Associated with Built-up Area Name

```
<xsd:simpleType name="Rel_1016_ROLE_name">
  <xsd:restriction base="xsd:string">
    <xsd:enumeration value="Built-up Area"/>
  </xsd:restriction>
</xsd:simpleType>
```



```

        <xsd:enumeration value="Service"/>
    </xsd:restriction>
</xsd:simpleType>

```

13.5.237.15.3 Service Associated with Built-up Area Value

```

<xsd:simpleType name="Rel_1016_ROLE_value">
    <xsd:restriction base="xsd:integer">
        <xsd:enumeration value="1"/>
        <xsd:enumeration value="2"/>
    </xsd:restriction>
</xsd:simpleType>

```

13.5.237.16 Enclosed Traffic Area Associated with Built-up Area

13.5.237.16.1 Enclosed Traffic Area Associated with Built-up Area Structure

```

<xsd:complexType name="Rel_1017_ROLE">
<!-- Enclosed Traffic Area Associated with Built-up Area -->
    <xsd:sequence>
        <xsd:element name="value" type="Rel_1017_ROLE_value"/>
        <xsd:element name="name" type="Rel_1017_ROLE_name" minOccurs="0"/>
    </xsd:sequence>
</xsd:complexType>

```

13.5.237.16.2 Enclosed Traffic Area Associated with Built-up Area Name

```

<xsd:simpleType name="Rel_1017_ROLE_name">
    <xsd:restriction base="xsd:string">
        <xsd:enumeration value="Built-up Area"/>
        <xsd:enumeration value="Enclosed Traffic Area"/>
    </xsd:restriction>
</xsd:simpleType>

```

13.5.237.16.3 Enclosed Traffic Area Associated with Built-up Area Value

```

<xsd:simpleType name="Rel_1017_ROLE_value">
    <xsd:restriction base="xsd:integer">
        <xsd:enumeration value="1"/>
        <xsd:enumeration value="2"/>
    </xsd:restriction>
</xsd:simpleType>

```

13.5.237.17 District Associated with Built-up Area

13.5.237.17.1 District Associated with Built-up Area Structure

```

<xsd:complexType name="Rel_1018_ROLE">
<!-- District Associated with Built-up Area -->
    <xsd:sequence>
        <xsd:element name="value" type="Rel_1018_ROLE_value"/>
        <xsd:element name="name" type="Rel_1018_ROLE_name" minOccurs="0"/>
    </xsd:sequence>
</xsd:complexType>

```

13.5.237.17.2 District Associated with Built-up Area Name

```

<xsd:simpleType name="Rel_1018_ROLE_name">
    <xsd:restriction base="xsd:string">
        <xsd:enumeration value="Built-up Area"/>
        <xsd:enumeration value="District"/>
    </xsd:restriction>
</xsd:simpleType>

```

13.5.237.17.3 District Associated with Built-up Area Value

```

<xsd:simpleType name="Rel_1018_ROLE_value">
    <xsd:restriction base="xsd:integer">
        <xsd:enumeration value="1"/>
        <xsd:enumeration value="2"/>
    </xsd:restriction>
</xsd:simpleType>

```

```
</xsd:restriction>  
</xsd:simpleType>
```

13.5.237.18 Road Element Associated with District

13.5.237.18.1 Road Element Associated with District Structure

```
<xsd:complexType name="Rel_1019_ROLE">  
<!-- Road Element Associated with District -->  
  <xsd:sequence>  
    <xsd:element name="value" type="Rel_1019_ROLE_value"/>  
    <xsd:element name="name" type="Rel_1019_ROLE_name" minOccurs="0"/>  
  </xsd:sequence>  
</xsd:complexType>
```

13.5.237.18.2 Road Element Associated with District Name

```
<xsd:simpleType name="Rel_1019_ROLE_name">  
  <xsd:restriction base="xsd:string">  
    <xsd:enumeration value="District"/>  
    <xsd:enumeration value="Road Element"/>  
  </xsd:restriction>  
</xsd:simpleType>
```

13.5.237.18.3 Road Element Associated with District Value

```
<xsd:simpleType name="Rel_1019_ROLE_value">  
  <xsd:restriction base="xsd:integer">  
    <xsd:enumeration value="1"/>  
    <xsd:enumeration value="2"/>  
  </xsd:restriction>  
</xsd:simpleType>
```

13.5.237.19 Ferry Connection Associated with Built-up Area

13.5.237.19.1 Ferry Connection Associated with Built-up Area Structure

```
<xsd:complexType name="Rel_1020_ROLE">  
<!-- Ferry Connection Associated with Built-up Area -->  
  <xsd:sequence>  
    <xsd:element name="value" type="Rel_1020_ROLE_value"/>  
    <xsd:element name="name" type="Rel_1020_ROLE_name" minOccurs="0"/>  
  </xsd:sequence>  
</xsd:complexType>
```

13.5.237.19.2 Ferry Connection Associated with Built-up Area Name

```
<xsd:simpleType name="Rel_1020_ROLE_name">  
  <xsd:restriction base="xsd:string">  
    <xsd:enumeration value="District"/>  
    <xsd:enumeration value="Road Element"/>  
  </xsd:restriction>  
</xsd:simpleType>
```

13.5.237.19.3 Ferry Connection Associated with Built-up Area Value

```
<xsd:simpleType name="Rel_1020_ROLE_value">  
  <xsd:restriction base="xsd:integer">  
    <xsd:enumeration value="1"/>  
    <xsd:enumeration value="2"/>  
  </xsd:restriction>  
</xsd:simpleType>
```

13.5.237.20 Building along Road Element

13.5.237.20.1 Building along Road Element Structure

```

<xsd:complexType name="Rel_1021_ROLE">
  <!-- Building along Road Element -->
  <xsd:sequence>
    <xsd:element name="value" type="Rel_1021_ROLE_value"/>
    <xsd:element name="name" type="Rel_1021_ROLE_name" minOccurs="0"/>
  </xsd:sequence>
</xsd:complexType>

```

13.5.237.20.2 Building along Road Element Name

```

<xsd:simpleType name="Rel_1021_ROLE_name">
  <xsd:restriction base="xsd:string">
    <xsd:enumeration value="Road Element"/>
    <xsd:enumeration value="Building Feature"/>
  </xsd:restriction>
</xsd:simpleType>

```

13.5.237.20.3 Building along Road Element Value

```

<xsd:simpleType name="Rel_1021_ROLE_value">
  <xsd:restriction base="xsd:integer">
    <xsd:enumeration value="1"/>
    <xsd:enumeration value="2"/>
  </xsd:restriction>
</xsd:simpleType>

```

13.5.237.21 Service along Road Element

13.5.237.21.1 Service along Road Element Structure

```

<xsd:complexType name="Rel_1022_ROLE">
  <!-- Service along Road Element -->
  <xsd:sequence>
    <xsd:element name="value" type="Rel_1022_ROLE_value"/>
    <xsd:element name="name" type="Rel_1022_ROLE_name" minOccurs="0"/>
  </xsd:sequence>
</xsd:complexType>

```

13.5.237.21.2 Service along Road Element Name

```

<xsd:simpleType name="Rel_1022_ROLE_name">
  <xsd:restriction base="xsd:string">
    <xsd:enumeration value="Road Element"/>
    <xsd:enumeration value="Service"/>
  </xsd:restriction>
</xsd:simpleType>

```

13.5.237.21.3 Service along Road Element Value

```

<xsd:simpleType name="Rel_1022_ROLE_value">
  <xsd:restriction base="xsd:integer">
    <xsd:enumeration value="1"/>
    <xsd:enumeration value="2"/>
  </xsd:restriction>
</xsd:simpleType>

```

13.5.237.22 Service along Road

13.5.237.22.1 Service along Road Structure

```

<xsd:complexType name="Rel_1023_ROLE">
  <!-- Service along Road -->
  <xsd:sequence>
    <xsd:element name="value" type="Rel_1023_ROLE_value"/>

```

```
<xsd:element name="name" type="Rel_1023_ROLE_name" minOccurs="0"/>
</xsd:sequence>
</xsd:complexType>
```

13.5.237.22.2 Service along Road Name

```
<xsd:simpleType name="Rel_1023_ROLE_name">
  <xsd:restriction base="xsd:string">
    <xsd:enumeration value="Road"/>
    <xsd:enumeration value="Service"/>
  </xsd:restriction>
</xsd:simpleType>
```

13.5.237.22.3 Service along Road Value

```
<xsd:simpleType name="Rel_1023_ROLE_value">
  <xsd:restriction base="xsd:integer">
    <xsd:enumeration value="1"/>
    <xsd:enumeration value="2"/>
  </xsd:restriction>
</xsd:simpleType>
```

13.5.237.23 Service at Junction

13.5.237.23.1 Service at Junction Structure

```
<xsd:complexType name="Rel_1024_ROLE">
  <!-- Service at Junction -->
  <xsd:sequence>
    <xsd:element name="value" type="Rel_1024_ROLE_value"/>
    <xsd:element name="name" type="Rel_1024_ROLE_name" minOccurs="0"/>
  </xsd:sequence>
</xsd:complexType>
```

13.5.237.23.2 Service at Junction Name

```
<xsd:simpleType name="Rel_1024_ROLE_name">
  <xsd:restriction base="xsd:string">
    <xsd:enumeration value="Junction"/>
    <xsd:enumeration value="Service"/>
  </xsd:restriction>
</xsd:simpleType>
```

13.5.237.23.3 Service at Junction Value

```
<xsd:simpleType name="Rel_1024_ROLE_value">
  <xsd:restriction base="xsd:integer">
    <xsd:enumeration value="1"/>
    <xsd:enumeration value="2"/>
  </xsd:restriction>
</xsd:simpleType>
```

13.5.237.24 Service at Intersection

13.5.237.24.1 Service at Intersection Structure

```
<xsd:complexType name="Rel_1025_ROLE">
  <!-- Service at Intersection -->
  <xsd:sequence>
    <xsd:element name="value" type="Rel_1025_ROLE_value"/>
    <xsd:element name="name" type="Rel_1025_ROLE_name" minOccurs="0"/>
  </xsd:sequence>
</xsd:complexType>
```

13.5.237.24.2 Service at Intersection Name

```
<xsd:simpleType name="Rel_1025_ROLE_name">
  <xsd:restriction base="xsd:string">
    <xsd:enumeration value="Intersection"/>
  </xsd:restriction>
</xsd:simpleType>
```

```

        <xsd:enumeration value="Service"/>
      </xsd:restriction>
    </xsd:simpleType>

```

13.5.237.24.3 Service at Intersection Value

```

<xsd:simpleType name="Rel_1025_ROLE_value">
  <xsd:restriction base="xsd:integer">
    <xsd:enumeration value="1"/>
    <xsd:enumeration value="2"/>
  </xsd:restriction>
</xsd:simpleType>

```

13.5.237.25 Service related to Service

13.5.237.25.1 Service related to Service Structure

```

<xsd:complexType name="Rel_1026_ROLE">
  <!-- Service related to Service -->
  <xsd:sequence>
    <xsd:element name="value" type="Rel_1026_ROLE_value"/>
    <xsd:element name="name" type="Rel_1026_ROLE_name" minOccurs="0"/>
  </xsd:sequence>
</xsd:complexType>

```

13.5.237.25.2 Service related to Service Name

```

<xsd:simpleType name="Rel_1026_ROLE_name">
  <xsd:restriction base="xsd:string">
    <xsd:enumeration value="Service"/>
    <xsd:enumeration value="Associated Service"/>
  </xsd:restriction>
</xsd:simpleType>

```

13.5.237.25.3 Service related to Service Value

```

<xsd:simpleType name="Rel_1026_ROLE_value">
  <xsd:restriction base="xsd:integer">
    <xsd:enumeration value="1"/>
    <xsd:enumeration value="2"/>
  </xsd:restriction>
</xsd:simpleType>

```

13.5.237.26 Road Element leading to Enclosed Traffic Area

13.5.237.26.1 Road Element leading to Enclosed Traffic Area Structure

```

<xsd:complexType name="Rel_1027_ROLE">
  <!-- Road Element leading to Enclosed Traffic Area -->
  <xsd:sequence>
    <xsd:element name="value" type="Rel_1027_ROLE_value"/>
    <xsd:element name="name" type="Rel_1027_ROLE_name" minOccurs="0"/>
  </xsd:sequence>
</xsd:complexType>

```

13.5.237.26.2 Road Element leading to Enclosed Traffic Area Name

```

<xsd:simpleType name="Rel_1027_ROLE_name">
  <xsd:restriction base="xsd:string">
    <xsd:enumeration value="Road Element"/>
    <xsd:enumeration value="Enclosed Traffic Area"/>
  </xsd:restriction>
</xsd:simpleType>

```

13.5.237.26.3 Road Element leading to Enclosed Traffic Area Value

```

<xsd:simpleType name="Rel_1027_ROLE_value">
  <xsd:restriction base="xsd:integer">
    <xsd:enumeration value="1"/>
  </xsd:restriction>
</xsd:simpleType>

```

```
        <xsd:enumeration value="2" />
    </xsd:restriction>
</xsd:simpleType>
```

13.5.237.27 Road Element belonging to Service

13.5.237.27.1 Road Element belonging to Service Structure

```
<xsd:complexType name="Rel_1028_ROLE">
<!-- Road Element belonging to Service -->
  <xsd:sequence>
    <xsd:element name="value" type="Rel_1028_ROLE_value" />
    <xsd:element name="name" type="Rel_1028_ROLE_name" minOccurs="0" />
  </xsd:sequence>
</xsd:complexType>
```

13.5.237.27.2 Road Element belonging to Service Name

```
<xsd:simpleType name="Rel_1028_ROLE_name">
  <xsd:restriction base="xsd:string">
    <xsd:enumeration value="Road Element" />
    <xsd:enumeration value="Service" />
  </xsd:restriction>
</xsd:simpleType>
```

13.5.237.27.3 Road Element belonging to Service Value

```
<xsd:simpleType name="Rel_1028_ROLE_value">
  <xsd:restriction base="xsd:integer">
    <xsd:enumeration value="1" />
    <xsd:enumeration value="2" />
  </xsd:restriction>
</xsd:simpleType>
```

13.5.237.28 Centre Point of Feature belonging to Feature

13.5.237.28.1 Centre Point of Feature belonging to Feature Structure

```
<xsd:complexType name="Rel_1029_ROLE">
<!-- Centre Point of Feature belonging to Feature -->
  <xsd:sequence>
    <xsd:element name="value" type="Rel_1029_ROLE_value" />
    <xsd:element name="name" type="Rel_1029_ROLE_name" minOccurs="0" />
  </xsd:sequence>
</xsd:complexType>
```

13.5.237.28.2 Centre Point of Feature belonging to Feature Name

```
<xsd:simpleType name="Rel_1029_ROLE_name">
  <xsd:restriction base="xsd:string">
    <xsd:enumeration value="Centre Point" />
    <xsd:enumeration value="Feature" />
  </xsd:restriction>
</xsd:simpleType>
```

13.5.237.28.3 Centre Point of Feature belonging to Feature Value

```
<xsd:simpleType name="Rel_1029_ROLE_value">
  <xsd:restriction base="xsd:integer">
    <xsd:enumeration value="1" />
    <xsd:enumeration value="2" />
  </xsd:restriction>
</xsd:simpleType>
```

13.5.237.29 Divided Junction

13.5.237.29.1 Divided Junction Structure

```

<xsd:complexType name="Rel_1030_ROLE">
  <!-- Divided Junction -->
  <xsd:sequence>
    <xsd:element name="value" type="Rel_1030_ROLE_value"/>
    <xsd:element name="name" type="Rel_1030_ROLE_name" minOccurs="0"/>
  </xsd:sequence>
</xsd:complexType>

```

13.5.237.29.2 Divided Junction Name

```

<xsd:simpleType name="Rel_1030_ROLE_name">
  <xsd:restriction base="xsd:string">
    <xsd:enumeration value="First Road Element"/>
    <xsd:enumeration value="Junction"/>
    <xsd:enumeration value="Second Road Element"/>
  </xsd:restriction>
</xsd:simpleType>

```

13.5.237.29.3 Divided Junction Value

```

<xsd:simpleType name="Rel_1030_ROLE_value">
  <xsd:restriction base="xsd:integer">
    <xsd:enumeration value="1"/>
    <xsd:enumeration value="2"/>
    <xsd:enumeration value="3"/>
  </xsd:restriction>
</xsd:simpleType>

```

13.5.237.30 Building associated with Service

13.5.237.30.1 Building associated with Service Structure

```

<xsd:complexType name="Rel_1040_ROLE">
  <!-- Building associated with Service -->
  <xsd:sequence>
    <xsd:element name="value" type="Rel_1040_ROLE_value"/>
    <xsd:element name="name" type="Rel_1040_ROLE_name" minOccurs="0"/>
  </xsd:sequence>
</xsd:complexType>

```

13.5.237.30.2 Building associated with Service Name

```

<xsd:simpleType name="Rel_1040_ROLE_name">
  <xsd:restriction base="xsd:string">
    <xsd:enumeration value="Service"/>
    <xsd:enumeration value="Building Feature"/>
  </xsd:restriction>
</xsd:simpleType>

```

13.5.237.30.3 Building associated with Service Value

```

<xsd:simpleType name="Rel_1040_ROLE_value">
  <xsd:restriction base="xsd:integer">
    <xsd:enumeration value="1"/>
    <xsd:enumeration value="2"/>
  </xsd:restriction>
</xsd:simpleType>

```

13.5.237.31 Building Façade associated with Building

13.5.237.31.1 Building Façade associated with Building Structure

```

<xsd:complexType name="Rel_1041_ROLE">
  <!-- Building Façade associated with Building -->

```

```
<xsd:sequence>
  <xsd:element name="value" type="Rel_1041_ROLE_value"/>
  <xsd:element name="name" type="Rel_1041_ROLE_name" minOccurs="0"/>
</xsd:sequence>
</xsd:complexType>
```

13.5.237.31.2 Building Façade associated with Building Name

```
<xsd:simpleType name="Rel_1041_ROLE_name">
  <xsd:restriction base="xsd:string">
    <xsd:enumeration value="Building Façade"/>
    <xsd:enumeration value="Building "/>
  </xsd:restriction>
</xsd:simpleType>
```

13.5.237.31.3 Building Façade associated with Building Value

```
<xsd:simpleType name="Rel_1041_ROLE_value">
  <xsd:restriction base="xsd:integer">
    <xsd:enumeration value="1"/>
    <xsd:enumeration value="2"/>
  </xsd:restriction>
</xsd:simpleType>
```

13.5.237.32 Building Unit associated with Building

13.5.237.32.1 Building Unit associated with Building Structure

```
<xsd:complexType name="Rel_1042_ROLE">
  <!-- Building Unit associated with Building -->
  <xsd:sequence>
    <xsd:element name="value" type="Rel_1042_ROLE_value"/>
    <xsd:element name="name" type="Rel_1042_ROLE_name" minOccurs="0"/>
  </xsd:sequence>
</xsd:complexType>
```

13.5.237.32.2 Building Unit associated with Building Name

```
<xsd:simpleType name="Rel_1042_ROLE_name">
  <xsd:restriction base="xsd:string">
    <xsd:enumeration value="Building Unit"/>
    <xsd:enumeration value="Building or Schematic Building"/>
  </xsd:restriction>
</xsd:simpleType>
```

13.5.237.32.3 Building Unit associated with Building Value

```
<xsd:simpleType name="Rel_1042_ROLE_value">
  <xsd:restriction base="xsd:integer">
    <xsd:enumeration value="1"/>
    <xsd:enumeration value="2"/>
  </xsd:restriction>
</xsd:simpleType>
```

13.5.237.33 Building Unit linked to Street

13.5.237.33.1 Building Unit linked to Street Structure

```
<xsd:complexType name="Rel_1043_ROLE">
  <!-- Building Unit linked to Street -->
  <xsd:sequence>
    <xsd:element name="value" type="Rel_1043_ROLE_value"/>
    <xsd:element name="name" type="Rel_1043_ROLE_name" minOccurs="0"/>
  </xsd:sequence>
</xsd:complexType>
```

13.5.237.33.2 Building Unit linked to Street Name

```
<xsd:simpleType name="Rel_1043_ROLE_name">
```



```

    <xsd:restriction base="xsd:string">
      <xsd:enumeration value="Street Feature"/>
      <xsd:enumeration value="Building Unit"/>
    </xsd:restriction>
  </xsd:simpleType>

```

13.5.237.33.3 Building Unit linked to Street Value

```

<xsd:simpleType name="Rel_1043_ROLE_value">
  <xsd:restriction base="xsd:integer">
    <xsd:enumeration value="1"/>
    <xsd:enumeration value="2"/>
  </xsd:restriction>
</xsd:simpleType>

```

13.5.237.34 Building related to Building

13.5.237.34.1 Building related to Building Structure

```

<xsd:complexType name="Rel_1044_ROLE">
  <!-- Building related to Building -->
  <xsd:sequence>
    <xsd:element name="value" type="Rel_1044_ROLE_value"/>
    <xsd:element name="name" type="Rel_1044_ROLE_name" minOccurs="0"/>
  </xsd:sequence>
</xsd:complexType>

```

13.5.237.34.2 Building related to Building Name

```

<xsd:simpleType name="Rel_1044_ROLE_name">
  <xsd:restriction base="xsd:string">
    <xsd:enumeration value="First Building"/>
    <xsd:enumeration value="Second Building"/>
  </xsd:restriction>
</xsd:simpleType>

```

13.5.237.34.3 Building related to Building Value

```

<xsd:simpleType name="Rel_1044_ROLE_value">
  <xsd:restriction base="xsd:integer">
    <xsd:enumeration value="1"/>
    <xsd:enumeration value="2"/>
  </xsd:restriction>
</xsd:simpleType>

```

13.5.237.35 Restricted Manoeuvre

13.5.237.35.1 Restricted Manoeuvre Structure

```

<xsd:complexType name="Rel_2102_ROLE">
  <!-- Restricted Manoeuvre -->
  <xsd:sequence>
    <xsd:element name="value" type="Rel_2102_ROLE_value"/>
    <xsd:element name="name" type="Rel_2102_ROLE_name" minOccurs="0"/>
  </xsd:sequence>
</xsd:complexType>

```

13.5.237.35.2 Restricted Manoeuvre Name

```

<xsd:simpleType name="Rel_2102_ROLE_name">
  <xsd:restriction base="xsd:string">
    <xsd:enumeration value="First Road Element"/>
    <xsd:enumeration value="Junction"/>
    <xsd:enumeration value="Second Road Element"/>
    <xsd:enumeration value="Subsequent Road Element"/>
    <xsd:enumeration value="Last Partner in Manoeuvre"/>
  </xsd:restriction>
</xsd:simpleType>

```

13.5.237.35.3 Restricted Manoeuvre Value

```
<xsd:simpleType name="Rel_2102_ROLE_value">  
  <xsd:restriction base="xsd:integer">  
    <xsd:enumeration value="1"/>  
    <xsd:enumeration value="2"/>  
    <xsd:enumeration value="3"/>  
    <xsd:enumeration value="4"/>  
    <xsd:enumeration value="5"/>  
  </xsd:restriction>  
</xsd:simpleType>
```

13.5.237.36 Prohibited Manoeuvre

13.5.237.36.1 Prohibited Manoeuvre Structure

```
<xsd:complexType name="Rel_2103_ROLE">  
<!-- Prohibited Manoeuvre -->  
  <xsd:sequence>  
    <xsd:element name="value" type="Rel_2103_ROLE_value"/>  
    <xsd:element name="name" type="Rel_2103_ROLE_name" minOccurs="0"/>  
  </xsd:sequence>  
</xsd:complexType>
```

13.5.237.36.2 Prohibited Manoeuvre Name

```
<xsd:simpleType name="Rel_2103_ROLE_name">  
  <xsd:restriction base="xsd:string">  
    <xsd:enumeration value="First Road Element"/>  
    <xsd:enumeration value="Junction"/>  
    <xsd:enumeration value="Second Road Element"/>  
    <xsd:enumeration value="Subsequent Road Element"/>  
    <xsd:enumeration value="Last Partner in Manoeuvre"/>  
  </xsd:restriction>  
</xsd:simpleType>
```

13.5.237.36.3 Prohibited Manoeuvre Value

```
<xsd:simpleType name="Rel_2103_ROLE_value">  
  <xsd:restriction base="xsd:integer">  
    <xsd:enumeration value="1"/>  
    <xsd:enumeration value="2"/>  
    <xsd:enumeration value="3"/>  
    <xsd:enumeration value="4"/>  
    <xsd:enumeration value="5"/>  
  </xsd:restriction>  
</xsd:simpleType>
```

13.5.237.37 Right of Way Regulation

13.5.237.37.1 Right of Way Regulation Structure

```
<xsd:complexType name="Rel_2104_ROLE">  
<!-- Right of Way Regulation -->  
  <xsd:sequence>  
    <xsd:element name="value" type="Rel_2104_ROLE_value"/>  
    <xsd:element name="name" type="Rel_2104_ROLE_name" minOccurs="0"/>  
  </xsd:sequence>  
</xsd:complexType>
```

13.5.237.37.2 Right of Way Regulation Name

```
<xsd:simpleType name="Rel_2104_ROLE_name">  
  <xsd:restriction base="xsd:string">  
    <xsd:enumeration value="First Road Element"/>  
    <xsd:enumeration value="Junction"/>  
    <xsd:enumeration value="Second Road Element"/>  
    <xsd:enumeration value="Subsequent Road Element"/>  
    <xsd:enumeration value="Traffic Sign"/>  
  </xsd:restriction>  
</xsd:simpleType>
```

```

    </xsd:restriction>
</xsd:simpleType>

```

13.5.237.37.3 Right of Way Regulation Value

```

<xsd:simpleType name="Rel_2104_ROLE_value">
  <xsd:restriction base="xsd:integer">
    <xsd:enumeration value="1"/>
    <xsd:enumeration value="2"/>
    <xsd:enumeration value="3"/>
    <xsd:enumeration value="4"/>
    <xsd:enumeration value="5"/>
  </xsd:restriction>
</xsd:simpleType>

```

13.5.237.38 Through Route

13.5.237.38.1 Through Route Structure

```

<xsd:complexType name="Rel_2105_ROLE">
<!-- Through Route -->
  <xsd:sequence>
    <xsd:element name="value" type="Rel_2105_ROLE_value"/>
    <xsd:element name="name" type="Rel_2105_ROLE_name" minOccurs="0"/>
  </xsd:sequence>
</xsd:complexType>

```

13.5.237.38.2 Through Route Name

```

<xsd:simpleType name="Rel_2105_ROLE_name">
  <xsd:restriction base="xsd:string">
    <xsd:enumeration value="First Road Element"/>
    <xsd:enumeration value="Continuing Road Element"/>
    <xsd:enumeration value="Subsequent Road Element"/>
  </xsd:restriction>
</xsd:simpleType>

```

13.5.237.38.3 Through Route Value

```

<xsd:simpleType name="Rel_2105_ROLE_value">
  <xsd:restriction base="xsd:integer">
    <xsd:enumeration value="1"/>
    <xsd:enumeration value="2"/>
    <xsd:enumeration value="3"/>
  </xsd:restriction>
</xsd:simpleType>

```

13.5.237.39 Fork

13.5.237.39.1 Fork Structure

```

<xsd:complexType name="Rel_2106_ROLE">
<!-- Fork -->
  <xsd:sequence>
    <xsd:element name="value" type="Rel_2106_ROLE_value"/>
    <xsd:element name="name" type="Rel_2106_ROLE_name" minOccurs="0"/>
  </xsd:sequence>
</xsd:complexType>

```

13.5.237.39.2 Fork Name

```

<xsd:simpleType name="Rel_2106_ROLE_name">
  <xsd:restriction base="xsd:string">
    <xsd:enumeration value="Approaching Road Element"/>
    <xsd:enumeration value="Junction"/>
    <xsd:enumeration value="Departing Road Element"/>
  </xsd:restriction>
</xsd:simpleType>

```

13.5.237.39.3 Fork Value

```
<xsd:simpleType name="Rel_2106_ROLE_value">  
  <xsd:restriction base="xsd:integer">  
    <xsd:enumeration value="1"/>  
    <xsd:enumeration value="2"/>  
    <xsd:enumeration value="3"/>  
  </xsd:restriction>  
</xsd:simpleType>
```

13.5.237.40 Give Way Regulation

13.5.237.40.1 Give Way Regulation Structure

```
<xsd:complexType name="Rel_2108_ROLE">  
<!-- Give Way Regulation -->  
  <xsd:sequence>  
    <xsd:element name="value" type="Rel_2108_ROLE_value"/>  
    <xsd:element name="name" type="Rel_2108_ROLE_name" minOccurs="0"/>  
  </xsd:sequence>  
</xsd:complexType>
```

13.5.237.40.2 Give Way Regulation Name

```
<xsd:simpleType name="Rel_2108_ROLE_name">  
  <xsd:restriction base="xsd:string">  
    <xsd:enumeration value="First Road Element"/>  
    <xsd:enumeration value="Junction"/>  
    <xsd:enumeration value="Second Road Element"/>  
    <xsd:enumeration value="Subsequent Road Element"/>  
    <xsd:enumeration value="Traffic Sign"/>  
  </xsd:restriction>  
</xsd:simpleType>
```

13.5.237.40.3 Give Way Regulation Value

```
<xsd:simpleType name="Rel_2108_ROLE_value">  
  <xsd:restriction base="xsd:integer">  
    <xsd:enumeration value="1"/>  
    <xsd:enumeration value="2"/>  
    <xsd:enumeration value="3"/>  
    <xsd:enumeration value="4"/>  
    <xsd:enumeration value="5"/>  
  </xsd:restriction>  
</xsd:simpleType>
```

13.5.237.41 Traffic Light Regulation

13.5.237.41.1 Traffic Light Regulation Structure

```
<xsd:complexType name="Rel_2109_ROLE">  
<!-- Traffic Light Regulation -->  
  <xsd:sequence>  
    <xsd:element name="value" type="Rel_2109_ROLE_value"/>  
    <xsd:element name="name" type="Rel_2109_ROLE_name" minOccurs="0"/>  
  </xsd:sequence>  
</xsd:complexType>
```

13.5.237.41.2 Traffic Light Regulation Name

```
<xsd:simpleType name="Rel_2109_ROLE_name">  
  <xsd:restriction base="xsd:string">  
    <xsd:enumeration value="Road Element"/>  
    <xsd:enumeration value="Junction"/>  
    <xsd:enumeration value="Traffic Light"/>  
  </xsd:restriction>  
</xsd:simpleType>
```

13.5.237.41.3 Traffic Light Regulation Value

```
<xsd:simpleType name="Rel_2109_ROLE_value">
  <xsd:restriction base="xsd:integer">
    <xsd:enumeration value="1"/>
    <xsd:enumeration value="2"/>
    <xsd:enumeration value="3"/>
  </xsd:restriction>
</xsd:simpleType>
```

13.5.237.42 Connectivity

13.5.237.42.1 Connectivity Structure

```
<xsd:complexType name="Rel_2110_ROLE">
<!-- Connectivity -->
  <xsd:sequence>
    <xsd:element name="value" type="Rel_2110_ROLE_value"/>
    <xsd:element name="name" type="Rel_2110_ROLE_name" minOccurs="0"/>
  </xsd:sequence>
</xsd:complexType>
```

13.5.237.42.2 Connectivity Name

```
<xsd:simpleType name="Rel_2110_ROLE_name">
  <xsd:restriction base="xsd:string">
    <xsd:enumeration value="From Road Element"/>
    <xsd:enumeration value="Junction"/>
    <xsd:enumeration value="Via Road Element"/>
    <xsd:enumeration value="To Road Element"/>
  </xsd:restriction>
</xsd:simpleType>
```

13.5.237.42.3 Connectivity Value

```
<xsd:simpleType name="Rel_2110_ROLE_value">
  <xsd:restriction base="xsd:integer">
    <xsd:enumeration value="1"/>
    <xsd:enumeration value="2"/>
    <xsd:enumeration value="3"/>
    <xsd:enumeration value="4"/>
  </xsd:restriction>
</xsd:simpleType>
```

13.5.237.43 Signpost Information

13.5.237.43.1 Signpost Information Structure

```
<xsd:complexType name="Rel_2128_ROLE">
<!-- Signpost Information -->
  <xsd:sequence>
    <xsd:element name="value" type="Rel_2128_ROLE_value"/>
    <xsd:element name="name" type="Rel_2128_ROLE_name" minOccurs="0"/>
  </xsd:sequence>
</xsd:complexType>
```

13.5.237.43.2 Signpost Information Name

```
<xsd:simpleType name="Rel_2128_ROLE_name">
  <xsd:restriction base="xsd:string">
    <xsd:enumeration value="Signpost"/>
    <xsd:enumeration value="Locating Road Element"/>
    <xsd:enumeration value="Destination Road Element"/>
  </xsd:restriction>
</xsd:simpleType>
```

13.5.237.43.3 Signpost Information Value

```
<xsd:simpleType name="Rel_2128_ROLE_value">
  <xsd:restriction base="xsd:integer">
```

```
        <xsd:enumeration value="1" />
        <xsd:enumeration value="2" />
        <xsd:enumeration value="3" />
    </xsd:restriction>
</xsd:simpleType>
```

13.5.237.44 Exit at Interchange

13.5.237.44.1 Exit at Interchange Structure

```
<xsd:complexType name="Rel_2129_ROLE">
<!-- Exit at Interchange -->
  <xsd:sequence>
    <xsd:element name="value" type="Rel_2129_ROLE_value" />
    <xsd:element name="name" type="Rel_2129_ROLE_name" minOccurs="0" />
  </xsd:sequence>
</xsd:complexType>
```

13.5.237.44.2 Exit at Interchange Name

```
<xsd:simpleType name="Rel_2129_ROLE_name">
  <xsd:restriction base="xsd:string">
    <xsd:enumeration value="Interchange" />
    <xsd:enumeration value="Junction" />
  </xsd:restriction>
</xsd:simpleType>
```

13.5.237.44.3 Exit at Interchange Value

```
<xsd:simpleType name="Rel_2129_ROLE_value">
  <xsd:restriction base="xsd:integer">
    <xsd:enumeration value="1" />
    <xsd:enumeration value="2" />
  </xsd:restriction>
</xsd:simpleType>
```

13.5.237.45 Toll Route

13.5.237.45.1 Toll Route Structure

```
<xsd:complexType name="Rel_2140_ROLE">
<!-- Toll Route -->
  <xsd:sequence>
    <xsd:element name="value" type="Rel_2140_ROLE_value" />
    <xsd:element name="name" type="Rel_2140_ROLE_name" minOccurs="0" />
  </xsd:sequence>
</xsd:complexType>
```

13.5.237.45.2 Toll Route Name

```
<xsd:simpleType name="Rel_2140_ROLE_name">
  <xsd:restriction base="xsd:string">
    <xsd:enumeration value="Toll Location" />
    <xsd:enumeration value="First Toll Route Part" />
    <xsd:enumeration value="Selective Intermediate Toll Route Part" />
    <xsd:enumeration value="Last Toll Route Part" />
  </xsd:restriction>
</xsd:simpleType>
```

13.5.237.45.3 Toll Route Value

```
<xsd:simpleType name="Rel_2140_ROLE_value">
  <xsd:restriction base="xsd:integer">
    <xsd:enumeration value="1" />
    <xsd:enumeration value="2" />
    <xsd:enumeration value="3" />
    <xsd:enumeration value="4" />
  </xsd:restriction>
</xsd:simpleType>
```

13.5.237.46 Grade Separated Crossing

13.5.237.46.1 Grade Separated Crossing Structure

```

<xsd:complexType name="Rel_2200_ROLE">
  <!-- Signpost Information -->
  <xsd:sequence>
    <xsd:element name="value" type="Rel_2200_ROLE_value"/>
    <xsd:element name="name" type="Rel_2200_ROLE_name" minOccurs="0"/>
  </xsd:sequence>
</xsd:complexType>

```

13.5.237.46.2 Grade Separated Crossing Name

```

<xsd:simpleType name="Rel_2200_ROLE_name">
  <xsd:restriction base="xsd:string">
    <xsd:enumeration value="Upper Part"/>
    <xsd:enumeration value="Lower Part"/>
    <xsd:enumeration value="Structure"/>
  </xsd:restriction>
</xsd:simpleType>

```

13.5.237.46.3 Grade Separated Crossing Value

```

<xsd:simpleType name="Rel_2200_ROLE_value">
  <xsd:restriction base="xsd:integer">
    <xsd:enumeration value="1"/>
    <xsd:enumeration value="2"/>
    <xsd:enumeration value="3"/>
  </xsd:restriction>
</xsd:simpleType>

```

13.5.237.47 Traffic Sign along Road Element

13.5.237.47.1 Traffic Sign along Road Element Structure

```

<xsd:complexType name="Rel_2300_ROLE">
  <!-- Traffic Sign along Road Element -->
  <xsd:sequence>
    <xsd:element name="value" type="Rel_2300_ROLE_value"/>
    <xsd:element name="name" type="Rel_2300_ROLE_name" minOccurs="0"/>
  </xsd:sequence>
</xsd:complexType>

```

13.5.237.47.2 Traffic Sign along Road Element Name

```

<xsd:simpleType name="Rel_2300_ROLE_name">
  <xsd:restriction base="xsd:string">
    <xsd:enumeration value="Traffic Sign"/>
    <xsd:enumeration value="Road Element"/>
  </xsd:restriction>
</xsd:simpleType>

```

13.5.237.47.3 Traffic Sign along Road Element Value

```

<xsd:simpleType name="Rel_2300_ROLE_value">
  <xsd:restriction base="xsd:integer">
    <xsd:enumeration value="1"/>
    <xsd:enumeration value="2"/>
  </xsd:restriction>
</xsd:simpleType>

```

13.5.237.48 Traffic Light along Road Element

13.5.237.48.1 Traffic Light along Road Element Structure

```

<xsd:complexType name="Rel_2305_ROLE">
  <!-- Traffic Light along Road Element -->
  <xsd:sequence>

```

```
<xsd:element name="value" type="Rel_2305_ROLE_value" />
<xsd:element name="name" type="Rel_2305_ROLE_name" minOccurs="0"/>
</xsd:sequence>
</xsd:complexType>
```

13.5.237.48.2 Traffic Light along Road Element Name

```
<xsd:simpleType name="Rel_2305_ROLE_name">
  <xsd:restriction base="xsd:string">
    <xsd:enumeration value="Traffic Light"/>
    <xsd:enumeration value="Road Element"/>
  </xsd:restriction>
</xsd:simpleType>
```

13.5.237.48.3 Traffic Light along Road Element Value

```
<xsd:simpleType name="Rel_2305_ROLE_value">
  <xsd:restriction base="xsd:integer">
    <xsd:enumeration value="1"/>
    <xsd:enumeration value="2"/>
  </xsd:restriction>
</xsd:simpleType>
```

13.5.237.49 Overhead Structure along Road Element

13.5.237.49.1 Overhead Structure along Road Element Structure

```
<xsd:complexType name="Rel_2310_ROLE">
<!-- Overhead Structure along Road Element -->
  <xsd:sequence>
    <xsd:element name="value" type="Rel_2310_ROLE_value" />
    <xsd:element name="name" type="Rel_2310_ROLE_name" minOccurs="0"/>
  </xsd:sequence>
</xsd:complexType>
```

13.5.237.49.2 Overhead Structure along Road Element Name

```
<xsd:simpleType name="Rel_2310_ROLE_name">
  <xsd:restriction base="xsd:string">
    <xsd:enumeration value="Structure"/>
    <xsd:enumeration value="Road Element"/>
  </xsd:restriction>
</xsd:simpleType>
```

13.5.237.49.3 Overhead Structure along Road Element Value

```
<xsd:simpleType name="Rel_2310_ROLE_value">
  <xsd:restriction base="xsd:integer">
    <xsd:enumeration value="1"/>
    <xsd:enumeration value="2"/>
  </xsd:restriction>
</xsd:simpleType>
```

13.5.237.50 Pedestrian Crossing along Road Element

13.5.237.50.1 Pedestrian Crossing along Road Element Structure

```
<xsd:complexType name="Rel_2315_ROLE">
<!-- Pedestrian Crossing along Road Element -->
  <xsd:sequence>
    <xsd:element name="value" type="Rel_2315_ROLE_value" />
    <xsd:element name="name" type="Rel_2315_ROLE_name" minOccurs="0"/>
  </xsd:sequence>
</xsd:complexType>
```

13.5.237.50.2 Pedestrian Crossing along Road Element Name

```
<xsd:simpleType name="Rel_2315_ROLE_name">
  <xsd:restriction base="xsd:string">
```



```

        <xsd:enumeration value="Pedestrian Crossing"/>
        <xsd:enumeration value="Road Element"/>
    </xsd:restriction>
</xsd:simpleType>

```

13.5.237.50.3 Pedestrian Crossing along Road Element Value

```

<xsd:simpleType name="Rel_2315_ROLE_value">
  <xsd:restriction base="xsd:integer">
    <xsd:enumeration value="1"/>
    <xsd:enumeration value="2"/>
  </xsd:restriction>
</xsd:simpleType>

```

13.5.237.51 Place within Place

13.5.237.51.1 Place within Place Structure

```

<xsd:complexType name="Rel_2400_ROLE">
  <!-- Place within Place -->
  <xsd:sequence>
    <xsd:element name="value" type="Rel_2400_ROLE_value"/>
    <xsd:element name="name" type="Rel_2400_ROLE_name" minOccurs="0"/>
  </xsd:sequence>
</xsd:complexType>

```

13.5.237.51.2 Place within Place Name

```

<xsd:simpleType name="Rel_2400_ROLE_name">
  <xsd:restriction base="xsd:string">
    <xsd:enumeration value="Contained Place"/>
    <xsd:enumeration value="Containing Place"/>
  </xsd:restriction>
</xsd:simpleType>

```

13.5.237.51.3 Place within Place Value

```

<xsd:simpleType name="Rel_2400_ROLE_value">
  <xsd:restriction base="xsd:integer">
    <xsd:enumeration value="1"/>
    <xsd:enumeration value="2"/>
  </xsd:restriction>
</xsd:simpleType>

```

13.5.237.52 Linear Assignment

13.5.237.52.1 Linear Assignment Structure

```

<xsd:complexType name="Rel_4800_ROLE">
  <!-- Linear Assignment -->
  <xsd:sequence>
    <xsd:element name="value" type="Rel_4800_ROLE_value"/>
    <xsd:element name="name" type="Rel_4800_ROLE_name" minOccurs="0"/>
  </xsd:sequence>
</xsd:complexType>

```

13.5.237.52.2 Linear Assignment Name

```

<xsd:simpleType name="Rel_4800_ROLE_name">
  <xsd:restriction base="xsd:string">
    <xsd:enumeration value="Source"/>
    <xsd:enumeration value="Target"/>
  </xsd:restriction>
</xsd:simpleType>

```

13.5.237.52.3 Linear Assignment Value

```

<xsd:simpleType name="Rel_4800_ROLE_value">
  <xsd:restriction base="xsd:integer">
    <xsd:enumeration value="1"/>
    <xsd:enumeration value="2"/>
  </xsd:restriction>
</xsd:simpleType>

```

```
</xsd:restriction>  
</xsd:simpleType>
```

13.5.237.53 Multi-Point Assignment

13.5.237.53.1 Multi-Point Assignment Structure

```
<xsd:complexType name="Rel_4801_ROLE">  
<!-- Multi-Point Assignment -->  
  <xsd:sequence>  
    <xsd:element name="value" type="Rel_4801_ROLE_value"/>  
    <xsd:element name="name" type="Rel_4801_ROLE_name" minOccurs="0"/>  
  </xsd:sequence>  
</xsd:complexType>
```

13.5.237.53.2 Multi-Point Assignment Name

```
<xsd:simpleType name="Rel_4801_ROLE_name">  
  <xsd:restriction base="xsd:string">  
    <xsd:enumeration value="Source"/>  
    <xsd:enumeration value="Target"/>  
  </xsd:restriction>  
</xsd:simpleType>
```

13.5.237.53.3 Multi-Point Assignment Value

```
<xsd:simpleType name="Rel_4801_ROLE_value">  
  <xsd:restriction base="xsd:integer">  
    <xsd:enumeration value="1"/>  
    <xsd:enumeration value="2"/>  
  </xsd:restriction>  
</xsd:simpleType>
```

13.5.237.54 Exclusive Multi-Point Assignment

13.5.237.54.1 Exclusive Multi-Point Assignment Structure

```
<xsd:complexType name="Rel_4802_ROLE">  
<!-- Multi-Point Assignment -->  
  <xsd:sequence>  
    <xsd:element name="value" type="Rel_4802_ROLE_value"/>  
    <xsd:element name="name" type="Rel_4802_ROLE_name" minOccurs="0"/>  
  </xsd:sequence>  
</xsd:complexType>
```

13.5.237.54.2 Exclusive Multi-Point Assignment Name

```
<xsd:simpleType name="Rel_4802_ROLE_name">  
  <xsd:restriction base="xsd:string">  
    <xsd:enumeration value="Source"/>  
    <xsd:enumeration value="Target"/>  
  </xsd:restriction>  
</xsd:simpleType>
```

13.5.237.54.3 Exclusive Multi-Point Assignment Value

```
<xsd:simpleType name="Rel_4802_ROLE_value">  
  <xsd:restriction base="xsd:integer">  
    <xsd:enumeration value="1"/>  
    <xsd:enumeration value="2"/>  
  </xsd:restriction>  
</xsd:simpleType>
```

13.5.237.55 Pedestrian Square Connected to Pedestrian Crossing

13.5.237.55.1 Pedestrian Square Connected to Pedestrian Crossing Structure

```
<xsd:complexType name="Rel_6010_ROLE">
```

```

<!-- Pedestrian Square Connected to Pedestrian Crossing -->
  <xsd:sequence>
    <xsd:element name="value" type="Rel_6010_ROLE_value"/>
    <xsd:element name="name" type="Rel_6010_ROLE_name" minOccurs="0"/>
  </xsd:sequence>
</xsd:complexType>

```

13.5.237.55.2 Pedestrian Square Connected to Pedestrian Crossing Name

```

<xsd:simpleType name="Rel_6010_ROLE_name">
  <xsd:restriction base="xsd:string">
    <xsd:enumeration value="Pedestrian Square"/>
    <xsd:enumeration value="Pedestrian Crossing Part"/>
  </xsd:restriction>
</xsd:simpleType>

```

13.5.237.55.3 Pedestrian Square Connected to Pedestrian Crossing Value

```

<xsd:simpleType name="Rel_6010_ROLE_value">
  <xsd:restriction base="xsd:integer">
    <xsd:enumeration value="1"/>
    <xsd:enumeration value="2"/>
  </xsd:restriction>
</xsd:simpleType>

```

13.5.237.56 Pedestrian Crossing Has Entry Point

13.5.237.56.1 Pedestrian Crossing Has Entry Point Structure

```

<xsd:complexType name="Rel_6020_ROLE">
  <!-- Pedestrian Crossing Has Entry Point -->
  <xsd:sequence>
    <xsd:element name="value" type="Rel_6020_ROLE_value"/>
    <xsd:element name="name" type="Rel_6020_ROLE_name" minOccurs="0"/>
  </xsd:sequence>
</xsd:complexType>

```

13.5.237.56.2 Pedestrian Crossing Has Entry Point Name

```

<xsd:simpleType name="Rel_6020_ROLE_name">
  <xsd:restriction base="xsd:string">
    <xsd:enumeration value="Pedestrian Crossing"/>
    <xsd:enumeration value="Entry Point"/>
  </xsd:restriction>
</xsd:simpleType>

```

13.5.237.56.3 Pedestrian Crossing Has Entry Point Value

```

<xsd:simpleType name="Rel_6020_ROLE_value">
  <xsd:restriction base="xsd:integer">
    <xsd:enumeration value="1"/>
    <xsd:enumeration value="2"/>
  </xsd:restriction>
</xsd:simpleType>

```

13.5.237.57 Route Link along Road Element

13.5.237.57.1 Route Link along Road Element Structure

```

<xsd:complexType name="Rel_7001_ROLE">
  <!-- Route Link along Road Element -->
  <xsd:sequence>
    <xsd:element name="value" type="Rel_7001_ROLE_value"/>
    <xsd:element name="name" type="Rel_7001_ROLE_name" minOccurs="0"/>
  </xsd:sequence>
</xsd:complexType>

```

13.5.237.57.2 Route Link along Road Element Name

```
<xsd:simpleType name="Rel_7001_ROLE_name">  
  <xsd:restriction base="xsd:string">  
    <xsd:enumeration value="Route Link"/>  
    <xsd:enumeration value="Road Element"/>  
  </xsd:restriction>  
</xsd:simpleType>
```

13.5.237.57.3 Route Link along Road Element Value

```
<xsd:simpleType name="Rel_7001_ROLE_value">  
  <xsd:restriction base="xsd:integer">  
    <xsd:enumeration value="1"/>  
    <xsd:enumeration value="2"/>  
  </xsd:restriction>  
</xsd:simpleType>
```

13.5.237.58 Stop Point along Route

13.5.237.58.1 Stop Point along Route Structure

```
<xsd:complexType name="Rel_7002_ROLE">  
<!-- Stop Point along Route -->  
  <xsd:sequence>  
    <xsd:element name="value" type="Rel_7002_ROLE_value"/>  
    <xsd:element name="name" type="Rel_7002_ROLE_name" minOccurs="0"/>  
  </xsd:sequence>  
</xsd:complexType>
```

13.5.237.58.2 Stop Point along Route Name

```
<xsd:simpleType name="Rel_7002_ROLE_name">  
  <xsd:restriction base="xsd:string">  
    <xsd:enumeration value="Stop Point"/>  
    <xsd:enumeration value="Route"/>  
  </xsd:restriction>  
</xsd:simpleType>
```

13.5.237.58.3 Stop Point along Route Value

```
<xsd:simpleType name="Rel_7002_ROLE_value">  
  <xsd:restriction base="xsd:integer">  
    <xsd:enumeration value="1"/>  
    <xsd:enumeration value="2"/>  
  </xsd:restriction>  
</xsd:simpleType>
```

13.5.237.59 Stop Point along Road Element

13.5.237.59.1 Stop Point along Road Element Structure

```
<xsd:complexType name="Rel_7003_ROLE">  
<!-- Stop Point along Road Element -->  
  <xsd:sequence>  
    <xsd:element name="value" type="Rel_7003_ROLE_value"/>  
    <xsd:element name="name" type="Rel_7003_ROLE_name" minOccurs="0"/>  
  </xsd:sequence>  
</xsd:complexType>
```

13.5.237.59.2 Stop Point along Road Element Name

```
<xsd:simpleType name="Rel_7003_ROLE_name">  
  <xsd:restriction base="xsd:string">  
    <xsd:enumeration value="Stop Point"/>  
    <xsd:enumeration value="Road Element"/>  
  </xsd:restriction>  
</xsd:simpleType>
```

13.5.237.59.3 Stop Point along Road Element Value

```
<xsd:simpleType name="Rel_7003_ROLE_value">
  <xsd:restriction base="xsd:integer">
    <xsd:enumeration value="1"/>
    <xsd:enumeration value="2"/>
  </xsd:restriction>
</xsd:simpleType>
```

13.5.237.60 Stop Point at Junction**13.5.237.60.1 Stop Point at Junction Structure**

```
<xsd:complexType name="Rel_7004_ROLE">
<!-- Stop Point at Junction -->
  <xsd:sequence>
    <xsd:element name="value" type="Rel_7004_ROLE_value"/>
    <xsd:element name="name" type="Rel_7004_ROLE_name" minOccurs="0"/>
  </xsd:sequence>
</xsd:complexType>
```

13.5.237.60.2 Stop Point at Junction Name

```
<xsd:simpleType name="Rel_7004_ROLE_name">
  <xsd:restriction base="xsd:string">
    <xsd:enumeration value="Stop Point"/>
    <xsd:enumeration value="Junction"/>
  </xsd:restriction>
</xsd:simpleType>
```

13.5.237.60.3 Stop Point at Junction Value

```
<xsd:simpleType name="Rel_7004_ROLE_value">
  <xsd:restriction base="xsd:integer">
    <xsd:enumeration value="1"/>
    <xsd:enumeration value="2"/>
  </xsd:restriction>
</xsd:simpleType>
```

13.5.237.61 Stop Point located near Service**13.5.237.61.1 Stop Point located near Service Structure**

```
<xsd:complexType name="Rel_7005_ROLE">
<!-- Stop Point located near Service -->
  <xsd:sequence>
    <xsd:element name="value" type="Rel_7005_ROLE_value"/>
    <xsd:element name="name" type="Rel_7005_ROLE_name" minOccurs="0"/>
  </xsd:sequence>
</xsd:complexType>
```

13.5.237.61.2 Stop Point located near Service Name

```
<xsd:simpleType name="Rel_7005_ROLE_name">
  <xsd:restriction base="xsd:string">
    <xsd:enumeration value="Stop Point"/>
    <xsd:enumeration value="Service"/>
  </xsd:restriction>
</xsd:simpleType>
```

13.5.237.61.3 Stop Point located near Service Value

```
<xsd:simpleType name="Rel_7005_ROLE_value">
  <xsd:restriction base="xsd:integer">
    <xsd:enumeration value="1"/>
    <xsd:enumeration value="2"/>
  </xsd:restriction>
```

```
</xsd:simpleType>
```

13.5.237.62 Public Transport Point along Route Link

13.5.237.62.1 Public Transport Point along Route Link Structure

```
<xsd:complexType name="Rel_7006_ROLE">  
<!-- Public Transport Point along Route Link -->  
<xsd:sequence>  
  <xsd:element name="value" type="Rel_7006_ROLE_value"/>  
  <xsd:element name="name" type="Rel_7006_ROLE_name" minOccurs="0"/>  
</xsd:sequence>  
</xsd:complexType>
```

13.5.237.62.2 Public Transport Point along Rout Link Name

```
<xsd:simpleType name="Rel_7006_ROLE_name">  
  <xsd:restriction base="xsd:string">  
    <xsd:enumeration value="Public Transport Point"/>  
    <xsd:enumeration value="Route Link"/>  
  </xsd:restriction>  
</xsd:simpleType>
```

13.5.237.62.3 Public Transport Point along Route Link Value

```
<xsd:simpleType name="Rel_7006_ROLE_value">  
  <xsd:restriction base="xsd:integer">  
    <xsd:enumeration value="1"/>  
    <xsd:enumeration value="2"/>  
  </xsd:restriction>  
</xsd:simpleType>
```

13.5.237.63 Public Transport Connection

13.5.237.63.1 Public Transport Connection Structure

```
<xsd:complexType name="Rel_7007_ROLE">  
<!-- Public Transport Connection -->  
<xsd:sequence>  
  <xsd:element name="value" type="Rel_7007_ROLE_value"/>  
  <xsd:element name="name" type="Rel_7007_ROLE_name" minOccurs="0"/>  
</xsd:sequence>  
</xsd:complexType>
```

13.5.237.63.2 Public Transport Connection Name

```
<xsd:simpleType name="Rel_7007_ROLE_name">  
  <xsd:restriction base="xsd:string">  
    <xsd:enumeration value="Originating Stop Point"/>  
    <xsd:enumeration value="Connected Stop Point"/>  
  </xsd:restriction>  
</xsd:simpleType>
```

13.5.237.63.3 Public Transport Connection Value

```
<xsd:simpleType name="Rel_7007_ROLE_value">  
  <xsd:restriction base="xsd:integer">  
    <xsd:enumeration value="1"/>  
    <xsd:enumeration value="2"/>  
  </xsd:restriction>  
</xsd:simpleType>  
</xsd:schema>
```

13.6 Schema GDF_userDefined.xsd

13.6.1 Header

```
<?xml version="1.0" encoding="UTF-8"?>
<xsd:schema xmlns:gdf="http://www.ukusa.org" xmlns="http://www.ukusa.org"
xmlns:xsd="http://www.w3.org/2001/XMLSchema" targetNamespace="http://www.ukusa.org"
elementFormDefault="qualified">
  <xsd:include schemaLocation="GDF_data_dict.xsd"/>
```

13.6.2 User-defined Feature Codes

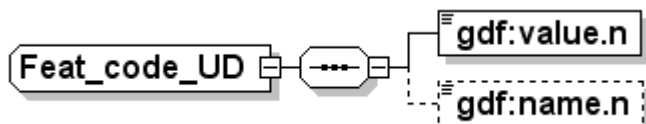

```
<xsd:complexType name="Feat_code_UD">
  <xsd:sequence>
    <xsd:element name="value.n" type="Feature_code_value_UD"/>
    <xsd:element name="name.n" type="Feature_code_name_UD" minOccurs="0"/>
  </xsd:sequence>
</xsd:complexType>
```

13.6.3 User-defined Relationship Code

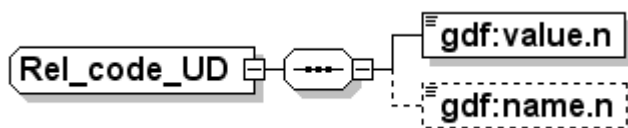

```
<xsd:complexType name="Rel_code_UD">
  <xsd:sequence>
    <xsd:element name="value.n" type="Rel_code_value_UD"/>
    <xsd:element name="name.n" type="Rel_code_name_UD" minOccurs="0"/>
  </xsd:sequence>
</xsd:complexType>
```

13.6.4 User-defined Attribute Type Code

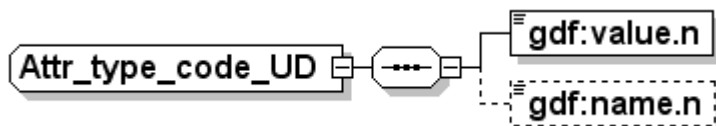

```
<xsd:complexType name="Attr_type_code_UD">
  <xsd:sequence>
    <xsd:element name="value.n" type="Attr_type_code_value_UD"/>
    <xsd:element name="name.n" type="Attr_type_code_name_UD" minOccurs="0"/>
  </xsd:sequence>
</xsd:complexType>
```

13.6.5 User-defined Feature Code Name (Simple)

```
<xsd:simpleType name="Feature_code_name_UD">
  <xsd:restriction base="xsd:string">
    <xsd:enumeration value="User_Defined_8100"/>
    <xsd:enumeration value="User_Defined_8101"/>
    <xsd:enumeration value="User_Defined_8102"/>
    <xsd:enumeration value="User_Defined_8103"/>
    <xsd:enumeration value="User_Defined_8104"/>
    <xsd:enumeration value="User_Defined_8105"/>
    <xsd:enumeration value="User_Defined_8106"/>
    <xsd:enumeration value="User_Defined_8107"/>
    <xsd:enumeration value="User_Defined_8108"/>
    <xsd:enumeration value="User_Defined_8109"/>
    <xsd:enumeration value="User_Defined_8110"/>
  <!-- a large break in the sequence occurs in the middle... -->
```

```
<xsd:enumeration value="User_Defined_9990" />
<xsd:enumeration value="User_Defined_9991" />
<xsd:enumeration value="User_Defined_9992" />
<xsd:enumeration value="User_Defined_9993" />
<xsd:enumeration value="User_Defined_9994" />
<xsd:enumeration value="User_Defined_9995" />
<xsd:enumeration value="User_Defined_9996" />
<xsd:enumeration value="User_Defined_9997" />
<xsd:enumeration value="User_Defined_9998" />
<xsd:enumeration value="User_Defined_9999" />
</xsd:restriction>
</xsd:simpleType>
```

13.6.6 User-defined Feature Code Value (Simple)

```
<xsd:simpleType name="Feature_code_value_UD">
  <xsd:restriction base="Four_digit_int">
    <xsd:minInclusive value="8100" />
    <xsd:totalDigits value="4" />
    <xsd:enumeration value="8100" />
    <xsd:enumeration value="8101" />
    <xsd:enumeration value="8102" />
    <xsd:enumeration value="8103" />
    <xsd:enumeration value="8104" />
    <xsd:enumeration value="8105" />
    <xsd:enumeration value="8106" />
    <xsd:enumeration value="8107" />
    <xsd:enumeration value="8108" />
    <xsd:enumeration value="8109" />
    <xsd:enumeration value="8110" />
    <xsd:enumeration value="9990" />
    <xsd:enumeration value="9991" />
    <xsd:enumeration value="9992" />
    <xsd:enumeration value="9993" />
    <xsd:enumeration value="9994" />
    <xsd:enumeration value="9995" />
    <xsd:enumeration value="9996" />
    <xsd:enumeration value="9997" />
    <xsd:enumeration value="9998" />
    <xsd:enumeration value="9999" />
  </xsd:restriction>
</xsd:simpleType>
```

13.6.7 User-defined Relationship Code Name (Simple)

```
<xsd:simpleType name="Rel_code_name_UD">
  <xsd:restriction base="xsd:string">
    <xsd:enumeration value="User_Defined_9000" />
    <xsd:enumeration value="User_Defined_9001" />
    <xsd:enumeration value="User_Defined_9002" />
    <xsd:enumeration value="User_Defined_9003" />
    <xsd:enumeration value="User_Defined_9004" />
    <xsd:enumeration value="User_Defined_9005" />
    <xsd:enumeration value="User_Defined_9006" />
    <xsd:enumeration value="User_Defined_9007" />
    <xsd:enumeration value="User_Defined_9008" />
    <xsd:enumeration value="User_Defined_9009" />
    <xsd:enumeration value="User_Defined_9010" />
    <xsd:enumeration value="User_Defined_9990" />
    <xsd:enumeration value="User_Defined_9991" />
    <xsd:enumeration value="User_Defined_9992" />
    <xsd:enumeration value="User_Defined_9993" />
    <xsd:enumeration value="User_Defined_9994" />
    <xsd:enumeration value="User_Defined_9995" />
    <xsd:enumeration value="User_Defined_9996" />
    <xsd:enumeration value="User_Defined_9997" />
    <xsd:enumeration value="User_Defined_9998" />
    <xsd:enumeration value="User_Defined_9999" />
  </xsd:restriction>
</xsd:simpleType>
```

13.6.8 User-defined Relationship Code Value (Simple)

```
<xsd:simpleType name="Rel_code_value_UD">
  <xsd:restriction base="Four_digit_int">
    <xsd:minInclusive value="9000"/>
    <xsd:enumeration value="9000"/>
    <xsd:enumeration value="9001"/>
    <xsd:enumeration value="9002"/>
    <xsd:enumeration value="9003"/>
    <xsd:enumeration value="9004"/>
    <xsd:enumeration value="9005"/>
    <xsd:enumeration value="9006"/>
    <xsd:enumeration value="9007"/>
    <xsd:enumeration value="9008"/>
    <xsd:enumeration value="9009"/>
    <xsd:enumeration value="9010"/>
    <!-- a break in the sequence occurs in the middle... -->
    <xsd:enumeration value="9990"/>
    <xsd:enumeration value="9991"/>
    <xsd:enumeration value="9992"/>
    <xsd:enumeration value="9993"/>
    <xsd:enumeration value="9994"/>
    <xsd:enumeration value="9995"/>
    <xsd:enumeration value="9996"/>
    <xsd:enumeration value="9997"/>
    <xsd:enumeration value="9998"/>
    <xsd:enumeration value="9999"/>
  </xsd:restriction>
</xsd:simpleType>
```

13.6.9 User-defined Attribute Type Code Name (Simple)

```
<xsd:simpleType name="Attr_type_code_name_UD">
  <xsd:restriction base="xsd:string"/>
</xsd:simpleType>
```

13.6.10 User-defined Attribute Type Code Value (Simple)

```
<xsd:simpleType name="Attr_type_code_value_UD">
  <xsd:restriction base="xsd:string">
    <xsd:length value="2"/>
  </xsd:restriction>
</xsd:simpleType>
```

13.6.11 Attribute Type Code

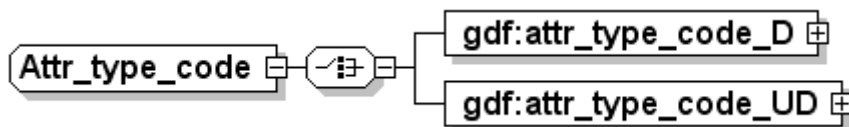

```
<xsd:complexType name="Attr_type_code">
  <xsd:choice>
    <xsd:element name="attr_type_code_D" type="Attr_type_code_D"/>
    <xsd:element name="attr_type_code_UD" type="Attr_type_code_UD"/>
  </xsd:choice>
</xsd:complexType>
```

13.6.12 Attribute Type Value

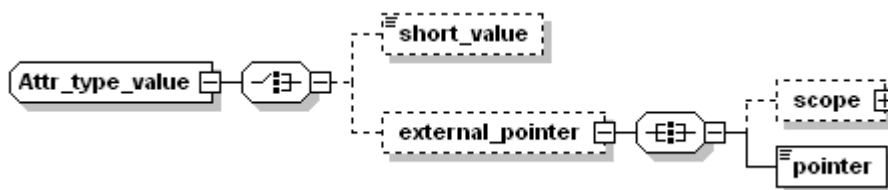

```
<xsd:complexType name="Attr_type_value">
  <xsd:choice>
```

```

<xsd:element name="short_value" type="xsd:string" minOccurs="0"/>
<xsd:element name="external_pointer" minOccurs="0">
  <xsd:complexType>
    <xsd:all>
      <xsd:element name="scope" type="DLS_ID" minOccurs="0"/>
      <xsd:element name="pointer" type="Rec_ID"/>
    </xsd:all>
  </xsd:complexType>
</xsd:element>
</xsd:choice>
</xsd:complexType>

```

13.6.13 Relationship Code

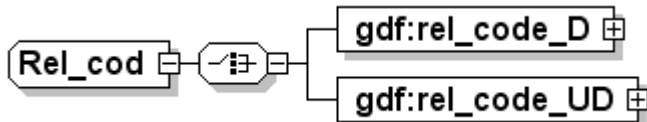

```

<xsd:complexType name="Rel_cod">
  <xsd:choice>
    <xsd:element name="rel_code_D" type="Rel_code_D"/>
    <xsd:element name="rel_code_UD" type="Rel_code_UD"/>
  </xsd:choice>
</xsd:complexType>

```

13.6.14 Feature Code

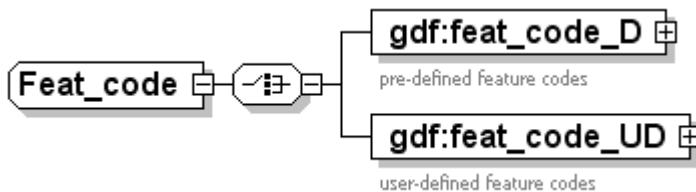

```

<xsd:complexType name="Feat_code">
  <xsd:choice>
    <xsd:element name="feat_code_D" type="Feat_code_D">
      <xsd:annotation>
        <xsd:documentation>pre-defined feature codes</xsd:documentation>
      </xsd:annotation>
    </xsd:element>
    <xsd:element name="feat_code_UD" type="Feat_code_UD">
      <xsd:annotation>
        <xsd:documentation>user-defined feature codes</xsd:documentation>
      </xsd:annotation>
    </xsd:element>
  </xsd:choice>
</xsd:complexType>

```

13.6.15 Attribute Content

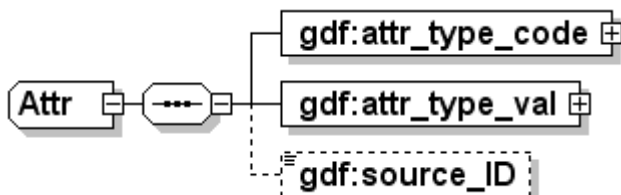

```

<xsd:complexType name="Attr">
  <xsd:sequence>
    <xsd:element name="attr_type_code" type="Attr_type_code"/>
    <xsd:element name="attr_type_val" type="Attr_type_value"/>
    <xsd:element name="source_ID" type="Src_desc_ID" minOccurs="0"/>
  </xsd:sequence>
</xsd:complexType>

```

13.6.16 Attribute Descriptor

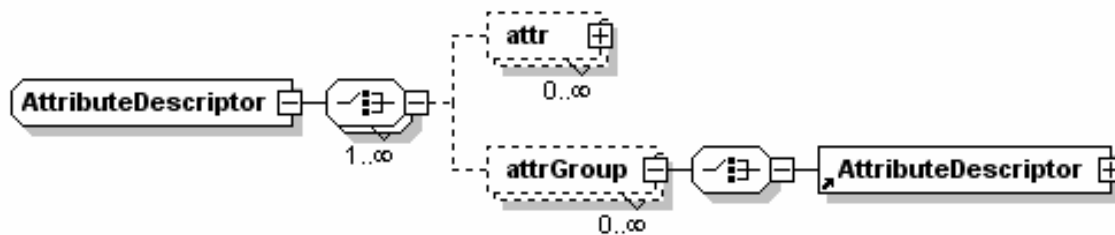

```

<xsd:complexType name="AttributeDescriptor">
  <xsd:choice maxOccurs="unbounded">
    <xsd:element name="attr" type="Attr" minOccurs="0" maxOccurs="unbounded"/>
    <xsd:element name="attrGroup" minOccurs="0" maxOccurs="unbounded">
      <xsd:complexType>
        <xsd:choice>
          <xsd:element ref="AttributeDescriptor"/>
        </xsd:choice>
      </xsd:complexType>
    </xsd:element>
  </xsd:choice>
</xsd:complexType>
<xsd:element name="AttributeDescriptor" type="AttributeDescriptor"/>
</xsd:schema>

```

14 SQL encoding specifications

14.1 SQL design

14.1.1 Introduction

The SQL encoding provides GDF data in a Relational Data Base Management System (RDBMS), consistent with SQL and SQL/MM standards [23] [25] [26]. The specification of the database design follows a two-step approach; in a first step, the SQL Logical Model of GDF database entities and their properties is devised, which is complemented in a second step by the actual table layout that corresponds to the database entities at hand.

The primary purpose of this SQL encoding is to make the GDF data accessible using the RDBMS and the SQL language. Applications of this data have not yet been specified. The database design therefore is not optimized for any particular access opportunities. Rather, it is in strict Third Normal Form [37]. It is anticipated that users of the data will restructure it in accordance with their particular application needs.

The mapping between MRS Record/Fields and SQL Table/Columns is not a simple one-to-one proposition. Instead, it will most likely have to be specified as SQL select statements or data loading routines. Both are beyond the scope of this standard.

14.1.2 Logical Model design

The SQL Logical Model, including Entity Relationship Diagrams (ERD) [34], defines the requirements for the SQL encoding consistent with the GDF UML conceptual model.

This sub-clause structure of this clause is dictated by the order in which the resultant tables will need to be created during physical database design. A constraint on a Table can only reference already created Tables.

In looking for Entities in this document, it may be more useful to have them alphabetically listed by the proposed (shortened) SQL table name adopting the corresponding Entity name, or by the commonly used GDF name of the Entity, respectively (see subclause 14.12 for two such Entity/Table Indexes).

Sub-clause 0 explains the conventions used in the ERDs contained in this document.

14.1.3 Physical Model design

14.1.3.1 General

Tables are defined using SQL data definition language (DDL) constructs from SQL and SQL/MM Spatial. The intent is to be database vendor-neutral. Base topology/network tables which are extended herein are shown in 14.14.

In looking for Tables in this document, it may be more useful to have them alphabetically listed by the proposed SQL table name corresponding to the Entity (including supplementary intersect tables), or by the commonly used GDF name of the Entity, respectively (see subclause 14.12 for two such Entity/Table Indexes).

14.1.3.2 Execution order

It should be possible to execute the DDL in the order that it is specified in this document.

14.1.3.3 Not NULL constraints

All NOT NULL columns should be specified with named constraints (which can be more easily dropped if necessary):

```
<column name> <data type>
  CONSTRAINT <table-name>_<column name>_NOT_NULL
  NOT NULL
```

14.1.3.4 Referential integrity

Optional referential integrity constraints are shown herein in *italics* and shall be as follows:

```
CONSTRAINT <local table name>_<local column name>_EXISTS
  FOREIGN KEY(<local column names>)
  REFERENCES <foreign table name>(<foreign column names>)
  [MATCH SIMPLE|PARTIAL|FULL]
```

MATCH SIMPLE is satisfied if either a) one of the foreign key values is NULL or b) none is NULL and all match a row in the referenced table. MATCH PARTIAL is satisfied if a) all values are NULL, b) all values match, or c) all non-NULL values match. MATCH FULL is satisfied if a) all values are NULL or b) all of the values are NOT NULL and match.

MATCH FULL is only necessary if the FOREIGN KEY is comprised of multiple columns and all or none of them must be NULL for the row to be valid (for example, for LVARCHAR strings in the LCS Table). For a row to be valid with only some of the FOREIGN KEY columns being NULL, MATCH SIMPLE is appropriate, but does not have to be stated as it is the default. Unfortunately, with MATCH SIMPLE, if ANY of the foreign key values is NULL, then the constraint passes, even if the other values do not match. To insure that these other values do match, MATCH PARTIAL is used (for example, dataset, layer, and section IDs in the DLS table). However, with MATCH PARTIAL, all columns must be optional, else MATCH PARTIAL behaviour defaults to that of MATCH SIMPLE.

These referential integrity constraints are considered “optional” in the sense that a fully functioning database can be created without them. However, the integrity of the database may be compromised. It may be more advisable to DEFER these constraints or to run tests similar to these against the populated database to insure referential integrity has not been compromised.

14.1.3.5 Interlocking references

For interlocking references, DEFERRABLE INITIALLY DEFERRED shall be added to prevent failed INSERTs. Once INSERTs have been made, SET CONSTRAINTS ALL IMMEDIATE to test their validity.

For example, consider two entities, A and B such that:

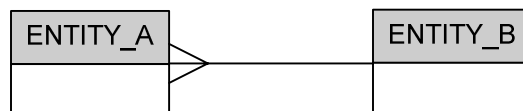

Each entity A must be associated with one and only one entity B. [1]

Each entity B must be associated with one or more entity A's. [1..*]

1) Create a table for Entity B called B. The primary key shall be B_ID.

```
CREATE TABLE B
(
  B_ID INTEGER,

  CONSTRAINT B_PRIMARY_KEY
  PRIMARY KEY (B_ID)
)
```

2) Create a table for Entity A called A. The primary key shall be A_ID. Every row in A must reference a row in B.

```
CREATE TABLE A
(
  A_ID INTEGER,
  B_ID INTEGER
  CONSTRAINT A_B_ID_NOT_NULL
  NOT NULL,

  CONSTRAINT A_PRIMARY_KEY
  PRIMARY KEY (A_ID),

  CONSTRAINT A_B_ID_EXISTS
  FOREIGN KEY(B_ID)
  REFERENCES B(B_ID)
)
```

3) Now add the constraint to B.

```
ALTER TABLE B
  ADD CONSTRAINT B_HAS_A
  CHECK (B_ID IN
    (SELECT B_ID FROM A))
  DEFERRABLE INITIALLY DEFERRED
```

4) Insert rows into B

5) Insert rows into A, including their B_ID values.

6) Enforce the deferred constraint B_HAS_A

```
SET CONSTRAINTS ALL IMMEDIATE
```

14.1.3.6 Additional constraints

Additional constraints may also be included. These too shall have a local table name prefix in their name and, if they are optional, are shown herein in *italics*.

14.1.3.7 Local Character Set Text

Where the ERD specifies that an attribute is of type LCHAR or LVARCHAR, a Local Character Set can be used for the string. To accommodate this in an SQL-compliant manner, the strings will be persisted in a separate, Album-level Table called LCS_Text. (Attribute values with an attribute data type of TXT will be handled in a similar manner.)

For the physical implementation, the LCHAR / LVARCHAR attribute will be persisted as two separate attributes. The ERD attribute name will be suffixed with “_DLS” and “_STRING”, respectively. The first specifies the DLS INTEGER value of the entity having this attribute value. The second is an INTEGER value identifying the LCHAR / LVARCHAR string in the LCS_Text Table, unique within the DLS. If the ERD attribute name is greater than 11 characters, it shall be shortened so that, along with the “_STRING” suffix, it will be within the allowable eighteen character limit for SQL identifiers.

The optional referential integrity constraints shall be as follows:

```
CONSTRAINT <local table name>_<ERD attribute name>_EXISTS
  FOREIGN KEY(<ERD attribute name>_DLS, <ERD attribute name>_STRING)
  REFERENCES LCS_TEXT(DLS, STRING_ID)
  MATCH FULL
```

Here MATCH FULL shall be used. If the ERD attribute can be NULL, then the _DLS and _STRING columns must both be NULL or else be equal to the DLS and STRING_ID columns for some row in the LCS_TEXT Table for the row to be valid. If only one of the two is NULL, the row is not valid. If the ERD attribute is NOT NULL, then both columns should be declared as NOT NULL.

14.2 Data content

14.2.1 Principle

The data contained in GDF can be either of two types: pre-defined content or map data. Pre-defined content is prescribed in this standard and applies to all GDF instances. Map data is the actual geographic data for a particular coverage area.

14.2.2 Pre-defined content

14.2.2.1 Overview

For pre-defined content, both the database design (DDL) and data content (DML) are specified in this standard. Most of the data content appears in GDF Annexes. In certain situations, this content can be expanded by individual GDF suppliers as user defined data.

Pre-defined content includes: Attribute Data Type, Attribute Data Unit, Attribute Definition, Attribute Value Code, Attribute Value Data Type, Character Set, Complex Split Indicator, Country Code, Dataset Topic, Ellipsoid Code, Feature Category, Feature Class Code, Feature Theme Code, Grid Code, Language Code, Producer Role, Projection Type Code, Relationship Role, Relationship Type Code, Split Indicator, Topology Type, and Vertical Datum Code.

Name of Entity	Definition Clause	Usage Clause(s)	Content
Attribute Data Type	14.2.2.11.3	14.2.2.11	14.2.2.11.3
Attribute Data Unit	14.2.2.11.4	14.2.2.11	14.2.2.11.4
Attribute Definition	14.2.2.11	14.2.2.12, 14.8, 14.10.4.3	Annex A.2
Attribute Value Code	14.2.2.12	14.8.4	Annex A.2
Attribute Value Data Type	14.2.2.11.2	14.2.2.11	14.2.2.11.2
Character Set	14.2.2.4.2	14.2.2.4.3, 14.4.2.1	14.2.2.4.2
Complex Split Indicator	14.2.2.20	14.6	14.2.2.20
Country Code	14.2.2.3	14.2.2.4.3, 14.4.3.4, 14.4.3.5.3, 14.4.3.8.1, 14.4.3.8.3, 14.4.3.8.4	Annex B.2
Dataset Topic	14.2.2.17	14.4.3.2	14.2.2.17
Ellipsoid Code	14.2.2.6	14.4.3.5.2	Annex B.3.5
Feature Category	14.2.2.8	14.6	14.2.2.8
Feature Class Code	14.2.2.10	14.2.2.12, 14.2.2.16, 14.6	Annex A.1
Feature Theme Code	14.2.2.9	14.2.2.10, 14.4.3.2, 14.4.4	Annex A.1
Grid Code	14.2.2.13	14.4.3.5.5	Annex B.3.2
Horizontal Datum Code	14.2.2.5	14.4.3.5.2	Annex B.3.1
Language Code	14.2.2.4.1	14.2.2.4.3, 14.2.2.4.4, 14.2.2.10, 14.2.2.11, 14.2.2.12, 14.2.2.15, 14.4.2.2, 14.4.2.3, 14.4.3.1, 14.4.3.3, 14.4.3.4, 14.4.3.8.1, 14.4.3.8.2, 14.5.1, 14.11	Annex B.1
Local Character Set	14.2.2.4.3	14.2.2.4.4, 14.4.2.3	*
Local Character Set Text	14.2.2.4.4	14.2.2.10, 14.2.2.11, 14.2.2.12, 14.2.2.15, 14.2.2.7	*
Producer Role	14.2.2.18	14.4.2.1	14.2.2.18
Projection Type Code	14.2.2.14	14.4.3.5.4	Annex B.3.6
Relationship Role	14.2.2.16	14.2.2.15, 14.7.4	Annex A.3.1

Name of Entity	Definition Clause	Usage Clause(s)	Content
Relationship Type Code	14.2.2.15	14.7.2	Annex A.3.1
Split Indicator	14.2.2.19	14.6	14.2.2.19
Topology Type	14.3	14.4.4, 14.4.5, 14.6, 14.7	14.3
Vertical Datum Code	14.2.2.7	14.4.3.5.3	Annex B.3.3

* Pre-defined content only includes those rows needed to support other Pre-defined Content. Usage Clauses therefore only include Pre-defined Content clauses.

14.2.2.2 DLS

14.2.2.2.1 Logical Model

The DLS entity belongs to the context of Data Partitioning (14.4) and ID uniqueness within Datasets, Layers, and Sections. See subclause 14.4.6 for a comprehensive definition.⁷⁸

DLS
* DLS:INTEGER o dataset_ID:INTEGER o layer_ID:INTEGER o section_ID:INTEGER

14.2.2.2.2 Physical Model

Because some Pre-defined Content uses Local Character Set character strings, it is necessary to first create the DLS Table, even though Dataset, Layer, and Section Tables have not yet been created. The DLS referential integrity constraints will be added in 14.4.6.2, once Dataset, Layer, and Section have been defined. For all Pre-defined Content, a DLS value of 0 shall be used which refers to the Album level (dataset_ID = layer_ID = section_ID = NULL).

```

CREATE TABLE DLS
(
  DLS INTEGER,
  DATASET_ID INTEGER,
  LAYER_ID INTEGER,
  SECTION_ID INTEGER,

  CONSTRAINT DLS_PRIMARY_KEY
    PRIMARY KEY (DLS),

  CONSTRAINT DLS_IDS_APPROPRIATELY_NULL
    CHECK (
      (DATASET_ID IS NULL AND LAYER_ID IS NULL AND SECTION_ID IS NULL)
      OR
      (DATASET_ID IS NOT NULL AND LAYER_ID IS NULL AND SECTION_ID IS NULL)
      OR
      (DATASET_ID IS NOT NULL AND LAYER_ID IS NOT NULL AND SECTION_ID IS NULL)
      OR
      (DATASET_ID IS NOT NULL AND LAYER_ID IS NOT NULL AND SECTION_ID IS NOT
        NULL)
    )
)

```

⁷⁸ The physical implementation order dictates the order of entity/table definitions.

NOTE All three of dataset, layer, and section ID must be NULLABLE in order for the referential constraint (with MATCH PARTIAL) to work when any of them are NULL.

14.2.2.3 Country

14.2.2.3.1 Logical Model

GDF uses the three character country codes defined by ISO 3166-1 (see Annex B.2).

COUNTRY_CODE
* country_code:CHAR(3) + country_name:VARCHAR(60)

14.2.2.3.2 Physical Model

```
CREATE TABLE COUNTRY_CODE
(
  COUNTRY_CODE CHAR(3),
  COUNTRY_NAME CHARACTER VARYING(60)
  CONSTRAINT COUNTRY_CODE_COUNTRY_NAME_NOT_NULL
  NOT NULL,

  CONSTRAINT COUNTRY_CODE_PRIMARY_KEY
  PRIMARY KEY(COUNTRY_CODE)
)
```

14.2.2.4 Language and Character Sets

14.2.2.4.1 Language Code

14.2.2.4.1.1 Logical Model

GDF uses the three character language codes defined [1] (see Annex B.1), which may be supplemented by other language codes, as appropriate.

LANGUAGE_CODE
* language_code:CHAR(3) + language_name:VARCHAR(60)

14.2.2.4.1.2 Physical Model

```
CREATE TABLE LANGUAGE_CODE
(
  LANGUAGE_CODE CHAR(3),
  LANGUAGE_NAME CHARACTER VARYING(60)
  CONSTRAINT LANGUAGE_CODE_LANGUAGE_NAME_NOT_NULL
  NOT NULL,

  CONSTRAINT LANGUAGE_CODE_PRIMARY_KEY
  PRIMARY KEY (LANGUAGE_CODE)
)
```

14.2.2.4.2 Character Set

14.2.2.4.2.1 Logical Model

This International Standard anticipates the use of a default character set for all character string data types except for the LCHAR and LVARCHAR. For attributes of type LCHAR and LVARCHAR, a Local Character Set can be used (see Clause 14.2.2.4.3).

Character Sets are uniquely identified by the character set number and shall have an associated character set name. A Character Set can be used as the Album Default Character Set only if the album default only attribute is True (the character set number is limited to values between 1 and 30). Any Character Set may be used as a Local Character Set.

CHARACTER_SET
* char_set_num:INTEGER + char_set_name:VARCHAR(40) + album_default_only:BOOLEAN

Pre-defined content for Character Set is:

CHARACTER SET NUMBER	CHARACTER SET NAME	ALBUM DEFAULT ONLY
1	ISO 8859-1 (Latin-1)	True
2	ISO 8859-2 (Latin-2)	True
3	ISO 8859-3 (Latin-3)	True
4	ISO 8859-4 (Latin-4)	True
5	ISO 8859-5 (Cyrillic)	True
6	ISO 8859-6 (Arabic)	True
7	ISO 8859-7 (Greek)	True
8	ISO 8859-8 (Hebrew)	True
9	ISO 8859-9 (Latin-5)	True
10	ISO 8859-10 (Latin-6)	True
11	ISO 8859-11 (Thai)	True
13	ISO 8859-13 (Latin-7)	True
14	ISO 8859-14 (Latin-8)	True
15	ISO 8859-15 (Latin-9)	True
16	ISO 8859-16 (Latin-10)	True
30	ISO/IEC 10646 Annex D (Unicode - UTF-8)	False
31	ISO/IEC 10646 (Unicode - UCS-2)	False
32	ISO/IEC 10646 (Unicode - UCS-2, big endian)	False
50	Shift-JIS (Japanese)	False
51	KSC-5601 (Korean)	False

14.2.2.4.2.2 Physical Model

```
CREATE TABLE CHARACTER_SET
(
  CHAR_SET_NUM INTEGER,
  CHAR_SET_NAME CHARACTER VARYING(60)
  CONSTRAINT CHARACTER_SET_CHAR_SET_NAME_NOT_NULL
  NOT NULL,
  ALBUM_DEFAULT_ONLY BOOLEAN
  CONSTRAINT CHARACTER_SET_ALBUM_DEFAULT_ONLY_NOT_NULL
  NOT NULL,
```

```
CONSTRAINT CHARACTER_SET_PRIMARY_KEY
PRIMARY KEY(CHAR_SET_NUM)
)
```

```
INSERT INTO CHARACTER_SET VALUES
(1, 'ISO8859-1 (Latin-1)', TRUE)
```

...

14.2.2.4.3 (Pre-defined content) Local Character Set

14.2.2.4.3.1 Logical Model

One or more Local Character Sets may be used in Pre-defined Content data.

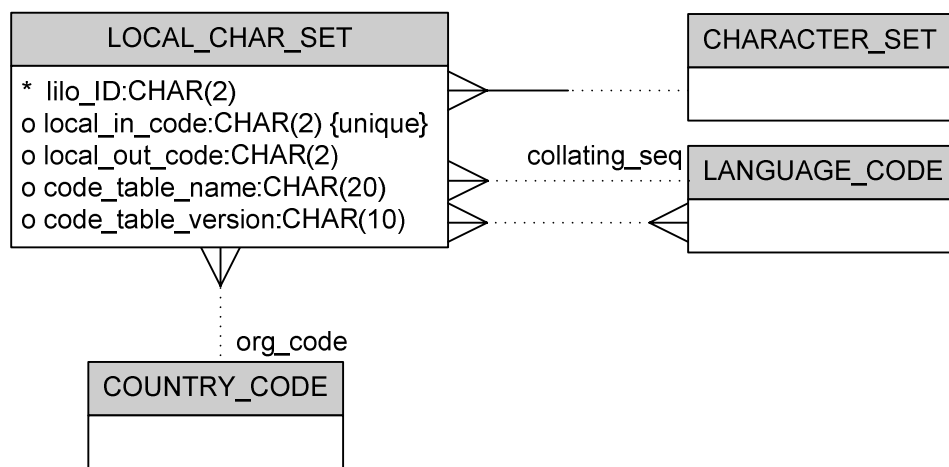

In the MRS, the data type L contains one-byte or multi-byte characters from a character set defined externally and specified in the Local Character Set Definition Record (ALHDREC.02). Such a character set is referred to as a "Local Character Set". The use of characters from a Local Character Set, and the use of characters from the default character set of the GDF Album after the use of characters from a Local Character Set is indicated by the presence of characters from the default character set specially defined for this use and referred to as Local-In and Local-Out. In the MRS, this is done in the Local Character Set Definition Record.

In SQL, the equivalent coding for MRS data type L character strings are either LCHAR and LVARCHAR. Local in and out codes are specified in the Local Character Set Entity. It is assumed that the local in code only appears at the beginning of the LCHAR or LVARCHAR character string.

Each Local Character Set may have a three character organisation code representing the three character country code referencing a Country (see 14.2.2.3).

Each Local Character Set must be associated with a single Character Set, using its integer character set number (see 14.2.2.4.2).

Each Local Character Set may have one or more three-character language codes referencing a Language (see 14.2.2.4.1) and one for specifying the collating sequence..

14.2.2.4.3.2 Physical Model

```
CREATE TABLE LOCAL_CHAR_SET
(
LILO_ID CHAR(2),
LOCAL_IN_CODE CHAR(2),
LOCAL_OUT_CODE CHAR(2),
CODE_TABLE_NAME CHAR(20),
```

```
CODE_TABLE_VERSION CHAR(10),
CHAR_SET_NUM INTEGER
    CONSTRAINT LOCAL_CHAR_SET_CHAR_SET_NUM_NOT_NULL
        NOT NULL,
COLLATING_SEQ CHAR(3),
ORG_CODE CHAR(3),

CONSTRAINT LOCAL_CHAR_SET_PRIMARY_KEY
    PRIMARY KEY (LILO_ID),

CONSTRAINT LOCAL_CHAR_SET_LOCAL_IN_CODE_UNIQUE
    UNIQUE(LOCAL_IN_CODE),

CONSTRAINT LOCAL_CHAR_SET_CHAR_SET_NUM_EXISTS
    FOREIGN KEY(CHAR_SET_NUM)
    REFERENCES CHARACTER_SET(CHAR_SET_NUM),

CONSTRAINT LOCAL_CHAR_SET_COLLATING_SEQ_EXISTS
    FOREIGN KEY(COLLATING_SEQ)
    REFERENCES LANGUAGE_CODE(LANGUAGE_CODE),

CONSTRAINT LOCAL_CHAR_SET_ORG_CODE_EXISTS
    FOREIGN KEY(ORG_CODE)
    REFERENCES COUNTRY_CODE(COUNTRY_CODE)
)
```

```
CREATE TABLE LCHAR_SET_LAN_CODE
(
    LILO_ID CHAR(2),
    LANGUAGE_CODE CHAR(3),

CONSTRAINT LCHAR_SET_LAN_CODE_PRIMARY_KEY
    PRIMARY KEY (LILO_ID, LANGUAGE_CODE),

CONSTRAINT LCHAR_SET_LAN_CODE_LILO_ID_EXISTS
    FOREIGN KEY(LILO_ID)
    REFERENCES LOCAL_CHAR_SET(LILO_ID),

CONSTRAINT LCHAR_SET_LAN_CODE_LANGUAGE_CODE_EXISTS
    FOREIGN KEY(LANGUAGE_CODE)
    REFERENCES LANGUAGE_CODE(LANGUAGE_CODE)
)
```

14.2.2.4.4 (Pre-defined content) Local Character Set Text

14.2.2.4.4.1 Logical Model

In the MRS, each local language string can contain anywhere within the string two bytes, called the Local In Code, which provide a directive to start using a particular character set at this point [e.g., CTRL-L and 8 says start using ISO-Latin-5] then the actual string of that character set, then a trailing two characters that says to stop using this character set

For SQL, it will be assumed that the Local In Code always occurs only at the beginning of the character string

Adopted approach: Local In Codes are defined in the Character Set Code Table specified in the Album's Local Character Set as the code table name. To find the Character Set Name (Character Set Code Table Name) –a Local Character Set Text Table with separate columns for each character set supported by the actual implementation DBMS version. Data type of each column has the SQL definable character set. All local language strings go in this table, in the column with the appropriate character set. Source table of the local

language string has an integer pointer to the correct row in the Local Character Set Text Table, instead of the string itself. The Local In Code gets stripped off on data load but tells what column in the Local Character Set Text table to use. If set is not available put in a special column. This is integrated with the Text table which can contain (long) local language strings as attribute values and therefore the language code and local character set are optional. There is one Foreign Text Table at the Album level which includes a DLS value in each row .

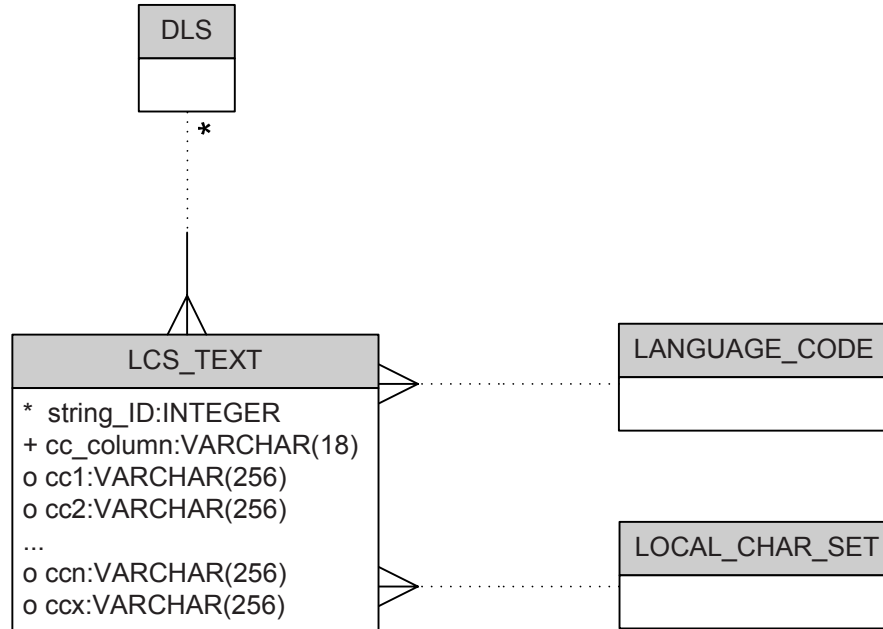

The Local Character Set Text entity provides persistence for character strings of type LCHAR and LVARCHAR. Each such string is uniquely identified within a DLS. The actual string is the appropriate attribute amongst cc1 through ccn or else ccx, as specified by the value of the cc column attribute. Here cc means character set and collating sequence (definable on a per column basis in SQL). The number of possible cc attributes (n) is dependent upon how many character sets and collating sequences are used in the GDF database and are supported by the particular RDBMS vendor. Each vendor has a default character set if no overriding value is provided. Each character set has a vendor-specific default collating sequence if no overriding value is provided. The last attribute, ccx, is used if the vendor does not support the character set used in the GDF file. Only one cc attribute gets the string; all others are NULL.

For example, consider the following L type character strings:

- 1: "road element"
- 2: "ESC-2pièce de rueESC-0"
- 3: "ESC-3StraßeESC-0"
- 4: "ESC-HחובלרESC-0"

String 1 is English (language code = ENG). If cc1 has character set = Latin1 and collating sequence = ASCII, then cc_column = "cc1", cc1 = "road element", and all other cc attributes are NULL.

String 2 is French (language code = FRE). If cc2 has character set = Latin2 and collating sequence = French, then cc_column = "cc2", cc2 = "pièce de rue", and all other cc attributes are NULL.

String 3 is German (language code = GER). If cc3 has character set = Latin2 and collating sequence = German, then cc_column = "cc3", cc3 = "Straße", and all other cc attributes are NULL.

String 4 is Hebrew (language code = HEB). If cc4 has character set = Hebrew and collating sequence = Hebrew, then cc_column = "cc4", cc4 = "רוחב", and all other cc attributes are NULL. If the RDBMS does not support the Hebrew character set, then cc_column = "ccx", ccx = "RJUC", and all other cc attributes are NULL, where the ccx character set = SQL_CHARACTER.

Though this approach facilitates persisting the character strings, it is important to remember that the SQL language does not support variable column (or table) names. One can therefore not retrieve the character string from the column whose name is specified as the value in the cc_column column unless SQL is embedded in a programming language, like Java.

14.2.2.4.4.2 Physical Model

```
CREATE TABLE LCS_TEXT
(
  DLS INTEGER,
  STRING_ID, INTEGER,
  CC_COLUMN CHARACTER VARYING(18)
  CONSTRAINT LCS_TEXT_CC_COLUMN_NOT_NULL
  NOT NULL,
  CC1 CHARACTER VARYING(256),
  CC2 CHARACTER VARYING(256)
  CHARACTER SET <character set name>
  COLLATE <collating sequence name>
  ...
  CCn CHARACTER VARYING(256)
  CHARACTER SET <character set name>
  COLLATE <collating sequence name>
  CCX CHARACTER VARYING(256),
  LANGUAGE_CODE CHAR(3),
  LILO_ID CHAR(2),

  CONSTRAINT LCS_TEXT_PRIMARY_KEY
  PRIMARY KEY (DLS, STRING_ID),

  CONSTRAINT LCS_TEXT_DLS_EXISTS
  FOREIGN KEY(DLS)
  REFERENCES DLS(DLS),

  CONSTRAINT LCS_TEXT_LANGUAGE_CODE_EXISTS
  FOREIGN KEY(LANGUAGE_CODE)
  REFERENCES LANGUAGE_CODE(LANGUAGE_CODE),

  CONSTRAINT LCS_TEXT_LILO_ID_EXISTS
  FOREIGN KEY(LILO_ID)
  REFERENCES LOCAL_CHAR_SET(LILO_ID)
)
```

NOTE **CC1**, **CC2**, **CCn**, and **CCX** are not actual column names; they are variables used to represent column names. Actual column names used by an implementation are implementation defined. At least one of these columns must exist

14.2.2.5 Horizontal Datum

14.2.2.5.1 Logical Model

GDF uses the four character reference codes for horizontal datums defined by ISO/TS 19127 [29] (see Annex B.3.1).

HORIZ_DATUM_CODE
* datum_code:CHAR(4) + datum_name:VARCHAR(160)

14.2.2.5.2 Physical Model

```
CREATE TABLE HORIZ_DATUM_CODE
(
  DATUM_CODE CHAR(4),
  DATUM_NAME CHARACTER VARYING(160)
  CONSTRAINT HORIZ_DATUM_CODE_DATUM_NAME_NOT_NULL
  NOT NULL,

  CONSTRAINT HORIZ_DATUM_CODE_PRIMARY_KEY
  PRIMARY KEY (DATUM_CODE)
)
```

14.2.2.6 Ellipsoid

14.2.2.6.1 Logical Model

GDF uses the two character reference codes for Ellipsoids defined by ISO/TS 19127 [29] (see Annex B.3.5).

ELLIPSOID_CODE
* ellipsoid_code:CHAR(2) + ellipsoid_name:VARCHAR(80)

14.2.2.6.2 Physical Model

```
CREATE TABLE ELLIPSOID_CODE
(
  ELLIPSOID_CODE CHAR(2),
  ELLIPSOID_NAME CHARACTER VARYING(80)
  CONSTRAINT ELLIPSOID_CODE_ELLIPSOID_NAME_NOT_NULL
  NOT NULL,

  CONSTRAINT ELLIPSOID_CODE_PRIMARY_KEY
  PRIMARY KEY (ELLIPSOID_CODE)
)
```

14.2.2.7 Vertical Datum

14.2.2.7.1 Logical Model

Used by a Vertical Datum in a Dataset or Section to specify either the height level of this or an adjacent orthometric reference system.

VERT_DATUM_CODE
* height_level_code:CHAR(2) + height_level_name:LVARCHAR(50)

14.2.2.7.2 Physical Model

```
CREATE TABLE VERT_DATUM_CODE
(
  HEIGHT_LEVEL_CODE CHAR(2),
  HT_LEVEL_DLS INTEGER
  CONSTRAINT VERT_DATUM_CODE_HT_LEVEL_DLS_NOT_NULL
  NOT NULL,
  HT_LEVEL_STRING INTEGER
  CONSTRAINT VERT_DATUM_CODE_HT_LEVEL_STRING_NOT_NULL
  NOT NULL,

  CONSTRAINT VERT_DATUM_CODE_PRIMARY_KEY
  PRIMARY KEY (HEIGHT_LEVEL_CODE),

  CONSTRAINT VERT_DATUM_CODE_HT_LEVEL_EXISTS
  FOREIGN KEY(HT_LEVEL_DLS, HT_LEVEL_STRING)
  REFERENCES LCS_TEXT(DLS, STRING_ID)
  MATCH FULL
)
```

14.2.2.8 Feature Category

14.2.2.8.1 Logical Model

Features can be simple or complex. Simple Features can be Point, Line, or Area Features, depending upon their geometric representation. Complex Features are a combination of Simple Features and can therefore have mixed geometric representations. Features are categorized based on geometric representations.

The four possible values for Feature Category are point, line, area, and complex, represented by category numbers 1 (one) through 4, respectively. Each Feature can only have a single value for Feature Category. All Features have a GDF integer feature ID, unique within a Feature Category (and Dataset, Layer, and Section).

FEATURE_CATEGORY
* feat_category_num:INTEGER + feat_category_name:VARCHAR(10)

Pre-defined content for Feature Category is:

FEATURE CATEGORY NUMBER	FEATURE CATEGORY NAME
1	point
2	line
3	area
4	complex

14.2.2.8.2 Physical Model

```
CREATE TABLE FEATURE_CATEGORY
(
  FEAT_CATEGORY_NUM INTEGER,
  FEAT_CATEGORY_NAME CHARACTER VARYING(10)
  CONSTRAINT FEATURE_CATEGORY_FEAT_CATEGORY_NAME_NOT_NULL
  NOT NULL,

  CONSTRAINT FEATURE_CATEGORY_PRIMARY_KEY
  PRIMARY KEY (FEAT_CATEGORY_NUM)
)
```



```
INSERT INTO FEATURE_CATEGORY VALUES
(1, 'Point')
```

```
INSERT INTO FEATURE_CATEGORY VALUES
(2, 'Line')
```

```
INSERT INTO FEATURE_CATEGORY VALUES
(3, 'Area')
```

```
INSERT INTO FEATURE_CATEGORY VALUES
(4, 'Complex')
```

14.2.2.9 Feature Theme

14.2.2.9.1 Logical Model

Features are broadly organized into Feature Themes, identified with a two digit Feature Theme Code, such as Roads and Ferries (theme code = 41), Waterways (43), and Named Areas (31). For the reason of referential integrity, a special Feature Theme Code of "00" is included in the SQL model which means all Feature Themes.

FEATURE_THEME_CODE
* feature_theme_code:CHAR(2) + feature_theme_name:VARCHAR(30)

14.2.2.9.2 Physical Model

```
CREATE TABLE FEATURE_THEME_CODE
(
  FEATURE_THEME_CODE CHAR(2),
  FEATURE_THEME_NAME CHARACTER VARYING(30)
  CONSTRAINT FEATURE_THEME_CODE_FEATURE_THEME_NAME_NOT_NULL
  NOT NULL,

  CONSTRAINT FEATURE_THEME_CODE_PRIMARY_KEY
  PRIMARY KEY (FEATURE_THEME_CODE)
)

INSERT INTO FEATURE_THEME_CODE VALUES
('00', 'All Feature Themes')
```

14.2.2.10 Feature Class

14.2.2.10.1 Logical Model

Within each Feature Theme, the Feature Class specifies a more specific breakdown of Features. For example, the Roads and Ferries Feature Theme includes Feature Classes for simple Features like Road Element (Class Code = 4110), Junction (4120), and Ferry Connection (4130) as well as for Complex Features like Road (4140), Intersection (4145), and Ferry (4150). For the reason of referential integrity, a special Feature Class Code of "0000" is included in the SQL model which means all Feature Classes.

The first two digits of the Feature Class Code are the same as the Feature Theme Code for the Feature Theme to which the Feature Class belongs. The first two characters of the FEATURE_CLASS. Feature Class Code must equal the FEATURE_CLASS.Feature Theme Code.

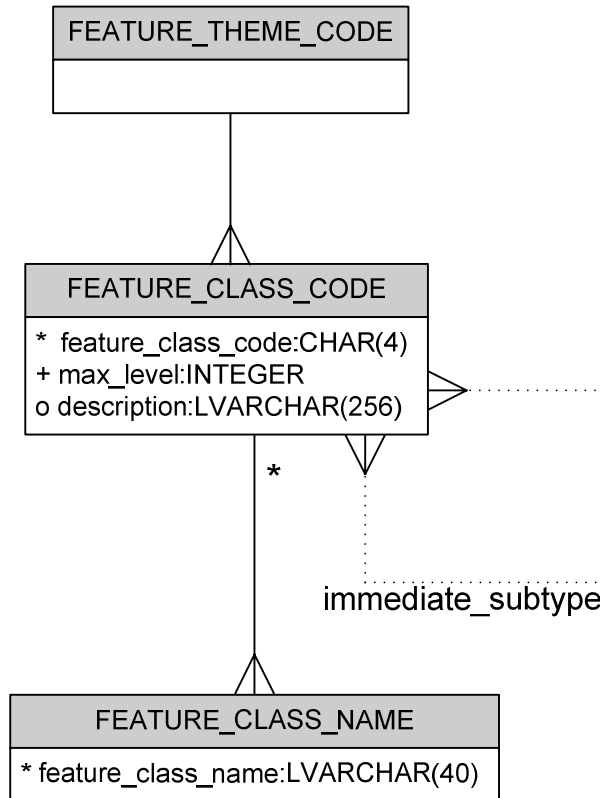

Each Feature Class shall contain the two character theme code referencing Feature Theme (see 14.2.2.9). Each Feature Class must have at least one Feature Class Name. Each Feature Class may have any number of subtypes, where the immediate subtype attribute of the parent Feature Class is the Feature Class Code referencing the child Feature Class. Each Feature Class may have any number of supertypes, where the immediate supertype attribute of the child Feature Class is the Feature Class Code referencing the parent Feature Class.

It is not necessary to distinguish which of the names is the primary name vs. any alternate name(s).

14.2.2.10.2 Physical Model

```

CREATE TABLE FEATURE_CLASS_CODE
(
  FEATURE_CLASS_CODE CHAR(4),
  MAX_LEVEL INTEGER
  CONSTRAINT FEATURE_CLASS_CODE_MAX_LEVEL_NOT_NULL
  NOT NULL,
  DESCRIPTION_DLS INTEGER,
  DESCRIPTION_STRING INTEGER,
  FEATURE_THEME_CODE CHAR(2)
  CONSTRAINT FEATURE_CLASS_CODE_FEATURE_THEME_CODE_NOT_NULL
  NOT NULL,

  CONSTRAINT FEATURE_CLASS_CODE_PRIMARY_KEY
  PRIMARY KEY (FEATURE_CLASS_CODE),

  CONSTRAINT FEATURE_CLASS_CODE_DESCRIPTION_EXISTS
  FOREIGN KEY(DESCRIPTION_DLS, DESCRIPTION_STRING)
  REFERENCES LCS_TEXT(DLS, STRING_ID)
  MATCH FULL,

  CONSTRAINT FEATURE_CLASS_CODE_FEATURE_THEME_CODE_EXISTS
  
```

```

FOREIGN KEY(FEATURE_THEME_CODE)
REFERENCES FEATURE_THEME_CODE(FEATURE_THEME_CODE),

CONSTRAINT FEATURE_CLASS_CODE_MATCHES_THEME_CODE
CHECK (SUBSTRING(FEATURE_CLASS_CODE FROM 1 FOR 2) = FEATURE_THEME_CODE )
)

```

NOTE Existence of at least one FEATURE_CLASS_NAME for each FEATURE_CLASS_CODE is checked after FEATURE_CLASS_NAME table has been created.

```

INSERT INTO FEATURE_CLASS_CODE VALUES
('0000', 1, NULL, NULL, '00')

```

```

CREATE TABLE FEATURE_CLASS_NAME
(
FEATURE_CLASS_CODE CHAR(4),
CLASS_NAME_DLS INTEGER,
CLASS_NAME_STRING INTEGER,

CONSTRAINT FEATURE_CLASS_NAME_PRIMARY_KEY
PRIMARY KEY (FEATURE_CLASS_CODE, CLASS_NAME_DLS, CLASS_NAME_STRING),

CONSTRAINT FEATURE_CLASS_NAME_FEATURE_CLASS_CODE_EXISTS
FOREIGN KEY(FEATURE_CLASS_CODE)
REFERENCES FEATURE_CLASS_CODE(FEATURE_CLASS_CODE),

CONSTRAINT FEATURE_CLASS_NAME_CLASS_NAME_EXISTS
FOREIGN KEY(CLASS_NAME_DLS, CLASS_NAME_STRING)
REFERENCES LCS_TEXT(DLS, STRING_ID)
MATCH FULL
)

```

```

ALTER TABLE FEATURE_CLASS_CODE
ADD CONSTRAINT FEATURE_CLASS_CODE_HAS_FEATURE_CLASS_NAME
CHECK (FEATURE_CLASS_CODE IN
(SELECT FEATURE_CLASS_CODE FROM FEATURE_CLASS_NAME))
DEFERRABLE INITIALLY DEFERRED

```

```

CREATE TABLE FEATURE_CLASS_HIER
(
PARENT_FEAT_CLASS CHAR(4),
CHILD_FEAT_CLASS CHAR(4),

CONSTRAINT FEATURE_CLASS_HIER_PRIMARY_KEY
PRIMARY KEY (PARENT_FEAT_CLASS, CHILD_FEAT_CLASS),

CONSTRAINT FEATURE_CLASS_HIER_PARENT_FEAT_CLASS_EXISTS
FOREIGN KEY(PARENT_FEAT_CLASS)
REFERENCES FEATURE_CLASS_CODE(FEATURE_CLASS_CODE),

CONSTRAINT FEATURE_CLASS_HIER_CHILD_FEAT_CLASS_EXISTS
FOREIGN KEY(CHILD_FEAT_CLASS)
REFERENCES FEATURE_CLASS_CODE(FEATURE_CLASS_CODE)
)

```

14.2.2.11 Attribute Definition

14.2.2.11.1 Attribute Type Code and Name

14.2.2.11.1.1 Logical Model

GDF uses a two character attribute type code, to identify an Attribute Definition. Pre-defined type codes are unique within all of GDF, user-defined type codes are unique within an Album.

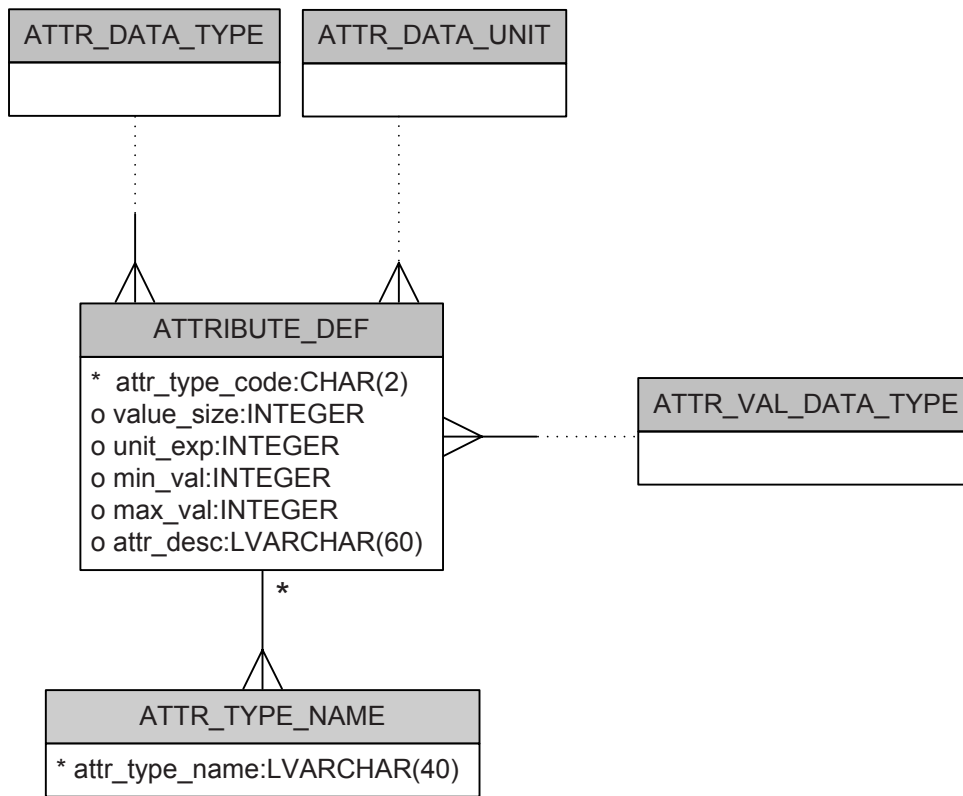

Each Attribute Definition must have at least one Attribute Type Name.

Each Attribute Definition must have an Attribute Value Data Type (see 14.2.2.11.2).

Each Attribute Definition must have an Attribute Data Type. (see 14.2.2.11.3). If the Attribute Data Type is MSR (Measure), then the Attribute Definition must have an Attribute Data Unit (see 14.2.2.11.4). Otherwise the Attribute Definition shall not have an Attribute Data Unit.

14.2.2.11.1.2 Physical Model

NOTE In order to execute below DDLs, it can be necessary to first execute other table layouts related to Attribute Definition (i.e., from other subclauses of 14.2.2.11).

```

CREATE TABLE ATTRIBUTE_DEF
(
    ATTR_TYPE_CODE CHAR(2),
    VALUE_SIZE INTEGER,
    UNIT_EXP INTEGER,
    MIN_VAL INTEGER,
    MAX_VAL INTEGER,
    ATTR_DESC_DLS INTEGER,
    ATTR_DESC_STRING INTEGER,
    ATTR_DATA_TYPE CHAR(3) NOT NULL,

```

```

ATTR_DATA_UNIT CHAR(3),
ATTR_VAL_DATA_TYPE CHAR(2)
    CONSTRAINT ATTRIBUTE_DEF_ATTR_VAL_DATA_TYPE_NOT_NULL
    NOT NULL,

CONSTRAINT ATTRIBUTE_DEF_PRIMARY_KEY
    PRIMARY KEY (ATTR_TYPE_CODE),

CONSTRAINT ATTRIBUTE_DEF_ATTR_DESC_EXISTS
    FOREIGN KEY(ATTR_DESC_DLS, ATTR_DESC_STRING)
    REFERENCES LCS_TEXT(DLS, STRING_ID)
    MATCH FULL,

CONSTRAINT ATTRIBUTE_DEF_ATTR_DATA_TYPE_EXISTS
    FOREIGN KEY(ATTR_DATA_TYPE)
    REFERENCES ATTR_DATA_TYPE(ATTR_DATA_TYPE),

CONSTRAINT ATTRIBUTE_DEF_ATTR_DATA_UNIT_EXISTS
    FOREIGN KEY(ATTR_DATA_UNIT)
    REFERENCES ATTR_DATA_UNIT(ATTR_DATA_UNIT),

CONSTRAINT ATTRIBUTE_DEF_ATTR_VAL_DATA_TYPE_EXISTS
    FOREIGN KEY(ATTR_VAL_DATA_TYPE)
    REFERENCES ATTR_VAL_DATA_TYPE(ATTR_VAL_DATA_TYPE)
)

CREATE TABLE ATTR_TYPE_NAME
(
    ATTR_TYPE_CODE CHAR(2),
    TYPE_NAME_DLS INTEGER,
    TYPE_NAME_STRING INTEGER,

CONSTRAINT ATTR_TYPE_NAME_PRIMARY_KEY
    PRIMARY KEY (ATTR_TYPE_CODE, TYPE_NAME_DLS, TYPE_NAME_STRING),

CONSTRAINT ATTR_TYPE_NAME_ATTR_TYPE_CODE_EXISTS
    FOREIGN KEY(ATTR_TYPE_CODE)
    REFERENCES ATTRIBUTE_DEF(ATTR_TYPE_CODE),

CONSTRAINT ATTR_TYPE_NAME_TYPE_NAME_EXISTS
    FOREIGN KEY(TYPE_NAME_DLS, TYPE_NAME_STRING)
    REFERENCES LCS_TEXT(DLS, STRING_ID)
    MATCH FULL
)

```

14.2.2.11.2 Attribute Value Data Type

14.2.2.11.2.1 Logical Model

When a Feature or Relationship has an Attribute, the data type of the Attribute Value of that Attribute is defined by the Attribute Value Data Type specified by the Attribute Definition of that Attribute Value.

GDF uses a two character attribute value data type code, to identify an Attribute Value Data Type.

ATTR_VAL_DATA_TYPE
* attr_val_data_type:CHAR(2) + val_data_type_name:CHAR(30)

Pre-defined content for Attribute Value Data Type is:

ATTRIBUTE VALUE DATA TYPE	VALUE DATA TYPE NAME
G	Printable characters
A	Alphabetic characters
N	Digits
I	Digits and + or -
AN	Alphabetic and numeric
L	Local characters

14.2.2.11.2.2 Physical Model

```

CREATE TABLE ATTR_VAL_DATA_TYPE
(
  ATTR_VAL_DATA_TYPE CHAR(2),
  VAL_DATA_TYPE_NAME CHARACTER VARYING(30)
  CONSTRAINT ATTR_VAL_DATA_TYPE_VAL_DATA_TYPE_NAME_NOT_NULL
  NOT NULL,

  CONSTRAINT ATTR_VAL_DATA_TYPE_PRIMARY_KEY
  PRIMARY KEY (ATTR_VAL_DATA_TYPE)
)

INSERT INTO ATTR_VAL_DATA_TYPE VALUES
('G', 'Printable characters')

INSERT INTO ATTR_VAL_DATA_TYPE VALUES
('A', 'Alphabetic characters')

INSERT INTO ATTR_VAL_DATA_TYPE VALUES
('N', 'Digits')

INSERT INTO ATTR_VAL_DATA_TYPE VALUES
('I', 'Digits and + or -')

INSERT INTO ATTR_VAL_DATA_TYPE VALUES
('AN', 'Alphabetic and numeric')

INSERT INTO ATTR_VAL_DATA_TYPE VALUES
('L', 'Local characters')

```

14.2.2.11.3 Attribute Data Type

14.2.2.11.3.1 Logical Model

Used by an Attribute Definition to specify the applicable data type of the attribute type.

ATTR_DATA_TYPE
* attr_data_type:CHAR(3) + data_type_name:CHAR(30)

Pre-defined content for Attribute Data Type is:

ATTRIBUTE DATA TYPE	DATA TYPE NAME
COD	Code List
ENM	Enumeration
CNT	Number
BOL	Boolean
BMR	Bit Mask Register
BMI	Bit Mask Integer
TMR	Time Domain
SCS	(Simple) Character String
TXT	(Language-Coded) Text
PRC	Percentage
CMP	Composite
IDN	Identifier
GSD	Geopolitical Structure Definition
PRS	Signed Percentage
MSR	Measure

14.2.2.11.3.2 Physical Model

```
CREATE TABLE ATTR_DATA_TYPE
(
  ATTR_DATA_TYPE CHAR(3),
  DATA_TYPE_NAME CHARACTER VARYING(30)
  CONSTRAINT ATTR_DATA_TYPE_DATA_TYPE_NAME_NOT_NULL
  NOT NULL,

  CONSTRAINT ATTR_DATA_TYPE_PRIMARY_KEY
  PRIMARY KEY (ATTR_DATA_TYPE)
)

INSERT INTO ATTR_DATA_TYPE VALUES
('COD', 'Code List')

...
```

14.2.2.11.4 Attribute Data Unit

14.2.2.11.4.1 Logical Model

Used by an Attribute Definition to specify the unit of measure in which the data values are expressed. (only specified if attribute data type is "MSR").

ATTR_DATA_UNIT
* attr_data_unit:CHAR(3) + data_unit_name:CHAR(30) + is_base_unit:BOOLEAN

Pre-defined content for Attribute Data Unit is:

ATTRIBUTE DATA UNIT	DATA UNIT NAME	IS BASE UNIT
DEG	Degree	True
MTR	Metres	True
KMR	Kilometre	False

INC	Inch	False
FET	Feet	False
MIL	Mile	False
KGR	Kilogram	True
PND	Pound (US pound)	False
KIP	Kilo Pound	False
TON	Ton (metric ton)	False
MIN	Minute (of time)	True
KPH	Kilometres per hour	True
MPH	Miles per hour	False

14.2.2.11.4.2 Physical Model

```

CREATE TABLE ATTR_DATA_UNIT
(
  ATTR_DATA_UNIT CHAR(3),
  DATA_UNIT_NAME CHARACTER VARYING(30) NOT NULL,
  CONSTRAINT ATTR_DATA_UNIT_DATA_UNIT_NAME_NOT_NULL
  NOT NULL,
  IS_BASE_UNIT BOOLEAN NOT NULL,
  CONSTRAINT ATTR_DATA_UNIT_IS_BASE_UNIT_NOT_NULL
  NOT NULL,

  CONSTRAINT ATTR_DATA_UNIT_PRIMARY_KEY
  PRIMARY KEY (ATTR_DATA_UNIT)
)

INSERT INTO ATTR_DATA_UNIT VALUES
('DEG', 'Degree', TRUE)

```

...

14.2.2.12 Attribute Value Code

14.2.2.12.1 Logical Model

For attribute values of attributes with data type code list and enumeration, GDF uses a maximum 11 character attribute value code, unique within an Attribute Type, to distinguish coded Attribute Values.

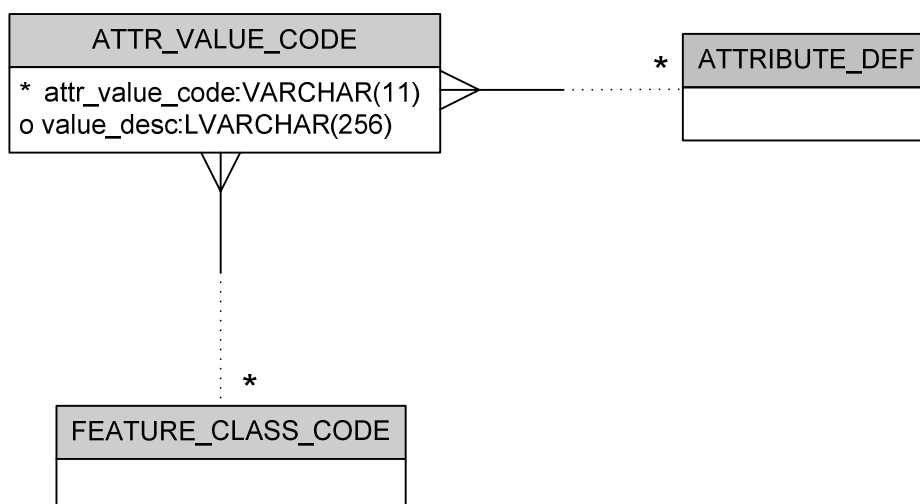

Each Attribute Value must contain the two character attribute type code referencing Attribute Definition (see 14.2.2.11). Each Attribute Value must contain a four-character Feature Class Code referencing Feature Class which may govern the Attribute Value (see 14.2.2.10). If the Attribute Value pertains to all Feature Classes, a Feature Class Code of "0000" shall be used.

14.2.2.12.2 Physical Model

```
CREATE TABLE ATTR_VALUE_CODE
(
  FEATURE_CLASS_CODE CHAR(4),
  ATTR_TYPE_CODE CHAR(2),
  ATTR_VALUE_CODE CHAR(11),
  VALUE_DESC_DLS INTEGER,
  VALUE_DESC_STRING INTEGER,

  CONSTRAINT ATTR_VALUE_CODE_PRIMARY_KEY
    PRIMARY KEY (FEATURE_CLASS_CODE, ATTR_TYPE_CODE, ATTR_VALUE_CODE),

  CONSTRAINT ATTR_VALUE_CODE_FEATURE_CLASS_CODE_EXISTS
    FOREIGN KEY(FEATURE_CLASS_CODE)
    REFERENCES FEATURE_CLASS_CODE(FEATURE_CLASS_CODE),

  CONSTRAINT ATTR_VALUE_CODE_ATTR_TYPE_CODE_EXISTS
    FOREIGN KEY(ATTR_TYPE_CODE)
    REFERENCES ATTRIBUTE_DEF(ATTR_TYPE_CODE),

  CONSTRAINT ATTR_VALUE_CODE_VALUE_DESC_EXISTS
    FOREIGN KEY(VALUE_DESC_DLS, VALUE_DESC_STRING)
    REFERENCES LCS_TEXT(DLS, STRING_ID)
    MATCH FULL
)

```

14.2.2.13 Grid

14.2.2.13.1 Logical Model

GDF uses the two character reference codes for grid systems defined by ISO/TS 19127 [29] (See Annex B.3.2)

GRID_CODE
* grid_code:CHAR(2) + grid_name:VARCHAR(80)

14.2.2.13.2 Physical Model

```
CREATE TABLE GRID_CODE
(
  GRID_CODE CHAR(2),
  GRID_NAME CHARACTER VARYING(80)
  CONSTRAINT GRID_CODE_GRID_CODE_NOT_NULL
  NOT NULL,

  CONSTRAINT GRID_CODE_PRIMARY_KEY
  PRIMARY KEY (GRID_CODE)
)

```

14.2.2.14 Projection Type

14.2.2.14.1 Logical Model

GDF uses the two character reference codes for projection types defined by ISO/TS 19127 [29] (see Annex B.3.6).

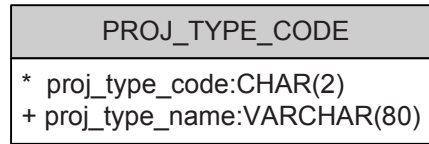

14.2.2.14.2 Physical Model

```
CREATE TABLE PROJ_TYPE_CODE
(
  PROJ_TYPE_CODE CHAR(2),
  PROJ_TYPE_NAME CHARACTER VARYING(80)
  CONSTRAINT PROJ_TYPE_CODE_PROJ_TYPE_NAME_NOT_NULL
  NOT NULL,

  CONSTRAINT PROJ_TYPE_CODE_PRIMARY_KEY
  PRIMARY KEY (PROJ_TYPE_CODE)
)
```

14.2.2.15 Relationship Type

14.2.2.15.1 Logical Model

GDF uses a four character reference code for relationship types.

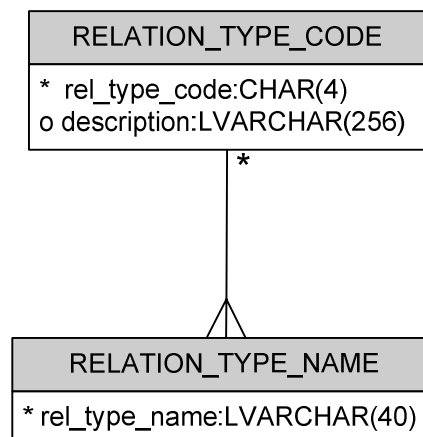

Each Relationship Type must have one or more relationship type names.

14.2.2.15.2 Physical Model

```
CREATE TABLE RELATION_TYPE_CODE
(
  REL_TYPE_CODE CHAR(4),
  DESCRIPTION_DLS INTEGER,
  DESCRIPTION_STRING INTEGER,
```

```

CONSTRAINT RELATION_TYPE_CODE_PRIMARY_KEY
    PRIMARY KEY (REL_TYPE_CODE),

CONSTRAINT RELATION_TYPE_CODE_DESCRIPTION_EXISTS
    FOREIGN KEY(DESCRIPTION_DLS, DESCRIPTION_STRING)
    REFERENCES LCS_TEXT(DLS, STRING_ID)
    MATCH FULL
)

```

NOTE 1 Existence of at least one RELATION_TYPE_NAME for each RELATION_TYPE_CODE is checked after RELATION_TYPE_NAME table has been created.

NOTE 2 Existence of at least one RELATIONSHIP_ROLE for each RELATION_TYPE_CODE is checked after RELATIONSHIP_ROLE table has been created.

```

CREATE TABLE RELATION_TYPE_NAME
(
    REL_TYPE_CODE CHAR(4),
    TYPE_NAME_DLS INTEGER,
    TYPE_NAME_STRING INTEGER,

CONSTRAINT RELATION_TYPE_NAME_PRIMARY_KEY
    PRIMARY KEY (REL_TYPE_CODE, TYPE_NAME_DLS, TYPE_NAME_STRING),

CONSTRAINT RELATION_TYPE_NAME_REL_TYPE_CODE_EXISTS
    FOREIGN KEY(REL_TYPE_CODE)
    REFERENCES RELATION_TYPE_CODE(REL_TYPE_CODE),

CONSTRAINT RELATION_TYPE_NAME_TYPE_NAME_EXISTS
    FOREIGN KEY(TYPE_NAME_DLS, TYPE_NAME_STRING)
    REFERENCES LCS_TEXT(DLS, STRING_ID)
    MATCH FULL
)

ALTER TABLE RELATION_TYPE_CODE
    ADD CONSTRAINT RELATION_TYPE_CODE_HAS_RELATION_TYPE_NAME
    CHECK (REL_TYPE_CODE IN
        (SELECT REL_TYPE_CODE FROM RELATION_TYPE_NAME))
    DEFERRABLE INITIALLY DEFERRED

```

14.2.2.16 Relationship Role

14.2.2.16.1 Logical Model

For each Relationship Type, GDF defines roles for each Feature which participates in the Relationship. Several Features may have the same role, and may be from different Feature Classes.

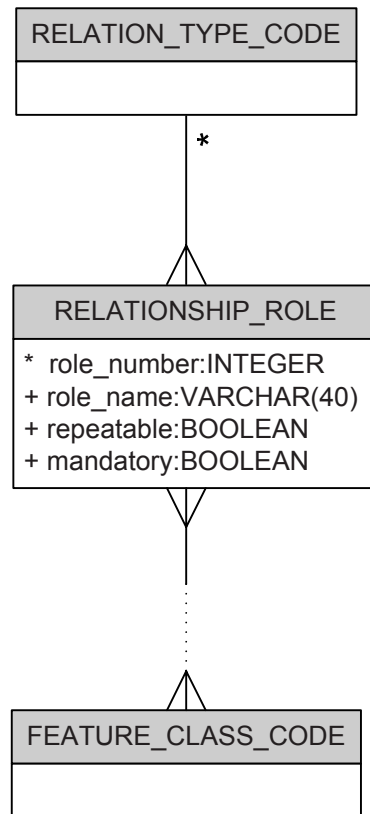

Relationship Roles are identified by an integer role number, unique within the Relationship Type (see 14.2.2.15). Repeatable tells whether this role can repeat, that is, if multiple Features can play this role in each instance of the Relationship Type. Mandatory indicates whether there has to be at least one Feature playing this role in each instance of the Relationship Type. The Feature Classes of all of the Features providing this Role must be specified by including their four character Feature Class Code (see 14.2.2.10).

14.2.2.16.2 Physical Model

```

CREATE TABLE RELATIONSHIP_ROLE
(
  REL_TYPE_CODE CHAR(4),
  ROLE_NUMBER INTEGER,
  ROLE_NAME CHARACTER VARYING(40)
  CONSTRAINT RELATIONSHIP_ROLE_ROLE_NAME_NOT_NULL
  NOT NULL,
  REPEATABLE BOOLEAN
  CONSTRAINT RELATIONSHIP_REPEATABLE_NOT_NULL
  NOT NULL,
  MANDATORY BOOLEAN
  CONSTRAINT RELATIONSHIP_ROLE_MANDATORY_NOT_NULL
  NOT NULL,

  CONSTRAINT RELATIONSHIP_ROLE_PRIMARY_KEY
  PRIMARY KEY (REL_TYPE_CODE, ROLE_NUMBER),

  CONSTRAINT RELATIONSHIP_ROLE_REL_TYPE_CODE_EXISTS
  FOREIGN KEY(REL_TYPE_CODE)
  REFERENCES RELATION_TYPE_CODE(REL_TYPE_CODE)
)
  
```

```
ALTER TABLE RELATION_TYPE_CODE
ADD CONSTRAINT RELATION_TYPE_CODE_HAS_RELATIONSHIP_ROLE
CHECK (REL_TYPE_CODE IN
(SELECT REL_TYPE_CODE FROM RELATION_TYPE_ROLE))
DEFERRABLE INITIALLY DEFERRED

CREATE TABLE REL_ROLE_FEAT_CLAS
(
REL_TYPE_CODE CHAR(4),
ROLE_NUMBER INTEGER,
FEATURE_CLASS_CODE CHAR(4),

CONSTRAINT REL_ROLE_FEAT_CLAS_PRIMARY_KEY
PRIMARY KEY (REL_TYPE_CODE, ROLE_NUMBER, FEATURE_CLASS_CODE),

CONSTRAINT REL_ROLE_FEAT_CLAS_REL_ROLE_EXISTS
FOREIGN KEY(REL_TYPE_CODE, ROLE_NUMBER)
REFERENCES RELATIONSHIP_ROLE(REL_TYPE_CODE, ROLE_NUMBER),

CONSTRAINT REL_ROLE_FEAT_CLAS_FEATURE_CLASS_CODE_EXISTS
FOREIGN KEY(FEATURE_CLASS_CODE)
REFERENCES FEATURE_CLASS_CODE(FEATURE_CLASS_CODE)
)

```

14.2.2.17 Dataset Topic

14.2.2.17.1 Logical Model

The Dataset Topic specifies the main theme of a Dataset. It is uniquely identified by a topic number and shall have an associated topic name (see Annex B.4.3; consistent with ISO 19115) [24].

DATASET_TOPIC
* topic_num:INTEGER + topic_name:VARCHAR(34)

Pre-defined content for Dataset Topic is:

TOPIC NUMBER	TOPIC NAME
1	farming
2	biota
3	boundaries
4	climatology/meteorology/atmosphere
5	economy
6	elevation
7	environment
8	geoscientific information
9	health
10	imagery base maps earth cover
11	intelligenceMilitary
12	inlandWaters
13	location
14	oceans
15	planning cadastre
16	society
17	structure
18	transportation
19	utilities communication

14.2.2.17.2 Physical Model

```
CREATE TABLE DATASET_TOPIC
(
  TOPIC_NUM INTEGER,
  TOPIC_NAME CHARACTER VARYING(40)
  CONSTRAINT DATASET_TOPIC_TOPIC_NAME_NOT_NULL
  NOT NULL,

  CONSTRAINT DATASET_TOPIC_PRIMARY_KEY
  PRIMARY KEY (TOPIC_NUM)
)

INSERT INTO DATASET_TOPIC VALUES
(1, 'farming')
```

...

14.2.2.18 Producer Role

14.2.2.18.1 Logical Model

The Producer Role is used to specify the function performed by the main producer and/or deliverer of an Album (see Annex B.4.2; consistent with ISO 19115) [24]

PRODUCER_ROLE
* producer_role_num:INTEGER + producer_role_name:VARCHAR(22)

Pre-defined content for Producer Role is:

PRODUCER ROLE NUMBER	PRODUCER ROLE NAME
1	resource provider
2	custodian
3	owner
4	user
5	distributor
6	originator
7	point of contact
8	principal investigator
9	processor
10	publisher
11	author

14.2.2.18.2 Physical Model

```
CREATE TABLE PRODUCER_ROLE
(
  PRODUCER_ROLE_NUM INTEGER,
  PRODUCER_ROLE_NAME CHARACTER VARYING(40)
  CONSTRAINT PRODUCER_ROLE_PRODUCER_ROLE_NAME_NOT_NULL
  NOT NULL,
```

```
CONSTRAINT PRODUCER_ROLE_PRIMARY_KEY
PRIMARY KEY (PRODUCER_ROLE_NUM)
)
```

```
INSERT INTO PRODUCER_ROLE VALUES
(1, 'resource provider')
```

...

14.2.2.19 Split Indicator

14.2.2.19.1 Logical Model

Used by a Line or Area Feature to specify whether the Line or Area Feature represents an entire Feature or part of a split Feature:

SPLIT_INDICATOR
* split_indicator:INTEGER + description:VARCHAR(60)

Pre-defined content for Split Indicator is:

SPLIT INDICATOR	DESCRIPTION
0	Line or Area Feature represents an entire Feature
1	Line or Area Feature represents part of a split Feature

14.2.2.19.2 Physical Model

```
CREATE TABLE SPLIT_INDICATOR
(
SPLIT_INDICATOR INTEGER,
DESCRIPTION CHARACTER VARYING(60)
CONSTRAINT SPLIT_INDICATOR_DESCRIPTION_NOT_NULL
NOT NULL,

CONSTRAINT SPLIT_INDICATOR_PRIMARY_KEY
PRIMARY KEY (SPLIT_INDICATOR)
)

INSERT INTO SPLIT_INDICATOR VALUES
(0, 'Line or Area Feature represents an entire feature')

INSERT INTO SPLIT_INDICATOR VALUES
(1, 'Line or Area Feature represents part of a split feature')
```

14.2.2.20 Complex Split Indicator

14.2.2.20.1 Logical Model

Used by a Complex Feature to specify whether the Complex Feature represents an entire Feature or part of a split Feature or if the definition is repeated in another Section:

COMPLEX_SPLIT_IND
* complex_split_ind:INTEGER + description:VARCHAR(60)

Pre-defined content for Complex Split Indicator is:

SPLIT INDICATOR	DESCRIPTION
0	Complex Feature represents an entire Feature
1	Complex Feature represents part of a split Feature
2	The definition is repeated in another Section

14.2.2.20.2 Physical Model

```
CREATE TABLE COMPLEX_SPLIT_IND
(
  COMPLEX_SPLIT_IND INTEGER,
  DESCRIPTION CHARACTER VARYING(60)
  CONSTRAINT COMPLEX_SPLIT_IND_DESCRIPTION_NOT_NULL
  NOT NULL,

  CONSTRAINT COMPLEX_SPLIT_IND_PRIMARY_KEY
  PRIMARY KEY (COMPLEX_SPLIT_IND)
)

INSERT INTO COMPLEX_SPLIT_IND VALUES
(0, 'Complex Feature represents an entire feature')

INSERT INTO COMPLEX_SPLIT_IND VALUES
(1, 'Complex Feature represents part of a split feature')

INSERT INTO COMPLEX_SPLIT_IND VALUES
(2, 'The definition is repeated in another Section')
```

14.2.3 Map Data

For map data, only the DDL is specified. Individual suppliers of the GDF map data will provide the content of these tables. This includes Features, Relationships between Features, and Attributes of Features and their Relationships.

14.3 Topology Type

14.3.1 Logical Model

Features can be represented by one of three topology methods: the two explicit topology types planar full (PF) and non-planar connectivity (NPC) and the non-explicit topology (NET) type.

TOPOLOGY_TYPE
* topology_type:CHAR(3) + topology_desc:VARCHAR(30)

Pre-defined content for Topology Type is:

TOPOLOGY TYPE	TOPOLOGY DESCRIPTION
PF	Planar Full
NPC	Non Planar Connectivity
NET	Non Explicit Topology

14.3.2 Physical Model

```

CREATE TABLE TOPOLOGY_TYPE
(
  TOPOLOGY_TYPE CHAR(3),
  TOPOLOGY_DESC CHARACTER VARYING(30)
  CONSTRAINT TOPOLOGY_TYPE_TOPOLOGY_DESC_NOT_NULL
  NOT NULL,

  CONSTRAINT TOPOLOGY_TYPE_PRIMARY_KEY
  PRIMARY KEY (TOPOLOGY_TYPE)
)

INSERT INTO TOPOLOGY_TYPE VALUES
('PF', 'Planar Full')

INSERT INTO TOPOLOGY_TYPE VALUES
('NPC', 'Non Planar Connectivity')

INSERT INTO TOPOLOGY_TYPE VALUES
('NET', 'Non Explicit Topology')

```

14.4 Data partitioning

14.4.1 Overview

Location-specific data is contained / distributed as a single GDF Album. An Album is hierarchically partitioned into Datasets, Layers, and Sections.

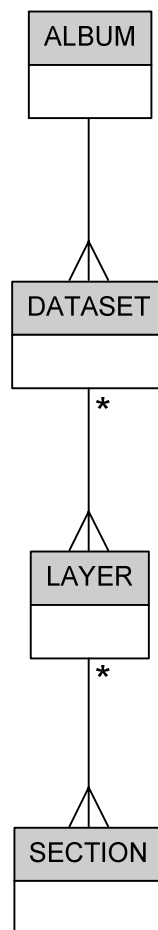

14.4.2 Album

14.4.2.1 Album Entity

14.4.2.1.1 Logical Model

The aggregation of all of the information pertaining to a particular geographic area, published at a particular moment by a certain supplier, is called an Album. Every GDF SQL database shall have one Album entity.

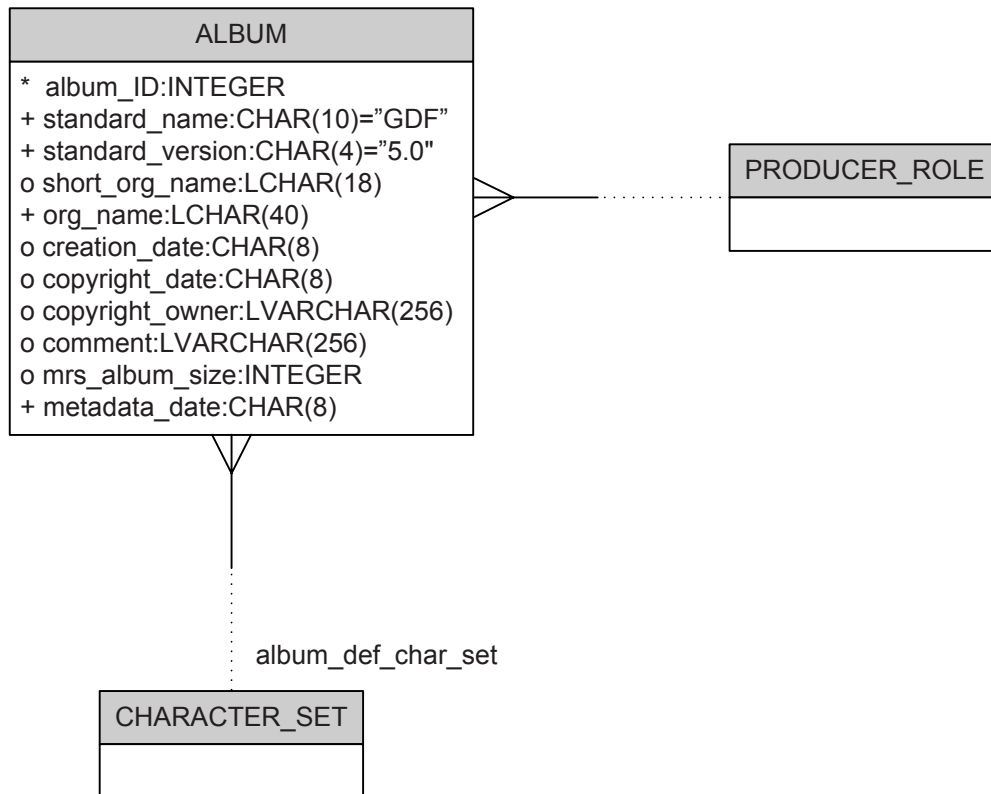

The Album's default Character Set is identified by an integer character set number referencing Character Set. It can only use Character Set values which have an album default only value of TRUE (see 14.2.2.4.2).

The Producer Role is used to specify the function performed by the main producer and/or deliverer of an Album. It is identified by an integer producer role number referencing Producer Role (see 14.2.2.18).

14.4.2.1.2 Physical Model

```

CREATE TABLE ALBUM
(
  ALBUM_ID INTEGER,
  STANDARD_NAME CHAR(10) DEFAULT 'GDF'
  CONSTRAINT ALBUM_STANDARD_NAME_NOT_NULL
  NOT NULL,
  STANDARD_VERSION CHAR(4) DEFAULT '5.0'
  CONSTRAINT ALBUM_STANDARD_VERSION_NOT_NULL
  NOT NULL,
  SHORT_ORG_DLS INTEGER,
  SHORT_ORG_STRING INTEGER,
  ORG_NAME_DLS INTEGER
  CONSTRAINT ALBUM_ORG_NAME_DLS_NOT_NULL
  NOT NULL,
  ORG_NAME_STRING INTEGER
  CONSTRAINT ALBUM_ORG_NAME_STRING_NOT_NULL
  NOT NULL,
  CREATION_DATE CHAR(8),
  COPYRIGHT_DATE CHAR(8),
  CPYRT_OWNER_DLS INTEGER,
  CPYRT_OWNER_STRING INTEGER,
  COMMENT_DLS INTEGER,
  COMMENT_STRING INTEGER,
  MRS_ALBUM_SIZE INTEGER,

```

```
METADATA_DATE CHAR(8)
    CONSTRAINT ALBUM_METADATA_DATE_NOT_NULL
    NOT NULL,
ALBUM_DEF_CHAR_SET INTEGER
    CONSTRAINT ALBUM_ALBUM_DEF_CHAR_SET_NOT_NULL
    NOT NULL,
PRODUCER_ROLE_NUM INTEGER
    CONSTRAINT ALBUM_PRODUCER_ROLE_NUM_NOT_NULL
    NOT NULL,

CONSTRAINT ALBUM_PRIMARY_KEY
    PRIMARY KEY (ALBUM_ID),

CONSTRAINT ALBUM_SHORT_ORG_EXISTS
    FOREIGN KEY(SHORT_ORG_DLS, SHORT_ORG_STRING)
    REFERENCES LCS_TEXT(DLS, STRING_ID)
    MATCH FULL,

CONSTRAINT ALBUM_ORG_NAME_EXISTS
    FOREIGN KEY(ORG_NAME_DLS, ORG_NAME_STRING)
    REFERENCES LCS_TEXT(DLS, STRING_ID)
    MATCH FULL,

CONSTRAINT ALBUM_CPYRT_OWNER_EXISTS
    FOREIGN KEY(CPYRT_OWNER_DLS, CPYRT_OWNER_STRING)
    REFERENCES LCS_TEXT(DLS, STRING_ID)
    MATCH FULL,

CONSTRAINT ALBUM_COMMENT_EXISTS
    FOREIGN KEY(COMMENT_DLS, COMMENT_STRING)
    REFERENCES LCS_TEXT(DLS, STRING_ID)
    MATCH FULL,

CONSTRAINT ALBUM_ALBUM_DEF_CHAR_SET_EXISTS
    FOREIGN KEY(ALBUM_DEF_CHAR_SET)
    REFERENCES CHARACTER_SET(CHAR_SET_NUM),

CONSTRAINT ALBUM_PRODUCER_ROLE_NUM_EXISTS
    FOREIGN KEY(PRODUCER_ROLE_NUM)
    REFERENCES PRODUCER_ROLE (PRODUCER_ROLE_NUM)
)
```

NOTE Existence of at least one DATASET for each ALBUM is checked after DATASET table has been created.

14.4.2.2 Local Character Set

One or more Local Character Sets may be used for Map Data in an Album for Multilanguage support, in the same manner as for Pre-defined Content (see 14.2.2.4.3).

14.4.2.3 Multilanguage support

As was done with Pre-defined Content, Map Data Multilanguage character strings (LCHAR and LVARCHAR) shall be kept as LCS_Text (see 14.2.2.4.4). Attribute value character strings greater than 11 characters in length (TXT records in the MRS) shall be handled in the same manner (see 14.8.4).

14.4.3 Dataset

14.4.3.1 Overview

The Dataset represents a macro-geographic partitioning of Features. For example, an Album which contains all the Features in the US may be broken down into 50 Datasets, one for each State.

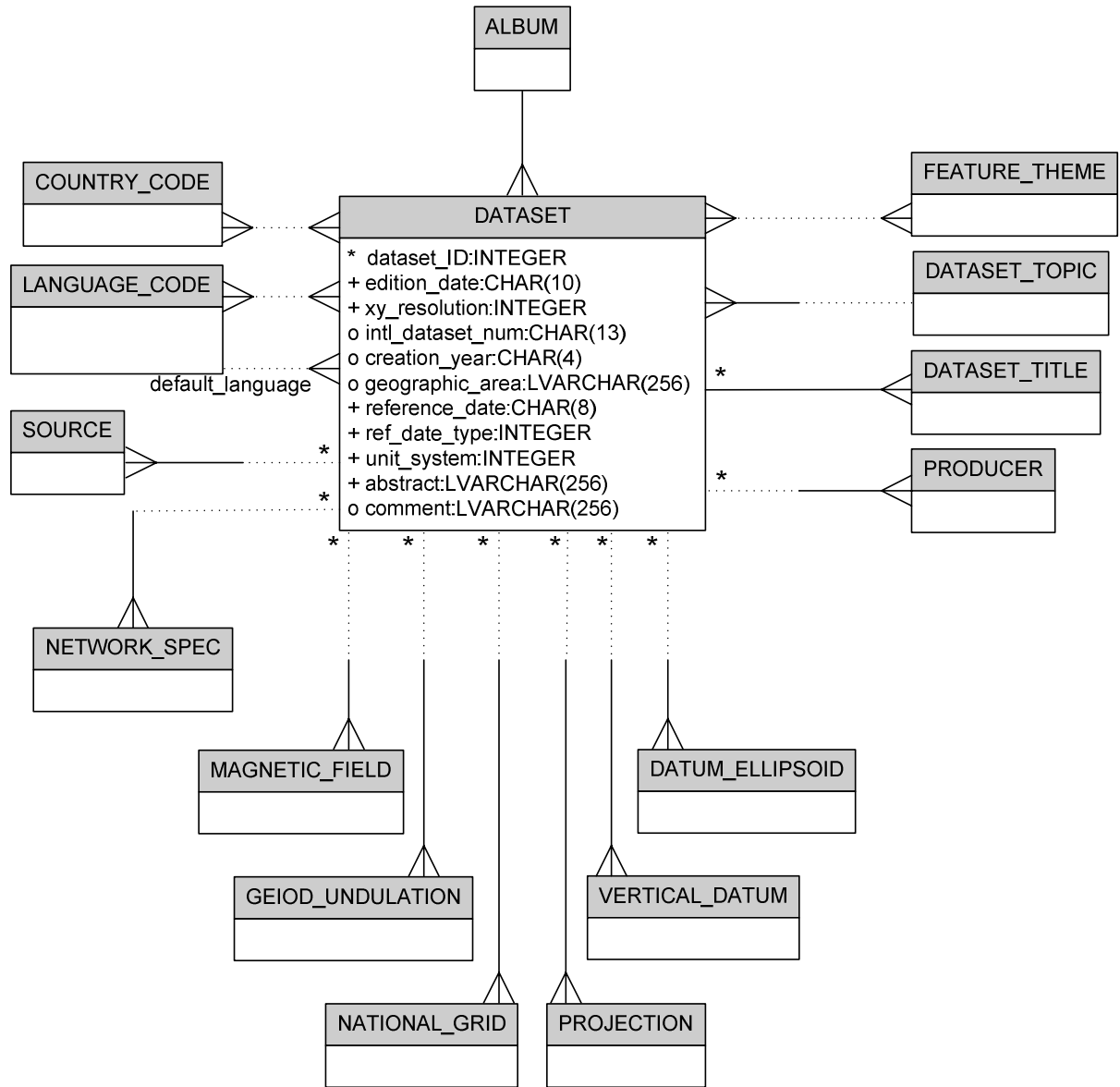

Each Dataset entity contains information about the Dataset itself, traditionally contained in the Dataset header record and associated sub-records in the Media Records Specification, including pre-defined content (Countries, Languages, Feature Themes, Dataset Topic), Dataset Titles, and Producers.

Additionally, information about the geodetic parameters (Horizontal and Vertical Datums, Ellipsoids, Projections, National Grids, Geoid Undulations, and Earth Magnetic Fields), Network Specifications, and data Sources used by Sections owned by the Dataset, are defined at the Dataset level so as not to have to be repeated for each Section which uses them.

Every GDF SQL database shall have at least one Dataset entity.

14.4.3.2 Dataset Header Information

14.4.3.2.1 Logical Model

Each Dataset is uniquely identified by its dataset ID. The edition date, XY resolution, reference date, reference date type, unit system, and abstract must be specified. The International dataset number, currency (creation year), and extensiveness (geographic area) are optional.

Unit system values include:

1 = Metric

2 = English

Reference date type values include (see Annex B.4.1):

1 = Creation

2 = Publication

3 = Revision

Pre-defined content (Countries, Languages, and Feature Themes) are optional; Dataset Topic is mandatory. These are all defined in the content section above. A Dataset may have any number of three character country codes, each referencing a Country (see 14.2.2.3). A Dataset may have a three character default language corresponding to a language code which references a Language as well as any number of language codes to specify the Language(s) used in the Dataset (see 14.2.2.4.1). The Dataset may specify a list of all of the Feature Theme Codes referencing Feature Themes of all of the Features contained within all of the Sections owned by the Dataset (see 14.2.2.9). A single integer topic number must be included for each Dataset, referencing a Dataset Topic (see 14.2.2.17). Each Dataset must have at least one Dataset Title (see 14.4.3.3).

14.4.3.2.2 Physical Model

```
CREATE TABLE DATASET
(
  DATASET_ID INTEGER,
  EDITION_DATE CHAR(10)
    CONSTRAINT DATASET_EDITION_DATE_NOT_NULL
    NOT NULL,
  XY_RESOLUTION INTEGER
    CONSTRAINT DATASET_XY_RESOLUTION_NOT_NULL
    NOT NULL,
  INIT_DATASET_NUM CHAR(13),
  CREATION_YEAR CHAR(4),
  GEO_AREA_DLS INTEGER,
  GEO_AREA_STRING INTEGER,
  REFERENCE_DATE CHAR(8)
    CONSTRAINT DATASET_REFERENCE_DATE_NOT_NULL
    NOT NULL,
  REF_DATE_TYPE CHARACTER VARYING(11)
    CONSTRAINT DATASET_REF_DATE_TYPE_NOT_NULL
    NOT NULL,
  UNIT_SYSTEM CHARACTER VARYING(7)
    CONSTRAINT DATASET_UNIT_SYSTEM_NOT_NULL
    NOT NULL,
  ABSTRACT_DLS INTEGER
    CONSTRAINT DATASET_ABSTRACT_DLS_NOT_NULL
    NOT NULL,
```

```

ABSTRACT_STRING INTEGER
    CONSTRAINT DATASET_ABSTRACT_STRING_NOT_NULL
    NOT NULL,
COMMENT_DLS INTEGER,
COMMENT_STRING INTEGER,
ALBUM_ID INTEGER
    CONSTRAINT DATASET_ALBUM_ID_NOT_NULL
    NOT NULL,
DEFAULT_LANGUAGE CHAR(3),
TOPIC_NUM INTEGER
    CONSTRAINT DATASET_TOPIC_NUM_NOT_NULL
    NOT NULL,

CONSTRAINT DATASET_PRIMARY_KEY
    PRIMARY KEY (DATASET_ID),

CONSTRAINT DATASET_GEO_AREA_EXISTS
    FOREIGN KEY(GEO_AREA_DLS, GEO_AREA_STRING)
    REFERENCES LCS_TEXT(DLS, STRING_ID)
    MATCH FULL,

CONSTRAINT DATASET_ABSTRACT_EXISTS
    FOREIGN KEY(ABSTRACT_DLS, ABSTRACT_STRING)
    REFERENCES LCS_TEXT(DLS, STRING_ID)
    MATCH FULL,

CONSTRAINT DATASET_COMMENT_EXISTS
    FOREIGN KEY(COMMENT_DLS, COMMENT_STRING)
    REFERENCES LCS_TEXT(DLS, STRING_ID)
    MATCH FULL,

CONSTRAINT DATASET_ALBUM_ID_EXISTS
    FOREIGN KEY(ALBUM_ID)
    REFERENCES ALBUM(ALBUM_ID),

CONSTRAINT DATASET_DEFAULT_LANGUAGE_EXISTS
    FOREIGN KEY(DEFAULT_LANGUAGE)
    REFERENCES LANGUAGE_CODE(LANGUAGE_CODE),

CONSTRAINT DATASET_TOPIC_NUM_EXISTS
    FOREIGN KEY(TOPIC_NUM)
    REFERENCES DATASET_TOPIC(TOPIC_NUM)
)

```

```

ALTER TABLE ALBUM
    ADD CONSTRAINT ALBUM_HAS_DATASET_ROLE
    CHECK (ALBUM_ID IN
        (SELECT ALBUM_ID FROM DATASET))
    DEFERRABLE INITIALLY DEFERRED

```

NOTE 1 Existence of at least one LAYER for each DATASET is checked after LAYER table has been created.

NOTE 2 Existence of at least one DATASET_TITLE for each DATASET is checked after DATASET_TITLE table has been created.

```

CREATE TABLE DATASET_LAN_CODE
(
    DATASET_ID INTEGER,
    LANGUAGE_CODE CHAR(3),

```

```
CONSTRAINT DATASET_LAN_CODE_PRIMARY_KEY
    PRIMARY KEY (DATASET_ID, LANGUAGE_CODE),

CONSTRAINT DATASET_LAN_CODE_DATASET_ID_EXISTS
    FOREIGN KEY(DATASET_ID)
    REFERENCES DATASET(DATASET_ID),

CONSTRAINT DATASET_LAN_CODE_LANGUAGE_CODE_EXISTS
    FOREIGN KEY(LANGUAGE_CODE)
    REFERENCES LANGUAGE_CODE(LANGUAGE_CODE)
)

CREATE TABLE DATASET_COUNTRY
(
    DATASET_ID INTEGER,
    COUNTRY_CODE CHAR(3),

    CONSTRAINT DATASET_COUNTRY_PRIMARY_KEY
        PRIMARY KEY (DATASET_ID, COUNTRY_CODE),

    CONSTRAINT DATASET_COUNTRY_DATASET_ID_EXISTS
        FOREIGN KEY(DATASET_ID)
        REFERENCES DATASET(DATASET_ID),

    CONSTRAINT DATASET_COUNTRY_COUNTRY_CODE_EXISTS
        FOREIGN KEY(COUNTRY_CODE)
        REFERENCES COUNTRY_CODE(COUNTRY_CODE)
)

CREATE TABLE DATASET_FEAT_THEME
(
    DATASET_ID INTEGER,
    FEATURE_THEME_CODE CHAR(2),

    CONSTRAINT DATASET_FEAT_THEME_PRIMARY_KEY
        PRIMARY KEY (DATASET_ID, FEATURE_THEME_CODE),

    CONSTRAINT DATASET_FEAT_THEME_DATASET_ID_EXISTS
        FOREIGN KEY(DATASET_ID)
        REFERENCES DATASET(DATASET_ID),

    CONSTRAINT DATASET_FEAT_THEME_FEATURE_THEME_CODE_EXISTS
        FOREIGN KEY(FEATURE_THEME_CODE)
        REFERENCES FEATURE_THEME_CODE(FEATURE_THEME_CODE)
)
```

14.4.3.3 Dataset Title

14.4.3.3.1 Logical Model

Each Dataset must contain at least one Dataset Title which provide names for the Dataset.

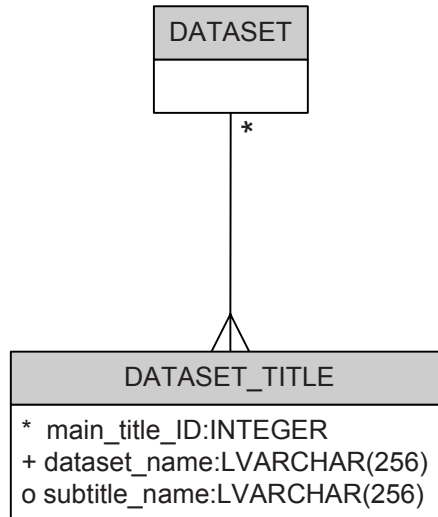

Each Dataset Title is identified by a main title ID unique within the Dataset. Each Dataset Title must contain a dataset name and optionally a subtitle name.

14.4.3.3.2 Physical Model

```

CREATE TABLE DATASET_TITLE
(
    DATASET_ID INTEGER,
    MAIN_TITLE_ID INTEGER,
    DATASET_DLS INTEGER
        CONSTRAINT TITLE_DATASET_DLS_NOT_NULL
        NOT NULL,
    DATASET_STRING INTEGER
        CONSTRAINT TITLE_DATASET_STRING_NOT_NULL
        NOT NULL,
    SUBTITLE_DLS INTEGER,
    SUBTITLE_STRING INTEGER,

    CONSTRAINT DATASET_TITLE_PRIMARY_KEY
        PRIMARY KEY (DATASET_ID, MAIN_TITLE_ID),

    CONSTRAINT TITLE_DATASET_ID_EXISTS
        FOREIGN KEY(DATASET_ID)
        REFERENCES DATASET(DATASET_ID),

    CONSTRAINT TITLE_DATASET_EXISTS
        FOREIGN KEY(DATASET_DLS, DATASET_STRING)
        REFERENCES LCS_TEXT(DLS, STRING_ID)
        MATCH FULL,

    CONSTRAINT TITLE_SUBTITLE_EXISTS
        FOREIGN KEY(SUBTITLE_DLS, SUBTITLE_STRING)
        REFERENCES LCS_TEXT(DLS, STRING_ID)
        MATCH FULL
)

ALTER TABLE DATASET
ADD CONSTRAINT DATASET_HAS_DATASET_TITLE
CHECK (DATASET_ID IN
(SELECT DATASET_ID FROM DATASET_TITLE))
DEFERRABLE INITIALLY DEFERRED
    
```

14.4.3.4 Producer

14.4.3.4.1 Logical Model

Each Dataset may contain Producers which specify who produced the Dataset and where it was produced.

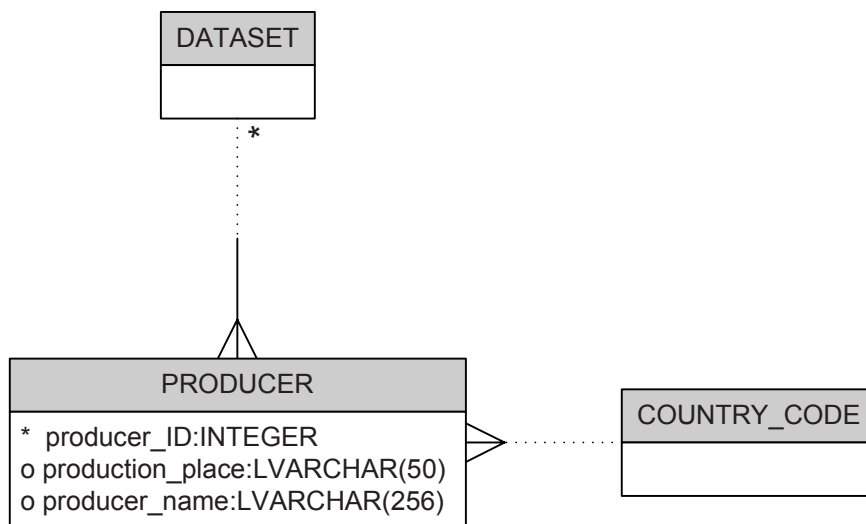

Each Producer is identified by a producer ID unique within the Dataset. Each Producer may contain a production place, a producer name, and a three-character country code referencing Country (see 14.2.2.3) of the production place.

14.4.3.4.2 Physical Model

```

CREATE TABLE PRODUCER
(
  DATASET_ID INTEGER,
  PRODUCER_ID INTEGER,
  PLACE_DLS INTEGER,
  PLACE_STRING INTEGER,
  PRODUCER_DLS INTEGER,
  PRODUCER_STRING INTEGER,
  COUNTRY_CODE CHAR(3),

  CONSTRAINT PRODUCER_PRIMARY_KEY
    PRIMARY KEY (DATASET_ID, PRODUCER_ID),

  CONSTRAINT PRODUCER_DATASET_ID_EXISTS
    FOREIGN KEY(DATASET_ID)
    REFERENCES DATASET(DATASET_ID),

  CONSTRAINT PRODUCER_PLACE_EXISTS
    FOREIGN KEY(PLACE_DLS, PLACE_STRING)
    REFERENCES LCS_TEXT(DLS, STRING_ID)
    MATCH FULL,

  CONSTRAINT PRODUCER_PRODUCER_EXISTS
    FOREIGN KEY(PRODUCER_DLS, PRODUCER_STRING)
    REFERENCES LCS_TEXT(DLS, STRING_ID)
    MATCH FULL,

```

```

  CONSTRAINT PRODUCER_COUNTRY_CODE_EXISTS
  FOREIGN KEY(COUNTRY_CODE)
  REFERENCES COUNTRY_CODE(COUNTRY_CODE)
  )
  
```

14.4.3.5 Geodetic Parameters

14.4.3.5.1 Overview

In a Dataset, all the geodetic parameters needed for the correct interpretation of the X, Y and Z coordinates have to be described explicitly so that the coordinates can be transformed into any other coordinate system.

The descriptions of the geodetic parameters are given at the Dataset level, and are provided with an identification number so that they can be referred to by the Sections for which they are relevant.

14.4.3.5.2 Datum and Ellipsoid

14.4.3.5.2.1 Logical Model

The geodetic (horizontal) Datum that underlies a particular National Grid is needed in order to be able to shift from one geographical coordinate system into another.

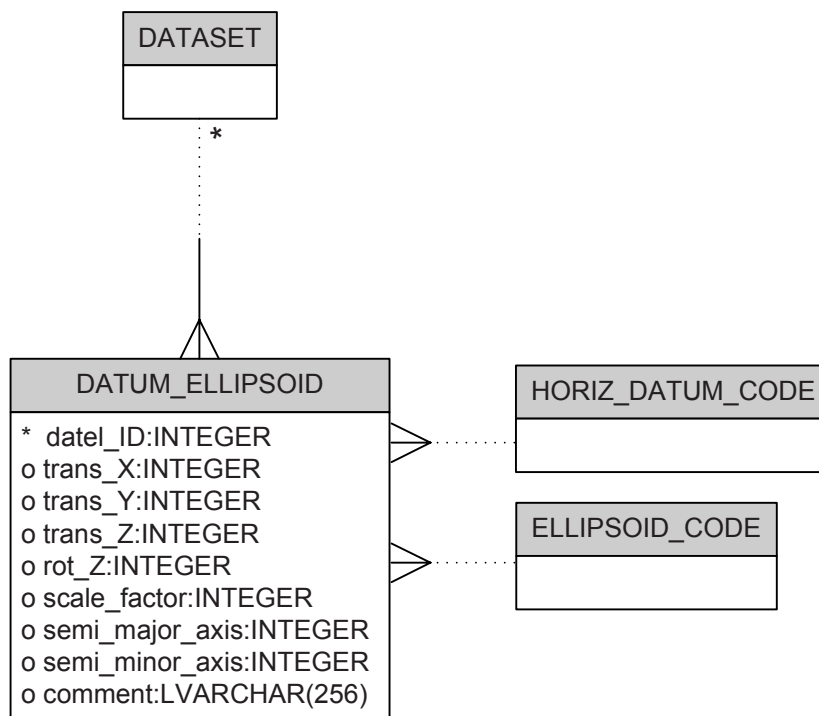

The combined Datum and Ellipsoid entity is identified by a datel ID, unique within the Dataset. All attributes are optional, including the four character datum code referencing a Horizontal Datum and a two character ellipsoid code referencing an Ellipsoid, both selected from the pre-defined content section above (see 14.2.2.5 and 14.2.2.6, respectively).

Any Section in the Dataset must reference the appropriate Horizontal Datum and Ellipsoid entity by using its datel ID.

14.4.3.5.2.2 Physical Model

```
CREATE TABLE DATUM_ELLIPSOID
(
  DATASET_ID INTEGER,
  DATEL_ID INTEGER,
  TRANS_X INTEGER,
  TRANS_Y INTEGER,
  TRANS_Z INTEGER,
  ROT_Z INTEGER,
  SCALE_FACTOR INTEGER,
  SEMI_MAJOR_AXIS INTEGER,
  SEMI_MINOR_AXIS INTEGER,
  COMMENT_DLS INTEGER,
  COMMENT_STRING INTEGER,
  DATUM_CODE CHAR(4),
  ELLIPSOID_CODE CHAR(2),

  CONSTRAINT DATUM_ELLIPSOID_PRIMARY_KEY
    PRIMARY KEY (DATASET_ID, DATEL_ID),

  CONSTRAINT DATUM_ELLIPSOID_DATASET_ID_EXISTS
    FOREIGN KEY(DATASET_ID)
    REFERENCES DATASET(DATASET_ID),

  CONSTRAINT DATUM_ELLIPSOID_COMMENT_EXISTS
    FOREIGN KEY(COMMENT_DLS, COMMENT_STRING)
    REFERENCES LCS_TEXT(DLS, STRING_ID)
    MATCH FULL,

  CONSTRAINT DATUM_ELLIPSOID_DATUM_CODE_EXISTS
    FOREIGN KEY(DATUM_CODE)
    REFERENCES HORIZ_DATUM_CODE(DATUM_CODE),

  CONSTRAINT DATUM_ELLIPSOID_ELLIPSOID_CODE_EXISTS
    FOREIGN KEY(ELLIPSOID_CODE)
    REFERENCES ELLIPSOID_CODE(ELLIPSOID_CODE)
)
```

14.4.3.5.3 Vertical Datum

14.4.3.5.3.1 Logical Model

A description of the orthometric reference system used in a certain country, together with adjacent orthometric reference systems, is needed in order to be able to translate height data either side of the interface between adjacent height levels.

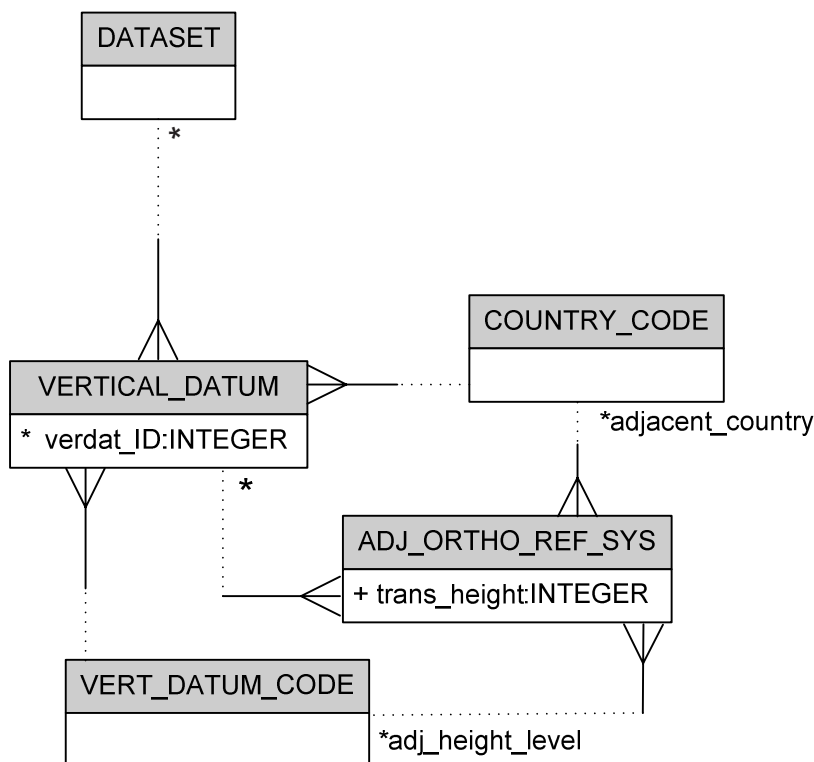

The Vertical Datum entities are each identified by a verdat ID, unique within the Dataset. Each Vertical Datum must contain a two-character height level code, referencing a Vertical Datum Code, and a three-character country code, referencing a Country, selected from the pre-defined content section above (see 14.2.2.7 and 14.2.2.3, respectively).

Each Vertical Datum may contain any number of Adjacent Orthometric Reference Systems. Each of these must have an adjacent height level, identified by a two-character Vertical Datum Code height level code, and an adjacent Country, identified by a three-character country code, selected from the pre-defined content section above (see 14.2.2.7 and 14.2.2.3, respectively), and a trans height to specify the difference of the orthometric height of the origin of the adjacent system.

Any Section in the Dataset may reference the appropriate Vertical Datum entity by using its verdat ID.

14.4.3.5.3.2 Physical Model

```

CREATE TABLE VERTICAL_DATUM
(
  DATASET_ID INTEGER,
  VERDAT_ID INTEGER,
  COUNTRY_CODE CHAR(3)
  CONSTRAINT VERTICAL_DATUM_COUNTRY_CODE_NOT_NULL
  NOT NULL,
  HEIGHT_LEVEL_CODE CHAR(2)
  CONSTRAINT VERTICAL_DATUM_HEIGHT_LEVEL_CODE_NOT_NULL
  NOT NULL,

  CONSTRAINT VERTICAL_DATUM_PRIMARY_KEY
  PRIMARY KEY (DATASET_ID, VERDAT_ID),

  CONSTRAINT VERTICAL_DATUM_DATASET_ID_EXISTS
  FOREIGN KEY(DATASET_ID)
  REFERENCES DATASET(DATASET_ID),

  CONSTRAINT VERTICAL_DATUM_COUNTRY_CODE_EXISTS

```

```
FOREIGN KEY(COUNTRY_CODE)
REFERENCES COUNTRY_CODE(COUNTRY_CODE),

CONSTRAINT VERTICAL_DATUM_HEIGHT_LEVEL_CODE_EXISTS
FOREIGN KEY(HEIGHT_LEVEL_CODE)
REFERENCES VERT_DATUM_CODE(HEIGHT_LEVEL_CODE)
)
```

CREATE TABLE ADJ_ORTHO_REF_SYS

```
(
DATASET_ID INTEGER,
VERDAT_ID INTEGER,
ADJACENT_COUNTRY CHAR(3),
ADJ_HEIGHT_LEVEL CHAR(2),
TRANS_HEIGHT INTEGER
CONSTRAINT ADJ_ORTHO_REF_SYS_TRANS_HEIGHT_NOT_NULL
NOT NULL,

CONSTRAINT ADJ_ORTHO_REF_SYS_PRIMARY_KEY
PRIMARY KEY (DATASET_ID, VERDAT_ID, ADJACENT_COUNTRY, ADJ_HEIGHT_LEVEL),

CONSTRAINT ADJ_ORTHO_REF_SYS_VERDAT_EXISTS
FOREIGN KEY(DATASET_ID, VERDAT_ID)
REFERENCES VERTICAL_DATUM(DATASET_ID, VERDAT_ID),

CONSTRAINT ADJ_ORTHO_REF_SYS_ADJACENT_COUNTRY_EXISTS
FOREIGN KEY(ADJACENT_COUNTRY)
REFERENCES COUNTRY_CODE(COUNTRY_CODE),

CONSTRAINT ADJ_ORTHO_REF_SYS_ADJ_HEIGHT_LEVEL_EXISTS
FOREIGN KEY(ADJ_HEIGHT_LEVEL)
REFERENCES VERT_DATUM_CODE(HEIGHT_LEVEL_CODE)
)
```

14.4.3.5.4 Projection

14.4.3.5.4.1 Logical Model

Information about the Projection used in a particular National Grid is needed to be able to transform XY- coordinates into geographical coordinates.

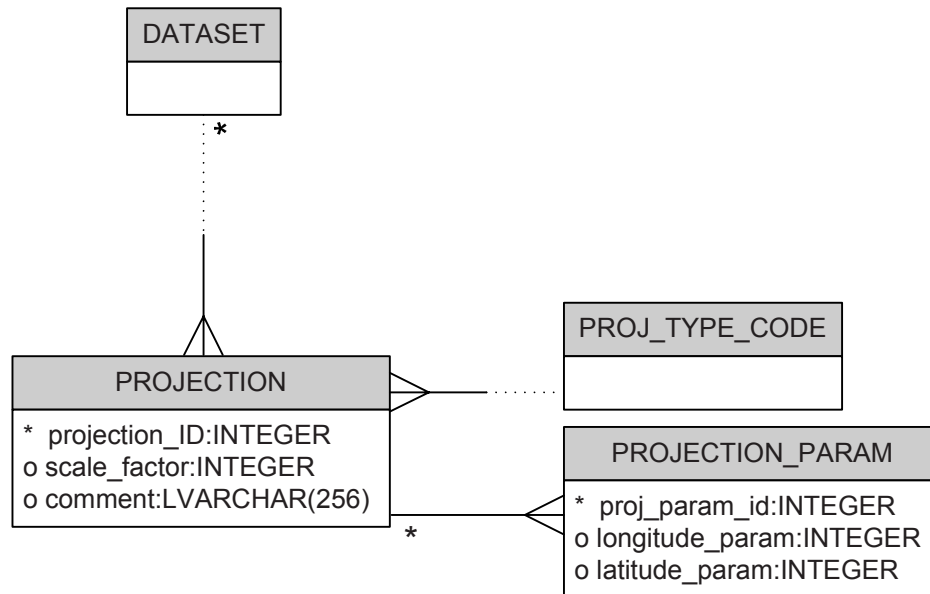

The Projection entities are each identified by a projection ID, unique within the Dataset. Each Projection must have a two-character projection type code referencing Projection Type in the pre-defined content section above (see 14.2.2.14). It may have a scale factor and comment and up to three sets of parameters (identified by the project parameter ID) each of which must include a longitude or latitude parameter or both.

Any Section in the Dataset may reference the appropriate Projection entity by using its projection ID.

14.4.3.5.4.2 Physical Model

```

CREATE TABLE PROJECTION
(
  DATASET_ID INTEGER,
  PROJECTION_ID INTEGER,
  SCALE_FACTOR INTEGER,
  COMMENT_DLS INTEGER,
  COMMENT_STRING INTEGER,
  PROJ_TYPE_CODE CHAR(2)
  CONSTRAINT PROJECTION_PROJ_TYPE_CODE_NOT_NULL
  NOT NULL,

  CONSTRAINT PROJECTION_PRIMARY_KEY
  PRIMARY KEY (DATASET_ID, PROJECTION_ID),

  CONSTRAINT PROJECTION_DATASET_ID_EXISTS
  FOREIGN KEY(DATASET_ID)
  REFERENCES DATASET(DATASET_ID),

  CONSTRAINT PROJECTION_COMMENT_EXISTS
  FOREIGN KEY(COMMENT_DLS, COMMENT_STRING)
  REFERENCES LCS_TEXT(DLS, STRING_ID)
  MATCH FULL,

  CONSTRAINT PROJECTION_PROJ_TYPE_CODE_EXISTS
  FOREIGN KEY(PROJ_TYPE_CODE)
  REFERENCES PROJ_TYPE_CODE(PROJ_TYPE_CODE)
)
  
```

NOTE Existence of at least one PROJECTION_PARAM for each PROJECTION is checked after PROJECTION_PARAM table has been created.

```
CREATE TABLE PROJECTION_PARAM
(
  DATASET_ID INTEGER,
  PROJECTION_ID INTEGER,
  PROJ_PARAM_ID INTEGER,
  LONGITUDE_PARAM INTEGER,
  LATITUDE_PARAM INTEGER,

  CONSTRAINT PROJECTION_PARAM_PRIMARY_KEY
    PRIMARY KEY (DATASET_ID, PROJECTION_ID, PROJ_PARAM_ID),

  CONSTRAINT PROJECTION_PARAM_PROJECTION_EXISTS
    FOREIGN KEY(DATASET_ID, PROJECTION_ID)
    REFERENCES PROJECTION(DATASET_ID, PROJECTION_ID),

  CONSTRAINT PROJECTION_PARAM_LAT_LONG_MISSING
    CHECK (LONGITUDE_PARAM IS NOT NULL OR LATITUDE_PARAM IS NOT NULL )
)

ALTER TABLE PROJECTION
  ADD CONSTRAINT PROJECTION_HAS_PROJECTION_PARAM
  CHECK (PROJECTION_ID IN
    (SELECT PROJECTION_ID FROM PROJECTION_PARAM))
  DEFERRABLE INITIALLY DEFERRED
```

14.4.3.5.5 National Map Grid

14.4.3.5.5.1 Logical Model

The characteristics of the National Grid to which the coordinates of a particular Section refer are needed to interpret correctly the X- and Y- coordinate values, and to be able to transform from XY- coordinates into geographical coordinates.

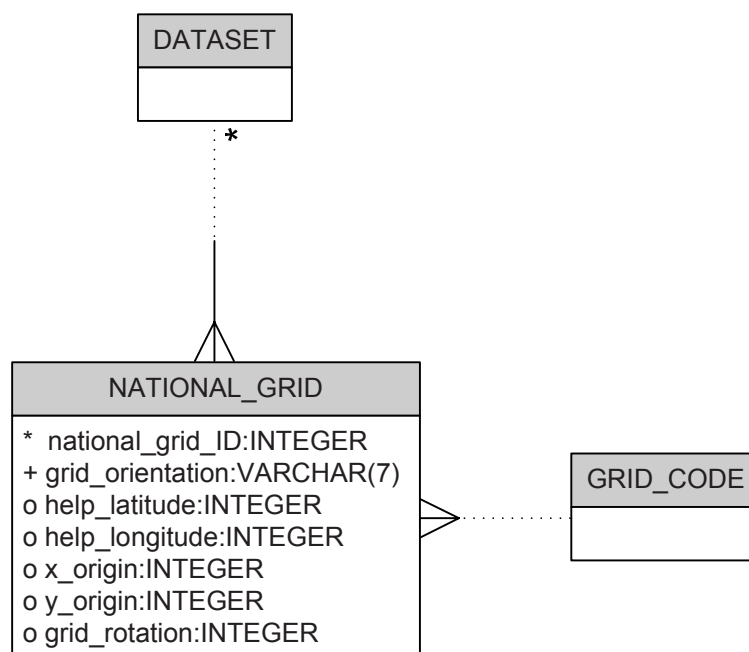

The National Grid entities are each identified by a national grid ID, unique within the Dataset. Each National Grid must have a grid axis orientation value. All the remaining attributes are optional, including a grid code which references Grid in the pre-defined content section above (see 14.2.2.13).

Any Section in the Dataset may reference the appropriate National Grid entity by using its national grid ID.

14.4.3.5.5.2 Physical Model

```
CREATE TABLE NATIONAL_GRID
(
  DATASET_ID INTEGER,
  NATIONAL_GRID_ID INTEGER,
  GRID_ORIENTATION CHARACTER VARYING(7)
    CONSTRAINT NATIONAL_GRID_GRID_ORIENTATION_NOT_NULL
    NOT NULL,
  HELP_LATITUDE INTEGER,
  HELP_LONGITUDE INTEGER,
  X_ORIGIN INTEGER,
  Y_ORIGIN INTEGER,
  GRID_ROTATION INTEGER,
  GRID_CODE CHAR(2),

  CONSTRAINT NATIONAL_GRID_PRIMARY_KEY
    PRIMARY KEY (DATASET_ID, NATIONAL_GRID_ID),

  CONSTRAINT NATIONAL_GRID_DATASET_ID_EXISTS
    FOREIGN KEY(DATASET_ID)
    REFERENCES DATASET(DATASET_ID),

  CONSTRAINT NATIONAL_GRID_GRID_CODE_EXISTS
    FOREIGN KEY(GRID_CODE)
    REFERENCES GRID_CODE(GRID_CODE)
)
```

14.4.3.5.6 Geoid Undulation

14.4.3.5.6.1 Logical Model

The height of the geoid above the reference ellipsoid in some particular reference points has to be described when Z-values are used.

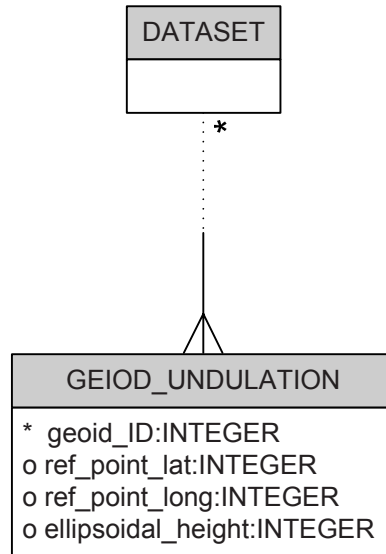

The Geoid Undulation entities are each identified by a geoid ID, unique within the Dataset. All attributes are optional.

Any Section in the Dataset may reference the appropriate Geoid Undulation entities by using their geoid IDs.

14.4.3.5.6.2 Physical Model

```
CREATE TABLE GEIOD_UNDULATION
(
  DATASET_ID INTEGER,
  GEOID_ID INTEGER,
  REF_POINT_LAT INTEGER,
  REF_POINT_LONG INTEGER,
  ELLIPSOIDAL_HEIGHT INTEGER,

  CONSTRAINT GEIOD_UNDULATION_PRIMARY_KEY
    PRIMARY KEY (DATASET_ID, GEOID_ID),

  CONSTRAINT GEIOD_UNDULATION_DATASET_ID_EXISTS
    FOREIGN KEY(DATASET_ID)
    REFERENCES DATASET(DATASET_ID)
)
```

14.4.3.5.7 Earth Magnetic Field

14.4.3.5.7.1 Logical Model

Information about the magnetic declination and the annual deviation is needed to be able to correct for this declination in the heading of a navigation compass.

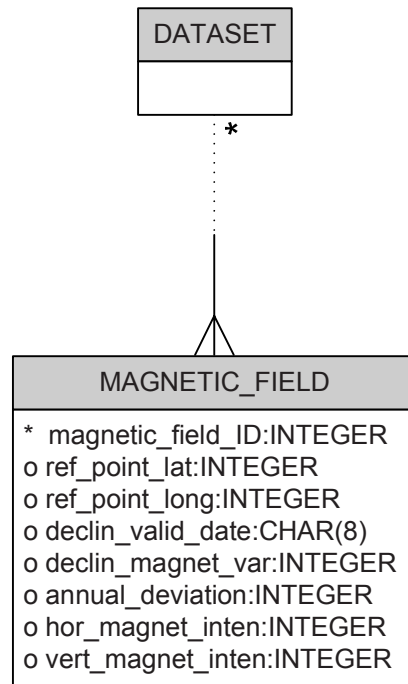

The Magnetic Field entities are each identified by a magnetic field ID, unique within the Dataset. All attributes are optional.

Any Section in the Dataset may reference the appropriate Earth Magnetic Field entities by using their magnetic field IDs.

14.4.3.5.7.2 Physical Model

```

CREATE TABLE MAGNETIC_FIELD
(
    DATASET_ID INTEGER,
    MAGNETIC_FIELD_ID INTEGER,
    REF_POINT_LAT INTEGER,
    REF_POINT_LONG INTEGER,
    DECLIN_VALID_DATE CHAR(8),
    DECLIN_MAGNET_VAR INTEGER,
    ANNUAL_DEVIATION INTEGER,
    HOR_MAGNET_INTEN INTEGER,
    VERT_MAGNET_INTEN INTEGER,

    CONSTRAINT MAGNETIC_FIELD_PRIMARY_KEY
        PRIMARY KEY (DATASET_ID, MAGNETIC_FIELD_ID),

    CONSTRAINT MAGNETIC_FIELD_DATASET_ID_EXISTS
        FOREIGN KEY(DATASET_ID)
        REFERENCES DATASET(DATASET_ID)
)
    
```

14.4.3.6 Network Specification

14.4.3.6.1 Logical Model

Each Dataset may contain Network Specifications which specify the level of completeness of a Road network, for use by Line Features in the Sections within the Dataset.

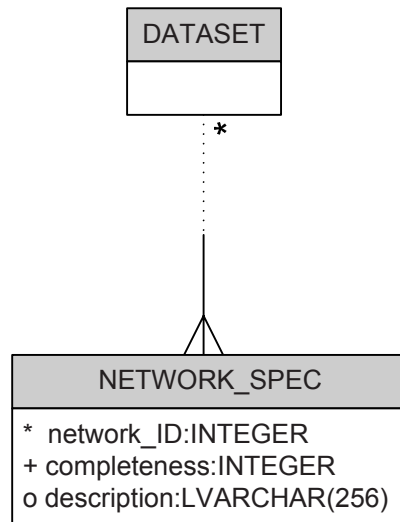

Each Network Specification is identified by a network ID, unique within the Dataset. Each Network Specification has a mandatory completeness value and an optional description.

Any Line Feature in any of the Sections in the Dataset may reference the appropriate Network Specification by using its network ID.

14.4.3.6.2 Physical Model

```

CREATE TABLE NETWORK_SPEC
(
  DATASET_ID INTEGER,
  NETWORK_ID INTEGER,
  COMPLETENESS INTEGER
  CONSTRAINT NETWORK_SPEC_COMPLETENESS_NOT_NULL
  NOT NULL,
  DESCRIPTION_DLS INTEGER,
  DESCRIPTION_STRING INTEGER,

  CONSTRAINT NETWORK_SPEC_PRIMARY_KEY
  PRIMARY KEY (DATASET_ID, NETWORK_ID),

  CONSTRAINT NETWORK_SPEC_DATASET_ID_EXISTS
  FOREIGN KEY(DATASET_ID)
  REFERENCES DATASET(DATASET_ID),

  CONSTRAINT NETWORK_SPEC_DESCRIPTION_EXISTS
  FOREIGN KEY(DESCRIPTION_DLS, DESCRIPTION_STRING)
  REFERENCES LCS_TEXT(DLS, STRING_ID)
  MATCH FULL
)
  
```

14.4.3.7 Spatial Domain

Each Dataset may contain Spatial Domains which describe the geographic coverage of a Dataset.

In the MRS, each Spatial Domain is identified by a spatial domain ID, unique within the Dataset. All other Spatial Domain attributes are optional

In GDF SQL, the following MRS records have been unified:

Record 08 Spatial Domain

Record 16.01 Section ID

Subrecord (partially)

Record 16.07 Section Border Subrecord (partially)

The following are equivalent

SQL attribute	Record 08 Field	Record 16.01 Field	Record 16.07 Field
geo_area_name	GEO_AREA	GEO_AREA	
north_latitude	NORTH_LAT		Y_MAX
south_latitude	SOUTH_LAT		Y_MIN
east_longitude	EAST_LONG		X_MAX
west_longitude	WEST_LONG		X_MIN

Any Section in the Dataset may reference the appropriate MRS Spatial Domain entity by using its spatial domain ID. The SQL attributes in the table above have been moved to the Section entity (see 14.4.5.1).

14.4.3.8 Data Source

14.4.3.8.1 Source Entity

14.4.3.8.1.1 Logical Model

Each instance of a Dataset will be based, to a certain degree, on information which already was available, either in the form of documents and/or in reality. These documents can have the form of a map, a book, report or other monographic document, both in printed and in digitized form. Each Dataset shall contain short descriptions of the Sources that have been used for its creation. These references are needed for reasons of copyright, but they are also useful as tools for quality control.

Each single document will in principle be represented by one cartographic Source description. Field information will be represented by the date on which the field activity was conducted.

Source identifies where the data came from. The following entities should have an optional Source attribute:

Node

Edge

Link

Face

Feature

Attribute

Relationship

Text

Time Domain

Section

Object Reference

Update

Sources are held at the Dataset level so the source ID is only unique within each Dataset.

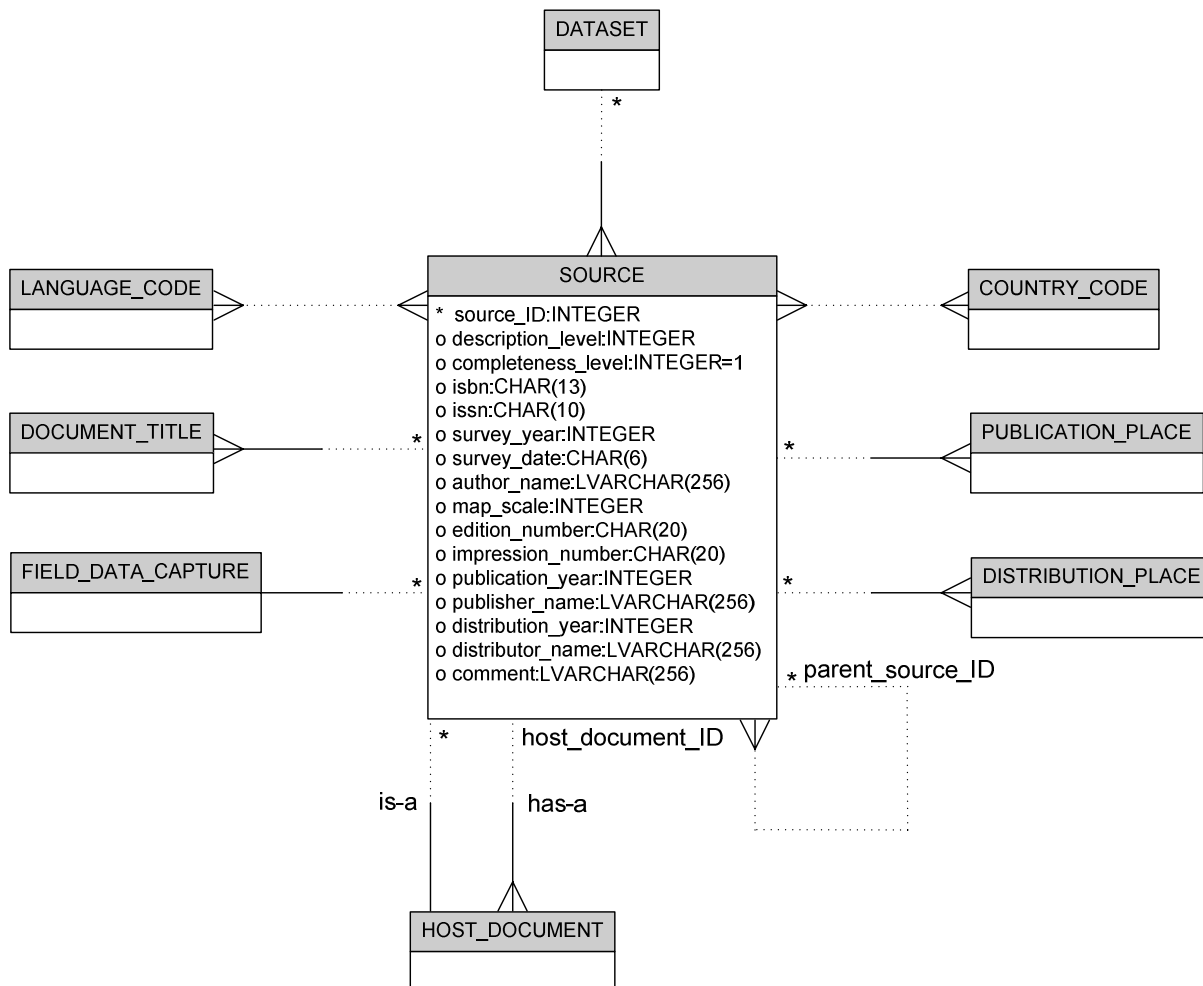

The Source data is normalized across the main Source entity plus five dependent entities (Document Title, Publication Place, Distribution Place, Host Document, and Field Data Capture) and all are optional. Each Source may contain any number of three-character country codes referencing Countries in the pre-defined content section above (see 14.2.2.3). Each Source may contain any number of three-character language codes referencing Languages in the pre-defined content section above (see 14.2.2.4.1) to specify Language(s) used in the Source.

14.4.3.8.1.2 Physical Model

```

CREATE TABLE SOURCE
(
  DATASET_ID INTEGER,
  SOURCE_ID INTEGER,
  DESCRIPTION_LEVEL INTEGER,
  COMPLETENESS_LEVEL INTEGER DEFAULT 1,
  ISBN CHAR(13),
  ISSN CHAR(10),
  SURVEY_YEAR INTEGER,
  SURVEY_DATE CHAR(6),
  AUTHOR_DLS INTEGER,

```

```

AUTHOR_STRING INTEGER,
MAP_SCALE INTEGER,
EDITION_NUMBER CHAR(20),
IMPRESSION_NUMBER CHAR(20),
PUBLICATION_YEAR INTEGER,
PUBLISHER_DLS INTEGER,
PUBLISHER_STRING INTEGER,
DISTRIBUTION_YEAR INTEGER,
DISTRIBUTOR_DLS INTEGER,
DISTRIBUTOR_STRING INTEGER,
COMMENT_DLS INTEGER,
COMMENT_STRING INTEGER,
PARENT_SOURCE_ID INTEGER,
HOST_DOCUMENT_ID INTEGER,

CONSTRAINT SOURCE_PRIMARY_KEY
    PRIMARY KEY (DATASET_ID, SOURCE_ID),

CONSTRAINT SOURCE_DATASET_ID_EXISTS
    FOREIGN KEY(DATASET_ID)
    REFERENCES DATASET(DATASET_ID),

CONSTRAINT SOURCE_AUTHOR_EXISTS
    FOREIGN KEY(AUTHOR_DLS, AUTHOR_STRING)
    REFERENCES LCS_TEXT(DLS, STRING_ID)
    MATCH FULL,

CONSTRAINT SOURCE_PUBLISHER_EXISTS
    FOREIGN KEY(PUBLISHER_DLS, PUBLISHER_STRING)
    REFERENCES LCS_TEXT(DLS, STRING_ID)
    MATCH FULL,

CONSTRAINT SOURCE_DISTRIBUTOR_EXISTS
    FOREIGN KEY(DISTRIBUTOR_DLS, DISTRIBUTOR_STRING)
    REFERENCES LCS_TEXT(DLS, STRING_ID)
    MATCH FULL,

CONSTRAINT SOURCE_COMMENT_EXISTS
    FOREIGN KEY(COMMENT_DLS, COMMENT_STRING)
    REFERENCES LCS_TEXT(DLS, STRING_ID)
    MATCH FULL,

CONSTRAINT SOURCE_PARENT_SOURCE_ID_EXISTS
    FOREIGN KEY(DATASET_ID, PARENT_SOURCE_ID)
    REFERENCES SOURCE(DATASET_ID, SOURCE_ID)
)

```

NOTE Host Document Referential Integrity constraint will be added after Host Document Table is created (14.4.3.8.5).

```

CREATE TABLE SOURCE_LAN_CODE
(
    DATASET_ID INTEGER,
    SOURCE_ID INTEGER,
    LANGUAGE_CODE CHAR(3),

    CONSTRAINT SOURCE_LAN_CODE_PRIMARY_KEY
        PRIMARY KEY (DATASET_ID, LANGUAGE_CODE),

    CONSTRAINT SOURCE_LAN_CODE_SOURCE_ID_EXISTS
        FOREIGN KEY(DATASET_ID, SOURCE_ID)

```

```

REFERENCES SOURCE(DATASET_ID, SOURCE_ID),

CONSTRAINT SOURCE_LAN_CODE_LANGUAGE_CODE_EXISTS
FOREIGN KEY(LANGUAGE_CODE)
REFERENCES LANGUAGE_CODE(LANGUAGE_CODE)
)

CREATE TABLE SOURCE_COUNTRY
(
DATASET_ID INTEGER,
COUNTRY_CODE CHAR(3),

CONSTRAINT SOURCE_COUNTRY_PRIMARY_KEY
PRIMARY KEY (DATASET_ID, COUNTRY_CODE),

CONSTRAINT SOURCE_COUNTRY_SOURCE_ID_EXISTS
FOREIGN KEY(DATASET_ID, SOURCE_ID)
REFERENCES SOURCE(DATASET_ID, SOURCE_ID),

CONSTRAINT SOURCE_COUNTRY_COUNTRY_CODE_EXISTS
FOREIGN KEY(COUNTRY_CODE)
REFERENCES COUNTRY_CODE(COUNTRY_CODE)
)

```

14.4.3.8.2 Document Title

14.4.3.8.2.1 Logical Model

The Document Title is the main title of the document. When the title is specified in more than one language, a corresponding number of repeating Document Titles have to be used.

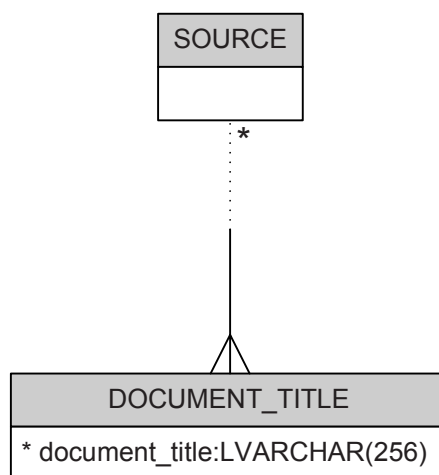

14.4.3.8.2.2 Physical Model

```

CREATE TABLE DOCUMENT_TITLE
(
DATASET_ID INTEGER,
SOURCE_ID INTEGER,
DOC_TITLE_DLS INTEGER,
DOC_TITLE_STRING INTEGER,

CONSTRAINT DOCUMENT_TITLE_PRIMARY_KEY
PRIMARY KEY (DATASET_ID, SOURCE_ID, DOC_TITLE_DLS, DOC_TITLE_STRING),
)

```



```

CONSTRAINT DOCUMENT_TITLE_SOURCE_ID_EXISTS
  FOREIGN KEY(DATASET_ID, SOURCE_ID)
  REFERENCES SOURCE(DATASET_ID, SOURCE_ID),

CONSTRAINT DOCUMENT_TITLE_DOC_TITLE_EXISTS
  FOREIGN KEY(DOC_TITLE_DLS, DOC_TITLE_STRING)
  REFERENCES LCS_TEXT(DLS, STRING_ID)
  MATCH FULL
)

```

14.4.3.8.3 Publication Place

14.4.3.8.3.1 Logical Model

Each Source may have a single Publisher, whose name is mandatory.

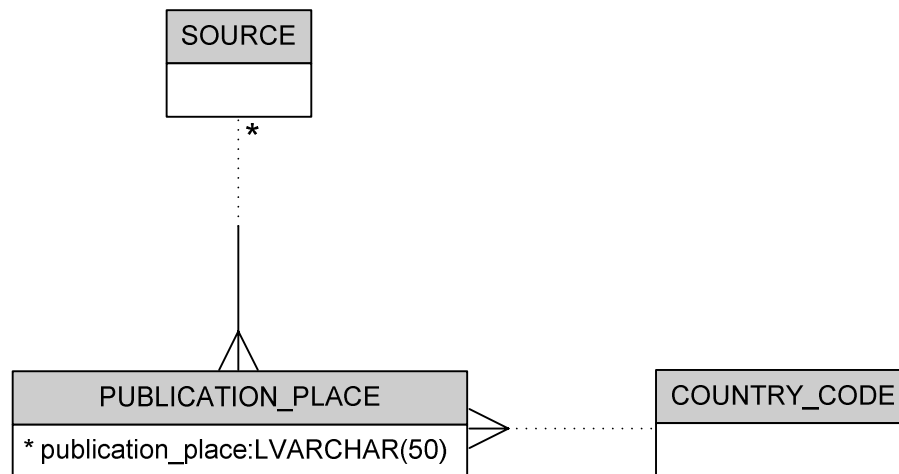

The Publisher may have multiple Publication Places, each comprised of a publication place and a three-digit country code referencing a Country from the pre-defined content section above (see 14.2.2.3).

14.4.3.8.3.2 Physical Model

```

CREATE TABLE PUBLICATION_PLACE
(
  DATASET_ID INTEGER,
  SOURCE_ID INTEGER,
  PLACE_DLS INTEGER,
  PLACE_STRING INTEGER,
  COUNTRY_CODE CHAR(3),

  CONSTRAINT PUBLICATION_PLACE_PRIMARY_KEY
    PRIMARY KEY (DATASET_ID, SOURCE_ID, PLACE_DLS, PLACE_STRING),

  CONSTRAINT PUBLICATION_PLACE_SOURCE_ID_EXISTS
    FOREIGN KEY(DATASET_ID, SOURCE_ID)
    REFERENCES SOURCE(DATASET_ID, SOURCE_ID),

  CONSTRAINT PUBLICATION_PLACE_PLACE_EXISTS
    FOREIGN KEY(PLACE_DLS, PLACE_STRING)
    REFERENCES LCS_TEXT(DLS, STRING_ID)
    MATCH FULL,
)

```

```

CONSTRAINT PUBLICATION_PLACE_COUNTRY_CODE_EXISTS
  FOREIGN KEY(COUNTRY_CODE)
  REFERENCES COUNTRY_CODE(COUNTRY_CODE)
)

```

14.4.3.8.4 Distribution Place

14.4.3.8.4.1 Logical Model

Each Source may have a single Distributor, whose name is mandatory.

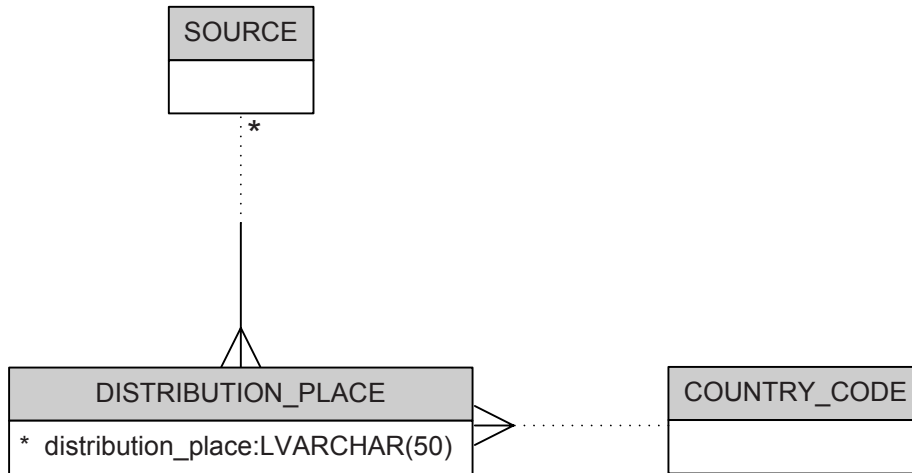

The Distributor may have multiple Distribution Places, each comprised of a distribution place and a three-digit country code referencing a Country from the pre-defined content section above (see 14.2.2.3).

14.4.3.8.4.2 Physical Model

```

CREATE TABLE DISTRIBUTION_PLACE
(
  DATASET_ID INTEGER,
  SOURCE_ID INTEGER,
  PLACE_DLS INTEGER,
  PLACE_STRING INTEGER,
  COUNTRY_CODE CHAR(3),

  CONSTRAINT DISTRIBUTION_PLACE_PRIMARY_KEY
    PRIMARY KEY (DATASET_ID, SOURCE_ID, PLACE_DLS, PLACE_STRING),

  CONSTRAINT DISTRIBUTION_PLACE_SOURCE_ID_EXISTS
    FOREIGN KEY(DATASET_ID, SOURCE_ID)
    REFERENCES SOURCE(DATASET_ID, SOURCE_ID),

  CONSTRAINT DISTRIBUTION_PLACE_PLACE_EXISTS
    FOREIGN KEY(PLACE_DLS, PLACE_STRING)
    REFERENCES LCS_TEXT(DLS, STRING_ID)
    MATCH FULL,

  CONSTRAINT DISTRIBUTION_PLACE_COUNTRY_CODE_EXISTS
    FOREIGN KEY(COUNTRY_CODE)
    REFERENCES COUNTRY_CODE(COUNTRY_CODE)
)

```

14.4.3.8.5 Host Document

14.4.3.8.5.1 Logical Model

A Source can have one Host Document which itself is a Source. This can be expressed as two relationships.

The is-a relationship says that a host document is itself a source. As such, it inherits the source_ID (and therefore the dataset_ID) as its unique identifier. Four optional attributes (relationship kind, first page, last page, and comment) are added to the host document type of source.

The has-a relationship says that many sources may have the same host identified above.

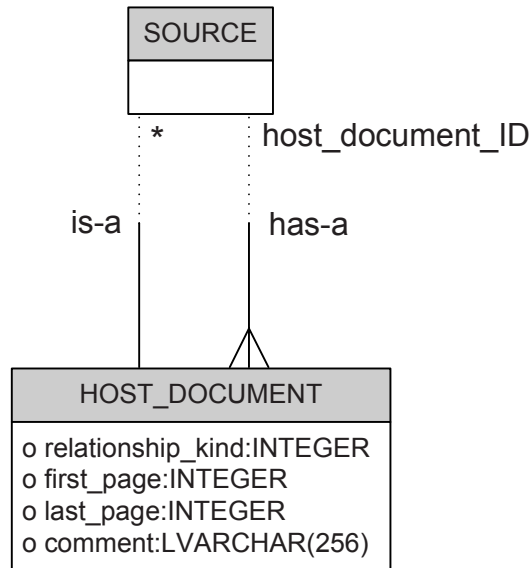

The host document ID is the source ID of the host Source not the source having the host. So if Source 1 has a host document, that host document is itself a Source (say Source 2), then host document ID = 2. All other Host Document attributes are optional. Relationship kind values include:

- 11 = Descended from
- 12 = Appendix to
- 13 = Published together with
- 14 = Additional map to
- 15 = Inset map to
- 16 = Is part of

14.4.3.8.5.2 Physical Model

```

CREATE TABLE HOST_DOCUMENT
(
  DATASET_ID INTEGER,
  SOURCE_ID INTEGER,
  RELATIONSHIP_KIND INTEGER,
  FIRST_PAGE INTEGER,
  LAST_PAGE INTEGER,
  COMMENT_DLS INTEGER,
  COMMENT_STRING INTEGER,

```

```

CONSTRAINT HOST_DOCUMENT_PRIMARY_KEY
PRIMARY KEY (DATASET_ID, SOURCE_ID),

CONSTRAINT HOST_DOCUMENT_SOURCE_ID_EXISTS
FOREIGN KEY(DATASET_ID, SOURCE_ID)
REFERENCES SOURCE(DATASET_ID, SOURCE_ID),

CONSTRAINT HOST_DOCUMENT_COMMENT_EXISTS
FOREIGN KEY(COMMENT_DLS, COMMENT_STRING)
REFERENCES LCS_TEXT(DLS, STRING_ID)
MATCH FULL
)

```

```

ALTER TABLE SOURCE
ADD CONSTRAINT SOURCE_HOST_DOCUMENT_ID_EXISTS
FOREIGN KEY(DATASET_ID, HOST_DOCUMENT_ID)
REFERENCES HOST_DOCUMENT(DATASET_ID, SOURCE_ID)

```

NOTE When inserting host documents, first insert the appropriate information about the host as a source into the Source table, identified with a Source_ID. Then add the additional host document information into the Host Document table identified with the same Source_ID. If any other sources use this host document, the source can now be added to the Source table with a Host_Document_ID equal to the Source_ID of the host,.

14.4.3.8.6 Field Data Capture

14.4.3.8.6.1 Logical Model

The date on which the field data capture of field verification was conducted.

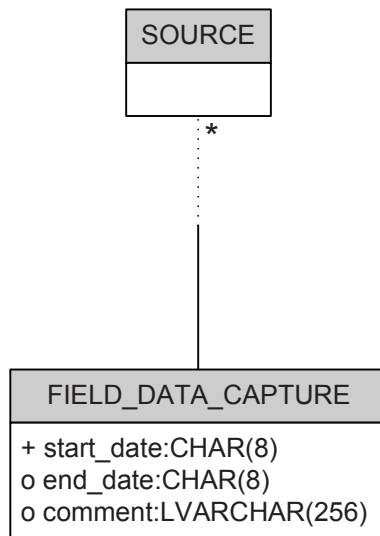

Field Data Capture is uniquely identified by the source_ID (and therefore the dataset_ID). The start date is mandatory, but the end date is optional – its absence signifies that all activity occurred on the start date. Comment is also optional.

14.4.3.8.6.2 Physical Model

```

CREATE TABLE FIELD_DATA_CAPTURE
(
DATASET_ID INTEGER,
SOURCE_ID INTEGER,
START_DATE CHAR(8)
)

```

```
CONSTRAINT FIELD_DATA_START_DATE_NOT_NULL
NOT NULL,
END_DATE CHAR(8),
COMMENT_DLS INTEGER,
COMMENT_STRING INTEGER,

CONSTRAINT FIELD_DATA_CAPTURE_PRIMARY_KEY
PRIMARY KEY (DATASET_ID, SOURCE_ID),

CONSTRAINT FIELD_DATA_CAPTURE_SOURCE_ID_EXISTS
FOREIGN KEY(DATASET_ID, SOURCE_ID)
REFERENCES SOURCE(DATASET_ID, SOURCE_ID),

CONSTRAINT FIELD_DATA_CAPTURE_COMMENT_EXISTS
FOREIGN KEY(COMMENT_DLS, COMMENT_STRING)
REFERENCES LCS_TEXT(DLS, STRING_ID)
MATCH FULL
)
```

14.4.4 Layer

14.4.4.1 Logical Model

Datasets are partitioned into Layers.

A Layer contains Features for zero or more Feature Themes.

Every Dataset shall have at least one Layer entity.

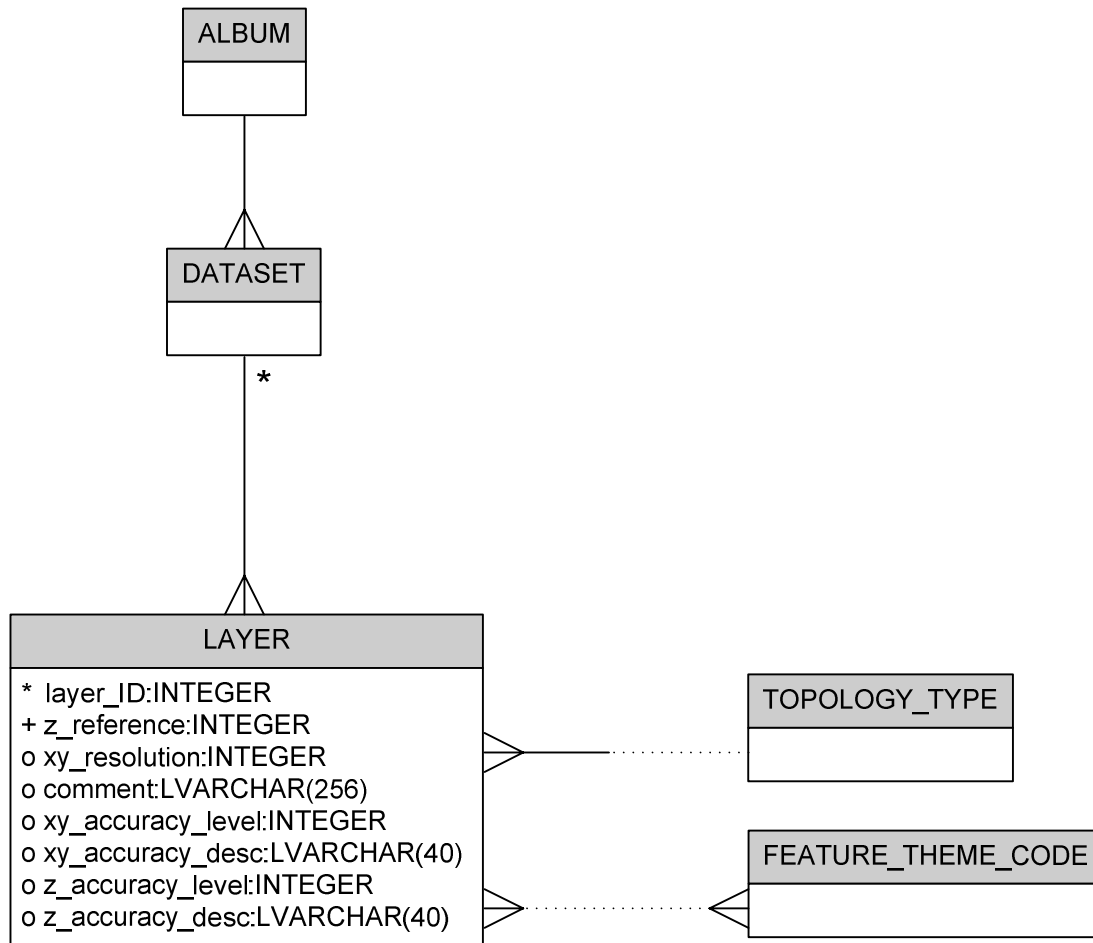

Each Layer is uniquely identified by its layer ID. The layer ID is only unique within a Dataset. The z reference is mandatory; all others are optional.

All of the Features contained within a Layer must be of the same Topology Type, identified by a three character topology type referencing Topology Type (see 14.3).

The Layer content may be specified by a list of all of the two character Feature Theme Codes referencing Feature Themes in the pre-defined content above (see 14.2.2.9) of all of the Features contained within all of the Sections owned by the Layer.

14.4.4.2 Physical Model

```

CREATE TABLE LAYER
(
  DATASET_ID INTEGER,
  LAYER_ID INTEGER,
  Z_REFERENCE INTEGER
  CONSTRAINT LAYER_Z_REFERENCE_NOT_NULL
  NOT NULL,
  XY_RESOLUTION INTEGER,
  COMMENT_DLS INTEGER,
  COMMENT_STRING INTEGER,
  XY_ACCURACY_LEVEL INTEGER,
  XY_ACC_DESC_DLS INTEGER,
  XY_ACC_DESC_STRING INTEGER,
  Z_ACCURACY_LEVEL INTEGER,
  Z_ACC_DESC_DLS INTEGER,

```

Z_ACC_DESC_STRING INTEGER,
TOPOLOGY_TYPE CHAR(3)
CONSTRAINT LAYER_TOPOLOGY_TYPE_NOT_NULL
NOT NULL,

CONSTRAINT LAYER_PRIMARY_KEY
PRIMARY KEY (DATASET_ID, LAYER_ID),

CONSTRAINT LAYER_DATASET_EXISTS
FOREIGN KEY(DATASET_ID)
REFERENCES DATASET(DATASET_ID),

CONSTRAINT LAYER_COMMENT_EXISTS
FOREIGN KEY(COMMENT_DLS, COMMENT_STRING)
REFERENCES LCS_TEXT(DLS, STRING_ID)
MATCH FULL,

CONSTRAINT LAYER_XY_ACC_DESC_EXISTS
FOREIGN KEY(XY_ACC_DESC_DLS, XY_ACC_DESC_STRING)
REFERENCES LCS_TEXT(DLS, STRING_ID)
MATCH FULL,

CONSTRAINT LAYER_Z_ACC_DESC_EXISTS
FOREIGN KEY(Z_ACC_DESC_DLS, Z_ACC_DESC_STRING)
REFERENCES LCS_TEXT(DLS, STRING_ID)
MATCH FULL,

CONSTRAINT LAYER_TOPOLOGY_TYPE_EXISTS
FOREIGN KEY(TOPOLOGY_TYPE)
REFERENCES TOPOLOGY_TYPE (TOPOLOGY_TYPE),
)

ALTER TABLE DATASET
ADD CONSTRAINT DATASET_HAS_LAYER
CHECK (DATASET_ID IN
(SELECT DATASET_ID FROM LAYER))
DEFERRABLE INITIALLY DEFERRED

NOTE Existence of at least one SECTION for each LAYER is checked after SECTION table has been created.

CREATE TABLE LAYER_FEAT_THEME
(
DATASET_ID INTEGER,
LAYER_ID INTEGER,
FEATURE_THEME_CODE CHAR(2),

CONSTRAINT LAYER_FEAT_THEME_PRIMARY_KEY
PRIMARY KEY (DATASET_ID, LAYER_ID, FEATURE_THEME_CODE),

CONSTRAINT LAYER_FEAT_THEME_LAYER_ID_EXISTS
FOREIGN KEY(DATASET_ID, LAYER_ID)
REFERENCES LAYER(DATASET_ID, LAYER_ID),

CONSTRAINT LAYER_FEAT_THEME_FEATURE_THEME_CODE_EXISTS
FOREIGN KEY(FEATURE_THEME_CODE)
REFERENCES FEATURE_THEME_CODE(FEATURE_THEME_CODE)
)

14.4.5 Section

14.4.5.1 Section Entity

14.4.5.1.1 Logical Model

Layers are geographically partitioned into Sections. All Features in a Section must be of the same Topology Type, since the Section is part of a Layer and a Layer can have only one Topology Type.

GDF Features cannot span Sections (see Conversion in Clause 14.6.4 as a way of splitting a real world feature between Sections). An important consideration for the SQL encoding is that all of the (planar full) topological primitives in a section form a single planar graph (*"topology" in SQL/MM terminology*).

Every Layer shall have at least one Section entity.

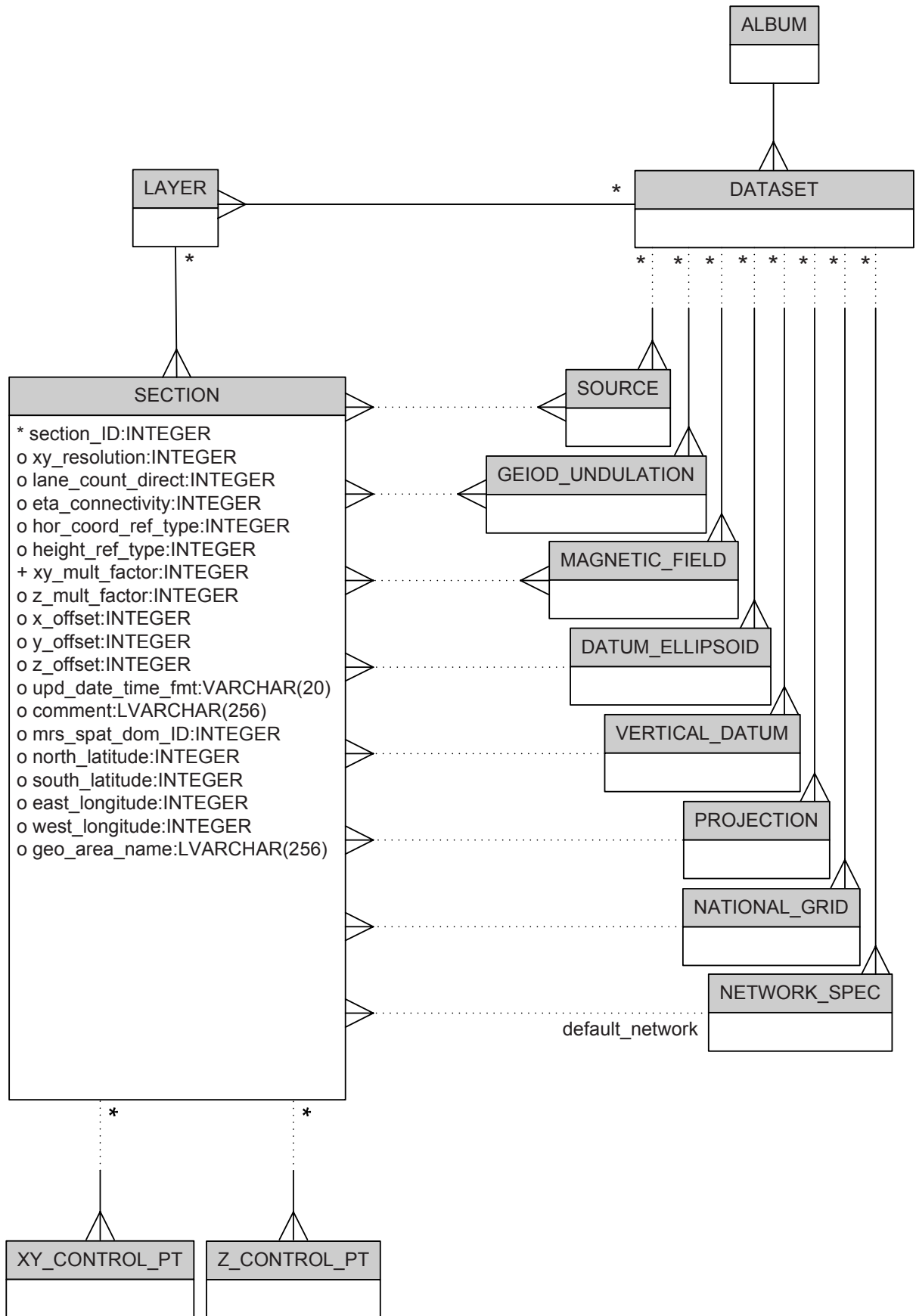

Sections are uniquely identified by their section ID. The section ID is only unique within a Layer. The xy multiplication factor is the only mandatory attribute. All others are optional except that either or both of the geo area name or all four latitude values must exist.

14.4.5.1.2 Physical Model

```
CREATE TABLE SECTION
(
  DATASET_ID INTEGER,
  LAYER_ID INTEGER,
  SECTION_ID INTEGER,
  XY_RESOLUTION INTEGER,
  LANE_COUNT_DIRECT INTEGER,
  ETA_CONNECTIVITY INTEGER,
  HOR_COORD_REF_TYPE INTEGER,
  HEIGHT_REF_TYPE INTEGER,
  XY_MULT_FACTOR INTEGER
  CONSTRAINT SECTION_XY_MULT_FACTOR_NOT_NULL
  NOT NULL,
  Z_MULT_FACTOR INTEGER,
  X_OFFSET INTEGER,
  Y_OFFSET INTEGER,
  Z_OFFSET INTEGER,
  UPD_DATE_TIME_FMT CHARACTER VARYING(20),
  COMMENT_DLS INTEGER,
  COMMENT_STRING INTEGER,
  MRS_SPAT_DOM_ID INTEGER,
  NORTH_LATITUDE INTEGER,
  SOUTH_LATITUDE INTEGER,
  EAST_LONGITUDE INTEGER,
  WEST_LONGITUDE INTEGER,
  GEO_AREA_DLS INTEGER,
  GEO_AREA_STRING INTEGER,
  DATEL_ID INTEGER,
  VERDAT_ID INTEGER,
  PROJECTION_ID INTEGER,
  NATIONAL_GRID_ID INTEGER,
  DEFAULT_NETWORK INTEGER,

  CONSTRAINT SECTION_PRIMARY_KEY
  PRIMARY KEY (DATASET_ID, LAYER_ID, SECTION_ID),

  CONSTRAINT SECTION_LAYER_ID_EXISTS
  FOREIGN KEY(DATASET_ID, LAYER_ID)
  REFERENCES LAYER(DATASET_ID, LAYER_ID),

  CONSTRAINT SECTION_COMMENT_EXISTS
  FOREIGN KEY(COMMENT_DLS, COMMENT_STRING)
  REFERENCES LCS_TEXT(DLS, STRING_ID)
  MATCH FULL,

  CONSTRAINT SPATIAL_DOMAIN_GEO_AREA_EXISTS
  FOREIGN KEY(GEO_AREA_DLS, GEO_AREA_STRING)
  REFERENCES LCS_TEXT(DLS, STRING_ID)
  MATCH FULL,

  CONSTRAINT SECTION_DATEL_ID_EXISTS
  FOREIGN KEY(DATASET_ID, DATEL_ID)
  REFERENCES DATUM_ELLIPSOID(DATASET_ID, DATEL_ID),
```

```
CONSTRAINT SECTION_VERDAT_ID_EXISTS  
FOREIGN KEY(DATASET_ID, VERDAT_ID)  
REFERENCES VERTICAL_DATUM(DATASET_ID, VERDAT_ID),
```

```
CONSTRAINT SECTION_PROJECTION_ID_EXISTS  
FOREIGN KEY(DATASET_ID, PROJECTION_ID)  
REFERENCES PROJECTION(DATASET_ID, PROJECTION_ID),
```

```
CONSTRAINT SECTION_NATIONAL_GRID_ID_EXISTS  
FOREIGN KEY(DATASET_ID, NATIONAL_GRID_ID)  
REFERENCES NATIONAL_GRID(DATASET_ID, NATIONAL_GRID_ID),
```

```
CONSTRAINT SECTION_NETWORK_ID_EXISTS  
FOREIGN KEY(DATASET_ID, DEFAULT_NETWORK)  
REFERENCES NETWORK_SPEC(DATASET_ID, NETWORK_ID),
```

```
CONSTRAINT SECTION_BOUNDARY_MISSING  
CHECK ((NORTH_LATITUDE IS NOT NULL AND SOUTH_LATITUDE IS NOT NULL AND  
EAST_LATITUDE IS NOT NULL AND WEST_LATITUDE IS NOT NULL) OR GEO_AREA_DLS IS  
NOT NULL)  
)
```

```
ALTER TABLE LAYER  
ADD CONSTRAINT LAYER_HAS_SECTION  
CHECK (LAYER_ID IN  
(SELECT LAYER_ID FROM SECTION))  
DEFERRABLE INITIALLY DEFERRED
```

```
CREATE TABLE SECTION_SOURCE
(
  DATASET_ID INTEGER,
  LAYER_ID INTEGER,
  SECTION_ID INTEGER,
  SOURCE_ID INTEGER,

  CONSTRAINT SECTION_SOURCE_PRIMARY_KEY
    PRIMARY KEY (DATASET_ID, LAYER_ID, SECTION_ID, SOURCE_ID),

  CONSTRAINT SECTION_SOURCE_SECTION_ID_EXISTS
    FOREIGN KEY(DATASET_ID, LAYER_ID, SECTION_ID)
    REFERENCES SECTION(DATASET_ID, LAYER_ID, SECTION_ID),

  CONSTRAINT SECTION_SOURCE_SOURCE_ID_EXISTS
    FOREIGN KEY(DATASET_ID, SOURCE_ID)
    REFERENCES SOURCE(DATASET_ID, SOURCE_ID)
)

CREATE TABLE SECTION_GEOID
(
  DATASET_ID INTEGER,
  LAYER_ID INTEGER,
  SECTION_ID INTEGER,
  GEOID_ID INTEGER,

  CONSTRAINT SECTION_GEOID_PRIMARY_KEY
    PRIMARY KEY (DATASET_ID, LAYER_ID, SECTION_ID, GEOID_ID),

  CONSTRAINT SECTION_GEOID_SECTION_ID_EXISTS
    FOREIGN KEY(DATASET_ID, LAYER_ID, SECTION_ID)
    REFERENCES SECTION(DATASET_ID, LAYER_ID, SECTION_ID),

  CONSTRAINT SECTION_GEOID_GEOID_ID_EXISTS
    FOREIGN KEY(DATASET_ID, GEOID_ID)
    REFERENCES GEOID_UNDULATION(DATASET_ID, GEOID_ID)
)

CREATE TABLE SECTION_MAG_FIELD
(
  DATASET_ID INTEGER,
  LAYER_ID INTEGER,
  SECTION_ID INTEGER,
  MAGNETIC_FIELD_ID INTEGER,

  CONSTRAINT SECTION_MAG_FIELD_PRIMARY_KEY
    PRIMARY KEY (DATASET_ID, LAYER_ID, SECTION_ID, MAGNETIC_FIELD_ID),

  CONSTRAINT SECTION_MAG_FIELD_SECTION_ID_EXISTS
    FOREIGN KEY(DATASET_ID, LAYER_ID, SECTION_ID)
    REFERENCES SECTION(DATASET_ID, LAYER_ID, SECTION_ID),

  CONSTRAINT SECTION_MAG_FIELD_MAGNETIC_FIELD_ID_EXISTS
    FOREIGN KEY(DATASET_ID, MAGNETIC_FIELD_ID)
    REFERENCES MAGNETIC_FIELD(DATASET_ID, MAGNETIC_FIELD_ID)
)
```

14.4.5.2 Section Source Reference

Of the Sources defined for this Section's Dataset, the ones (if any) that are actually used in this Section, specified by their integer dataset ID and integer source ID (see 14.4.3.8). This dataset ID shall be the same as the dataset ID of the Section.

14.4.5.3 Section Orthometric Reference

Of the Geoid Undulations defined for this Section's Dataset, the ones (if any) that are actually used in this Section, specified by their integer dataset ID and integer geoid ID (see 14.4.3.5.6). This dataset ID shall be the same as the dataset ID of the Section.

14.4.5.4 Section Magnetism Reference

Of the Magnetic Fields defined for this Section's Dataset, the ones (if any) that are actually used in this Section, specified by their integer dataset ID and integer magnetic field ID (see 14.4.3.5.7). This dataset ID shall be the same as the dataset ID of the Section.

14.4.5.5 Section Horizontal Datum Reference

Of the Datum Ellipsoids defined for this Section's Dataset, the one that is actually used in this Section, specified by their integer dataset ID and integer datel ID (see 14.4.3.5.2). This dataset ID shall be the same as the dataset ID of the Section.

14.4.5.6 Section Vertical Datum Reference

Of the Vertical Datums defined for this Section's Dataset, the one (if any) that is actually used in this Section, specified by their integer dataset ID and integer verdat ID (see 14.4.3.5.3). This dataset ID shall be the same as the dataset ID of the Section.

14.4.5.7 Section Projection Reference

Of the Projections defined for this Section's Dataset, the one (if any) that is actually used in this Section, specified by their integer dataset ID and integer projection ID (see 14.4.3.5.4). This dataset ID shall be the same as the dataset ID of the Section.

14.4.5.8 Section National Grid Reference

Of the National Grids defined for this Section's Dataset, the one (if any) that is actually used in this Section, specified by their integer dataset ID and integer national grid ID (see 14.4.3.5.5). This dataset ID shall be the same as the dataset ID of the Section.

14.4.5.9 Section Default Network Specification Reference

Of the Network Specifications defined for this Section's Dataset, the one (if any) that is chosen to be the default one for this Section, specified by their integer dataset ID and integer network ID (see 14.4.3.6). This dataset ID shall be the same as the dataset ID of the Section.

14.4.5.10 Section XY Control Point(s)

14.4.5.10.1 Logical Model

Any number of points with highly accurate X and Y coordinates which may be used to check the accuracy of coordinates obtained from digitizing.

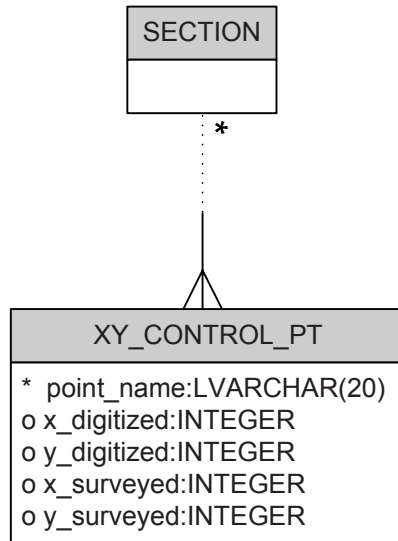

Each xy control point is uniquely identified by a point name within the Section. All other attributes are optional but you must have at least one of them.

14.4.5.10.2 Physical Model

```

CREATE TABLE XY_CONTROL_POINT
(
  DATASET_ID INTEGER,
  LAYER_ID INTEGER,
  SECTION_ID INTEGER,
  POINT_NAME_DLS INTEGER,
  POINT_NAME_STRING INTEGER,
  X_DIGITIZED INTEGER,
  Y_DIGITIZED INTEGER,
  X_SURVEYED INTEGER,
  Y_SURVEYED INTEGER,

  CONSTRAINT XY_CONTROL_POINT_PRIMARY_KEY
    PRIMARY KEY (DATASET_ID, LAYER_ID, SECTION_ID, POINT_NAME_DLS,
    POINT_NAME_STRING),

  CONSTRAINT XY_CONTROL_POINT_SECTION_ID_EXISTS
    FOREIGN KEY(DATASET_ID, LAYER_ID, SECTION_ID)
    REFERENCES SECTION(DATASET_ID, LAYER_ID, SECTION_ID),

  CONSTRAINT XY_CONTROL_POINT_POINT_NAME_EXISTS
    FOREIGN KEY(POINT_NAME_DLS, POINT_NAME_STRING)
    REFERENCES LCS_TEXT(DLS, STRING_ID)
    MATCH FULL,

  CONSTRAINT XY_CONTROL_POINT_ATTRIBUTE_MISSING
    CHECK (X_DIGITIZED IS NOT NULL OR Y_DIGITIZED IS NOT NULL OR X_SURVEYED IS NOT
    NULL OR Y_SURVEYED IS NOT NULL)
)
  
```

14.4.5.11 Section Z Control Point(s)

14.4.5.11.1 Logical Model

Any number of points with highly accurate coordinates which may be used to check the accuracy of coordinates obtained from photogrammetry.

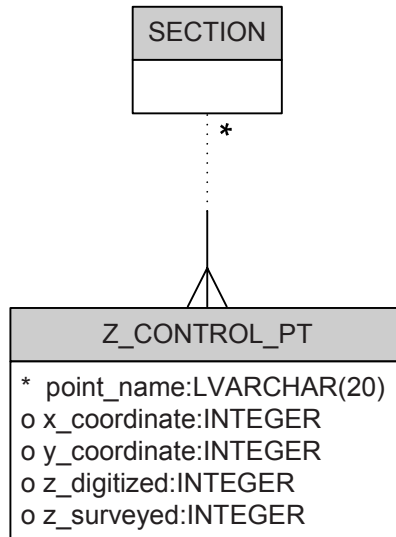

Each z control point is uniquely identified by a point name within the Section. All other attributes are optional but you must have at least one of (x and y coordinate, z digitized, or z surveyed).

14.4.5.11.2 Physical Model

```

CREATE TABLE Z_CONTROL_POINT
(
    DATASET_ID INTEGER,
    LAYER_ID INTEGER,
    SECTION_ID INTEGER,
    POINT_NAME_DLS INTEGER,
    POINT_NAME_STRING INTEGER,
    X_COORDINATE INTEGER,
    Y_COORDINATE INTEGER,
    Z_DIGITIZED INTEGER,
    Z_SURVEYED INTEGER,

    CONSTRAINT Z_CONTROL_POINT_PRIMARY_KEY
        PRIMARY KEY (DATASET_ID, LAYER_ID, SECTION_ID, POINT_NAME_DLS,
            POINT_NAME_STRING),

    CONSTRAINT Z_CONTROL_POINT_SECTION_ID_EXISTS
        FOREIGN KEY(DATASET_ID, LAYER_ID, SECTION_ID)
        REFERENCES SECTION(DATASET_ID, LAYER_ID, SECTION_ID),

    CONSTRAINT Z_CONTROL_POINT_POINT_NAME_EXISTS
        FOREIGN KEY(POINT_NAME_DLS, POINT_NAME_STRING)
        REFERENCES LCS_TEXT(DLS, STRING_ID)
        MATCH FULL,

    CONSTRAINT Z_CONTROL_POINT_ATTRIBUTE_MISSING
        CHECK ((X_COORDINATE IS NOT NULL AND Y_COORDINATE IS NOT NULL) OR Z_DIGITIZED
            IS NOT NULL OR Z_SURVEYED IS NOT NULL)
)
    
```

14.4.6 DLS

14.4.6.1 Logical Model

Members at each of the levels of Album partitioning (Dataset, Layer, and Section) are identified with ID's of the appropriate type, unique only within the parent level member. GDF dataset ID's are unique within the Album. GDF layer ID's are only unique within the containing Dataset. GDF section ID's are only unique within the containing Layer. For this SQL encoding, a DLS value is introduced as a surrogate ID for GDF Sections, unique across the entire Album. This obviates the need to include the GDF dataset ID, GDF layer ID, and GDF section ID together as the primary key for Section.

DLS is an integer representing the unique combination of a dataset ID, a layer ID, and a section ID. To represent an entire Layer, the section ID shall be NULL. To represent an entire Dataset, both the layer ID and section IDs shall be NULL.

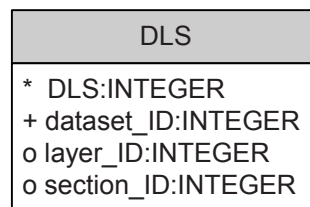

14.4.6.2 Physical Model

See 14.2.2.2.2 for table create.

```
ALTER TABLE DLS
  CONSTRAINT DLS_SECTION_EXISTS
  FOREIGN KEY(DATASET_ID, LAYER_ID, SECTION_ID)
  REFERENCES SECTION(DATASET_ID, LAYER_ID, SECTION_ID)
  MATCH PARTIAL
```

14.5 General GDF data

14.5.1 Text Records

14.5.1.1 Logical Model

For Attribute Values only, and which are of type text, the maximum length (11 characters in the MRS) of the text string may dictate that the string be separated out as a separate Text entity. Each Text entity is given a text ID, unique within a GDF Section. In this case, the Attribute Value will be the DLS/text ID, rather than the text string itself.

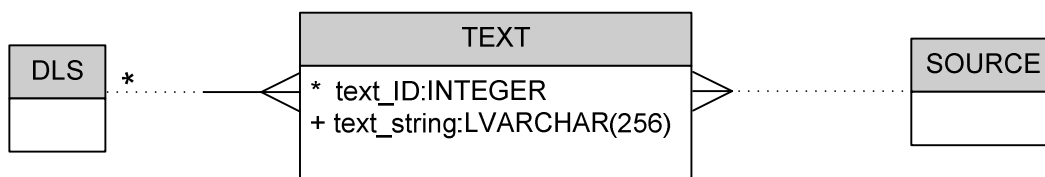

Text can have attributes (see 14.8).

14.5.1.2 Physical Model

Implemented as LCS_TEXT (See 14.2.2.4.4). The string_ID there will replace the text_ID here.

14.5.2 Time Domain Records

14.5.2.1 Logical Model

For Attribute Values of type time, the length of the time string may dictate that the string be separated out as a separate Time Domain entity. Each Time Domain entity is given a time ID, unique within a GDF Section. In this case, the Attribute Value will be the DLS/time ID, rather than the Time Domain string itself.

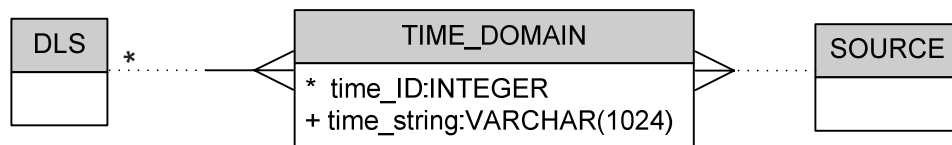

14.5.2.2 Physical Model

```

CREATE TABLE TIME_DOMAIN
(
  DLS INTEGER,
  TIME_ID INTEGER,
  TIME_STRING CHARACTER VARYING(1024)
  CONSTRAINT TIME_DOMAIN_TIME_STRING_NOT_NULL
  NOT NULL,
  SOURCE_ID INTEGER,

  CONSTRAINT TIME_DOMAIN_PRIMARY_KEY
  PRIMARY KEY (DLS, TIME_ID),

  CONSTRAINT TIME_DOMAIN_DLS_EXISTS
  FOREIGN KEY(DLS)
  REFERENCES DLS(DLS),

  CONSTRAINT TIME_DOMAIN_SOURCE_EXISTS
  FOREIGN KEY(DLS.DATASET_ID, SOURCE_ID)
  REFERENCES SOURCE(DATASET_ID, SOURCE_ID)
)
  
```

14.5.3 Geopolitical Structure Definition (GSD)

14.5.3.1 Logical Model

GDF provides for a means to define geopolitical structures in terms of a generic description of the hierarchical and non-hierarchical relations between Administrative Area Features and Named Area Features, constituting a Directed Acyclic Graph (DAG), in a given (part of a) country.

Geopolitical Structure Definition (GSD) is an attribute data type. It is uniquely identified by a geopolitical structure definition ID, unique within a Dataset. It may have a name.

The Geopolitical Structure Definition may be made up of one or more Geopolitical Structure Definition Components, each of which is uniquely identified by a geopolitical structure definition component ID unique within the same Dataset as the Geopolitical Structure Definition. A Geopolitical Structure Definition Component must have a four-character Feature Class Code referencing Feature Class Code (see 14.2.2.10)

and at least one name. It may have a description and any number of other Geopolitical Structure Definition Components as its immediate child, immediate parent, contained child, and/or lowest full predecessor.

The Geopolitical Structure Containment attribute (Attribute Data Type = GSD) is defined by a Geopolitical Structure Definition and a Geopolitical Structure Definition Component.

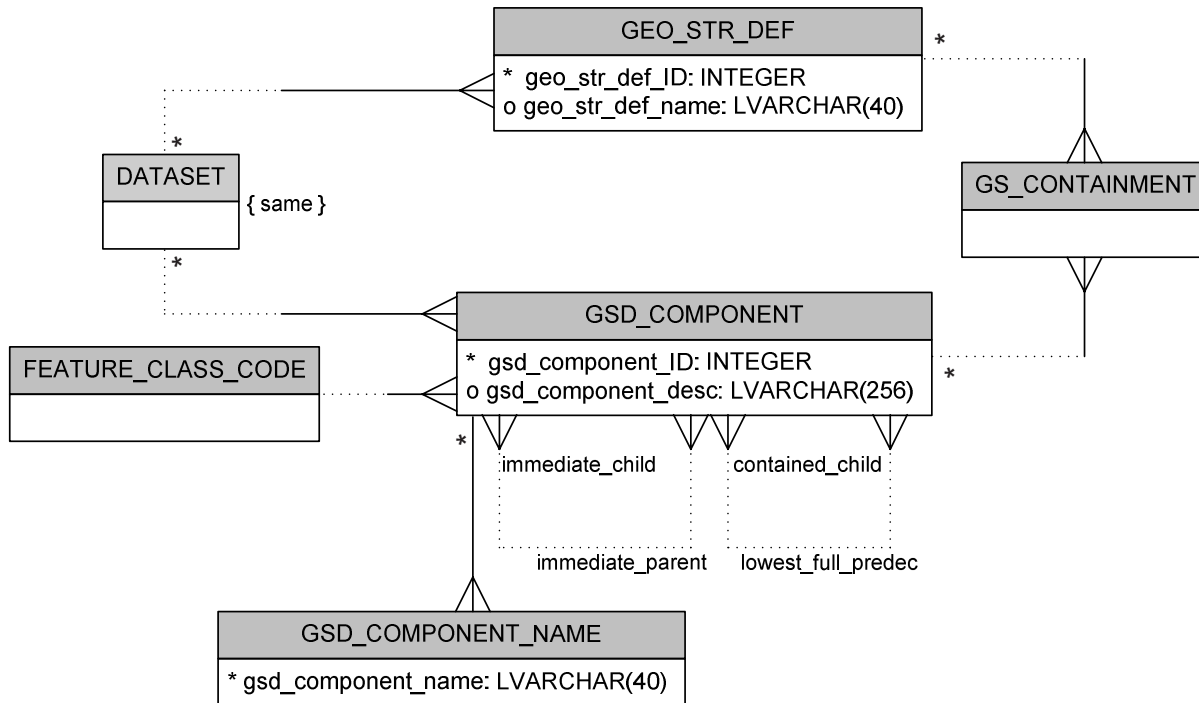

14.5.3.2 Physical Model

```

CREATE TABLE GEO_STR_DEF
(
  DATASET_ID INTEGER,
  GEO_STR_DEF_ID INTEGER,
  GSD_DLS INTEGER,
  GSD_STRING INTEGER,

  CONSTRAINT GEO_STR_DEF_PRIMARY_KEY
    PRIMARY KEY (DATASET_ID, GEO_STR_DEF_ID),

  CONSTRAINT GEO_STR_DEF_DATASET_ID_EXISTS
    FOREIGN KEY(DATASET_ID)
    REFERENCES DATASET(DATASET_ID),

  CONSTRAINT GEO_STR_DEF_GSD_EXISTS
    FOREIGN KEY(GSD_DLS, GSD_STRING)
    REFERENCES LCS_TEXT(DLS, STRING_ID)
    MATCH FULL
)

CREATE TABLE GSD_COMPONENT
(
  DATASET_ID INTEGER,
  GSD_COMPONENT_ID INTEGER,
  GSD_COMP_DLS INTEGER,
  GSD_COMP_STRING INTEGER,
  FEATURE_CLASS_CODE CHAR(4),

```

```

CONSTRAINT GSD_COMPONENT_PRIMARY_KEY
    PRIMARY KEY (DATASET_ID, GEO_STR_DEF_ID),

CONSTRAINT GSD_COMPONENT_DATASET_ID_EXISTS
    FOREIGN KEY(DATASET_ID)
    REFERENCES DATASET(DATASET_ID),

CONSTRAINT GSD_COMPONENT_GSD_COMPONENT_EXISTS
    FOREIGN KEY(GSD_COMP_DLS, GSD_COMP_STRING)
    REFERENCES LCS_TEXT(DLS, STRING_ID)
    MATCH FULL,

CONSTRAINT GSD_COMPONENT_FEATURE_CLASS_CODE_EXISTS
    FOREIGN KEY(FEATURE_CLASS_CODE)
    REFERENCES FEATURE_CLASS_CODE(FEATURE_CLASS_CODE)
)

```

NOTE Existence of at least one GSD_COMPONENT_NAME for each GSD_COMPONENT is checked after GSD_COMPONENT_NAME table has been created.

```

CREATE TABLE GSD_COMPONENT_NAME
(
    DATASET_ID INTEGER,
    GSD_COMPONENT_ID INTEGER,
    COMP_NAME_DLS INTEGER,
    COMP_NAME_STRING INTEGER,

    CONSTRAINT GSD_COMPONENT_NAME_PRIMARY_KEY
        PRIMARY KEY (DATASET_ID, GSD_COMPONENT_ID, COMP_NAME_DLS,
            COMP_NAME_STRING),

    CONSTRAINT GSD_COMPONENT_NAME_GSD_COMPONENT_ID_EXISTS
        FOREIGN KEY(DATASET_ID, GSD_COMPONENT_ID)
        REFERENCES GSD_COMPONENT(DATASET_ID, GSD_COMPONENT_ID),

    CONSTRAINT GSD_COMPONENT_NAME_COMPONENT_NAME_EXISTS
        FOREIGN KEY(COMP_NAME_DLS, COMP_NAME_STRING)
        REFERENCES LCS_TEXT(DLS, STRING_ID)
        MATCH FULL
)

ALTER TABLE GSD_COMPONENT
    ADD CONSTRAINT GSD_COMPONENT_HAS_COMPONENT_NAME
    CHECK (DATASET_ID, GSD_COMPONENT_ID IN
        (SELECT DATASET_ID, GSD_COMPONENT_ID FROM GSD_COMPONENT_NAME))
    DEFERRABLE INITIALLY DEFERRED

```

```

CREATE TABLE GS_CONTAINMENT
(
    DATASET_ID INTEGER,
    GEO_STR_DEF_ID INTEGER,
    GSD_COMPONENT_ID INTEGER,

    CONSTRAINT GS_CONTAINMENT_PRIMARY_KEY
        PRIMARY KEY (DATASET_ID, GEO_STR_DEF_ID, GSD_COMPONENT_ID),

    CONSTRAINT GS_CONTAINMENT_GEO_STR_DEF_ID_EXISTS
        FOREIGN KEY(DATASET_ID, GEO_STR_DEF_ID)
        REFERENCES GEO_STR_DEF_ID(DATASET_ID, GEO_STR_DEF_ID),

```

```
CONSTRAINT GS_CONTAINMENT_GSD_COMPONENT_ID_EXISTS
  FOREIGN KEY(DATASET_ID, GSD_COMPONENT_ID)
  REFERENCES GSD_COMPONENT(DATASET_ID, GSD_COMPONENT_ID)
)

CREATE TABLE GSD_COMP_HIER
(
  DATASET_ID INTEGER,
  IMMEDIATE_PARENT INTEGER,
  IMMEDIATE_CHILD INTEGER,

  CONSTRAINT GSD_COMP_HIER_PRIMARY_KEY
    PRIMARY KEY (DATASET_ID, IMMEDIATE_PARENT, IMMEDIATE_CHILD),

  CONSTRAINT GSD_COMP_HIER_IMMEDIATE_PARENT_EXISTS
    FOREIGN KEY(DATASET_ID, IMMEDIATE_PARENT)
    REFERENCES GSD_COMPONENT(DATASET_ID, GSD_COMPONENT_ID),

  CONSTRAINT GSD_COMP_HIER_IMMEDIATE_CHILD_EXISTS
    FOREIGN KEY(DATASET_ID, IMMEDIATE_CHILD)
    REFERENCES GSD_COMPONENT(DATASET_ID, GSD_COMPONENT_ID)
)

CREATE TABLE GSD_COMP_CONT_HIER
(
  DATASET_ID INTEGER,
  LOWEST_FULL_PREDEC INTEGER,
  CONTAINED_CHILD INTEGER,

  CONSTRAINT GSD_COMP_CONT_HIER_PRIMARY_KEY
    PRIMARY KEY (DATASET_ID, LOWEST_FULL_PREDEC, CONTAINED_CHILD),

  CONSTRAINT GSD_COMP_CONT_HIER_LOWEST_FULL_PREDEC_EXISTS
    FOREIGN KEY(DATASET_ID, LOWEST_FULL_PREDEC)
    REFERENCES GSD_COMPONENT(DATASET_ID, GSD_COMPONENT_ID),

  CONSTRAINT GSD_COMP_CONT_HIER_CONTAINED_CHILD_EXISTS
    FOREIGN KEY(DATASET_ID, CONTAINED_CHILD)
    REFERENCES GSD_COMPONENT(DATASET_ID, GSD_COMPONENT_ID)
)
```

14.5.4 User Defined Extensions

Users can extend the set of pre-defined Feature Theme Codes, Attribute Type Codes, and Relationship Type Codes and some metadata codes. No apparent impact on table layout exists except to be sure to reserve Feature Theme Codes in the range 81-99, Attribute Type Codes of which the first character is non-alphabetic (e.g.: !K, 8T, ...), and Relationship Type Codes in the range 9000-9999 for User Defined.

14.6 Features

14.6.1 Overview

In GDF real world objects (such as roads and buildings) or activities at a certain location are represented by Features.

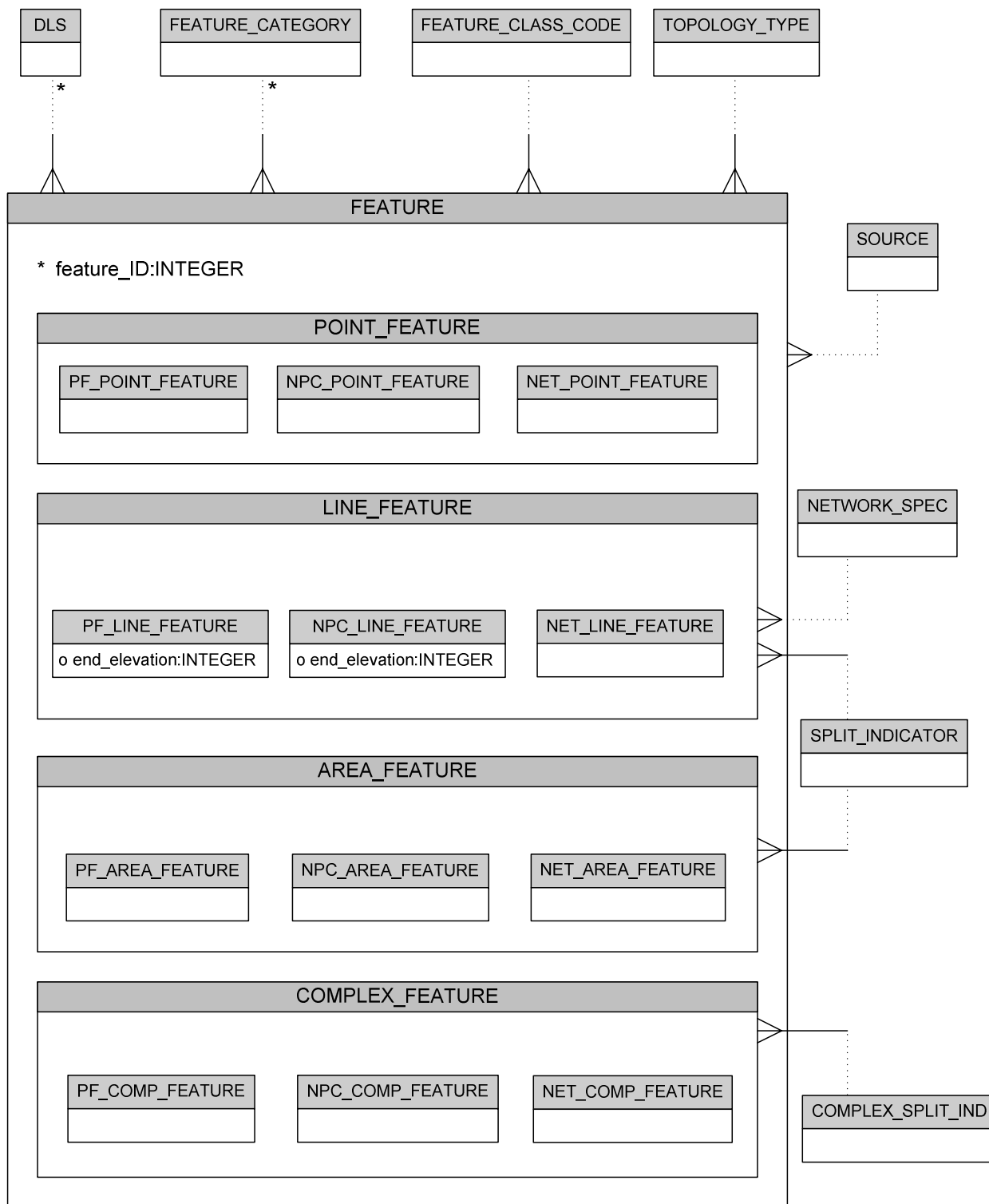

Features are identified by a feature ID. As a consequence of the multi-level Album partitioning, and the fact that feature ID is only unique within a Section for a single Feature Category (see Clause 14.2.2.8), the primary key for a Feature in an Album would have to include all of the following:

- Dataset ID
- Layer ID
- Section ID

Feature Category code

Feature ID

With the introduction of the surrogate key, DLS, this can be shortened to:

DLS

Feature Category code

Feature ID

Therefore, each Feature shall contain an integer DLS referencing DLS (see 14.4.6), an integer Feature Category code referencing Feature Category (see 14.2.2.8), and an integer feature ID.

All Features in a Section must have the same three character topology type referencing Topology Type (see 14.3), since the Section is part of a Layer and a Layer can have only one topology type.

All Features may have a source ID referencing Source (see 14.4.3.8).

Features are subtyped based on their Feature Category: Point, Line, Area, or Complex. Each of these is further subtyped based on their Topology Type.

Line Features have an optional integer network ID referencing Network Specification (see 14.4.3.6) and a mandatory Split Indicator (see 14.2.2.19).

Area Features have a mandatory Split Indicator (see 14.2.2.19).

Complex Features have a mandatory Complex Split Indicator (see 14.2.2.20).

14.6.2 Simple Features

14.6.2.1 Overview

Simple Features include Point, Line, and Area Features.

PF and NPC Point, Line, and Area Features may have associated topology and geometry. These can be specified using SQL/MM topology tables and geometry (spatial) types specified by ISO 13249-3. When including SQL/MM tables and types in this International Standard, content referring to ISO 13249-3 is shown in *italics*.

Point, Line, and Area Features having a NET Topology Type do not have explicit topology but must have a geometry attribute. These are dot, polyline, and polygon, respectively. Not all major existing RDBMS implementations permit the extension of SQL/MM spatial types to accommodate the z, elevation, and time attributes required by NET.

An NET Dot is a single Vertex. An NET Polyline is a sequence of two or more Vertexes. An NET Polygon is a sequence of four or more Vertexes where the first vertex must equal the last vertex. Each Vertex must have an x and a y coordinate and may have a z coordinate.

A Boolean height attribute can be used to indicate that height values are included. If height is True, h1 is mandatory and h2 is optional. If height is NULL or False, h1 and h2 are ignored. An NET Dot Vertex cannot have an h2 value.

A Boolean time attribute can be used to indicate that time values are included. If time is True, start appear, end appear, start disappear, and end disappear are all optional. If time is NULL or False, these four time attributes are ignored.

See NET_Point Features, NET Line Features, and NET Area Features for ERDs.

14.6.2.2 Point Features

14.6.2.2.1 Overview

All Point Features have a Feature Category number equal to 1 (one). The topological representation used further distinguishes each Point Feature type: planar full, non-planar connectivity, and non-explicit topology types of Point Features.

Each explicit topology type of Point Feature may have a single topological representation. Using elements of ISO 13249-3, the topological representation is by an *SQL/MM defined TopoGeo node (ST_Node)* for planar full topology or by a *TopoNet node (ST_Node)* for non-planar connectivity topology. *SQL/MM provides node ID, geometry, and containing face attributes. Node ID is unique within a TopoGeo “topology”, equivalent to a planar graph or within a TopoNet “network” where “topology” and “network” are the names of the SQL schemas which own the ST_Nodes. Nodes have geometry values to specify their geographic location, expressed as an SQL/MM ST_Point value which contains two or three coordinate values. For planar full topology, containing face applies only to isolated nodes. For non-planar connectivity topology, containing face is not applicable as there are no faces.*

GDF extends *ST_Node* with a GDF-specific GDF Node ID, unique within a Section. They can also include an integer source ID referencing Source (see 14.4.3.8). GDF also provides for a status code which, when applied to Nodes, has the following values and meanings:

- 1 = Section border Node
- 2 = normal Node
- 3 = Dataset border Node
- 4 = end of stub
- 5 = non-Section border Node

14.6.2.2.2 Planar Full Topology Point Features

14.6.2.2.2.1 Logical Model

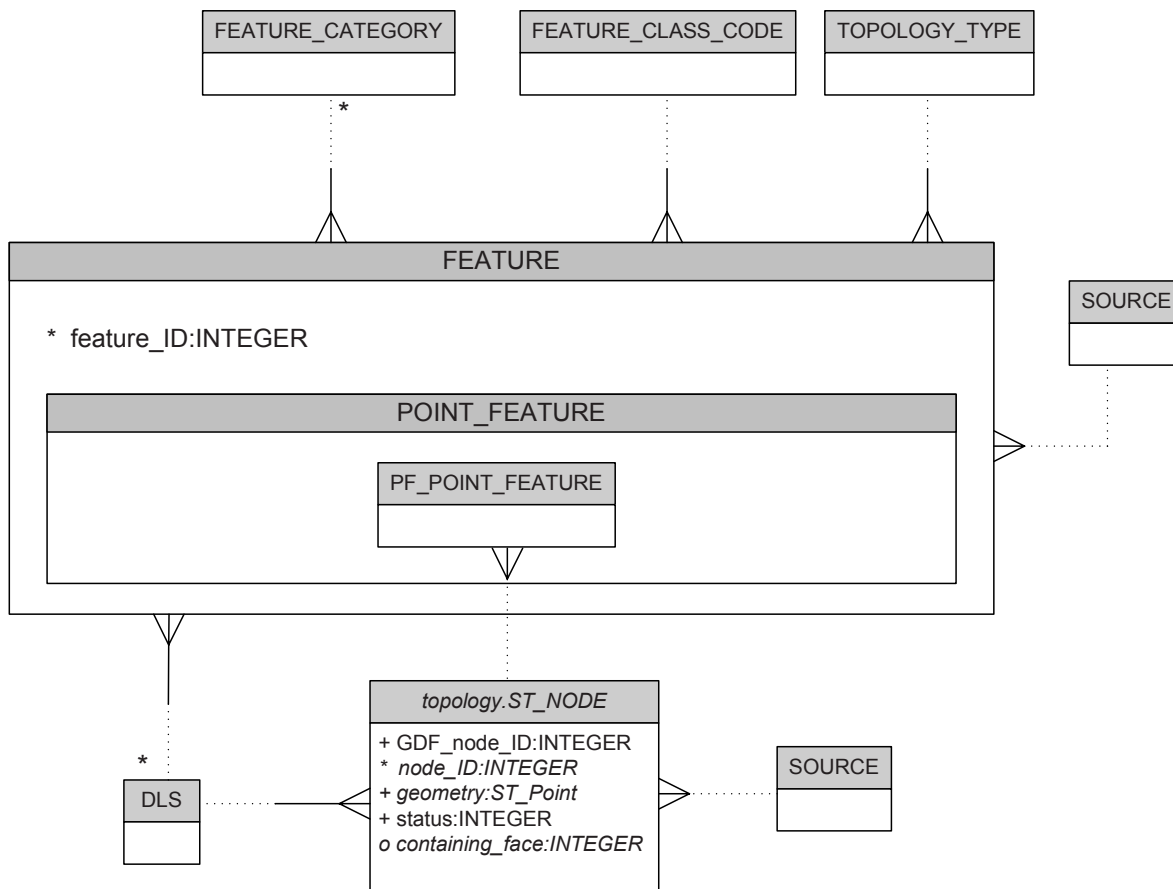

If the Point Feature has a Node, then both must be in the same Section (have the same DLS). They may have different Sources.

14.6.2.2.2.2 Physical Model

```

ALTER TABLE topology.ST_NODE
  ADD COLUMN DLS INTEGER

ALTER TABLE topology.ST_NODE
  ADD COLUMN GDF_NODE_ID INTEGER

ALTER TABLE topology.ST_NODE
  ADD COLUMN STATUS INTEGER

ALTER TABLE topology.ST_NODE
  ADD COLUMN SOURCE_ID INTEGER

ALTER TABLE topology.ST_NODE
  ADD CONSTRAINT PF_NODE_DLS_EXISTS
  FOREIGN KEY(DLS)
  REFERENCES DLS(DLS)

ALTER TABLE topology.ST_NODE
  ADD CONSTRAINT PF_NODE_SOURCE_EXISTS
  FOREIGN KEY(DLS.DATASET_ID, SOURCE_ID)
  
```

REFERENCES SOURCE(DATASET_ID, SOURCE_ID)

```
ALTER TABLE topology.ST_NODE
  ADD CONSTRAINT PF_NODE_UNIQUE_GDF_NODE_ID
  UNIQUE (DLS, GDF_NODE_ID)

CREATE TABLE PF_POINT_FEATURE
(
  DLS INTEGER,
  FEAT_CATEGORY_NUM INTEGER,
  FEATURE_ID INTEGER,
  FEATURE_CLASS_CODE CHAR(4)
  CONSTRAINT PF_POINT_FEATURE_FEATURE_CLASS_CODE_NOT_NULL
  NOT NULL,
  SOURCE_ID INTEGER,
  GDF_NODE_ID INTEGER,

  CONSTRAINT PF_POINT_FEATURE_PRIMARY_KEY
  PRIMARY KEY (DLS, FEAT_CATEGORY_NUM, FEATURE_ID),

  CONSTRAINT PF_POINT_FEATURE_DLS_EXISTS
  FOREIGN KEY(DLS)
  REFERENCES DLS(DLS),

  CONSTRAINT PF_POINT_FEATURE_FEATURE_CLASS_EXISTS
  FOREIGN KEY(FEATURE_CLASS_CODE)
  REFERENCES FEATURE_CLASS(FEAT_CLASS_CODE),

  CONSTRAINT PF_POINT_FEATURE_SOURCE_EXISTS
  FOREIGN KEY(DLS.DATASET_ID, SOURCE_ID)
  REFERENCES SOURCE(DATASET_ID, SOURCE_ID),

  CONSTRAINT PF_POINT_FEATURE_NODE_EXISTS
  FOREIGN KEY(DLS, GDF_NODE_ID)
  REFERENCES topology.ST_NODE(DLS, GDF_NODE_ID),

  CONSTRAINT PF_POINT_FEATURE_IS_POINT
  CHECK (FEAT_CATEGORY_NUM = 1)
)
```

14.6.2.2.3 Non-Planar Connectivity Topology Point Features

14.6.2.2.3.1 Logical Model

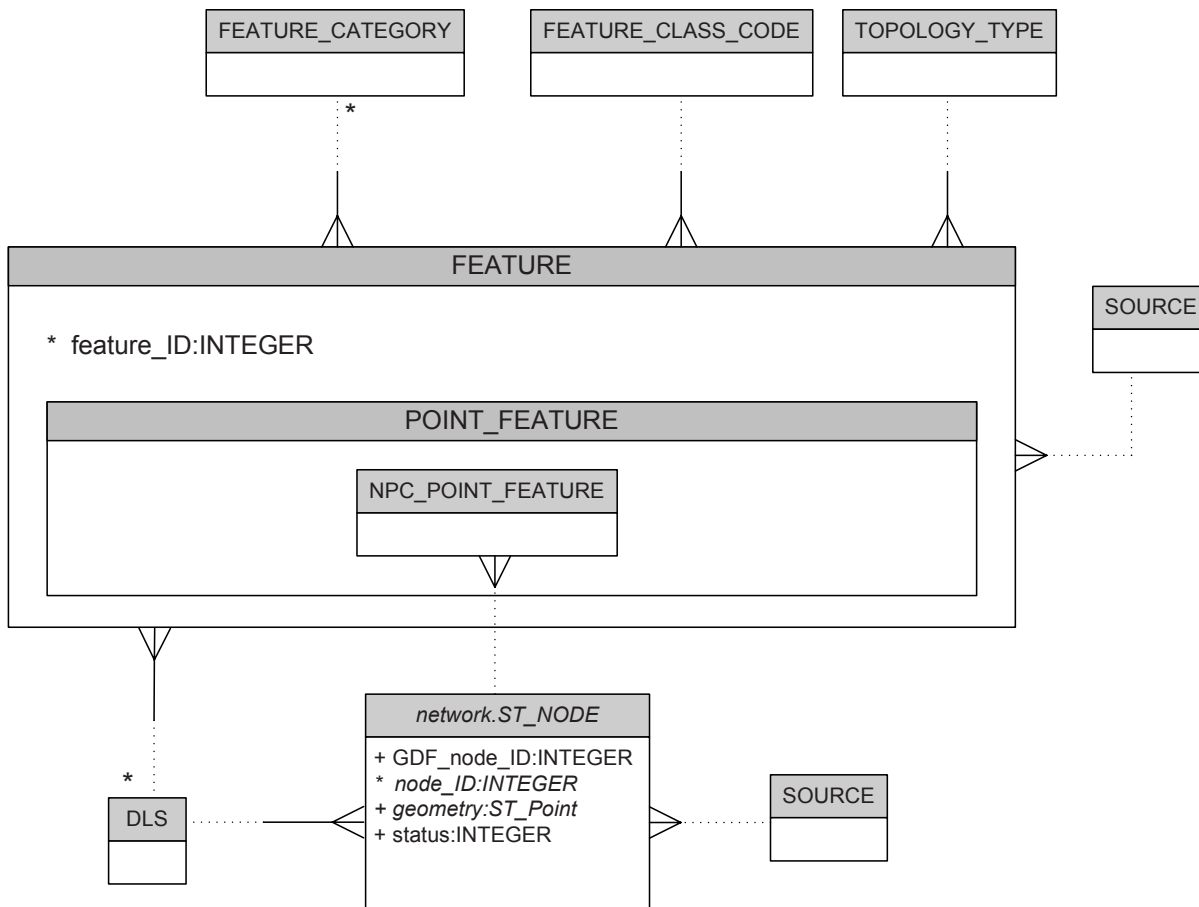

If the Point Feature has a Node, then both must be in the same Section (have the same DLS). They may have different Sources.

14.6.2.2.3.2 Physical Model

```
ALTER TABLE network.ST_NODE
  ADD COLUMN DLS INTEGER
```

```
ALTER TABLE network.ST_NODE
  ADD COLUMN GDF_NODE_ID INTEGER
```

```
ALTER TABLE network.ST_NODE
  ADD COLUMN STATUS INTEGER
```

```
ALTER TABLE network.ST_NODE
  ADD COLUMN SOURCE_ID INTEGER
```

```
ALTER TABLE network.ST_NODE
  ADD CONSTRAINT NPC_NODE_DLS_EXISTS
  FOREIGN KEY(DLS)
  REFERENCES DLS(DLS)
```

```
ALTER TABLE network.ST_NODE
  ADD CONSTRAINT NPC_NODE_SOURCE_EXISTS
```

*FOREIGN KEY(DLS.DATASET_ID, SOURCE_ID)
REFERENCES SOURCE(DATASET_ID, SOURCE_ID)*

ALTER TABLE *network*.ST_NODE
ADD CONSTRAINT NPC_NODE_UNIQUE_GDF_NODE_ID
UNIQUE (DLS, GDF_NODE_ID)

CREATE TABLE NPC_POINT_FEATURE
(
DLS INTEGER,
FEAT_CATEGORY_NUM INTEGER,
FEATURE_ID INTEGER,
FEATURE_CLASS_CODE CHAR(4)
CONSTRAINT NPC_POINT_FEATURE_FEATURE_CLASS_CODE_NOT_NULL
NOT NULL,
SOURCE_ID INTEGER,
GDF_NODE_ID INTEGER,

CONSTRAINT NPC_POINT_FEATURE_PRIMARY_KEY
PRIMARY KEY (DLS, FEAT_CATEGORY_NUM, FEATURE_ID),

*CONSTRAINT NPC_POINT_FEATURE_DLS_EXISTS
FOREIGN KEY(DLS)
REFERENCES DLS(DLS),*

*CONSTRAINT NPC_POINT_FEATURE_FEATURE_CLASS_EXISTS
FOREIGN KEY(FEATURE_CLASS_CODE)
REFERENCES FEATURE_CLASS(FEATURE_CLASS_CODE),*

*CONSTRAINT NPC_POINT_FEATURE_SOURCE_EXISTS
FOREIGN KEY(DLS.DATASET_ID, SOURCE_ID)
REFERENCES SOURCE(DATASET_ID, SOURCE_ID),*

CONSTRAINT NPC_POINT_FEATURE_NODE_EXISTS
FOREIGN KEY(DLS, GDF_NODE_ID)
REFERENCES *network*.ST_NODE(DLS, GDF_NODE_ID),

*CONSTRAINT NPC_POINT_FEATURE_IS_POINT
CHECK (FEAT_CATEGORY_NUM = 1)*
)

14.6.2.2.4 Non-Explicit Topology Point Features

14.6.2.2.4.1 Logical Model

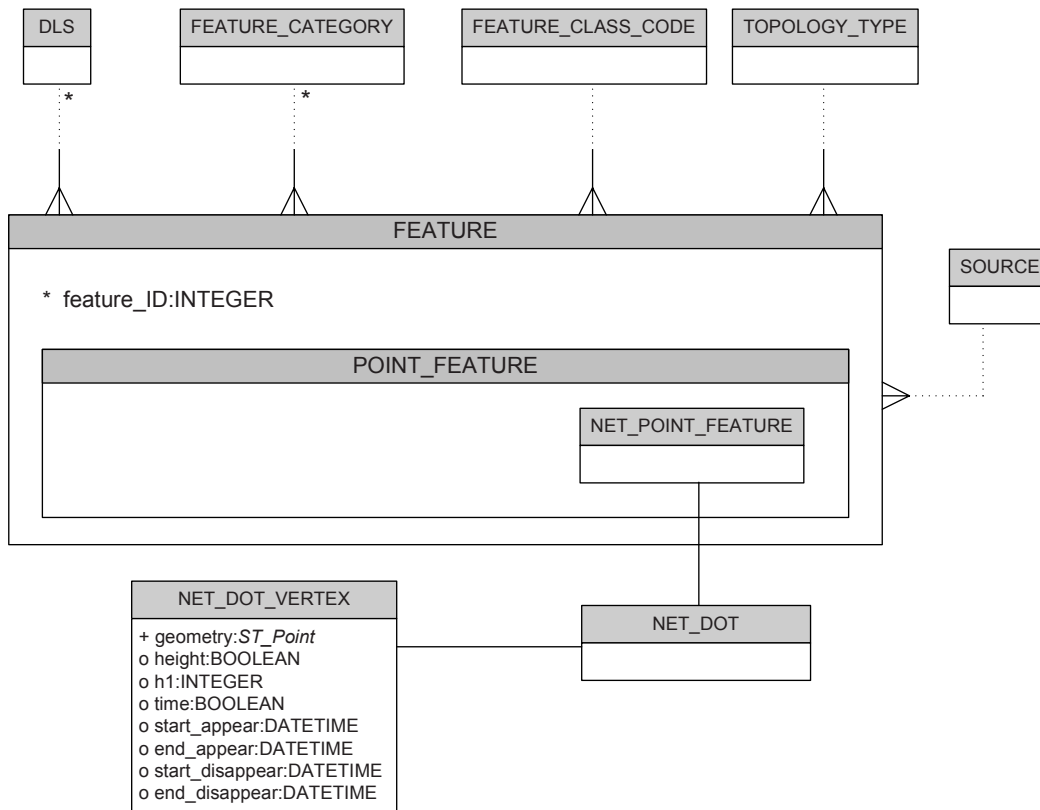

For Non-Explicit Topology Point Features, topology is not expressed by a topological primitive, but instead can be derived from its NET Dot geometry.

14.6.2.2.4.2 Physical Model

```

CREATE TABLE NET_POINT_FEATURE
(
  DLS INTEGER,
  FEAT_CATEGORY_NUM INTEGER,
  FEATURE_ID INTEGER,
  FEATURE_CLASS_CODE CHAR(4)
  CONSTRAINT NET_POINT_FEATURE_FEATURE_CLASS_CODE_NOT_NULL
  NOT NULL,
  SOURCE_ID INTEGER,
  GEOMETRY ST_POINT
  CONSTRAINT NET_POINT_FEATURE_GEOMETRY_NOT_NULL
  NOT NULL,
  HEIGHT BOOLEAN,
  H1 INTEGER,
  TIME BOOLEAN,
  START_APPEAR DATETIME,
  END_APPEAR DATETIME,
  START_DISAPPEAR DATETIME,
  END_DISAPPEAR DATETIME,

```

```

CONSTRAINT NET_POINT_FEATURE_PRIMARY_KEY
    PRIMARY KEY (DLS, FEAT_CATEGORY_NUM, FEATURE_ID),

CONSTRAINT NET_POINT_FEATURE_DLS_EXISTS
    FOREIGN KEY(DLS)
    REFERENCES DLS(DLS),

CONSTRAINT NET_POINT_FEATURE_FEATURE_CLASS_EXISTS
    FOREIGN KEY(FEATURE_CLASS_CODE)
    REFERENCES FEATURE_CLASS(FEATURE_CLASS_CODE),

CONSTRAINT NET_POINT_FEATURE_SOURCE_EXISTS
    FOREIGN KEY(DLS.DATASET_ID, SOURCE_ID)
    REFERENCES SOURCE(DATASET_ID, SOURCE_ID),

CONSTRAINT NET_POINT_FEATURE_HEIGHT_CONSTRAINT
    CHECK (((HEIGHT IS NULL OR HEIGHT IS FALSE) AND HI IS NULL)
    OR
    (HEIGHT IS TRUE AND HI IS NOT NULL)
    ),

CONSTRAINT NET_POINT_FEATURE_TIME_CONSTRAINT
    CHECK (((TIME IS NULL OR TIME IS FALSE) AND START_APPEAR IS NULL AND END_APPEAR
    IS NULL AND START_DISAPPEAR IS NULL AND END_DISAPPEAR IS NULL)
    OR
    (TIME IS TRUE)
    ),

CONSTRAINT NET_POINT_FEATURE_IS_POINT
    CHECK (FEAT_CATEGORY_NUM = 1)
)

```

14.6.2.3 Line Features

14.6.2.3.1 Overview

All Line Features have a Feature Category number equal to 2. As with Point Features, the topological representation further distinguishes each Line Feature type: planar full, non-planar connectivity, and non-explicit topology types of Line Features.

Line Features with explicit topology have a mandatory end elevation. Mandatory, but possibly NULL (depending on the setting in the Layer header (Z-Ref attribute)).

Adding this to the "Line Feature record" has been the MRS choice to guarantee that concatenated Edges making up a Line Feature do not have Z gaps (assumption is the Starting Edge elevation of Edge n+1 is identical to end elevation of Edge n). SQL does the same as MRS and adds end_elevation to PF and NPC Line Feature entities.

All Line Features have a mandatory split indicator to specify whether the Feature is fully contained within a single Section (0) or split across multiple Sections (1). If so, the Feature occurs twice, with different primary keys (since Section is part of the key). The feature ID's are not necessarily related. Conversion records explain which parts belong together.

14.6.2.3.2 Planar Full Topology Line Features

14.6.2.3.2.1 Logical Model

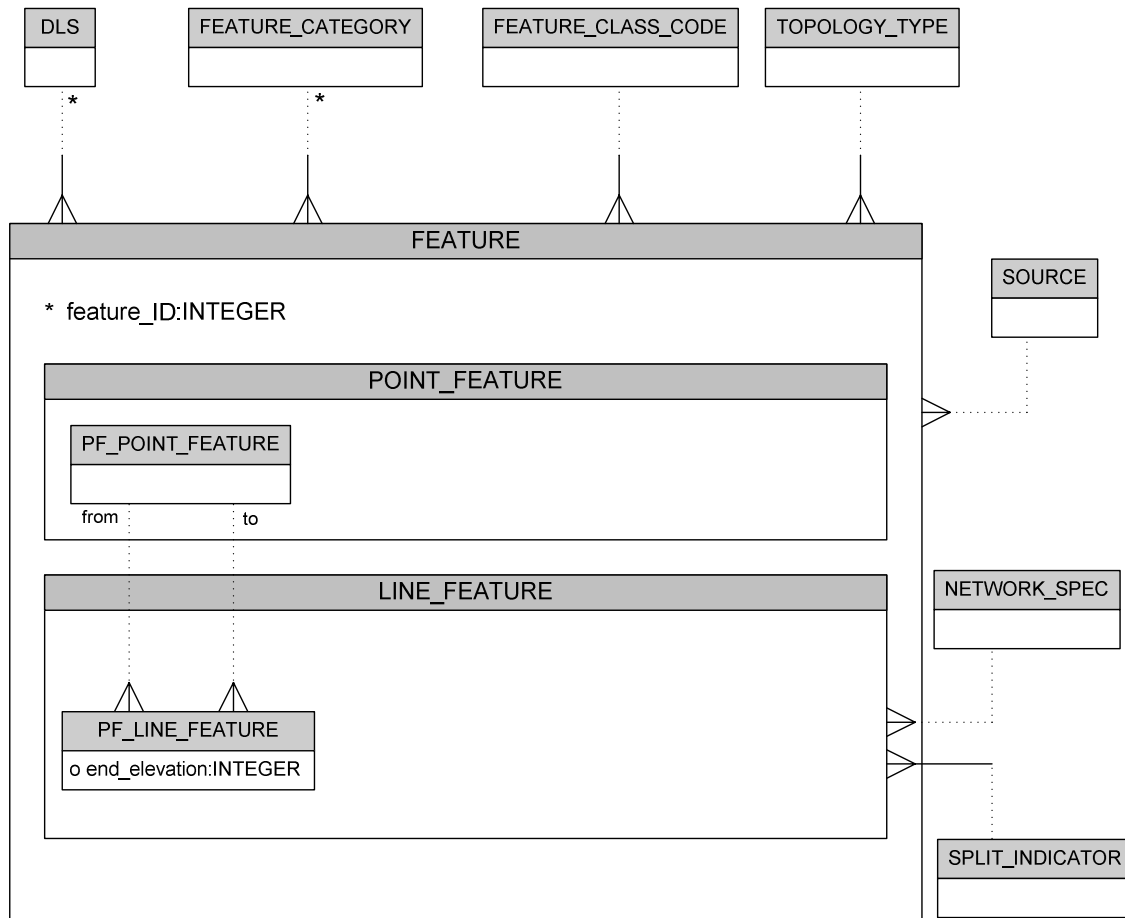

Planar full topology type of Line Features can have a from and a to planar full topology type Point Feature.

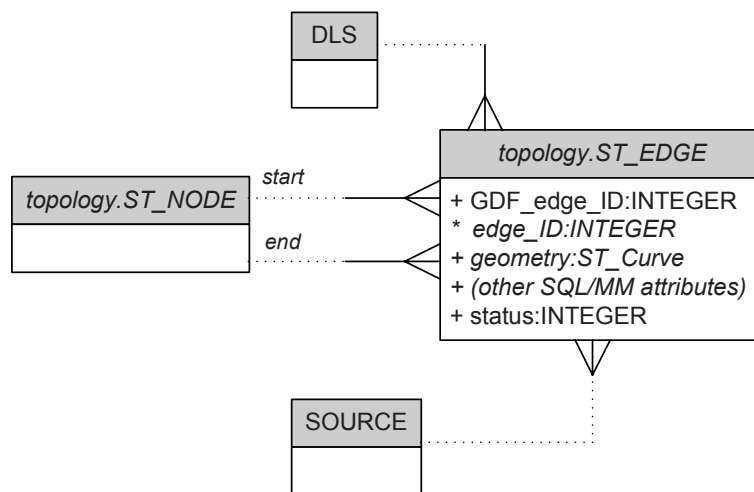

Using elements of ISO 13249-3, individual Edges are represented by SQL/MM ST_Edge. SQL/MM provides edge ID, geometry, and additional SQL/MM specific attributes. Edge ID is unique within a TopoGeo “topology”, equivalent to a planar graph. Here “topology” is the name of the SQL schema which owns the ST Nodes,

ST_Edges, and ST_Faces. Edges have geometry values to specify their geographic location and shape, expressed as an SQL/MM ST_Curve value. For compatibility with GDF, only the ST_Curve ST_Linestring subtype is applicable at this time. It is defined by a list of ST_Points, each of which contains two or three coordinate values. The additional SQL/MM attributes include next left edge, next right edge, left face, and right face. SQL/MM provides for start and end nodes, of type ST_Node, and insures that the edge geometry starts at the start node geometry location and ends at the end node geometry location.

GDF extends *ST_Edge* with a GDF-specific GDF Edge ID, unique within a Section. They can also include an integer source ID referencing Source (see 14.4.3.8). GDF also provides for a status code which, when applied to Edges, has the following values and meanings:

- 1 = (Not applicable)
- 2 = normal Edge
- 3 = Dataset border Edge
- 4 = (Not applicable)
- 5 = non-Section border Edge

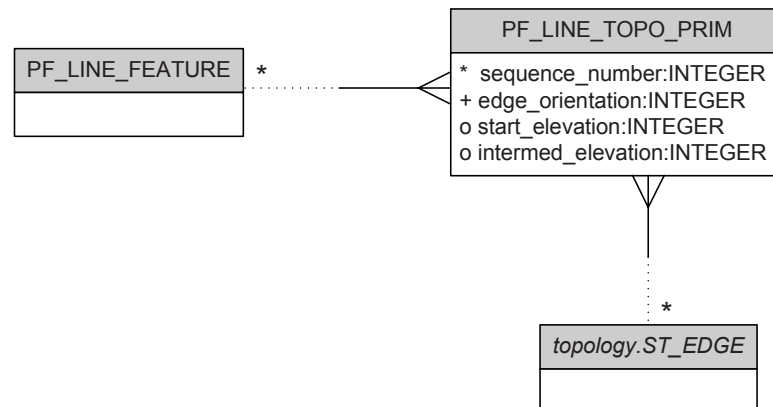

Each Planar Full Topology Type of Line Feature may have a single topological representation. Using elements of ISO 13249-3, the topological representation is by a list of *SQL/MM defined edges (ST_Edge)*, ordered by sequence number. The Edge orientation indicates whether the Line Feature uses each Edge in the direction it is defined, as dictated by the start and end Nodes.

14.6.2.3.2.2 Physical Model

```

CREATE TABLE PF_LINE_FEATURE
(
  DLS INTEGER,
  FEAT_CATEGORY_NUM INTEGER,
  FEATURE_ID INTEGER,
  FEATURE_CLASS_CODE CHAR(4)
  CONSTRAINT PF_LINE_FEATURE_FEATURE_CLASS_CODE_NOT_NULL
  NOT NULL,
  SPLIT_INDICATOR INTEGER
  CONSTRAINT PF_LINE_FEATURE_SPLIT_INDICATOR_NOT_NULL
  NOT NULL,
  END_ELEVATION INTEGER,
  SOURCE_ID INTEGER,
  NETWORK_ID INTEGER,
  FROM_FEAT_DLS INTEGER,
  FROM_FEAT_CATEGORY INTEGER,
  FROM_FEATURE_ID INTEGER,

```

TO_FEAT_DLS INTEGER,
TO_FEAT_CATEGORY INTEGER,
TO_FEATURE_ID INTEGER,

CONSTRAINT PF_LINE_FEATURE_PRIMARY_KEY
PRIMARY KEY (DLS, FEAT_CATEGORY_NUM, FEATURE_ID),

CONSTRAINT PF_LINE_FEATURE_DLS_EXISTS
FOREIGN KEY(DLS)
REFERENCES DLS(DLS),

CONSTRAINT PF_LINE_FEATURE_FEATURE_CLASS_EXISTS
FOREIGN KEY(FEATURE_CLASS_CODE),
REFERENCES FEATURE_CLASS(FEATURE_CLASS_CODE),

CONSTRAINT PF_LINE_FEATURE_SOURCE_EXISTS
FOREIGN KEY(DLS.DATASET_ID, SOURCE_ID)
REFERENCES SOURCE(DATASET_ID, SOURCE_ID),

CONSTRAINT PF_LINE_NETWORK_ID_EXISTS
FOREIGN KEY(DLS.DATASET_ID, NETWORK_ID)
REFERENCES NETWORK_SPEC(DATASET_ID, NETWORK_ID),

CONSTRAINT PF_LINE_FEATURE_IS_LINEAR
CHECK (FEAT_CATEGORY_NUM = 2),

CONSTRAINT PF_LINE_FROM_FEATURE_EXISTS
FOREIGN KEY(FROM_FEAT_DLS, FROM_FEAT_CATEGORY, FROM_FEATURE_ID)
REFERENCES PF_POINT_FEATURE (DLS, FEAT_CATEGORY_NUM, FEATURE_ID),

CONSTRAINT PF_LINE_TO_FEATURE_EXISTS
FOREIGN KEY(TO_FEAT_DLS, TO_FEAT_CATEGORY, TO_FEATURE_ID)
REFERENCES PF_POINT_FEATURE (DLS, FEAT_CATEGORY_NUM, FEATURE_ID)

)

ALTER TABLE *topology*.ST_EDGE
ADD COLUMN DLS INTEGER

ALTER TABLE *topology*.ST_EDGE
ADD COLUMN GDF_EDGE_ID INTEGER

ALTER TABLE *topology*.ST_EDGE
ADD COLUMN STATUS INTEGER

ALTER TABLE *topology*.ST_EDGE
ADD COLUMN SOURCE_ID INTEGER

ALTER TABLE *topology*.ST_EDGE
ADD CONSTRAINT PF_EDGE_DLS_EXISTS
FOREIGN KEY(DLS)
REFERENCES DLS(DLS)

ALTER TABLE *topology*.ST_EDGE
ADD CONSTRAINT PF_EDGE_SOURCE_EXISTS
FOREIGN KEY(DLS.DATASET_ID, SOURCE_ID)
REFERENCES SOURCE(DATASET_ID, SOURCE_ID)

ALTER TABLE *topology*.ST_EDGE
ADD CONSTRAINT PF_EDGE_UNIQUE_GDF_EDGE_ID
UNIQUE (DLS, GDF_EDGE_ID)

NOTE Relationship to ST_NODE already covered by SQL/MM.

```
CREATE TABLE PF_LINE_TOPO_PRIM
(
  DLS INTEGER,
  FEAT_CATEGORY_NUM INTEGER,
  FEATURE_ID INTEGER,
  SEQUENCE_NUMBER INTEGER,
  GDF_EDGE_ID INTEGER,
  EDGE_ORIENTATION INTEGER
  CONSTRAINT PF_LINE_TOPO_PRIM_EDGE_ORIENTATION_NOT_NULL
  NOT NULL,
  START_ELEVATION INTEGER,
  INTERMED_ELEVATION INTEGER,

  CONSTRAINT PF_LINE_TOPO_PRIM_PRIMARY_KEY
  PRIMARY KEY (DLS, FEAT_CATEGORY_NUM, FEATURE_ID, SEQUENCE_NUMBER,
  GDF_EDGE_ID),

  CONSTRAINT PF_LINE_TOPO_PRIM_GDF_EDGE_EXISTS
  FOREIGN KEY(DLS, GDF_EDGE_ID)
  REFERENCES topology.ST_EDGE(DLS, GDF_EDGE_ID),

  CONSTRAINT PF_LINE_TOPO_PRIM_PF_LINE_FEATURE_EXISTS
  FOREIGN KEY(DLS, FEAT_CATEGORY_NUM, FEATURE_ID)
  REFERENCES PF_LINE_FEATURE (DLS, FEAT_CATEGORY_NUM, FEATURE_ID)
)
```

14.6.2.3.3 Non-Planar Connectivity Topology Line Features

14.6.2.3.3.1 Logical Model

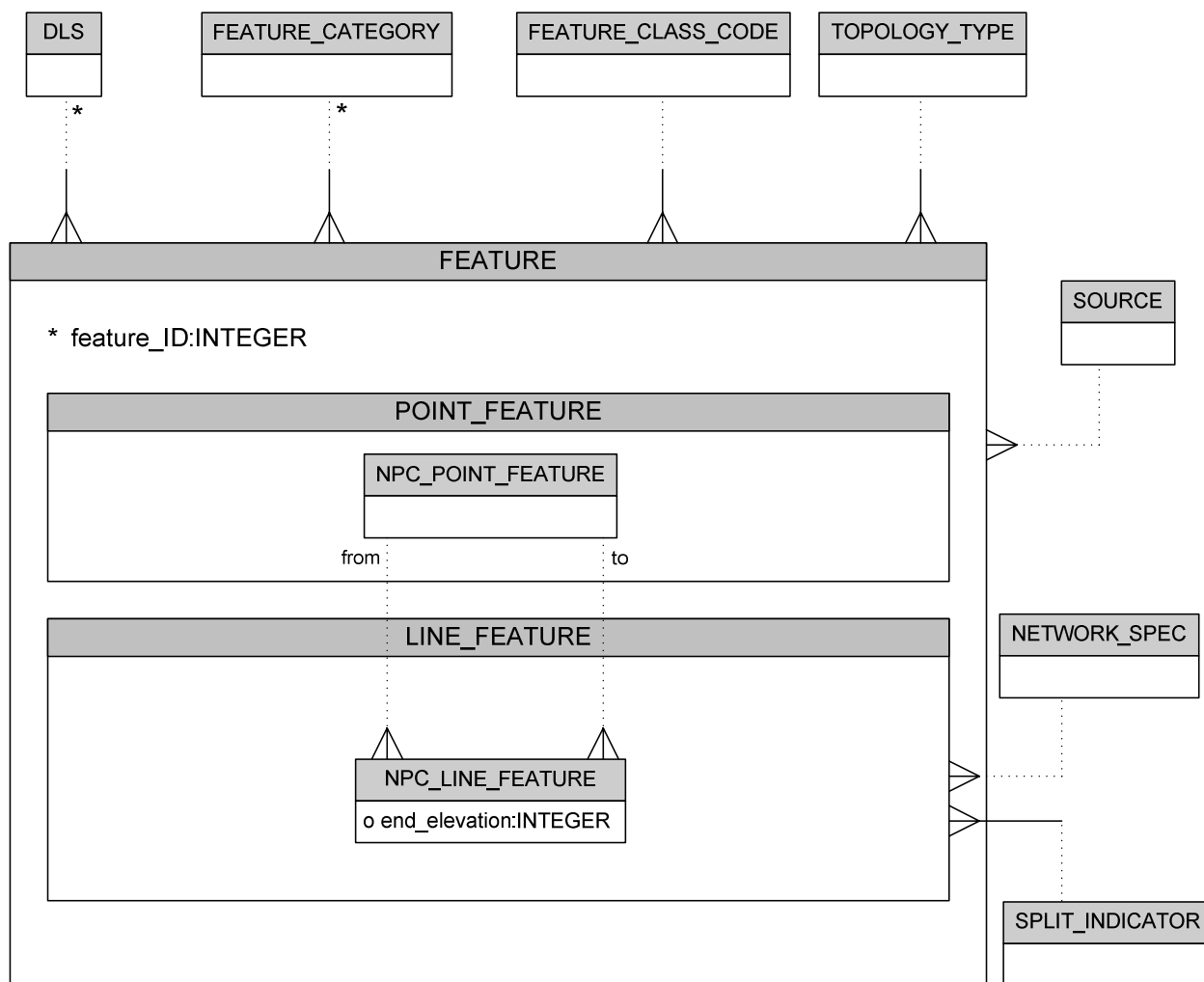

Non-planar connectivity Topology Type of Line Features can have a from and a to non-planar connectivity topology type Point Feature.

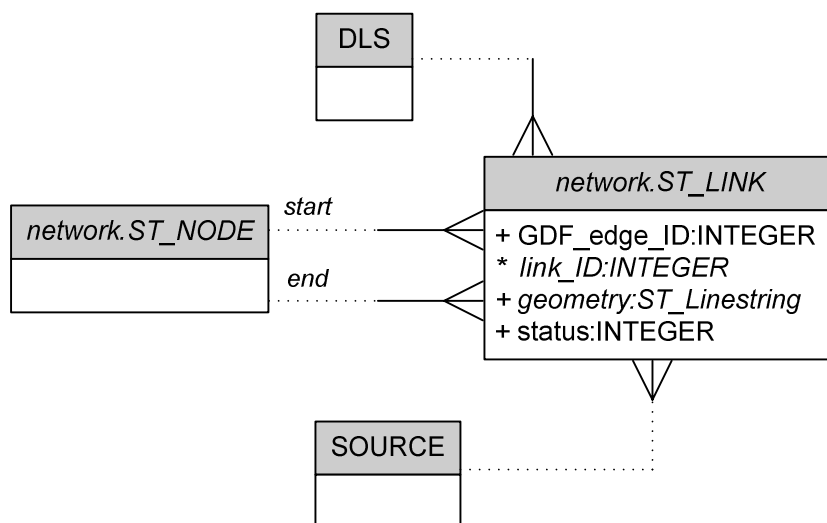

Using elements of ISO 13249-3, individual links are represented by *SQL/MM ST_Link*. *SQL/MM* provides link ID and geometry. Link ID is unique within a TopoNet “network”. Here “network” is the name of the SQL schema which owns the *ST_Nodes* and *ST_Links*. Links have optional geometry values (which GDF makes mandatory) to specify their geographic location and shape, expressed as an *SQL/MM ST_Curve* value. For compatibility with GDF, only the *ST_Curve ST_Linestring* subtype is applicable at this time. It is defined by a list of *ST_Points*, each of which contains two or three coordinate values. *SQL/MM* provides for start and end nodes, of type TopoNet *ST_Node*, and insures that the edge geometry starts at the start node geometry location and ends at the end node geometry location.

GDF extends *ST_Link* with a GDF-specific GDF Edge ID, unique within a Section. They can also include an integer source ID referencing Source (see 14.4.3.8). GDF also provides for a status code which, when applied to Edges, has the following values and meanings:

- 1 = (Not applicable)
- 2 = normal Edge
- 3 = Dataset border Edge
- 4 = (Not applicable)
- 5 = non-Section border Edge

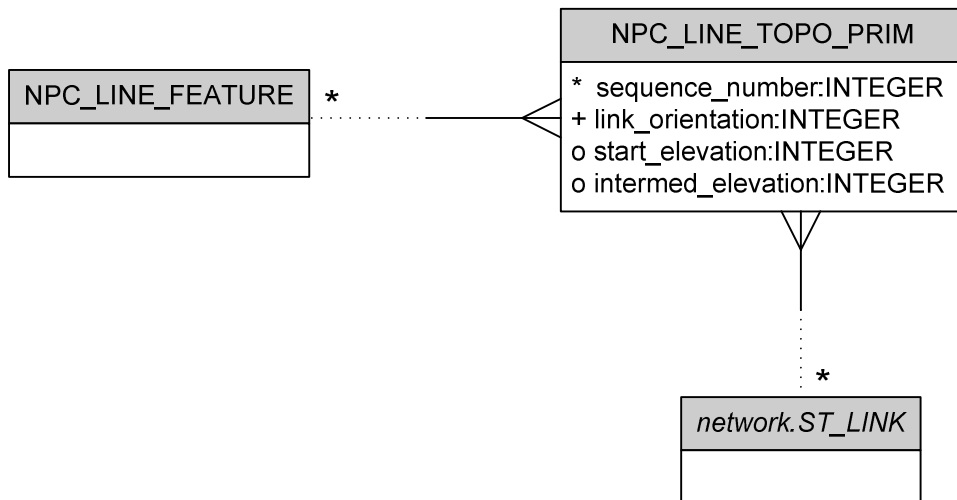

Each non-planar connectivity Topology Type of Line Feature may have a single topological representation. Using elements of ISO 13249-3, the topological representation is by a list of *SQL/MM defined links (ST_Link)*, ordered by sequence number. The link orientation indicates whether the Line Feature uses each Link in the direction it is defined, as dictated by its start and end Nodes.

14.6.2.3.3.2 Physical Model

```

CREATE TABLE NPC_LINE_FEATURE
(
  DLS INTEGER,
  FEAT_CATEGORY_NUM INTEGER,
  FEATURE_ID INTEGER,
  FEATURE_CLASS_CODE CHAR(4)
  CONSTRAINT NPC_LINE_FEATURE_FEATURE_CLASS_CODE_NOT_NULL
  NOT NULL,

```

```
SPLIT_INDICATOR INTEGER
    CONSTRAINT NPC_LINE_FEATURE_SPLIT_INDICATOR_NOT_NULL
    NOT NULL,
END_ELEVATION INTEGER,
SOURCE_ID INTEGER,
NETWORK_ID INTEGER,
FROM_FEAT_DLS INTEGER,
FROM_FEAT_CATEGORY INTEGER,
FROM_FEATURE_ID INTEGER,
TO_FEAT_DLS INTEGER,
TO_FEAT_CATEGORY INTEGER,
TO_FEATURE_ID INTEGER,

CONSTRAINT NPC_LINE_FEATURE_PRIMARY_KEY
    PRIMARY KEY (DLS, FEAT_CATEGORY_NUM, FEATURE_ID),

CONSTRAINT NPC_LINE_FEATURE_DLS_EXISTS
    FOREIGN KEY(DLS)
    REFERENCES DLS(DLS),

CONSTRAINT NPC_LINE_FEATURE_FEATURE_CLASS_EXISTS
    FOREIGN KEY(FEATURE_CLASS_CODE)
    REFERENCES FEATURE_CLASS(FEATURE_CLASS_CODE),

CONSTRAINT NPC_LINE_FEATURE_SOURCE_EXISTS
    FOREIGN KEY(DLS.DATASET_ID, SOURCE_ID)
    REFERENCES SOURCE(DATASET_ID, SOURCE_ID),

CONSTRAINT NPC_LINE_NETWORK_ID_EXISTS
    FOREIGN KEY(DLS.DATASET_ID, NETWORK_ID)
    REFERENCES NETWORK_SPEC(DATASET_ID, NETWORK_ID),

CONSTRAINT NPC_LINE_FEATURE_IS_LINEAR
    CHECK (FEAT_CATEGORY_NUM = 2),

CONSTRAINT NPC_LINE_FROM_FEATURE_EXISTS
    FOREIGN KEY(FROM_FEAT_DLS, FROM_FEAT_CATEGORY, FROM_FEATURE_ID),
    REFERENCES NPC_POINT_FEATURE (DLS, FEAT_CATEGORY_NUM, FEATURE_ID),

CONSTRAINT NPC_LINE_TO_FEATURE_EXISTS
    FOREIGN KEY(TO_FEAT_DLS, TO_FEAT_CATEGORY, TO_FEATURE_ID),
    REFERENCES NPC_POINT_FEATURE (DLS, FEAT_CATEGORY_NUM, FEATURE_ID)
)

ALTER TABLE network.ST_EDGE
    ADD COLUMN DLS INTEGER

ALTER TABLE network.ST_EDGE
    ADD COLUMN GDF_EDGE_ID INTEGER

ALTER TABLE network.ST_EDGE
    ADD COLUMN STATUS INTEGER

ALTER TABLE network.ST_EDGE
    ADD COLUMN SOURCE_ID INTEGER

ALTER TABLE network.ST_EDGE
    ADD CONSTRAINT NPC_EDGE_DLS_EXISTS
    FOREIGN KEY(DLS)
    REFERENCES DLS(DLS)
```

```
ALTER TABLE network.ST_EDGE
  ADD CONSTRAINT NPC_EDGE_SOURCE_EXISTS
  FOREIGN KEY(DLS.DATASET_ID, SOURCE_ID)
  REFERENCES SOURCE(DATASET_ID, SOURCE_ID)
```

```
ALTER TABLE network.ST_EDGE
  ADD CONSTRAINT NPC_EDGE_UNIQUE_GDF_EDGE_ID
  UNIQUE (DLS, GDF_EDGE_ID)
```

NOTE Relationship to ST_NODE already covered by SQL/MM.

```
CREATE TABLE NPC_LINE_TOPO_PRIM
(
  DLS INTEGER,
  FEAT_CATEGORY_NUM INTEGER,
  FEATURE_ID INTEGER,
  SEQUENCE_NUMBER INTEGER,
  GDF_EDGE_ID INTEGER,
  LINK_ORIENTATION INTEGER
  CONSTRAINT PF_LINE_TOPO_PRIM_EDGE_ORIENTATION_NOT_NULL
  NOT NULL,
  START_ELEVATION INTEGER,
  INTERMED_ELEVATION INTEGER,

  CONSTRAINT NPC_LINE_TOPO_PRIM_PRIMARY_KEY
  PRIMARY KEY (DLS, FEAT_CATEGORY_NUM, FEATURE_ID, SEQUENCE_NUMBER,
  GDF_EDGE_ID),

  CONSTRAINT NPC_LINE_TOPO_PRIM_GDF_EDGE_EXISTS
  FOREIGN KEY(DLS, GDF_EDGE_ID)
  REFERENCES network.ST_LINK(DLS, GDF_EDGE_ID),

  CONSTRAINT NPC_LINE_TOPO_PRIM_NPC_LINE_FEATURE_EXISTS
  FOREIGN KEY(DLS, FEAT_CATEGORY_NUM, FEATURE_ID)
  REFERENCES NPC_LINE_FEATURE (DLS, FEAT_CATEGORY_NUM, FEATURE_ID)
)
```

14.6.2.3.4 Non-Explicit Topology Line Features

14.6.2.3.4.1 Logical Model

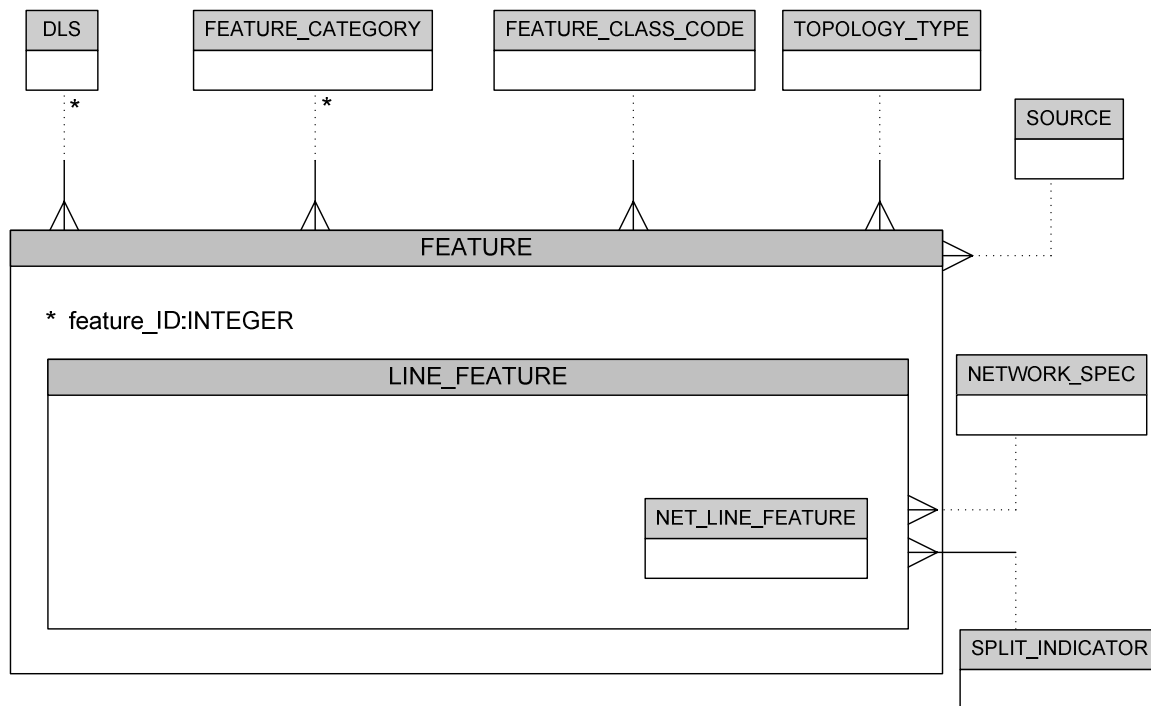

For Non-Explicit Topology Line Features, topology is not expressed with topological primitives, but instead can be derived from its NET Polyline geometry.

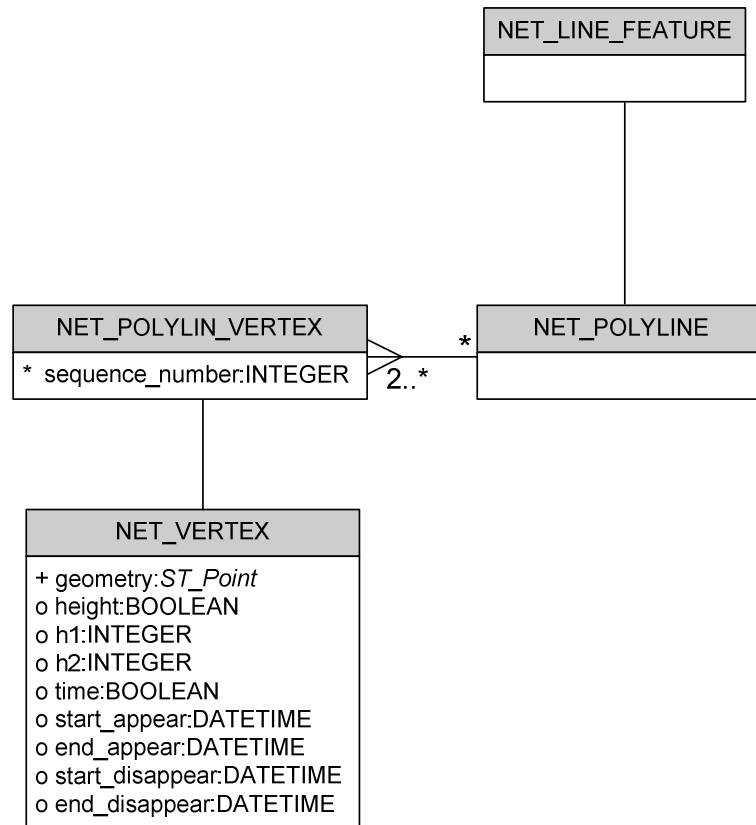

14.6.2.3.4.2 Physical Model

```

CREATE TABLE NET_LINE_FEATURE
(
  DLS INTEGER,
  FEAT_CATEGORY_NUM INTEGER,
  FEATURE_ID INTEGER,
  FEATURE_CLASS_CODE CHAR(4)
  CONSTRAINT NET_LINE_FEATURE_FEATURE_CLASS_CODE_NOT_NULL
  NOT NULL,
  SPLIT_INDICATOR INTEGER
  CONSTRAINT NET_LINE_FEATURE_SPLIT_INDICATOR_NOT_NULL
  NOT NULL,
  SOURCE_ID INTEGER,
  NETWORK_ID INTEGER,

  CONSTRAINT NET_LINE_FEATURE_PRIMARY_KEY
  PRIMARY KEY (DLS, FEAT_CATEGORY_NUM, FEATURE_ID),

  CONSTRAINT NET_LINE_FEATURE_DLS_EXISTS
  FOREIGN KEY(DLS)
  REFERENCES DLS(DLS),

  CONSTRAINT NET_LINE_FEATURE_FEATURE_CLASS_EXISTS
  FOREIGN KEY(FEATURE_CLASS_CODE)
  REFERENCES FEATURE_CLASS(FEATURE_CLASS_CODE),

  CONSTRAINT NET_LINE_FEATURE_SOURCE_EXISTS
  FOREIGN KEY(DLS.DATASET_ID, SOURCE_ID)
  REFERENCES SOURCE(DATASET_ID, SOURCE_ID),

  CONSTRAINT NET_LINE_NETWORK_ID_EXISTS
  
```

```
FOREIGN KEY(DLS.DATASET_ID, NETWORK_ID)  
REFERENCES NETWORK_SPEC(DATASET_ID, NETWORK_ID),
```

```
CONSTRAINT NET_LINE_FEATURE_IS_LINEAR  
CHECK (FEAT_CATEGORY_NUM = 2)  
)
```

```
CREATE TABLE NET_POLYLIN_VERTEX
```

```
(  
DLS INTEGER,  
FEAT_CATEGORY_NUM INTEGER,  
FEATURE_ID INTEGER,  
SEQUENCE_NUMBER INTEGER,  
GEOMETRY ST_POINT  
CONSTRAINT NET_POLYLIN_VERTEX_GEOMETRY_NOT_NULL  
NOT NULL,  
HEIGHT BOOLEAN,  
H1 INTEGER,  
H2 INTEGER,  
TIME BOOLEAN,  
START_APPEAR DATETIME,  
END_APPEAR DATETIME,  
START_DISAPPEAR DATETIME,  
END_DISAPPEAR DATETIME,
```

```
CONSTRAINT NET_POLYLIN_VERTEX_PRIMARY_KEY  
PRIMARY KEY (DLS, FEAT_CATEGORY_NUM, FEATURE_ID, SEQUENCE_NUMBER),
```

```
CONSTRAINT NET_POLYLIN_VERTEX_NET_LINE_FEATURE_EXISTS  
FOREIGN KEY(DLS, FEAT_CATEGORY_NUM, FEATURE_ID)  
REFERENCES NET_LINE_FEATURE(DLS, FEAT_CATEGORY_NUM, FEATURE_ID),
```

```
CONSTRAINT NET_POLYLIN_VERTEX_HEIGHT_CONSTRAINT  
CHECK (((HEIGHT IS NULL OR HEIGHT IS FALSE) AND H1 IS NULL AND H2 IS NULL)  
OR  
(HEIGHT IS TRUE AND H1 IS NOT NULL)  
)
```

```
CONSTRAINT NET_POLYLIN_VERTEX_TIME_CONSTRAINT  
CHECK (((TIME IS NULL OR TIME IS FALSE) AND START_APPEAR IS NULL AND END_APPEAR  
IS NULL AND START_DISAPPEAR IS NULL AND END_DISAPPEAR IS NULL)  
OR  
(TIME IS TRUE)  
)  
)
```

14.6.2.4 Area Features

14.6.2.4.1 Overview

All Area Features have a Feature Category number equal to 3. As with Point and Line Features, the topological representation further distinguishes each Area Feature type: planar full, non-planar connectivity, and non-explicit Topology Types of Area Features. As with Line Features, all Area Features have a mandatory split indicator to specify whether they cross Section boundaries.

14.6.2.4.2 Planar Full Topology Area Features

14.6.2.4.2.1 Logical Model

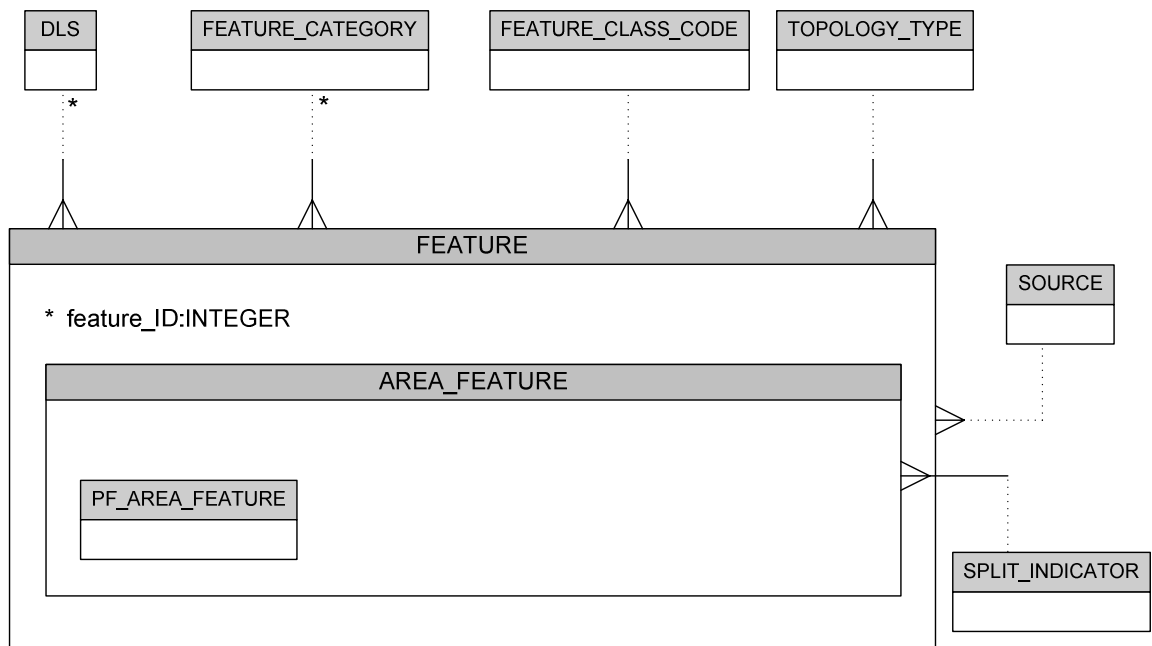

GDF extends *ST_Face* with a GDF-specific GDF Face ID, unique within a Section. They have a mandatory Boolean extended area geometry information flag and optional geometrical type, slope, aspect, and light (shading) value attributes. They can also include an integer source ID referencing Source (see 14.4.3.8).

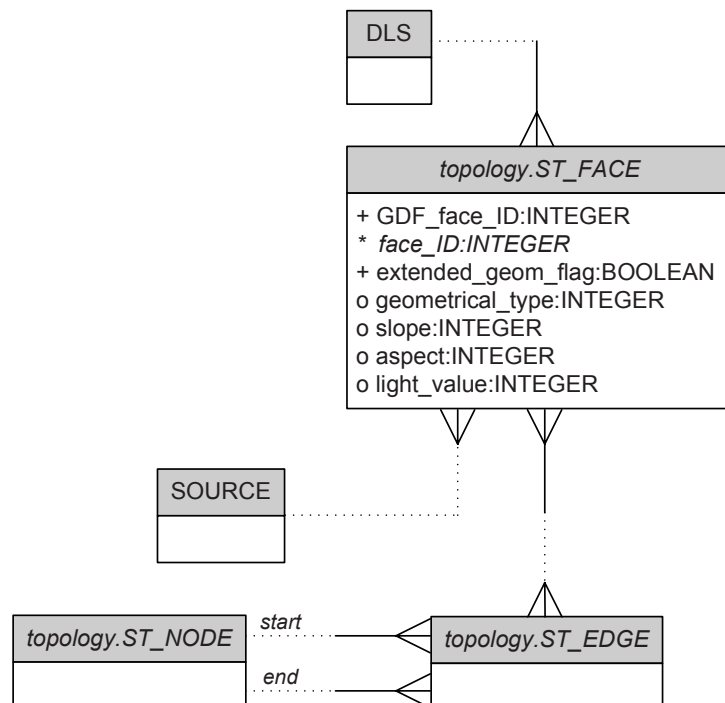

Each planar full Topology Type of Area Feature can have a single topological representation. Using elements of ISO 13249-3, the topological representation is by a set of *SQL/MM defined faces (ST_FACE)*. Faces do not have their own geometry values but the geometry can be constructed from the geometry of their contributing

edges. Here “topology” is the name of the SQL schema which owns the *ST_Nodes*, *ST_Edges*, and *ST_Faces*.

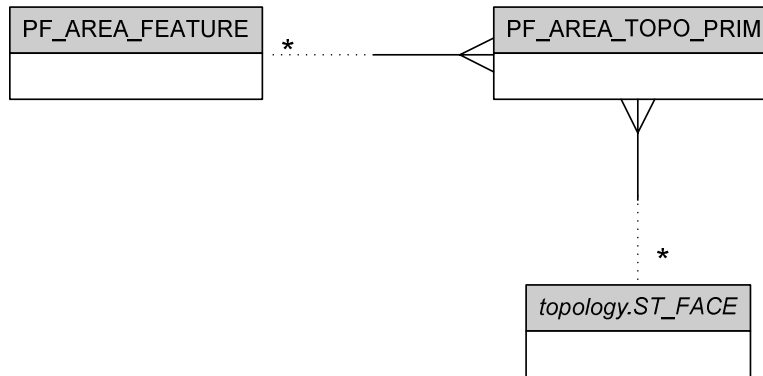

14.6.2.4.2.2 Physical Model

```

CREATE TABLE PF_AREA_FEATURE
(
    DLS INTEGER,
    FEAT_CATEGORY_NUM INTEGER,
    FEATURE_ID INTEGER,
    FEATURE_CLASS_CODE CHAR(4)
    CONSTRAINT PF_AREA_FEATURE_FEATURE_CLASS_CODE_NOT_NULL
    NOT NULL,
    SPLIT_INDICATOR INTEGER
    CONSTRAINT PF_AREA_FEATURE_SPLIT_INDICATOR_NOT_NULL
    NOT NULL,
    SOURCE_ID INTEGER,
    CONSTRAINT PF_AREA_FEATURE_PRIMARY_KEY
    PRIMARY KEY (DLS, FEAT_CATEGORY_NUM, FEATURE_ID),

    CONSTRAINT PF_AREA_FEATURE_DLS_EXISTS
    FOREIGN KEY(DLS)
    REFERENCES DLS(DLS),

    CONSTRAINT PF_AREA_FEATURE_FEATURE_CLASS_EXISTS
    FOREIGN KEY(FEATURE_CLASS_CODE),
    REFERENCES FEATURE_CLASS(FEATURE_CLASS_CODE),

    CONSTRAINT PF_AREA_FEATURE_SOURCE_EXISTS
    FOREIGN KEY(DLS.DATASET_ID, SOURCE_ID)
    REFERENCES SOURCE(DATASET_ID, SOURCE_ID),

    CONSTRAINT PF_AREA_FEATURE_IS_AREA
    CHECK (FEAT_CATEGORY_NUM = 3)
)

ALTER TABLE topology.ST_FACE
ADD COLUMN DLS INTEGER

ALTER TABLE topology.ST_FACE
ADD COLUMN GDF_FACE_ID INTEGER

ALTER TABLE topology.ST_FACE
ADD COLUMN EXTENDED_GEOM_FLAG BOOLEAN
CONSTRAINT PF_FACE_EXTENDED_GEOM_FLAG_NOT_NULL
NOT NULL
    
```

```
ALTER TABLE topology.ST_FACE
  ADD COLUMN GEOMETRICAL_TYPE INTEGER
```

```
ALTER TABLE topology.ST_FACE
  ADD COLUMN SLOPE INTEGER
```

```
ALTER TABLE topology.ST_FACE
  ADD COLUMN ASPECT INTEGER
```

```
ALTER TABLE topology.ST_FACE
  ADD COLUMN LIGHT_VALUE INTEGER
```

```
ALTER TABLE topology.ST_FACE
  ADD COLUMN SOURCE_ID INTEGER
```

```
ALTER TABLE topology.ST_FACE
  ADD CONSTRAINT PF_FACE_DLS_EXISTS
  FOREIGN KEY(DLS)
  REFERENCES DLS(DLS)
```

```
ALTER TABLE topology.ST_FACE
  ADD CONSTRAINT PF_FACE_SOURCE_EXISTS
  FOREIGN KEY(DLS.DATASET_ID, SOURCE_ID)
  REFERENCES SOURCE(DATASET_ID, SOURCE_ID)
```

```
ALTER TABLE topology.ST_FACE
  ADD CONSTRAINT PF_FACE_UNIQUE_GDF_FACE_ID
  UNIQUE (DLS, GDF_FACE_ID)
```

NOTE Relationship to ST_EDGE and ST_NODE already covered by SQL/MM.

```
CREATE TABLE PF_AREA_TOPO_PRIM
(
  DLS INTEGER,
  FEAT_CATEGORY_NUM INTEGER,
  FEATURE_ID INTEGER,
  GDF_FACE_ID INTEGER,

  CONSTRAINT PF_AREA_TOPO_PRIM_PRIMARY_KEY
  PRIMARY KEY (DLS, FEAT_CATEGORY_NUM, FEATURE_ID, GDF_FACE_ID),

  CONSTRAINT PF_AREA_TOPO_PRIM_GDF_FACE_EXISTS
  FOREIGN KEY(DLS, GDF_FACE_ID)
  REFERENCES topology.ST_FACE(DLS, GDF_FACE_ID),

  CONSTRAINT PF_AREA_TOPO_PRIM_PF_AREA_FEATURE_EXISTS
  FOREIGN KEY(DLS, FEAT_CATEGORY_NUM, FEATURE_ID)
  REFERENCES PF_AREA_FEATURE (DLS, FEAT_CATEGORY_NUM, FEATURE_ID)
)
```

14.6.2.4.3 Non-Planar Connectivity Topology Area Features

14.6.2.4.3.1 Logical Model

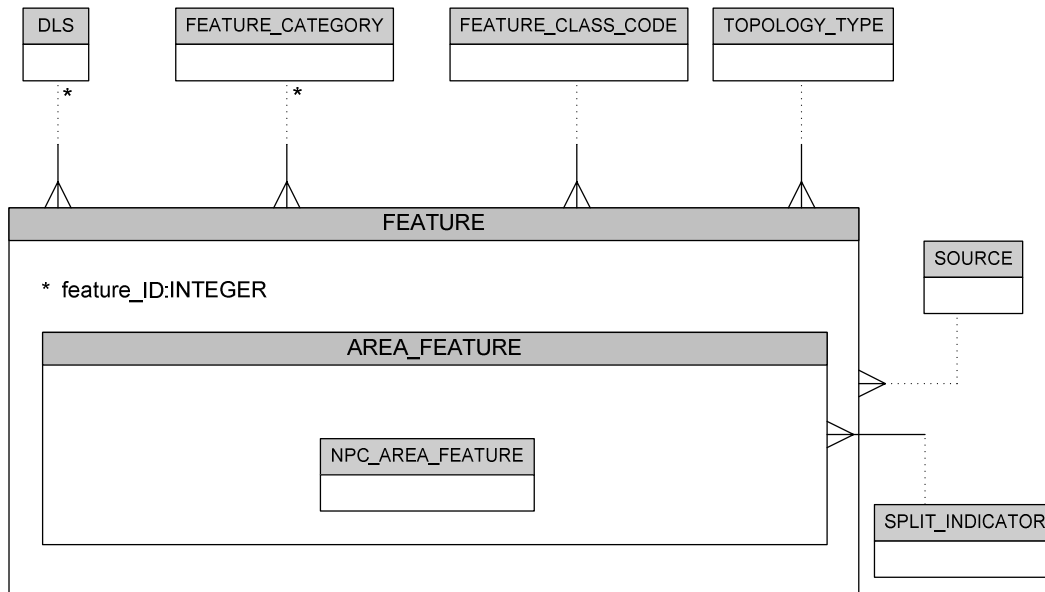

Each non-planar connectivity Topology Type of Area Feature may have a single topological representation. Using elements of ISO 13249-3, the topological representation is by a list of *SQL/MM defined links (ST_LINK)*, ordered by sequence number. *Links have geometry values to specify their geographic location and shape, expressed as an SQL/MM ST_Linestring value which contains two or more points each with two or three coordinate values. Here “network” is the name of the SQL schema which owns the ST_Nodes and ST_Links.*

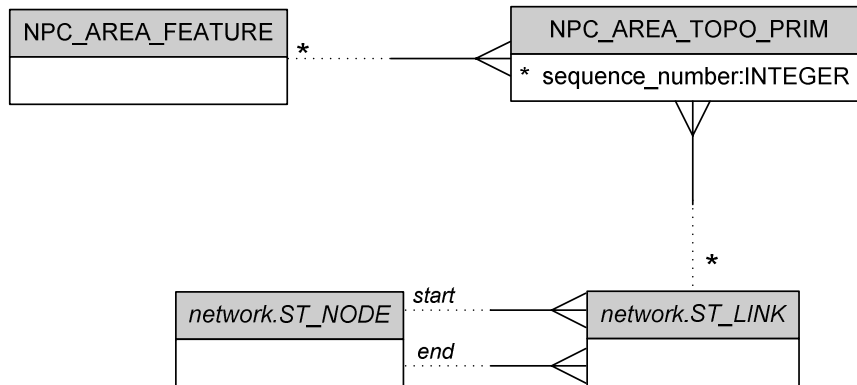

14.6.2.4.3.2 Physical Model

```

CREATE TABLE NPC_AREA_FEATURE
(
  DLS INTEGER,
  FEAT_CATEGORY_NUM INTEGER,
  FEATURE_ID INTEGER,
  FEATURE_CLASS_CODE CHAR(4)
  CONSTRAINT NPC_AREA_FEATURE_FEATURE_CLASS_CODE_NOT_NULL
  NOT NULL,
  SPLIT_INDICATOR INTEGER
  CONSTRAINT NPC_AREA_FEATURE_SPLIT_INDICATOR_NOT_NULL
  NOT NULL,

```

```
SOURCE_ID INTEGER,  
  
CONSTRAINT NPC_AREA_FEATURE_PRIMARY_KEY  
    PRIMARY KEY (DLS, FEAT_CATEGORY_NUM, FEATURE_ID),  
  
CONSTRAINT NPC_AREA_FEATURE_DLS_EXISTS  
    FOREIGN KEY(DLS)  
    REFERENCES DLS(DLS),  
  
CONSTRAINT NPC_AREA_FEATURE_FEATURE_CLASS_EXISTS  
    FOREIGN KEY(FEATURE_CLASS_CODE)  
    REFERENCES FEATURE_CLASS(FEATURE_CLASS_CODE),  
  
CONSTRAINT NPC_AREA_FEATURE_SOURCE_EXISTS  
    FOREIGN KEY(DLS.DATASET_ID, SOURCE_ID)  
    REFERENCES SOURCE(DATASET_ID, SOURCE_ID),  
  
CONSTRAINT NPC_AREA_FEATURE_IS_AREA  
    CHECK (FEAT_CATEGORY_NUM = 3),  
)  
  
CREATE TABLE NPC_AREA_TOPO_PRIM  
(  
    DLS INTEGER,  
    FEAT_CATEGORY_NUM INTEGER,  
    FEATURE_ID INTEGER,  
    SEQUENCE_NUMBER INTEGER,  
    GDF_EDGE_ID INTEGER,  
  
    CONSTRAINT NPC_AREA_TOPO_PRIM_PRIMARY_KEY  
        PRIMARY KEY (DLS, FEAT_CATEGORY_NUM, FEATURE_ID, SEQUENCE_NUMBER,  
            GDF_EDGE_ID),  
  
    CONSTRAINT NPC_AREA_TOPO_PRIM_GDF_EDGE_EXISTS  
        FOREIGN KEY(DLS, GDF_EDGE_ID)  
        REFERENCES network.ST_LINK(DLS, GDF_EDGE_ID),  
  
    CONSTRAINT NPC_AREA_TOPO_PRIM_NPC_AREA_FEATURE_EXISTS  
        FOREIGN KEY(DLS, FEAT_CATEGORY_NUM, FEATURE_ID)  
        REFERENCES NPC_AREA_FEATURE (DLS, FEAT_CATEGORY_NUM, FEATURE_ID)  
)
```

14.6.2.4.4 Non-Explicit Topology Area Features

14.6.2.4.4.1 Logical Model

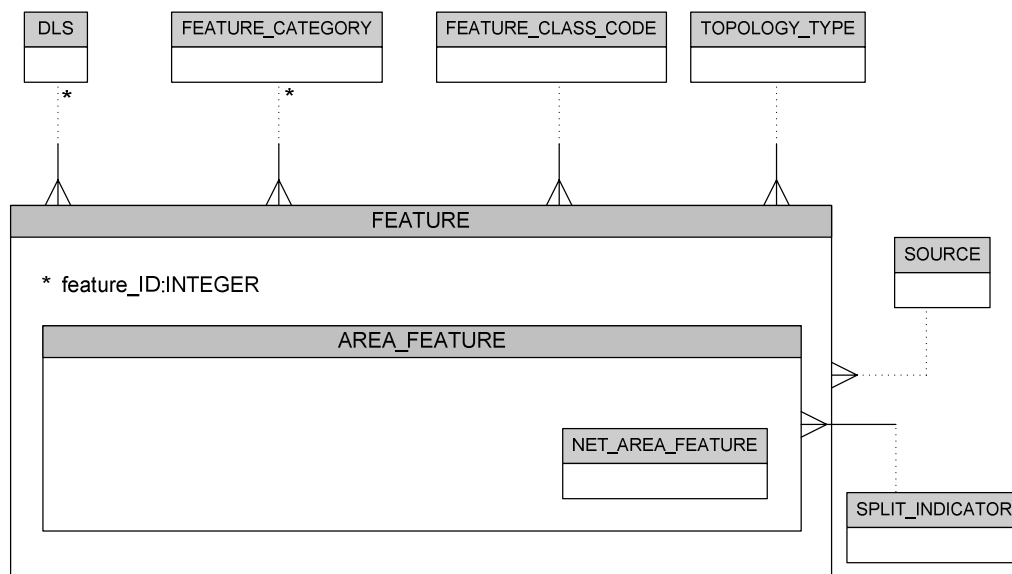

For Non-Explicit Topology Area Features, topology is not expressed with topological primitives, but instead can be derived from its NET Polygon geometry.

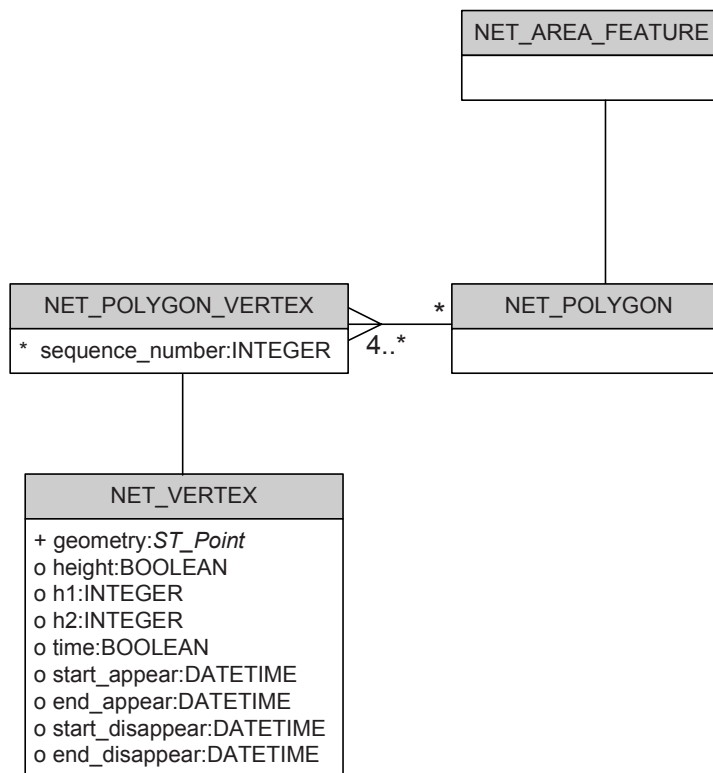

14.6.2.4.4.2 Physical Model

```

CREATE TABLE NET_AREA_FEATURE
(
  DLS INTEGER,
  FEAT_CATEGORY_NUM INTEGER,

```

```

FEATURE_ID INTEGER,
FEATURE_CLASS_CODE CHAR(4)
    CONSTRAINT NET_AREA_FEATURE_FEATURE_CLASS_CODE_NOT_NULL
        NOT NULL,
SPLIT_INDICATOR INTEGER
    CONSTRAINT NET_AREA_FEATURE_SPLIT_INDICATOR_NOT_NULL
        NOT NULL,
SOURCE_ID INTEGER,

CONSTRAINT NET_AREA_FEATURE_PRIMARY_KEY
    PRIMARY KEY (DLS, FEAT_CATEGORY_NUM, FEATURE_ID),

CONSTRAINT NET_AREA_FEATURE_DLS_EXISTS
    FOREIGN KEY(DLS)
        REFERENCES DLS(DLS),

CONSTRAINT NET_AREA_FEATURE_FEATURE_CLASS_EXISTS
    FOREIGN KEY(FEATURE_CLASS_CODE)
        REFERENCES FEATURE_CLASS(FEATURE_CLASS_CODE),

CONSTRAINT NET_AREA_FEATURE_SOURCE_EXISTS
    FOREIGN KEY(DLS.DATASET_ID, SOURCE_ID)
        REFERENCES SOURCE(DATASET_ID, SOURCE_ID),

CONSTRAINT NET_AREA_FEATURE_IS_AREA
    CHECK (FEAT_CATEGORY_NUM = 3)
)

CREATE TABLE NET_POLYGON_VERTEX
(
DLS INTEGER,
FEAT_CATEGORY_NUM INTEGER,
FEATURE_ID INTEGER,
SEQUENCE_NUMBER INTEGER,
GEOMETRY ST_POINT
    CONSTRAINT NET_POLYGON_VERTEX_GEOMETRY_NOT_NULL
        NOT NULL,
HEIGHT BOOLEAN,
H1 INTEGER,
H2 INTEGER,
TIME BOOLEAN,
START_APPEAR DATETIME,
END_APPEAR DATETIME,
START_DISAPPEAR DATETIME,
END_DISAPPEAR DATETIME,

CONSTRAINT NET_POLYGON_VERTEX_PRIMARY_KEY
    PRIMARY KEY (DLS, FEAT_CATEGORY_NUM, FEATURE_ID, SEQUENCE_NUMBER),

CONSTRAINT NET_POLYGON_VERTEX_NET_AREA_FEATURE_EXISTS
    FOREIGN KEY(DLS, FEAT_CATEGORY_NUM, FEATURE_ID)
        REFERENCES NET_AREA_FEATURE(DLS, FEAT_CATEGORY_NUM, FEATURE_ID),

CONSTRAINT NET_POLYGON_VERTEX_HEIGHT_CONSTRAINT
    CHECK (((HEIGHT IS NULL OR HEIGHT IS FALSE) AND H1 IS NULL AND H2 IS NULL)
        OR
        (HEIGHT IS TRUE AND H1 IS NOT NULL)
    ),

CONSTRAINT NET_POLYGON_VERTEX_TIME_CONSTRAINT

```

```

CHECK (((TIME IS NULL OR TIME IS FALSE) AND START_APPEAR IS NULL AND END_APPEAR
IS NULL AND START_DISAPPEAR IS NULL AND END_DISAPPEAR IS NULL)
OR
(TIME IS TRUE)
)
)

```

14.6.3 Complex Features

14.6.3.1 Overview

All Complex Features have a Feature Category number equal to 4. As with Simple Features, the topological representation further distinguishes each Complex Feature type: planar full, non-planar connectivity, and non-explicit Topology Types of Complex Features. Complex Features can be made up of simple (Point, Line, and Area) Features as well as other Complex Features but these included Features must be of the same Topology Type as the owning complex type. The Features which comprise a Complex Feature are distinguished by a feature number. Complex Features have a mandatory complex split indicator with values of 0 (single Section) and 1 (split across multiple Sections) as for Line Features and Area Features but can also have a value of 2 to indicate that the Complex Feature is repeated in different Sections.

The Features which comprise a Complex Feature must be from the same Section and Layer as the Complex Feature.

14.6.3.2 Planar Full Topology Complex Features

14.6.3.2.1 Logical Model

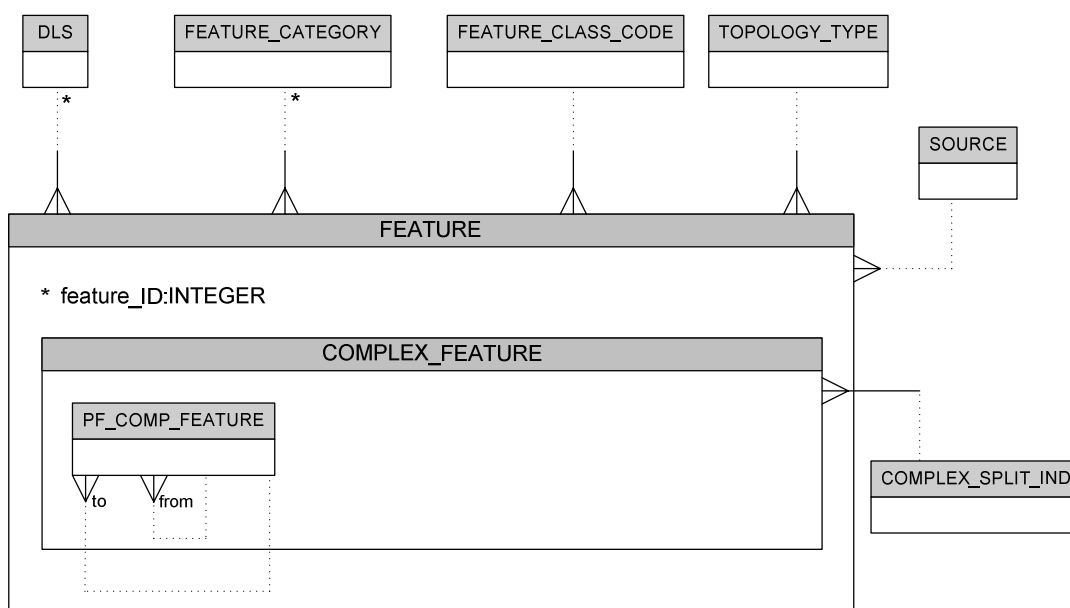

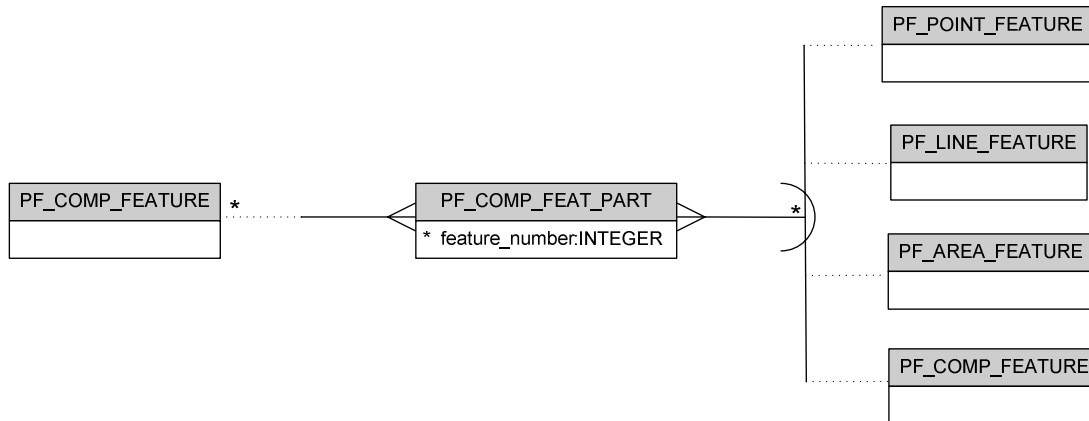

14.6.3.2.2 Physical Model

```

CREATE TABLE PF_COMP_FEATURE
(
  DLS INTEGER,
  FEAT_CATEGORY_NUM INTEGER,
  FEATURE_ID INTEGER,
  FEATURE_CLASS_CODE CHAR(4)
  CONSTRAINT PF_COMP_FEATURE_FEATURE_CLASS_CODE_NOT_NULL
  NOT NULL,
  COMPLEX_SPLIT_INDICATOR INTEGER
  CONSTRAINT PF_COMP_FEATURE_COMPLEX_SPLIT_IND_NOT_NULL
  NOT NULL,
  SOURCE_ID INTEGER,
  FROM_FEAT_DLS INTEGER,
  FROM_FEAT_CATEGORY INTEGER,
  FROM_FEATURE_ID INTEGER,
  TO_FEAT_DLS INTEGER,
  TO_FEAT_CATEGORY INTEGER,
  TO_FEATURE_ID INTEGER,

  CONSTRAINT PF_COMP_FEATURE_PRIMARY_KEY
  PRIMARY KEY (DLS, FEAT_CATEGORY_NUM, FEATURE_ID),

  CONSTRAINT PF_COMP_FEATURE_DLS_EXISTS
  FOREIGN KEY(DLS)
  REFERENCES DLS(DLS),

  CONSTRAINT PF_COMP_FEATURE_FEATURE_CLASS_EXISTS
  FOREIGN KEY(FEATURE_CLASS_CODE),
  REFERENCES FEATURE_CLASS(FEATURE_CLASS_CODE),

  CONSTRAINT PF_COMP_FEATURE_SOURCE_EXISTS
  FOREIGN KEY(DLS.DATASET_ID, SOURCE_ID)
  REFERENCES SOURCE(DATASET_ID, SOURCE_ID),

  CONSTRAINT PF_COMP_FEATURE_IS_COMPLEX
  CHECK (FEAT_CATEGORY_NUM = 4),

  CONSTRAINT PF_COMP_FROM_FEATURE_EXISTS
  FOREIGN KEY(FROM_FEAT_DLS, FROM_FEAT_CATEGORY, FROM_FEATURE_ID),
  REFERENCES PF_COMP_FEATURE (DLS, FEAT_CATEGORY_NUM, FEATURE_ID),

```

```

CONSTRAINT PF_COMP_TO_FEATURE_EXISTS
  FOREIGN KEY(TO_FEAT_DLS, TO_FEAT_CATEGORY, TO_FEATURE_ID),
  REFERENCES PF_COMP_FEATURE (DLS, FEAT_CATEGORY_NUM, FEATURE_ID)
)

```

```

CREATE TABLE PF_COMP_FEAT_PART

```

```

(
  DLS INTEGER,
  COMP_FEAT_CATEGORY INTEGER,
  COMP_FEATURE_ID INTEGER,
  FEATURE_NUMBER INTEGER,
  FEAT_CATEGORY_NUM INTEGER,
  FEATURE_ID INTEGER,

```

```

CONSTRAINT PF_COMP_FEAT_PART_PRIMARY_KEY
  PRIMARY KEY (DLS, COMP_FEAT_CATEGORY, COMP_FEATURE_ID,
  FEATURE_NUMBER),

```

```

CONSTRAINT PF_COMP_FEAT_PART_PART_EXISTS
  CHECK (DLS, FEAT_CATEGORY_NUM, FEATURE_ID IN
  (
    SELECT DLS, FEAT_CATEGORY_NUM, FEATURE_ID
      FROM PF_POINT_FEATURE
    UNION
    SELECT DLS, FEAT_CATEGORY_NUM, FEATURE_ID
      FROM PF_LINE_FEATURE
    UNION
    SELECT DLS, FEAT_CATEGORY_NUM, FEATURE_ID
      FROM PF_AREA_FEATURE
    UNION
    SELECT DLS, FEAT_CATEGORY_NUM, FEATURE_ID
      FROM PF_COMP_FEATURE
  )
)
)
)
)

```

14.6.3.3 Non-Planar Connectivity Topology Complex Features

14.6.3.3.1 Logical Model

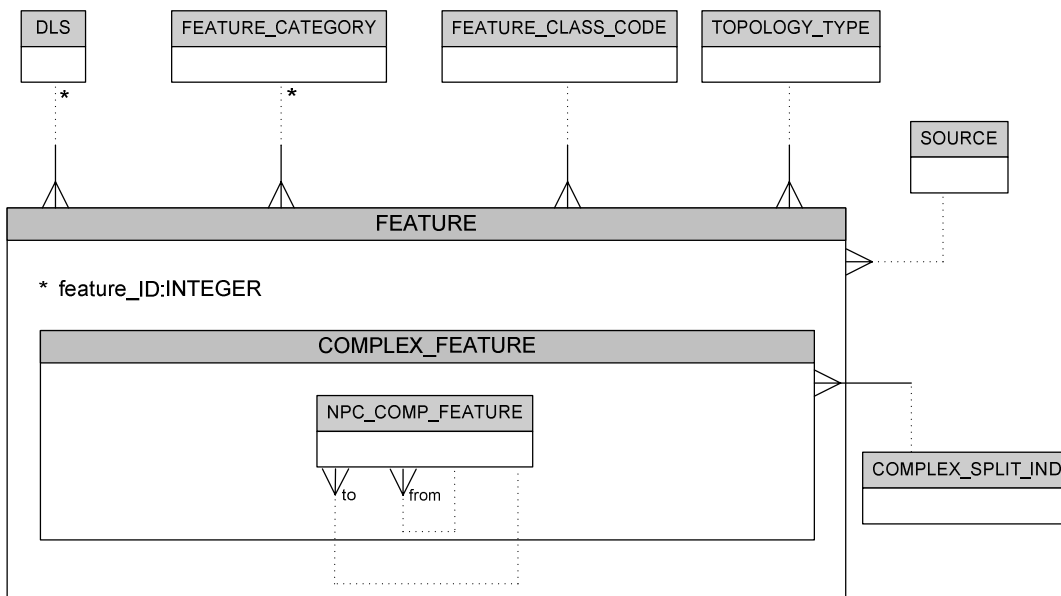

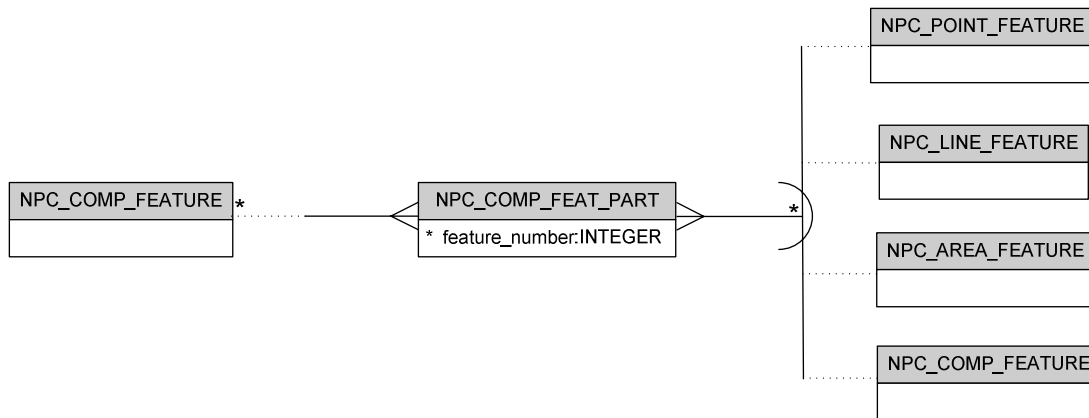

14.6.3.3.2 Physical Model

```

CREATE TABLE NPC_COMP_FEATURE
(
  DLS INTEGER,
  FEAT_CATEGORY_NUM INTEGER,
  FEATURE_ID INTEGER,
  FEATURE_CLASS_CODE CHAR(4)
  CONSTRAINT NPC_COMP_FEATURE_FEATURE_CLASS_CODE_NOT_NULL
  NOT NULL,
  COMPLEX_SPLIT_INDICATOR INTEGER
  CONSTRAINT NPC_COMP_FEATURE_COMPLEX_SPLIT_IND_NOT_NULL
  NOT NULL,
  SOURCE_ID INTEGER,
  FROM_FEAT_DLS INTEGER,
  FROM_FEAT_CATEGORY INTEGER,
  FROM_FEATURE_ID INTEGER,
  TO_FEAT_DLS INTEGER,
  TO_FEAT_CATEGORY INTEGER,
  TO_FEATURE_ID INTEGER,

  CONSTRAINT NPC_COMP_FEATURE_PRIMARY_KEY
  PRIMARY KEY (DLS, FEAT_CATEGORY_NUM, FEATURE_ID),

  CONSTRAINT NPC_COMP_FEATURE_DLS_EXISTS
  FOREIGN KEY(DLS)
  REFERENCES DLS(DLS),

  CONSTRAINT NPC_COMP_FEATURE_FEATURE_CLASS_EXISTS
  FOREIGN KEY(FEATURE_CLASS_CODE),
  REFERENCES FEATURE_CLASS(FEATURE_CLASS_CODE),

  CONSTRAINT NPC_COMP_FEATURE_SOURCE_EXISTS
  FOREIGN KEY(DLS.DATASET_ID, SOURCE_ID)
  REFERENCES SOURCE(DATASET_ID, SOURCE_ID),

  CONSTRAINT NPC_COMP_FEATURE_IS_COMPLEX
  CHECK (FEAT_CATEGORY_NUM = 4),

  CONSTRAINT NPC_COMP_FROM_FEATURE_EXISTS
  FOREIGN KEY(FROM_FEAT_DLS, FROM_FEAT_CATEGORY, FROM_FEATURE_ID),

```

```
REFERENCES NPC_COMP_FEATURE (DLS, FEAT_CATEGORY_NUM, FEATURE_ID),  
  
CONSTRAINT NPC_COMP_TO_FEATURE_EXISTS  
FOREIGN KEY(TO_FEAT_DLS, TO_FEAT_CATEGORY, TO_FEATURE_ID),  
REFERENCES NPC_COMP_FEATURE (DLS, FEAT_CATEGORY_NUM, FEATURE_ID)  
)
```

```
CREATE TABLE NPC_COMP_FEAT_PART
```

```
(  
DLS INTEGER,  
COMP_FEAT_CATEGORY INTEGER,  
COMP_FEATURE_ID INTEGER,  
FEATURE_NUMBER INTEGER,  
FEAT_CATEGORY_NUM INTEGER,  
FEATURE_ID INTEGER,
```

```
CONSTRAINT NPC_COMP_FEAT_PART_PRIMARY_KEY  
PRIMARY KEY (DLS, COMP_FEAT_CATEGORY, COMP_FEATURE_ID,  
FEATURE_NUMBER),
```

```
CONSTRAINT NPC_COMP_FEAT_PART_PART_EXISTS  
CHECK (DLS, FEAT_CATEGORY_NUM, FEATURE_ID IN  
(  
SELECT DLS, FEAT_CATEGORY_NUM, FEATURE_ID  
FROM NPC_POINT_FEATURE  
UNION  
SELECT DLS, FEAT_CATEGORY_NUM, FEATURE_ID  
FROM NPC_LINE_FEATURE  
UNION  
SELECT DLS, FEAT_CATEGORY_NUM, FEATURE_ID  
FROM NPC_AREA_FEATURE  
UNION  
SELECT DLS, FEAT_CATEGORY_NUM, FEATURE_ID  
FROM NPC_COMP_FEATURE  
)
```

```
)  
)  
)
```

14.6.3.4 Non-Explicit Topology Complex Features

14.6.3.4.1 Logical Model

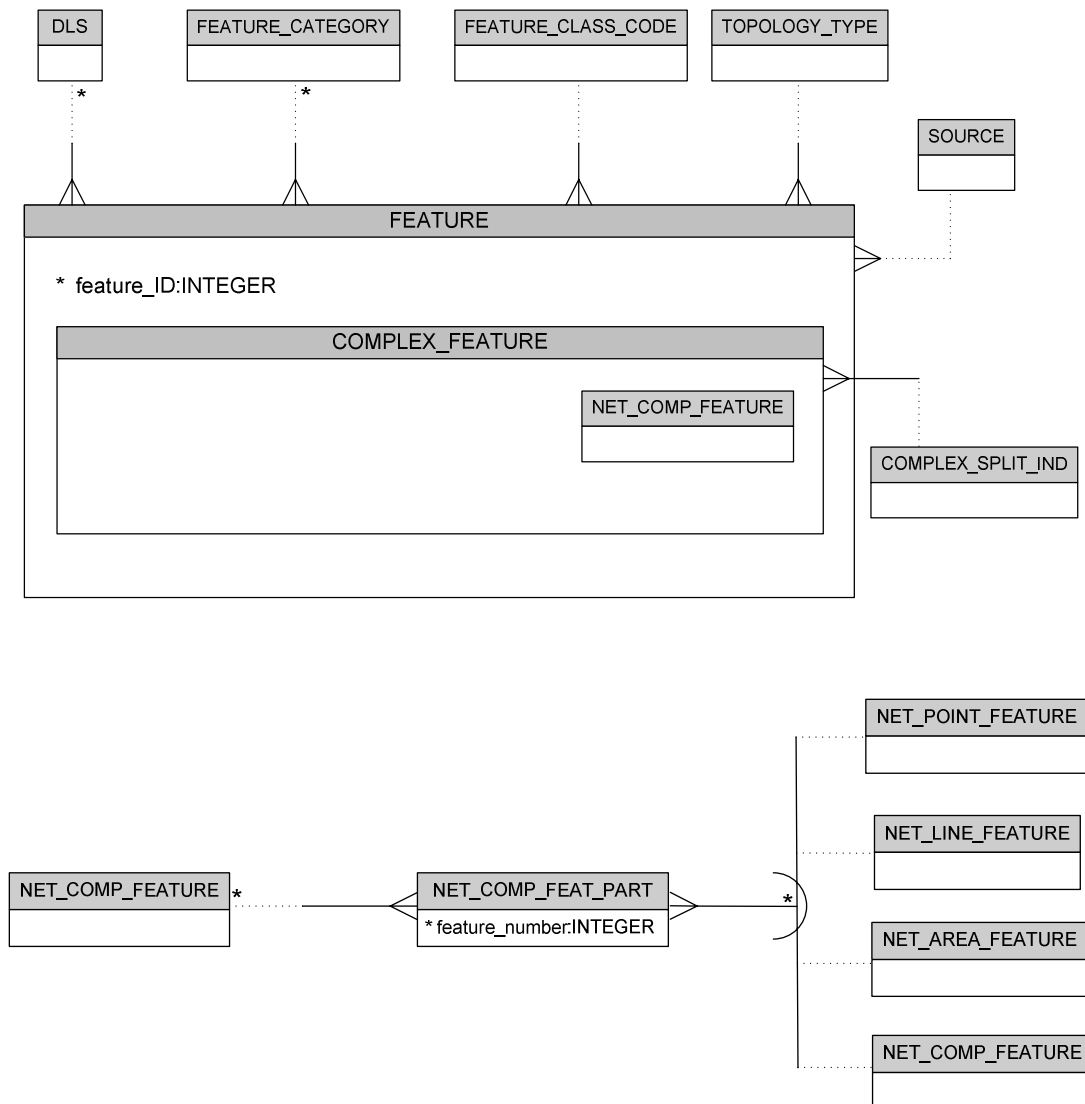

14.6.3.4.2 Physical Model

```

CREATE TABLE NET_COMP_FEATURE
(
  DLS INTEGER,
  FEAT_CATEGORY_NUM INTEGER,
  FEATURE_ID INTEGER,
  FEATURE_CLASS_CODE CHAR(4)
  CONSTRAINT NET_COMP_FEATURE_FEATURE_CLASS_CODE_NOT_NULL
  NOT NULL,
  COMPLEX_SPLIT_IND INTEGER
  CONSTRAINT NET_COMP_FEATURE_COMPLEX_SPLIT_IND_NOT_NULL
  NOT NULL,
  SOURCE_ID INTEGER,

  CONSTRAINT NET_COMP_FEATURE_PRIMARY_KEY

```

```

PRIMARY KEY (DLS, FEAT_CATEGORY_NUM, FEATURE_ID),

CONSTRAINT NET_COMP_FEATURE_DLS_EXISTS
FOREIGN KEY(DLS)
REFERENCES DLS(DLS),

CONSTRAINT NET_COMP_FEATURE_FEATURE_CLASS_EXISTS
FOREIGN KEY(FEATURE_CLASS_CODE),
REFERENCES FEATURE_CLASS(FEATURE_CLASS_CODE),

CONSTRAINT NET_COMP_FEATURE_SOURCE_EXISTS
FOREIGN KEY(DLS.DATASET_ID, SOURCE_ID)
REFERENCES SOURCE(DATASET_ID, SOURCE_ID),

CONSTRAINT NET_COMP_FEATURE_IS_COMPLEX
CHECK (FEAT_CATEGORY_NUM = 4)

)

CREATE TABLE NET_COMP_FEAT_PART
(
DLS INTEGER,
COMP_FEAT_CATEGORY INTEGER,
COMP_FEATURE_ID INTEGER,
FEATURE_NUMBER INTEGER,
FEAT_CATEGORY_NUM INTEGER,
FEATURE_ID INTEGER,

CONSTRAINT NET_COMP_FEAT_PART_PRIMARY_KEY
PRIMARY KEY (DLS, COMP_FEAT_CATEGORY, COMP_FEATURE_ID,
FEATURE_NUMBER),

CONSTRAINT NET_COMP_FEAT_PART_PART_EXISTS
CHECK (DLS, FEAT_CATEGORY_NUM, FEATURE_ID IN
(
SELECT DLS, FEAT_CATEGORY_NUM, FEATURE_ID
FROM NPC_POINT_FEATURE
UNION
SELECT DLS, FEAT_CATEGORY_NUM, FEATURE_ID
FROM NPC_LINE_FEATURE
UNION
SELECT DLS, FEAT_CATEGORY_NUM, FEATURE_ID
FROM NPC_AREA_FEATURE
UNION
SELECT DLS, FEAT_CATEGORY_NUM, FEATURE_ID
FROM NPC_COMP_FEATURE
)
)
)

```

14.6.4 Conversion

14.6.4.1 Logical Model

When a Feature spans more than one Section, each Section must contain a Conversion entity which identifies the local Feature (part) and each of the foreign Features (parts). For example, if a Feature is split across two Sections such that the part in the Section with DLS=101 has a Feature ID=1001 and the part in the Section with DLS=102 has a Feature ID=1002, then the Section with DLS=101 will contain a Conversion entity with a local Feature 1001 whose DLS is 101 and a foreign Feature 1002 whose DLS is 102. The Section with

DLS=102 will contain a Conversion entity with a local Feature 1002 whose DLS is 102 and a foreign Feature 1001 whose DLS is 101.

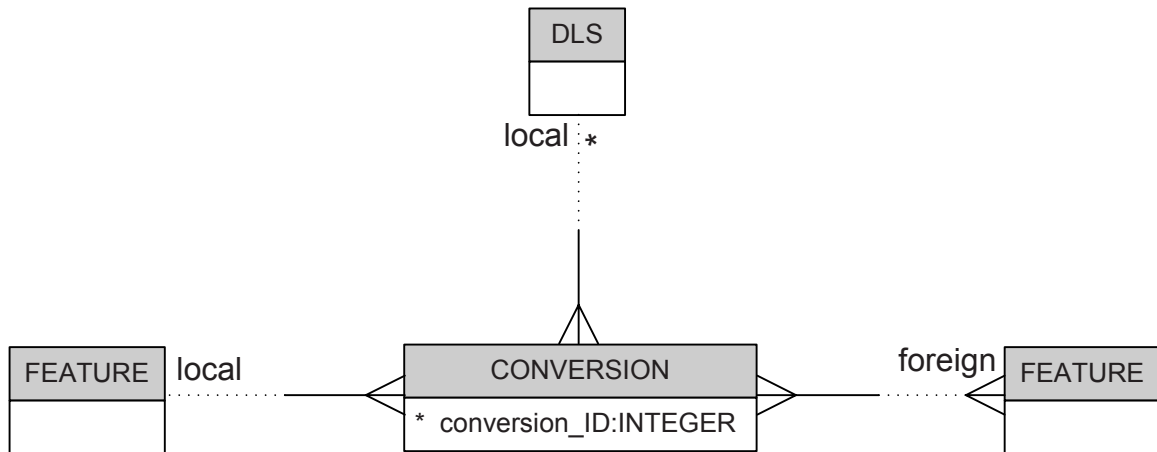

In this Logical Model, the DLS of the Conversion entity is shown because its unique identifier is needed to make the conversion ID unique in the database. Because this DLS is the same as the DLS that is part of the unique identifier for the local Feature, it does not have to appear twice in the physical implementation.

14.6.4.2 Physical Model

```

CREATE TABLE CONVERSION
(
    LOCAL_DLS INTEGER,
    CONVERSION_ID INTEGER,
    LOCAL_FEAT_CAT INTEGER,
    LOCAL_FEAT_ID INTEGER,
    FOREIGN_DLS INTEGER,
    FOREIGN_FEAT_CAT INTEGER,
    FOREIGN_FEAT_ID INTEGER,

    CONSTRAINT CONVERSION_PRIMARY_KEY
        PRIMARY KEY (LOCAL_DLS, CONVERSION_ID),

    CONSTRAINT CONVERSION_DLS_EXISTS
        FOREIGN KEY(LOCAL_DLS)
        REFERENCES DLS(DLS),

    CONSTRAINT CONVERSION_LOCAL_FEATURE_EXISTS
        CHECK (LOCAL_DLS, LOCAL_FEAT_CAT, LOCAL_FEAT_ID IN
        (
            SELECT DLS, FEAT_CATEGORY_NUM, FEATURE_ID
            FROM PF_POINT_FEATURE
            UNION
            SELECT DLS, FEAT_CATEGORY_NUM, FEATURE_ID
            FROM PF_LINE_FEATURE
            UNION
            SELECT DLS, FEAT_CATEGORY_NUM, FEATURE_ID
            FROM PF_AREA_FEATURE
            UNION
            SELECT DLS, FEAT_CATEGORY_NUM, FEATURE_ID
            FROM PF_COMP_FEATURE
            UNION
            SELECT DLS, FEAT_CATEGORY_NUM, FEATURE_ID
        )
    )
    
```

```
        FROM NPC_POINT_FEATURE
    UNION
    SELECT DLS, FEAT_CATEGORY_NUM, FEATURE_ID
        FROM NPC_LINE_FEATURE
    UNION
    SELECT DLS, FEAT_CATEGORY_NUM, FEATURE_ID
        FROM NPC_AREA_FEATURE
    UNION
    SELECT DLS, FEAT_CATEGORY_NUM, FEATURE_ID
        FROM NPC_COMP_FEATURE
    UNION
    SELECT DLS, FEAT_CATEGORY_NUM, FEATURE_ID
        FROM NET_POINT_FEATURE
    UNION
    SELECT DLS, FEAT_CATEGORY_NUM, FEATURE_ID
        FROM NET_LINE_FEATURE
    UNION
    SELECT DLS, FEAT_CATEGORY_NUM, FEATURE_ID
        FROM NET_AREA_FEATURE
    UNION
    SELECT DLS, FEAT_CATEGORY_NUM, FEATURE_ID
        FROM NET_COMP_FEATURE
    )
),
```

```
CONSTRAINT CONVERSION_FOREIGN_FEATURE_EXISTS
CHECK (FOREIGN_DLS, FOREIGN_FEAT_CAT, FOREIGN_FEAT_ID IN
(
    SELECT DLS, FEAT_CATEGORY_NUM, FEATURE_ID
        FROM PF_POINT_FEATURE
    UNION
    SELECT DLS, FEAT_CATEGORY_NUM, FEATURE_ID
        FROM PF_LINE_FEATURE
    UNION
    SELECT DLS, FEAT_CATEGORY_NUM, FEATURE_ID
        FROM PF_AREA_FEATURE
    UNION
    SELECT DLS, FEAT_CATEGORY_NUM, FEATURE_ID
        FROM PF_COMP_FEATURE
    UNION
    SELECT DLS, FEAT_CATEGORY_NUM, FEATURE_ID
        FROM NPC_POINT_FEATURE
    UNION
    SELECT DLS, FEAT_CATEGORY_NUM, FEATURE_ID
        FROM NPC_LINE_FEATURE
    UNION
    SELECT DLS, FEAT_CATEGORY_NUM, FEATURE_ID
        FROM NPC_AREA_FEATURE
    UNION
    SELECT DLS, FEAT_CATEGORY_NUM, FEATURE_ID
        FROM NPC_COMP_FEATURE
    UNION
    SELECT DLS, FEAT_CATEGORY_NUM, FEATURE_ID
        FROM NET_POINT_FEATURE
    UNION
    SELECT DLS, FEAT_CATEGORY_NUM, FEATURE_ID
        FROM NET_LINE_FEATURE
    UNION
    SELECT DLS, FEAT_CATEGORY_NUM, FEATURE_ID
        FROM NET_AREA_FEATURE

```



```
UNION
SELECT DLS, FEAT_CATEGORY_NUM, FEATURE_ID
FROM NET_COMP_FEATURE
)
)
)
```

14.7 Relationships

14.7.1 Relationship Entity

14.7.1.1 Logical Model

Relationships can exist between two or more Features. Relationships are identified by a relationship ID, unique within a DLS.

If all Features in the Relationship are in the same Section, the Relationship resides in that Section, i.e., the relationship has the same DLS as the Features.

If the related Features span multiple Sections of a single Layer, then the Relationship is stored with this Layer. The DLS of the Relationship is constructed from the common dataset ID and layer ID of the Features plus a value of 0 (zero) for section ID.

If the related Features span multiple Layers, then the Relationship is stored with the Dataset which owns the participating Layers. The DLS of the Relationship is constructed from the common dataset ID of the Features plus a value of 0 (zero) for layer ID and section ID.

If the related Features span multiple Datasets, then the Relationship is stored in at least one of these Datasets. The DLS of each Relationship occurrence is constructed from the Dataset in which it is stored plus a value of 0 (zero) for layer ID and section ID.

Because all Features owned by either a single Section or Layer must be of the same Topology Type (see 14.3), only Relationships at the Dataset level can relate Features of differing Topology Type.

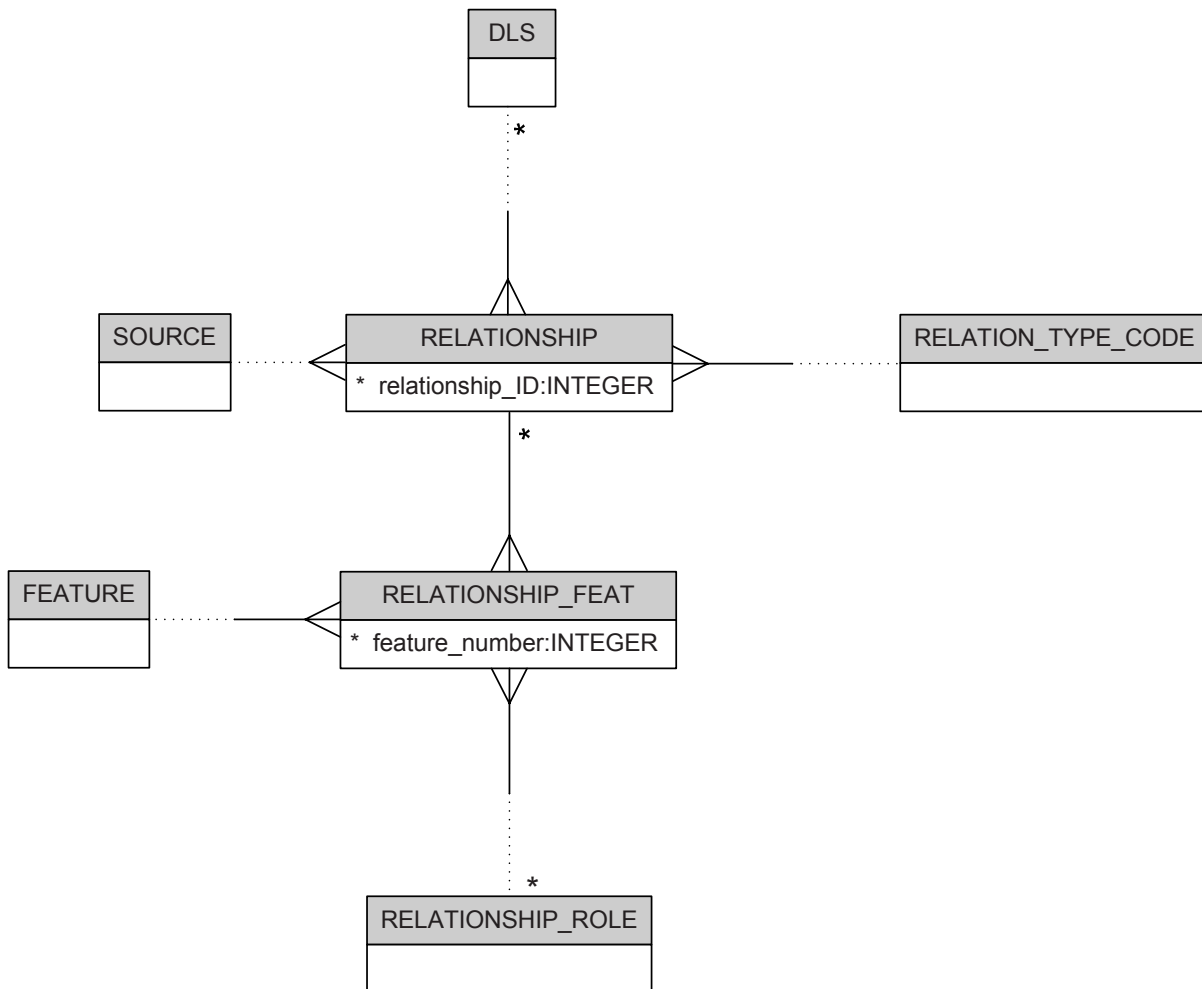

14.7.1.2 Physical Model

```

CREATE TABLE RELATIONSHIP
(
  DLS INTEGER,
  RELATIONSHIP_ID INTEGER,
  SOURCE_ID INTEGER,
  REL_TYPE_CODE CHAR(4)
  CONSTRAINT RELATIONSHIP_REL_TYPE_CODE_NOT_NULL
  NOT NULL,

  CONSTRAINT RELATIONSHIP_PRIMARY_KEY
  PRIMARY KEY (DLS, RELATIONSHIP_ID),

  CONSTRAINT RELATIONSHIP_DLS_EXISTS
  FOREIGN KEY(DLS)
  REFERENCES DLS(DLS),

  CONSTRAINT RELATIONSHIP_SOURCE_EXISTS
  FOREIGN KEY(DLS.DATASET_ID, SOURCE_ID)
  REFERENCES SOURCE(DATASET_ID, SOURCE_ID),

  CONSTRAINT RELATIONSHIP_REL_TYPE_CODE_EXISTS
  FOREIGN KEY(REL_TYPE_CODE)
  REFERENCES RELATION_TYPE_CODE (REL_TYPE_CODE)
)
  
```

NOTE Existence of at least two FEATURES for each RELATIONSHIP is checked after RELATIONSHIP_FEAT table has been created.

14.7.2 Relationship Type Reference

Each Relationship must have a four character relationship code referencing Relationship Type which is pre-defined content (see 14.2.2.15).

14.7.3 Source Reference

Each Relationship may have an integer source ID referencing Source (see 14.4.3.8).

14.7.4 Relationship Role Reference

Each Relationship Type has a pre-defined list of integer role numbers, each referencing a Relationship Role in the pre-defined content (see 14.2.2.16).

14.7.5 Relationship Feature

14.7.5.1 Logical Model

Relationship Feature identifies the Features which participate in the Relationship.

Relationship Feature therefore must identify the Relationship using the Relationship's unique identifier (relationship ID and the DLS of the Relationship).

Each Feature performs a particular Role in the Relationship. Relationship Feature identifies this Relationship Role using the Relationship Role's unique identifier comprised of its role number referencing Relationship Role (see 14.2.2.16) and the relationship code referencing the Relationship Role's Relationship Type (see 14.2.2.15).

Because multiple Features can perform the same role in the Relationship, they are uniquely identified using a feature number, unique within the Relationship Role (and consequently Relationship Type).

14.7.5.2 Physical Model

```
CREATE TABLE RELATIONSHIP_FEAT
(
  DLS INTEGER,
  RELATIONSHIP_ID INTEGER,
  ROLE_NUMBER INTEGER,
  FEATURE_NUMBER INTEGER,
  FEATURE_DLS INTEGER
  CONSTRAINT RELATIONSHIP_FEAT_FEATURE_DLS_NOT_NULL
  NOT NULL,
  FEAT_CATEGORY_NUM INTEGER
  CONSTRAINT RELATIONSHIP_FEAT_FEAT_CATEGORY_NUM_NOT_NULL
  NOT NULL,
  FEATURE_ID INTEGER
  CONSTRAINT RELATIONSHIP_FEAT_FEATURE_ID_NOT_NULL
  NOT NULL,

  CONSTRAINT RELATIONSHIP_FEAT_PRIMARY_KEY
  PRIMARY KEY (DLS, RELATIONSHIP_ID, ROLE_NUMBER, FEATURE_NUMBER),

  CONSTRAINT RELATIONSHIP_FEAT_RELATIONSHIP_EXISTS
```

```
FOREIGN KEY(DLS, RELATIONSHIP_ID)
REFERENCES RELATIONSHIP(DLS, RELATIONSHIP_ID),

CONSTRAINT RELATIONSHIP_FEAT_RELATIONSHIP_ROLE_EXISTS
FOREIGN KEY(ROLE_NUMBER)
REFERENCES RELATIONSHIP_ROLE(ROLE_NUMBER),

CONSTRAINT RELATIONSHIP_FEAT_FEATURE_EXISTS
CHECK (FEATURE_DLS, FEAT_CATEGORY_NUM, FEATURE_ID IN
(
SELECT DLS, FEAT_CATEGORY_NUM, FEATURE_ID
FROM PF_POINT_FEATURE
UNION
SELECT DLS, FEAT_CATEGORY_NUM, FEATURE_ID
FROM PF_LINE_FEATURE
UNION
SELECT DLS, FEAT_CATEGORY_NUM, FEATURE_ID
FROM PF_AREA_FEATURE
UNION
SELECT DLS, FEAT_CATEGORY_NUM, FEATURE_ID
FROM PF_COMP_FEATURE
UNION
SELECT DLS, FEAT_CATEGORY_NUM, FEATURE_ID
FROM NPC_POINT_FEATURE
UNION
SELECT DLS, FEAT_CATEGORY_NUM, FEATURE_ID
FROM NPC_LINE_FEATURE
UNION
SELECT DLS, FEAT_CATEGORY_NUM, FEATURE_ID
FROM NPC_AREA_FEATURE
UNION
SELECT DLS, FEAT_CATEGORY_NUM, FEATURE_ID
FROM NPC_COMP_FEATURE
UNION
SELECT DLS, FEAT_CATEGORY_NUM, FEATURE_ID
FROM NET_POINT_FEATURE
UNION
SELECT DLS, FEAT_CATEGORY_NUM, FEATURE_ID
FROM NET_LINE_FEATURE
UNION
SELECT DLS, FEAT_CATEGORY_NUM, FEATURE_ID
FROM NET_AREA_FEATURE
UNION
SELECT DLS, FEAT_CATEGORY_NUM, FEATURE_ID
FROM NET_COMP_FEATURE
)
)
)
```

```
ALTER TABLE RELATIONSHIP
ADD CONSTRAINT RELATIONSHIP_HAS_TWO_OR_MORE_FEATURES
CHECK
(
(SELECT COUNT(RELATIONSHIP_ID)
FROM RELATIONSHIP_FEAT)
> 1
)
DEFERRABLE INITIALLY DEFERRED
```

14.7.6 Feature Reference

Relationship Feature must also identify each Feature participating in the Relationship using the Feature's unique identifier comprised of its integer DLS referencing the Data/Layer/Section owning the Feature (see 14.4.6), the integer Feature Category code referencing the Feature Category (see 14.2.2.8), and the feature ID of the Feature (see 14.6).

14.8 Attributes

14.8.1 Overview

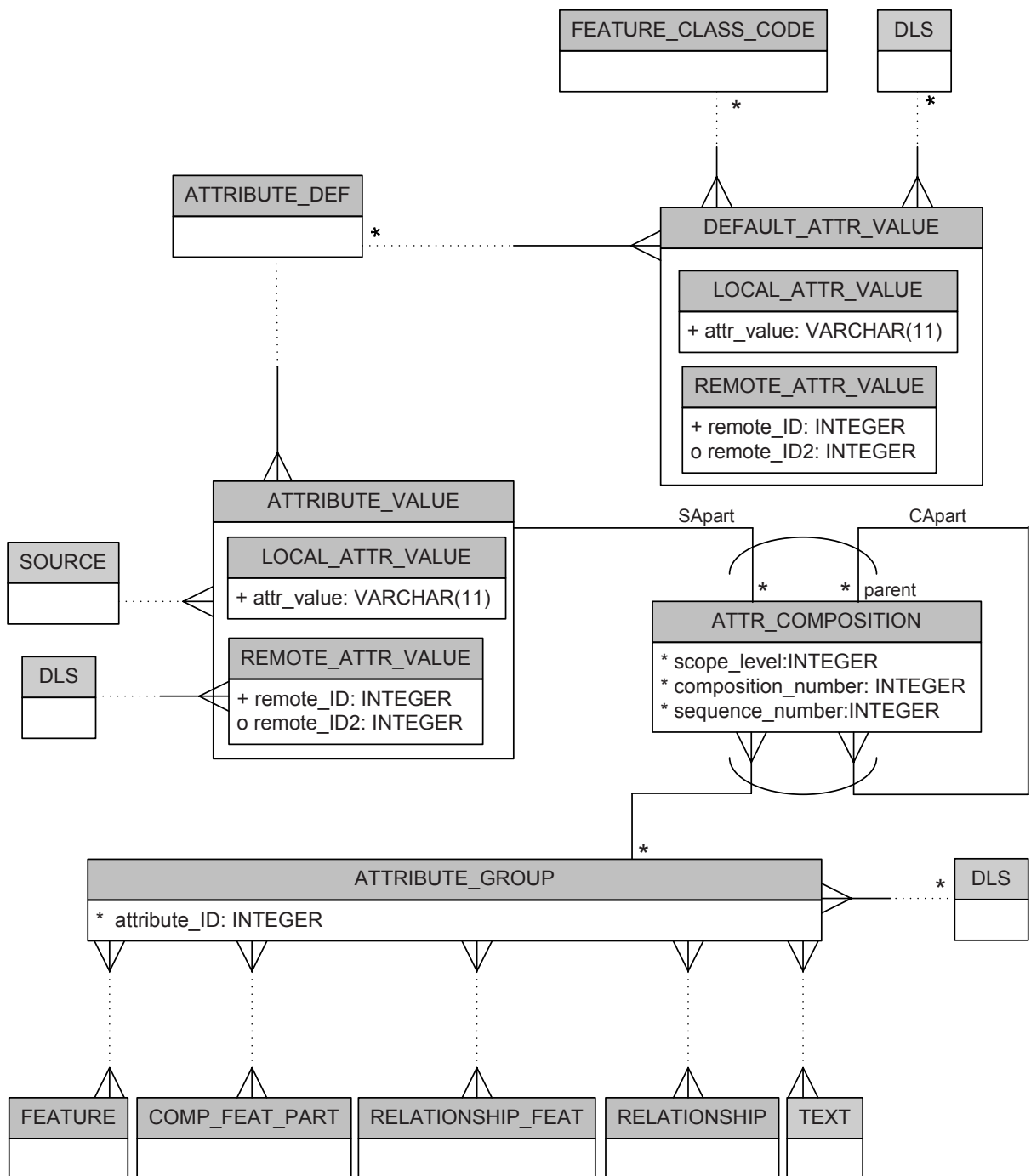

14.8.2 Attribute Group

14.8.2.1 Logical Model

An Attribute Group represents a group of attributes and their values which are collectively uniquely identified by an integer attribute ID unique within a DLS. The Group is comprised of one or more member attributes, each specified by an Attribute Composition.

This Attribute Group can be applied to one or more Features, Complex Feature Parts, Relationships, Feature-Relationship Associations, and/or Text (TXT) records.

14.8.2.2 Physical Model

```
CREATE TABLE ATTRIBUTE_GROUP
(
  DLS INTEGER,
  ATTRIBUTE_ID INTEGER,

  CONSTRAINT ATTRIBUTE_GROUP_PRIMARY_KEY
    PRIMARY KEY (DLS, ATTRIBUTE_ID)

  CONSTRAINT ATTRIBUTE_GROUP_DLS_EXISTS
    FOREIGN KEY(DLS)
    REFERENCES DLS(DLS),
)
```

14.8.3 Attribute Composition

14.8.3.1 Logical Model

Attribute Composition specifies a particular member of an Attribute Group. It is uniquely identified by the owning Attribute Group's attribute ID along with integer scope level, composition number and sequence number values, the combination of which is unique within the Attribute Group. An Attribute Composition can be used to specify either a Simple or Composite Attribute or the simple, restrictive, or composite part of a Composite Attribute.

Attribute Compositions on scope level 1 (one) specify either simple or Composite Attributes at the highest level within the Attribute Group. They all have a composition number equal to 0 (zero) as they are not parts of another Composite Attribute. There must be at least one Attribute Composition at scope level 1. If there is only one, it is given a sequence number of 1 (one). If there are more than one, the sequence number specifies where the Attribute Composition appears in order within the Attribute Group. If only Simple Attributes appear on scope level 1, there are no other scope levels for this Attribute Group.

Composite Attributes may be made up of simple, restrictive, and/or other Composite Attribute child parts. Each part is an Attribute composition having a scope level one greater in number than the scope level of the parent Composite Attribute. All of these children are assigned the same composition number. The composition number must be unique within the entire Attribute Group, but otherwise has no meaning defining parentage or sequence. The order of the child part within the parent Composite Attribute is specified by the sequence number.

For Simple Attributes, the Attribute composition contains an Attribute Value for that Simple Attribute.

Attribute Compositions representing a Restrictive Sub-Attribute contain an Attribute Value for that Restrictive Sub-Attribute.

Composite Attributes do not have a value – only their simple and Restrictive Sub-Attribute parts have values. Therefore, in the Composite Attribute case, instead of an Attribute Value, the Attribute Composition contains one or more other child Attribute Compositions, one for each component of the Composite Attribute at the next lower level. At this next lower level (and subsequent lower levels), each of the Attribute Compositions can represent either a Simple Attribute, a Restrictive Sub-Attribute or a Composite Attribute.

Consider the following example. Let AG1 be an Attribute group; SA1, SA2, SA3, SA4, SA5 and SA6 be Simple Attributes; CA1, CA2, CA3, CA4 and CA5 be Composite Attributes; and RSA1 and RSA2 be Restrictive Sub-Attributes. A Feature has Attribute Group AG1, comprised of SA1, CA1, and CA2, in that order. CA1 is comprised of CA3 and CA4. CA2 is comprised of CA5 and RSA1. CA3 is comprised of SA2 and RSA3. CA4 is comprised of SA3 and SA4. CA5 is comprised of SA5 and SA6. This is shown diagrammatically as follows:

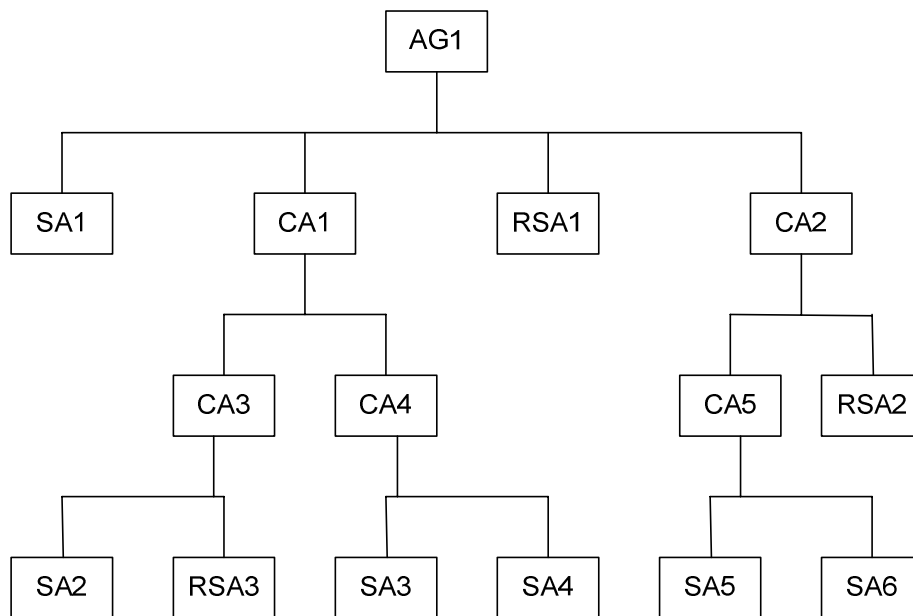

The following table shows the Feature attribution

ATTRIBUTE	SCOPE LEVEL	COMPOSITION NUMBER	SEQUENCE NUMBER	PARENT
SA1	1	0	1	-
CA1	1	0	2	-
RSA1	1	0	3	-
CA2	1	0	4	-
CA3	2	1	1	CA1
CA4	2	1	2	CA1
CA5	2	2	1	CA2
RSA2	2	2	2	CA2
SA2	3	3	1	CA3
RSA3	3	3	2	CA3
SA3	3	5	1	CA4
SA4	3	5	2	CA4
SA5	3	4	1	CA5
SA6	3	4	2	CA5

14.8.3.2 Physical Model

```
CREATE TABLE ATTR_COMPOSITION
(
  DLS INTEGER,
  ATTRIBUTE_ID INTEGER,
  SCOPE_LEVEL INTEGER,
  COMPOSITION_NUMBER INTEGER,
  SEQUENCE_NUMBER INTEGER,
  PARENT_SCOPE_LEVEL INTEGER,
  PARENT_COMP_NUMBER INTEGER,
  PARENT_SEQ_NUMBER INTEGER,
  AV_ATTR_VALUE CHARACTER VARYING(11),
  AV_TYPE_CODE CHAR(2),
  AV_REMOTE_DLS INTEGER,
  AV_REMOTE_ID INTEGER,
  AV_REMOTE_ID2 INTEGER,
  AV_SOURCE_ID INTEGER,

  CONSTRAINT ATTR_COMPOSITION_PRIMARY_KEY
    PRIMARY KEY (DLS, ATTRIBUTE_ID, SCOPE_LEVEL, COMPOSITION_NUMBER,
    SEQUENCE_NUMBER),

  CONSTRAINT ATTR_COMPOSITION_PARENT_EXISTS
    FOREIGN KEY(DLS, ATTRIBUTE_ID, PARENT_SCOPE_LEVEL, PARENT_COMP_NUMBER,
    PARENT_SEQ_NUMBER)
    REFERENCES COMPOSITE_ATTRIBUTE(DLS, ATTRIBUTE_ID, SCOPE_LEVEL,
    COMPOSITION_NUMBER, SEQUENCE_NUMBER),

  CONSTRAINT AV_SOURCE_EXISTS
    FOREIGN KEY(DLS.DATASET_ID, SOURCE_ID)
    REFERENCES SOURCE(DATASET_ID, SOURCE_ID),

  CONSTRAINT ATTR_COMPOSITION_AV_TYPE_CODE_EXISTS
    FOREIGN KEY(AV_TYPE_CODE)
    REFERENCES ATTRIBUTE_DEF(ATTR_TYPE_CODE)
)
```

The following constraints are not checked:

- a) Each Attribute Composition can have:
 - 1) only a parent if it is a Composite Attribute part of another Composite Attribute,
 - 2) only an attribute value (AV) if it is a Simple Attribute or Restrictive Sub-Attribute (operating on a Relationship) at scope level 1,
 - 3) both a parent and an AV if it is a Simple Attribute or Restrictive Sub-Attribute part of a Composite Attribute, or
 - 4) neither a parent nor an AV if it is a Composite Attribute at scope level 1.
- b) If a Composite Attribute has an AV, it can have a Source, but must have an Attribute type code plus one of:
 - 1) a (local) Attribute Value,
 - 2) a (remote) DLS plus a remote ID, or
 - 3) a (remote GSD) DLS, remote ID and remote ID2.

14.8.4 Attribute Value

14.8.4.1 Logical Model

For Attribute Compositions which represent either a simple or Restrictive Sub-Attribute, the Attribute Composition combines a single Attribute type (e.g., speed limit) specified by an Attribute Definition with a corresponding Attribute Value (e.g., 55).

If the value described by the Attribute Value entity is a character string containing language-coded text, a character string exceeding 11 characters, a time domain value, or a GSD value, then the value is considered to be “remote”. Otherwise the value is considered to be “local”. Local attribute values are stored locally (in the Attribute Value entity) as character strings. Remote attribute values have a pointer stored locally but the actual value is stored remotely in another entity (Time Domain, LCS Text, or GS_Containment, see 14.5.2, 14.2.2.4.4 or 14.5.3, respectively). The locally-stored pointer is comprised of an integer DLS ID and an integer remote ID which corresponds to either a time ID or string ID. For GS_Containment values, two integers are required. The first specifies the geopolitical structure definition id and the second one specifies the corresponding gsd component id.

ATTRIBUTE DATA TYPE	DATA TYPE NAME	LOCAL / REMOTE	LOCAL STORED VALUE
COD	Code List	L	Integer code as character string
ENM	Enumeration	L	Integer code as character string
CNT	Number	L	Number as character string
BOL	Boolean	L	1 or 0 as character string
BMR	Bit Mask Register	L	Binary number as character string
BMI	Bit Mask Integer	L	Binary number as character string
TMR	Time Domain	R (Time)	DLS and time_ID, both integers
SCS	(Simple) Character String	L	Character string as character string
TXT	(Language-Coded) Text	R (LCS)	DLS and string_ID, both integers
PRC	Percentage	L	Percentage as character string
CMP	Composite	L	No value stored
IDN	Identifier	L	Identifier as character string
GSD	Geopolitical Structure Definition	R (GS_Containment)	Two GS_Containment integer IDs
PRS	Signed Percentage	L	Percentage with (optional) sign as character string
MSR	Measure	L	Numeric value as a character string

14.8.4.2 Physical Model

Moved into Attribute Composition table (since it is 1:1)

14.8.5 Attribute Definition Reference

The Attribute Definition is pre-defined content which defines the Attribute, including the Attribute type code, Attribute Data Type and possibly Attribute Data Unit (see 14.2.2.11.4).

14.8.6 Default Attribute Value

14.8.6.1 Logical Model

Each Default Attribute Value must contain a four-character Feature Class Code referencing the Feature Class which may govern the Attribute Value (see 14.2.2.10). If the Default Attribute Value pertains to all Feature Classes, a Feature Class Code of “0000” shall be used. As with Attribute Values, Default Attribute Values can be “local” or “remote”.

14.8.6.2 Physical Model

```
CREATE TABLE DEFAULT_ATTR_VALUE
(
  DLS INTEGER,
  FEATURE_CLASS_CODE CHAR(4),
  TYPE_CODE CHAR(2),
  ATTR_VALUE CHARACTER VARYING(11),
  REMOTE_ID INTEGER,
  REMOTE_ID2 INTEGER,

  CONSTRAINT DEFAULT_ATTR_VALUE_PRIMARY_KEY
    PRIMARY KEY (DLS, FEATURE_CLASS_CODE, TYPE_CODE),

  CONSTRAINT DEFAULT_ATTR_VALUE_FEATURE_CLASS_CODE_EXISTS
    FOREIGN KEY(FEATURE_CLASS_CODE)
    REFERENCES FEATURE_CLASS_CODE(FEATURE_CLASS_CODE),

  CONSTRAINT DEFAULT_ATTR_VALUE_TYPE_CODE_EXISTS
    FOREIGN KEY(TYPE_CODE)
    REFERENCES ATTRIBUTE_DEF(ATTR_TYPE_CODE)
)
```

NOTE The remote DLS is the same as the Default Attribute Value DLS and is therefore not persisted separately.

The following constraints are not checked:

A Default Attribute Value must have a DLS, an Attribute type code, a Feature Class Code, plus one of:

- 1) a (local) Attribute Value,
- 2) a remote ID, or
- 3) a remote ID and remote ID2 (for a remote GSD).

14.8.7 DLS Reference

Attribute Groups are kept at the same or higher level (Dataset, Layer, or Section) as the entity to which they apply. They will therefore have the same or higher DLS value (i.e. additional NULL values for section ID, or section ID and Layer ID, respectively) as that entity.

14.8.8 Attribute Group Application

14.8.8.1 Logical Model

Attribute Groups can apply to several entity types, including Features, Complex Feature Parts, Relationships, Feature-Relationship Associations, or Text records. This is a many to many relationship: once defined, an Attribute Group in its entirety may apply to any number of entities and any entity may have any number of Attribute Groups associated with it.

14.8.8.2 Physical Model

```
CREATE TABLE FEATURE_ATTR
(
  FEATURE_DLS INTEGER,
  FEAT_CATEGORY_NUM INTEGER,
  FEATURE_ID INTEGER,
  ATTRIBUTE_DLS INTEGER,
  ATTRIBUTE_ID INTEGER,
```

CONSTRAINT FEATURE_ATTR_PRIMARY_KEY
PRIMARY KEY (FEATURE_DLS, FEAT_CATEGORY_NUM, FEATURE_ID, ATTRIBUTE_DLS,
ATTRIBUTE_ID),

CONSTRAINT FEATURE_ATTR_FEATURE_EXISTS
CHECK (FEATURE_DLS, FEAT_CATEGORY_NUM, FEATURE_ID IN
(SELECT DLS, FEAT_CATEGORY_NUM, FEATURE_ID
FROM PF_POINT_FEATURE
UNION
SELECT DLS, FEAT_CATEGORY_NUM, FEATURE_ID
FROM PF_LINE_FEATURE
UNION
SELECT DLS, FEAT_CATEGORY_NUM, FEATURE_ID
FROM PF_AREA_FEATURE
UNION
SELECT DLS, FEAT_CATEGORY_NUM, FEATURE_ID
FROM PF_COMP_FEATURE
UNION
SELECT DLS, FEAT_CATEGORY_NUM, FEATURE_ID
FROM NPC_POINT_FEATURE
UNION
SELECT DLS, FEAT_CATEGORY_NUM, FEATURE_ID
FROM NPC_LINE_FEATURE
UNION
SELECT DLS, FEAT_CATEGORY_NUM, FEATURE_ID
FROM NPC_AREA_FEATURE
UNION
SELECT DLS, FEAT_CATEGORY_NUM, FEATURE_ID
FROM NPC_COMP_FEATURE
UNION
SELECT DLS, FEAT_CATEGORY_NUM, FEATURE_ID
FROM NET_POINT_FEATURE
UNION
SELECT DLS, FEAT_CATEGORY_NUM, FEATURE_ID
FROM NET_LINE_FEATURE
UNION
SELECT DLS, FEAT_CATEGORY_NUM, FEATURE_ID
FROM NET_AREA_FEATURE
UNION
SELECT DLS, FEAT_CATEGORY_NUM, FEATURE_ID
FROM NET_COMX_FEATURE)
),

CONSTRAINT FEATURE_ATTR_ATTRIBUTE_GROUP_EXISTS
FOREIGN KEY(ATTRIBUTE_DLS, ATTRIBUTE_ID)
REFERENCES ATTRIBUTE_GROUP(DLS, ATTRIBUTE_ID)
)

CREATE TABLE CMP_FEAT_PART_ATTR
(
FEATURE_DLS INTEGER,
FEAT_CATEGORY_NUM INTEGER,
FEATURE_ID INTEGER,
SEQUENCE_NUMBER INTEGER,
ATTRIBUTE_DLS INTEGER,
ATTRIBUTE_ID INTEGER,

CONSTRAINT FEATURE_ATTR_PRIMARY_KEY
PRIMARY KEY (FEATURE_DLS, FEAT_CATEGORY_NUM, FEATURE_ID,
SEQUENCE_NUMBER ATTRIBUTE_DLS, ATTRIBUTE_ID),

```
CONSTRAINT FEATURE_ATTR_COMPLEX_FEATURE_PART_EXISTS
CHECK (FEATURE_DLS, FEAT_CATEGORY_NUM, FEATURE_ID, SEQUENCE_NUMBER IN
(SELECT DLS, FEAT_CATEGORY_NUM, FEATURE_ID, SEQUENCE_NUMBER
FROM PF_COMP_FEAT_PART
UNION
SELECT DLS, FEAT_CATEGORY_NUM, FEATURE_ID, SEQUENCE_NUMBER
FROM NPC_COMP_FEAT_PART
UNION
SELECT DLS, FEAT_CATEGORY_NUM, FEATURE_ID, SEQUENCE_NUMBER
FROM NET_COMP_FEAT_PART)
),
```

```
CONSTRAINT FEATURE_ATTR_ATTRIBUTE_GROUP_EXISTS
FOREIGN KEY(ATTRIBUTE_DLS, ATTRIBUTE_ID)
REFERENCES ATTRIBUTE_GROUP(DLS, ATTRIBUTE_ID)
)
```

```
CREATE TABLE RELATIONSHIP_ATTR
```

```
(
RELATIONSHIP_DLS INTEGER,
RELATIONSHIP_ID INTEGER,
ATTRIBUTE_DLS INTEGER,
ATTRIBUTE_ID INTEGER,
```

```
CONSTRAINT RELATIONSHIP_ATTR_PRIMARY_KEY
PRIMARY KEY (RELATIONSHIP_DLS, RELATIONSHIP_ID, ATTRIBUTE_DLS,
ATTRIBUTE_ID),
```

```
CONSTRAINT RELATIONSHIP_ATTR_RELATIONSHIP_EXISTS
FOREIGN KEY(RELATIONSHIP_DLS, RELATIONSHIP_ID)
REFERENCES RELATIONSHIP(DLS, RELATIONSHIP_ID),
```

```
CONSTRAINT RELATIONSHIP_ATTR_ATTRIBUTE_GROUP_EXISTS
FOREIGN KEY(ATTRIBUTE_DLS, ATTRIBUTE_ID)
REFERENCES ATTRIBUTE_GROUP(DLS, ATTRIBUTE_ID)
)
```

```

CREATE TABLE RELATION_FEAT_ATTR
(
  RELATION_FEAT_DLS INTEGER,
  RELATIONSHIP_ID INTEGER,
  ROLE_NUMBER INTEGER,
  FEATURE_NUMBER INTEGER,
  ATTRIBUTE_DLS INTEGER,
  ATTRIBUTE_ID INTEGER,

  CONSTRAINT RELATION_FEAT_ATTR_PRIMARY_KEY
    PRIMARY KEY (RELATIONSHIP_DLS, RELATIONSHIP_ID, ROLE_NUMBER,
      FEATURE_NUMBER, ATTRIBUTE_DLS, ATTRIBUTE_ID),

  CONSTRAINT RELATION_FEAT_ATTR_RELATIONSHIP_FEAT_EXISTS
    FOREIGN KEY(RELATION_FEAT_DLS, RELATIONSHIP_ID, ROLE_NUMBER,
      FEATURE_NUMBER)
    REFERENCES RELATIONSHIP_FEAT(DLS, RELATIONSHIP_ID, ROLE_NUMBER,
      FEATURE_NUMBER),

  CONSTRAINT RELATIONSHIP_ATTR_ATTRIBUTE_GROUP_EXISTS
    FOREIGN KEY(ATTRIBUTE_DLS, ATTRIBUTE_ID)
    REFERENCES ATTRIBUTE_GROUP(DLS, ATTRIBUTE_ID)
)

CREATE TABLE TEXT_ATTR
(
  TEXT_DLS INTEGER,
  STRING_ID INTEGER,
  ATTRIBUTE_DLS INTEGER,
  ATTRIBUTE_ID INTEGER,

  CONSTRAINT RELATIONSHIP_ATTR_PRIMARY_KEY
    PRIMARY KEY (TEXT_DLS, STRING_ID, ATTRIBUTE_DLS, ATTRIBUTE_ID),

  CONSTRAINT TEXT_ATTR_TEXT_EXISTS
    FOREIGN KEY(TEXT_DLS, STRING_ID)
    REFERENCES LCS_TEXT(DLS, STRING_ID),

  CONSTRAINT TEXT_ATTR_ATTRIBUTE_GROUP_EXISTS
    FOREIGN KEY(ATTRIBUTE_DLS, ATTRIBUTE_ID)
    REFERENCES ATTRIBUTE_GROUP(DLS, ATTRIBUTE_ID)
)

```

14.9 Object Referencing

14.9.1 Logical Model

In the GDF MRS, record IDs are unique within a record type and can change over time. Each data record can be assigned a globally unique ID across time, called an object reference. This object reference can be of any reference type, data type and length. .

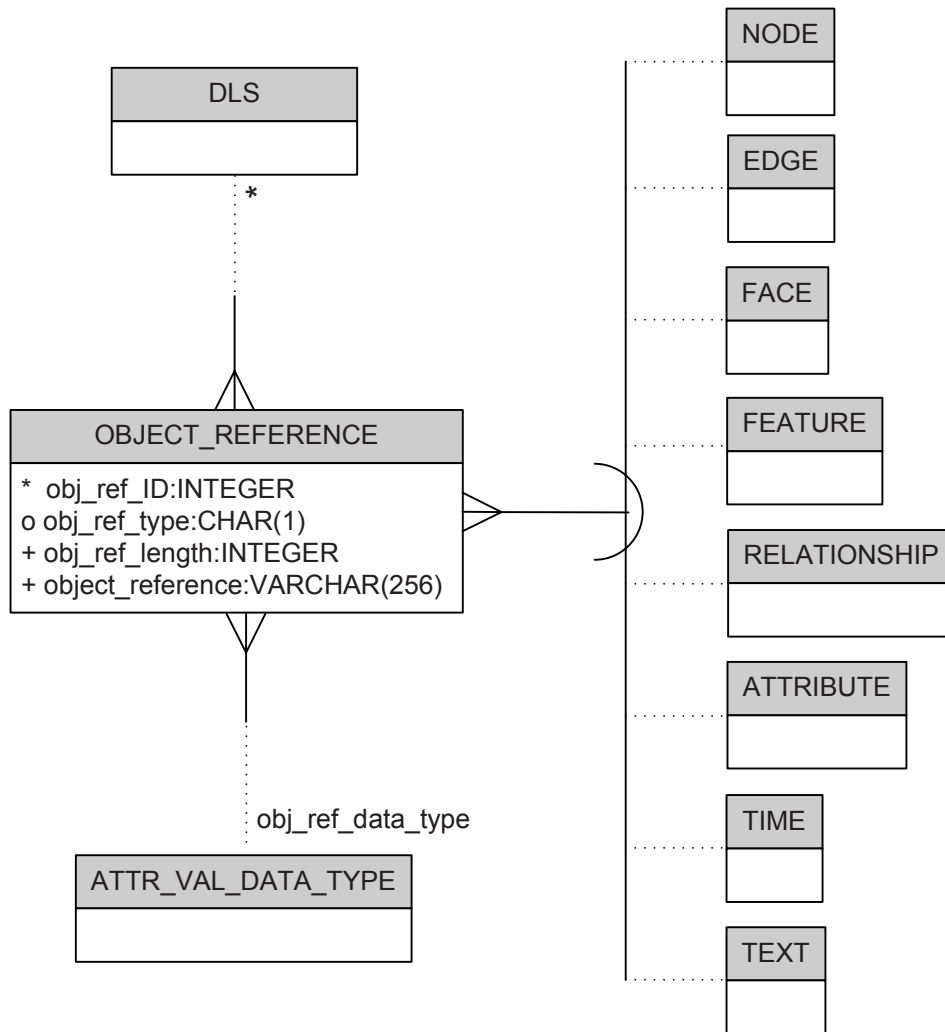

Object References refer to a single object (Feature, Relationship, Node, Edge, Face, Time, Text, or Attribute). They are uniquely identified by an object reference ID, unique within a DLS. The DLS of the object reference is the same as the DLS of the object.

NOTE the approach taken here uses the entity's id (e.g., Node id for Nodes) instead of the record type and number as is done in the MRS.

14.9.2 Physical Model

```

CREATE TABLE OBJECT_REFERENCE
(
  DLS INTEGER,
  OBJ_REF_ID INTEGER,
  OBJ_REF_TYPE CHAR(1),
  OBJ_REF_LENGTH INTEGER
  CONSTRAINT OBJECT_REFERENCE_OBJ_REF_LENGTH_NOT_NULL
  NOT NULL,
  OBJECT_REFERENCE CHARACTER VARYING(256)
  CONSTRAINT OBJECT_REFERENCE_OBJECT_REFERENCE_NOT_NULL
  NOT NULL,
  OBJ_REF_DATA_TYPE CHAR(2),
  GDF_NODE_ID INTEGER,
  GDF_EDGE_ID INTEGER,

```

```

GDF_FACE_ID INTEGER,
FEAT_CATEGORY_NUM INTEGER,
FEATURE_ID INTEGER,
RELATIONSHIP_ID INTEGER,
ATTRIBUTE_ID INTEGER,
TIME_ID INTEGER,
STRING_ID INTEGER,

CONSTRAINT OBJECT_REFERENCE_PRIMARY_KEY
    PRIMARY KEY (DLS, OBJ_REF_ID),

CONSTRAINT OBJECT_REFERENCE_DLS_EXISTS
    FOREIGN KEY(DLS)
    REFERENCES DLS(DLS),

CONSTRAINT OBJECT_REFERENCE_OBJ_REF_DATA_TYPE_EXISTS
    FOREIGN KEY(OBJ_REF_DATA_TYPE)
    REFERENCES ATTR_VAL_DATA_TYPE(ATTR_VAL_DATA_TYPE),

CONSTRAINT OBJECT_REFERENCE_GDF_NODE_ID_EXISTS
    FOREIGN KEY(DLS, GDF_NODE_ID)
    REFERENCES topology.ST_NODE(DLS, GDF_NODE_ID),

CONSTRAINT OBJECT_REFERENCE_GDF_EDGE_ID_EXISTS
    FOREIGN KEY(DLS, GDF_EDGE_ID)
    REFERENCES topology.ST_EDGE(DLS, GDF_EDGE_ID),

CONSTRAINT OBJECT_REFERENCE_GDF_FACE_ID_EXISTS
    FOREIGN KEY(DLS, GDF_FACE_ID)
    REFERENCES topology.ST_FACE(DLS, GDF_FACE_ID),

CONSTRAINT OBJECT_REFERENCE_FEATURE_EXISTS
    CHECK (DLS, FEAT_CATEGORY_NUM, FEATURE_ID IN
        (
            SELECT DLS, FEAT_CATEGORY_NUM, FEATURE_ID
            FROM PF_POINT_FEATURE
            UNION
            SELECT DLS, FEAT_CATEGORY_NUM, FEATURE_ID
            FROM PF_LINE_FEATURE
            UNION
            SELECT DLS, FEAT_CATEGORY_NUM, FEATURE_ID
            FROM PF_AREA_FEATURE
            UNION
            SELECT DLS, FEAT_CATEGORY_NUM, FEATURE_ID
            FROM PF_COMP_FEATURE
            UNION
            SELECT DLS, FEAT_CATEGORY_NUM, FEATURE_ID
            FROM NPC_POINT_FEATURE
            UNION
            SELECT DLS, FEAT_CATEGORY_NUM, FEATURE_ID
            FROM NPC_LINE_FEATURE
            UNION
            SELECT DLS, FEAT_CATEGORY_NUM, FEATURE_ID
            FROM NPC_AREA_FEATURE
            UNION
            SELECT DLS, FEAT_CATEGORY_NUM, FEATURE_ID
            FROM NPC_COMP_FEATURE
            UNION
            SELECT DLS, FEAT_CATEGORY_NUM, FEATURE_ID
            FROM NET_POINT_FEATURE
        )
    )

```

```
UNION
SELECT DLS, FEAT_CATEGORY_NUM, FEATURE_ID
FROM NET_LINE_FEATURE
UNION
SELECT DLS, FEAT_CATEGORY_NUM, FEATURE_ID
FROM NET_AREA_FEATURE
UNION
SELECT DLS, FEAT_CATEGORY_NUM, FEATURE_ID
FROM NET_COMP_FEATURE
)
),

CONSTRAINT OBJECT_REFERENCE_RELATIONSHIP_ID_EXISTS
FOREIGN KEY(DLS, RELATIONSHIP_ID)
REFERENCES RELATIONSHIP(DLS, RELATIONSHIP_ID),

CONSTRAINT OBJECT_REFERENCE_ATTRIBUTE_ID_EXISTS
FOREIGN KEY(DLS, ATTRIBUTE_ID)
REFERENCES ATTRIBUTE(DLS, ATTRIBUTE_ID),

CONSTRAINT OBJECT_REFERENCE_TIME_ID_EXISTS
FOREIGN KEY(DLS, TIME_ID)
REFERENCES TIME(DLS, TIME_ID),

CONSTRAINT OBJECT_REFERENCE_STRING_ID_EXISTS
FOREIGN KEY(DLS, STRING_ID)
REFERENCES LCS_TEXT(DLS, STRING_ID)
)
```

NOTE topology is the name of the SQL schema specifying the topology coverage in SQL/MM.

14.10 Update registry

14.10.1 Overview

Update information can be of three types, depending on what is being updated. These include geometric, object, and Attribute updates.

14.10.2 Geo-topo Update Information

14.10.2.1 Logical Model

Geo-topo Update Information describes updates to geometric objects: Node, Edge, Face, or NET Feature (which contain dots, polylines, and polygons) or coordinate tuples (from MRS coord records).

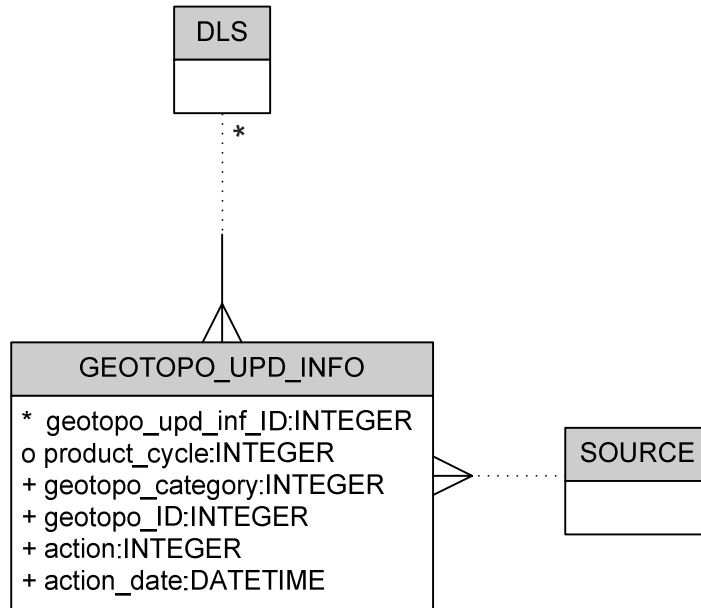

Geotopo Update Information entities are identified by a geotopo update information ID, unique within the DLS which contains the geometric object being updated.

The geotopo category is the Geotopo Object Category:

- 1 = Node
- 2 = Edge
- 3 = Face
- 4 = Dot
- 5 = Polyline
- 6 = Polygon
- 7 = Coordinate Tuple(s)

The geotopo ID is the unique identifier of the updated geometry object (GDF Node ID or GDF Edge ID or GDF Face ID or NET Feature ID (for dots, polylines, and polygons).

The action is the Action Class:

- 0 = update of source only
- 1 = New
- 2 = Delete
- 3 = Modify

Each Geotopo Update Information may contain the integer source ID representing Source (see 14.4.3.8).

14.10.2.2 Physical Model

```
CREATE TABLE GEOTOPO_UPD_INFO
(
  DLS INTEGER,
  GEOTOPO_UPD_INF_ID INTEGER,
  PRODUCT_CYCLE INTEGER,
  GEOTOPO_CATEGORY INTEGER
  CONSTRAINT GEOTOPO_UPD_INFO_GEOTOPO_CATEGORY_NOT_NULL
  NOT NULL,
  GEOTOPO_ID INTEGER
  CONSTRAINT GEOTOPO_UPD_INFO_GEOTOPO_ID_NOT_NULL
  NOT NULL,
  ACTION INTEGER
  CONSTRAINT GEOTOPO_UPD_INFO_ACTION_NOT_NULL
  NOT NULL,
  ACTION_DATE DATETIME
  CONSTRAINT GEOTOPO_UPD_INFO_ACTION_DATE_NOT_NULL
  NOT NULL,
  SOURCE_ID INTEGER,

  CONSTRAINT GEOTOPO_UPD_INFO_PRIMARY_KEY
  PRIMARY KEY (DLS, GEOTOPO_UPD_INF_ID),

  CONSTRAINT GEOTOPO_UPD_INFO_DLS_EXISTS
  FOREIGN KEY(DLS)
  REFERENCES DLS(DLS),

  CONSTRAINT GEOTOPO_UPD_INFO_SOURCE_EXISTS
  FOREIGN KEY(DLS.DATASET_ID, SOURCE_ID)
  REFERENCES SOURCE(DATASET_ID, SOURCE_ID)
)
```

14.10.3 Object Update Information

14.10.3.1 Logical Model

Object Update Information describes updates to non-geometric objects: Features (point, line, area, complex), Relationships, Name, Time Domain, and Other text

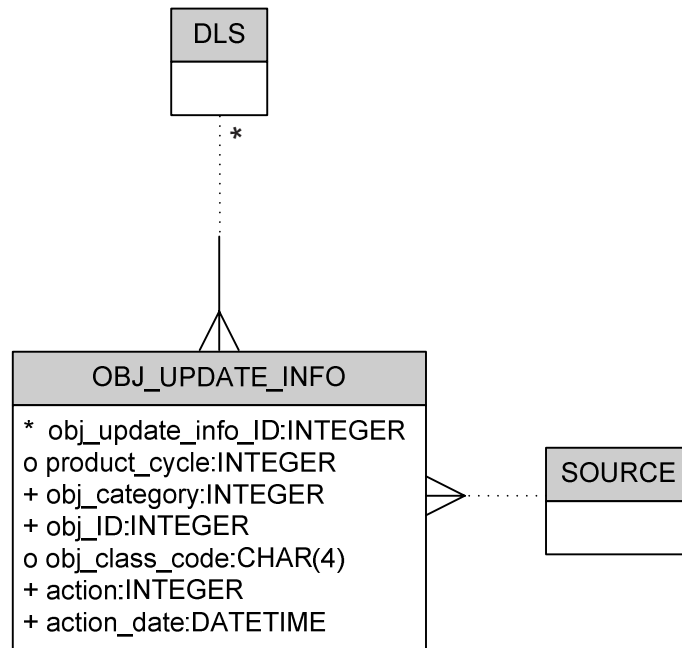

Object Update Information entities are identified by a object update information ID, unique within the DLS which contains the object being updated.

The object category is the Object Category:

- 1 = Point
- 2 = Line
- 3 = Area
- 4 = Complex
- 5 = Relationship
- 6 = Name
- 7 = Time Domain
- 8 = Other Text
- 9 = Geopolitical Structure
- 10 = Geopolitical Structure Component

The object ID is the unique identifier of the updated object. If the object is a Feature, this is the Feature Class Code. Otherwise:

- 0001 = Relationship
- 0002 = Name
- 0003 = Time Domain

0004 = Other Text

0005 = Geopolitical Structure

0006 = Geopolitical Structure Component

The action is the Action Class:

0 = update of source only

1 = New

2 = Delete

3 = Modify

Each Object Update Information may contain the integer source ID representing Source (see 14.4.3.8).

14.10.3.2 Physical Model

```
CREATE TABLE OBJ_UPDATE_INFO
(
  DLS INTEGER,
  OBJ_UPDATE_INFO_ID INTEGER,
  PRODUCT_CYCLE INTEGER,
  OBJ_CATEGORY INTEGER
  CONSTRAINT OBJ_UPDATE_INFO_OBJ_CATEGORY_NOT_NULL
  NOT NULL,
  OBJ_ID INTEGER
  CONSTRAINT OBJ_UPDATE_INFO_OBJ_ID_NOT_NULL
  NOT NULL,
  OBJ_CLASS_CODE CHAR(4),
  ACTION INTEGER
  CONSTRAINT OBJ_UPDATE_INFO_ACTION_NOT_NULL
  NOT NULL,
  ACTION_DATE DATETIME
  CONSTRAINT OBJ_UPDATE_INFO_ACTION_DATE_NOT_NULL
  NOT NULL,
  SOURCE_ID INTEGER,

  CONSTRAINT OBJ_UPDATE_INFO_PRIMARY_KEY
  PRIMARY KEY (DLS, OBJ_UPDATE_INFO_ID),

  CONSTRAINT OBJ_UPDATE_INFO_DLS_EXISTS
  FOREIGN KEY(DLS)
  REFERENCES DLS(DLS),

  CONSTRAINT OBJ_UPDATE_INFO_SOURCE_EXISTS
  FOREIGN KEY(DLS.DATASET_ID, SOURCE_ID)
  REFERENCES SOURCE(DATASET_ID, SOURCE_ID)
)
```

14.10.4 Attribute Update Information

14.10.4.1 Overview

Attribute Update Information describes updates to Attribute Values.

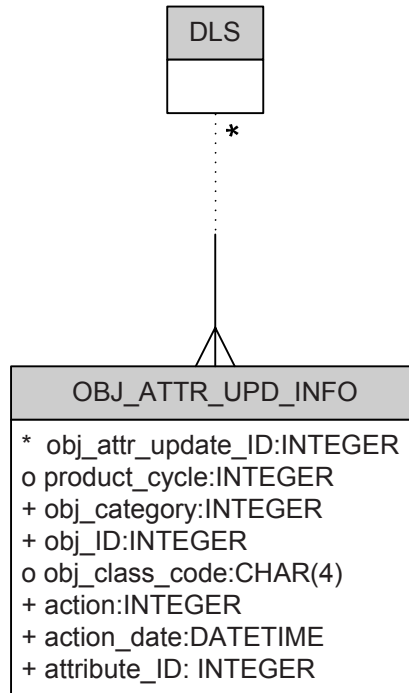

14.10.4.2 Object Attribute Update Information

14.10.4.2.1 Logical Model

Object Attribute Update Information entities are identified by an object attribute update ID, unique within the DLS which contains the object being updated.

All of its Attributes are the same as for Object Update Information entities.

14.10.4.2.2 Physical Model

```

CREATE TABLE OBJ_ATTR_UPD_INFO
(
  DLS INTEGER,
  OBJ_ATTR_UPDATE_ID INTEGER,
  PRODUCT_CYCLE INTEGER,
  OBJ_CATEGORY INTEGER
  CONSTRAINT OBJ_ATTR_UPD_INFO_OBJ_CATEGORY_NOT_NULL
  NOT NULL,
  OBJ_ID INTEGER
  CONSTRAINT OBJ_ATTR_UPD_INFO OBJ_ID_NOT_NULL
  NOT NULL,
  OBJ_CLASS_CODE CHAR(4),
  ACTION INTEGER
  CONSTRAINT OBJ_ATTR_UPD_INFO ACTION_NOT_NULL
  NOT NULL,
  ACTION_DATE DATETIME
)
  
```

```

        CONSTRAINT OBJ_ATTR_UPD_INFO ACTION_DATE_NOT_NULL
        NOT NULL,
    ATTRIBUTE_ID INTEGER
    CONSTRAINT OBJ_ATTR_UPD_INFO ATTRIBUTE_ID_NOT_NULL
    NOT NULL,

    CONSTRAINT OBJ_ATTR_UPD_INFO_PRIMARY_KEY
    PRIMARY KEY (DLS, OBJ_ATTR_UPDATE_ID),

    CONSTRAINT OBJ_ATTR_UPD_INFO_DLS_EXISTS
    FOREIGN KEY(DLS)
    REFERENCES DLS(DLS)
)

```

14.10.4.3 Attribute Value Update Information

The Attribute Value Update Information flags which Attribute Group has been changed for a particular object. This is specified by including the existing Attribute Group's attribute_ID. The DLS of the Attribute Group is the same as the DLS of the Object Attribute Update Information (see 14.8.2).

14.11 Abbreviation

14.11.1 Logical Model

Common cartographic practice often leads to the abbreviation of common words on a map to reduce clutter and make the map more visually appealing. Additionally, users may enter addresses using these abbreviations for geocoding. The Abbreviation Record may be used to describe the common abbreviations for a given language.

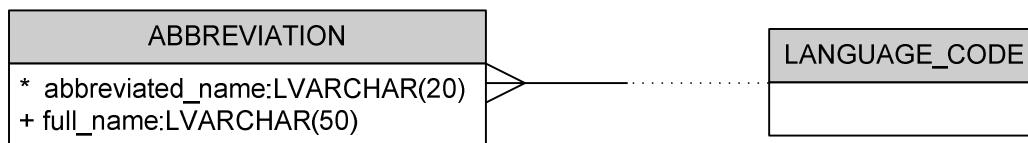

Each Abbreviation is uniquely identified by its abbreviated name. Every Abbreviation must contain the full name which is being abbreviated and must include the three character language code representing the Language (see 14.2.2.4.1) of the full name.

14.11.2 Physical Model

```

CREATE TABLE ABBREVIATION
(
    DLS INTEGER,
    ABBR_STRING INTEGER,
    FULL_NAME_STRING INTEGER,
    LANGUAGE_CODE CHAR(3)
    CONSTRAINT ABBREVIATION_LANGUAGE_CODE_NOT_NULL
    NOT NULL,

    CONSTRAINT ABBREVIATION_PRIMARY_KEY
    PRIMARY KEY (DLS, ABBR_STRING),

    CONSTRAINT ABBREVIATION_ABBR_EXISTS
    FOREIGN KEY(DLS, ABBR_STRING)
    REFERENCES LCS_TEXT(DLS, STRING_ID)
    MATCH FULL,

    CONSTRAINT ABBREVIATION_FULL_NAME_EXISTS

```

*FOREIGN KEY(DLS, FULL_NAME_STRING)
REFERENCES LCS_TEXT(DLS, STRING_ID)
MATCH FULL,*

*CONSTRAINT ABBREVIATION_LANGUAGE_CODE_EXISTS
FOREIGN KEY(LANGUAGE_CODE)
REFERENCES LANGUAGE_CODE(LANGUAGE_CODE)*

)

14.12 Entity/Table indexes

14.12.1 Entities/Tables in SQL Table Name Order

Alphabetical list of Entities/Tables by SQL Table Name and the subclause(s) in which they are fully attributed and defined:

SQL TABLE NAME	ENTITY NAME	SUBCLAUSE
ABBREVIATION	Abbreviation	14.11
ADJ_ORTHO_REF_SYS	Adjacent Orthometric Reference System	14.4.3.5.3
ALBUM	Album	14.4.2.1
ATTR_COMPOSITION	Attribute Composition	14.8.3
ATTR_DATA_TYPE	Attribute Data Type	14.2.2.11.3
ATTR_DATA_UNIT	Attribute Data Unit	14.2.2.11.4
ATTR_TYPE_NAME	Attribute Type Name	14.2.2.11.1
ATTR_VAL_DATA_TYPE	Attribute Value Data Type	14.2.2.11.2
ATTR_VALUE_CODE	Attribute Value Code	14.2.2.12
ATTRIBUTE_DEF	Attribute Definition	14.2.2.11
ATTRIBUTE_GROUP	Attribute Group	14.8.2
CHARACTER_SET	Character Set	14.2.2.4.2
CMP_FEAT_PART_ATTR	(intersect table)	14.8.8
COMPLEX_SPLIT_IND	Complex Split Indicator	14.2.2.20
CONVERSION	Conversion	14.6.4
COUNTRY_CODE	Country	14.2.2.3
DATASET	Dataset	14.4.3.1, 14.4.3.2
DATASET_COUNTRY	(intersect table)	14.4.3.2
DATASET_FEAT_THEME	(intersect table)	14.4.3.2
DATASET_LAN_CODE	(intersect table)	14.4.3.2
DATASET_TITLE	Dataset Title	14.4.3.3
DATASET_TOPIC	Dataset Topic	14.2.2.17
DATUM_ELLIPSOID	Datum and Ellipsoid	14.4.3.5.2
DEFAULT_ATTR_VALUE	Default Attribute Value	14.8.6
DISTRIBUTION_PLACE	Distribution Place	14.4.3.8.4
DLS	Dataset Layer Section	14.2.2.2, 14.4.6
DOCUMENT_TITLE	Document Title	14.4.3.8.2
ELLIPSOID_CODE	Ellipsoid	14.2.2.6
FEATURE_ATTR	(intersect table)	14.8.8
FEATURE_CATEGORY	Feature Category	14.2.2.8
FEATURE_CLASS_HIER	(intersect table)	14.2.2.10
FEATURE_CLASS_CODE	Feature Class	14.2.2.10
FEATURE_CLASS_NAME	Feature Class Name	14.2.2.10
FEATURE_THEME_CODE	Feature Theme	14.2.2.9
FIELD_DATA_CAPTURE	Field Data Capture	14.4.3.8.6
GEO_STR_DEF	Geopolitical Structure Definition	14.5.3
GEO_TOPO_UPDATE_INFO	Geo-Topo Update Information	14.10.2
GEOID_UNDULATION	Geoid Undulation	14.4.3.5.6
GRID_CODE	Grid	14.2.2.13
GS_CONTAINMENT	Geopolitical Structure Containment	14.5.3

SQL TABLE NAME	ENTITY NAME	SUBCLAUSE
GSD_COMP_CONT_HIER	(intersect table)	14.5.3
GSD_COMP_HIER	(intersect table)	14.5.3
GSD_COMPONENT	Geopolitical Structure Definition Component	14.5.3
GSD_COMPONENT_NAME	Geopolitical Structure Definition Component Name	14.5.3
HORIZ_DATUM_CODE	Horizontal Datum	14.2.2.5
HOST_DOCUMENT	Host Document	14.4.3.8.5
LANGUAGE_CODE	Language	14.2.2.4.1
LAYER	Layer	14.4.4
LAYER_FEAT_THEME	(intersect table)	14.4.4
LCHAR_SET_LAN_CODE	(intersect table)	14.2.2.4.3
LCS_TEXT	Local Character Set Text	14.2.2.4.4
LOCAL_CHAR_SET	Local Character Set	14.2.2.4.3
MAGNETIC_FIELD	Earth Magnetic Field	14.4.3.5.7
NATIONAL_GRID	National Map Grid	14.4.3.5.5
NET_AREA_FEATURE	Non-Explicit Topology Area Feature	14.6.1, 14.6.2.4.4
NET_COMP_FEAT_PART	Non-Explicit Complex Feature Part	14.6.3.4
NET_COMP_FEATURE	Non-Explicit Complex Feature	14.6.1, 14.6.3.4
NET_DOT_VERTEX	Non-Explicit Topology Dot Vertex	14.6.2.2.4
NET_LINE_FEATURE	Non-Explicit Topology Line Feature	14.6.1, 14.6.2.3.4
NET_POINT_FEATURE	Non-Explicit Topology Point Feature	14.6.1, 14.6.2.2.4
NET_POLYLIN_VERTEX	Non-Explicit Topology Polyline Vertex	14.6.2.3.4
NET_POLYGON_VERTEX	Non-Explicit Topology Polygon Vertex	14.6.2.4.4
network.ST_LINK	Non-Planar Connectivity Link	14.6.2.3.3, 14.14.3.3
network.ST_NODE	Non-Planar Connectivity Node	14.6.2.2.3, 14.6.2.3.3, 14.14.3.2
NETWORK_SPEC	Network Specification	14.4.3.6
NPC_AREA_FEATURE	Non-Planar Connectivity Area Feature	14.6.1, 14.6.2.4.3
NPC_AREA_TOPO_PRIM	Non-Planar Connectivity Area Topology Primitive	14.6.2.4.3
NPC_COMP_FEAT_PART	Non-Planar Connectivity Complex Feature Part	14.6.3.3
NPC_COMP_FEATURE	Non-Planar Connectivity Complex Feature	14.6.1, 14.6.3.3
NPC_LINE_FEATURE	Non-Planar Connectivity Line Feature	14.6.1, 14.6.2.3.3
NPC_LINE_TOPO_PRIM	Non-Planar Connectivity Line Topology Primitive	14.6.2.3.3
NPC_POINT_FEATURE	Non-Planar Connectivity Point Feature	14.6.1, 14.6.2.2.3
OBJ_ATTR_UPD_INFO	Object Attribute Update Information	14.10.4.1, 14.10.4.2
OBJ_UPDATE_INFO	Object Update Information	14.10.3
OBJECT_REFERENCE	Object Reference	14.9
PF_AREA_FEATURE	Planar Full Area Feature	14.6.1, 14.6.2.4.2
PF_AREA_TOPO_PRIM	Planar Full Area Topology Primitive	14.6.2.4.2
PF_COMP_FEAT_PART	Planar Full Complex Feature Part	14.6.3.2
PF_COMP_FEATURE	Planar Full Complex Feature	14.6.1, 14.6.3.2
PF_LINE_FEATURE	Planar Full Line Feature	14.6.1, 14.6.2.3.2
PF_LINE_TOPO_PRIM	Planar Full Line Topology Primitive	14.6.2.3.2
PF_POINT_FEATURE	Planar Full Point Feature	14.6.1, 14.6.2.2.2
POINT_FEATURE	Point Feature	14.6.1, 14.6.2.2.1
PRODUCER	Dataset Producer	14.4.3.4
PRODUCER_ROLE	Producer Role	14.2.2.18
PROJ_TYPE_CODE	Projection Type	14.2.2.14
PROJECTION	Projection	14.4.3.5.4
PROJECTION_PARAM	Projection Parameter	14.4.3.5.4
PUBLICATION_PLACE	Publication Place	14.4.3.8.3
REL_ROLE_FEAT_CLAS	(intersect table)	14.2.2.16
RELATION_FEAT_ATTR	(intersect table)	14.8.8
RELATION_TYPE_CODE	Relationship Type	14.2.2.15

SQL TABLE NAME	ENTITY NAME	SUBCLAUSE
RELATION_TYPE_NAME	Relationship Type Name	14.2.2.15
RELATIONSHIP	Relationship	14.7.1
RELATIONSHIP_ATTR	(intersect table)	14.8.8
RELATIONSHIP_FEAT	Relationship Feature	14.7.1, 14.7.5,
RELATIONSHIP_ROLE	Relationship Role	14.2.2.16
REMOTE_ATTR_VALUE	Remote Attribute Value	14.8.1, 0
SECTION	Section	14.4.5.1
SECTION_GEOID	(intersect table)	14.4.5.1
SECTION_MAG_FIELD	(intersect table)	14.4.5.1
SECTION_SOURCE	(intersect table)	14.4.5.1
SOURCE	Data Source	14.4.3.8.1
SOURCE_COUNTRY	(intersect table)	14.4.3.8.1
SOURCE_LAN_CODE	(intersect table)	14.4.3.8.1
SPLIT_INDICATOR	Split Indicator	14.2.2.19
TEXT_ATTR	(intersect table)	14.8.8
TIME_DOMAIN	Time Domain	14.5.2
topology.ST_EDGE	Planar Full Edge	14.6.2.3.2, 14.14.2.3
topology.ST_FACE	Planar Full Face	14.6.2.4.2, 14.14.2.4
topology.ST_NODE	Planar Full Node	14.6.2.2.2, 14.14.2.2
TOPOLOGY_TYPE	Topology Type	14.3
VERT_DATUM_CODE	Vertical Datum Code	14.2.2.7
VERTICAL_DATUM	Vertical Datum	14.4.3.5.3
XY_CONTROL_PT	Section XY Control Point	14.4.5.10
Z_CONTROL_PT	Section Z Control Point	14.4.5.11
(no 1:1 table correspondence)	Area Feature	14.6.1, 14.6.2.4.1
(no 1:1 table correspondence)	Attribute Value	14.8.1
(no 1:1 table correspondence)	Complex Feature	14.6.1, 14.6.3.1
(no 1:1 table correspondence)	Feature	14.6.1
(no 1:1 table correspondence)	Line Feature	14.6.1, 14.6.2.3.1
(no 1:1 table correspondence)	Local Attribute Value	14.8.1
(no 1:1 table correspondence)	Non-Explicit Topology Dot	14.6.2.2.4
(no 1:1 table correspondence)	Non-Explicit Topology Polyline	14.6.2.3.4
(no 1:1 table correspondence)	Non-Explicit Topology Polygon	14.6.2.4.4
(no 1:1 table correspondence)	Text	14.5.1

14.12.2 Entities/Tables in Entity Name Order

Alphabetical list of Entities/Tables by Entity Name and the subclause(s) in which they are fully attributed and defined:

SQL TABLE NAME	ENTITY NAME	SUBCLAUSE
ABBREVIATION	Abbreviation	14.11
ADJ_ORTHO_REF_SYS	Adjacent Orthometric Reference System	14.4.3.5.3
ALBUM	Album	14.4.2.1
(no 1:1 table correspondence)	Area Feature	14.6.1, 14.6.2.4.1
ATTR_COMPOSITION	Attribute Composition	14.8.3
ATTR_DATA_TYPE	Attribute Data Type	14.2.2.11.3
ATTR_DATA_UNIT	Attribute Data Unit	14.2.2.11.4
ATTRIBUTE_DEF	Attribute Definition	14.2.2.11
ATTRIBUTE_GROUP	Attribute Group	14.8.2
ATTR_TYPE_NAME	Attribute Type Name	14.2.2.11.1
(no 1:1 table correspondence)	Attribute Value	14.8.1, 14.8.4
ATTR_VALUE_CODE	Attribute Value Code	14.2.2.12
ATTR_VAL_DATA_TYPE	Attribute Value Data Type	14.2.2.11.2
CHARACTER_SET	Character Set	14.2.2.4.2

SQL TABLE NAME	ENTITY NAME	SUBCLAUSE
(no 1:1 table correspondence)	Complex Feature	14.6.1, 14.6.3.1
COMPLEX_SPLIT_IND	Complex Split Indicator	14.2.2.20
CONVERSION	Conversion	14.6.4
COUNTRY_CODE	Country	14.2.2.3
SOURCE	Data Source	14.4.3.8.1
DATASET	Dataset	14.4.3.1, 14.4.3.2
DLS	Dataset Layer Section	14.2.2.2, 14.4.6
PRODUCER	Dataset Producer	14.4.3.4
DATASET_TOPIC	Dataset Topic	14.2.2.17
DATASET_TITLE	Dataset Title	14.4.3.3
DATUM_ELLIPSOID	Datum and Ellipsoid	14.4.3.5.2
DEFAULT_ATTR_VALUE	Default Attribute Value	14.8.6
DISTRIBUTION_PLACE	Distribution Place	14.4.3.8.4
DOCUMENT_TITLE	Document Title	14.4.3.8.2
MAGNETIC_FIELD	Earth Magnetic Field	14.4.3.5.7
ELLIPSOID_CODE	Ellipsoid	14.2.2.6
(no 1:1 table correspondence)	Feature	14.6.1
FEATURE_CATEGORY	Feature Category	14.2.2.8
FEATURE_CLASS_CODE	Feature Class	14.2.2.10
FEATURE_CLASS_NAME	Feature Class Name	14.2.2.10
FEATURE_THEME_CODE	Feature Theme	14.2.2.9
FIELD_DATA_CAPTURE	Field Data Capture	14.4.3.8.6
GEOID_UNDULATION	Geoid Undulation	14.4.3.5.6
GS_CONTAINMENT	Geopolitical Structure Containment	14.5.3
GEO_STR_DEF	Geopolitical Structure Definition	14.5.3
GSD_COMPONENT	Geopolitical Structure Definition Component	14.5.3
GSD_COMPONENT_NAME	Geopolitical Structure Definition Component Name	14.5.3
GEO_TOPO_UPDATE_INFO	Geo-Topo Update Information	14.10.2
GRID_CODE	Grid	14.2.2.13
HORIZ_DATUM_CODE	Horizontal Datum	14.2.2.5
HOST_DOCUMENT	Host Document	14.4.3.8.5
LANGUAGE_CODE	Language	14.2.2.4.1
LAYER	Layer	14.4.4
(no 1:1 table correspondence)	Line Feature	14.6.1, 14.6.2.3.1
(no 1:1 table correspondence)	Local Attribute Value	14.8.1, 14.8.4
LOCAL_CHAR_SET	Local Character Set	14.2.2.4.3
LCS_TEXT	Local Character Set Text	14.2.2.4.4
NATIONAL_GRID	National Map Grid	14.4.3.5.5
NETWORK_SPEC	Network Specification	14.4.3.6
NET_COMP_FEATURE	Non-Explicit Complex Feature	14.6.1, 14.6.3.4
NET_COMP_FEAT_PART	Non-Explicit Complex Feature Part	14.6.3.4
NET_AREA_FEATURE	Non-Explicit Topology Area Feature	14.6.1, 14.6.2.4.4
(no 1:1 table correspondence)	Non-Explicit Topology Dot	14.6.2.114.6.2.2.4
NET_DOT_VERTEX	Non-Explicit Topology Dot Vertex	14.6.2.2.4
NET_LINE_FEATURE	Non-Explicit Topology Line Feature	14.6.1, 14.6.2.3.4
NET_POINT_FEATURE	Non-Explicit Topology Point Feature	14.6.1, 14.6.2.2.4
(no 1:1 table correspondence)	Non-Explicit Topology Polygon	14.6.2.4.4
NET_POLYGON_VERTEX	Non-Explicit Topology Polygon Vertex	14.6.2.4.4
(no 1:1 table correspondence)	Non-Explicit Topology Polyline	14.6.2.3.4
NET_POLYLIN_VERTEX	Non-Explicit Topology Polyline Vertex	14.6.2.3.4
NPC_AREA_FEATURE	Non-Planar Connectivity Area Feature	14.6.1, 14.6.2.4.3
NPC_AREA_TOPO_PRIM	Non-Planar Connectivity Area Topology Primitive	14.6.2.4.3
NPC_COMP_FEATURE	Non-Planar Connectivity Complex Feature	14.6.1, 14.6.3.3
NPC_COMP_FEAT_PART	Non-Planar Connectivity Complex Feature Part	14.6.3.3

SQL TABLE NAME	ENTITY NAME	SUBCLAUSE
NPC_LINE_FEATURE	Non-Planar Connectivity Line Feature	14.6.1, 14.6.2.3.3
NPC_LINE_TOPO_PRIM	Non-Planar Connectivity Line Topology Primitive	14.6.2.3.3
network.ST_LINK	Non-Planar Connectivity Link	14.6.2.3.3, 14.14.3.3
network.ST_NODE	Non-Planar Connectivity Node	14.6.2.2.3, 14.6.2.3.3, 14.14.3.2
NPC_POINT_FEATURE	Non-Planar Connectivity Point Feature	14.6.1, 14.6.2.2.3
OBJ_ATTR_UPD_INFO	Object Attribute Update Information	14.10.4.1, 14.10.4.2
OBJECT_REFERENCE	Object Reference	14.9
OBJ_UPDATE_INFO	Object Update Information	14.10.3
PF_AREA_FEATURE	Planar Full Area Feature	14.6.1, 14.6.2.4.2
PF_AREA_TOPO_PRIM	Planar Full Area Topology Primitive	14.6.2.4.2
PF_COMP_FEATURE	Planar Full Complex Feature	14.6.1, 14.6.3.2
PF_COMP_FEAT_PART	Planar Full Complex Feature Part	14.6.3.2
topology.ST_EDGE	Planar Full Edge	14.6.2.3.2, 14.14.2.3
topology.ST_FACE	Planar Full Face	14.6.2.4.2, 14.14.2.4
PF_LINE_FEATURE	Planar Full Line Feature	14.6.1, 14.6.2.3.2
PF_LINE_TOPO_PRIM	Planar Full Line Topology Primitive	14.6.2.3.2
topology.ST_NODE	Planar Full Node	14.6.2.2.2, 14.14.2.2
PF_POINT_FEATURE	Planar Full Point Feature	14.6.1, 14.6.2.2.2
POINT_FEATURE	Point Feature	14.6.1, 14.6.2.2.1
PRODUCER_ROLE	Producer Role	14.2.2.18
PROJECTION	Projection	14.4.3.5.4
PROJECTION_PARAM	Projection Parameter	14.4.3.5.4
PROJ_TYPE_CODE	Projection Type	14.2.2.14
PUBLICATION_PLACE	Publication Place	14.4.3.8.3
RELATIONSHIP	Relationship	14.7.1
RELATIONSHIP_FEAT	Relationship Feature	14.7.1, 14.7.5,
RELATIONSHIP_ROLE	Relationship Role	14.2.2.16
RELATION_TYPE_CODE	Relationship Type	14.2.2.15
RELATION_TYPE_NAME	Relationship Type Name	14.2.2.15
REMOTE_ATTR_VALUE	Remote Attribute Value	14.8.1, 0
SECTION	Section	14.4.5.1
XY_CONTROL_PT	Section XY Control Point	14.4.5.10
Z_CONTROL_PT	Section Z Control Point	14.4.5.11
SPLIT_INDICATOR	Split Indicator	14.2.2.19
(no 1:1 table correspondence)	Text	14.5.1
TIME_DOMAIN	Time Domain	14.5.2
TOPOLOGY_TYPE	Topology Type	14.3
VERTICAL_DATUM	Vertical Datum	14.4.3.5.3
VERT_DATUM_CODE	Vertical Datum Code	14.2.2.7
CMP_FEAT_PART_ATTR	(intersect table)	14.8.8
DATASET_COUNTRY	(intersect table)	14.4.3.2
DATASET_FEAT_THEME	(intersect table)	14.4.3.2
DATASET_LAN_CODE	(intersect table)	14.4.3.2
FEATURE_ATTR	(intersect table)	14.8.8
FEATURE_CLASS_HIER	(intersect table)	14.2.2.10
GSD_COMP_CONT_HIER	(intersect table)	14.5.3
GSD_COMP_HIER	(intersect table)	14.5.3
LAYER_FEAT_THEME	(intersect table)	14.4.4
LCHAR_SET_LAN_CODE	(intersect table)	14.2.2.4.3
REL_ROLE_FEAT_CLAS	(intersect table)	14.2.2.16
RELATION_FEAT_ATTR	(intersect table)	14.8.8
RELATIONSHIP_ATTR	(intersect table)	14.8.8
SECTION_GEOID	(intersect table)	14.4.5.1
SECTION_MAG_FIELD	(intersect table)	14.4.5.1

SQL TABLE NAME	ENTITY NAME	SUBCLAUSE
SECTION_SOURCE	(intersect table)	14.4.5.1
SOURCE_COUNTRY	(intersect table)	14.4.3.8.1
SOURCE_LAN_CODE	(intersect table)	14.4.3.8.1
TEXT_ATTR	(intersect table)	14.8.8

14.13 Entity Relationship diagram conventions

14.13.1 Introduction

Entity Relationship Diagrams (ERD) are typically used to define the Logical Model for designing Relational Databases. Unfortunately, there are no formal standards for ERDs like there is for UML. Though there is consistency in the basic concepts, the graphic style has many dialects. Therefore, the conventions used in this clause are explained in this sub-clause. They are roughly based on conventions found in [34] but with some modifications.

14.13.2 Definitions

14.13.2.1 Overview

Each concept is defined in terms of an SQL Logical Model, how it is shown in an ERD, the closest similar concept from UML, how the UML approach is diagrammed in a UML Class Diagram, and how the concept is typically implemented during physical SQL design.

14.13.2.2 Entity

14.13.2.2.1 Overview

Something of significance about which information needs to be kept.

Shown as a two-compartment (entity name, attributes) rectangle in an ERD.



Similar to Class in UML except without operations.

Shown as a three-compartment (class name, attributes, operations) rectangle in a UML Class Diagram.

Typically implemented as a Table in physical database design.

14.13.2.2.2 Entity instance

A particular instance of an entity.

Typically not shown on an ERD.

Similar to Object in UML.

Typically not shown on a UML Class Diagram.

Typically implemented as a Row in a Table in physical database design.

14.13.2.2.3 Subentities

Entities which have common attributes and/or relationships but which differ in other attributes and/or relationships.

Shown as an entity rectangle inside the supertype entity rectangle in an ERD with the common attributes in the outer rectangle, the common relationships touching the outer rectangle, the subentity-specific attributes in the inner the subentity rectangle, and the subentity-only relationships touching the inner subentity rectangle.

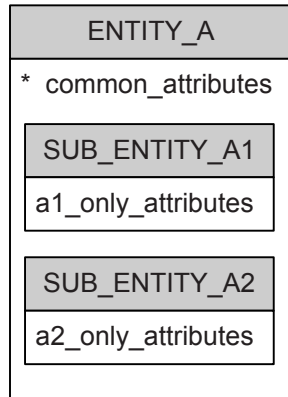

Similar to Subclass in UML except without operations.

Shown as an association between Classes with a triangle symbol pointing towards the supertype in a UML Class Diagram.

Can now be implemented using sub-tables in SQL physical database design, except that not all vendors offer this capability yet. Other options include:

- 1) a single table can be used with non-null columns for mandatory root-type attributes, a column to specify the subtype's type, and nullable columns for all optional root-type entity attributes and all subtype possible subtype attributes.
- 2) one table for the supertype and all common attributes plus separate tables for each of the subtypes and their specialized attributes. These subtype tables will also need to include a foreign key column(s) referencing the supertype table. Each subtype instance is thereby split across a number of tables equal to the number of levels in the type hierarchy.
- 3) one table for each subtype which includes columns for that subtype's attributes plus columns for each of the common attributes from any of its supertypes.

Each option has advantages and disadvantages. One limitation of the SQL language is that column and table names cannot be specified using variables unless you embed SQL in a higher level language. Another is that you can union select statements to collect rows from different tables, but only if the select statements return columns of the same type.

14.13.2.3 Attribute

14.13.2.3.1 Overview

A piece of information kept about an entity.

Listed in the second compartment of the Entity rectangle in an ERD.

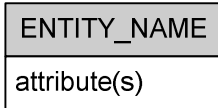

The full list of Attributes of an Entity is typically shown only on a single diagram. Thereafter, just its uniqueness attributes may be shown.

Similar to Attributes in UML.

Listed in the second compartment of the Class rectangle in a UML Class Diagram.

Typically implemented as a Column in a Table in physical database design.

14.13.2.3.2 Uniqueness attribute(s)

The value(s) of these attributes must be different for each instance of the entity.

Attribute name preceded with an asterisk (*) in an ERD.

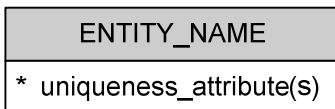

Not distinguished in UML.

Typically implemented as a Primary Key in a Table in physical database design.

14.13.2.3.3 Mandatory attribute

There must be one value for this attribute for each instance of the entity.

Attribute name preceded with an plus sign (+) in an ERD.

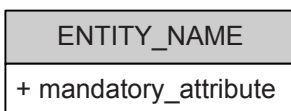

Specified by a multiplicity starting at 1 (one) in UML.

Attribute name succeeded by the multiplicity in square brackets in a UML Class Diagram.

Typically specified as a NOT NULL Column in a Table in physical database design. SQL (in First Normal Form) does not support multiple values for an attribute Column so the multiple values instead will appear in another Table, each in the same Column but a different Row.

14.13.2.3.4 Optional attribute

There may be a value for this attribute for each instance of the entity.

Attribute name preceded with a lower case letter "o" in an ERD.

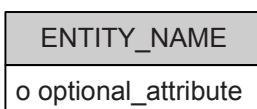

Specified by a multiplicity starting at 0 (zero) in UML.

Attribute name succeeded by the multiplicity in square brackets in a UML Class Diagram.

Typically implemented as a Column in a Table without a NOT NULL constraint in physical database design.

14.13.2.3.5 Attribute data type

The type of data for values of an attribute (e.g., integer, character string, date, etc.)

Follows the attribute name, separated by a colon (:) in an ERD.

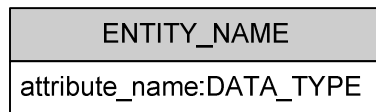

Similar to Simple Attribute data types in UML (see Joins).

Follows the attribute name, separated by a colon (:) in a UML Class Diagram.

Typically implemented as the data type of the Attribute's Column in a Table in physical database design.

14.13.2.4 Relationship

14.13.2.4.1 Overview

An association between two (or more) entities.

Shown as solid or dashed line connecting the Entity rectangles, with or without a crow's foot at either or both ends in an ERD.

Similar to associations in UML but not directed nor aggregation/composition.

Shown as a line connecting the Class rectangles, adorned with arrows for directionality or diamonds for aggregation/composition in a UML Class Diagram.

Typically implemented by Joining Tables at run time but requires embedding the second entity's uniqueness attribute(s) in the first entity's Table during database design.

14.13.2.4.2 Optionality

Whether or not all instances of Entity B must be related to at least one instance of Entity A.

The half of the association line closest to Entity B is solid if mandatory; dashed if optional in an ERD.

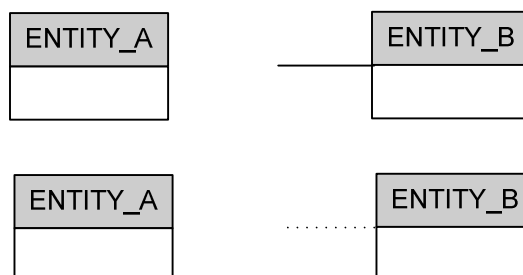

Specified by an association multiplicity starting at 0 (zero) for optional; greater than zero for mandatory in UML.

The multiplicity would be shown on the A side of the association in a UML Class Diagram.

The Column(s) in the Table for Entity A which corresponds to the uniqueness attribute Column(s) in the Table for Entity B would be labeled as NOT NULL if the association is mandatory in physical database design.

14.13.2.4.3 Multiplicity

Whether or not multiple instances of Entity A can be related to a single instance of Entity B.

The existence of a crow's foot at the Entity A side of the relationship in an ERD.

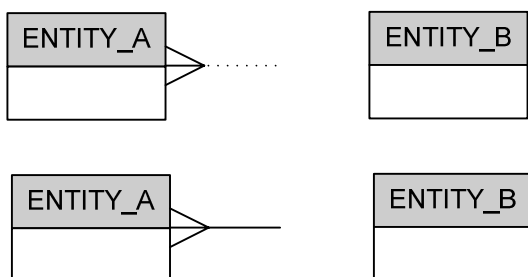

Specified by an association multiplicity greater than 0 (zero) in UML.

The multiplicity would be shown on the A side of the association in a UML Class Diagram.

In physical database design, each Row in the Table for Entity A that represents an instance that is related to Entity B would contain the uniqueness attribute Column(s) from the Table for Entity B.

The relationship can be many to many (each A may/must relate to many B's and each B may/must relate to many A's).

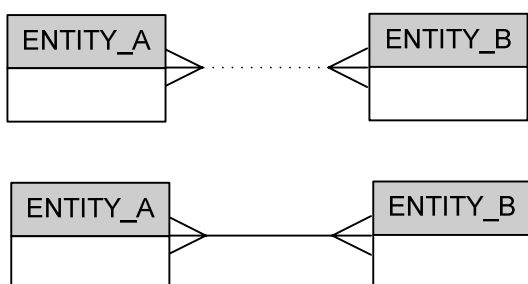

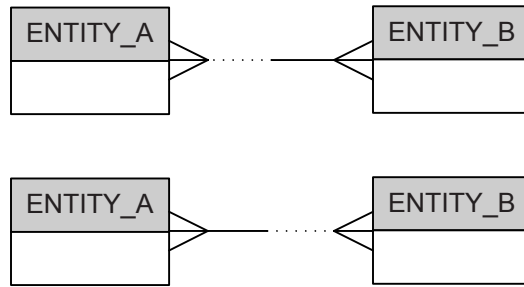

When appearing on an ERD, this should always be questioned. It is usually the case that there is additional information about the relationship itself (not about either of the entities individually). If this is the case, the appropriate solution is to add an additional (intersect) entity which will eliminate the many-to-many associations and will be a place where the relationship attributes can go.

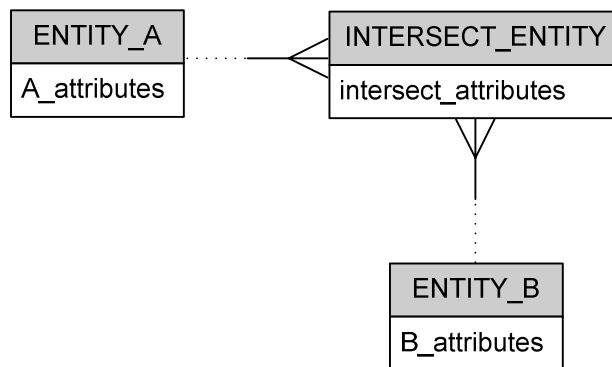

In this case, an additional (intersect) Table is required whose Columns would contain the uniqueness attribute Column(s) from the Tables for Entities A and B plus any additional columns for information about the relationship itself (intersect attributes).

As it turns out, if there are no intersect attributes, the Intersect Entity is not shown on the ERD, the many-to-many association is kept, but the physical design will still necessitate the additional Intersect Table. The Table will only contain the respective uniqueness attributes from A and B.

14.13.2.4.4 Multiple relationships

It is possible to have more than one distinct relationship between two Entities.

Multiple relationship lines can be shown between the two Entity rectangles and text labels are used to distinguish the relationships in an ERD.

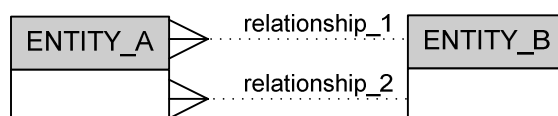

Similar situation can exist in UML.

The multiple association lines will have role names to distinguish them in a UML Class Diagram.

In physical database design, there would be multiple sets of Columns in the Table for the first Entity such that each set matches the set of uniqueness attribute Column(s) from the Table for the other Entity. The differing Column names in the first Table can be used to distinguish the relationships.

14.13.2.4.5 Exclusive OR

A relationship may apply between either Entity A and Entity B or between Entity A and Entity C, but not both.

Both relationship lines are shown but with an overlaid arc in an ERD.

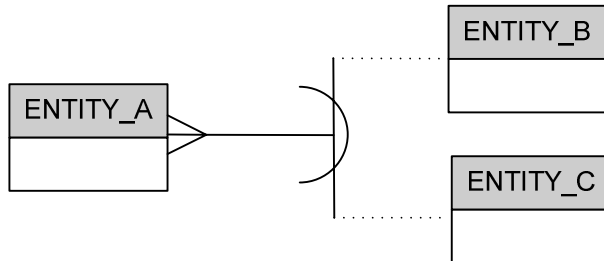

A similar situation can arise in UML.

For GDF, the ISO/TC 211 convention of introducing a Class with a stereotype of Union is used in a UML Class Diagram.

These are not easy to implement with SQL. You have choices similar to subtypes but are limited in what SQL will allow you to select.

14.13.2.4.6 Self relationships

A relationship may apply between two instances of the same Entity

This is shown as a “pig's ear” in an ERD.

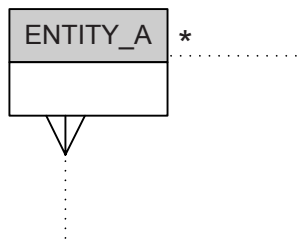

A similar situation can arise in UML.

For physical database design, the uniqueness attributes of Entity A will appear twice in the Table, with the actual Column names distinguishing the two roles.

14.13.2.5 Extending uniqueness

As long as the sum of the uniqueness attributes within a single Entity uniquely identify a single instance of the Entity in the entire database, then the approach suggested above in 14.13.2.3.2 is acceptable. But this is not always the case. In GDF or example, the layer ID is the uniqueness attribute for Layers, but it is only unique within a single Dataset. So there could be two Layers with a layer ID = 1 in the Album. To uniquely identify one of them, it is also necessary to include the Dataset's uniqueness attribute, the dataset ID.

This is shown by adding an asterisk (*) to the end of the relationship line in an ERD:

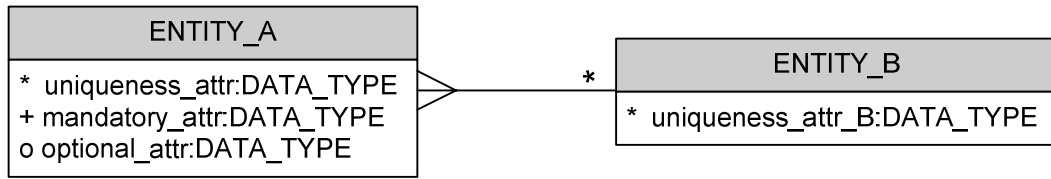

To uniquely identify an instance of Entity A within the entire database, the uniqueness attribute(s) from the instance of Entity B related to the instance of Entity A must also be stated.

Extending uniqueness can be transitive. For example, a GDF Section's section ID is only unique within a Layer whose layer ID is only unique within a Dataset. Therefore, the uniqueness attribution of a Section will require the section ID, layer ID, and dataset ID.

When adding Entity B's uniqueness attribute to the Table for Entity A, the attribute name from Entity B is used unless specified otherwise as follows (though this is usually a physical design decision and therefore may not be apparent at logical design time for the ERD to show:

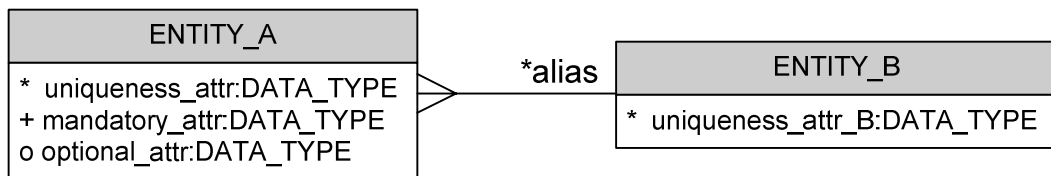

14.13.3 Relationship combinations

14.13.3.1 Overview

Because relationships can exist in both directions, ERDs split the relationship line in half. Each half can be either dashed (optional) or solid (mandatory) and with (meaning many) or without (meaning at most one) a crow's foot. This results in numerous possible combinations. UML combines these two notions of optionality and cardinality into a numeric label which is more intuitive than having to remember what linestyles mean.

To simplify the interpretation of ERD relationships, Oracle [34] suggests constructing a sentence of uniform construction for reading the relationship in either direction. It is:

"Each <entity A> {must | may} be associated with {one or more | one and only one} <entity B>"

Reading from Entity A towards Entity B, the "must" or "may" choice is dictated by the first half of the line being solid or dashed, respectively. When arriving at Entity B, if there is a crow's foot, the choice is "one or more", else it is "one and only one". And then of course, the relationship can be read in the reverse direction.

Usually "associated with" is replaced by a more meaningful relationship name, similar to role names in UML. Since the name would be different depending on the direction of traversing the relationship line, the name is written nearest the farther entity. These have not been used in this clause.

The relationship combinations likely to be found in this document are shown below, together with the wording and equivalent UML multiplicities.

14.13.3.2 Many-to-many relationships

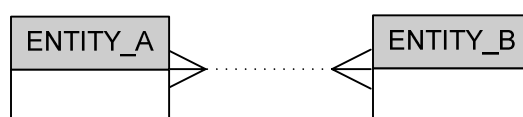

Each entity A may be associated with one or more entity B's. [0..*]

Each entity B may be associated with one or more entity A's. [0..*]

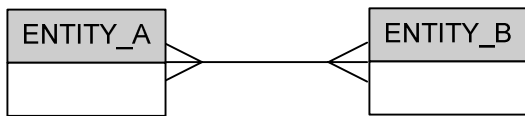

Each entity A must be associated with one or more entity B's. [1..*]

Each entity B must be associated with one or more entity A's. [1..*]

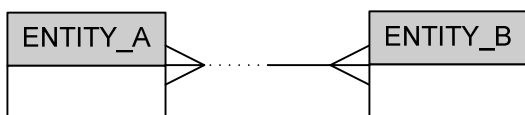

Each entity A may be associated with one or more entity B's. [0..*]

Each entity B must be associated with one or more entity A's. [1..*]

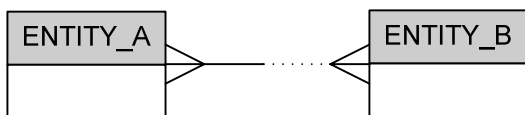

Each entity A must be associated with one or more entity B's. [1..*]

Each entity B may be associated with one or more entity A's. [0..*]

14.13.3.3 One-to-many (or many-to-one) relationships

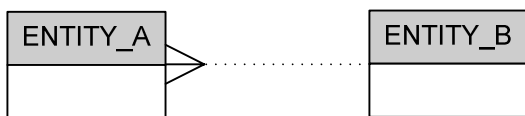

Each entity A may be associated with one and only one entity B. [0..1]

Each entity B may be associated with one or more entity A's. [0..*]

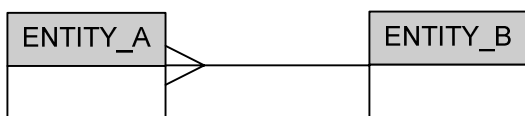

Each entity A must be associated with one and only one entity B. [1]

Each entity B must be associated with one or more entity A's. [1..*]

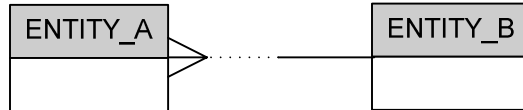

Each entity A may be associated with one and only one entity B. [0..1]

Each entity B must be associated with one or more entity A's. [1..*]

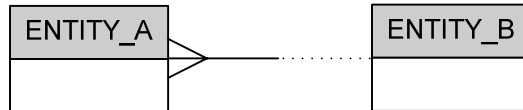

Each entity A must be associated with one and only one entity B. [1]

Each entity B may be associated with one or more entity A's. [0..*]

14.13.3.4 One-to-one relationships



Each entity A may be associated with one and only one entity B. [0..1]

Each entity B may be associated with one and only one entity A. [0..1]

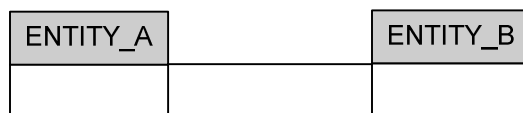

Each entity A must be associated with one and only one entity B. [1]

Each entity B must be associated with one and only one entity A. [1]

The last two examples are rarely found in an ERD and should be challenged. It is possible that Entity B attributes could be attributes of Entity A and Entity B is not needed.

This may not necessarily be the case. In Third Normal Form, all attributes of Entity A must be functionally dependent only upon all of the uniqueness attributes of Entity A. If some are functionally dependent upon the uniqueness attributes of Entity B instead, then Entity B is appropriately shown with the one-to-one relationship to Entity A.

14.14 SQL/MM base tables for Topology and Network

14.14.1 General

The SQL DDL for the base SQL/MM topology/network Tables is included for reference, as they are adopted from ISO 13249-3 and complemented in the GDF SQL encoding specifications.

14.14.2 Planar Full topology

14.14.2.1 Overview

For GDF PF Features, the topology primitives Node, Edge, and Face are stored in the SQL/MM-defined ST_Node, ST_Edge, and ST_Face base tables, respectively in the ST_TOPO_GEO schema. Each of these tables contains a TOPOLOGY column which contains the name of the planar coverage of which the primitives are a part. This is usually equal to the Section level partitioning in GDF. A schema is then defined having the coverage's <topology-name>. Within each <topology-name> schema, ST_Node, ST_Edge, and ST_Face views are defined on the respective ST_TOPO_GEO schema base tables. These <topology-name> views contain only those Nodes, Edges, and Faces belonging to the <topology-name> schema's coverage (i.e., having a TOPOLOGY value equal to the schema <topology-name>).

14.14.2.2 <topology-name>.ST_Node

The ST_Node base table stores information about planar coverage Nodes used by GDF PF Features. Nodes belonging to a particular coverage can be selected based on the <topology-name> in the TOPOLOGY column. The ST_Node view in the <topology-name> schema is defined on the ST_Node Base Table and only includes those Nodes in the <topology-name> coverage.

```
CREATE TABLE ST_NODE
(
  TOPOLOGY CHARACTER VARYING(ST_MaxTopologyName),
  NODE_ID INTEGER NOT NULL,
  GEOMETRY ST_Point NOT NULL,
  CONTAINING_FACE INTEGER,

  CONSTRAINT ST_NODE_PRIMARY_KEY PRIMARY KEY(TOPOLOGY, NODE_ID),
  CONSTRAINT FACE_EXISTS FOREIGN KEY(TOPOLOGY, CONTAINING_FACE)
    REFERENCES ST_FACE(TOPOLOGY, FACE_ID)
)

CREATE VIEW ST_NODE AS
  SELECT NODE_ID, GEOMETRY, CONTAINING_FACE
  FROM ST_TOPO_GEO.ST_NODE
  WHERE TOPOLOGY = '<topology-name>'
```

14.14.2.3 <topology-name>.ST_Edge

The ST_Edge base table stores information about planar coverage Edges used by GDF PF Features. Edges belonging to a particular coverage can be selected based on the <topology-name> in the TOPOLOGY column. The ST_Edge view in the <topology-name> schema is defined on the ST_Edge Base Table and only includes those Edges in the <topology-name> coverage.

```
CREATE TABLE ST_EDGE
(
  TOPOLOGY CHARACTER VARYING(ST_MaxTopologyName),
  EDGE_ID INTEGER NOT NULL,
  START_NODE INTEGER NOT NULL,
  END_NODE INTEGER NOT NULL,
  NEXT_LEFT_EDGE INTEGER NOT NULL,
  NEXT_RIGHT_EDGE INTEGER NOT NULL,
  LEFT_FACE INTEGER NOT NULL,
  RIGHT_FACE INTEGER NOT NULL,
  GEOMETRY ST_Curve NOT NULL,

  CONSTRAINT ST_EDGE_PRIMARY_KEY PRIMARY KEY(TOPOLOGY, EDGE_ID),
  CONSTRAINT START_NODE_EXISTS FOREIGN KEY(TOPOLOGY, START_NODE)
    REFERENCES ST_NODE(TOPOLOGY, NODE_ID),
```

```

CONSTRAINT END_NODE_EXISTS FOREIGN KEY(TOPOLOGY, END_NODE)
  REFERENCES ST_NODE(TOPOLOGY, NODE_ID),
CONSTRAINT NEXT_LEFT_EDGE_EXISTS
  CHECK (TOPOLOGY, ABS(NEXT_LEFT_EDGE)) IN
  (SELECT TOPOLOGY, EDGE_ID FROM ST_EDGE)),
CONSTRAINT NEXT_RIGHT_EDGE_EXISTS
  CHECK (TOPOLOGY, ABS(NEXT_RIGHT_EDGE)) IN
  (SELECT TOPOLOGY, EDGE_ID FROM ST_EDGE)),
CONSTRAINT LEFT_FACE_EXISTS FOREIGN KEY(TOPOLOGY, LEFT_FACE)
  REFERENCES ST_FACE(TOPOLOGY, FACE_ID),
CONSTRAINT RIGHT_FACE_EXISTS FOREIGN KEY(TOPOLOGY, RIGHT_FACE)
  REFERENCES ST_FACE(TOPOLOGY, FACE_ID)
)

```

```

CREATE VIEW ST_EDGE AS
  SELECT EDGE_ID, START_NODE, END_NODE,
         NEXT_LEFT_EDGE, NEXT_RIGHT_EDGE,
         LEFT_FACE, RIGHT_FACE, GEOMETRY
  FROM ST_TOPO_GEO.ST_EDGE
  WHERE TOPOLOGY = '<topology-name>'

```

14.14.2.4 <topology-name>.ST_Face

The ST_Face base table stores information about planar coverage Edges used by GDF PF Features. Faces belonging to a particular coverage can be selected based on the <topology-name> in the TOPOLOGY column. The ST_Face view in the <topology-name> schema is defined on the ST_Face Base Table and only includes those Faces in the <topology-name> coverage.

```

CREATE TABLE ST_FACE
(
  TOPOLOGY CHARACTER VARYING(ST_MaxTopologyName),
  FACE_ID INTEGER NOT NULL,
  MBR ST_Polygon,

  CONSTRAINT ST_FACE_PRIMARY_KEY PRIMARY KEY(TOPOLOGY, FACE_ID)
)

```

```

CREATE VIEW ST_FACE AS
  SELECT FACE_ID, MBR
  FROM ST_TOPO_GEO.ST_FACE
  WHERE TOPOLOGY = '<topology-name>'

```

14.14.3 Non-Planar Connectivity networks

14.14.3.1 Overview

For GDF NPC Features, using elements of ISO 13249-3, the topology primitives Node and Edge are stored in the SQL/MM-defined ST_Node and ST_Link base tables, respectively in the ST_TOPO_NET schema. Each of these tables contains a NETWORK column which contains the name of the connectivity network of which the primitives are a part. This is usually equal to the Section level partitioning in GDF. A schema is then defined having the network's <network-name>. Within each <network-name> schema, ST_Node and ST_Link views are defined on the respective ST_TOPO_NET schema base tables. These views contain only those Nodes and Edges belonging to the <network-name> schema's connectivity network (i.e., having a NETWORK value equal to the schema <network-name>).

14.14.3.2 <network-name>.ST_Node

The ST_Node base table stores information about planar coverage Nodes used by GDF NPC Features. Nodes belonging to a particular coverage can be selected based on the <network-name> in the NETWORK

column. The ST_Node view in the <network-name> schema is defined on the ST_Node Base Table and only includes those Nodes in the <network-name> connectivity network.

```
CREATE TABLE ST_NODE
(
  NETWORK CHARACTER VARYING(ST_MaxNetworkName),
  NODE_ID INTEGER NOT NULL,
  GEOMETRY ST_Point,

  CONSTRAINT ST_NODE_PRIMARY_KEY PRIMARY KEY(NETWORK, NODE_ID)
)

CREATE VIEW ST_NODE AS
SELECT NODE_ID, GEOMETRY
FROM ST_TOPO_NET.ST_NODE
WHERE NETWORK = '<network-name>'
```

14.14.3.3 <network-name>.ST_Link

The ST_Link base table stores information about planar coverage Edges used by GDF NPC Features. Edges belonging to a particular coverage can be selected based on the <network-name> in the NETWORK column. The ST_Link view in the <network-name> schema is defined on the ST_Link Base Table and only includes those Edges in the <network-name> connectivity network.

```
CREATE TABLE ST_LINK
(
  NETWORK CHARACTER VARYING(ST_MaxNetworkName),
  LINK_ID INTEGER NOT NULL,
  START_NODE INTEGER NOT NULL,
  END_NODE INTEGER NOT NULL,
  GEOMETRY ST_Curve,

  CONSTRAINT ST_LINK_PRIMARY_KEY PRIMARY KEY(NETWORK, LINK_ID),
  CONSTRAINT START_NODE_EXISTS FOREIGN KEY(NETWORK, START_NODE)
  REFERENCES ST_NODE(NETWORK, NODE_ID),
  CONSTRAINT END_NODE_EXISTS FOREIGN KEY(NETWORK, END_NODE)
  REFERENCES ST_NODE(NETWORK, NODE_ID)
)

CREATE VIEW ST_LINK AS
SELECT LINK_ID, START_NODE, END_NODE, GEOMETRY
FROM ST_TOPO_NET.ST_LINK
WHERE NETWORK = '<network-name>'
```

Annex A (normative)

Semantic codes

A.1 Feature Theme and Feature Class Codes

Theme Code	Code	Interpretation
11		Administrative Areas
	1110	Supra-National Area
	1111	Country
	1112	Order-1 Area
	1113	Order-2 Area
	1114	Order-3 Area
	1115	Order-4 Area
	1116	Order-5 Area
	1117	Order-6 Area
	1118	Order-7 Area
	1119	Order-8 Area
	1120	Order-9 Area
	1165	Administrative Place A
	1166	Administrative Place B
	1167	Administrative Place C
	1168	Administrative Place D
	1169	Administrative Place E
	1170	Administrative Place F
	1171	Administrative Place G
	1172	Administrative Place H
	1173	Administrative Place I
	1174	Administrative Place J
	1175	Administrative Place K
	1176	Administrative Place L
	1177	Administrative Place M
	1178	Administrative Place N
	1179	Administrative Place O
	1180	Administrative Place P
	1181	Administrative Place Q
	1182	Administrative Place R
	1183	Administrative Place S
	1184	Administrative Place T
	1185	Administrative Place U
1186	Administrative Place V	
1187	Administrative Place W	
1188	Administrative Place X	
1189	Administrative Place Y	
1190	Administrative Place Z	
1198	Administrative Boundary Junction	
1199	Administrative Boundary Element	

Theme Code	Code	Interpretation
31		Named Areas
	3110	Built-up Area
	3120	Named Area
	3131	Police District
	3132	Emergency Medical Dispatch District
	3133	School District
	3134	Census District
	3135	Fire Dispatch District
	3136	Postal District
	3137	Phone District
	3138	Electoral District
	3198	Boundary Junction
	3199	Boundary Element

Theme Code	Code	Interpretation
41		Roads and Ferries
	4110	Road Element
	4115	Pathway
	4120	Junction
	4130	Ferry Connection
	4135	Enclosed Traffic Area
	4140	Road
	4145	Intersection
	4150	Ferry
	4160	Address Area
	4165	Address Area Boundary Element
	4170	Aggregated Way
	4180	Interchange
4190	Roundabout	

Theme Code	Code	Interpretation
42		Railways
	4210	Railway Element
	4220	Railway Element Junction

Theme Code	Class Code	Interpretation
43		Waterways
	4310	Water Body
	4330	Water Boundary Element
	4335	Water Boundary Junction
	4350	Inland Water
	4351	Reservoir
	4352	Lake
	4353	Water Course
	4354	Canal
	4355	River
	4370	Marine Water
	4371	Coastal Lagoon
	4372	Estuary
4373	Sea and Ocean	

Theme Code	Class Code	Interpretation
48		Linear Datum Feature
	4810	Linear Datum
	4820	Anchor Point
	4830	Anchor Section

Theme Code	Class Code	Interpretation
49		Linear Referencing Features
	4910	Path
	4920	Referent

Theme Code	Class Code	Interpretation
50		Public Transport
	5010	Route Link
	5015	Route Point
	5020	Stop Point
	5025	Public Transport Point
	5030	Stop Area
	5040	Route
	5050	Line
	5060	Taxi Stand

Theme Code	Class Code	Interpretation
60		Terrain Elevation
	6010	TIN Surface
	6020	TIN Triangle
	6030	TIN Node
	6040	TIN Breakline

Theme Code	Class Code	Interpretation
	6050	TIN Stopline
	6060	Contour Line
	6070	Contour Line Area
	6075	Contour Line Point
	6080	Gridded Surface

Theme Code	Class Code	Interpretation
71		Land Cover And Use
	7103	Sidewalk
	7104	Building Façade
	7105	Town Block
	7106	Block Detail
	7107	Building Unit
	7108	Building Detail
	7109	Schematic Building
	7110	Building
	7111	Artificial Surface
	7112	Urban Fabric
	7113	Industrial, Commercial and Transport Unit
	7114	Mine, Dump and Construction Site
	7115	Artificial, Non-Agricultural Vegetation Area
	7116	Continuous Urban Fabric
	7117	Discontinuous Urban Fabric
	7118	Industrial or Commercial Unit
	7119	Road and Rail Network and Associated Land
	7120	Wetland
	7121	Inland Wetland
	7122	Inland Marsh
	7123	Peatbog
	7124	Forested Wetland
	7125	Coastal Wetland
	7126	Salt Marsh
	7127	Saline
	7128	Intertidal Flat
	7129	Pasture and Rangeland
	7130	Port Area
	7131	Airport Area
	7132	Mineral Extraction Site
	7133	Dump Site
	7134	Construction Site
	7135	Green Urban Area
	7136	Sport And Leisure Facility
	7137	Agricultural Area
	7138	Arable Land
	7139	Permanent Crop
	7140	Pasture
	7141	Rangeland
	7142	Heterogeneous Agricultural Area
	7143	Non-Irrigated Arable Land
	7144	Permanently Irrigated Land
	7145	Rice Field
	7146	Vineyard
	7147	Fruit Tree And Berry Plantation
	7148	Olive Grove
	7149	Annual Crop Associated With Permanent Crop
	7150	Complex Cultivation Pattern
	7152	Land Principally Occupied By Agriculture With

Theme Code	Class Code	Interpretation
		Significant Area Of Natural Vegetation
	7153	Agro-Forestry Area
	7154	Forest And Semi-Natural Area
	7155	Forest
	7156	Scrub And/Or Herbaceous Vegetation Association
	7157	Open Space With Little Or No Vegetation
	7158	Broad-Leaved Forest
	7159	Coniferous Forest
	7160	Mixed Forest
	7161	Natural Grassland
	7162	Moor And Heathland
	7163	Sclerophyllous Vegetation
	7164	Transitional Woodland/Scrub
	7165	Beach, Dune And Sand Plain
	7166	Bare Rock
	7167	Sparsely Vegetated Area
	7168	Burnt Area
	7169	Glacier And Perpetual Snow
	7180	Island

Theme Code	Class Code	Interpretation
72		Road Furniture
	7210	Signpost
	7220	Traffic Sign
	7230	Traffic Light
	7240	Pedestrian Crossing
	7245	Complex Pedestrian Crossing
	7251	Environmental Equipment
	7252	Lighting
	7253	Measurement Device
	7254	Road Markings
	7255	Safety Equipment

Theme Code	Class Code	Interpretation
73		Services

Theme Code	Class Code	Interpretation
75		Structures
	7500	Structure

Theme Code	Class Code	Interpretation
80		General Features
	8000	Centre Point of Feature
	8001	Traffic Location
	8002	Entry Point

Theme Code	Class Code	Interpretation
81-99		User-defined Features

A.2 Attribute Type Codes

In the following table, for Attribute Types refer to sub-clause 7.1.1. For Attribute Data Type refer to sub-clause 10.3.5.7.

For Attribute Data Types representing certain units of measure, being either metric, English, or user-defined, the generic 'MSR' code is used. For the Attribute Data Types used to represent percentage attributes, "PRC", and "PRS", the scaling exponent or factor is not explicitly represented in the following tables. Please refer to the Attribute Catalogue (clause 7) for the exact scaling exponent or factor for the Attribute in question.

Attribute Type Name	Attribute Type Code	Attribute Data Type	Attribute Value Name	Attribute Value Code
Accepted Credit Cards	CA	BMR	User defined	Digit 1
			User defined	Digit 2
			User defined	Digit 3
			User defined	Digit 4
			User defined	Digit 5
			User defined	Digit 6
			User defined	Digit 7
			User defined	Digit 8
			User defined	Digit 9
			User defined	Digit 10
			User defined	Digit 11
			Each digit may then take the following values: False True	0 1
Accessibility	Not Applicable	CMP	N/A	N/A
Accessibility Limitation	Not Applicable	CMP	N/A	N/A
Accident	Not Applicable	CMP	N/A	N/A
Accident Date	AT	TMR	N/A	N/A
Accident Identifier	AC	TXT	N/A	N/A
Address Information	Not Applicable	CMP	N/A	N/A

Attribute Type Name	Attribute Type Code	Attribute Data Type	Attribute Value Name	Attribute Value Code
Administrative Boundary Type	BX	ENM	Database Coverage Area Edge	5
			Supra-National	10
			Country	20
			Order-1 Administrative Area	21
			Order-2 Administrative Area	22
			Order-3 Administrative Area	23
			Order-4 Administrative Area	24
			Order-5 Administrative Area	25
			Order-6 Administrative Area	26
			Order-7 Administrative Area	27
			Order-8 Administrative Area	28
			Order-9 Administrative Area	29
			Administrative Place A	65
			Administrative Place B	66
			Administrative Place C	67
			Administrative Place D	68
			Administrative Place E	69
			Administrative Place F	70
			Administrative Place G	71
			Administrative Place H	72
			Administrative Place I	73
			Administrative Place J	74
			Administrative Place K	75
			Administrative Place L	76
			Administrative Place M	77
			Administrative Place N	78
			Administrative Place O	79
			Administrative Place P	80
			Administrative Place Q	81
			Administrative Place R	82
			Administrative Place S	83
			Administrative Place T	84
			Administrative Place U	85
Administrative Place V	86			
Administrative Place W	87			
Administrative Place X	88			
Administrative Place Y	89			
Administrative Place Z	90			
Airport Code	AI	COD	3 Letter codes from Airline Coding Directory [42] or 4-Letter codes from ICAO Location Indicators [44], followed by optional supplementary character	
Alternate Name	Not Applicable	CMP	N/A	N/A
Alternate Name Body	Not Applicable	CMP	N/A	N/A
Alternate Name Text	AN	TXT	N/A	N/A
Alternate Pronunciation	PG	TXT	N/A	N/A
Alternate Street Name	Not Applicable	CMP	N/A	N/A
Alternate Street Name Body	Not Applicable	CMP	N/A	N/A
Alternate Street Name Text	AL	TXT	N/A	N/A
Assignment Order	CK	CNT	N/A	N/A
Association Type	AY	COD	Geographically Located In Commonly Associated With	1 2
Average Vehicle Speed	AS	MSR	N/A	N/A

Attribute Type Name	Attribute Type Code	Attribute Data Type	Attribute Value Name	Attribute Value Code
Block Class Name	BK	TXT	N/A	N/A
Block Grouping	BG	COD	Group 1 Group 2 Group ... Group 99	1 2 ... 99
Block Type	BO	COD	Sub-divisions Line Crossing Line	1 2
Blocked Passage	Not Applicable	CMP	N/A	N/A
Blocked Passage Location	BP	COD	Physically Blocked at Start Junction Physically Blocked at End Junction Physically Blocked between Start and End Junction	1 2 3
Blocked Passage Type	BE	COD	Permanently fixed Removable	1 2
Boundary Type	BY	ENM	Database Coverage Area Edge Built-up Area Named Area Police District Emergency Medical Dispatch District School District Census District Fire Dispatch District Postal District Phone District Elective District	5 10 20 31 32 33 34 35 36 37 38
Brand Name	BN	TXT	N/A	N/A
Breakfast Available	BA	BOL	False True	0 1
Building Class Name	BC	TXT	N/A	N/A
Building Detail Type	BD	COD	Soft Line Hard Line	1 2
Building Storey	BF	TXT	N/A	N/A
Building Storey Count	BS	CNT	N/A	N/A
Business Lunch	BL	BOL	False True	0 1
Car Dealer Type	CD	COD	Sales Facility Repair Facility Sales and Repair Facility	1 2 3
City Centre Administrative Class	CC	ENM	Class 0 Class 1 Class 2 Class 3 Class 4 Class 5 Class 6 Class 7 Class 8 Class 9 Others	0 1 2 3 4 5 6 7 8 9 10
Commercial Airline Service	CM	BOL	False True	0 1
Common Language	CL	COD	ISO 639-2 language code [1]	
Commuter/Regional Railway Station	CR	BOL	False True	0 1
Complex Building Elevation	Not applicable	CMP	N/A	N/A

Attribute Type Name	Attribute Type Code	Attribute Data Type	Attribute Value Name	Attribute Value Code
Composite Alternate Pronunciation	Not applicable	CMP	N/A	N/A
Composite Exit Number	Not Applicable	CMP	N/A	N/A
Composite Form of Way	Not Applicable	CMP	N/A	N/A
Composite Pronunciation	Not Applicable	CMP	N/A	N/A
Conditional Traffic Flow	CF	ENM	Closed Open	0 1
Construction Status	CS	COD	Planned Under Construction – closed Under Construction – open	1 2 3
Correspondence	Not applicable	CMP	N/A	N/A
Correspondence Order	CQ	CNT	N/A	N/A
Continuation Type	CP	COD	Natural Other type of lane transition	0 1
Currency	CU	TXT	N/A	N/A
Departure/Arrival	AD	COD	Departure Arrival Departure and Arrival	1 2 3
Destination of Flight Connection	DC	COD	3 Letter codes from Airline Coding Directory [42] or 4-Letter codes from ICAO Location Indicators [44], followed by optional supplementary character	
Destination Info on Traffic Sign	Not Applicable	CMP	N/A	N/A
Destination Location	DL	TXT	N/A	N/A
Direction Category	DI	BMI	Reserved Ahead Between ahead and right Right Between right and backward Backward (u-turn) Between left and backward Left Between ahead and left Merge into right lane (lane ends) Merge into left lane (lane ends) Merge lanes (no priority lane) Combinations are possible, e.g. the marking of straight ahead and left is stored as 520 (i.e. 8+512).	1.....7 8 16 32 64 128 256 512 1024 2048 4096 8192
Directional Prefix	DP	TXT	N/A	N/A
Directional Suffix	DS	TXT	N/A	N/A
Display Class	DY	COD	First Class Second Class Third Class Fourth Class Fifth Class Sixth Class Seventh Class Eighth Class Ninth Class Tenth Class	1 2 3 4 5 6 7 8 9 10

Attribute Type Name	Attribute Type Code	Attribute Data Type	Attribute Value Name	Attribute Value Code
Distance Expression	Not applicable	CMP	N/A	N/A
Distance Measure	CH	MSR	N/A	N/A
Distance Measure Referent	CI	CNT	N/A	N/A
Divided Road Element	DR	BOL	False True	0 1
Divider	Not Applicable	CMP	N/A	N/A
Divider Colour	DZ	COD	White Yellow	1 2
Divider Height	DH	MSR	N/A	N/A
Divider Impact	DX	COD	Traversable Traversable from right only Traversable from left only Not traversable	1 2 3 4
Divider Marking	DM	COD	No line marking (i.e. no divider) Dashed Line (long line sections) Double solid line Single solid line Double line: combination of (inner) single solid line and (outer) dashed line Double line: combination of (inner) dashed line and (outer) single solid line Dashed line (short line sections) shaded area marking	0 1 2 3 4 5 6 7
Divider Type	DT	COD	<Reserved> <Reserved> Legal Divider (not physical) Physical Divider	1 2 3 4
Divider Width	DW	MSR	N/A	N/A
Domestic/International	NI	COD	Domestic International Domestic and International	1 2 3
Enclosed Traffic Area Type	EA	COD	Parking Place Parking Building Another Type of Enclosed Traffic Area Unstructured Traffic Square Pedestrian Square	1 2 3 4 5
Entry Point Type	ET	COD	Main Minor	1 2
Equipment Identifier	EQ	TXT	N/A	N/A
Exit Number	EN	SCS	N/A	N/A
External Identifier	EI	TXT	N/A	N/A
Façade Colour	FL	SCS	N/A	N/A
Façade Component	Not Applicable	CMP	N/A	N/A
Façade Component Placement	FQ	COD	Aligned at the Bottom Spanning Bottom to Center Centered Spanning Center to Top Aligned at the Top Spanning Bottom to Top Spanning whole façade	1 2 3 4 5 6 7

Attribute Type Name	Attribute Type Code	Attribute Data Type	Attribute Value Name	Attribute Value Code
Façade Fabric	Not applicable	CMP	N/A	N/A
Façade Fabric Type	FF	COD	Façade Fabric type 1 Façade Fabric type 2 ... Façade Fabric type 999	1 2 ... 999
Façade Information	Not Applicable	CMP	N/A	N/A
Facilities en Suite	FS	CNT	N/A	N/A
Ferry Type	FT	COD	Operated by ship or hovercraft Operated by train	1 2
First House Number	HF	SCS	N/A	N/A
Flight Info	Not Applicable	CMP	N/A	N/A
Form of Way	FW	COD	Part of a motorway Part of a multiple carriageway which is not a Motorway Part of a single carriageway Part of a roundabout circle Part of a traffic square Part of an Enclosed Traffic Area Part of a slip road Part of a service road Entrance/exit to/from a car park Entrance/exit to/from a service Part of a pedestrian zone Part of Runaway Vehicle Ramp	1 2 3 4 5 9 10 11 12 13 14 16
Freeway	FY	BOL	False True	0 1
Frequency of a Traffic Connection	FR	TMR	N/A	N/A
Functional Road Class	FC	COD	Main road First class road Second class road Third class road Fourth class road Fifth class road Sixth class road Seventh class road Eighth class road Ninth class road	0 1 2 3 4 5 6 7 8 9
General Aviation	GA	BOL	False True	0 1
Geopolitical Structure Containment	IA	GSD	N/A	N/A
Give Way Type	GW	COD	Give Way (Yield) Stop All Way stop (example: 4-Way Stop) Caution Sign "Unmarked Intersection Ahead" (i.e. general traffic regulations apply)	1 2 3 4

Attribute Type Name	Attribute Type Code	Attribute Data Type	Attribute Value Name	Attribute Value Code
Government Type	GT	COD	National Order-1 Order-2 Order-3 Order-4 Order-5 Order-6 Order-7 Municipality	0 1 2 3 4 5 6 7 8
Hearing Limitation	AH	BOL	False True	0 1
Height Label	HP	MSR	N/A	N/A
High Occupancy Vehicle	Not Applicable	CMP	N/A	N/A
House Number	HN	SCS	N/A	N/A
House Number Range	Not Applicable	CMP	N/A	N/A
House Number Structure	HS	COD	No House Numbers Regular, odd numbers Regular, even numbers Regular, odd and even Irregular	1 2 3 4 5
ID of Flight Connection	ID	SCS	N/A	N/A
Importance	IM	COD	National Local	1 2
Infrastructure Accessibility Aids	AA	COD	Textured surface available Audible signal available Visual signal available Care provider available User defined	1 2 3 4 51-99
Interchange Type	IF	COD	Crossing between Freeways only Crossing between a Freeway and a Non-Freeway Crossing between Non-Freeways only	1 2 3
Intermediate House Number	HI	SCS	N/A	N/A
International Railway Station	AR	BOL	False True	0 1
ISO Country Code	IC	COD	ISO 3166-1 alpha-3 country codes	
Junction Type	JT	COD	Mini roundabout <Reserved code> Railway Crossing Border Crossing Fixed Guideway Vehicle Crossing (example: tram, dedicated busway)	1 2 3 4 5
Lane Dependent Validity	LD	SCS	Lanes counted from the left Lanes counted from the right Not valid for that lane Valid for that lane	1 st char. = L 1 st char. = R (n+1) th char. = 0 = 0 (n+1) th char. = 1
Lane Info	Not Applicable	CMP	N/A	N/A

Attribute Type Name	Attribute Type Code	Attribute Data Type	Attribute Value Name	Attribute Value Code
Lane Type	EV	COD	Normal lane Emergency lane Exit/Entrance lane Shoulder lane Lay-by lane Overtaking lane	0 1 2 3 4 5
Last House Number	HL	SCS	N/A	N/A
Lateral Offset	LO	CNT	N/A	N/A
Length of a Road Element	LR	MSR	N/A	N/A
Linear Position	Not applicable	CMP	N/A	N/A
Linear Referencing Method	LS	COD	Milepoint Kilopoint Milepost Kilopost Mile Reference Post Kilometre Reference Post Percentage Normalized Stationing Metric Stationing Reverse Milepoint Reverse Kilopoint Reverse Percentage	1 2 3 4 5 6 7 8 9 10 -1 -2 -7
Linear Segmentation	Not applicable	CMP	N/A	N/A
Location Description	LU	TXT	N/A	N/A
Location Reference	Not Applicable	CMP	N/A	N/A
Location Reference Code	LC	TXT	N/A	N/A
Location Reference Type	LT	COD	RDS/TMC VICS	1 2
Lower Building Elevation	BI	MSR	N/A	N/A
Magnetic Anomalies	MA	BOL	False True	0 1
Main Railway Station	MR	BOL	False True	0 1
Maximum Height Allowed	MH	MSR	N/A	N/A
Maximum Length Allowed	ML	MSR	N/A	N/A
Maximum Number of Lanes	XL	CNT	N/A	N/A
Maximum Total Weight Allowed	MT	MSR	N/A	N/A
Maximum Weight per Axle Allowed	AW	MSR	N/A	N/A
Maximum Width Allowed	MW	MSR	N/A	N/A
Measured Length	LM	MSR	N/A	N/A

Attribute Type Name	Attribute Type Code	Attribute Data Type	Attribute Value Name	Attribute Value Code
Military Airport	MP	BOL	False True	0 1
Minimum Number of Lanes	MI	CNT	N/A	N/A
Minimum Number of Occupants	MO	CNT	N/A	N/A
Mountain Pass	Not Applicable	CMP	N/A	N/A
Multi-Media Action	MC	User Defined	N/A	0...99
Multi-Media Description	MD	COD	Unknown Building Roof Object Façade Component Object Façade Fabric Object 3-D Landmark Object Elevation Point Grid Object <Reserved for future GDF defined values> User Defined	0 1 2 3 4 5 6 - 50000 50001 - 99999
Multi-Media File Attachment	Not Applicable	CMP	N/A	N/A
Multi-Media File Attachment Context	Not Applicable	CMP	N/A	N/A
Multi-Media File Attachment Name	MN	TXT	N/A	N/A
Multi-Media File Attachment Type	MQ	COD	Codes for MIME Media Types [49]	
Multi-Media Time Domain	MM	TMR	N/A	N/A
Name Component	Not Applicable	CMP	N/A	N/A
Name Component Length	NC	CNT	N/A	N/A
Name Component Offset	NO	CNT	N/A	N/A
Name Component Type	NT	COD	Name Component Type 1 Name Component Type 2 : : Name Component Type n	1 2 : : n
Name Prefix	NP	TXT	N/A	N/A
National Road Class	NR	COD	Main road First class road Second class road Third class road Fourth class road Fifth class road Sixth class road Seventh class road Eighth class road Ninth class road	0 1 2 3 4 5 6 7 8 9
Not Crossable by Pedestrians	PX	COD	No crossing advised (prohibited) No crossing advised (dangerous) No crossing not advised	1 2 3
Notation	Not applicable	CMP	N/A	N/A
Notation Alphabet	NE	TXT	N/A	N/A

Attribute Type Name	Attribute Type Code	Attribute Data Type	Attribute Value Name	Attribute Value Code
Notation Anomaly	NA	COD	Usual form Non-literal form Synonym	1 2 3
Notation Variant	NV	COD	Given form Long form Short form Alternate spelling	1 2 3 4
Notation Version	NW	COD	Original Exonym	1 2
Number of Lanes	NL	CNT	N/A	N/A
Number of Rooms	RO	CNT	N/A	N/A
Official Code	OC	SCS	N/A	N/A
Official Language	OL	COD	ISO 639-2 language code [1]	
Official Name	Not Applicable	CMP	N/A	N/A
Official Name Body	Not Applicable	CMP	N/A	N/A
Official Name Text	ON	TXT	N/A	N/A
Official Street Name	Not Applicable	CMP	N/A	N/A
Official Street Name Body	Not Applicable	CMP	N/A	N/A
Official Street Name Text	OF	TXT	N/A	N/A
One-way	OY	ENM	In positive direction In negative direction	0 1
Opening Period	OP	TMR	N/A	N/A
Other Textual Content on a Traffic Sign	CT	TXT	N/A	N/A
Ownership	OW	COD	Publicly owned Privately owned	1 2
Park and Ride Facility	PK	BOL	False True	0 1
Park Type	PT	COD	City Park Regional Park County Park State/Provincial Park National Park	1 2 3 4 5
Parking Facilities Available	PF	CNT	N/A	N/A
Parking Type Charged	PY	BOL	False True	0 1
Pass	PA	BOL	False True	0 1
Passing Restrictions	RP	BOL	False True	0 1
Pathway Safety Indicator	PJ	COD	Uncritical To be avoided Barred	1 2 3
Pathway Type	PH	COD	Surface Passageway Stairs Escalator Elevator Gallery Underpass Overpass Platform	1 2 3 4 5 6 7 8

Attribute Type Name	Attribute Type Code	Attribute Data Type	Attribute Value Name	Attribute Value Code
Paved Road Surface Type	OA	COD	Rigid Flexible Blocks	11 12 13
Pavement Status	PV	COD	Paved Unpaved	1 2
Pedestrian Crossing Level	XD	COD	Street level crossing Overpass Underpass	1 2 3
Pedestrian Crossing Priority	XC	COD	Pedestrians over road traffic Pedestrians over road traffic on request (at pedestrian crossings with traffic lights) Road traffic over pedestrians	1 2 3
Pedestrian Crossing Signage	XB	COD	No traffic signs (Passive) Traffic signs Traffic signs with warning lights Traffic light regulated	0 1 2 3
Pedestrian Crossing Type	XA	COD	No road markings Refuge island in the middle of road, no markings Zebra crossing, with or without additional constructive aids Other type	0 1 2 3
Pedestrian type	HT	COD	All pedestrian type Pedestrian with Stroller Pedestrian with Luggage cart Visually challenged pedestrian Aurally challenged pedestrian Mobility challenged Pedestrian (like Wheelchair) Mobility challenged Pedestrian with Care provider User defined	0 1 2 3 4 5 6 51-99
Percentage of International Traffic	PI	PRC	N/A	N/A
Phonetic Alphabet	LA	COD	IPA SAMPA SAMPA-SAMPROSA X-SAMPA	1 2 3 4
Place Name	PE	TXT	N/A	N/A
Place within Place Classification	PL	COD	Administrative Postal Address-significant Useful for reverse-geocoding	1 2 3 4
Point Assignment	Not applicable	CMP	N/A	N/A
Population	PO	CNT	N/A	N/A
Population Class	PC	COD	Population Class 1 Population Class 2 : : Population Class n	1 2 : : n
Positional Accuracy	AP	MSR	N/A	N/A
Post Office Type	PP	COD	Main Post Office Minor Post Office	1 2
Postal Code	PS	SCS	N/A	N/A

Attribute Type Name	Attribute Type Code	Attribute Data Type	Attribute Value Name	Attribute Value Code
Price Band	PR	COD	Highest Cost Category Second Highest Cost Category Third Highest Cost Category Fourth Highest Cost Category Fifth Highest Cost Category Sixth Highest Cost Category Seventh Highest Cost Category Eighth Highest Cost Category Lowest Cost Category	1 2 3 4 5 6 7 8 9
Pronunciation	PB	TXT	N/A	N/A
Pronunciation Language	LP	COD	ISO 639-2 language code [1]	
Pronunciation Variant	LV	COD	sub-standard local literal	1 2 3
Public Transport Mode	PM	COD	Bus Light Rail Underground Rail Passenger Ferry	1 2 3 4 5
Public Transport Operator	PQ	TXT	N/A	N/A
Publicly Accessible	SR	BOL	False True	0 1
Railway Type	RY	COD	Main/National Railway Minor/Regional Railway Underground/Metro	1 2 3
Rating	RA	COD	Unclassified 1 st category 2 nd category 3 rd category 4 th category 5 th (lowest) category	0 1 2 3 4 5
Region Code	RC	COD	Region Code 1 Region Code 2 : : Region Code n	1 2 : : n
Removable Blockage	RB	COD	Accessible for Emergency Vehicles Keyed Access Guard Controlled	1 2 3
Restaurant Facilities Available	RF	BOL	False True	0 1
Road and Rail Network and Associated Land Type	RZ	COD	Road And Rail Network And Associated Land Type 1 Road And Rail Network And Associated Land Type 2 ... Road And Rail Network And Associated Land Type 50	1 2 ... 50
Road Furniture Position	FP	BMI	To the right of the road To the left of the road Overhead Combinations are possible, e.g. The combination (placement) of multiple sets of road furniture to the right of the road and above is 5 (=1+4)	1 2 4

Attribute Type Name	Attribute Type Code	Attribute Data Type	Attribute Value Name	Attribute Value Code
Road Gradient	RG	PRS	N/A	N/A
Road Inclination	IR	PRS	N/A	N/A
Road Surface	Not Applicable	CMP	N/A	N/A
Road Surface Condition	RR	COD	Good Poor	1 2
Road Under Structure	US	BOL	False True	0 1
Road with Bicycle Lane	RL	BOL	False True	0 1
Road with Parking Lane	RK	BOL	False True	0 1
Road with Sidewalk	RM	BOL	False True	0 1
Route Direction	PD	ENM	Negative Positive	0 1
Route Number	Not Applicable	CMP	N/A	N/A
Route Number Body	RN	TXT	N/A	N/A
Route Number on Sign	RX	TXT	N/A	N/A
Route Type Prefix	RE	TXT	N/A	N/A
Route Type Suffix	RI	TXT	N/A	N/A
Routing Identifier	RS	TXT	N/A	N/A
Routing Sequence Number	RU	CNT	N/A	N/A
Routing Type	RT	COD	Restricted Vehicle Road Dangerous Load Route Precautionary Salting Route Transcontinental Route Designated Truck Route Other Route	1 2 3 4 5 99
Sand Area Type	SA	COD	Beach/Dune Desert Other	1 2 99
Scenic Value	SV	BOL	False True	0 1
Scope	CY	ENM	Full Partial	1 2
Separator	SE	SCS	N/A	N/A
Service Address	Not Applicable	CMP	N/A	N/A
Settlement Type	SM	COD	Residential Recreational Industrial Military	1 2 3 4
Side of Line	SI	ENM	Left Side Right Side	1 2
Sign Text	SJ	TXT	N/A	N/A
Slip Road Type	SL	COD	Parallel Road Slip Road of a grade separated crossing Slip Road of a crossing at grade Other	1 2 3 10
Slow Walker Limitation	AZ	BOL	False True	0 1

Attribute Type Name	Attribute Type Code	Attribute Data Type	Attribute Value Name	Attribute Value Code
Snack Served	SS	BOL	False True	0 1
Special Routing	Not Applicable	CMP	N/A	N/A
Speed Restrictions	SP	MSR	N/A	N/A
Spoken Language	OS	COD	ISO 639-2 language code [1]	
Start End Flag	CE	ENM	Start End	1 2
Street Lighted	SG	BOL	False True	0 1
Street Name	SN	TXT	N/A	N/A
Street Type Prefix	SX	TXT	N/A	N/A
Street Type Suffix	ST	TXT	N/A	N/A
Structure Abutment	AB	BMI	Structure abutment on the left of Road Element Structure abutment on the right of Road Element Structure abutment in the middle of the Road Element Values can be combined by summing them, e.g. 1+2+4=7 indicates a Structure Abutment on the left, right and middle of a Road Element.	1 2 4
Structure Abutment Info	Not Applicable	CMP	N/A	N/A
Structure Category	SC	COD	Over Under Other	1 2 3
Structure Identifier	SF	TXT	N/A	N/A
Structure Type	BT	COD	Bridge Viaduct Aqueduct Tunnel Cutting Gallery Retaining wall Embankment Not classified	1 2 3 4 11 12 13 14 5
Suitable for Disabled Or Challenged	SD	BOL	False True	0 1
Summer Time	SU	MSR	N/A	N/A

Attribute Type Name	Attribute Type Code	Attribute Data Type	Attribute Value Name	Attribute Value Code
Symbol on Traffic Sign	SY	COD	All traffic	0
			Motor cycle	1
			Private car	2
			Private car with trailer	3
			Heavy Goods Vehicle	4
			Heavy Goods Vehicle with trailer	5
			Bus	6
			Motor vehicle, having a maximum speed of 25 km/h	7
			Vehicle with dangerous goods other than explosive or water polluting goods	8
			Vehicle with explosive goods	9
			Vehicle with water polluting goods	10
			Tram	11
			Train	12
			Bicycle	15
			Moped	16
			Horse-drawn vehicle	17
			Rider	18
			Pedestrian	19
			Pedestrian with hand-drawn vehicle	20
			Speed	40
Total Weight	50			
Weight per axle	51			
Width	52			
Height	53			
Length	54			
Telefax Number	TX	SCS	N/A	N/A
Telephone Number	TL	SCS	N/A	N/A
Time Difference of Flight Connection	TF	TMR	N/A	N/A
Time of Arrival of Flight Connection	TA	TMR	N/A	N/A
Time of Departure of Flight Connection	TD	TMR	N/A	N/A
Time Zone	TZ	CNT	N/A	N/A
Toll	Not Applicable	CMP	N/A	N/A
Toll Charge	TC	CNT	N/A	N/A
Toll Point Type	TB	COD	Physical Toll Booth	1
			Virtual Toll Booth	2
			Hybrid	3
Toll Road	TR	BOL	False	0
			True	1
Traffic Flow	Not Applicable	CMP	N/A	N/A
Traffic Flow Measurement	TM	CNT	N/A	N/A
Traffic Flow Measurement Type	TY	COD	Average Traffic	1
			Average Flow during Peak Periods	2
			Maximum Flow	3
Traffic Flow Measurement Unit	TU	TMR	N/A	N/A
Traffic Jam Sensitivity	TJ	COD	No or low probability	0
			High probability	1
Traffic Light Info	Not Applicable	CMP	N/A	N/A

Attribute Type Name	Attribute Type Code	Attribute Data Type	Attribute Value Name	Attribute Value Code
Traffic Sign Class	TS	COD	Right of Way Directional Right of Passage Signpost Route prohibition Stopping prohibition Warning sign Directional sign Variable Speed Sign	50 51 52 53 54 55 56 57 99
Traffic Sign Information	Not Applicable	CMP	N/A	N/A
Trailing Spaces	TI	ENM	None Between preceding part and Street Name Body Between Street Name Body and succeeding part Between preceding part and the Street Name Body, and between the Street Name Body and the succeeding part	0 1 2 3
Transcription Description	LX	TXT	N/A	N/A
Transition	TN	COD	Regular Geometry Transitional Geometry	0 1
Travel Time	TT	TMR	N/A	N/A
Type of Public Transport Point	TP	COD	Timing Point Traffic Control Point Activation Point Turn Station Break Facility Parking Point Relief Point	1 2 3 4 5 6 7
Underground Flag	UF	COD	Aboveground Underground	0 1
Unpaved Road Surface Type	UR	COD	Gravel Dirt	21 22
Upper Building Elevation	BH	MSR	N/A	N/A
Urban Railway Station	BR	BOL	False True	0 1
Validity Direction	VD	ENM	Same direction Opposite direction	1 2
Validity Period	VP	TMR	N/A	N/A
Value on Referent	VR	TXT	N/A	N/A
Value on Traffic Sign	VA	MSR	N/A	N/A

Attribute Type Name	Attribute Type Code	Attribute Data Type	Attribute Value Name	Attribute Value Code
Vehicle Type	VT	COD	All Vehicles	0
			Passenger Cars	11
			Residential Vehicle	12
			High Occupancy Vehicle	13
			Car with Trailer	14
			Emergency Vehicle	15
			Taxi	16
			Public Bus	17
			Private Bus	18
			Military vehicle	19
			Delivery Truck	20
			Transport Truck	21
			Motorcycle	22
			Moped	23
			Bicycle	24
			Pedestrian	25
			Farm Vehicle	26
			Vehicle with water polluting load	28
			Vehicle with explosive load	29
			Vehicle with other dangerous load	30
			Trolley Bus	31
Employee Vehicle	32			
Light Rail	33			
Facility Vehicle	34			
School Bus	35			
4 Wheel Drive Vehicle	36			
Vehicle carrying snow chains	37			
Mail Vehicle	38			
Tanker	39			
Vehicle for disabled persons	40			
Snowmobile	41			
Vision Limitation	AV	BOL	False	0
			True	1
Water Boundary Element Type	WB	COD	Ocean or Sea shore line	1
			Lake shore line	2
			River side	3
			Canal side	4
			Wetland side	5
			Harbour side	6
			Water side of Pier or Dock	7
			Bay side	8
			Others	99
Water Body Type	WT	COD	Harbour/Port	6
			Bay	8
			Marina	9
			Unspecified	99
Wheelchair Limitation	AE	BOL	False	0
			True	1
Width	WI	MSR	N/A	N/A

A.3 Relationship Type Codes

A.3.1 Defined Relationship Type Codes

NOTE In the column for Feature Classes involved, Feature Class Names in parenthesis denote optional partners, and an asterisk (*) denotes repeatable partners. Both notations can be combined, allowing the following cases:

() means 0..1
 ()* means 0..*
 * means 1..*
 Neither () nor * means 1

Additional conventions:

| means or
italics means abstract Feature Class
 {ordered} means ordering constraint for repeatable role

Code	Name	Features classes involved	Role Number	Role Name
1001	Road Element Associated with Administrative Area	Order-8 Area Road Element	1 2	Order-8 Area Road Element
1002	Junction Associated with Administrative Area	Order-8 Area Junction	1 2	Order-8 Area Junction
1003	Road Element Associated with Named Area	Named Area Road Element	1 2	Named Area Road Element
1005	Building Associated with Administrative Area	Order-8 Area Building Schematic Building Building Unit	1 2	Order-8 Area Building Feature
1006	Service Associated with Administrative Area	Order-8 Area Service	1 2	Order-8 Area Service
1007	Built-up Area Associated with Administrative Area	Order-8 Area Built-up Area	1 2	Order-8 Area Built-up Area
1008	Ferry Connection Associated with Administrative Area	Order-8 Area Ferry Connection	1 2	Order-8 Area Ferry Connection
1009	District Associated with Administrative Area	Order-8 Area District	1 2	Order-8 Area District
1010	Enclosed Traffic Area Associated with Administrative Area	Order-8 Area Enclosed Traffic Area	1 2	Order-8 Area Enclosed Traffic Area
1011	Road Element Associated with Built-up Area	Built-up Area Road Element	1 2	Built-up Area Road Element

Code	Name	Features classes involved	Role Number	Role Name
1012	Junction Associated with Built-up Area	Built-up Area Junction	1	Built-up Area
			2	Junction
1013	Ferry Connection Associated with Named Area	Named Area Ferry Connection	1	Named Area
			2	Ferry Connection
1014	Service Associated with Named Area	Named Area Service	1	Named Area
			2	Service
1015	Building Associated with Built-up Area	Built-up Area Building Schematic Building Building Unit	1	Built-up Area
			2	Building Feature
1016	Service Associated with Built-up Area	Built-up Area Service	1	Built-up Area
			2	Service
1017	Enclosed Traffic Area Associated with Built-up Area	Built-up Area Enclosed Traffic Area	1	Built-up Area
			2	Enclosed Traffic Area
1018	District Associated with Built-up Area	Built-up Area District	1	Built-up Area
			2	District
1019	Road Element Associated with District	District Road Element	1	District
			2	Road Element
1020	Ferry Connection Associated with Built-up Area	Built-up Area Ferry Connection	1	Built-up Area
			2	Ferry Connection
1021	Building along Road Element	Road Element Building Schematic Building Building Unit	1	Road Element
			2	Building Feature
1022	Service along Road Element	Road Element Service	1	Road Element
			2	Service
1023	Service along Road	Road Service	1	Road
			2	Service
1024	Service at Junction	Junction Service	1	Junction
			2	Service
1025	Service at Intersection	Intersection Service	1	Intersection
			2	Service
1026	Service related to Service	Service Service	1	Service
			2	Associated Service
1027	Road Element leading to Enclosed Traffic Area	Road Element Enclosed Traffic Area	1	Road Element
			2	Enclosed Traffic Area
1028	Road Element belonging to Service	Road Element Service	1	Road Element
			2	Service

Code	Name	Features classes involved	Role Number	Role Name
1029	Centre Point of Feature belonging to Feature	Centre Point of Feature Feature	1 2	Centre Point Feature
1030	Divided Junction	Road Element Junction Road Elements	1 2 3	First Road Element Junction Second Road Element
1040	Building associated with Service	Service Building Schematic Building Building Unit	1 2	Service Building Feature
1041	Building Façade associated with Building	Building Façade Building	1 2	Building Façade Building
1042	Building Unit associated with Building	Building Unit Building Schematic Building	1 2	Building Unit Building or Schematic Building
1043	Building Unit linked to Street	Road Element Pathway Address Area Boundary Element Building Unit	1 2	Street Feature Building Unit
1044	Building related to Building	Building Building	1 2	First Building Second Building
2102	Restricted Manoeuvre	Road Element Junction Road Element (Road Element)* {ordered} (Traffic Sign)	1 2 3 4 5	First Road Element Junction Second Road Element Subsequent Road Element Last Partner in Manoeuvre
2103	Prohibited Manoeuvre	Road Element Junction Road Element (Road Element)* {ordered} (Traffic Sign)	1 2 3 4 5	First Road Element Junction Second Road Element Subsequent Road Element Last Partner in Manoeuvre
2104	Right of Way Regulation	Road Element Junction Road Element (Road Element)* {ordered} (Traffic Sign)	1 2 3 4 5	First Road Element Junction Second Road Element Subsequent Road Element Traffic Sign
2105	Through Route	Road Element Road Element (Road Element)* {ordered}	1 2 3	Beginning Road Element Continuing Road Element Subsequent Road Element
2106	Fork	Road Element Junction (Road Element)*	1 2 3	Approaching Road Element Junction Departing Road Element

Code	Name	Features classes involved	Role Number	Role Name
2108	Give Way Regulation	Road Element	1	First Road Element
		Junction	2	Junction
		(Road Element)	3	Second Road Element
		(Road Element)* {ordered}	4	Subsequent Road Element
		(Traffic Sign)	5	Traffic Sign
2109	Traffic Light Regulation	Road Element	1	Road Element
		Junction	2	Junction
		(Traffic Light)*	3	Traffic Light
2110	Connectivity	Road Element	1	From Road Element
		Junction	2	Junction
		(Road Element)* {ordered}	3	Via Road Element
		Road Element	4	To Road Element
2128	Signpost Information	Sign Post*	1	Sign Post
		Road Element	2	Locating Road Element
		Road Element	3	Destination Road Element
2129	Exit at Interchange	Interchange	1	Interchange
		Junction	2	Junction
2140	Toll Route	Toll Location	1	Toll Location
		Road Element Ferry Connection	2	First Toll Route Part
		(Road Element Ferry Connection)* {ordered}	3	Selective Intermediate Toll Route Part
		Road Element Ferry Connection	4	Last Toll Route Part
2200	Grade Separated Crossing	(<i>Transportation Element</i>)	1	Upper Part
		(<i>Transportation Element</i>)	2	Lower Part
		(Structure)	3	Structure
2300	Traffic Sign along Road Element	Traffic Sign	1	Traffic Sign
		Road Element	2	Road Element
2305	Traffic Light along Road Element	Traffic Light	1	Traffic Light
		Road Element	2	Road Element
2310	Overhead Structure along Road Element	Structure	1	Structure
		Road Element	2	Road Element
2315	Pedestrian Crossing along Road Element	Pedestrian Crossing	1	Pedestrian Crossing
		Road Element	2	Road Element
2400	Place within Place	Administrative Area	1	Contained Place
		Administrative Area	2	Containing Place

Code	Name	Features classes involved	Role Number	Role Name
4800	Linear Assignment	Planar Topo Line Feature Non-planar Topo Line Feature Non-explicit Topo Line Feature	1	Source
		Planar Topo Line Feature* Non-planar Topo Line Feature* Non-explicit Topo Line Feature*	2	Target
4801	Multi-Point Assignment	Planar Topo Point Feature* Non-planar Topo Point Feature* Non-explicit Topo Point Feature*	1	Source
		Planar Topo Line Feature Non-planar Topo Line Feature Non-explicit Topo Line Feature	2	Target
4802	Exclusive Multi-Point Assignment	Planar Topo Point Feature* Non-planar Topo Point Feature* Non-explicit Topo Point Feature*	1	Source
		Planar Topo Line Feature Non-planar Topo Line Feature Non-explicit Topo Line Feature	2	Target
6010	Pedestrian Square Connected to Pedestrian Crossing	Enclosed Traffic Area	1	Pedestrian Square
		Pedestrian Crossing Entry Point	2	Pedestrian Crossing Part
6020	Pedestrian Crossing Has Entry Point	Pedestrian Crossing	1	Pedestrian Crossing
		Entry Point*	2	Entry Point
7001	Route Link along Road Element	Route Link	1	Route Link
		Road Element	2	Road Element
7002	Stop Point along Route	Stop Point	1	Stop Point
		Route	2	Route
7003	Stop Point along Road Element	Stop Point	1	Stop Point
		Road Element	2	Road Element
7004	Stop Point at Junction	Stop Point	1	Stop Point
		Junction	2	Junction
7005	Stop Point located near Service	Stop Point	1	Stop Point
		Service	2	Service
7006	Public Transport Point along Route Link	Public Transport Point	1	Public Transport Point
		Route Link	2	Route Link

Code	Name	Features classes involved	Role Number	Role Name
7007	Public Transport Connection	Stop Point Stop Point	1	Originating Stop Point
			2	Connected Stop Point

A.3.2 User-defined codes

Any Relationship Type Code starting at 9000.

Annex B (informative)

Metadata codes

B.1 ISO 639-2 Language Codes [1]

NOTE 1 ISO 639-2 was based on the MARC Code List for Languages and published in 1998. The US Library of Congress is maintenance agency for both lists, and the two are kept compatible in terms of code additions and deletions.

NOTE 2 This information is current as of 3 March 2009. For more current information the user is referred to the source organisation [1].

Code	Language name
AAR	Afar
ABK	Abkhaz
ACE	Achinese
ACH	Acoli
ADA	Adangme
ADY	Adyghe; Adygei
AFA	Afro-Asiatic languages
AFH	Afrihili (Artificial language)
AFR	Afrikaans
AIN	Ainu
AKA	Akan
AKK	Akkadian
ALB	Albanian
ALE	Aleut
ALG	Algonquian (Other)
ALT	Southern Altai
AMH	Amharic
ANG	English, Old (ca. 450-1100)
ANP	Angika
APA	Apache languages
ARA	Arabic
ARC	Official Aramaic (700-300 BCE); Imperial Aramaic (700-300 BCE)
ARG	Aragonese
ARM	Armenian
ARN	Mapudungun; Mapuche
ARP	Arapaho
ART	Artificial languages
ARW	Arawak
ASM	Assamese
AST	Asturian; Bable; Leonese; Asturleonese
ATH	Athapascan (Other)
AUS	Australian languages
AVA	Avaric
AVE	Avestan
AWA	Awadhi
AYM	Aymara
AZE	Azerbaijani
BAD	Banda languages

Code	Language name
BAI	Bamileke languages
BAK	Bashkir
BAL	Baluchi
BAM	Bambara
BAN	Balinese
BAQ	Basque
BAS	Basa
BAT	Baltic languages
BEJ	Beja
BEL	Belarusian
BEM	Bemba
BEN	Bengali
BER	Berber languages
BEJ	Beja; Bedawiyet
BHO	Bhojpuri
BIH	Bihari
BIK	Bikol
BIN	Bini; Edo
BIS	Bislama
BLA	Siksika
BNT	Bantu languages
BOS	Bosnian
BRA	Braj
BRE	Breton
BTK	Batak languages
BUA	Buriat
BUG	Bugis
BUL	Bulgarian
BUR	Burmese
BYN	Blin; Bilin
CAD	Caddo
CAI	Central American Indian languages
CAR	Galibi Carib
CAT	Catalan
CAU	Caucasian languages
CEB	Cebuano
CEL	Celtic languages
CHA	Chamorro
CHB	Chibcha
CHE	Chechen
CHG	Chagatai
CHI	Chinese
CHK	Truk
CHM	Mari
CHN	Chinook jargon
CHO	Choctaw
CHP	Chipewyan; Dene Suline
CHR	Cherokee
CHU	Church Slavic
CHV	Chuvash
CHY	Cheyenne
CMC	Chamic languages
COP	Coptic
COR	Cornish
COS	Corsican

Code	Language name
CPE	Creoles and pidgins, English based
CPF	Creoles and pidgins, French-based
CPP	Creoles and pidgins, Portuguese-based
CRE	Cree
CRH	Crimean Tatar; Crimean Turkish
CRP	Creoles and pidgins
CSB	Kashubian
CUS	Cushitic languages
CZE	Czech
DAK	Dakota
DAN	Danish
DAR	Dargwa
DAY	Land Dayak languages
DEL	Delaware
DEN	Slave
DGR	Dogrib
DIN	Dinka
DIV	Divehi; Dhivehi; Maldivian
DOI	Dogri
DRA	Dravidian languages
DSB	Lower Sorbian
DUA	Duala
DUM	Dutch, Middle (ca. 1050-1350)
DUT	Dutch
DYU	Dyula
DZO	Dzongkha
EFI	Efik
EGY	Egyptian
EKA	Ekajuk
ELX	Elamite
ENG	English
ENM	English, Middle (1100-1500)
EPO	Esperanto
EST	Estonian
EWE	Ewe
EWO	Ewondo
FAN	Fang
FAO	Faroese
FAT	Fanti
FIJ	Fijian
FIL	Filipino; Pilipino
FIN	Finnish
FIU	Finno-Ugrian languages
FON	Fon
FRE	French
FRM	French, Middle (ca. 1400-1600)
FRO	French, Old (ca. 842-1400)
FRR	Northern Frisian
FRS	Eastern Frisian
FRY	Western Frisian
FUL	Fula
FUR	Friulian

Code	Language name
GAA	Gã
GAY	Gayo
GBA	Gbaya
GEM	Germanic languages
GEO	Georgian
GER	German
GEZ	Ethiopic
GIL	Gilbertese
GLA	Scottish Gaelic
GLE	Irish
GLG	Galician
GLV	Manx
GMH	German, Middle High (ca. 1050-1500)
GOH	German, Old High (ca. 750-1050)
GON	Gondi
GOR	Gorontalo
GOT	Gothic
GRB	Grebo
GRC	Greek, Ancient (to 1453)
GRE	Greek, Modern (1453-)
GRN	Guarani
GSW	Swiss German; Alemannic; Alsatian
GUJ	Gujarati
GWI	Gwich'in
HAI	Haida
HAT	Haitian; Haitian Creole
HAU	Hausa
HAW	Hawaiian
HEB	Hebrew
HER	Herero
HIL	Hiligaynon
HIM	Himachali
HIN	Hindi
HIT	Hittite
HMN	Hmong
HMO	Hiri Motu
HRV	Croatian (SCR retired)
HSB	Upper Sorbian
HUN	Hungarian
HUP	Hupa
IBA	Iban
IBO	Igbo
ICE	Icelandic
IDO	Ido
III	Sichuan Yi; Nuosu
IJO	Ijo languages
IKU	Inuktitut
ILE	Interlingue; Occidental
ILO	Iloko
INA	Interlingua (International Auxiliary Language Association)
INC	Indic languages
IND	Indonesian
INE	Indo-European languages
INH	Ingush

Code	Language name
IPK	Inupiaq
IRA	Iranian languages
IRO	Iroquoian languages
ITA	Italian
JAV	Javanese
JBO	Lojban
JPN	Japanese
JPR	Judeo-Persian
JRB	Judeo-Arabic
KAA	Kara-Kalpak
KAB	Kabyle
KAC	Kachin; Jingpho
KAL	Kalâtdlisut
KAM	Kamba
KAN	Kannada
KAR	Karen languages
KAS	Kashmiri
KAU	Kanuri
KAW	Kawi
KAZ	Kazakh
KBD	Kabardian
KHA	Khasi
KHI	Khoisan languages
KHM	Central Khmer
KHO	Khotanese, Sakan
KIK	Kikuyu
KIN	Kinyarwanda
KIR	Kyrgyz; Kyrgyz
KMB	Kimbundu
KOK	Konkani
KOM	Komi
KON	Kongo
KOR	Korean
KOS	Kusaie
KPE	Kpelle
KRC	Karachay-Balkar
KRL	Karelian
KRO	Kru languages
KRU	Kurukh
KUA	Kuanyama
KUM	Kumyk
KUR	Kurdish
KUT	Kutenai
LAD	Ladino
LAH	Lahnda
LAM	Lamba
LAO	Lao
LAT	Latin
LAV	Latvian
LEZ	Lezgian
LIM	Limburgan; Limburger; Limburgish
LIN	Lingala
LIT	Lithuanian

Code	Language name
LOL	Mongo-Nkundu
LOZ	Lozi
LTZ	Letzeburgesch
LUA	Luba-Lulua
LUB	Luba-Katanga
LUG	Ganda
LUI	Luiseño
LUN	Lunda
LUO	Luo (Kenya and Tanzania)
LUS	Lushai
MAC	Macedonian
MAD	Madurese
MAG	Magahi
MAH	Marshall
MAI	Maithili
MAK	Makasar
MAL	Malayalam
MAN	Mandingo
MAO	Maori
MAP	Austronesian languages
MAR	Marathi
MAS	Masai
MAY	Malay
MDF	Moksha
MDR	Mandar
MEN	Mende
MGA	Irish, Middle (ca. 1100-1550)
MIC	Mi'kmaq; Micmac
MIN	Minangkabau
MIS	Uncoded languages
MKH	Mon-Khmer languages
MLG	Malagasy
MLT	Maltese
MNC	Manchu
MNI	Manipuri
MNO	Manobo languages
MOH	Mohawk
MOL	Moldavian, Moldovan (deprecated)
MON	Mongolian
MOS	Mooré
MUL	Multiple languages
MUN	Munda (Other)
MUS	Creek
MWL	Mirandese
MWR	Marwari
MYN	Mayan languages
MYV	Erzya
NAH	Nahuatl languages
NAI	North American Indian languages
NAP	Neapolitan
NAU	Nauru
NAV	Navajo
NBL	Ndebele, South; South Ndebele
NDE	Ndebele, North; North Ndebele

Code	Language name
NDO	Ndonga
NDS	Low German; Low Saxon; German, Low; Saxon, Low
NEP	Nepali
NEW	Newari
NIA	Nias
NIC	Niger-Kordofanian languages
NIU	Niuean
NOG	Nogai
NON	Old Norse
NOR	Norwegian
NQO	N'Ko
NSO	Pedi; Sepedi; Northern Sotho
NUB	Nubian languages
NYA	Nyanja
NYM	Nyamwezi
NYN	Nyankole
NYO	Nyoro
NWC	Classical Newari; Old Newari; Classical Nepal Bhasa
NZI	Nzima
OCI	Occitan (post-1500)
OJI	Ojibwa
ORI	Oriya
ORM	Oromo
OSA	Osage
OSS	Ossetic
OTA	Turkish, Ottoman
OTO	Otomian languages
PAA	Papuan languages
PAG	Pangasinan
PAL	Pahlavi
PAM	Pampanga; Kapampangan
PAN	Panjabi
PAP	Papiamentu
PAU	Palauan
PEO	Old Persian (ca. 600-400 B.C.)
PER	Persian
PHI	Philippine languages
PHN	Phoenician
PLI	Pali
POL	Polish
PON	Ponape
POR	Portuguese
PRA	Prakrit languages
PRO	Provençal (to 1500); Occitan, Old (to 1500)
PUS	Pushto; Pashto
QUE	Quechua
RAJ	Rajasthani
RAP	Rapanui
RAR	Rarotongan; Cook Islands Maori
ROA	Romance languages
ROH	Romansh
ROM	Romany

Code	Language name
RUM	Romanian
RUN	Rundi
RUP	Aromanian; Arumanian; Macedo-Romanian
RUS	Russian
SAD	Sandawe
SAG	Sango
SAH	Yakut
SAI	South American Indian languages
SAL	Salishan languages
SAM	Samaritan Aramaic
SAN	Sanskrit
SAS	Sasak
SAT	Santali
SRP	Serbian (SCC retired)
SCN	Sicilian
SCO	Scots
SEL	Selkup
SEM	Semitic languages
SGA	Irish, Old (to 1100)
SGN	Sign languages
SHN	Shan
SID	Sidamo
SIN	Sinhala; Sinhalese
SIO	Siouan (Other)
SIT	Sino-Tibetan languages
SLA	Slavic languages
SLO	Slovak
SLV	Slovenian
SMA	Southern Sami
SME	Northern Sami
SMI	Sami languages
SMJ	Lule Sami
SMN	Inari Sami
SMO	Samoan
SMS	Skolt Sami
SNA	Shona
SND	Sindhi
SNK	Soninke
SOG	Sogdian
SOM	Somali
SON	Songhai languages
SOT	Sotho
SPA	Spanish
SRD	Sardinian
SRN	Sranan Tongo
SRR	Serer
SSA	Nilo-Saharan languages
SSW	Swazi
SUK	Sukuma
SUN	Sundanese
SUS	Susu
SUX	Sumerian
SWA	Swahili
SWE	Swedish
SYC	Classical Syriac

Code	Language name
SYR	Syriac
TAH	Tahitian
TAI	Tai languages
TAM	Tamil
TAT	Tatar
TEL	Telugu
TEM	Temne
TER	Terena
TET	Tetum
TGK	Tajik
TGL	Tagalog
THA	Thai
TIB	Tibetan
TIG	Tigré
TIR	Tigrinya
TIV	Tiv
TKL	Tokelauan
TLH	Klingon; tlhIngan-Hol
TLI	Tlingit
TMH	Tamashek
TOG	Tonga (Nyasa)
TON	Tongan
TPI	Tok Pisin
TSI	Tsimshian
TSN	Tswana
TSO	Tsonga
TUK	Turkmen
TUM	Tumbuka
TUP	Tupi languages
TUR	Turkish
TUT	Altaic languages
TVL	Tuvaluan
TWI	Twi
TYV	Tuvinian
UDM	Udmurt
UGA	Ugaritic
UIG	Uighur
UKR	Ukrainian
UMB	Umbundu
UND	Undetermined
URD	Urdu
UZB	Uzbek
VAI	Vai
VEN	Venda
VIE	Vietnamese
VOL	Volapük
VOT	Votic
WAK	Wakashan languages
WAL	Wolaitta; Wolaytta (Walamo deprecated)
WAR	Waray
WAS	Washo
WEL	Welsh

Code	Language name
WEN	Sorbian languages
WLN	Walloon
WOL	Wolof
XAL	Kalmyk; Oirat
XHO	Xhosa
YAO	Yao
YAP	Yapese
YID	Yiddish
YOR	Yoruba
YPK	Yupik languages
ZAP	Zapotec
ZBL	Blissymbols; Blissymbolics; Bliss
ZEN	Zenaga
ZHA	Zhuang
ZND	Zande languages
ZUL	Zulu
ZUN	Zuni
ZZA	Zaza; Dimili; Dimli; Kirdki; Kirmanjki; Zazaki
ZXX	No linguistic content; Not applicable

B.2 ISO 3166-1 Country Codes

NOTE This information is current as of 17 October 2008. For more current information the user is referred to the source organisation (see ISO 3166-1).

Code	Country Name
AFG	Afghanistan
ALA	Åland Islands
ALB	Albania
DZA	Algeria
ASM	American Samoa
AND	Andorra
AGO	Angola
AIA	Anguilla
ATG	Antigua and Barbuda
ARG	Argentina
ARM	Armenia
ABW	Aruba
AUS	Australia
AUT	Austria
AZE	Azerbaijan
BHS	Bahamas
BHR	Bahrain
BGD	Bangladesh
BRB	Barbados
BLR	Belarus
BEL	Belgium
BLZ	Belize
BEN	Benin
BMU	Bermuda

Code	Country Name
BTN	Bhutan
BOL	Bolivia
BIH	Bosnia and Herzegovina
BWA	Botswana
BRA	Brazil
VGB	British Virgin Islands
BRN	Brunei Darussalam
BGR	Bulgaria
BFA	Burkina Faso
BDI	Burundi
KHM	Cambodia
CMR	Cameroon
CAN	Canada
CPV	Cape Verde
CYM	Cayman Islands
CAF	Central African Republic
TCD	Chad
CHL	Chile
CHN	China
HKG	Hong Kong Special Administrative Region of China
MAC	Macao Special Administrative Region of China
COL	Colombia
COM	Comoros
COG	Congo
COK	Cook Islands
CRI	Costa Rica
CIV	Cote d'Ivoire
HRV	Croatia
CUB	Cuba
CYP	Cyprus
CZE	Czech Republic
PRK	Democratic People's Republic of Korea
COD	Democratic Republic of the Congo
DNK	Denmark
DJI	Djibouti
DMA	Dominica
DOM	Dominican Republic
TMP	East Timor
ECU	Ecuador
EGY	Egypt
SLV	El Salvador
GNQ	Equatorial Guinea
ERI	Eritrea
EST	Estonia
ETH	Ethiopia
FRO	Faeroe Islands
FLK	Falkland Islands (Malvinas)
FJI	Fiji
FIN	Finland
FRA	France
GUF	French Guiana
PYF	French Polynesia
GAB	Gabon
GMB	Gambia
GEO	Georgia
DEU	Germany

Code	Country Name
GHA	Ghana
GIB	Gibraltar
GRC	Greece
GRL	Greenland
GRD	Grenada
GLP	Guadeloupe
GUM	Guam
GTM	Guatemala
GIN	Guinea
GNB	Guinea-Bissau
GUY	Guyana
HTI	Haiti
VAT	Holy See
HND	Honduras
HUN	Hungary
ISL	Iceland
IND	India
IDN	Indonesia
IRN	Iran (Islamic Republic of)
IRQ	Iraq
IRL	Ireland
IMN	Isle of Man
ISR	Israel
ITA	Italy
JAM	Jamaica
JPN	Japan
JEY	Jersey
JOR	Jordan
KAZ	Kazakhstan
KEN	Kenya
KIR	Kiribati
KWT	Kuwait
KGZ	Kyrgyzstan
LAO	Lao People's Democratic Republic
LVA	Latvia
LBN	Lebanon
LSO	Lesotho
LBR	Liberia
LBY	Libyan Arab Jamahiriya
LIE	Liechtenstein
LTU	Lithuania
LUX	Luxembourg
MDG	Madagascar
MWI	Malawi
MYS	Malaysia
MDV	Maldives
MLI	Mali
MLT	Malta
MHL	Marshall Islands
MTQ	Martinique
MRT	Mauritania
MUS	Mauritius
MYT	Mayotte
MEX	Mexico
FSM	Micronesia, Federated States of
MCO	Monaco

Code	Country Name
MNG	Mongolia
MNE	Montenegro
MSR	Montserrat
MAR	Morocco
MOZ	Mozambique
MMR	Myanmar
NAM	Namibia
NRU	Nauru
NPL	Nepal
NLD	Netherlands
ANT	Netherlands Antilles
NCL	New Caledonia
NZL	New Zealand
NIC	Nicaragua
NER	Niger
NGA	Nigeria
NIU	Niue
NFK	Norfolk Island
MNP	Northern Mariana Islands
NOR	Norway
PSE	Occupied Palestinian Territory
OMN	Oman
PAK	Pakistan
PLW	Palau
PAN	Panama
PNG	Papua New Guinea
PRY	Paraguay
PER	Peru
PHL	Philippines
PCN	Pitcairn
POL	Poland
PRT	Portugal
PRI	Puerto Rico
QAT	Qatar
KOR	Republic of Korea
MDA	Republic of Moldova
REU	Réunion
ROM	Romania
RUS	Russian Federation
RWA	Rwanda
SHN	Saint Helena
KNA	Saint Kitts and Nevis
LCA	Saint Lucia
MAF	Saint-Martin (French part)
SPM	Saint Pierre and Miquelon
VCT	Saint Vincent and the Grenadines
WSM	Samoa
SMR	San Marino
STP	Sao Tome and Principe
SAU	Saudi Arabia
SEN	Senegal
SRB	Serbia
SYC	Seychelles
SLE	Sierra Leone
SGP	Singapore
SVK	Slovakia

Code	Country Name
SVN	Slovenia
SLB	Solomon Islands
SOM	Somalia
ZAF	South Africa
ESP	Spain
LKA	Sri Lanka
SDN	Sudan
SUR	Suriname
SJM	Svalbard and Jan Mayen Islands
SWZ	Swaziland
SWE	Sweden
CHE	Switzerland
SYR	Syrian Arab Republic
TWN	Taiwan Province of China
TJK	Tajikistan
THA	Thailand
MKD	The former Yugoslav Republic of Macedonia
TGO	Togo
TKL	Tokelau
TON	Tonga
TTO	Trinidad and Tobago
TUN	Tunisia
TUR	Turkey
TKM	Turkmenistan
TCA	Turks and Caicos Islands
TUV	Tuvalu
UGA	Uganda
UKR	Ukraine
ARE	United Arab Emirates
GBR	United Kingdom
TZA	United Republic of Tanzania
USA	United States
VIR	United States Virgin Islands
URY	Uruguay
UZB	Uzbekistan
VUT	Vanuatu
VEN	Venezuela
VNM	Viet Nam
WLF	Wallis and Futuna Islands
ESH	Western Sahara
YEM	Yemen
ZMB	Zambia
ZWE	Zimbabwe

B.3 Codes for Geodetic Systems

B.3.1 Reference Codes for Horizontal Datums [29]

NOTE This information is subject to updating. For the most current information the user is referred to the source organisation [29].

Code	Datum name
ADI	Adindan
ADIA	Adindan (Ethiopia)
ADIB	Adindan (Sudan)
ADIC	Adindan (Mali)
ADID	Adindan (Senegal)
ADIE	Adindan (Burkina Faso)
ADIF	Adindan (Cameroon)
ADIM	Adindan (Mean value: Ethiopia and Sudan)
AFG	Afgooye (Somalia)
AIA	Antigua Island Astro 1943
AIN	Ain el Abd 1970
AINA	Ain el Abd 1970 (Bahrain Island)
AINB	Ain el Abd 1970 (Saudi Arabia)
AMA	American Samoa Datum 1962
AME	Amersfoort 1885/1903 (Netherlands)
ANO	Anna 1 Astro 1965 (Cocos Islands)
APL	Approximate Luzon Datum (Philippines)
ARF	Arc 1950
ARFA	Arc 1950 (Botswana)
ARFB	Arc 1950 (Lesotho)
ARFC	Arc 1950 (Malawi)
ARFD	Arc 1950 (Swaziland)
ARFE	Arc 1950 (Zaire)
ARFF	Arc 1950 (Zambia)
ARFG	Arc 1950 (Zimbabwe)
ARFH	Arc 1950 (Burundi)
ARFM	Arc 1950 (Mean value: Botswana, Lesotho, Malawi, Swaziland, Zaire, Zambia, and Zimbabwe)
ARS	Arc 1960
ARSA	Arc 1960 (Kenya)
ARSB	Arc 1960 (Tanzania)
ARSM	Arc 1960 (Mean value: Kenya, Tanzania)
ART	Arc 1935 (Africa)
ASC	Ascension Island 1958 (Ascension Island)
ASM	Montserrat Island Astro 1958
ASQ	Astro Station 1952 (Marcus Island)
ATF	Astro Beacon "E" (Iwo Jima Island)
ATX	Average Terrestrial System 1977, New Brunswick
AUA	Australian Geod. 1966 (Australia and Tasmania Is.)
AUG	Australian Geod. 1984 (Australia and Tasmania Is.)
BAT	Djakarta (Batavia) (Sumatra Island, Indonesia)
BAT1	Djakarta (Batavia) (Sumatra Island, Indonesia) with Zero Meridian Djakarta
BEK	Bekaa Base South End (Lebanon)
BEL	Belgium 1950 System (Lommel Signal, Belgium)
BER	Bermuda 1957 (Bermuda Islands)
BID	Bissau (Guinea-Bissau)
BJM	Modified BJZ54 (China)
BJZ	BJZ54 (A954 Beijing Coordinates) (China)

Code	Datum name
BOO	Bogota Observatory (Colombia)
BOO1	Bogota Observatory (Colombia) with Zero Meridian Bogota
BRE	Bern 1898 (Switzerland)
BRE1	Bern 1898 (Switzerland) with Zero Meridian Bern
BUR	Bukit Rimpah (Bangka & Belitung Islands, Indonesia)
CAC	Cape Canaveral (Mean value: Florida and Bahama Islands)
CAI	Campo Inchauspe (Argentina)
CAM	Camacupa Base SW End (Campo De Aviacao, Angola)
CAO	Canton Astro 1966 (Phoenix Islands)
CAP	Cape (South Africa)
CAZ	Camp Area Astro (Camp McMurdo Area, Antarctica)
CCD	S-JTSK, Czechoslovakia (prior to 1 Jan 1993)
CGE	Carthage (Tunisia)
CGX	Compensation Géodétique du Québec 1977
CHI	Chatham 1971 (Chatham Island, New Zealand)
CHU	Chua Astro (Paraguay)
COA	Corrego Alegre (Brazil)
COV	Conakry Pyramid of the Service Geographique (Guinea)
CSG	Guyana CSG67
DAL	Dabola (Guinea)
DCS	DCS-3 Lighthouse, Saint Lucia, Lesser Antilles
DID	Deception Island, Antarctica
DOB	GUX 1 Astro (Guadacanal Island)
DOM	Dominica Astro M-12, Dominica, Lesser Antilles
EAS	Easter Island 1967 (Easter Island)
ENW	Wake-Eniwetok 1960 (Marshall Islands)
EUR	European 1950
EURA	European 1950 (Western Europe: Austria, Denmark, France, Federal Republic of Germany, Netherlands, and Switzerland)
EURB	European 1950 (Greece)
EURC	European 1950 (Norway and Finland)
EURD	European 1950 (Portugal and Spain)
EURE	European 1950 (Cyprus)
EURF	European 1950 (Egypt)
EURG	European 1950 (England, Channel Islands, Scotland, and Shetland Islands)
EURH	European 1950 (Iran)
EURI	European 1950 (Sardinia)
EURJ	European 1950 (Sicily)
EURK	European 1950 (England, Channel Islands, Ireland, Northern Ireland, Scotland, Shetland Islands, and Wales)
EURL	European 1950 (Malta)
EURM	European 1950 (Mean value: Austria, Belgium, Denmark, Finland, France, Federal Republic of Germany, Gibraltar, Greece, Italy, Luxembourg, Netherlands, Norway, Portugal, Spain, Sweden, & Switzerland)
EURS	European 1950 (Iraq, Israel, Jordan, Kuwait, Lebanon, Saudi Arabia, and Syria)
EURT	European 1950 (Tunisia)
EUS	European 1979 (Mean value: Austria, Finland, Netherlands, Norway, Spain, Sweden, and Switzerland)
EUT	European Terrestrial Reference System 1989 (ETRS89)
FAH	Oman (Oman)
FLO	Observatorio Meteorologico 1939 (Corvo and Flores Islands, Azores)
FOT	Fort Thomas 1955 (Nevis, St Kitts, Leeward Islands)
GAA	Gan 1970 (Addu Atoll, Republic of Maldives)
GAN	Gandajika Base (Zaire)
GDS	Geocentric Datum of Australia (GDA)

Code	Datum name
GDZ	GDZ80 (China)
GEO	Geodetic Datum 1949 (New Zealand)
GIZ	DOS 1968 (Gizo Island, New Georgia Islands)
GRA	Graciosa Base SW (Faial, Graciosa, Pico, Sao Jorge, and Terceira Island, Azores)
GRK	Greek Datum, Greece
GRX	Greek Geodetic Reference System 1987 (GGRS 87)
GSE	Gunong Segara (Kalimantan Island, Indonesia)
GSF	Gunong Serindung
GUA	Guam 1963
HEN	Herat North (Afganistan)
HER	Hermannskogel
HIT	Provisional South Chilean 1963 (or Hito XVIII 1963) (S. Chile, 53°S)
HJO	Hjörsey 1955 (Iceland)
HKD	Hong Kong 1963 (Hong Kong)
HKO	Hong Kong 1929
HTN	Hu-Tzu-Shan
HUY	Hungarian 1972
IBE	Bellevue (IGN) (Efate and Erromango Islands)
IDN	Indonesian 1974
IND	Indian
INDA	Indian (Thailand and Vietnam)
INDB	Indian (Bangladesh)
INDI	Indian (India and Nepal)
INDP	Indian (Pakistan)
INF	Indian (1954)
INFA	Indian 1954 (Thailand)
ING	Indian 1960
INGA	Indian 1960 (Vietnam: near 16°N)
INGB	Indian 1960 (Con Son Island (Vietnam))
INH	Indian 1975
INHA	Indian 1975 (Thailand)
IRL	Ireland 1965 (Ireland and Northern Ireland)
ISG	ISTS 061 Astro 1968 (South Georgia Islands)
IST	ISTS 073 Astro 1969 (Diego Garcia)
JOH	Johnston Island 1961 (Johnston Island)
KAB	Kalianpur (India)
KAN	Kandawala (Sri Lanka)
KEA	Kertau 1948 (or Revised Kertau) (West Malaysia and Singapore)
KCS	KCS 2, Sierra Leone
KEG	Kerguelen Island 1949 (Kerguelen Island)
KGS	Korean Geodetic System 1995 (South Korea)
KKX	KKJ (or Kartastokoordinaattijarjestelma), Finland
KUS	Kusaie Astro 1951
KUW	Kuwait Oil Company (K28)
LCF	L.C. 5 Astro 1961 (Cayman Brac Island)
LEH	Leigon (Ghana)
LIB	Liberia 1964 (Liberia)
LIS	Lisbon (Castelo di São Jorge), Portugal
LOC	Local Astro.
LOM	Loma Quintana (Venezuela)
LUZ	Luzon
LUZA	Luzon (Philippines except Mindanao Island)
LUZB	Luzon (Mindanao Island)
MAA	Marco Astro (Salvage Islands)
MAR	Martinique Fort-Desaix

Code	Datum name
MAS	Massawa (Eritrea, Ethiopia)
MAW	Manokwari (West Irian)
MCX	Mayotte Combani
MDT	Mount Dillon, Tobago
MER	Merchich (Morocco)
MID	Midway Astro 1961 (Midway Island)
MIK	Mahe 1971 (Mahe Island)
MIN	Minna
MINA	Minna (Cameroon)
MINB	Minna (Nigeria)
MOD	Rome 1940 (or Monte Mario 1940), Italy
MOD1	Rome 1940 (or Monte Mario 1940), Italy, with Zero Meridian Rome
MOL	Montjong Lowe
MPO	M'Poraloko (Gabon)
MVS	Viti Levu 1916 (Viti Levu Island, Fiji Islands)
NAH	Nahrwan
NAHA	Nahrwan (Masirah Island, Oman)
NAHB	Nahrwan (United Arab Emirates)
NAHC	Nahrwan (Saudi Arabia)
NAP	Naparima (BWI, Trinidad and Tobago)
NAR	North American 1983
NARA	North American 1983 (Alaska, excluding Aleutian Islands)
NARB	North American 1983 (Canada)
NARC	North American 1983 (CONUS)
NARD	North American 1983 (Mexico and Central America))
NARE	North American 1983 (Aleutian Islands)
NARH	North American 1983 (Hawaii)
NAS	North American 1927
NASA	North American 1927 (Eastern US)
NASB	North American 1927 (Western US)
NASC	North American 1927 (Mean value: CONUS)
NASD	North American 1927 (Alaska)
NASE	North American 1927 (Mean value: Canada)
NASF	North American 1927 (Alberta and British Columbia)
NASG	North American 1927 (Newfoundland, New Brunswick, Nova Scotia and Quebec)
NASH	North American 1927 (Manitoba and Ontario)
NASI	North American 1927 (Northwest Territories and Saskatchewan)
NASJ	North American 1927 (Yukon)
NASL	North American 1927 (Mexico)
NASN	North American 1927 (Central America - Belize, Costa Rica, El Salvador, Guatemala, Honduras, and Nicaragua)
NASO	North American 1927 (Canal Zone)
NASP	North American 1927 (Caribbean, Barbados, Caicos Islands, Cuba, Dominican Republic, Grand Cayman, Jamaica, Leeward Islands, and Turks Islands)
NASQ	North American 1927 (Bahamas, except San Salvador Island)
NASR	North American 1927 (San Salvador Island)
NAST	North American 1927 (Cuba)
NASU	North American 1927 (Hayes Peninsula, Greenland)
NASV	North American 1927 (Aleutian Islands East of 180°W)
NASW	North American 1927 (Aleutian Islands West of 180°W)
NAX	Revised Nahrwan
NFR1 Alt: FDA	New French or Nouvelle Triangulation Française (NTF) with Zero Meridian Paris
NSD	North Sahara 1959
OCO	Ocotopeque, Guatemala

Code	Datum name
ODU	Belgium 1972 (Observatoire d'Uccle)
OEG	Old Egyptian (Egypt)
OGB	Ordnance Survey of Great Britain 1936
OGBA	Ordnance Survey G.B. 1936 (England)
OGBB	Ordnance Survey G.B. 1936 (England, Isle of Man, and Wales)
OGBC	Ordnance Survey G.B. 1936 (Scotland and Shetland Islands)
OGBD	Ordnance Survey G.B. 1936 (Wales)
OGBM	Ordnance Survey G.B. 1936 (Mean value: England, Isle of Man, Scotland, Shetland, and Wales)
OHA	Old Hawaiian
OHAA	Old Hawaiian (Hawaii)
OHAB	Old Hawaiian (Kauai)
OHAC	Old Hawaiian (Maui)
OHAD	Old Hawaiian (Oahu)
OHAM	Old Hawaiian (Mean value)
OSL	Oslo Observatory (Old), Norway
PAD	Padang Base West End (Sumatra, Indonesia)
PAD1	Padang Base West End (Sumatra, Indonesia) with Zero Meridian Djakarta
PAL	Palestine 1928 (Israel, Jordan)
PDM	Potsdam or Helmertturm (Germany)
PHA	Ayabelle Lighthouse (Djibouti)
PIT	Pitcairn Astro 1967 (Pitcairn Island)
PLN	Pico de las Nieves (Canary Islands)
POS	SE Base (Porto Santo) (Porto Santo & Madeira Islands)
PRP	Provisional South American 1956
PRPA	Prov. S. American 1956 (Bolivia)
PRPB	Prov. S. American 1956 (Northern Chile near 19°S)
PRPC	Prov. S. American 1956 (Southern Chile near 43°S)
PRPD	Prov. S. American 1956 (Columbia)
PRPE	Prov. S. American 1956 (Ecuador)
PRPF	Prov. S. American 1956 (Guyana)
PRPG	Prov. S. American 1956 (Peru)
PRPH	Prov. S. American 1956 (Venezuela)
PRPM	Prov. S. American 1956 (Mean value: Bolivia, Chile, Colombia, Ecuador, Guyana, Peru, & Venezuela)
PTB	Point 58 Mean Solution (Burkina Faso and Niger)
PTN	Pointe Noire 1948
PUK	Pulkovo 1942 (Russia)
PUR	Puerto Rico (Puerto Rico and Virgin Islands)
QAT	Qatar National (Qatar)
QUO	Qornoq (South Greenland)
RAU	Rauenberg (Berlin, Germany)
REC	Reconnaissance Triangulation, Morocco
REU	Reunion 1947
RTS	RT90, Stockholm, Sweden
SAE	Santo (DOS) 1965 (Espirito Santo Island)
SAF	South African (South Africa)
SAG	Sainte Anne I 1984 (Guadeloupe)
SAN	South American 1969
SANA	South American 1969 (Argentina)
SANB	South American 1969 (Bolivia)
SANC	South American 1969 (Brazil)
SAND	South American 1969 (Chile)
SANE	South American 1969 (Columbia)
SANF	South American 1969 (Ecuador)

Code	Datum name
SANG	South American 1969 (Guyana)
SANH	South American 1969 (Paraguay)
SANI	South American 1969 (Peru)
SANJ	South American 1969 (Baltra, Galapagos Islands)
SANK	South American 1969 (Trinidad and Tobago)
SANL	South American 1969 (Venezuela)
SANM	South American 1969 (Mean value: Argentina, Bolivia, Brazil, Chile, Columbia, Ecuador, Guyana, Paraguay, Peru, Trinidad and Tobago, and Venezuela)
SAO	Sao Braz (Sao Miguel, Santa Maria Islands, Azores)
SAP	Sapper Hill 1943 (East Falkland Islands)
SCK	Schwarzeck (Namibia)
SGA	Soviet Geodetic System 1985
SGB	Soviet Geodetic System 1990
SGM	Selvagem Grande 1938 (Salvage Islands)
SHB	Astro Dos 71/4 (St. Helena Island)
SIB	Sierra Leone 1960
SOA	South Asia (Southeast Asia, Singapore)
SPK	S-42 (Pulkovo 1942)
SPX	St. Pierre et Miquelon 1950
STO	Stockholm 1938 (Sweden)
SYO	Sydney Observatory, New South Wales, Australia
TAN	Tananarive Observatory 1925
TAN1	Tananarive Observatory 1925, with Zero Meridian Paris
TDC	Tristan Astro 1968 (Tristan da Cunha)
TIL	Timbalai 1948 (Brunei and East Malaysia - Sarawak and Sabah)
TIN	Timbali 1968
TOY	Tokyo
TOYA	Tokyo (Japan)
TOYB	Tokyo (Korea)
TOYC	Tokyo (Okinawa)
TOYM	Tokyo (Mean value: Japan, Korea, and Okinawa)
TRI	Trinidad 1903
TRN	Astro Tern Is. 1961 (Tern Island, Hawaii)
UND	Undetermined or Unknown
VOI	Voirol 1875
VOI1	Voirol 1875 with Zero Meridian Paris
VOR	Voirol 1960, Algeria
VOR1	Voirol 1960, Algeria, with Zero Meridian Paris
WAK	Wake Island Astro 1952
WGA	World Geodetic System 1960
WGB	World Geodetic System 1966
WGC	World Geodetic System 1972
WGE	World Geodetic System 1984
YAC	Yacare (Uruguay)
ZAN	Zanderij (Surinam)
ZYX	Other Known Datum

B.3.2 Reference Codes for Grid Systems [29]

NOTE This information is subject to updating. For the most current information the user is referred to the source organisation [29].

Code	Grid name
AD	Aden Zone
AF	Afghanistan Gauss-Krüger Grid
AG	Air Defense Grid
AI	Air Support Grid
AJ	Alabama Coordinate System *
AK	Alaska Coordinate System *
AL	Algeria Zone *
AM	Albania Bonne Grid
AN	Alpha-Numeric (Atlas) Grid
AO	Arbitrary Grid
AP	American Samoa Coordinate System *
AQ	Argentine Gauss-Krüger Conformal Grid *
AR	Artillery Referencing System
AS	Arizona Coordinate System
AT	Map Grid of Australia 1994 (MGA94) *
AU	Australia Belt *
AV	Arkansas Coordinate System *
AW	Australian Map Grid *
AX	Azores Gauss Conformal Grid
AZ	Azores Zone
BA	Baku 1927 Coordinate System
BB	Bavaria Soldner Coordinate System
BC	Belgium Lambert Grid *
BD	Baltic Region Transverse Mercator Grid
BE	Belgium Bonne Grid
BF	Brazil Gauss Conformal Grid *
BL	Soldner-Berlin (Müggelberg) Grid
BO	Borneo Rectified Skew Orthomorphic Grid *
BW	British West Indies Grid *
CB	California Coordinate System *
CD	Canada British Modified Grid
CE	Ceylon Belt (Transverse Mercator)
CF	Canary Islands (Spanish Lambert Grid)
CG	Chile Gauss Conformal Grid *
CH	China Belt *
CI	Canary Islands Zone
CJ	China Lambert Zone
CK	Colorado Coordinate Zone *
CM	Connecticut Coordinate System *
CN	Caspian Zone
CO	Costa Rica Lambert Grid
CQ	Crimea Grid
CR	Crete Zone
CT	Cuba Lambert Grid *
CU	Caucasus Zone
CV	Cape Verde Islands Zone
CW	British Cassini Grid *
CX	Czechoslovak Uniform Cadastral Coordinate System
CY	Cyprus Grid *
CZ	Czechoslovak Military Grid

Code	Grid name
DA	Danube Zone
DB	Dahomey Belt
DC	Denmark General Staff Grid
DD	Delaware Coordinate System *
DE	Dominican Lambert Grid
DJ	Denmark Geodetic Institute System 1934
DK	Cape Verde Peninsula Grid
EA	East Africa Belt *
EB	English Belt
ED	Egypt Gauss Conformal Grid *
EE	El Salvador Lambert Grid
EF	Estonian Grid
EL	Estonian Lambert Conformal Grid
EO	Hungarian Unified National Mapping System (EOTR)
EP	Egypt Purple Belt
ER	Egypt Red Belt *
ET	Egypt 35 Degree Belt
FA	Fernando Poo Gauss Grid
FB	Fiji Grid
FC	Florida Coordinate System *
FD	French Bonne Grid
FE	French Guiana Gauss Grid
FF	French Somaliland Gauss-Laborde Grid
FI	French Indochina Grid
FJ	Franz Josef Land Zone
FL	French Lambert Grid *
FO	Formosa (Taiwan) Gauss-Schreiber Coordinate System
FS	French Equatorial Africa Grid
GA	Gabon Belt *
GB	Gauss-Boaga Grid (Transverse Mercator)
GC	Gabon Gauss Conformal Grid
GE	Geographic Reference System (GEOREF) *
GF	Guadeloupe Gauss-Laborde Grid
GG	Colombia Gauss Conformal Grid
GH	Sweden Gauss-Hannover Grid
GI	Georgia Coordinate System *
GK	Gauss-Krüger Grid (Transverse Mercator) *
GL	Greece Azimuthal Grid
GN	German Army Grid (DHG) *
GO	Ghana National Grid
GP	Greece Bonne Grid
GQ	Greece Conical Mecklenburg Coordinates
GR	Greece Conical Mecklenburg Coordinate (New Numbering)
GT	Greenland Lambert Grid
GU	Guinea Zone
GV	Guam Coordinate System
GW	Guatemala Lambert Grid
GY	Guyana Transverse Mercator Grid
HB	Haiti Lambert Grid
HC	Hawaii Coordinate System *
HD	Hawaii Grid
HE	Honduras Lambert Grid
HF	Hong Kong New System Cassini Grid
HG	Hungary Stereographic Grid
HR	Hong Kong Colony Grid

Code	Grid name
IA	Idaho Coordinate System *
IB	Illinois Coordinate System *
IC	Indiana Coordinate System *
ID	Indonesia Mercator Grid
IE	Indonesia Polyhedric Grid *
IF	Iowa Coordinate System *
IG	Ivory Coast Azimuthal Grid
IH	Irish Cassini Grid
IJ	Ivory Coast Belt
IK	Irish Transverse Mercator Grid
IL	Iceland New Lambert Zone
IN	India Zone *
IP	Iberian Peninsula Zone
IQ	Iraq Zone *
IR	Iraq National Grid
IT	Italy Zone *
IY	Ivy - Found on an HA in Marshall Islands
IZ	Iceland Zone
JA	Jamaica Foot Grid
JB	Japan Plane-Rectangular Coordinate System
JC	Japan Gauss-Schreiber Grid
JM	Jamaica National Grid (metric)
JO	Johore Grid
KA	Austria Gauss-Krüger Grid
KB	Bulgaria Gauss-Krüger Grid
KC	Katanga Grid
KD	Kansas Coordinate System *
KE	Kentucky Coordinate System *
KF	Finland Gauss-Krüger Grid
KG	German Gauss-Krüger Grid
KH	Kenya Colony Grid
KJ	Korea Gauss-Schreiber Coordinate System
KK	Louisiana Coordinate System *
KL	Lithuania Gauss-Krüger Grid
KN	Kwantung Province Grid
KT	Turkey Gauss-Krüger Grid
KW	Kwangsi Province Grid
KX	Luxembourg Gauss-Krüger Grid
LC	Lambert Conformal Conic Grid *
LD	Latvia Coordinate System
LE	Levant Zone
LF	Levant Stereographic Grid
LG	Liberia Rectified Skew Orthomorphic Grid
LI	Libya Zone
LK	Lithuanian LKS-94 Grid
LL	Sirte (Libya) Lambert Grid
MA	Malaya Grid *
MB	Malta Belt
MC	Maldivo-Chagos Belt
MD	Madiera Zone
ME	Mediterranean Zone *
MF	Maine Coordinate System *
MG	Malaya Rectified Skew Orthomorphic (Yard) Grid
MH	Martinique Gauss Grid
MI	Maryland Coordinate System *

Code	Grid name
MJ	Massachusetts Coordinate System *
MK	Mexican Lambert Grid
ML	Michigan Coordinate System *
MM	Mecca-Muscat Zone
MN	Minnesota Coordinate System *
MO	Madagascar Grid (Laborde)
MP	Mississippi Coordinate System *
MQ	Morocco Zone *
MS	Other Known Grid
MT	Missouri Coordinate System *
MU	Mauritius Zone
MV	Montana Coordinate System *
MW	Mozambique Lambert Grid
MX	Mozambique Polyconic Grid
NA	Northwest Africa Zone
NB	New Jersey Coordinate System *
NC	Nigeria Colony Belt *
ND	National Grid of Great Britain
NE	Northern European Zone *
NF	Nebraska Coordinate System *
NG	Numeric Grid
NH	New Hampshire Coordinate System *
NI	Niger Zone
NJ	Netherlands Stereographic Grid (Old Numbering)
NK	North Korea Gauss-Krüger Grid
NL	Netherlands Stereographic Grid (New Numbering)
NM	Netherlands East Indies Equatorial Zone British Metric Grid (Lambert) *
NO	Nord de Guerre Zone *
NN	New Mexico Coordinate System *
NP	Nevada Coordinate System *
NQ	New Sierra Leone Colony Grid *
NR	New York Coordinate System *
NS	Netherlands East Indies Southern Zone
NT	New Zealand Map Grid (NZMG)
NU	Nicaragua Lambert Grid *
NV	Niger Belt
NW	North Carolina Coordinate System *
NX	North Dakota Coordinate System *
NY	Netherlands East Indies Equatorial Zone U.S. Yard Grid *
NZ	New Zealand Belt *
OA	Northern Malaya Grid
OB	Norway Gauss-Krüger Grid *
OD	Ohio Coordinate System *
OE	Oklahoma Coordinate System *
OR	Orange Report Net
OS	Oregon Coordinate System *
PA	Palestine Belt *
PB	Panama Lambert Grid
PC	Palestine Civil Grid (Cassini) *
PD	Paraguay Gauss-Krüger Grid
PE	Peiping Coordinate System of 1954
PF	Pennsylvania Coordinate System *
PG	Polish PSWG 1992 Grid
PI	Peru Polyconic Grid
PJ	Philippine Plane Coordinate System

Code	Grid name
PK	Poland Gauss-Krüger Grid
PL	Poland Quasi-Stereographic Grid
PP	Philippine Polyconic Grid
PQ	Portugal Bonne Grid, Old
PR	Portugal Bonne Grid, New
PS	Portugal Gauss Grid
PT	Puerto Rico & Virgin Islands Coordinate System *
PU	Puerto Rico Lambert Grid
QA	Qatar Cassini Grid
QU	Qatar Peninsula Grid (or Qatar National Grid (TM))
RB	Russian Belt *
RC	Reunion Gauss Grid
RD	Rhode Island Coordinate System *
RE	Romania Bonne Grid
RF	Soviet Coordinate System of 1942 *
RH	Romania Lambert-Cholesky Grid
RK	Rikets National Grid *
RI	Romania Stereographic Grid
RT	Pulkovo Coordinate System of 1932
SA	South Africa Belt (yards) *
SB	Senegal Gauss Conformal Grid (Belt)
SD	South Africa Coordinate System (South Africa Belt (English feet)) *
SE	Senegal Belt
SF	South Carolina Coordinate System *
SH	Sahara Zone
SI	South Dakota Coordinate System *
SJ	South Libya Zone
SK	Sarawak Grid
SL	Spain Lambert Grid
SN	Southern New Guinea Grid *
SQ	South Georgia Lambert Grid
SR	South Syria Lambert Grid
SS	Spanish North-Morocco Lambert Grid
SV	Svalbard Gauss-Krüger Grid
SX	Svobodny 1935 Coordinate System
SY	Seychelles Belt
SZ	Spitzbergen Zone
TA	Tanganyika Territorial Grid
TB	Tashkent 1875 Coordinate System
TC	Tennessee Coordinate System *
TD	Texas Coordinate System *
TE	Tobago Grid
TF	Trinidad Grid
TG	Trucial Coast Cassini Grid
TH	Trucial Coast Transverse Mercator Grid
TI	Turkey Bonne Grid
TN	Tunisia Zone *
UA	Uganda Cassini Coordinate System *
UB	Unidentified Grid
UC	Uruguay Gauss-Krüger Grid
UD	Utah Coordinate System *
UP	Universal Polar Stereographic System *
US	U.S. Polyconic Grid System
UT	Universal Transverse Mercator *
VA	Vermont Coordinate System *

Code	Grid name
VB	Virginia Coordinate System *
VE	Venezuela Modified Lambert Grid
VI	Vietnam Azimuthal Grid
WA	West Malaysia Rectified Skew Orthomorphic (Metric) Grid
WB	Switzerland Bonne Grid
WC	Switzerland Conformal Oblique Cylindrical Grid
WD	West Virginia Coordinate System *
WE	Wisconsin Coordinate System *
WF	Wyoming Coordinate System *
WH	Washington Coordinate System *
WP	World Polyconic System
YA	Yugoslavia Gauss-Krüger Grid (Not Reduced)
YG	Yugoslavia Reduced Gauss-Krüger Grid
YU	Yunnan Province Grid

B.3.3 Reference Codes for a number of Vertical Datums

NOTE This information is current as of March 2009. Except for GDF-assigned codes (source designation is GDF), the user is referred to the following source organisation for more current information.

- British Library *UKMARC Manual* [36]
- DIGEST [36]

Code	Name	Source
AA	Aburatsubo, Japan	UKMARC
AB	Accra, Ghana	UKMARC
AC	Aden Mean Sea Level	UKMARC
AD	Aden Tidal Observatory	UKMARC
AE	Adjusted MSL 1891, Denmark	UKMARC
AF	Admiralty Datum, Australia	UKMARC
AG	Aitutaki, Cook Islands	UKMARC
AH	Al Faw (Fao), Iraq	UKMARC
AJ	Alexandria, Egypt	UKMARC
AK	Alicante, 1870-72, Spain	UKMARC
AL	Almirante, Panama	UKMARC
AM	Amherst Tidal Observatory, Burma	UKMARC
AN	Anhui Assumed, China	UKMARC
AO	Antalya, Turkey	UKMARC
AP	Antofagasta, Chile	UKMARC
AQ	Approximate Kronstadt	UKMARC
AR	Apra Harbor, Guam, Mariana Islands	UKMARC
AS	Aquaba, Jordan	UKMARC
AT	Africa (Chile), Bolivia	UKMARC
BA	Arica, Chile	UKMARC
BB	Assab, Ethiopia	UKMARC
BC	Auckland 1946, New Zealand	UKMARC
BD	Australian Capital Territory Datum Australia	UKMARC
BE	Balboa (Canal), Panama	UKMARC
BF	Banana, Zaire	UKMARC
BG	Bangkok RR Station, Thailand	UKMARC
BH	Barahona, Dominican Republic	UKMARC
BI	Beira, Rhodesia	UKMARC

BJ	Beirut, Lebanon	UKMARC
BK	Belfast, Ireland	UKMARC
BL	Belize, British Honduras	UKMARC
BM	Bench Mark 1 MSL (1949), Mariana Islands	UKMARC
BN	Bench Mark 4 MSL, Mariana Islands	UKMARC
BO	Berlin, Germany	UKMARC
BP	Biloxi, Mississippi, USA	UKMARC
BQ	Bluff, 1955, New Zealand	UKMARC
BR	Bluff, 1960, New Zealand	UKMARC
BS	Brisbane MSL, Queensland, Australia	UKMARC
BT	Broome Jetty MSL, Western Australia	UKMARC
CA	Brussels, Belgium	UKMARC
CB	Buenaventura, Colombia	UKMARC
CC	Burnie, Tasmania	UKMARC
CD	Byrd Station, Antarctica	UKMARC
CE	Cagliari 1956, Sardinia	UKMARC
CF	Cairo, Illinois, USA	UKMARC
CG	Callao, Peru	UKMARC
CH	Camarta BM, Nicobar Island	UKMARC
CI	Cape Town, South Africa	UKMARC
CJ	Cape York MSL, Queensland, Australia	UKMARC
CK	Cartagena (Atlantic Coast), Colombia	UKMARC
CL	Casablanca 1922, Morocco	UKMARC
CM	Cascais 1881-1938, Portugal	UKMARC
CN	Chekiang Assumed, China	UKMARC
CO	Chen-chiang Customs, China	UKMARC
CP	Chih-huang Tao, China	UKMARC
CQ	Chihli River Commission, China	UKMARC
CR	Chi-lung (Kirun), Taiwan	UKMARC
CS	Ching Tao MSL, China, also Tsingtao 1956	UKMARC
DA	Coatzacoalcos, Mexico	UKMARC
DB	Colombo 1884-90, Ceylon	UKMARC
DC	Conakry, Guinea-Bissau	UKMARC
DD	Constanta, Rumania	UKMARC
DE	Cooktown MSL, Queensland, Australia	UKMARC
DF	Cristobal (Canal), Panama	UKMARC
DH	Dakar, Senegal	UKMARC
DI	Dansk N.N., Denmark	UKMARC
DJ	Darwin MSL, Northern Territory, Australia	UKMARC
DK	Darwin Town Datum, Northern Territory, Australia	UKMARC
DL	Davao Wharf Tide Staff, Mindanao, Philippines	UKMARC
DM	Denison MSL, Western Australia	UKMARC
DN	Darby MSL, Western Australia	UKMARC
DO	Devonport MSL, Tasmania	UKMARC
DP	Diego Garcia, Chagos Archipelago	UKMARC
DQ	Disko Bugt, Greenland	UKMARC
DR	Djakarta, Java, Indonesia	UKMARC
DS	Dublin Bay, Ireland	UKMARC
DT	Dunedin 1958, New Zealand	UKMARC
EA	Durres, Albania	UKMARC
EB	Eden Tide Gauge, New South Wales, Australia	UKMARC
EC	Ensenada, Baja California, Mexico	UKMARC
ED	Errits, Denmark	UKMARC
EE	Federal Datum, Rhodesia	UKMARC
EF	Freetown, Sierra Leone	UKMARC
EG	Fremantle MSL, Western Australia	UKMARC
EH	Fukien Assumed, China	UKMARC

EI	Genoa 1942, Italy	UKMARC
EJ	Ginara, Punta Colombo, Cuba	UKMARC
EK	Golfito, Costa Rica	UKMARC
EL	Ha Tien MSL, Vietnam	UKMARC
EM	Haifa, Israel	UKMARC
EN	Hai-lo Conservancy Commission, China	UKMARC
EO	Havana, Cuba	UKMARC
EP	Helsinki, Finland	UKMARC
EQ	Hobart MSL, Tasmania	UKMARC
ER	Hobson Bay LWM, Victoria, Australia	UKMARC
ES	Honan Assumed, China	UKMARC
ET	Honolulu, Hawaiian Islands	UKMARC
FA	Honto MSL, Sakhalin, USSR	UKMARC
FB	Hau River Commission, China	UKMARC
FC	Hunan Assumed, China	UKMARC
FD	Hupeh Assumed, China	UKMARC
FE	Ilha e Naos, Panama	UKMARC
FF	Illigan Harbour Tide Staff, Mindanao, Philippines	UKMARC
FG	Imbituba, Brazil	UKMARC
FH	Inch'on Provisional, Korea (South)	UKMARC
FI	Indian MSL, India	UKMARC
FJ	Indian Spring Low Water	UKMARC
FK	International Great Lakes Datum 1935, Canada	UKMARC
FL	International Great Lakes Datum 1955, USA	UKMARC
FM	Ireland I. Dockyard, Bermuda Islands	UKMARC
FN	Irish Ordnance Datum (poolbeg), Ireland	UKMARC
FO	Isla de Pinos, Cuba	UKMARC
FP	Isle of Man Ordnances Datum, Great Britain	UKMARC
FQ	Israel Land Survey Datum, Jaffa, Israel	UKMARC
FR	Jaffa, Israel	UKMARC
FS	Jehol Assumed, China	UKMARC
FT	K'an-men MSL, China	UKMARC
GA	Kavála, Greece	UKMARC
GB	Kiangsi Assumed, China	UKMARC
GC	Kiangsu Assumed, China	UKMARC
GD	Kiaochow Tsinan RR, China	UKMARC
GE	Kirin, China	UKMARC
GF	Klaipeda (Memel), Lithuania	UKMARC
GG	Ko Lak MSL, Thailand	UKMARC
GH	Kribi, Cameroon	UKMARC
GI	Kronshtadt (1840), USSR	UKMARC
GJ	Kuala Trengganu MSL, Malaysia (West)	UKMARC
GK	Kwangsi Assumed, China	UKMARC
GL	Kwangtung Assumed, China	UKMARC
GM	Kweichow Assumed, China	UKMARC
GN	La Goulette, (Tunisia), Algeria	UKMARC
GO	La Goulette, Tunisia	UKMARC
GP	La Guaira, Venezuela	UKMARC
GQ	La Libertad, Ecuador	UKMARC
GR	La Libertad, El Salvador	UKMARC
GS	La Union (Cutuco), El Salvador	UKMARC
GT	Lagos, Nigeria	UKMARC
HA	Land Survey, Antarctica	UKMARC
HB	Launceston City Council Datum, Tasmania	UKMARC
HC	Lien-yun Chiang MSL, China	UKMARC
HD	Lisov, Czechoslovakia	UKMARC
HH	Lo-hsing-t'a Zero Point, China	UKMARC

HI	Lombrum, Manus Island, Admiralty Islands	UKMARC
HJ	Lome, Togo	UKMARC
HK	Low Island, Great Barrier Reef	UKMARC
HL	Low Water Ordinary Spring Tide, Wyndham, Western Australia	UKMARC
HM	Luanda, Angola	UKMARC
HN	Lyttleton 1938, New Zealand	UKMARC
HO	Makassar, Sulawesi, Indonesia	UKMARC
HP	Mako Harbor, Pescadores	UKMARC
HQ	Malin Head, Ireland	UKMARC
HR	Manila Bay MSL, Philippines	UKMARC
HS	Mar del Plata, Argentina	UKMARC
HT	Marseille 1885-96, France	UKMARC
IA	International Great Lakes Datum (IGLD) 1985	GDF
IC	International Terrestrial Reference Frame 1994 (ITRF94)	GDF
ID	International Terrestrial Reference Frame 1996 (ITRF96)	GDF
IE	International Terrestrial Reference Frame 1997 (ITRF97)	GDF
IF	International Terrestrial Reference Frame 2000 (ITRF2000)	GDF
JA	Matarani, Peru	UKMARC
JB	Matavi, Tahiti, Society Islands	UKMARC
JC	Maura Tide Gauge, Malaysia (East)	UKMARC
JD	Mawson Tide Gauge, Antarctica	UKMARC
JE	Mayaguez, Puerto Rico	UKMARC
JF	Mazatlan, Mexico	UKMARC
JG	Mediterranean, Italy (old-net)	UKMARC
JH	Mean Gulf Level, USA	UKMARC
JI	Mean High Water Sea, Antarctica	UKMARC
JL	Mean Sea Level Manifa Pier, Saudi Arabia	UKMARC
JM	Memphis, Tennessee, USA	UKMARC
JN	Mina Construction Datum, Kuwait	UKMARC
JO	Mocamedes, Angola	UKMARC
JP	Mombasa, Kenya	UKMARC
JQ	Monrovia, Liberia	UKMARC
JR	Montevideo, Uruguay	UKMARC
JS	Moturiki 1953, New Zealand	UKMARC
JT	MSL Adjustment 1927, Alaska	UKMARC
KA	MSL Adjustment 1935, Canadian Geodetic Datum	UKMARC
KB	MSL Adjustment 1958, Cuba	UKMARC
KC	MSL Adjustment 1959, Mexico and Panama	UKMARC
KD	MSL Adjustment 1960, Mexico, Central America and Colombia	UKMARC
KE	MSL Adjustment 1961, Haiti	UKMARC
KF	MSL Adjustment 1962, Chile	UKMARC
KG	MSL Adjustment 1964, Jamaica	UKMARC
KH	MSL Adjustment 1966, Ecuador and Peru	UKMARC
KI	NADAP I, Hungary	UKMARC
KJ	NADAP II, Hungary	UKMARC
KK	Naha BM, Ryukyu Islands	UKMARC
KL	Narvik, Norway	UKMARC
KM	Nelson 1955, New Zealand	UKMARC
KN	Nevelsk (Honto), Sakhalin	UKMARC
KO	NM/S/G, Antarctica	UKMARC
KP	Nord Norges Normal Null(NNN), Norway	UKMARC
KQ	Norges Normal Null, Norway	UKMARC
KR	Normal Amsterdams Piel (NAP), Netherlands	UKMARC
KS	Normal Null (NN), Germany	UKMARC
KT	Normalhoehen (NH) System 1960. East Germany	UKMARC
LA	Noumea MSL, New Caledonia	UKMARC
LB	N.S.P. 1958, Surinam	UKMARC

LC	Okinawa Level, Ryukyu Islands	UKMARC
LD	Old Huang-ho-Zero Pt. China	UKMARC
LE	Ordnance Datum (Lerwick), Shetland Islands, Great Britain	UKMARC
LF	Ordnance Datum (Liverpool), Great Britain	UKMARC
LG	Ordnance Datum (Newlyn), 1921 Great Britain	UKMARC
LH	Ordnance Datum (Stornoway), Outer Hebrides, Great Britain	UKMARC
LI	Ostende, Belgium	UKMARC
LJ	Pafos, Cyprus	UKMARC
LK	Perth Headland Jetty, Western Australia	UKMARC
LL	Pierre du Niton, Geneva, Switzerland	UKMARC
LM	Pimba Railway Datum, South Australia	UKMARC
LN	Point Fouillole, Guadeloupe	UKMARC
LO	Point Lonsdale, Victoria, Australia	UKMARC
LP	Point Noire, Congo (Brazzaville)	UKMARC
LQ	Pont de Capitainerie de le Ville, São Tomé Island	UKMARC
LR	Port Adelaide MSL, South Australia	UKMARC
LS	Port au Prince, Haiti	UKMARC
LT	Port aux Basques, Newfoundland	UKMARC
MA	Port-aux-Français, Kerguelen Is	UKMARC
MB	Port Dickson, Malaysia (West)	UKMARC
MC	Port Moresby, Papua	UKMARC
MD	Port of Spain, Trinidad	UKMARC
ME	Port Royal, Jamaica	UKMARC
MF	Port Swettenham MSL, Malaysia (West)	UKMARC
MG	Port Waikato 1954, New Zealand	UKMARC
MH	Port Weld MSL, Malaysia (West)	UKMARC
MI	Port Welshpool, Victoria, Australia	UKMARC
MJ	Portland MSL, Victoria, Australia	UKMARC
MK	Principal Datum, Hong Kong	UKMARC
ML	Puerto Armuelles, Panama	UKMARC
MM	Puerto Cortés 1948-51, Honduras	UKMARC
MN	Puerto de Cristobal, Panama	UKMARC
MO	Puerto Limón, Costa Rica	UKMARC
MP	Puerto Montt, Chile	UKMARC
MQ	Puerto Plata, Dominican Republic	UKMARC
MR	Puerto Puntarenas, Costa Rica	UKMARC
MS	Pulau Lakei, Malaysia	UKMARC
MT	Punta Arenas, Chile	UKMARC
NA	Punta Penasco, Mexico	UKMARC
NB	Queensland State Datum, Australia	UKMARC
NC	Reykjavik, Iceland	UKMARC
ND	San Jose, Guatemala	UKMARC
NE	San Juan del Sur, Nicaragua	UKMARC
NF	Sandy Hook, New Jersey, USA	UKMARC
NG	Santo Antonio 1916, Principe	UKMARC
NH	Santo Domingo, Dominican Republic	UKMARC
NI	Sea Ice, Antarctica	UKMARC
NJ	Sea Level Datum, 1912, USA	UKMARC
NK	Sea Level Datum, 1929, USA	UKMARC
NL	Sea Level, Bonin Island	UKMARC
NM	Seoul, S Korea	UKMARC
NN	Seward-Veldez MSL, Alaska	UKMARC
NO	Shanghai Customs, China	UKMARC
NP	Shanghai-Nanking RR, China	UKMARC
NQ	Shansi Assumed, China	UKMARC
NR	Shantung Assumed, China	UKMARC
NS	Shensi Assumed, China	UKMARC

NT	Singkiang Assumed, China	UKMARC
OG	Ordnance Survey Geoid Model (OSGM) 2002	GDF
PA	Shun-ch'in Water Conservancy Bureau, China	UKMARC
PB	Split, Yugoslavia	UKMARC
PC	Station R, Ille du Maregraphe, Terre Adélie, Antarctica	UKMARC
PD	St James, Barbados	UKMARC
PE	St John, New Brunswick, Canada	UKMARC
PF	Stockholm, Sweden	UKMARC
PG	Sydney Datum MSL, New South Wales, Australia	UKMARC
PH	Sydney Standard, New South Wales, Australia	UKMARC
PI	Szechwan Assumed, China	UKMARC
PJ	Tacloban Tide Staff, Leyte, Philippines	UKMARC
PK	Ta-Ku MSL, China	UKMARC
PL	Ta-ku Zero Point, China	UKMARC
PM	Talara, Peru	UKMARC
PN	Ta-lien, China, also Dairen MSL	UKMARC
PO	Tallin (Reval), Estonia	UKMARC
PP	Tamatave, Malagasy Republic	UKMARC
PQ	Tampico, Mexico	UKMARC
PR	Tandjungpriak TG, Java, Indonesia	UKMARC
PS	Tanga, Tanzania	UKMARC
PT	Tararu, New Zealand	UKMARC
QA	Thessaloniki, Greece	UKMARC
QB	Tibe Gauge Observatory, Port Blair, Andaman Islands	UKMARC
QC	Tokyo, Japan	UKMARC
QD	Topoplobampo, Mexico	UKMARC
QE	Torres (Brazil), Paraguay	UKMARC
QF	Torres, Brazil	UKMARC
QG	Torun, Poland	UKMARC
QH	Townsville, Queensland, Australia	UKMARC
QI	Tregde, Norway	UKMARC
QJ	Trieste 1875 (Italy) Austria, Czechoslovakia, Hungary and Yugoslavia	UKMARC
QK	Tripoli, Libya	UKMARC
QM	Unahi Road, New Zealand	UKMARC
QN	Valparaiso, Chile	UKMARC
QO	Varna, Bulgaria	UKMARC
QP	Vladivostok, USSR	UKMARC
QQ	Walvis Bay, Southwest Africa	UKMARC
QR	Wanganui, New Zealand	UKMARC
QS	Wangpoo Conservancy Board, China	UKMARC
QT	Wellington 1953, New Zealand	UKMARC
RA	Williamstown LWM, Victoria, Australia	UKMARC
RB	Wonsan (Genzan), Korea	UKMARC
RC	Wu-sung MSL, China	UKMARC
RD	Wu-sung Zero Point, China	UKMARC
RE	Yunnan Assumed, China	UKMARC
RG	General levelling, France	UKMARC
RM	Relative metric	GDF
RO	Relative Ordinal	GDF
TA	Approximate mean sea-level	UKMARC
TB	Local	UKMARC
TC	Local LWM	UKMARC
TD	Local MSL	UKMARC
TE	Mean sea-level	UKMARC
TF	None	UKMARC
TG	Arbitrary	UKMARC
TH	Mean low water	UKMARC

TI	Mean low water Springs	UKMARC
TJ	Mean lower low water	UKMARC
TK	Mean lower low water Springs	UKMARC
TL	Lowest normal low water	UKMARC
TM	Lowest low water	UKMARC
TN	Indian Spring low water	UKMARC
TO	At or near the level of lowest astronomical tide	UKMARC
UU	Unknown vertical datum	UKMARC
VA	North American Vertical Datum of 1988 (NAVD88)	GDF
VB	National Geodetic Vertical Datum of 1929 (NGVD29) (North America)	GDF
WC	World Geodetic System ² 1966 - ellipsoid	DIGEST
WD	World Geodetic System of 1972 (WGS72) - ellipsoid	DIGEST
WE	World Geodetic System of 1984 (WGS84) - ellipsoid	DIGEST
WF	World Geodetic System (Unspecified) (-,-)	DIGEST
WS	World Geodetic System 1960	DIGEST
WT	WGS 84 EGM96 Earth Gravitational Model	GDF
WX	European Terrestrial Reference System 89 (ETRS89)	GDF
WY	European Vertical Reference System 2000 (EVRS)	GDF
ZZ	Other known vertical datum	UKMARC

B.3.4 List of Projection Types and Parameters

The order of the longitude and latitude values is relevant and shall be represented in the listed order in the corresponding Latitude Longitude groups.

1. Regular Mercator (Conform Cylindric)
 - The point scale factor M_0 along the equator
2. Transverse Mercator (Conform Transverse Cylindric)
 - The geographical longitude of the central meridian of the projection
 - The point scale factor M_0 at the central meridian
3. Oblique Mercator (= Conform Oblique Cylindric) [Hotine version]
 - The geographical latitude of the Projection Pole
 - The geographical longitude of the Projection Pole
 - The geographical latitude of the point where the point scale factor has been specified
 - The geographical longitude of the point where the point scale factor has been specified
 - The point scale factor M_0 in that point
4. Lambert Conformal Conic, 1 parallel
 - The geographical latitude of the central parallel
 - The point scale factor M_0 along the central parallel
5. Lambert Conformal Conic, 2 parallels
 - The geographical latitude of the Northern standard parallel
 - The geographical latitude of the Southern standard parallel
 - The geographical latitude of the reference parallel for which the point scale factor M_0 is given
 - The point scale factor M_0 along the reference parallel
6. Stereographic
 - The geographic latitude of the projection centre
 - The geographical longitude of the projection centre
 - The point scale factor M_0 in the projection centre
7. Soldner/Cassini (Transverse Equidistant Cylindric)
 - The geographical longitude of the central meridian
 - The point scale factor along the central meridian

8. Bonne
 - The geographical latitude of the central parallel
 - The geographical longitude of the central meridian
 - The point scale factor M_0 along the central meridian
9. Hatt/Postel (Azimuthal Equidistant)
 - The geographical latitude of the projection centre
 - The geographical longitude of the projection centre
 - The point scale factor in the projection centre
10. Polyconic projection with all equidistant parallels
 - The geographical longitude of the central meridian
 - Point scale factor at the central meridian
11. Polyconic projection with orthogonal parameterlines and 1 equidistant parallel
 - The geographical longitude of the central meridian
 - The geographical latitude of the equidistant parallel
 - Point scale factor at the central meridian
12. Polyhedral projection
 - The geographical latitude of the northern equidistant parallel
 - The geographical longitude of the western equidistant meridian
 - The geographical latitude of the southern equidistant parallel
 - The geographical longitude of the eastern equidistant meridian

B.3.5 Reference Codes for Ellipsoids [11]

NOTE 1 This information is subject to updating. For the most current information the user is referred to the source organisation [11].

Code	Ellipsoid name
AA	Airy (1830)
AM	US- Modified Airy UK- Airy Modified
AN	Australian National (1966)
AP	APL 4.5 (1968)
AT	Average Terrestrial System 1977
AW	Airy (War Office)
BM	Bessel (Modified)
BN	Bessel 1841 (Namibia)
BR	US - Bessel 1841 (Ethiopia, Indonesia, Japan, Korea) UK - Bessel 1841 (Revised)
CA	Clarke 1858
CB	Clarke 1858 (Modified)
CC	Clarke 1866
CD	US - Clarke 1880 UK - Clarke 1880 Modified
CE	Clarke 1880 (Cape)
CF	Clarke 1880 (Palestine)
CG	Clarke 1880 (IGN)
CI	Clarke 1880 (Syria)
CJ	Clarke 1880 (Fiji)
CL	Clarke 1880 (Unspecified)
DA	Danish (1876) or Andrae
DB	Delambre 1810
DC	Delambre (Carte de France)

Code	Ellipsoid name
EA	US - Everest (India 1830) UK - Everest (1830)
EB	US - Everest (Brunei and E. Malaysia (Sabah and Sarawak)) UK - Everest (Borneo)
EC	US - Everest (India 1956) UK - Everest (India)
ED	US - Everest (W. Malaysia 1969) UK - Everest (Malaya RSO)
EE	US - Everest (W. Malaysia and Singapore 1948) UK - Everest (Malaya RKT)
EF	Everest (Pakistan)
EV	Everest (Unspecified)
FA	US - Modified Fischer 1960 (South Asia) UK - Fischer 1960 (South Asia)
FC	Fischer 1968
FM	Fischer 1960 (Mercury)
GE	Germaine (Djibouti)
HA	Hayford 1909
HE	Helmert 1906
HO	Hough 1960
IA	IAG Best Estimate 1975
ID	Indonesian National (1974)
IN	US - International 1924 UK - International
KA	Krassovsky (1940)
KB	Krayenhoff 1827
NO	No ellipsoid
NW	NWL-8E
PM	Plessis Modified
PR	Plessis Reconstituted
RE	Geodetic Reference System 1967
RF	Geodetic Reference System 1980
SA	South American
SG	Soviet Geodetic System 1985
SJ	Ellipsoid Junction
SN	Soviet Geodetic System 1990
ST	Struve 1860
SV	Svanberg
WA	Walbeck 1819 (Planheft 1942)
WB	Walbeck 1819 (AMS 1963)
WC	World Geodetic System 1966
WD	World Geodetic System 1972
WE	World Geodetic System 1984
WF	World Geodetic System (Unspecified)
WO	US - War Office 1924 (McCaw) UK - War Office 1924
WS	World Geodetic System 1960
ZY	Other Known Ellipsoid
ZZ	Unknown Ellipsoid

NOTE 2 If the code "ZY" is used it must be followed by a Comment in which the full name of the ellipsoid is described.

B.3.6 Reference Codes for Projection Types [29]

NOTE 1 This information is subject to updating. For the most current information the user is referred to the source organisation [29].

Code	Projection Type name
AC	Albers Equal-Area Conic
AK	(Lambert) Azimuthal Equal-Area
AL	Azimuthal Equidistant
BF	Bonne
CC	Equidistant Conic with 1 Standard Parallel
CP	Equirectangular (La Carte Parallélogramatique)
CS	Cassini-Soldner
GN	Gnomonic
HX	Hotine Oblique Mercator based on 2 Points
KA	Equidistant Conic with 2 Standard Parallels
LA	Laborde
LE	Lambert Conformal Conic
LJ	Lambert Equal-Area Meridional
MC	Mercator
MH	Miller Cylindrical
MJ	French Lambert
NT	New Zealand Map Grid
OC	Oblique Mercator
OD	Orthographic
PG	Polar Stereographic
PH	Polyconic
RC	Relative Coordinates
RS	Hotine Oblique Mercator (Rectified Skew Orthomorphic)
RX	Robinson
SA	Sinusoidal
SD	Oblique Stereographic
SX	Space Oblique Mercator
TC	Transverse Mercator
VA	Van der Grinten
VX	General Vertical Near-Side Perspective
ZY	Other Known Projection

NOTE 2 If the code "ZY" is used a Comment must be added to describe the projection type used.

B.4 Codes from ISO 19115 [24].

B.4.1 Date Type Code (ISO 19115 CI_DateTypeCode)

Code	Value	Identification of when a given event occurred
creation	1	Date identifies when the resource was brought into existence
publication	2	Date identifies when the resource was issued
revision	3	Date identifies when the resource was examined or re-examined and improved or amended

B.4.2 Role Code (ISO 19115 CI_RoleCode)

Code	Value	Identification of when a given event occurred
Resource Provider	1	Party that supplies the resource
Custodian	2	Party that accepts accountability and responsibility for the data and ensures appropriate care and maintenance of the resource
Owner	3	Party that owns the resource
User	4	Party who uses the resource
Distributor	5	Party who distributes the resource
Originator	6	Party who created the resource
Point Of Contact	7	Party who can be contacted for acquiring knowledge about or acquisition of the resource
Principal Investigator	8	Key party responsible for gathering information and conducting research
Processor	9	Party who has processed the data in a manner such that the resource has been modified
Publisher	10	Party who published the resource
Author	11	Party who authored the resource

B.4.3 Topic Category (ISO 19115 MD_TopicCategory)

Code	Value	Identification of when a given event occurred
Farming	1	Rearing of animals and/or cultivation of plants Examples: agriculture, irrigation, aquaculture, plantations, herding, pests and diseases affecting crops and livestock
Biota	2	Flora and/or fauna in natural environment Examples: wildlife, vegetation, biological sciences, ecology, wilderness, sealife, wetlands, habitat
Boundaries	3	Legal land descriptions Examples: political and administrative boundaries
Climatology / Meteorology / Atmosphere	4	Processes and phenomena of the atmosphere Examples: cloud cover, weather, climate, atmospheric conditions, climate change, precipitation
Economy	5	Economic activities, conditions and employment Examples: production, labour, revenue, commerce, industry, tourism and ecotourism, forestry, fisheries, commercial or subsistence

Code	Value	Identification of when a given event occurred
Elevation	6	Height above or below sea level Examples: altitude, bathymetry, digital elevation models, slope, derived products
Environment	7	Environmental resources, protection and conservation Examples: environmental pollution, waste storage and treatment, environmental impact assessment, monitoring environmental risk, nature reserves, landscape
Geoscientific Information	8	Information pertaining to earth sciences Examples: geophysical features and processes, geology, minerals, sciences dealing with the composition, structure and origin of the earth's rocks, risks of earthquakes, volcanic activity, landslides, gravity information, soils, permafrost, hydrogeology, erosion
Health	9	Health, health services, human ecology, and safety Examples: disease and illness, factors affecting health, hygiene, substance abuse, mental and physical health, health services
Imagery Base Maps Earth Cover	10	Base maps Examples: land cover, topographic maps, imagery, unclassified images, annotations
Intelligence Military	11	Military bases, structures, activities Examples: barracks, training grounds, military transportation, information collection
Inland Waters	12	Inland water features, drainage systems and their characteristics Examples: rivers and glaciers, salt lakes, water utilization plans, dams, currents, floods, water quality, hydrographic charts
Location	13	Positional information and services Examples: addresses, geodetic networks, control points, postal zones and services, place names
Oceans	14	Features and characteristics of salt water bodies (excluding inland waters) Examples: tides, tidal waves, coastal information, reefs
Planning Cadastre	15	Information used for appropriate actions for future use of the land Examples: land use maps, zoning maps, cadastral surveys, land ownership
Society	16	Characteristics of society and cultures Examples: settlements, anthropology, archaeology, education, traditional beliefs, manners and customs, demographic data, recreational areas and activities, social impact assessments, crime and justice, census information
Structure	17	Man-made construction Examples: buildings, museums, churches, factories, housing, monuments, shops, towers

Code	Value	Identification of when a given event occurred
Transportation	18	Means and aids for conveying persons and/or goods Examples: roads, airports/airstrips, shipping routes, tunnels, nautical charts, vehicle or vessel location, aeronautical charts, railways
Utilities Communication	19	Energy, water and waste systems and communications infrastructure and services Examples: hydroelectricity, geothermal, solar and nuclear sources of energy, water purification and distribution, sewage collection and disposal, electricity and gas distribution, data communication, telecommunication, radio, communication networks

Annex C (informative)

Services

C.1 Service definitions

C.1.1 Amusement Park

A park that contains rides or other entertainment which may be based on a central theme.

C.1.2 Airline Access

An airline's check-in area (if there is more than one terminal) at the airport.

C.1.3 Airport

An airfield which accommodates either cargo or passenger traffic of a commercial or private nature.

C.1.4 ATM

A computer terminal that allows bank customers to deposit, withdraw, or transfer funds without the assistance of a bank teller.

C.1.5 Bank

An institution for the transaction of monetary services.

In some countries the building societies and some post offices may be incorporated into this category.

C.1.6 Bowling Centre

A facility designed for bowling.

C.1.7 Business Facility

Location where the main activities of a particular business activity are concentrated.

C.1.8 Bus Station

A terminus where a person may board either a local bus service or a long distance or a national/international coach.

C.1.9 Camping

An official site where a tent may be pitched. The site need not be for sole use by tents.

C.1.10 Car Dealership

An establishment that sells cars.

C.1.11 Car Shipping Terminal

A location where cars may be loaded onto ferries for car shipping services.

C.1.12 Caravan Site

An official site where a caravan may be parked. The site need not be for sole use by caravans.

C.1.13 Cargo Centre

An access point for non-passenger goods, such as within an airport.

C.1.14 Casino

An establishment whose primary purpose is providing facilities for gambling.

C.1.15 Cinema

A facility used for showing movies to a large audience.

C.1.16 City Hall

City or Town Council Offices.

C.1.17 City Centre

The central activity point of a settlement or Administrative Area. It will typically be the town hall, central train station or other central activity centre (i.e. church or pedestrian District.)

C.1.18 Coach and Lorry Parking

A car park restricted for Coach and Lorry use only.

C.1.19 Community Centre

Facilities and activities for the benefit of the local community only. They typically cater to special interest groups such as youth, elderly, or "handicapped".

C.1.20 Court House

A building that houses courts of law.

C.1.21 Cultural Centre

A centre for cultural activities.

C.1.22 Customs

The customs house offices used for pre-registration or collection of goods. It is not used for customs points for checking disembarking passengers or vehicles.

C.1.23 Department Store

A large shop which sells different types of goods all from within the one shop.

EXAMPLE A store selling clothing, jewellery, household goods, or furniture.

C.1.24 Embassy

The office or residence of the ambassador and entourage of a foreign country.

C.1.25 Emergency Call Station

A free emergency telephone with a direct line to an emergency service centre.

C.1.26 Emergency Medical Service

A location where mobile medical help is stationed.

C.1.27 Exhibition or Conference Centre

Large building where large public shows are held or large groups of people meet for consultation or discussion.

C.1.28 Ferry Terminal

The access point or check-in area for a given ferry company.

C.1.29 Fire Brigade

A location where mobile crews and vehicles for firefighting and rescue operations are stationed.

C.1.30 First Aid Post

A location where First Aid is available.

C.1.31 Free Port

A shop or facility where products can be purchased under a reduced tariff structure.

C.1.32 Frontier Crossing

A border post between two countries.

C.1.33 Golf Course

A facility designated and maintained for playing golf.

C.1.34 Government Office

An office for local, regional or national government activities.

C.1.35 Historical Monument

A building, monument, or site with important historical or cultural value.

C.1.36 Hospital/Polyclinic

A place where medical and surgical treatment is provided for sick and injured persons.

C.1.37 Hotel or Motel

An establishment where lodging is available to all members of the public for one or more nights. The nature of the establishment need not necessarily be strictly a hotel. Places such as public houses, guesthouses and inns with available rooms may be included in this Feature. It excludes establishments offering accommodation to special needs groups such as socially disadvantaged persons. Also excluded are private rental accommodation establishments and holiday homes.

C.1.38 Kindergarten

A location for pre-school education for children.

C.1.39 Library

A place in which literary, musical, artistic, or reference materials are kept for use and circulation, but are not for sale.

C.1.40 Marina

A docking and service facility for pleasure craft.

C.1.41 Motoring Organisation Office

A national club or subscription-based organisation offering services and facilities for motorists.

C.1.42 Mountain Pass Summit

Point of greatest altitude of a mountain pass.

C.1.43 Museum

A building or place for the preservation and/or exhibition of artistic, historic or scientific objects.

C.1.44 Open Parking Areas

Ground-level car and commercial vehicle parking locations.

C.1.45 Parking Garage

A car park typically within a building. May be subterranean or multi-storey.

C.1.46 Petrol Station

A garage or service station offering petrol for sale.

C.1.47 Pharmacy

A place where general drugs and remedies are sold to the general public.

C.1.48 Place of Worship

A building where a member of the general public may go for prayer or to take part in a religious service.

C.1.49 Police Station

An office or facility for police.

C.1.50 Post Office

A public facility that provides postal or telecommunication services.

C.1.51 Public Phone

A phone which is available for public use. It may be within a building or on the street. It may be coin-operated or card-operated.

C.1.52 Railway Station

A facility for loading and unloading passengers and goods travelling on a rail network.

C.1.53 Recreation Facility

An outdoor area of land designated as open to the public for general recreation.

C.1.54 Rent-a-Car Pick Up/Return

Site for the pick up or return of rental cars.

C.1.55 Rest Area

A service located along freeways offering one or more recreational facilities or service functions to the car driver.

C.1.56 Restaurant

Any establishment offering meals for payment including sit down meals or fast food take-aways. Hotels or Public Houses may be included in this Feature.

C.1.57 Roadside Diner

A roadside location where parking is available and meals are served.

C.1.58 School

A building or location used for instructional classes. (See also University or College).

C.1.59 Shopping Centre

A large purpose-built building within which many individual shops trade.

C.1.60 Ski Lift Station

The start point of a ski lift: i.e. the downhill station of a ski lift.

C.1.61 Ski Resort

A downhill or cross-country ski facility.

C.1.62 Sports Centre

An indoor sports facility or an outdoor location where any sport such as golf, riding, sailing etc. may be enjoyed.

C.1.63 Stadium

An athletics tracks or sports ground with tiers of seats for spectators.

C.1.64 Swimming Pool

A facility specially designed for swimming or related water activities.

C.1.65 Theatre

A building or an outdoor area where performances of drama are given.

C.1.66 Toll Location

The location where a fee is paid to travel on a road.

C.1.67 Tourist Attraction

Any physical or natural Feature that may be of interest to a tourist.

C.1.68 Tourist Office

A location where advice can be obtained on local or national tourist attractions.

C.1.69 Transport Company

A transport company's offices or cargo points where transport services for cargo by road, rail, water or air are offered.

C.1.70 Travel Agency

An office that sells tickets for travel by rail, road, air or water for local, national or international travel.

C.1.71 University or College

An institution of higher education.

C.1.72 Vantage Point

A location specifically designated as having a scenic view.

C.1.73 Vehicle Repair Facility

A garage or service station open to the public where repairs on a vehicle are carried out.

C.1.74 Warehouse

A large building within which any goods or items may be stored for the short or long term.

C.1.75 Weigh Station

A facility operated by a Road Authority to weigh the load of commercial vehicles for the purposes of safety compliance and/or determining road usage charges.

C.1.76 Winery

A facility for wine making, which may also include wine tasting, wine sales, and winery tours.

C.1.77 Zoo

A location where wild animals are kept for educational reasons, and which is open for the public.

C.2 Feature Class Codes for Services

Theme Code	Class Code	Interpretation
73		Services
	7310	Vehicle Repair Facility
	7311	Petrol Station
	7312	Rent a Car Pick Up/Return
	7313	Parking Garage
	7314	Hotel or Motel
	7315	Restaurant
	7316	Tourist Office
	7317	Museum
	7318	Theatre
	7319	Cultural Centre
	7320	Sports Centre
	7321	Hospital/Polyclinic
	7322	Police Station
	7323	City Hall
	7324	Post Office
	7325	First Aid Post
	7326	Pharmacy
	7327	Department Store
	7328	Bank
	7329	Travel Agency
	7330	Public Phone
	7331	Warehouse
	7334	Ski-lift Station
	7336	Zoo
	7337	Vantage Point
	7338	Swimming Pool
	7339	Place of Worship
	7340	Transport Company
	7341	Casino
	7342	Cinema
	7343	Court House
	7344	Golf Course
	7345	Historical Monument

Theme Code	Class Code	Interpretation
	7346	Library
	7347	Marina
	7348	Ski Resort
	7349	Winery
	7350	Mountain Pass Summit
	7351	Cargo Centre
	7352	Ferry Terminal
	7355	Car Shipping Terminal
	7356	Airline Access
	7359	Weigh Station
	7360	Camping
	7361	Caravan Site
	7362	Coach and Lorry Parking
	7363	Community Centre
	7364	Customs
	7365	Embassy
	7366	Frontier Crossing
	7367	Government Office
	7368	Motoring Organization Office
	7369	Open Parking Areas
	7370	Recreation Facility
	7371	Roadside Diner
	7372	School
	7373	Shopping Centre
	7374	Stadium
	7375	Toll Location
	7376	Tourist Attraction
	7377	University or College
	7378	Business Facility
	7379	City Centre
	7380	Railway Station
	7383	Airport
	7384	Bus Station
	7385	Exhibition or Conference Centre
	7386	Kindergarten
	7390	Emergency Call Station
	7391	Emergency Medical Service
	7392	Fire Brigade
	7394	Free Port
	7395	Rest Area
	7396	Amusement Park
	7397	ATM
	7398	Car Dealership
	7399	Bowling Centre

Annex D (normative)

Syntax for Time Domains

D.1 Basic Time Domain description

Generally a Time Domain is composed of a Starting Date and/or a Time Duration with the following notation:

- [(Starting Date) {Time duration}].

'[' and ']' are mandatory, and exactly one of each shall be used to encase a basic Time Domain.

A time domain expression may contain any number of space and line break characters either side of its syntax elements '[' , '(' , ')' , '{' , '}' , ']' , '-' , '+' , '*' , as well as the various time terms. Time terms themselves, as the inner elements, shall not be broken-up.

EXAMPLE 1 [(M5d1){d1}], or likewise [(M5 d1) {d1}], means:

- Starting Date : any year, month 5 (May), day 1st, at 0: 00 : 00am.
- Duration : 1 complete day (i.e. 24 hours or 1440 minutes).

Alternatively a basic Time Domain may be composed of a Starting Date and an Ending Date with the following notation:

- [(Starting Date) (Ending Date)].

EXAMPLE 2 [(M5d1)(M5d2)] means :

- Starting Date : any year, month 5 (May), day 1st, at 0 :00 :00 am.
- Ending Date : any year, month 5 (May), day 2nd, at 0 :00 :00 am.

Special cases of a Time Domain are:

- A Starting Date without a specified duration, like [(h1)] for the begin of every full hour, and
- A time period specified by means of a Time Duration only, like [{h1}] for one hour elapsed time.

It is specific for each time domain-related Attribute Type whether the general syntax or one of the two special cases mentioned is appropriate for representing the respective time domain value. Note that both special cases have mandatory encasing brackets.

For time domain Attributes which expect both start date and duration, it is possible to provide only a start time, and the missing of the duration signifies an implicit "always" (post the Starting Date). When both are expected, a start date is mandatory (i.e. having only duration would be "wrong").

Minus signs '-' play also special role within the time syntax. A minus sign may precede the duration component, which changes the duration semantics into a negative duration: that is duration which "clocks backwards". A minus sign may precede a solitary start term (without a duration clause) when both where expected, and so the "always" duration implied (as in above) becomes "negative always", which then would read "always until the start time". There are other uses of minus signs within either term (those are explained

in their respective sections) and there are minus signs used in compound time expressions (and those are explained in that section).

D.2 Starting Date and Ending Date syntax

D.2.1 Introduction

Starting Dates and Ending Dates are defined by means of a set of graphical symbols allowing the description of “sharp” time terms: years, months, weeks, days, and so on down to the smallest time unit which is the second. Following afterwards are the “fuzzy” times, times which do not have a universal definition. Times, which while well defined, behave differently in different places and different times. The symbols shall be organized in a sequential order starting with the longest time unit, decreasing towards the smallest, and ending with the fuzzy time units. Valid symbol combinations are shown in Figure D.1. Note that (explicit) fuzzy time units overrule the (implicit) default reference time frame of a given sharp time unit (see D.2.2).

Next to the regular start-duration notation of fuzzy time unit constructions, a shorthand notation is allowed, for which examples are provided in D.4.3.

Each particular symbol is composed of a time type code which indicates a particular time unit (e.g. y for year) and a certain number of digits which represent the time values (up to 4 digits). The placeholders for these values use n's or x's, respectively, to indicate the maximum number of digits. Values from the allowable value domain may use fewer than the total of the indicated number of digits, leading to shorter time symbols. As the range of year values starts at 1000, always four digits shall be specified.

D.2.2 Sharp time terms

D.2.2.1 Year

yynnnn Defines a particular year. E.g., (y1991) means the year 1991. When no more information is given, (y1991) means 1st of January 1991 at 0: 00: 00 am.

D.2.2.2 Month

Mnn Defines a particular month within a particular year, or any year when no “y” information is given. The domain runs from 1 to 12, meaning January and December respectively. (M5) means every 1st of May at 0: 00: 00 am, whatever the year may be.

D.2.2.3 Week

wnn Defines a week within a previously defined year, or any year when no “y” information is given. The domain runs from 1 to 53 indicating week number 1 and week number 53 respectively. Week number 1 will often be a partial week (in years which do not start on a Sunday), as will week number 53 (in years which do not end on Saturday). Note that the begin of week number one may fall into the previous year; likewise, a weekday towards the end of week number 53 may fall into the subsequent year. Furthermore, note that the week numbering may deviate from commonly applied week numbering schemes. The ‘wnn’ symbol may be preceded by a minus sign (‘-wnn’). I.e. weeks which begin counting before the beginning of the year context (which is equivalent to weeks being counted backwards from the end of the previous year). In such a case, the (negative) count points to the begin of the last, last but one, etc. week in the previous year (or any year, as governed by the year context). Note that w1 and -w1 may resolve to the same week, comprising a set of 7 weekdays either side of New Year of the year context.

D.2.2.4 Day

Four different time type codes for a “Day” are defined. The code which shall to be used depends on whether a particular day in a month, a particular day of the week or a day in a particular week of a month needs to be represented.

dnn Defines a particular day within a particular month if previously defined with the “M” format. When no month information is given, (dnn) means the nth day in any month.

EXAMPLE 1 (...d14) means the 14th day in the previously defined month (if any), in the previously defined year (if any) at 0: 00: 00 am.

The domain runs from 1 to 28, 29, 30 or 31, depending on the month.

The ‘dnn’ symbol may be preceded by a minus sign (‘-dnn’ which stands for days counted backwards from the beginning of the month).

EXAMPLE 2 (...-d14) means the 14th day backwards from the beginning of the previously defined month (if any), in the previously defined year (if any) at 0: 00: 00 am.

A more specific example would be:

EXAMPLE 3 (M5-d14) which means April 17 at 0: 00: 00 am (any year).

tn Defines a particular weekday in a previously (if any) defined week. The tn symbol may repeat, as such allowing to specify multiple weekdays in a single basic Time Domain. Domain of values is the following: 1: Sunday, 2: Monday, 3: Tuesday, 4: Wednesday, 5: Thursday, 6: Friday, 7: Saturday and 8: Public Holiday.

EXAMPLE 4 (M5t2) means each Monday in the 5th month (May) of any year, at 0: 00: 00 am.

EXAMPLE 5 (t2t4) means each Monday and Wednesday, in any month of any year, at 0: 00: 00 am.

fxn Defines a particular weekday in a previously (if any) defined month, with the following rules: n is used as in the “t” format with the same domain of values (except for 8), 1: Sunday up to 7: Saturday. For “x” one of the following values shall be substituted: 1: first, 2: second, 3: third, 4: fourth, and 5: fifth. (Note that “the fifth” may not be applicable for certain months/weekday combinations).

EXAMPLE 6 (...f12) means the first Monday at 0: 00: 00 am.

lxn Defines a particular weekday in a previously (if any) defined month, with the following rules: n is used as for the “t” format with the same domain of values (except for 8),, 1: Sunday up to 7: Saturday. x shall be chosen from the following set: 1: last, 2: last but one, 3: last but two, 4: last but three, and 5: last but four. (Note that “the last but four” may not be applicable for certain months/weekday combinations).

EXAMPLE 7 (...l12) means the last Monday at 0: 00: 00 am.

D.2.2.5 Hour

hnn Defines a particular hour within a particular day (if previously defined). When no day is specified, it means that every day is valid. The domain runs from 0 to 23.

EXAMPLE 1 (d12h6) means every 12th day of a month at 6: 00: 00 am.

The ‘hnn’ symbol may be preceded by a minus sign (‘-hnn’ which stands for hours counted backwards from the beginning (midnight) of the previously defined day (if any), within the previously defined context (if any)).

EXAMPLE 2 (d12-h3) means every 11th day of a month at 9: 00: 00 pm.

D.2.2.6 Minute

mnn Defines a particular minute within a particular hour (if previously defined). When no hour is defined, it means that any hour is valid. The domain runs from 0 to 59.

EXAMPLE 1 (d12h6m30) means every 12th day of a month at 6: 30: 00 am.

The 'mnn' symbol may be preceded by a minus sign ('-mnn' which stands for minutes counted backwards from the beginning of the previously defined hour (if any), within the previously defined context (if any)).

EXAMPLE 2 (d12h6-m15) means every 12th day of a month at quarter of 6 :00 :00 am or 5 :45 :00am.

D.2.2.7 Second

snn Defines a particular second within a particular minute (if previously defined). When no minute is specified, it means that any minute is valid. nn domain is from 0 to 59.

EXAMPLE 1 (d12h6m30s52) means every 12th day of a month at 6: 30: 52 am.

The 'snn' symbol may be preceded by a minus sign ('-snn' which stands for seconds counted backwards from the beginning of the previously defined minute (if any), within the previously defined context (if any)).

EXAMPLE 2 (d12h6m31-s8) means every 12th day of a month at 6: 30: 52 am.

D.2.3 Fuzzy time terms

znn Defines a fuzzy time term within the preceding sharp time (for any symbols equal or greater than the applicable reference time frame, if previously specified) and/or which serves as context for predefined sharp time (for any symbols smaller than the applicable reference time frame, if previously specified). When no previous time is specified, it means that any occurrence of the fuzzy term is valid.

EXAMPLE 1 (z15) means the beginning of peak hours on any day in any month in any year

EXAMPLE 2 (M12z15) means the beginning of peak hours in December in any year.

Sharp symbols like dnn, hnn, mnn, etc may evaluate relative to a fuzzy context, if their default reference time frame is not present.

EXAMPLE 3 (d3s5) means beginning of third day of winter (default context for dnn would be day of month)

EXAMPLE 4 (-m30z15) means 30 minutes before beginning of peak hours (default context for mnn would be hour in a day).

The 'znn' symbol may be preceded by a minus sign ('-znn'); unlike for sharp time symbols, the minus sign alters the symbol semantics from 'starts (or ends) at beginning of' to 'starts (or ends) at end of'.

EXAMPLE 5 (M12-z15) means the end of peak hour in December in any year

EXAMPLE 6 (-m30-z15) means 30 minutes before end of peak hour

D.2.4 Summarizing table of all "sharp" symbols

time unit	reference time frame	notation	value domain	explanation of values
Year		ynnnn	1000...9999	any year
Month	in a Year*	Mnn	1...12	January, February, etc. to December
Week	in a Year*	(-)wnn	1...53	
Day	in a Month*	(-)dnn	1...28/29/30/31	Maximum value depends on the month
Day	of the Week	tn	1...8	Sunday(=1) to Saturday (=7), and Public Holiday (=8)

time unit	reference time frame	notation	value domain	explanation of values
Weekday	in a Month	fxn	x: 1...5 n: 1...7	first, second, etc. weekday of the month Sunday to Saturday
Weekday	in a Month	lxn	x: 1...5 n: 1...7	last, last but one, etc. weekday of the month Sunday to Saturday
Hour	of the day*	(-)hnn	0...23	24 hours format
Minute	of an hour*	(-)mnn	0...59	
Second	of a minute	(-)snn	0...59	

* Sharp symbol may evaluate relative to an applicable fuzzy context, if their default reference time frame is not present.

D.2.5 Summarizing table of “fuzzy” symbols

time unit	reference time frame	notation	value domain	explanation of values (terms in parenthesis apply when minus in use)
External	Any	(-)z0		Starting/ending (at the end) of a period controlled by external device. EXAMPLE 1 Devices in the Korean city of Kwatchen which use digital signs to control flow of traffic. EXAMPLE 2 Ramps which regulate access by means of centralized traffic control in the US.
Sunrise	Within a day	(-)z1		Starts/ends at Sunrise (Sunset)
Sunset	Within a day	(-)z2		Starts/ends at Sunset (Sunrise)
School	Within a year, week, or day	(-)z3		Starts/ends at (the end of) any school period (date and hour)
Holiday	Within a year	(-)z4		Starts/ends at (the end of) any Holiday
Winter	Within a year	(-)z5		Beginning/ending of (the end of) Winter
Spring	Within a year	(-)z6		Beginning/ending of (the end of) Spring
Summer	Within a year	(-)z7		Beginning/ending of (the end of) Summer
Autumn	Within a year	(-)z8		Beginning/ending of (the end of) Autumn
High Tide	Within a day	(-)z9		Starts/ends at (the end of) High Tide
Low Tide	Within a day	(-)z10		Starts/ends at (the end of) Low Tide
High Water	Within a year	(-)z11		Starts/ends at (the end of) River High Water
Low Water	Within a year	(-)z12		Starts/ends at (the end of) River Low Water
Wet Season	Within a year	(-)z13		Starts/ends at (the end of) Wet Season (Rainy Season)
Dry Season	Within a year	(-)z14		Starts/ends at (the end of) Dry Season
Peak Hours	Within a year, month, week, or a day	(-)z15		Starts/ends at (the end of) Peak Hours: Peak hours include rush hour and activity / scheduled event based times. These would vary by location and by season. Peak hours are applicable not only to road networks but ferries as well. EXAMPLE 1 Activities like shopping, beach going, and skiing.

time unit	reference time frame	notation	value domain	explanation of values (terms in parenthesis apply when minus in use)
Off-Peak Hours	Within a year, month, week, or a day	(-)z16		EXAMPLE 2 Scheduled events like parades, sporting events, concerts, conventions. Starts/ends at (the end of) Off-Peak Hours
Rain/wet conditions	Any	(-)z17		Starts/ends at (the end of) Rain/wet conditions
Snow	Any	(-)z18		Starts/ends at (the end of) Snow
Fog	Any	(-)z19		Starts/ends at (the end of) Fog
Dust	Any	(-)z20		Starts/ends at (the end of) Dust
Dawn	Within a day	(-)z21		Starts/ends at (the end of) Dawn
Dusk	Within a day	(-)z22		Starts/ends at (the end of) Dusk
User Defined	Any	(-)z23– (-)z49		User Defined Starting/ending Fuzzy types

D.2.6 Valid format combinations and default values for Starting Dates and Ending Dates

D.2.6.1 General aspects of the combination of Starting Date and Ending Dates formats

Starting Dates and Ending Dates, which are composed of several time units (e.g. 14th of November 1991), are defined by placing the symbols sequentially in a hierarchical order.

However, some constraints have to be taken into account.

Valid possible symbol sequences are shown in Figure D.1.

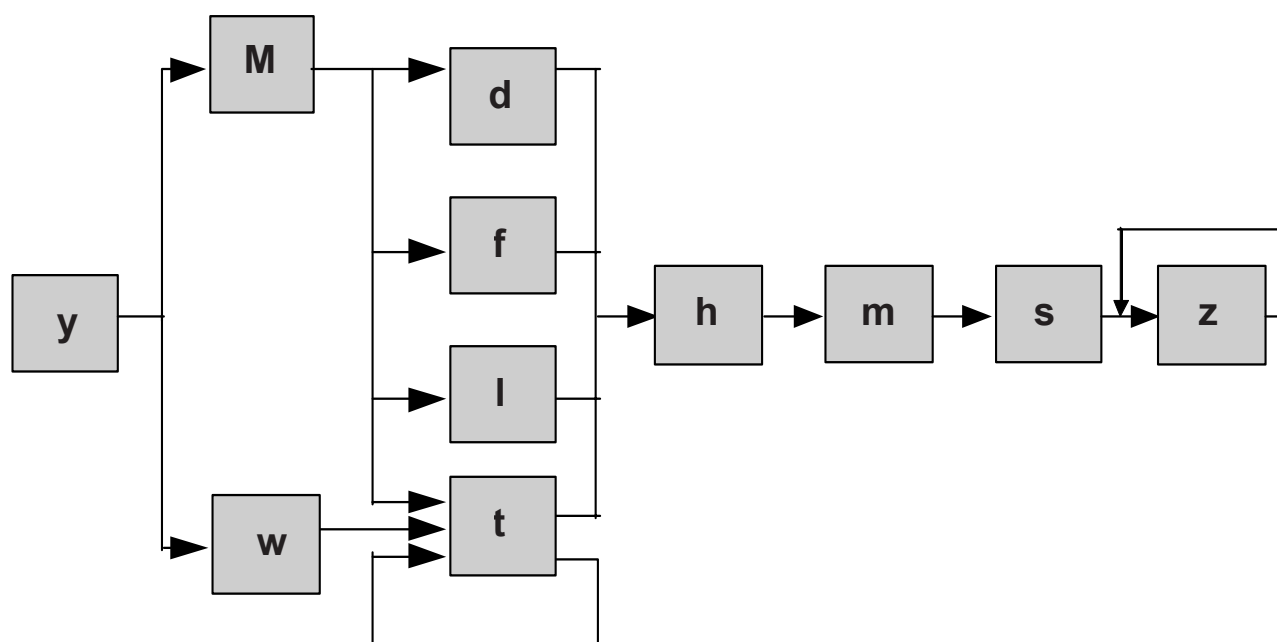

Figure D.1 — Valid symbol combinations of starting dates and ending dates

A minus sign “-” may precede the ‘w’, ‘d’, ‘h’, ‘m’, or ‘s’ terms to allow for subtractive values. A minus sign “-” may precede the ‘z’ term(s) to toggle between fuzzy term beginning and ending as the applicable starting/ending date.

If not all time type codes of a format combination are used (e.g. only a week and an hour are specified), default values are adopted for the undefined time units. For the fuzzy times, the default value is non-presence.

D.2.6.2 General rule for default values

To find the default value for a particular time unit that is undefined in a Starting Date sequence or Ending Date sequence, respectively, a distinction has to be made whether the missing time type code is a “final” one or not.

- “Final” time type codes: For all time type codes that are missing at the end of a sequence, the default value is the lowest possible value (i.e. M1, w1, d1, h0, m0, and s0). If no “Day” is specified (i.e. none of the “d, t, f, l” formats are used) within a defined year and/or month, the default time code and the default value is d1.
- “Other” time type codes: If time type codes are missing at the beginning of a sequence or between defined time units, this means that all values of the missing time code are valid (generally resolving to “any”).

EXAMPLE 1 (y1994t1) means year 1994, any month/any week, each Sunday (t1), time 00: 00: 00 am.

EXAMPLE 2 (w9h11m30) means 9th week of any year, any day in this week, 11: 30 : 00 am.

EXAMPLE 3 (-w9h11m30) means 9th week from the end of (the previous year of) any year, any day in this week, 11 :30 :00 am

EXAMPLE 4 (M4) means any year, 1st of April, time 00: 00: 00 am.

EXAMPLE 5 (M4m33) means any year, April, any day of April, any hour at 33 minutes and 0 seconds.

EXAMPLE 6: (M4-m27) means any year, April, any day of April, any hour at 33 minutes and 0 seconds.

EXAMPLE 7 (y1994t1z1) means Year 1994, any month / any week, each Sunday (t1), at the fuzzy time when Sunrise begins.

Since the fuzzy value of Dawn contains in it the notion of “lower order” sharp, Hours, Minutes, and Seconds are not set to their usual default values.

NOTE 1 The other fuzzy values which are missing (such as z13 or z27) are simply ignored and no default value is substituted for them.

EXAMPLE 8 (w9z3) means 9th week of any year, any day in this week, at the time at which the school period begins on each of these days (if school is in session on that particular day).

EXAMPLE 9 (M4z4) means any year in the Month of April, at each time in which a Holiday begins. If there are no Holidays in the Month of April, this is an empty reference.

D.2.6.3 Detailed description of possible combinations and default values

y: If no additional “M, w, d, t, f, l, h, m, s” information is given, the default value is M1d1h0m0s0 for the 1st of January at 0: 00: 00 am in the defined year. The presence of “z” information may change the default value if “y” is an applicable reference frame for the “z” information at hand.

M: If no additional “y” information is given, it means that any year is valid. If no additional “d, t, f, l, h, m, s” information is given, the default value is d1h0m0s0 for the 1st day in the defined month at 0: 00: 00 am. The presence of “z” information may change the default value if “M” is an applicable reference frame for the “z” information at hand. No “w” format can be used in combination with the “M” format.

w: If no “y” extra information is given, it means any year is valid. If no “t, h, m, s” extra information is given, the implicit value is t1h0m0s0 for Sunday in the defined week at 0: 00: 00 am. The presence of “z” information may change the default value if “w” is an applicable reference frame for the “z” information at hand. No “M, d, l, f” format can be used in combination with the “w” format.

- d: If no additional “y” and/or “M” information is given, it means that any month and/or any year is valid. If no additional “h, m, s” information is given, the default value is h0m0s0 for 0: 00: 00 am on the defined day. The presence of “z” information may change the default value if “d” is an applicable reference frame for the “z” information at hand. No “w, t, l, f” format can be used in combination with the “d” format.
- t: If no additional “y” and/or “M” or “w” information is given, it means that any month or any week and/or any year is valid. If no “h, m, s” extra information is given, the default value is h0m0s0 for 0: 00: 00 am on the defined day. The presence of “z” information may change the default value if “t” is an applicable reference frame for the “z” information at hand. No “d, l, f” format can be used in combination with the “t” format.
- f: If no “y” and/or “M” information is given, it means that any month and/or any year is valid. If no additional “h, m, s” information is given, the default value is h0m0s0 for 0: 00: 00 am on the defined day. The presence of “z” information may change the default value if “f” is an applicable reference frame for the “z” information at hand. No “w, d, t, l” format can be used in combination with the “f” format.
- l: If no “y” and/or “M” information is given, it means that any month and/or any year is valid. If no “h, m, s” extra information is given, the default value is h0m0s0 for 0: 00: 00 am on the defined day. The presence of “z” information may change the default value if “l” is an applicable reference frame for the “z” information at hand. No “w, d, t, f” format can be used in combination with the “l” format.
- h: If no “y, M, w, d, t, l, f” information is given, it means that any day is valid. If no “m, s” information is given, the default value is m0s0 in the hour in question. The presence of “z” information may change the default value if “h” is an applicable reference frame for the “z” information at hand.
- m: If no “y, M, w, d, t, l, f” information is given, it means that any day is valid. If no “h” information is given, it means that any hour in the previously defined day is valid. If no “s” information is given, the default value is s0 in the minute in question. The presence of “z” information may change the default value if “m” is an applicable reference frame for the “z” information at hand.
- s: If no “y, M, w, d, t, l, f” information is given, it means that any day is valid. If no “h” information is given, it means that any hour in the previously defined day is valid. If no “m” information is given, it means that any minute in the previously defined hour is valid. The presence of “z” information may change the default value if “s” is an applicable reference frame for the “z” information at hand.

NOTE In the list below of fuzzy symbols, symbols numbered z50 and higher correspond to fuzzy duration symbols (see D.3.3), the counterparts of the fuzzy start symbols numbered z0 and higher.

- z0,
z50: [External] Since the extent of the time specified externally is not yet determined, it is difficult to assign default values. The “logically correct” behaviour is expected.
- z1,
z51: [Sunrise to Sunset] If no “y, M, w, d, t, l, f” information is given, it means that any day applies (either as a start time or as a duration time). “h, m, s” information should not be provided.
- z2,
z52: [Sunset to Sunrise] If no “y, M, w, d, t, l, f” information is given, it means that any day applies (either as a start time or as a duration time). “h, m, s” information should not be provided.
- z3,
z53: [School] If no “y, M, w, d, t, l, f” information is given, it means that any day when school is in session applies (either as a start time or as a duration time). If “y, M, w, d, t, l, f” information is completely given, and z3 is present, “h, m, s” may not be provided, since z3 is the actual equivalent to the “h, m, s” of the beginning of the time during the day of the school session. If no “y, M, w, d, t, l, f” information is given, and z3 is present, “h, m, s” may be provided. If “h, m, s” information is provided it designates the start time within the school session day already specified.
- z4,

- z54: [Holiday] If no “y, M, w, d, t, l, f” information is given, it means that any holiday day applies (either as a start time or as a duration time). If “h, m, s” information is provided it designates the start time within the holiday day already specified.
- z5,
z55: [Winter] If no “y, d, t, l, f” information is given, it means that any Winter day applies (either as a start time or as a duration time). “M, w” information may not be specified together with z5. If “h, m, s” information is provided it designates the start time within the Winter day(s) already specified.
- z6,
z56: [Spring] If no “y, d, t, l, f” information is given, it means that any Spring day applies (either as a start time or as a duration time). “M, w” information may not be specified together with z6. If “h, m, s” information is provided it designates the start time within the Spring day(s) already specified.
- z7,
z57: [Summer] If no “y, d, t, l, f” information is given, it means that any Summer day applies (either as a start time or as a duration time). “M, w” information may not be specified together with z7. If “h, m, s” information is provided it designates the start time within the Summer day(s) already specified.
- z8,
z58: [Autumn] If no “y, d, t, l, f” information is given, it means that any Autumn day applies (either as a start time or as a duration time). “M, w” information may not be specified together with z8. If “h, m, s” information is provided it designates the start time within the Autumn day(s) already specified.
- z9,
z59: [High Tide] If no “y, M, w, d, t, l, f” information is given, it means that any day applies (either as a start time or as a duration time). “h, m, s” information should not be provided.
- z10,
z60: [Low Tide] If no “y, M, w, d, t, l, f” information is given, it means that any day applies (either as a start time or as a duration time). “h, m, s” information should not be provided.
- z11,
z61: [High Water] If no “y, d, t, l, f” information is given, it means that any High Water day applies (either as a start time or as a duration time). “M, w” information may not be specified together with z11. If “h, m, s” information is provided it designates the start time within the High Water day(s) already specified.
- z12,
z62: [Low Water] If no “y, d, t, l, f” information is given, it means that any Low Water day applies (either as a start time or as a duration time). “M, w” information may not be specified together with z12. If “h, m, s” information is provided it designates the start time within the Low Water day(s) already specified.
- z13,
z63: [Wet Season] If no “y, d, t, l, f” information is given, it means that any Wet Season day applies (either as a start time or as a duration time). “M, w” information may not be specified together with z13. If “h, m, s” information is provided it designates the start time within the Wet Season day(s) already specified.
- z14,
z64: [Dry Season] If no “y, d, t, l, f” information is given, it means that any Dry Season day applies (either as a start time or as a duration time). “M, w” information may not be specified together with z14. If “h, m, s” information is provided it designates the start time within the Dry Season day(s) already specified.
- z15,
z65: [Peak Hours] If no “y, M, w, d, t, l, f” information is given, it means that any day is valid. “h, m, s” information should not be provided.

- z16,
z66: [Off-Peak Hours] If no "y, M, w, d, t, l, f" information is given, it means that any day is valid. "h, m, s" information should not be provided.
- z17,
z67: [Rain/wet conditions] if no "y, M, w, d, t, l, f" information is given, it means that any day is valid. "h, m, s" information should not be provided.
- z18,
z68: [Snow] if no "y, M, w, d, t, l, f" information is given, it means that any day is valid. "h, m, s" information should not be provided.
- z19,
z69: [Fog] if no "y, M, w, d, t, l, f" information is given, it means that any day is valid. "h, m, s" information should not be provided.
- z20,
z70: [Dust] if no "y, M, w, d, t, l, f" information is given, it means that any day is valid. "h, m, s" information should not be provided.
- z21,
z71: [Dawn] If no "y, M, w, d, t, l, f" information is given, it means that any day applies (either as a start time or as a duration time). "h, m, s" information should not be provided.
- z22,
z72: [Dusk] If no "y, M, w, d, t, l, f" information is given, it means that any day applies (either as a start time or as a duration time). "h, m, s" information should not be provided.

D.2.6.4 Table of allowed and forbidden format combinations

The following table shows valid combinations of Starting Date formats. For each format A of the first column all possible formats B that can follow in a Starting Date sequence are marked by an "*" in the corresponding line. Since the table is too large to fit on the page in one piece, it is broken down to 4 quadrants.

EXAMPLE (M5w1) week 1 in month 5 (May) is not correct, but (y1991w1) week 1 in year 1991 is allowed.

	<i>B</i>	<i>y</i>	<i>M</i>	<i>w</i>	<i>d</i>	<i>t</i>	<i>f</i>	<i>l</i>	<i>h</i>	<i>m</i>	<i>s</i>
<i>A</i>											
<i>y</i>		*	*	*	*	*	*	*	*	*	*
<i>M</i>			*	*	*	*	*	*	*	*	*
<i>w</i>				*	*	*	*	*	*	*	*
<i>d</i>					*	*	*	*	*	*	*
<i>t</i>						*	*	*	*	*	*
<i>f</i>							*	*	*	*	*
<i>l</i>								*	*	*	*
<i>h</i>									*	*	*
<i>m</i>										*	*
<i>s</i>											*

z	B	z0	z1	z2	z3	z4	z5	z6	z7	z8	z9	z10	z11	z12	z13	z14	z15	z16	z17	z18	z19	z20	z21	z22
A																								
y		*	*	*	*	*	*	*	*	*	*	*	*	*	*	*	*	*	*	*	*	*	*	*
M		*	*	*	*					*	*						*	*	*	*	*	*	*	*
w		*	*	*	*					*	*						*	*	*	*	*	*	*	*
d		*	*	*	*	*	*	*	*	*	*	*	*	*	*	*	*	*	*	*	*	*	*	*
t		*	*	*	*	*	*	*	*	*	*	*	*	*	*	*	*	*	*	*	*	*	*	*
f		*	*	*	*	*	*	*	*	*	*	*	*	*	*	*	*	*	*	*	*	*	*	*
l		*	*	*	*	*	*	*	*	*	*	*	*	*	*	*	*	*	*	*	*	*	*	*
h				*	*	*	*	*	*			*	*	*	*									
m				*	*	*	*	*	*			*	*	*	*									
s				*	*	*	*	*	*			*	*	*	*									

Since the 3rd quadrant of this table provides no additional information over the 2nd quadrant, it is omitted from this manuscript.

z	B	z0	z1	z2	z3	z4	z5	z6	z7	z8	z9	z10	z11	z12	z13	z14	z15	z16	z17	z18	z19	z20	z21	z22
A																								
z0																								
z1				*	*	*	*	*	*			*	*	*	*									
z2				*	*	*	*	*	*			*	*	*	*	*	*							
z3		*	*			*	*	*	*	*	*	*	*	*	*	*			*	*	*	*	*	*
z4		*	*			*	*	*	*	*	*	*	*	*	*	*			*	*	*	*	*	*
z5		*	*	*	*		*	*	*	*	*	*					*	*	*	*	*	*	*	*
z6		*	*	*	*	*	*	*	*	*	*	*					*	*	*	*	*	*	*	*
z7		*	*	*	*	*	*	*	*	*	*	*					*	*	*	*	*	*	*	*
z8		*	*	*	*	*	*	*	*	*	*	*					*	*	*	*	*	*	*	*
z9				*	*	*	*	*	*			*	*	*	*									
z10				*	*	*	*	*	*			*	*	*	*									
z11		*	*	*	*					*	*				*	*	*	*	*	*	*	*	*	*
z12		*	*	*	*					*	*				*	*	*	*	*	*	*	*	*	*
z13		*	*	*	*					*	*	*	*				*	*	*	*	*	*	*	*
z14		*	*	*	*					*	*	*	*				*	*	*	*	*	*	*	*
z15						*	*	*	*			*	*	*	*									
z16						*	*	*	*			*	*	*	*									
z17				*	*	*	*	*	*			*	*	*	*					*	*	*		
z18				*	*	*	*	*	*			*	*	*	*					*	*	*		
z19				*	*	*	*	*	*			*	*	*	*					*	*	*		
z20				*	*	*	*	*	*			*	*	*	*				*	*	*			
z21				*	*	*	*	*	*			*	*	*	*									*
z22				*	*	*	*	*	*			*	*	*	*	*	*							*

D.2.6.5 Starting Date examples

“14th November 1991 (at 0: 00: 00 am)”:
(y1991M11d14).

“Every 2nd of May at 5: 31 pm (any year, default second=00)”:
(M5d2h17m31).

“Each last Sunday in February (any year, at 0: 00: 00 am)”:
(M2l11).

“Monday in week 41 year 1991 (at 0: 00: 00 am)”:
(y1991w41t2).

“July 1962 (by default the 1st of July at 0: 00: 00 am)”
(y1962M7).

“Start of High Tide on 14th November 1991”:
(y1991M11d14z9).

“Every 2nd day of any month during the Wet Season at 5: 31 pm (any year, default second=00)”:
(d2h17m31z63).

“Each last Sunday in February at the onset of Peak Hours (rush hours) (any year, at 0: 00: 00 am)”:
(M2I11z15).

“Monday at onset of Dusk during Spring in the year 1991”:
(y1991t2z2z56).

D.3 Time duration syntax

D.3.1 Introduction

The syntax specified in this sub-clause enables the description of intervals by means of a set of symbols representing the time duration units year, month, week, day, hour, minute, second, and the collection of fuzzy time markers. Together with a starting date, the interval constitutes a basic Time Domain.

The symbols have to be organized in a sequential order starting with the longest time unit, decreasing towards the smallest, and ending with the fuzzy time units. Valid symbol combinations are shown in Figure D.2. Interpretation shall follow this logical sequence from left to right. Despite fuzzy time units always being last in order, the strictly cumulative duration of combined sharp and fuzzy time units may in special cases extend beyond the end of the fuzzy time unit (see D.3.7.5 for an example).

Given that year and month do not have a constant duration, their interpretation in order to determine the effective Ending Date depends on the applicable Starting Date context. As an exception, the impact of occasional UTC leap seconds which are being introduced from time to time (extending the last minute of a particular month by one second) are not taken into account.

The symbol is composed of a duration type code, which indicates a particular time duration unit (e.g. y for year) and up to 2 digits which are destined for the time duration values. Values from the allowable value domain may use a single digit only, leading to shorter time symbols.

If the ‘{’ (which is the start designator of the Time Duration expression) preceded by a minus sign, it means that the cumulative duration is counted in the reverse order. Inside the Time Duration expression, the minus sign applies to single terms.

D.3.2 Sharp time terms

D.3.2.1 Years

y_{nn}: Defines a duration of *nn* years.

EXAMPLE 1 [(y1991M11d14h5m30s19){y1}] means from 14 November 1991, 5: 30: 19 am to 14 November 1992, 5: 30: 19 am.

If there is no identical calendar date in the year in question, which occurs only for February the 29th, “plus 1 year” leads to February the 28th of the following year. Notice that {y1} = {M12}.

D.3.2.2 Months

M_{nn}: Defines a duration of *nn* months.

EXAMPLE 1 [(y1991M11d14h5m30s19){M3}] means from 14 November 1991, 5: 31: 19 am to 14 February 1992, 5: 30: 19 am.

If there is no identical calendar date in the target month in question, the last day in this month should become the target calendar day.

EXAMPLE 2 31st of January plus 1 month leads to 31st of February, which is not correct. According to the rule mentioned above, 31 January plus 1 month leads to 28 or 29 February depending on the year.

EXAMPLE 3 [(y1991M11d14h5m30s19){-M3}] means from 14 November 1991, 5: 30: 19 am backwards to 14 August 1991, 5: 30: 19 am.

EXAMPLE 4 [(y1991M11d14h5m30s19)(y1991M8d14h5m30s19)] means from 14 November 1991, 5: 30: 19 am backwards to 14 August 1991, 5: 30: 19 am.

EXAMPLE 5 [(y1991M11d14h5m30s19){M1d2}] means from 14 November 1991, 5: 30: 19 am add one month and then add 2 days which yields 16 December 1991, 5: 30: 19 am.

D.3.2.3 Weeks

wnn: Defines a duration of nn weeks, i.e. nn*7 days.

EXAMPLE [(y1991M11d14h5m30s19){w2}] means from 14 November 1991 at 5: 30: 19 am to 28 November 1991, 5: 30: 19 am. Notice that {w1} = {d7}.

D.3.2.4 Days

dnn: Defines a duration of nn days, i.e. nn*24 hours.

EXAMPLE [(y1991M11d14h5m30s19){d2}] means from 14 November 1991 at 5: 30: 19 am to 16 November 1991, 5: 30: 19 am. Notice that {d1} = {h24}.

D.3.2.5 Hours

hnn: Defines a duration of nn hours, i.e. nn*60 minutes.

EXAMPLE [(y1991M11d14h5m30s19){h10}] means from 14 November 1991, 5: 30: 19 am to 14 November 1991 at 3: 30: 19 pm. Notice that {h1} = {m60}.

D.3.2.6 Minutes

mnn: Defines a duration of nn minutes, i.e. nn*60 seconds.

EXAMPLE [(y1991M11d14h5m30s19){m11}] means from 14 November 1991 at 5: 30: 19 am to 14 November 1991 at 5: 41: 19 am. Notice that {m1} = {s60}.

D.3.2.7 Seconds

snn: Defines a duration of nn seconds.

EXAMPLE [(y1991M11d14h5m30s19){s21}] means from 14 November 1991 at 5: 30: 19 am to 14 November 1991 at 5: 30: 40 am. Notice that {m1} = {s60}.

D.3.3 Fuzzy time terms

znnn Defines a fuzzy time duration. The domain for nn ranges from 50 to 99 (see D.3.5 for fuzzy time semantics).

EXAMPLE 1 {z55} means during Winter.

The ‘znnn’ symbol may be preceded by a minus sign (‘-znnn’); unlike for sharp time symbols, the minus sign alters the symbol semantics to become the complementary.

EXAMPLE 2 {-z55} means during non-Winter.

D.3.4 Summarizing table of all “sharp” symbols

time unit	notation	Value domain	substitutions	remarks
Year	(-)ynn	0...99		If there is no existing identical calendar date in the target year, the last day of the target month will be seen as the target calendar day (can occur for starting date February 29th)
Month	(-)Mnn	0...99	{M12} = {y1}	If there is no existing identical calendar date in the target month, the last day of this month will be seen as the target calendar day.
Week	(-)wnn	0...99		
Day	(-)dnn	0...99	{d7} = {w1}	
Hour	(-)hnn	0...99	{h24} = {d1}	
Minute	(-)mnn	0...99	{m60} = {h1}	
Second	(-)snn	0...99	{s60} = {m1}	

D.3.5 Summarizing table of “fuzzy” symbols

time unit	Reference time frame	notation	value domain	explanation of values (terms in parenthesis apply when minus in use)
External	Any	(-)z50		Duration (complement) period controlled by external device. EXAMPLE 1 Devices in the Korean city of Kwatchen which use digital signs to control flow of traffic. EXAMPLE 2 Ramps which regulate access by means of centralized traffic control in the US.
Sunrise till Sunset	Within a “day”	(-)z51		Duration (complement) of Sunrise till Sunset
Sunset till Sunrise	Within a “day”	(-)z52		Duration (complement) of Sunset till Sunrise
School	Within a year, week, or day	(-)z53		Duration (complement) of School time (a possibly non contiguous duration)
Holiday	Within a year	(-)z54		Duration (complement) of Holiday (a possibly non contiguous duration)
Winter	Within a “year”	(-)z55		Duration (complement) of Winter
Spring	Within a “year”	(-)z56		Duration (complement) of Spring
Summer	Within a “year”	(-)z57		Duration (complement) of Summer
Autumn	Within a “year”	(-)z58		Duration (complement) of Autumn
High Tide	Within a “day”	(-)z59		Duration (complement) of “High Tide”
Low Tide	Within a “day”	(-)z60		Duration (complement) of “Low Tide”
High Water	Within a “year”	(-)z61		Duration (complement) of “River High Water” period

time unit	Reference time frame	notation	value domain	explanation of values (terms in parenthesis apply when minus in use)
Low Water	Within a "year"	(-)z62		Duration (complement) of "River Low Water" period
Wet Season	Within a "year"	(-)z63		Duration (complement) of Wet Season (Rainy Season)
Dry Season	Within a "year"	(-)z64		Duration (complement) of Dry Season
Peak Hours	Within a year, month, week, or a day	(-)z65		Duration (complement) of Peak Hours (Rush hours on freeway for instance) (a possibly non-contiguous duration).
Off-Peak Hours	Within a year, month, week, or a day	(-)z66		Duration (complement) of Off-Peak Hours (a possibly non-contiguous duration)
Rain/wet conditions	Any	(-)z67		Duration (complement) of Rain/wet conditions
Snow	Any	(-)z68		Duration (complement) of Snow
Fog	Any	(-)z69		Duration (complement) of Fog
Dust	Any	(-)z70		Duration (complement) of Dust
Dawn	Within a "day"	(-)z71		Duration (complement) of Dawn
Dusk	Within a "day"	(-)z72		Duration (complement) of Dusk
User Defined	Any	(-)z73– (-)z99		User Defined Durations (complement) of Fuzzy types
Always	Any	(-)z100		Duration of always (never)

D.3.6 Valid format combinations and default values for Time Durations

D.3.6.1 Combination of periods

Time periods which are composed of several time duration units are represented by listing the individual symbols sequentially in hierarchical order:

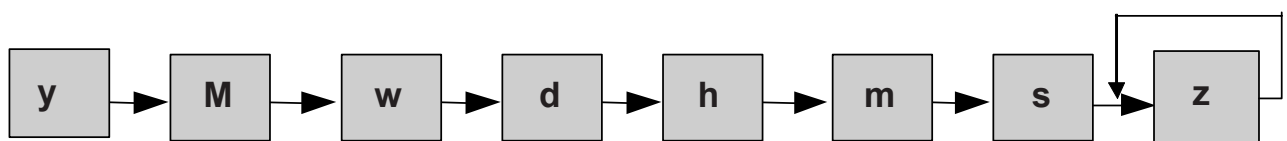

Figure D.2 — Combination of periods

The total time duration of a particular combination of symbols is the sum of all single time intervals.

EXAMPLE 1 {y2M1w2} means a period of 2 years, 1 month and 2 weeks.

EXAMPLE 2 {y2-M1w2} means a period of 2 years, take away 1 month and then add 2 weeks.

EXAMPLE 3 {y2-M1-w2} means a period of 2 years, take away 1 month and then take away (additionally) 2 weeks. Note that the finally 2 weeks subtraction isn't from the 1 month term, but from the entire cumulative term (in a strict left to right deployment).

D.3.6.2 Default values

The default value for each missing time type value in a sequence of basic time intervals is 0 (zero). The default value for a fuzzy time duration is non-presence.

D.3.7 Time Domain examples

D.3.7.1 “From 9am to 1pm every day”

Starting date is any year, any month, any day, at 9: 00: 00 am

{h9}

Duration is 4 hours.

{h4}

So that the complete expression is:

[(h9){h4}]

Another way to make an equivalent statement is

[(h13){-h4}]

As well as

[(h13){-h4}]

Yet another way to make an equivalent statement is

[(h9)(h13)]

D.3.7.2 “From 19: 30 to 22: 00 every Friday in March”

Starting date is any year, March, any Friday at 7: 30 pm

{M3t6h19m30}

Duration is 2 hours and 30 minutes.

{h2m30}

So that the complete expression becomes:

[(M3t6h19m30){h2m30}]

D.3.7.3 “Last 5 minutes before New Year 1992”

Starting date is the 1st of January 1992 at 0: 00: 00 am

{y1992} implies the 1st of January at 0: 00: 00 am

Duration is minus 5 minutes.

{-m5}

So that the complete expression becomes:

[(y1992){-m5}]

D.3.7.4 “From Sunrise to Sunset”

Starting time is any year, any month, any day, at Sunrise

(z1)

Duration is Sunrise to Sunset.

{z51}

So that the complete expression is:

[(z1){z51}]

D.3.7.5 “From 1 hour before Sunrise to 1 hour after Sunset”

Starting time is any year, any month, any day, an hour before Sunrise

(-h1z1)

Duration is daytime hours plus 2 hour.

{h2z51}

So that the complete expression is:

[(-h1z1){h2z51}]

D.3.7.6 “From 1 hour before Sunset to 1 hour after Sunset”

Starting time is any year, any month, any day, an hour before Sunset (since a

‘-‘ before “point-in-time” fuzzy changes the semantics from “beginning”

of it, to the “end” of it (alternative to using z2)

(-h1-z1)

1 hour after Sunset.

(h1-z1)

So that the complete expression is:

[(-h1-z1)(h1-z1)]

A more succinct expression is the following:

[(-h1z2)(h1z2)]

D.3.7.7 “While school is in session”

Starting time is any year, any school day, at beginning of any school time

(z3)

Duration is school session time.

{z53}

So that the complete expression is:

[(z3){z53}]

Note that “while school is not in session” would be rendered as

[(-z3){-z53}]

D.3.7.8 “In summer and autumn”

Starting time is any year, at onset of summer day, at midnight

(z7)

Duration is summer and autumn.

{z57z58}

So that the complete expression is:

[(z7){z57z58}]

Note that use of a start offset does not change the effective time domain end:

[(d1z7){z57z58}] means from one day after beginning of summer till the end of autumn

Furthermore, discontinues fuzzy time domains can be expressed:

[(z6){z56z58}] means all of spring and all of autumn

D.3.7.9 “During Peak Hours in Winter”

Starting time is any year, in Winter, at the start of any of the Peak Hour periods

(z55z15)

Duration is Peak Hour period.

{z65}

So that the complete expression is:

[(z55z15){z65}]

D.3.7.10 “A specific time in November”

Starting time is the year of 1991, November the 14th, 5 : 30 :19 pm

(y1991M11d14h5m30s19)

Duration is 3 months and 3 days.

{M3d3}

So that the complete expression is:

[(y1991M11d14h5m30s19) {M3d3}]

D.3.7.11 "Another specific time in November"

Starting time is the year of 1991, November the 14th, 5 : 30:19 pm

(y1991M11d14h5m30s19)

Duration is 3 days less then 3 months.

{M3-d3}

So that the complete expression is:

[(y1991M11d14h5m30s19) {M3-d3}]

D.4 Time Domain combinations and shorthand notations

D.4.1 General aspects

Basic Time Domains may also be combined with set operations, such as:

Union of sets notation: +

Intersection of sets notation: *

Subtraction of sets notation: -

Each set operation(s) of basic Time Domains A, B, C, etc. shall be encased by mandatory brackets ('[' and ']', respectively), leading to allowable cases of composite Time Domains as follows:

[A + B], as well as [A + B + C + ...]

[A * B], as well as [A * B * C * ...]

[A - B]

In hierarchically structured expressions, any composite Time Domain may be subject to further set operations, in turn playing the roles of A, B, C, etc and following the same bracketing rule.

A time domain expression may contain any number of space and line break characters either side of its syntax elements '[', '(', ')', '{', '}', ']', '-', '+', '*' , as well as the various time terms. Time terms themselves, as the inner elements, shall not be broken-up.

D.4.2 Example

A shop is assumed to be "Open to all users": From 9: 00am to 12: 00am plus from 13: 30 to 19: 00 each day from Monday to Saturday, except each 1st of May, last Tuesday of January for inventory reasons, and during August (holidays).

The way to code this is to attach the Attribute "Opening Period" to the Feature "Shopping Center". The Opening Period refers by means of a Time Domain ID to a corresponding Time Domain Record that contains all opening information.

Because of De Morgan's theorem, $A * (B + C) = (A * B) + (A * C)$, there are many different symbol combinations to represent the same complex Time Domain.

The example described above can be solved by the following combination of basic Time Domains:

"From 9: 00am to 12: 00am" is $[(h9)\{h3\}]$

"From 13: 30 to 19: 00" is $[(h13m30)\{h5m30\}]$

"From 9: 00am to 12: 00am and from 13: 30 to 19: 00" becomes:

$[(h9)\{h3\}] + [(h13m30)\{h5m30\}]$

Since this is valid only from Monday to Saturday, an intersection operation is required with the Time Domain "Any week from Monday to Saturday", represented by $[(t2)\{d6\}]$

The expression now becomes: $[[[(h9)\{h3\}] + [(h13m30)\{h5m30\}]] * [(t2)\{d6\}]]$

We will now deal with the restrictions:

"1st of May every year", which is represented as $[(M5d1)\{d1\}]$

"last Tuesday of January" which is represented as $[(M1113)\{d1\}]$

"All days during August" which is represented as $[(M8)\{M1\}]$

The final expression becomes then:

$[[[[[(h9)\{h3\}] + [(h13m30)\{h5m30\}]] * [(t2)\{d6\}]] - [(M5d1)\{d1\}]] - [(M1113)\{d1\}]] - [(M8)\{M1\}]]$.

D.4.3 Shorthand expressions for fuzzy symbols

D.4.3.1 Introduction

Following the regular structure of start-duration expressions, use of fuzzy symbols may necessitate the use of 'intersect' set operations in a frequent number of cases.

EXAMPLE 1 $[(d1)\{d2\}] * [(z7)\{z57\}]$ means overall the first two days of every month during summer of any year

However, while 'Point-in-time' semantics of fuzzy terms are (strictly speaking) in the range of 0 the 49, the entire set of fuzzy terms are allowed in an "start" time expression. The same holds true in a "duration" time expression, where the entire domain of the fuzzy terms are allowed in. Together The following example uses z57 ("during summer") as part of the Starting Time Syntax, as well as in the alternate form using an Ending Date.

EXAMPLE 2 $[(d1z57)\{d2\}]$ is equivalent to the previous example.

EXAMPLE 3 $[(d1z57)(d3z57)]$ is also equivalent to the previous example.

D.4.3.2 Multiple fuzzy terms as part of starting date

Starting time is any year, during Winter, at the start of any Peak Hour period(s)

{z15z55}

Duration is Peak Hour period.

{z65}

So that the complete expression is:

[(z15z55){z65}]

Note that even if Peak Hour has more than one time components, this expression would apply to both times, for the duration of both parts, as appropriate. Suppose rush hour was from 7am to 10am and then again from 4pm to 8pm, then the expression allows the “dual” (or periodic or cyclical) times of 7am for 3 hours, and then 4pm for 4 hours.

D.4.3.3 Fuzzy start/end symbol vs fuzzy duration symbol in starting date

There is a semantic difference between starting date usage of fuzzy start/end symbols (znn with value range 0..49) and starting date usage of fuzzy duration symbols (znn with value range 50..99 corresponding to fuzzy start/end symbols).

EXAMPLE 1 [(y1991h12z57){h2}] means two hour period from noon till 2pm any day during summer 1991

EXAMPLE 2 [(y1991h12z7){h2}] means two hour period starting at noon till 2pm after the beginning of summer 1991 (ie. on the first day of summer only)

D.4.3.4 Sharp time term serving as durative context in starting date/ending date

What is true for fuzzy duration time units actually also is the case for sharp time units. Due to the fact that many sharp time symbols use identical start and duration expressions, the duration context (when combined with fuzzy symbols) is less obvious than for any fuzzy time context.

EXAMPLE (M12z15) means the beginning of peak hours during December in any year

D.5 Resolution of a time equation

D.5.1 Introduction

The problem is to know whether a particular moment (second) belongs to a given Time Domain or not. When the moment in question is within that Time Domain, the boolean value True is attached to the Time Domain.

If not, the boolean value evaluates to False.

D.5.2 Boolean tables

“*” is the boolean AND operator, “+” is the OR operator, and “-” is the “A AND NOT B” operator.

The boolean tables for Time Domain combinations are:

A + B	B	True	False
A			
True		T	T
False		T	F

A * B	B	True	False
A			
True		T	F
False		F	F

A - B	B	True	False
A			
True		F	T
False		F	F

D.5.3 Example of a resolution

Assume we want to know if the previous shop is open on 14 November 1991 at 10: 20 am. We have to check if this particular moment fits with the Time Domain where the Attribute Opening Period refers to.

14 November 1991, 10: 20 am matches the following basic domains:

y1991 / M11 / w46 / d14 / t5 / f25 / l25 / h10 / m20 / s0

A check of the defined Time Domain results in:

“From 9: 00 am to 12: 00am”: [(h9){h3}] is True

“From 13: 30 to 19: 00”: [(h13m30){h5m30}] is False; “From Monday to Saturday”: [(t2){d6}] is True

Therefore the expression [[[(h9){h3}] + [(h13m30){h5m30}]] * [(t2){d6}]] is True

“1st of May every year”: [(M5d1){d1}] is False

“Last Tuesday of January”: [(M1113){d1}] is False;

“All days during August”: [(M8){M1}] is False

Thus the complete expression

```
[ [ [
[ [ [(h9){h3}] + [(h13m30){h5m30}] ] * [(t2){d6}] ]
-[(M5d1){d1}] ]
-[(M1113){d1}] ]
-[(M8){M1}]
]
```

Evaluates to True: The shop is open.

Annex E (normative)

Sectioning GDF Datasets

E.1 Goal of sectioning

Sectioning is the process of organizing data records in a GDF to ease the processing of large amounts of data. The goal of sectioning is only to organize data for better handling. Sectioning does not define the area of coverage of a database. The area covered by a particular GDF is defined independently of its logical subdivision units Dataset, Layer, and Section.

Sections are the smallest unit of sectioning. Layer boundaries, as well as Dataset boundaries, always coincide with Section boundaries. There are no special cases or conditions to be handled at Layer or Dataset boundaries other than those applying to Section boundaries. Therefore, specifications in the following address Section boundaries only.

E.2 Definitions

Element: Any GDF level-0, level-1, or level-2 object. The following are elements: Node, Edge, Face, point, line, area and Complex Feature.

Local: Defined in the same Section. If two elements are defined in the same Section, they are said to be local to each other. An element is considered local in a Section where it is defined by a level-0, level-1, or level-2 record.

Foreign: Defined in different Sections. Two elements are considered foreign if they are defined in different Sections. An element is considered foreign in a Section where it is referenced by a conversion record.

Split Feature: Any Feature which crosses Section boundaries, and contains geometry which was introduced to avoid Features crossing Section boundaries.

Foreign and local are relative terms. An element can be local in one Section and foreign in another.

E.3 Rules of sectioning

E.3.1 General

The rules for sectioning describe how elements are allowed to be defined with respect to Sections. That is, which elements can be defined foreignly, and how to define them foreignly. The rules also describe how to code elements which cross Section boundaries, so the Features can be reconstructed.

E.3.2 Determination of Sections

Because Sections are used to ease the processing of data, elements in a Section should be geometrically related. However, there are no strict rules for this relation. Sections may geographically overlap or cover the same area as other Sections.

There are no standard requirements for Section boundaries. Section boundaries are defined by the level-0 geometric representation which coincides with more than 1 Section.

E.3.3 Level-0 elements

Since Level-0 includes only the geometric description of real-world Features, it would be expected and preferred to include this geometrical description in the same Section as the Feature definition. For this reason, all level-0 elements which are referenced by a level-1 or indirectly by a level-2 Feature must be defined locally to the Section in which the Feature is defined.

Any portion of a level-1 or level-2 Feature which is defined in a Section must have that portion of its geometry defined local to that Section.

It is not a requirement that Features which share geometry be defined in the same Section. As a result, level-0 elements may be duplicated in as many Sections as necessary.

E.3.4 Level-1 and 2 Features

Level-1 and level-2 Features define real world objects. Many real world objects can not be completely defined in one Section because either they are too big or they cross Section boundaries. If this is the case, a single level-1 or level-2 Feature can be split into separate parts which can be defined in different Sections. These elements shall be marked to indicate how to rebuild them into a single object when the data is processed.

In order to split the level-1 Features, it may be required to add additional level-0 elements at Section boundaries. These elements should be defined as follows:

- A level-1 Point Feature can never cross a Section boundary. Therefore, a level-1 Point Feature should always point to a single, locally defined Node.
- If a level-1 Line Feature crosses a Section boundary, a Node can be added to each Section to terminate the Edge in that Section. This can occur as many times as a Line Feature crosses a Section boundary. A Line Feature should be defined in each Section for each time the Line Feature crosses into that Section. These Features should point only to local level-0 elements. The Line Feature should be marked as "split Feature". The set of Edges which define a particular split Feature should not overlap.
- If a level-1 Area Feature crosses a Section boundary, an additional Edge, and any necessary additional Nodes, can be added to both Sections in order to complete a Face in the Area Feature. This can occur for each Face in the Area Feature which intersects a Section border. An Area Feature should be defined in every Section for each occurrence of the Area Feature crossing into that Section. These Features should point to local level-0 geometry. The Area Features should be marked as "split Feature". The set of Faces which define a particular split Feature should not overlap.

Since level-2 Complex Features are made up of level-1 Features, it is not necessary to introduce new geometry for the level-2 Feature. If a level-2 Area Feature crosses a Section boundary, either because it is made up of Features which cross a Section boundary or because it is made up of Features which are not defined in the same Section, a level-2 Feature should be defined in each Section in which a level-1 Feature which is part of the level-2 Feature exists. These level-2 Features should be marked as "split Feature".

The set of level-1 or level-2 Features which make up a split Feature should not overlap. The exception is Administrative Area Features. Due to the hierarchical nature of the Features, it is allowed that the set of Administrative Area Features which define a higher level Administrative Area Feature have a definition which is local to the higher level Administrative Area Feature. These Features can be identified as being the same Feature as a Feature defined in a different Section by their name, and higher order administrative levels. These Features can be marked as "duplicate definition in another Section". This condition is for Administrative Area Features only.

E.3.5 Names

Names can be repeated in any Section where an element is defined which carries that name. Name records can not be referenced foreignly. As a result, all elements must carry their name definitions locally to the Section in which they are defined.

E.3.6 Relationships

To ease the ability to process data, all Relationships must have at least one locally defined Feature. There is no requirement for which Feature must be defined locally. If a Feature is defined both locally and foreignly, the Relationship record must point to the local definition. For instance, if an Administrative Area is split, and defined both in a local Section and a foreign Section, the Road Element in Administrative Area Relationship must point to the locally defined Administrative Area Feature. All pointers to other elements in a Relationship records, including names and Attributes, must point to local elements.

E.3.7 Attributes

Attributes can be repeated in any Section where any element is defined which has that Attribute. Attribute records can not be referenced foreignly. As a result, all elements must carry their Attribute definitions locally to the Section in which they are defined. Attribute records which point to other elements, including subAttributes and time domain records, can not point to any foreignly defined elements. Segmentation of Attribute records is based on the local definition of the Feature.

E.4 Relationship between Sections, Layers and Datasets

There are no standard requirements for the Relationship between Sections, Layers and Datasets, except that a Dataset must contain 1 or more Layers which in turn must contain one or more Sections. This can be defined between the data supplier and the data consumer.

Annex F (informative)

Rules for the formation of Level 2 Features from Roads and Ferries

F.1 Basic guidelines

F.1.1 Introduction

The Level 2 Features Roads, Intersections and Interchanges are Complex Features which are constructed from various combinations of Road Elements, Junctions. In the construction of Roads and Intersections, the basic guideline is functionality in terms of car driving. A crossing which is experienced as one functional unity can be represented as one Intersection. The connection between two neighbouring Intersections can also be viewed as one functional unity and thus defined as one Road. In the construction of Interchanges, the basic guideline has a more conceptual character. Interchanges are to be considered as crossings between roadways on a higher level of generalisation. It should be noted that the functional considerations used for the definition of Roads and Intersections and the conceptual considerations used for the definition of Interchanges are not completely distinct. The functional considerations also lead to a certain amount of generalisation. On the other hand, the conceptual considerations may also lead to objects which might have a functional character. This functional character however will generally have a higher abstraction level than the functional character of Roads and Intersections. Where the functional character of an Intersection is associated with a driving decision (e.g. "turn left"), the functional character of an Interchange will generally be associated with a set of driving decisions (e.g. at the Frankfurter Kreuz, take direction Würzburg). Especially in the less complex cases (e.g. a crossing between two single carriageways without any slip roads), Intersections and Interchanges might coincide completely.

The formation rules for Intersections and Roads are highly interdependent. A definition of an Intersection has direct consequences for the definition of the Roads which connect to that Intersection. Vice versa, because a Road starts or ends at an Intersection, the definition of Roads also influences the definition of Intersections.

The basic formation rule for an Intersection is that at a normal crossing at grade, in which three or more single or multi carriageways come together, the set of Junctions and Road Elements which together make up the connection form one Intersection.

The formation rules for Intersections and Roads stated in this way have a consequence for the level 1 representation of the road network. If at a certain location along a multi carriageway, only one of the carriageways gives access to a side street, a two-valent Junction should be introduced on the not intersected carriageway opposite to the Junction(s) representing the connection(s) at the other carriageway. The introduction of these Junctions is necessary to maintain the integrity of the Level 2 graph. These Junctions will be referred to as "two-valent opposing Junctions" (See Figure F.2).

Interchanges are the representation of locations in the road network which have a clear real world connotation. The concept of Interchanges is related to generalisation. On a sufficient high generalisation level, the connection between two motorways will be considered as one object. Such an object can be represented as an Interchange (See Figure F.16 for an example). In areas where connections are of smaller scale than motorways (e.g. inner-city areas), Interchanges can coincide with the simple crossing of two single carriageways.

F.1.2 The difference between Intersections and Interchanges: Roundabouts

A roundabout may be represented in two distinct ways at Level 2 which makes the distinction between Interchanges and Intersections somewhat clearer. One choice is where the entire roundabout is viewed as one unit so that all the Junctions and Road Elements constituting the roundabout form an Interchange.

Another choice is to view the roundabout in a more functional way by forming one Intersection at each connection with a road connected to it. (See Figure F.15).

F.2 More guidelines for the formation of Intersections

F.2.1 Crossings

F.2.1.1 General

Intersections cover a wide variety of situations which all need their specific formation rules.

One generic rule however has been formulated to use as a guideline to judge whether a crossing between roads which do not come together in one point should be viewed as a functional unity. This rule is visualised in Figure F.1 and can be stated as follows: If the Junctions of a connection between several carriageways all are located within the area which is common to the areas formed by the extension of the curb sides of the different carriageways, these Junctions together with their intermediate Road Elements together form one Intersection.

F.2.1.2 Crossings involving only single carriageways

These crossings can be categorised according to their valency:

1. Two-valent Crossings.

A two-valent Junction (except a two-valent opposing Junction) should not be considered part of an Intersection but instead such a Junction, together with the Road Elements it connects, should be considered part of a Road.

2. Three-valent Crossings.

A typical example of a three-valent crossing is a "T-Junction". At Level 1, such a crossing can be represented as one Junction and at Level 2 as one Intersection. The same is true for a "Y-Junction" or "Fork". When the centerlines of the Road Elements converging on a crossing do not intersect each other at one single point, the connection can be defined as one single Intersection if it forms a functional unity. This can be judged by applying the general rule stated at the beginning of this paragraph.

3. Four or more-valent Crossings.

Figure F.3 and Figure F.4 give examples of some normal cases. Figure F.5 and Figure F.6 give examples of more special cases. As can be seen from these examples, the general rule should be used as a guideline only and not be applied too strictly. There are situations for which the general rule does not hold but which still can be considered as functional unities.

F.2.1.3 Crossings involving dual carriageways

The normal situations in which dual carriageways form a crossing are visualised in Figure F.2, Figure F.7, Figure F.8 and Figure F.9.

1. At crossings in which two multi carriageways are involved, the Junctions and the "intermediate" Road Elements together form the Intersection (See Figure F.9).
2. At crossings in which a single carriageway connects to a multi carriageway, Junctions which define the points of intersection together with a possible Road Element, which connects these Junctions together, may form an Intersection. Three different situations can be identified in this case:
 - The single carriageway connects to only one side of the multi carriageway, and thus gives access to one carriageway only (See Figure F.2). In this case, the Junction at the connection of the single

and the multi carriageway, together with the two-valent opposing Junction on the other carriageway, form one Intersection.

- Two single carriageways connect to the multi carriageway opposite each other but are not connected across the multi carriageway (See Figure F.8). In this case, the two Junctions at the connections of the single carriageways and the multi carriageway form one Intersection.
- Two single carriageways connect to the multi carriageway opposite each other and are connected across the multi carriageway via a small Road Element (See Figure F.7). In this case, the two Junctions at the connection of the single carriageways and the multi carriageway, together with the Road Element which connects these Junctions, form one Intersection.

When two opposite dual carriageways are not exactly in line, rules similar to those for single carriageway crossings must be applied. The crossing can be viewed as one functional unity when the median of each dual carriageway lies inside the outline of its opposite dual carriageway. In such a case the crossing may be represented by a single Intersection.

A special situation is shown in Figure F.10. A dual carriageway has a gap in the median to allow vehicles to make a U-turn. The Level 1 representation, therefore, contains two Junctions joined by a small Road Element. Because both carriageways are viewed as forming one Road, the two Junctions and the small Road Element joining them form one Intersection at Level 2.

The general rule of formation based on functionality also has consequences for Level 2 formation in relation to the Attributes of a Road Element. In Figure F.11, a lower class road runs parallel to a main road. The Road Elements have different functionality so that they may not be considered one Road. Consequently two Level 2 Intersections are defined where a side road crosses the roads.

F.2.1.4 The impact of the presence of traffic Islands and similar constructions on the formation of Intersections

Generally traffic islands are constructed as an integral part of a crossing between two roads. The Road Elements, which have been defined to indicate the presence of these constructions, therefore should be included in the definition of the Intersection. Figure F.12 to Figure F.14 illustrate such situations.

F.2.2 The practical case

The reality, which should be represented in a GDF, often cannot be fully divided into a set of situations which fit exactly in the above described categories. Therefore formation of Level 2 in practice will often come down to making subjective interpretations and trying to apply guidelines that for certain cases appear to be contradictory. To give some indication for this, Figure F.21 to Figure F.23 show a situation containing several functional unities and one Level 2 representation that may be derived from it.

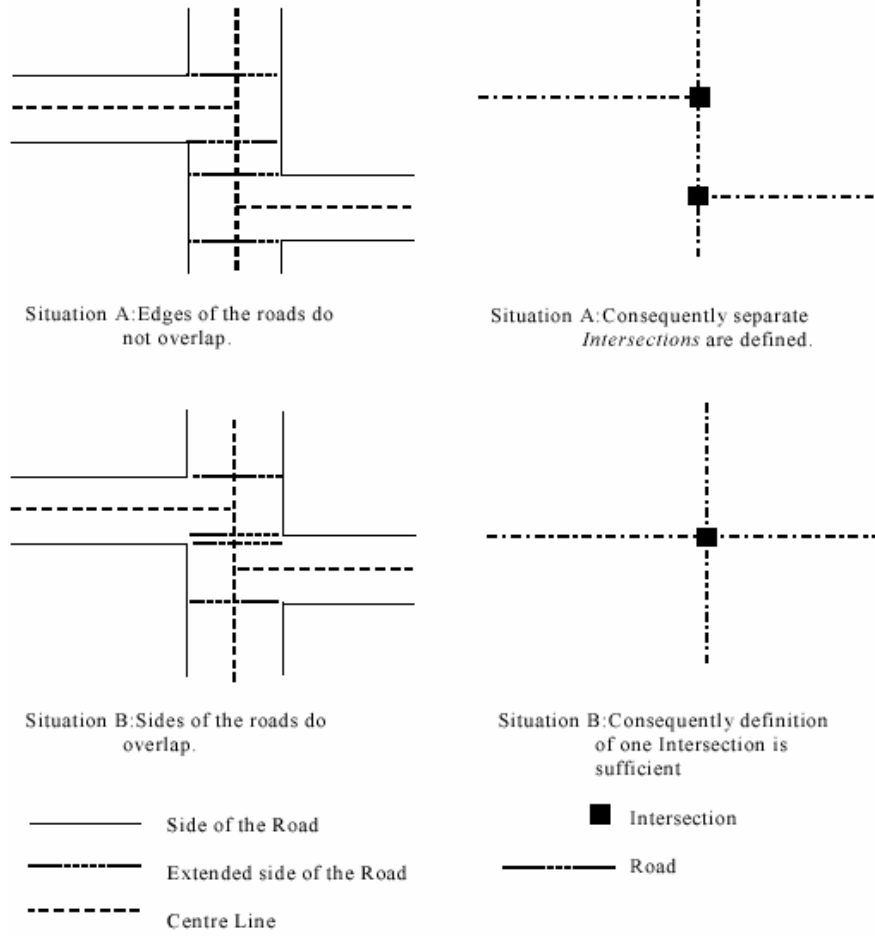
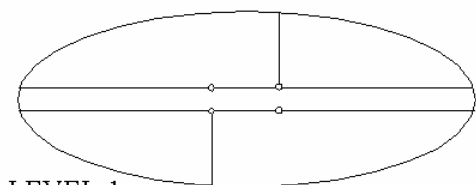
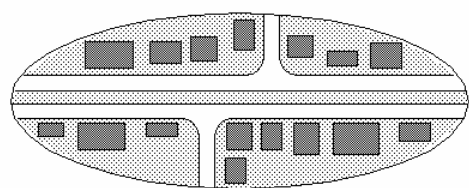
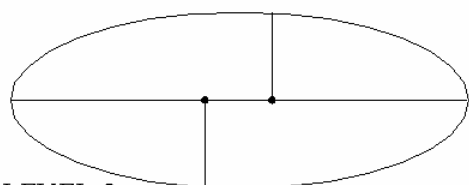

Figure F.1 — Rules for the formation of Intersections at crossings



LEVEL-1



LEVEL-2

Figure F.2 — Representation of Multi Carriageways at Level-2

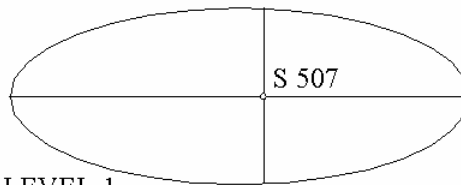
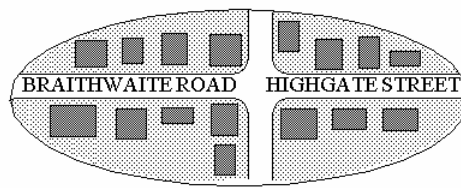

LEVEL-1

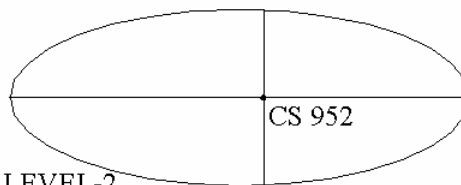

LEVEL-2

Figure F.3 — An Intersection containing one Junction

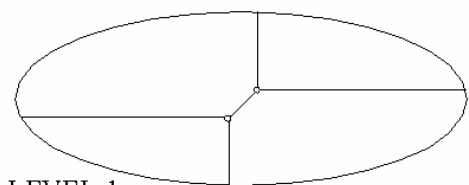
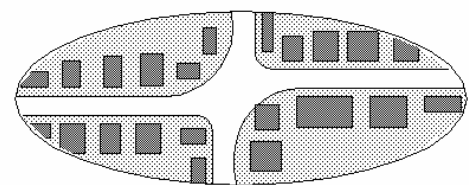

LEVEL-1

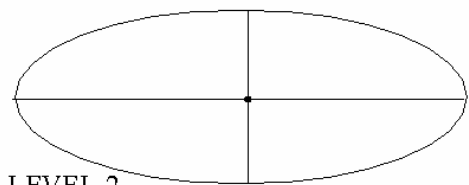

LEVEL-2

Figure F.4 — An Intersection containing two Junctions

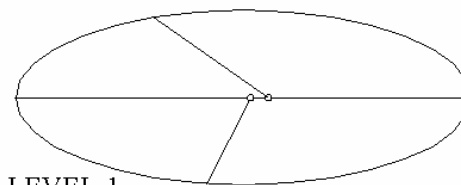
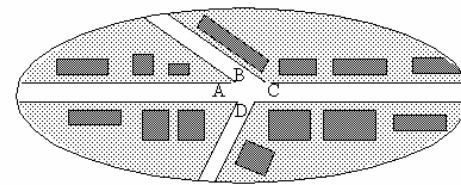

LEVEL-1

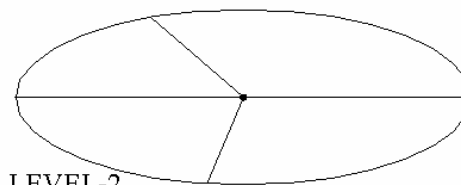

LEVEL-2

Figure F.5 — A four-valent crossing with two Junctions and one Intersection

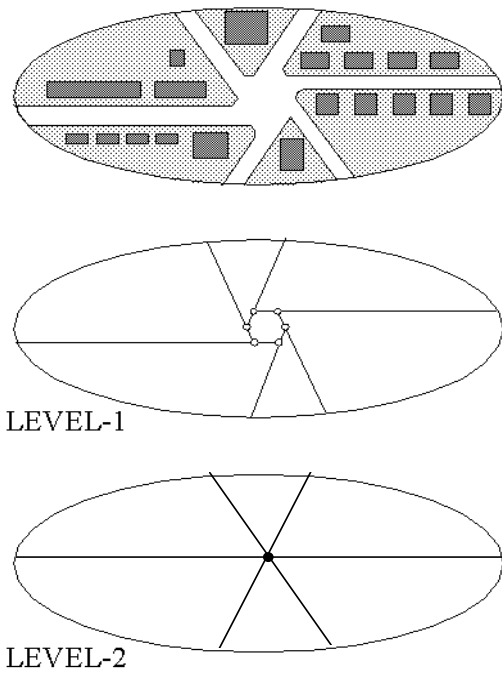

Figure F.6 — A six-valent crossing with six Junctions and one Intersection

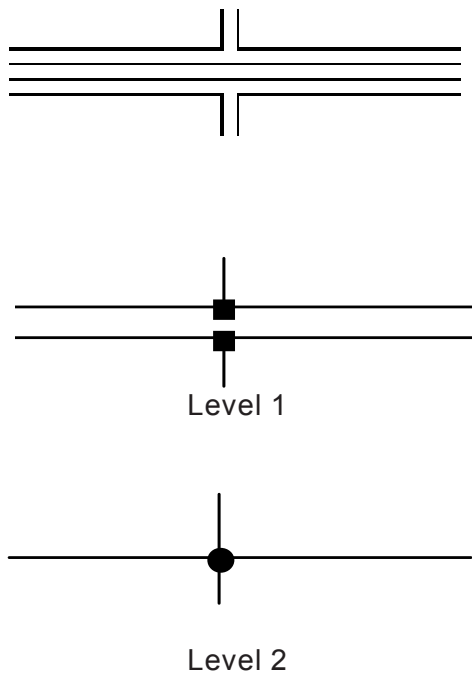

Figure F.8 — A crossing between two non-connected single carriageways and a multi carriageway

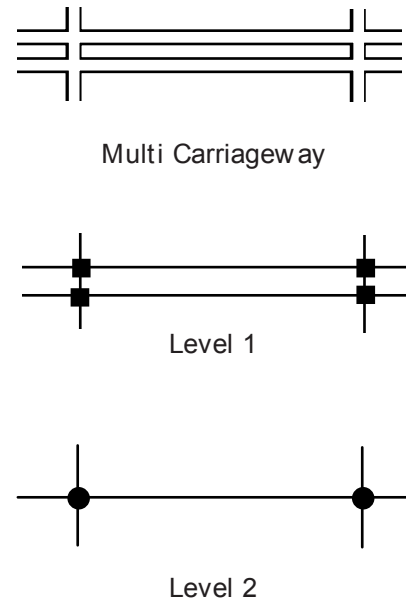

Figure F.7 — Crossings between two connected single carriageways and a multi carriageway represented by Intersections

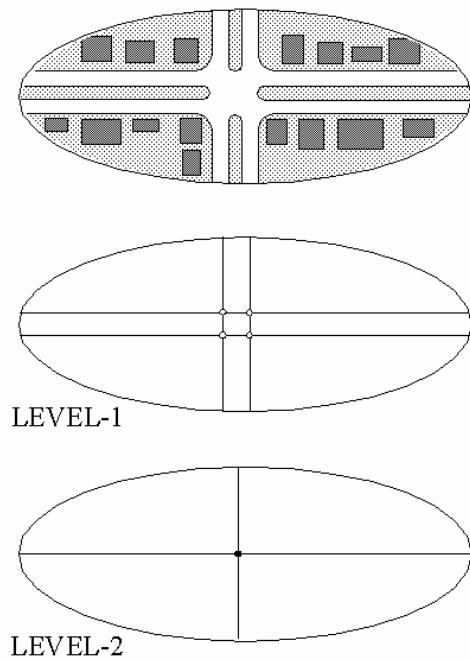

Figure F.9 — A crossing between two multi carriageways

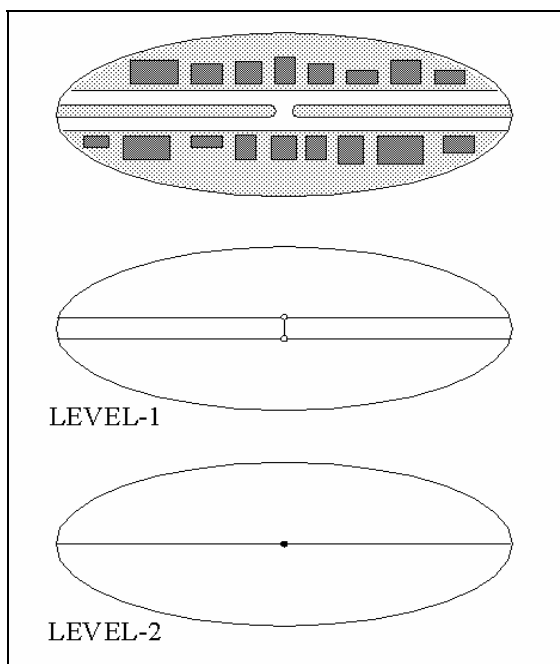

Figure F.10 — Representation of a U-turn on Level-2

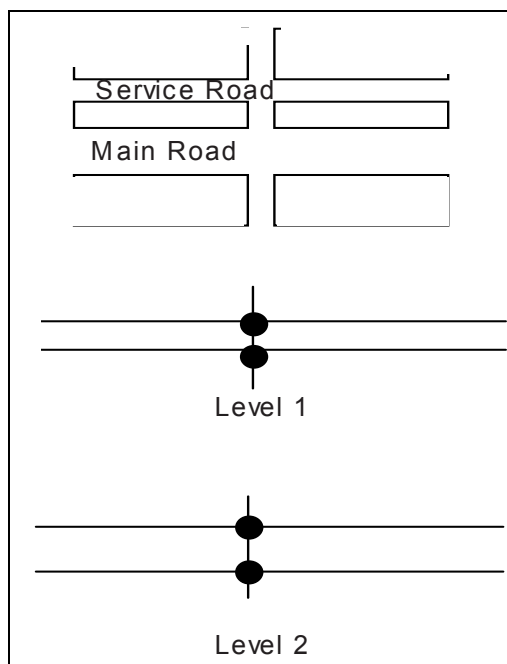

Figure F.11 — The effect of Functional Road Class on Level-2 formation

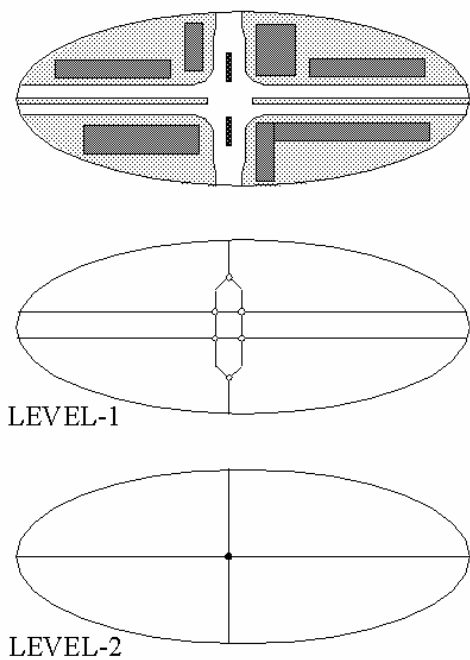

Figure F.12 — An example of Level-2 formation of Intersections at crossings with traffic islands

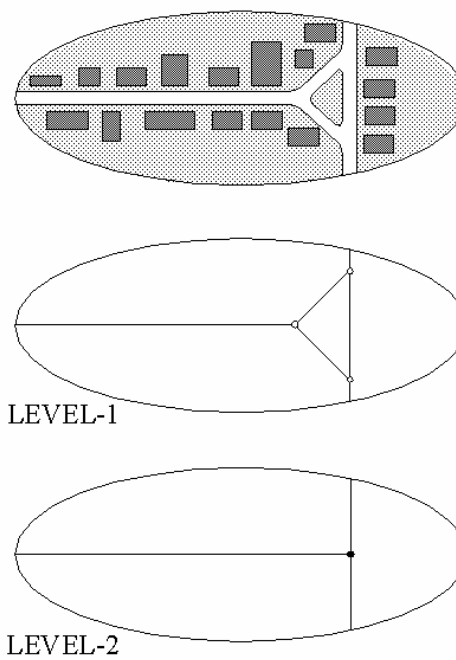

Figure F.13 — Another example of Level-2 formation of Intersections at crossings with traffic islands

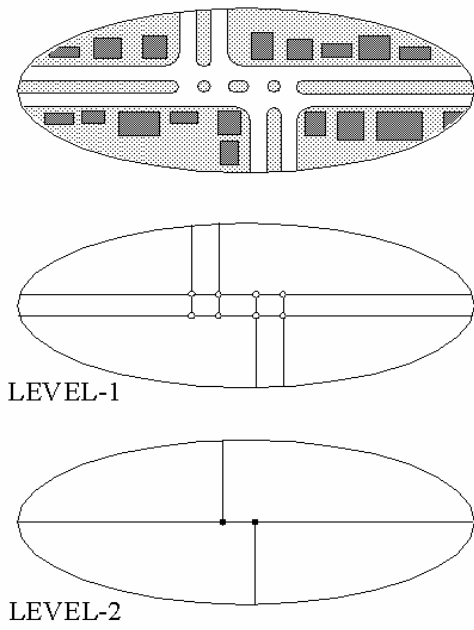

Figure F.14 — Further example of Level-2 formation of Intersections at crossings with traffic islands

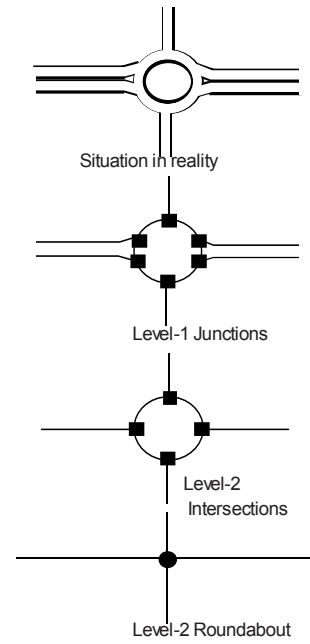

Figure F.15 — An example of Level-2 formation of roundabouts

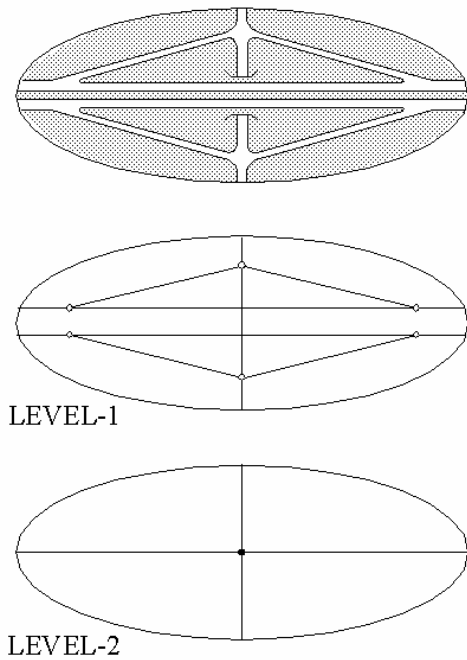

Figure F.16 — An example of a level-2 representation of an Interchange

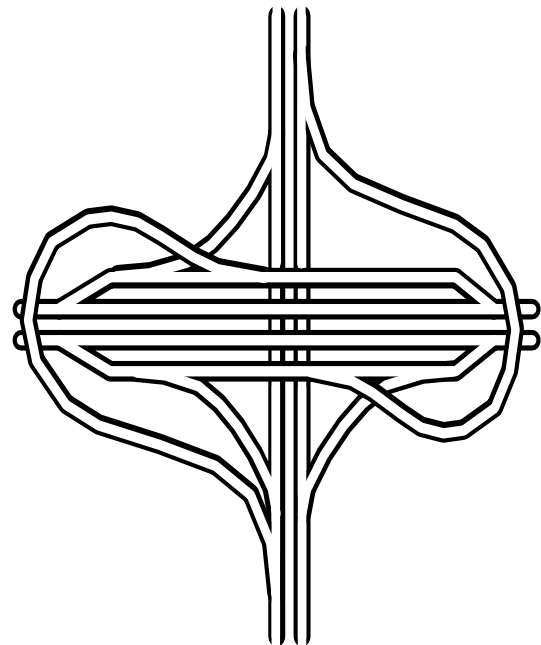

Figure F.17 — Representation of a Motorway Interchange

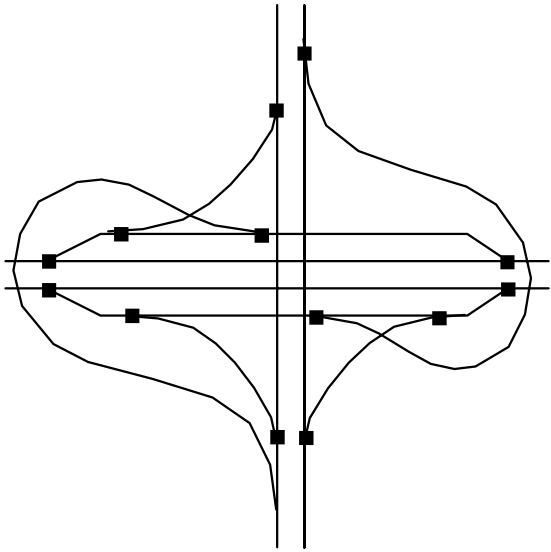

Figure F.18 — Level 1 representation of Figure F.19

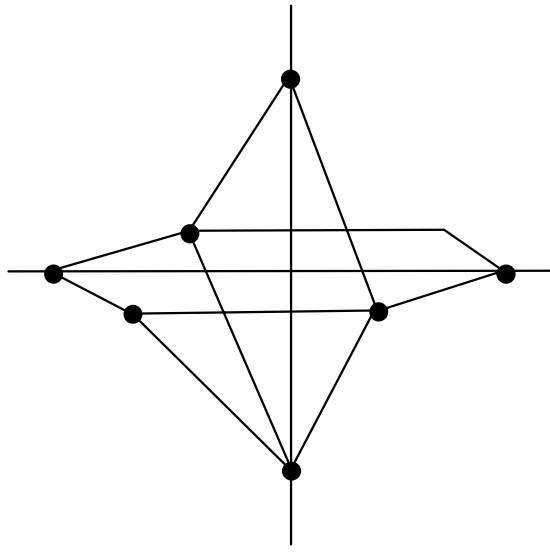

Figure F.19 — An example of the level-2 representation of Figure F.20

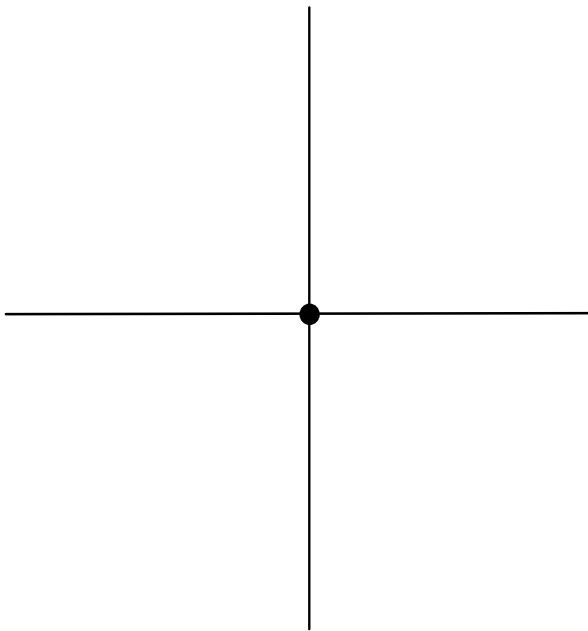

Figure F.20 — Another example of a level-2 representation of Figure F.19

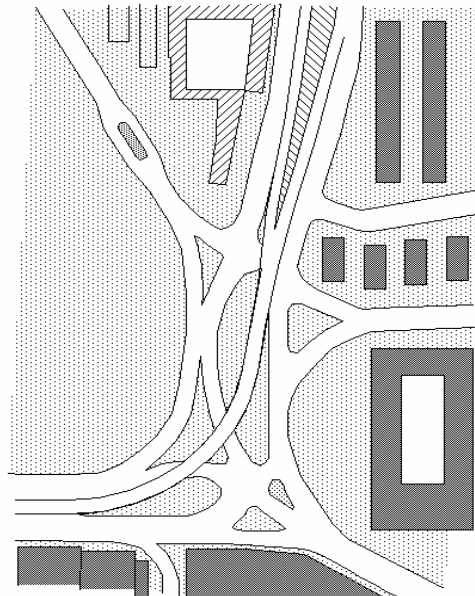

Figure F.21 — A complex case

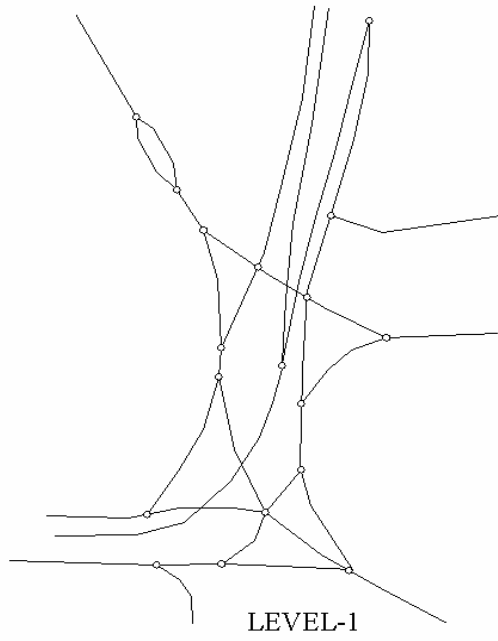

Figure F.22 — The level-1 representation of Figure F.21

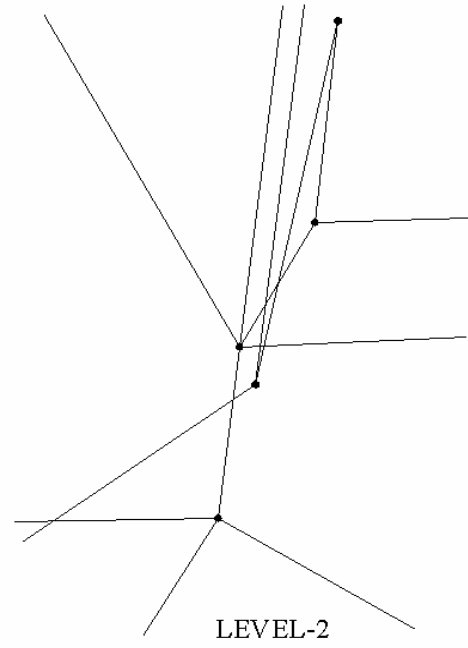

Figure F.23 — A level-2 representation of Figure F.21

Annex G (informative)

Geopolitical Structure examples

G.1 Correspondence of Order Areas to Administrative Area types for a number of countries

	Order-1	Order-l	Order-m	Order-8	Order-9
Belgium	Gewest/ Région	Provincie/ Provence	Arrondissement/ Arrondissement	Gemeente/ Commune	
England	County			District/ Borough/ Civil Parish/ City	
France	Région	Département	Arrondissement	Commune	
Germany	Bundesland	Regierungsbezirk	Kreis	Gemeinde	Gemarkung
Italy	Regione		Provincia	Comune	
Japan	Prefecture (to do fu ken)			Special Ward (Tokyo-ku) City/Town/Village	Area Name (ku)
Luxembourg	District			Commune	
Netherlands	Provincie			Gemeente	
Scotland	Region			District	
South Korea	Metropolitan city / Do	Gu / Gun / City		Eub / Myun / Dong	
USA	State			County	
Wales	County	District		Community	

NOTE This list is not exhaustive and is only meant as an example.

G.2 Geopolitical Structure Definition examples for a number of countries

GDF provides for a means to define geopolitical structures in terms of a generic description of the hierarchical and non-hierarchical relations between Administrative Area Features and Named Area Features, constituting a Directed Acyclic Graph (DAG), in a given (part of a) country.

Four international examples are provided, both in terms of a graphical representation and a corresponding representation of records and fields (using record type 10 and 11; see 10.4.6, 12.6.10 and 12.6.11).

NOTE The examples render the diagrams provided with them, not necessarily the actual (more complex all exception treating) reality on the ground. The main objective is to illustrate the principle of translating a graphical structure into a record encoding structure.

G.2.1 Korean example

REC 10	Geopolitical Structure Definition Record	Populated fields	Populated fields
GPL_STR_ID	Geopolitical Structure ID	301	302
GPL_STR_NM	A name for the Geopolitical Structure	Korean admin area hierarchy	Korean new address hierarchy
NUM_COMP	counter	13	8
GPL_S_C_ID	Geopolitical Structure Component ID	30001, 30102, 30103, 30104, 30205, 30206, 30207, 30308, 30409, 30410, 30411, 30512, 30513	30001, 30102, 30103, 30104, 30205, 30206, 30207, 30308

REC 11	Geopolitical Structure Component Def. Rec.	Populated fields	Populated fields	Populated fields	Populated fields	Populated fields
GPL_S_C_ID	Geopolitical Structure Component ID	30001	30102	30103	30104	30205
FEAT_CODE	Feature Class Code of the Admin./Named Area	1111	1112	1112	1112	1113
NUM_NAME	counter	1	1	1	1	1
LAN_CODE	MARC language code of the language used to name the Administrative Area or Named Area	ENG	KOR	KOR	KOR	KOR
LOCAL_NM	The local name of the Administrative Area or Named Area in the specified language	Country	Do	Si	Si	Si
NUM_IMM	counter	0	1	1	1	1
PAR_IMM_ID	Immediate parent Geopol. Structure Comp		30001	30001	30001	30102
NUM_FUL	counter	0	0	0	0	0
PRE_FUL_ID	Lowest full predecessor Geopol. Structure Comp					
GPL_S_C_DC	Informative description of the characteristics of this component	Root of Korea graph	1 st level subdivision (hierarchical) - Province	1 st level subdivision (hierarchical) - Metro City	1 st level subdivision (hierarchical) - Special City	2 nd level subdivision (hierarchical) - (regular) City

REC 11	Populated fields	Populated fields	Populated fields	Populated fields	Populated fields
GPL_S_C_ID	30206	30207	30308	30409	30410
FEAT_CODE	1113	1113	1114	1119	1119
NUM_NAME	1	1	1	1	1
LAN_CODE	KOR	KOR	KOR	KOR	KOR
LOCAL_NM	Gun	Gu	Gu	Eup	Myeon
NUM_IMM	2	2	1	3	3
PAR_IMM_ID	30102, 30103	30103, 30104	30205	30308, 30205, 30206	30308, 30205, 30206
NUM_FUL	0	0	0	0	0
PRE_FUL_ID					
GPL_S_C_DC	2 nd level subdivision (hierarchical) – County	2 nd level subdivision (hierarchical) – Autonomous District	3 rd level subdivision (hierarchical) – Non-Autonomous District	4 th level subdivision (hierarchical) – Eup	4 th level subdivision (hierarchical) – Myeon

REC 11	Populated fields	Populated fields	Populated fields
GPL_S_C_ID	30411	30512	30513
FEAT_CODE	1119	1120	1120
NUM_NAME	1	1	1
LAN_CODE	KOR	KOR	KOR
LOCAL_NM	Dong	Ri	Tong
NUM_IMM	4	2	1
PAR_IMM_ID	30308, 30205, 30206, 30207	30409, 30410	30411
NUM_FUL	0	0	0
PRE_FUL_ID			
GPL_S_C_DC	4 th level subdivision (hierarchical) – Dong	5 th level subdivision (hierarchical) – Ri , pseudo administrative	5 th level subdivision (hierarchical) – Tong , pseudo administrative

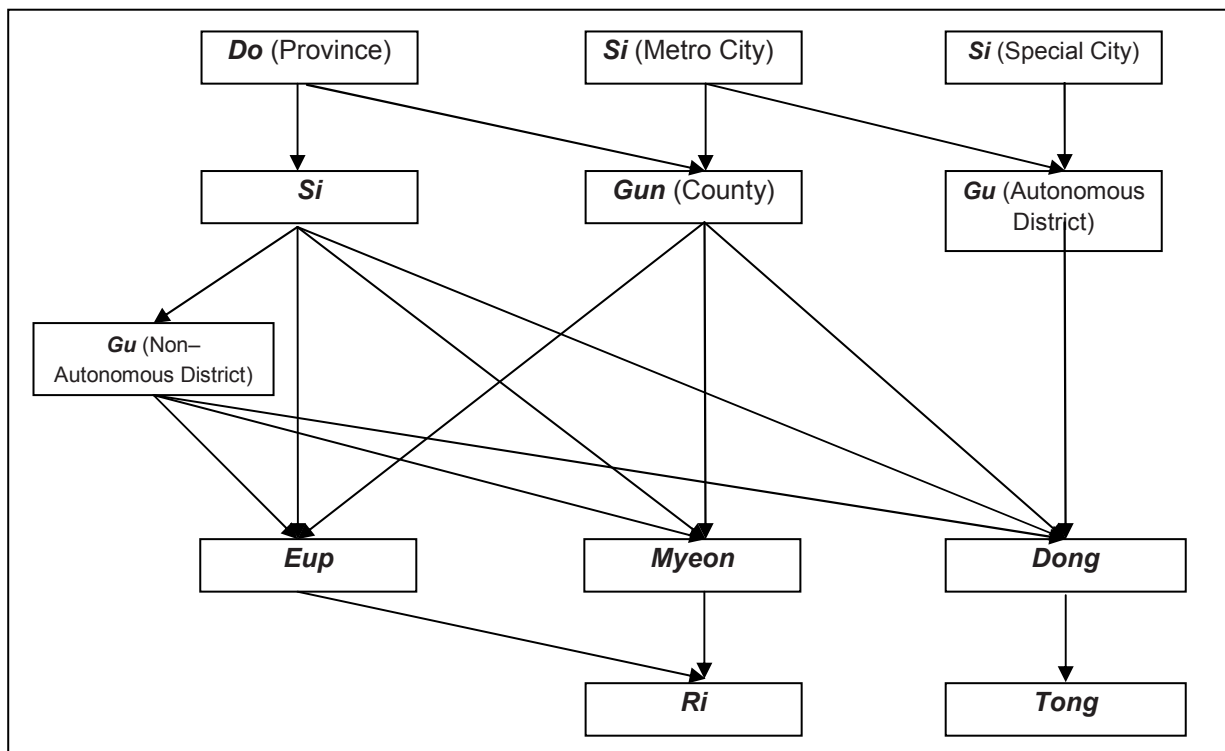

Figure G.1 — Hierarchy of current administrative areas

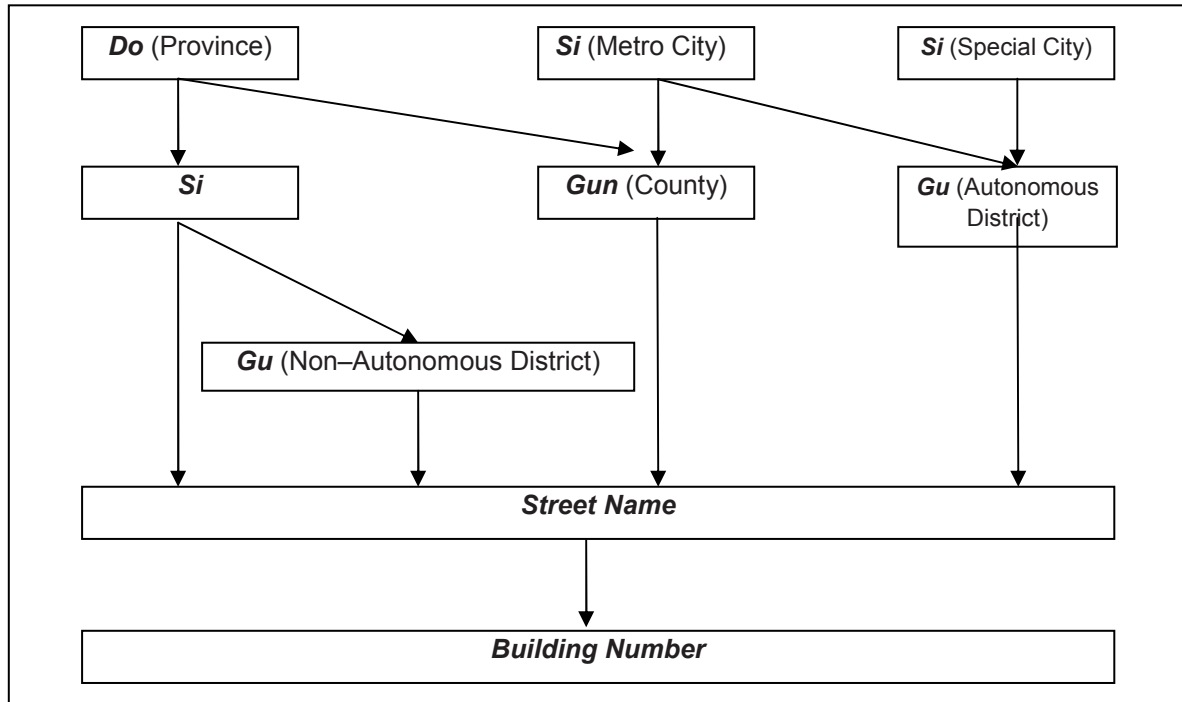

Figure G.2 — New address hierarchy

G.2.2 European example (France)

REC 10	Geopolitical Structure Definition Record	Populated fields
GPL_STR_ID	Geopolitical Structure ID	501
GPL_STR_NM	A name for the Geopolitical Structure	French admin hierarchy
NUM_COMP	counter	11
GPL_S_C_ID	Geopolitical Structure Component ID	50001, 50102, 50103, 50204, 50305, 50406, 50507, 50608, 50509, 50510, 50511

REC 11	Geopolitical Structure Component Def. Rec.	Populated fields	Populated fields	Populated fields	Populated fields	Populated fields
GPL_S_C_ID	Geopolitical Structure Component ID	50001	50102	50103	50204	50305
FEAT_CODE	Feature Class Code of the Admin./Named Area	1111	1112	1112	1113	1117
NUM_NAME	counter	1	1	2	1	1
LAN_CODE	MARC language code of the language used to name the Administrative Area or Named Area	ENG	FRE	FRE	FRE	FRE
LOCAL_NM	The local name of the Administrative Area or Named Area in the specified language	Country	Région	Région d'outre-mer, Département d'outre-mer	Département	Arrondissement
NUM_IMM	counter	0	1	1	1	2
PAR_IMM_ID	Immediate parent Geopol. Structure Comp		50001	50001	501021	50204, 50103
NUM_FUL	counter	0	0	0	0	0
PRE_FUL_ID	Lowest full predecessor Geopol. Structure Comp					
GPL_S_C_DC	Informative description of the characteristics of this component	Root of France graph	1 st level subdivision (hierarchical) - Region	1 st level subdivision (hierarchical) - Overseas Region / Overseas Department	2 nd level subdivision (hierarchical) Department	3 rd level subdivision (hierarchical) - Arrondissement

REC 11	Populated fields	Populated fields	Populated fields	Populated fields	Populated fields	Populated fields
GPL_S_C_ID	50406	50507	50608	50509	50510	50511
FEAT_CODE	1118	1119	1120	1165	1165	1165
NUM_NAME	1	1	1	1	1	1
LAN_CODE	FRE	FRE	FRE	FRE	FRE	FRE
LOCAL_NM	Canton	Commune	Arrondissement municipal	Communauté urbaine	Communauté d'agglomération	Communauté de communes
NUM_IMM	1	4	1	1	1	1
PAR_IMM_ID	50305	50406, 50509, 50510, 50511	50507	50406	50406	50406
NUM_FUL	0	1	0	1	2	2
PRE_FUL_ID		50305		50102	50102, 50103	50102, 50103
GPL_S_C_DC	4 th level subdivision (hierarchical) – Canton	5 th level subdivision (hierarchical, with non-hierarchical exceptions) – Municipality	6 th level subdivision (hierarchical) – Municipal arrondissement	Inter-communal grouping (non-hierarchical) – Urban communities	Inter-communal grouping (non-hierarchical) – Agglomeration communities	Inter-communal grouping (non-hierarchical) – Commune communities

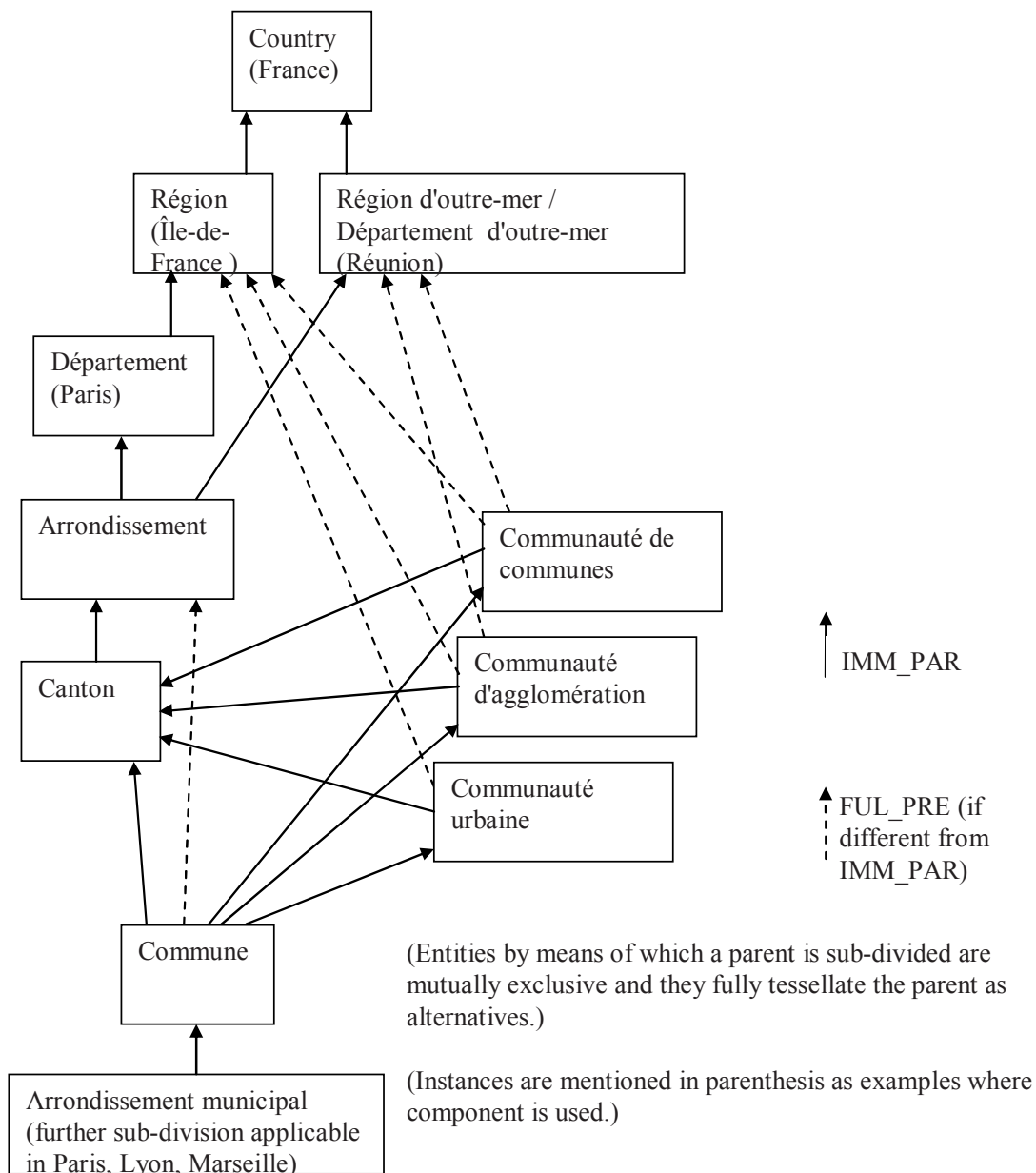

G.2.3 US examples

REC 10	Geopolitical Structure Definition Record	Populated fields
GPL_STR_ID	Geopolitical Structure ID	101
GPL_STR_NM	A name for the Geopolitical Structure	USA admin hierarchy
NUM_COMP	counter	13
GPL_S_C_ID	Geopolitical Structure Component ID	10001, 10102, 10103, 10104, 10105, 10206, 10207, 10208, 10209, 10310, 10311, 10312, 10413

REC 11	Geopolitical Structure Component Def. Rec.	Populated fields	Populated fields	Populated fields	Populated fields	Populated fields	Populated fields
GPL_S_C_ID	Geopolitical Structure Component ID	10001	10102	10103	10104	10105	10206
FEAT_CODE	Feature Class Code of the Admin./Named Area	1111	1112	1112	1112	1112	1119
NUM_NAME	counter	1	1	1	1	1	1
LAN_CODE	MARC language code of the language used to name the Administrative Area or Named Area	ENG	ENG	ENG	ENG	ENG	ENG
LOCAL_NM	The local name of the Administrative Area or Named Area in the specified language	Country	State	State of Alaska	District of Columbia	Territory	County
NUM_IMM	counter	0	1	1	1	1	2
PAR_IMM_ID	Immediate parent Geopol. Structure Comp		10001	10001	10001	10001	10102, 10105
NUM_FUL	counter	0	0	0	0	0	0
PRE_FUL_ID	Lowest full predecessor Geopol. Structure Comp						
GPL_S_C_DC	Informative description of the characteristics of this component	Root of USA graph	1 st level subdivision (hierarchical) – (regular) State	1 st level subdivision (hierarchical) – State (Alaska)	1 st level subdivision (hierarchical) – Washington DC	1 st level subdivision (hierarchical) – Territory (Guam, Puerto Rico, ...)	2 nd level subdivision (hierarchical) – County

REC 11	Populated fields	Populated fields	Populated fields	Populated fields	Populated fields	Populated fields	Populated fields
GPL_S_C_ID	10207	10208	10209	10310	10311	10312	10413
FEAT_CODE	1119	1119	1119	1167	1120	1120	1166
NUM_NAME	1	1	1	1	1	1	1
LAN_CODE	ENG	ENG	ENG	ENG	ENG	ENG	ENG
LOCAL_NM	Parish	Borough	Unincorporated Borough	City	CCD	MCD	Borough
NUM_IMM	1	1	1	3	1	2	1
PAR_IMM_ID	10102	10103	10103	10206, 10207, 10208,	10206	10206, 10207	10310
NUM_FUL	0	0	0	3	0	0	0
PRE_FUL_ID				10105, 10102, 10103			
GPL_S_C_DC	2 nd level subdivision (hierarchical) – (Louisiana) Parish	2 nd level subdivision (hierarchical) – (Alaska “county equivalent”) Borough	2 nd level subdivision (hierarchical) – (Alaska “county equivalent”) the Unincorporated Borough (there is only one and it is non-continuous)	3 rd level subdivision (non-hierarchical) – City	3 rd level subdivision (hierarchical) – CCD (Census Tract)	3 rd level subdivision (hierarchical) – MCD (Minor Civil Division: township, “MCD” borough, precinct, “MCD” district, ward)	3 rd level subdivision (non-hierarchical) – (“sub-City”) Borough

Feature: Admin Place C = City of Chicago / Attribute: Geopolitical Structure Containment = 101.10104 / Relationships: Place Within Place = Chicago in Cook County & Chicago in De Kalb County / Attribute of both Relationships: Scope = partial

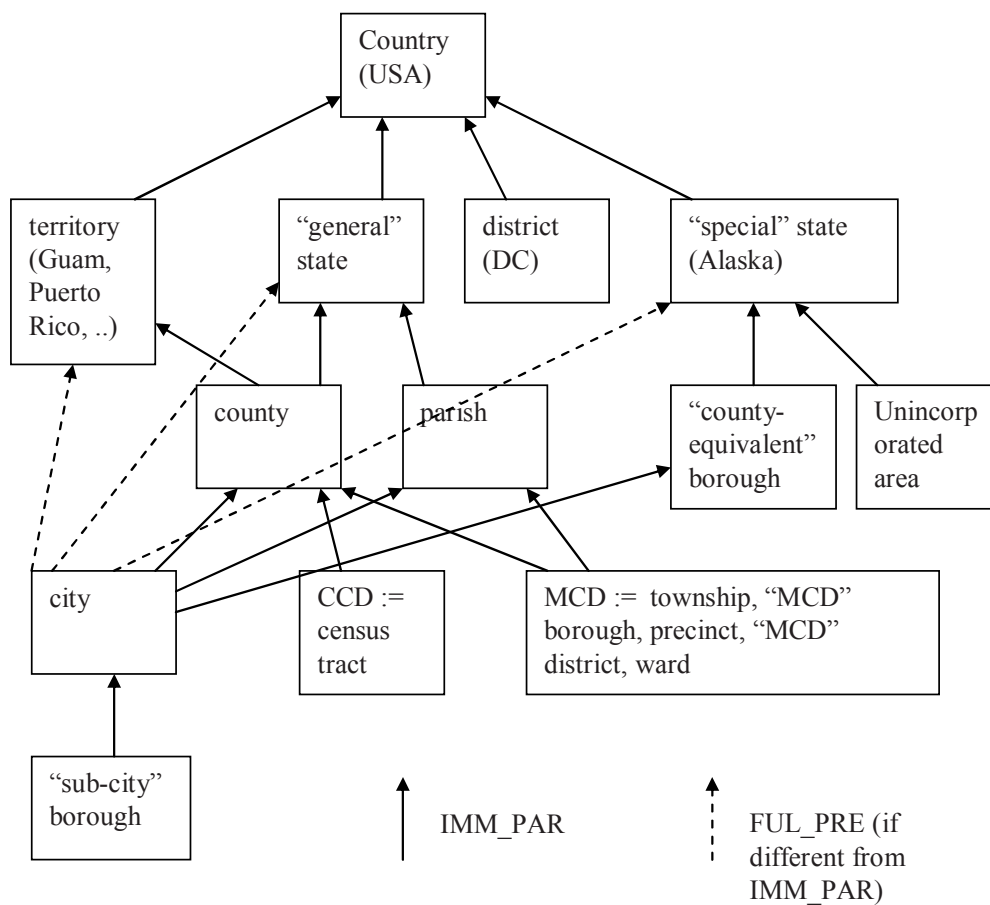

(Entities by means of which a parent is sub-divided are mutually exclusive and they fully tessellate the parent as alternatives.)

(Instances are mentioned in parenthesis as examples where component is used.)

G.2.4 Japanese example

REC 10	Geopolitical Structure Definition Record	Populated fields
GPL_STR_ID	Geopolitical Structure ID	201
GPL_STR_NM	A name for the Geopolitical Structure	Japan admin hierarchy
NUM_COMP	counter	18
GPL_S_C_ID	Geopolitical Structure Component ID	20001, 20102, 20103, 20304, 20205, 20206, 20307, 20308, 20309, 20410, 20511, 20612, 20713, 20414, 20515, 20018, 20119, 20320

REC 11	Geopolitical Structure Component Def. Rec.	Populated fields	Populated fields	Populated fields	Populated fields	Populated fields
GPL_S_C_ID	Geopolitical Structure Component ID	20001	20102	20103	20304	20205
FEAT_CODE	Feature Class Code of the Admin./Named Area	1111	1112	1112	1114	1113
NUM_NAME	counter	1	1	2	1	1
LAN_CODE	MARC language code of the language used to name the Administrative Area or Named Area	ENG	JPN	JPN	JPN	JPN
LOCAL_NM	The local name of the Administrative Area or Named Area in the specified language	Country	To	Fu, Ken	Shi (3)	Shi (2)
NUM_IMM	counter	0	1	1	3	2
PAR_IMM_ID	Immediate parent Geopol. Structure Comp		20001	20001	20102, 20103, 20119	20103, 20119
NUM_FUL	counter	0	0	0	0	0
PRE_FUL_ID	Lowest full predecessor Geopol. Structure Comp					
GPL_S_C_DC	Informative description of the characteristics of this component	Root of Japan graph	1 st level subdivision (hierarchical) - Capital	1 st level subdivision (hierarchical) - non-Capital Prefecture	3 rd level subdivision (hierarchical) - City	2 nd level subdivision (hierarchical) - Specified City

REC 11	Populated fields	Populated fields	Populated fields	Populated fields	Populated fields
GPL_S_C_ID	20206	20307	20308	20309	20410
FEAT_CODE	1113	1114	1114	1114	1117
NUM_NAME	1	1	1	1	1
LAN_CODE	JPN	JPN	JPN	JPN	JPN
LOCAL_NM	Gun	Ku (1)	Chou (1)	Son	Chou (2)
NUM_IMM	3	1	1	1	3
PAR_IMM_ID	20102, 20103, 20119	20205	20206	20206	20304, 20307, 20320
NUM_FUL	0	0	0	0	0
PRE_FUL_ID					
GPL_S_C_DC	2 nd level sub-division (hierarchical) – District , not administrative	3 rd level sub-division (hierarchical) – Ward	3 rd level sub-division (hierarchical) – Town	3 rd level sub-division (hierarchical) – Village	4 th level sub-division (hierarchical: <i>house locator</i> branch) – Major part of Town Name , integral representation with Minor part of Town Name

REC 11	Populated fields	Populated fields	Populated fields	Populated fields	Populated fields
GPL_S_C_ID	20511	20612	20713	20414	20515
FEAT_CODE	1118	1119	1120	1117	1118
NUM_NAME	1	1	1	1	1
LAN_CODE	JPN	JPN	JPN	JPN	JPN
LOCAL_NM	Choume	Ban	Gou	Oo-aza	Ko-aza
NUM_IMM	1	2	1	5	1
PAR_IMM_ID	20410	20511, 20515	20612	20304, 20307, 20308, 20309, 20320	20414
NUM_FUL	0	0	0	0	0
PRE_FUL_ID					
GPL_S_C_DC	5 th level sub-division (hierarchical: <i>house locator</i> branch) – Minor part of Town Name , integral representation with Major part of Town Name, sometimes omitted	6 th level sub-division (hierarchical) – Block/Area number	7 th level sub-division (hierarchical) – House/Branch number , sometimes omitted	4 th level sub-division (hierarchical: <i>area locator</i> branch) – Major part	5 th level sub-division (hierarchical: <i>area locator</i> branch) – Minor part

REC 11	Populated fields	Populated fields	Populated fields
GPL_S_C_ID	20018	20119	20320
FEAT_CODE	1111	1112	1114
NUM_NAME	1	1	1
LAN_CODE	JPN	JPN	JPN
LOCAL_NM	Dou	Shi (1)	-Ku (2)
NUM_IMM	0	1	1
PAR_IMM_ID		20018	20102
NUM_FUL	1	0	0
PRE_FUL_ID	20001		
GPL_S_C_DC	Entity for Hokkaido Island (co-root – “dual star system” - smaller parallel entity to Japan the country)	1 st level subdivision (hierarchical)	3 rd level sub-division (hierarchical) – Capital Ward

Basic hierarchy

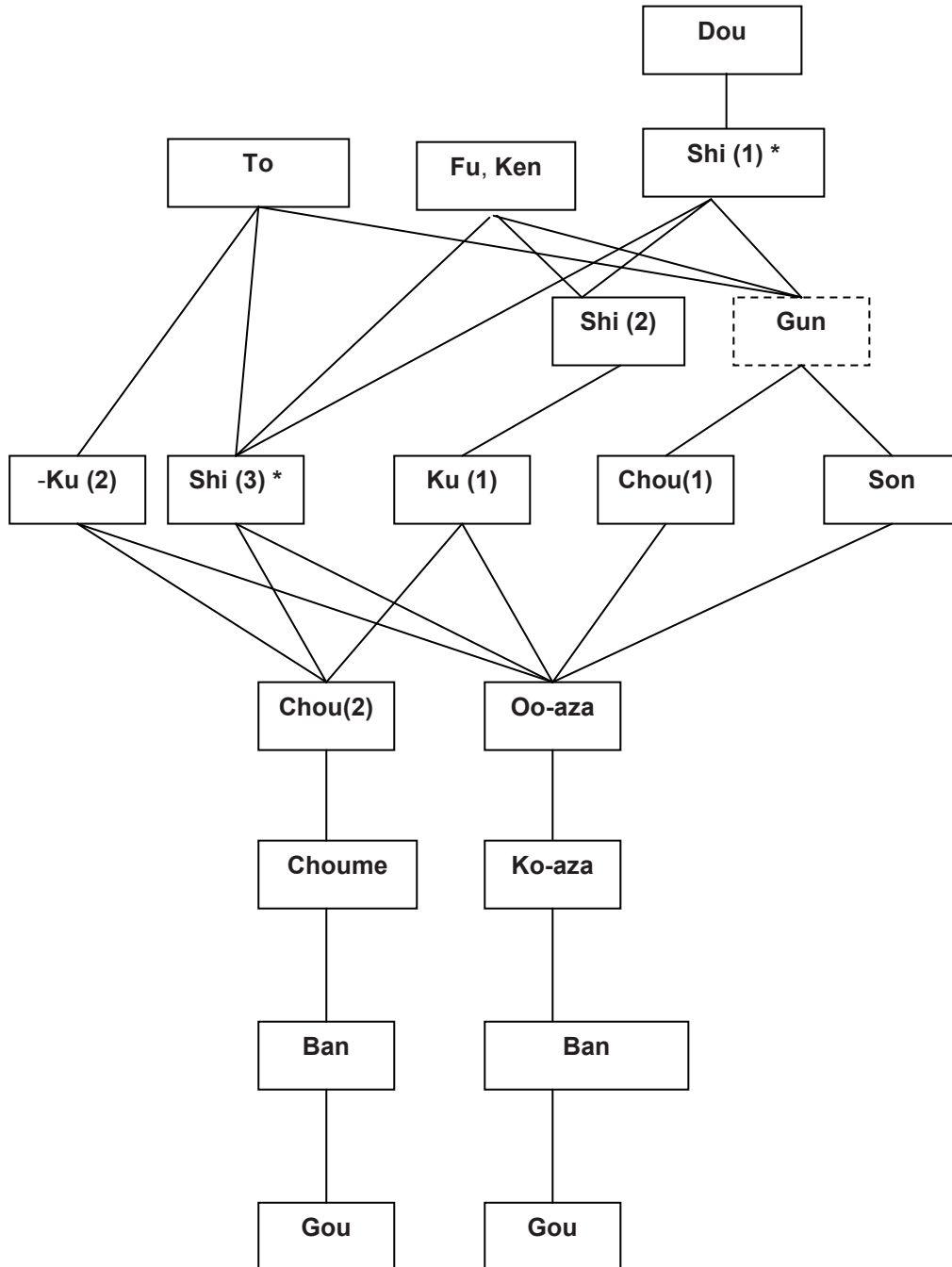

* Characters of "SHI" are different

Annex H (informative)

Specification of possible use of notation and phonetic Attributes for character strings

H.1 Introduction

This annex provides examples, how the different notation and phoneme related Attribute properties can be used to qualify name strings, both in its written and pronounced form.

NOTE 1 Not all Sub-Attributes have been included to limit the complexity of the table.

NOTE 2 The provided examples are solely intended to illustrate the basic concept of the comprehensive name model of GDF.

H.2 Examples

Name Example	Language-coded Text		Notation			Composite Pronunciation		Alternate Composite Pronunciation		
	Language Code	Name String	Notation Version	Notation Variant	Notation Anomaly	Pronunciation Language Code	(Standard) Pronunciation	Pronunciation Variant	Pronunciation Language Code	Alternate Pronunciation
Frankfurt	GER	Frankfurt (Main)	original	given form	usual					
	GER	Frankfurt am Main	original	long form	usual	GER	<German pronunciation>			
						ENG	<English pronunciation>			
	ENG	Frankfurt on the Main	exonym	long form	usual	ENG	<English pronunciation>			
	GER	Frankfurt	original	short form	usual	GER	<German pronunciation>	local	GER	<Hessian pronunciation "Frankfudd">
	FRE	Francfort	exonym	short form	usual	FRE	<French pronunciation>			
GER	Frankfurt a. M.	original	alternate spelling	usual						
Des Plaines	ENG	Des Plaines	original	given form	usual	ENG	<English pronunciation>	local	ENG	<Chicago pronunciation "Dez Planes">
						FRE	<French pronunciation>			
St. Louis	ENG	St. Louis	original	given form	usual					

Name Example	Language-coded Text		Notation			Composite Pronunciation		Alternate Composite Pronunciation		
	Language Code	Name String	Notation Version	Notation Variant	Notation Anomaly	Pronunciation Language Code	(Standard) Pronunciation	Pronunciation Variant	Pronunciation Language Code	Alternate Pronunciation
	ENG	Saint Louis	original	long form	usual	ENG	<English Pronunciation >			
Washington (DC)	ENG	Washington, DC	original	given form	usual					
	ENG	Washington D C	original	long form	usual	ENG	<English Pronunciation >			
	ENG	Washington	original	short form	usual	ENG	<English Pronunciation >			
	ENG	DC	original	short form	synonym			literal	ENG	<English pronunciation "D C">
United Kingdom	ENG	United Kingdom	original	given form	usual	ENG	<English Pronunciation >			
	FRE	Royaume-Uni	exonym	given form	usual	FRE	<French Pronunciation >			
	ENG	UK	original	short form	non-literal			literal	ENG	<English Pronunciation "U K">
	FRE	RU	exonym	short form	non-literal			literal	FRE	<French Pronunciation "R U">
USA	ENG	United States	original	given form	usual	ENG	<English Pronunciation >	local	ENG-SOUTHERN	<English Pronunciation "Yeew'knights d Stahts">
	ENG	United States of America	original	long form	usual	ENG	<English Pronunciation >			
	ENG	USA	original	short form	non-literal			literal	ENG	<English Pronunciation "U S A">
								sub-standard	ENG	<English Pronunciation "U S of A">
								literal	GER	<German Pronunciation "U S A">
	ENG	America	original	short form	synonym	ENG	<English Pronunciation >			
ENG	The States	original	short form	synonym	ENG	<English Pronunciation >				

Name Example	Language-coded Text		Notation			Composite Pronunciation		Alternate Composite Pronunciation		
	Language Code	Name String	Notation Version	Notation Variant	Notation Anomaly	Pronunciation Language Code	(Standard) Pronunciation	Pronunciation Variant	Pronunciation Language Code	Alternate Pronunciation
's-Hertogenbosch	DUT	's-Hertogenbosch	original	given form	usual	DUT	<Dutch pronunciation>			
	DUT	Den Bosch	original	given form	synonym	DUT	<Dutch pronunciation>			
New York City		New York City	original	given form	usual	ENG	<English Pronunciation >			
		New York	original	short form	usual	ENG	<English Pronunciation >			
		NYC	original	short form	non-literal			literal	ENG	<English Pronunciation "N Y C">
		The Big Apple	original	given form	synonym	ENG	<English Pronunciation >			
AAA	ENG	AAA	original	given form	usual	ENG	<English pronunciation "A A A">			
	ENG	Triple A	original	alternate spelling	non-literal	ENG	<English pronunciation>			
FRE						<French pronunciation>				
C.R.E.P.S.	ENG	C.R.E.P.S.	original	given form	usual	ENG	<English Pronunciation "C R E P S">	local	ENG	<English Pronunciation "Crepes">
M.J.C. Coteaux	FRE	M.J.C. Coteaux	original	given form	usual	FRE	<French pronunciation "M J C Coteaux">	sub-standard	FRE	<French pronunciation "Maison Des Jeunes Et De La Culture Coteaux">

Bibliography

- [1] ISO 639-2, *Codes for the representation of names of languages — Part 2: Alpha-3 code*. Codes are available at <http://www.loc.gov/standards/iso639-2/>
- [2] ISO 2108, *Information and documentation — International standard book number (ISBN)*
- [3] ISO 3297, *Information and documentation — International standard serial number (ISSN)*
- [4] ISO 3864-4, *Graphical symbols — Safety colours and safety signs — Part 4: Colorimetric and photometric properties of safety sign materials*
- [5] ISO 6709, *Standard representation of geographic point location by coordinates*
- [6] ISO 8601, *Data elements and interchange formats — Information interchange — Representation of dates and times*
- [7] ISO/IEC 8211, *Information technology — Specification for a data descriptive file for information interchange*
- [8] ISO/IEC 8859-1, *Information technology — 8-bit single-byte coded graphic character sets — Part 1: Latin alphabet No. 1*
- [9] ISO/IEC 8859-2, *Information technology — 8-bit single-byte coded graphic character sets — Part 2: Latin alphabet No. 2*
- [10] ISO/IEC 8859-3, *Information technology — 8-bit single-byte coded graphic character sets — Part 3: Latin alphabet No. 3*
- [11] ISO/IEC 8859-4, *Information technology — 8-bit single-byte coded graphic character sets — Part 4: Latin alphabet No. 4*
- [12] ISO/IEC 8859-5, *Information technology — 8-bit single-byte coded graphic character sets — Part 5: Latin/Cyrillic alphabet*
- [13] ISO/IEC 8859-6, *Information technology — 8-bit single-byte coded graphic character sets — Part 6: Latin/Arabic alphabet*
- [14] ISO/IEC 8859-7, *Information technology — 8-bit single-byte coded graphic character sets — Part 7: Latin/Greek alphabet*
- [15] ISO/IEC 8859-8, *Information technology — 8-bit single-byte coded graphic character sets — Part 8: Latin/Hebrew alphabet*
- [16] ISO/IEC 8859-9, *Information technology — 8-bit single-byte coded graphic character sets — Part 9: Latin alphabet No. 5*
- [17] ISO/IEC 8859-10, *Information technology — 8-bit single-byte coded graphic character sets — Part 10: Latin alphabet No. 6*
- [18] ISO/IEC 8859-11, *Information technology — 8-bit single-byte coded graphic character sets — Part 11: Latin/Thai alphabet*
- [19] ISO/IEC 8859-13, *Information technology — 8-bit single-byte coded graphic character sets — Part 13: Latin alphabet No. 7*

- [20] ISO/IEC 8859-14, *Information technology — 8-bit single-byte coded graphic character sets — Part 14: Latin alphabet No. 8 (Celtic)*
- [21] ISO/IEC 8859-15, *Information technology — 8-bit single-byte coded graphic character sets — Part 15: Latin alphabet No. 9*
- [22] ISO/IEC 8859-16, *Information technology — 8-bit single-byte coded graphic character sets — Part 16: Latin alphabet No.10*
- [23] ISO/IEC 9075-2, *Information technology — Database languages — SQL — Part 2: Foundation (SQL/Foundation)*
- [24] ISO/IEC 10646, *Information technology — Universal Coded Character Set (UCS)*
- [25] ISO/IEC 13249-1, *Information Technology — Database languages — SQL multimedia and application packages — Part 1: Framework*
- [26] ISO/IEC 13249-3, *Information technology — Database languages — SQL multimedia and application packages — Part 3: Spatial*
- [27] ISO 19107:2003, *Geographic information — Spatial schema*
- [28] ISO 19115, *Geographic information — Metadata*
- [29] ISO/TS 19127, *Geographic information — Geodetic codes and parameters*
- [30] ISO 19148⁷⁹⁾, *Geographic information — Linear Referencing*
- [31] ISO/IEC 19501, *Information technology — Open Distributed Processing — Unified Modeling Language (UML) Version 1.4.2*
- [32] EUR 12585, *CORINE Land cover — Technical guide*; European Commission; Luxemburg 1994
- [33] EN 12896:2006, *Road transport and traffic telematics — Public transport — Reference data model*
- [34] Berge, Claude; *Graphs*; North-Holland Mathematical Library, Volume 6 — Part 1; North Holland; Amsterdam, New York, Oxford; 1985
- [35] Barker, Richard, *Case*Method™: Entity Relationship Modeling*, Addison-Wesley Publishing Company, New York, 1990
- [36] British Library UKMARC Manual, <http://www.bl.uk/bibliographic/ukmarc.html>
- [37] Date, C.J., *An Introduction to Database Systems*, Seventh Edition, Addison Wesley Longman, Inc., New York, 2000
- [38] *Digital Geographic Information Exchange Standard (DIGEST) 2.1, Part 3 Codes and Parameters*; Digital Geographic Information Working Group; 2008, http://www.dgiwg.org/dgiwg/htm/documents/historical_documents.htm
- [39] *The DRM (Digital Road Map) Standard Format 21 Ver. 1.3* (in Japanese), Japan Digital Road Map Association, Japan, 2007
- [40] FIG; *Technical Dictionary, terms and definitions as used in surveying and mapping in Germany*; Institute for Applied Geodesy; Frankfurt am Main; 1971

⁷⁹⁾ To be published.

- [41] National Committee for Digital Cartographic Data Standards et al.; *Spatial Data Transfer Standard*; U.S. Geological Survey, National Mapping Division; Columbus, Ohio, USA; June 1990
- [42] IATA, Airline Coding Directory, <http://www.iata.org/ps/publications/acd.htm>
- [43] ICA; *Multilingual Dictionary of Technical Terms in Cartography*; International Cartographic Association; Wiesbaden; 1973
- [44] ICAO Document 7910: Location Indicators, ICAO, <http://www.airport-technology.com/icao-codes/>
- [45] International Federation of Library Associations and Institutions, ISBD(G): General International Standard Bibliographic Description (1992) and ISBD(CM): International Standard Bibliographic Description for Cartographic Materials (Revised edition 1987); IFLA International Office for UBC; London, U.K.
- [46] International Phonetic Alphabet (IPA), International Phonetic Association, <http://www.langsci.ucl.ac.uk/ipa/ipachart.html>
- [47] JIS X0208 Annex 1, 7-bits and 8-bits double byte coded KANJI sets for information interchange (Shift-JIS); Japanese Standards Association; 2007-09-27
- [48] KS X 1001:2004 (previously named KSC-5601:1987) Code for information interchange (Hangeul and hanja); *Korean Industrial Standard (KS) — Information Industry Standard*, Korean Agency for Technology and Standards; 2004-12-28
- [49] MIME Media Types, IANA, <http://www.iana.org/assignments/media-types/>
- [50] SAMPA (Speech Assessments Methods Phonetic Alphabet), The Speech Assessment Methods (SAM) research project, <http://www.phon.ucl.ac.uk/home/sampa/home.htm>
- [51] SAMPROSA (SAM PROSodic Alphabet symbol set), The SAM Prosody Group, <http://www.phon.ucl.ac.uk/home/sampa/samprosa.htm>
- [52] W3C, *Extensible Markup Language (XML) 1.0 (Third Edition)*, W3C Recommendation (4 February 2004)
- [53] W3C, *XML Base*, W3C Recommendation (27 June 2001)
- [54] W3C, *Namespaces in XML*, W3C Recommendation (14 January 1999)
- [55] W3C, *XML Schema Part 1: Structures*, W3C Recommendation (2 May 2001)
- [56] W3C *XML Schema Part 2: Datatypes*, W3C Recommendation (2 May 2001)
- [57] Working Party to Produce National Standards for the Transfer of Digital Map Data; National Transfer Format, Release 1.1; Ordnance Survey; Southampton, U.K.; January 1989

British Standards Institution (BSI)

BSI is the independent national body responsible for preparing British Standards and other standards-related publications, information and services.

It presents the UK view on standards in Europe and at the international level.

It is incorporated by Royal Charter.

Revisions

British Standards are updated by amendment or revision. Users of British Standards should make sure that they possess the latest amendments or editions.

It is the constant aim of BSI to improve the quality of our products and services. We would be grateful if anyone finding an inaccuracy or ambiguity while using this British Standard would inform the Secretary of the technical committee responsible, the identity of which can be found on the inside front cover.

Tel: +44 (0)20 8996 9001 Fax: +44 (0)20 8996 7001

BSI offers Members an individual updating service called PLUS which ensures that subscribers automatically receive the latest editions of standards.

Tel: +44 (0)20 8996 7669 Fax: +44 (0)20 8996 7001

Email: plus@bsigroup.com

Buying standards

You may buy PDF and hard copy versions of standards directly using a credit card from the BSI Shop on the website www.bsigroup.com/shop. In addition all orders for BSI, international and foreign standards publications can be addressed to BSI Customer Services.

Tel: +44 (0)20 8996 9001 Fax: +44 (0)20 8996 7001

Email: orders@bsigroup.com

In response to orders for international standards, it is BSI policy to supply the BSI implementation of those that have been published as British Standards, unless otherwise requested.

Information on standards

BSI provides a wide range of information on national, European and international standards through its Knowledge Centre.

Tel: +44 (0)20 8996 7004 Fax: +44 (0)20 8996 7005

Email: knowledgecentre@bsigroup.com

Various BSI electronic information services are also available which give details on all its products and services.

Tel: +44 (0)20 8996 7111 Fax: +44 (0)20 8996 7048

Email: info@bsigroup.com

BSI Subscribing Members are kept up to date with standards developments and receive substantial discounts on the purchase price of standards. For details of these and other benefits contact Membership Administration.

Tel: +44 (0)20 8996 7002 Fax: +44 (0)20 8996 7001

Email: membership@bsigroup.com

Information regarding online access to British Standards via British Standards Online can be found at www.bsigroup.com/BSOL

Further information about BSI is available on the BSI website at www.bsigroup.com/standards

Copyright

Copyright subsists in all BSI publications. BSI also holds the copyright, in the UK, of the publications of the international standardization bodies. Except as permitted under the Copyright, Designs and Patents Act 1988 no extract may be reproduced, stored in a retrieval system or transmitted in any form or by any means – electronic, photocopying, recording or otherwise – without prior written permission from BSI. This does not preclude the free use, in the course of implementing the standard of necessary details such as symbols, and size, type or grade designations. If these details are to be used for any other purpose than implementation then the prior written permission of BSI must be obtained. Details and advice can be obtained from the Copyright & Licensing Manager.

Tel: +44 (0)20 8996 7070

Email: copyright@bsigroup.com

BSI Group Headquarters

389 Chiswick High Road London W4 4AL UK

Tel +44 (0)20 8996 9001

Fax +44 (0)20 8996 7001

www.bsigroup.com/standards