

Tool steels

The European Standard EN ISO 4957:1999 has the status of a
British Standard

ICS 77.140.35

National foreword

This British Standard is the official English language version of EN ISO 4957:1999. It is identical with ISO 4957:1999. It supersedes BS 4659:1989 which is withdrawn.

The UK participation in its preparation was entrusted to Technical Committee ISE/31, Wrought steels, which has the responsibility to:

- aid enquirers to understand the text;
- present to the responsible international/European committee any enquiries on the interpretation, or proposals for change, and keep the UK interests informed;
- monitor related international and European developments and promulgate them in the UK.

A list of organizations represented on this committee can be obtained on request to its secretary.

Cross-references

Attention is drawn to the fact that CEN and CENELEC Standards normally include an annex which lists normative references to international publications with their corresponding European publications. The British Standards which implement these international or European publications may be found in the BSI Standards Catalogue under the section entitled "International Standards Correspondence Index", or by using the "Find" facility of the BSI Standards Electronic Catalogue.

A British Standard does not purport to include all the necessary provisions of a contract. Users of British Standards are responsible for their correct application.

Compliance with a British Standard does not of itself confer immunity from legal obligations.

Summary of pages

This document comprises a front cover, an inside front cover, the EN ISO title page, the EN ISO foreword page, the ISO title page, pages ii to iv, pages 1 to 32, an inside back cover and a back cover.

The BSI copyright notice displayed in this document indicates when the document was last issued.

Amendments issued since publication

Amd. No.	Date	Comments

This British Standard, having been prepared under the direction of the Engineering Sector Committee, was published under the authority of the Standards Committee and comes into effect on 15 March 2000

© BSI 03-2000

ISBN 0 580 35854 2

ICS 25.100.01; 77.140.10; 77.140.20

English version

Tool steels (ISO 4957:1999)

Aciers à outils (ISO 4957:1999)

Werkzeugstähle (ISO 4957:1999)

This European Standard was approved by CEN on 15 December 1999.

CEN members are bound to comply with the CEN/CENELEC Internal Regulations which stipulate the conditions for giving this European Standard the status of a national standard without any alteration. Up-to-date lists and bibliographical references concerning such national standards may be obtained on application to the Central Secretariat or to any CEN member.

This European Standard exists in three official versions (English, French, German). A version in any other language made by translation under the responsibility of a CEN member into its own language and notified to the Central Secretariat has the same status as the official versions.

CEN members are the national standards bodies of Austria, Belgium, Czech Republic, Denmark, Finland, France, Germany, Greece, Iceland, Ireland, Italy, Luxembourg, Netherlands, Norway, Portugal, Spain, Sweden, Switzerland and United Kingdom.



EUROPEAN COMMITTEE FOR STANDARDIZATION
COMITÉ EUROPÉEN DE NORMALISATION
EUROPÄISCHES KOMITEE FÜR NORMUNG

Central Secretariat: rue de Stassart, 36 B-1050 Brussels

Foreword

The text of the International Standard ISO 4957:1999 has been prepared by Technical Committee ISO/TC 17 "Steel" in collaboration with Technical Committee ECISS/TC 23 "Steels for heat treatment, alloy steels and free-cutting steels - Qualities and dimensions", the secretariat of which is held by DIN.

This European Standard shall be given the status of a national standard, either by publication of an identical text or by endorsement, at the latest by June 2000, and conflicting national standards shall be withdrawn at the latest by June 2000.

According to the CEN/CENELEC Internal Regulations, the national standards organizations of the following countries are bound to implement this European Standard: Austria, Belgium, Czech Republic, Denmark, Finland, France, Germany, Greece, Iceland, Ireland, Italy, Luxembourg, Netherlands, Norway, Portugal, Spain, Sweden, Switzerland and the United Kingdom.

NOTE FROM CEN/CS: The foreword is susceptible to be amended on reception of the German language version. The confirmed or amended foreword, and when appropriate, the normative annex ZA for the references to international publications with their relevant European publications will be circulated with the German version.

Endorsement notice

The text of the International Standard ISO 4957:1999 was approved by CEN as a European Standard without any modification.

INTERNATIONAL STANDARD

ISO
4957

Second edition
1999-12-15

Tool steels

Aciers à outils



Reference number
ISO 4957:1999(E)

Contents

1	Scope	1
2	Normative references	1
3	Terms and definitions	2
4	Requirements	3
5	Inspection, testing and conformance of products	4
6	Marking	5
7	Ordering and designation	5
	Annex A (informative) Hardness-tempering temperature-curves	18
	Annex B (normative) Supplementary or special requirements	28
	Annex C (informative) Designations of comparable steels	30
	Bibliography	32

Foreword

ISO (the International Organization for Standardization) is a worldwide federation of national standards bodies (ISO member bodies). The work of preparing International Standards is normally carried out through ISO technical committees. Each member body interested in a subject for which a technical committee has been established has the right to be represented on that committee. International organizations, governmental and non-governmental, in liaison with ISO, also take part in the work. ISO collaborates closely with the International Electrotechnical Commission (IEC) on all matters of electrotechnical standardization.

International Standards are drafted in accordance with the rules given in the ISO/IEC Directives, Part 3.

Draft International Standards adopted by the technical committees are circulated to the member bodies for voting. Publication as an International Standard requires approval by at least 75 % of the member bodies casting a vote.

Attention is drawn to the possibility that some of the elements of this International Standard may be the subject of patent rights. ISO shall not be held responsible for identifying any or all such patent rights.

International Standard ISO 4957 was prepared by Technical Committee ISO/TC 17, *Steel*, Subcommittee SC 4, *Heat treatable and alloy steels*.

This second edition cancels and replaces the first edition (ISO 4957:1980) which has been technically revised.

Annex B forms a normative part of this International Standard, annexes A and C are for information only.

Tool steels

1 Scope

1.1 This International Standard covers the following grades of wrought tool steels:

- a) non-alloy cold-work tool steels;
- b) alloy cold-work tool steels;
- c) alloy hot-work tool steels;
- d) high-speed tool steels.

If not stated otherwise, this International Standard applies to all types of hot-rolled, forged, cold-drawn or cold-rolled products which are supplied in one of the surface and heat-treatment conditions given in 4.1.2 and Table 1.

Products according to this International Standard may be produced by powder metallurgy.

NOTE 1 The Tables 2, 4, 6 and 8 cover only those steels which have gained certain international importance, which does not mean however, that they are available in all industrial countries. In addition, a number of other steels for tools are specified in regional, national or company standards.

NOTE 2 Where the heat resistance of the tools is of particular importance, as for example in the case of tools for hot forming glass, the material selection should be based on ISO 4955 or ISO 9722.

1.2 In addition to this International Standard, the general technical delivery requirements of ISO 404 are applicable.

2 Normative references

The following normative documents contain provisions which, through reference in this text, constitute provisions of this International Standard. For dated references, subsequent amendments to, or revisions of, any of these publications do not apply. However, parties to agreements based on this International Standard are encouraged to investigate the possibility of applying the most recent editions of the normative documents indicated below. For undated references, the latest edition of the normative document referred to applies. Members of ISO and IEC maintain registers of currently valid International Standards.

ISO 377:1997, *Steel and steel products — Location and preparation of samples and test pieces for mechanical testing.*

ISO 404:1992, *Steel and steel products — General technical delivery requirements.*

ISO 1035-1:1980, *Hot-rolled steel bars — Part 1: Dimensions of round bars.*

ISO 1035-3:1980, *Hot-rolled steel bars — Part 3: Dimensions of flat bars.*

ISO 1035-4:1982, *Hot-rolled steel bars — Part 4: Tolerances.*

ISO 4948-1:1982, *Steels — Classification — Part 1: Classification of steels into unalloyed and alloy steels based on chemical composition.*

ISO 6506:1981¹⁾, *Metallic materials — Hardness test — Brinell test.*

ISO 6508:1986²⁾, *Metallic materials — Hardness test — Rockwell test (scales A - B - C - D - E - F - G - H - K).*

ISO 6929:1987, *Steel products — Definitions and classification.*

ISO/TR 9769:1991, *Steel and iron — Review of available methods of analysis.*

ISO 10474:1991, *Steel and steel products — Inspection documents.*

ISO 14284:1996, *Steel and iron — Sampling and preparation of samples for the determination of chemical composition.*

3 Terms and definitions

For the purposes of this International Standard, the terms and definitions given in ISO 4948-1 and ISO 6829 as well as the following apply.

3.1

product forms

[ISO 6929]

3.2

unalloyed and alloyed steel

[ISO 4948-1]

3.3

tool steels

special steels suitable for working or processing of materials, for handling and measuring workpieces and, for this purpose, exhibiting high hardness and wear resistance and/or toughness

3.3.1

cold-work tool steels

non-alloy or alloy tool steels for applications in which the surface temperature is generally below 200 °C

3.3.2

hot-work tool steels

alloy tool steels for applications in which the surface temperature is generally over 200 °C

3.3.3

high-speed tool steels

steels used mainly for machining and for forming processes and which, because of their chemical composition, have the highest high-temperature hardness and temper resistance up to about 600 °C

1) To be replaced by ISO 6506-1, ISO 6506-2 and ISO 6506-3.

2) To be replaced by ISO 6508-1, ISO 6508-2 and ISO 6508-3.

4 Requirements

4.1 Manufacturing process

4.1.1 General

The manufacturing process of the steel and the products is left to the discretion of the manufacturer, with the restrictions given in 4.1.2.

When he so requests, the purchaser shall be informed what steel making process is being used.

4.1.2 Heat-treatment condition and surface condition on delivery

The heat-treatment and surface conditions of the products shall comply with the agreements when ordering.

4.1.2.1 Heat-treatment condition

The heat-treatment conditions are given in Table 1.

Unless otherwise specified in the order, the tool steels (except C45U, Table 2, 35CrMo7, X38CrMo16 and 40CrMnNiMo8-6-4, Table 4, 55NiCrMoV7, Table 6) are delivered in the annealed condition.

4.1.2.2 Surface condition

Usual surface conditions are:

- a) the hot-rolled or forged condition (= as hot worked);
- b) the machined (ground, polished, turned, peeled or milled) condition;
- c) the cold-reduced condition.

4.2 Chemical composition and mechanical properties

4.2.1 Table 1 gives a survey of combinations of usual heat-treatment conditions at delivery and requirements according to Tables 2 to 9 (chemical composition, hardness).

4.2.2 For hardness-tempering temperature-curves of the steels see annex A.

4.2.3 For hardness penetration depth of non-alloy cold-work tool steels, see Table 2, footnote d.

4.3 Surface quality

4.3.1 All products shall have a workmanlike finish and shall be clean and free from surface imperfections likely to have an adverse effect on their processing or designated application.

4.3.2 Ground, polished or finished-machined products shall be free from surface imperfections and surface decarburization.

4.3.3 Hot-rolled, forged, cold-drawn or rough-machined products shall be ordered with sufficient material to be removed from all surfaces by machining or grinding to allow for

- a) surface decarburization and
- b) surface imperfections.

As long as no International Standard for the machining allowances of tool steels is available, the allowances shall be agreed at the time of enquiry and order.

4.4 Shape, dimensions and tolerances

The shape, dimensions and tolerances of the products shall comply with the requirements agreed upon at the time of enquiry and order. The agreements shall, as far as possible, be based on corresponding International Standards or otherwise, on suitable national standards.

For rolled flat and round bars, the following International Standards cover dimensions and/or tolerances for products included in this International Standard: ISO 1035-1, ISO 1035-3 and ISO 1035-4.

NOTE By agreement, the tolerances can be all plus or other disposition than equal plus/minus.

5 Inspection, testing and conformance of products

5.1 Inspection and testing procedures and types of inspection documents

5.1.1 For each delivery, the issue of any inspection document in accordance with ISO 10474 may be agreed upon at the time of enquiry and order.

5.1.2 If, in accordance with the agreements made at the time of enquiry and order, a test report is to be provided, this shall cover:

- a) the statement that the material complies with the requirements of the order;
- b) the results of the cast analysis for all elements specified for the type of steel supplied.

5.1.3 If, in accordance with the agreements in the order, an inspection certificate 3.1.A, 3.1.B or 3.1.C or an inspection report 3.2 (see ISO 10474) is to be provided, the specific inspections and tests described in 5.2 shall be carried out and their results shall be certified in the document.

In addition the document shall cover

- a) the results of the cast analysis provided by the manufacturer for all elements specified for the steel type concerned;
- b) the results of all inspections and tests ordered by supplementary requirements (see annex B);
- c) the symbol letters of numbers connecting the inspection documents, the test pieces and products to each other.

5.2 Specific inspection and testing

5.2.1 Number of sample products

5.2.1.1 Chemical composition

The cast analysis is given by the manufacturer. For product analysis see B.2 in annex B.

5.2.1.2 Mechanical properties

One sample product per test unit shall be tested.

5.2.1.2.1 For material delivered in the annealed or annealed and cold rolled or annealed and cold drawn condition, the test unit shall consist of products from the same cast and the same heat-treatment batch.

In the case of material heat treated in a continuous furnace, a heat-treatment batch is regarded as that quantity of products (of the same cast and dimensions) which without any interruptions, was under constant treatment conditions (same furnace temperature, atmosphere and transportation speed) through the furnace.

5.2.1.2.2 For material delivered in the quenched and tempered condition, the test unit shall consist of products from the same cast, heat-treatment and thickness.

However, if the manufacturer verifies that the thickness has no significant effect on the hardness in the quenched and tempered condition, then different thicknesses may be covered in a test unit.

5.2.1.3 Inspection of the surface quality

Unless otherwise agreed when ordering (see B.5), the number of products to be inspected for surface quality is left to the discretion of the inspector.

5.2.1.4 Dimensional inspection

Unless otherwise agreed when ordering (see B.6) the number of products to be inspected for their shape and dimensions is left to the discretion of the inspector.

5.2.2 Sampling

5.2.2.1 The general conditions for selection and preparation of samples and test pieces shall be in accordance with ISO 377 and ISO 14284.

5.2.2.2 For the Brinell hardness test the surface of the sample product or of a test piece taken from the sample product in the delivery condition shall be prepared in accordance with the requirements of ISO 6506.

5.2.3 Test methods

5.2.3.1 The Brinell hardness test shall be made in accordance with ISO 6506.

5.2.3.2 Unless otherwise agreed (see B.5), the surface quality shall be inspected visually.

5.2.4 Retests

For retests, ISO 404 shall apply.

6 Marking

The manufacturer shall mark the products or the bundles or boxes containing the products in a suitable way, so that the identification of the cast, the steel type and the origin of the delivery is possible (see B.8).

7 Ordering and designation

The designation of the product in an order shall cover the following:

- a) The quantity to be delivered.
- b) The designation of the product form (e.g. bar) followed by
 - 1) either the designation of the dimensional standard and the dimensions and tolerances selected from it (see 4.4) or
 - 2) the designation of any other document covering the dimensions and tolerances required for the product.

- c) If a surface condition other than "hot worked" or a special surface quality is required
- 1) the surface condition (see 4.1.2.2);
 - 2) the surface quality (see 4.3).
- d) A description of the steel comprising
- 1) the reference to this International Standard;
 - 2) the designation of the steel type (see Tables 2, 4, 6 and 8);
 - 3) the symbol for the heat-treatment condition on delivery (see Table 1) and, if the products are to be delivered in the quenched and tempered condition, the hardness values required;
 - 4) the standard designation for the required type of inspection document (see ISO 10474);
 - 5) the symbol and, where necessary, the details of this supplementary requirement (see annex B), if any supplementary requirement shall be complied with.

EXAMPLE

The following are to be ordered.

- a) 2 t Hot-rolled round bars
- 1) in accordance with ISO 1035-1;
 - 2) with a nominal diameter of 30,0 mm;
 - 3) with a nominal length of 4 000 mm;
 - 4) with a tolerance on diameter of $\pm 0,30$ mm (class S of ISO 1035-4:1982);
 - 5) with a tolerance on length of $^{+100}_0$ mm (class L2 of ISO 1035-4:1982);
 - 6) all other tolerances as given in ISO 1035-4, for normal cases.
- b) Surface
- 1) as hot worked.
- c) Steel
- 1) in accordance with this International Standard, type X153CrMoV12 (see Table 4);
 - 2) heat-treatment condition: annealed (soft annealed) (symbol +A, see Table 1);
 - 3) with an inspection certificate 3.1.B (see ISO 10474).
- d) Designation

2 t rounds ISO 1035-1-30,0 S x 4 000 L2

Steel ISO 4957-X153CrMoV12+A-3.1.B

Table 1 — Combinations of heat-treatment conditions at delivery and requirements in accordance with Tables 2 to 9

		4																
		Applicable requirements for																
1	2	3	4.1				4.2				4.3				4.4			
	Heat-treatment condition at delivery	Symbol ^a	non-alloy cold-work tool steels		alloy cold-work tool steels		hot-work tool steels		high-speed tool steels									
2	Untreated	+U	— ^c	+A ^c	— ^c	+A ^c	— ^c	+A ^c	— ^c	+A ^c	— ^c	+A ^c	— ^c	+A ^c	— ^c	+A ^c		
3	Annealed (soft annealed) ^b	+A ^b	Chemical composition acc. to Tables 2 and 3	Hardness acc. to Table 2	Chemical composition acc. to Tables 4 and 5	Hardness acc. to Table 4	Chemical composition acc. to Tables 6 and 7	Hardness acc. to Table 6	Chemical composition acc. to Tables 8 and 9	Hardness acc. to Table 8	Chemical composition acc. to Tables 6 and 7	Hardness acc. to Table 6	Chemical composition acc. to Tables 8 and 9	Hardness acc. to Table 8	Chemical composition acc. to Tables 6 and 7	Hardness acc. to Table 8		
4	Annealed and cold drawn	+A+C	+A and footnote b to Table 2 ^c		+A and footnote c to Table 4 ^c		+A and footnote c to Table 6 ^c		+A and footnote c to Table 8 ^c		+A and footnote c to Table 6 ^c		+A and footnote c to Table 8 ^c		+A and footnote c to Table 8 ^c			
	Annealed and cold-rolled ^d	+A+CR ^d	+A and footnote b to Table 2 ^c		+A and footnote c to Table 4 ^c		+A and footnote c to Table 6 ^c		+A and footnote c to Table 8 ^c		+A and footnote c to Table 6 ^c		+A and footnote c to Table 8 ^c		+A and footnote c to Table 8 ^c			
5	Quenched and tempered ^e	+QT ^e	—		f		f		f		f		f		f			

^a In cases where no heat-treatment condition is specified at the time of ordering, the product will be delivered in the usual heat-treatment condition given in 4.1.2.1.

^b Most common heat-treatment condition at delivery.

^c In addition, the requirements for minimum hardness in the hardening test apply. For verification see B.3.

^d Only for steels of Table 8.

^e Mainly for individually manufactured blocks for moulds and dies.

^f The hardness requirements are to be agreed at the time of enquiry and order.

Table 2 — Chemical composition (cast analysis), annealed hardness, temperature for hardening and hardness in the hardened and tempered condition for non-alloy cold-work tool steels

Steel name	Chemical composition, (% m/m) ^a						Hardness (annealed) ^b +A HB max.	Hardening test			
	C	Si	Mn	P	S	max.		Hardening temperature °C (± 10 °C)	Quenching medium	Tempering temperature °C (± 10 °C)	Hardness HRC min.
C45U	0,42 to 0,50	0,15 to 0,40	0,60 to 0,80	0,030	0,030	0,030	207 ^c	810	W	180	54
C70U ^d	0,65 to 0,75	0,10 to 0,30	0,10 to 0,40	0,030	0,030	0,030	183	800	W	180	57
C80U ^d	0,75 to 0,85	0,10 to 0,30	0,10 to 0,40	0,030	0,030	0,030	192	790	W	180	58
C90U ^d	0,85 to 0,95	0,10 to 0,30	0,10 to 0,40	0,030	0,030	0,030	207	780	W	180	60
C105U ^d	1,00 to 1,10	0,10 to 0,30	0,10 to 0,40	0,030	0,030	0,030	212	780	W	180	61
C120U ^d	1,15 to 1,25	0,10 to 0,30	0,10 to 0,40	0,030	0,030	0,030	217	770	W	180	62

^a Elements not quoted in this table shall not be intentionally added to the steel without the agreement of the purchaser, other than for the purpose of finishing the heat. All reasonable precautions shall be taken to prevent the addition from scrap or other materials used in manufacture, of such elements which affect the hardenability, mechanical properties and applicability.

^b Hardness in the cold drawn condition (+A+C) may be 20 HB higher than in the annealed (+A) condition.

^c This grade is used in the non-heat treated condition.

^d Steel grades C70U to C120U are due to their chemical composition shallow hardening steels. For diameters of 30 mm, the hardness penetration depth will be approximately 3 mm. Through-hardening may only be achieved in diameters up to 10 mm.

Table 3 — Permissible deviations between specified analysis and product analysis for non-alloy cold-work tool steels (see Table 2)

Permissible deviations, (% <i>m/m</i>)				
C	Si	Mn	P	S
± 0,03	± 0,03	± 0,04	+ 0,005	+ 0,005
<p>NOTE The deviations, other than when maxima only are specified, apply either above or below the specified limits of the range but not both above and below for the same element from different sample products from the same cast. When maxima only are specified, the deviations are positive only. The values are valid only if the samples are selected in accordance with ISO 14284, so that they represent the average composition of the cross-section of the product.</p>				

Table 4 — Chemical composition (cast analysis), annealed hardness, temperature for hardening and hardness in the hardened and tempered condition for alloy cold-work tool steels

Steel name	Chemical composition ^{a, b} , (% m/m)										Hardness (annealed) ^c			Hardening test			Hardness HRC min.
	C	Si	Mn	Cr	Mo	Ni	V	W	+A HB max.	Hardening temperature °C (± 10°C)	Quenching medium ^d	Tempering temperature °C (± 10°C)					
105V	1,00 to 1,10	0,10 to 0,30	0,10 to 0,40	—	—	—	—	—	—	—	—	—	—	790	W	180	61
50WCrV8	0,45 to 0,55	0,70 to 1,00	0,15 to 0,45	0,90 to 1,20	—	—	—	—	—	—	—	—	—	920	O	180	56
60WCrV8	0,55 to 0,65	0,70 to 1,00	0,15 to 0,45	0,90 to 1,20	—	—	—	—	—	—	—	—	—	910	O	180	58
102Cr6	0,95 to 1,10	0,15 to 0,35	0,25 to 0,45	1,35 to 1,65	—	—	—	—	—	—	—	—	—	840	O	180	60
21MnCr5	0,18 to 0,24	0,15 to 0,35	1,10 to 1,40	1,00 to 1,30	—	—	—	—	—	—	—	—	—	e	e	e	e
70MnMoCr8	0,65 to 0,75	0,10 to 0,50	1,80 to 2,50	0,90 to 1,20	0,90 to 1,40	—	—	—	—	—	—	—	—	835	A	180	58
90MnCrV8	0,85 to 0,95	0,10 to 0,40	1,80 to 2,20	0,20 to 0,50	—	—	—	—	—	—	—	—	—	790	O	180	60
95MnWCr5	0,90 to 1,00	0,10 to 0,40	1,05 to 1,35	0,40 to 0,65	—	—	—	—	—	—	—	—	—	800	O	180	60
X100CrMoV5	0,95 to 1,05	0,10 to 0,40	0,40 to 0,80	4,80 to 5,50	0,90 to 1,20	—	—	—	—	—	—	—	—	970	A	180	60
X153CrMoV12	1,45 to 1,60	0,10 to 0,60	0,20 to 0,60	11,00 to 13,00	0,70 to 1,00	—	—	—	—	—	—	—	—	1020	A	180	61
X210Cr12	1,90 to 2,20	0,10 to 0,60	0,20 to 0,60	11,00 to 13,00	—	—	—	—	—	—	—	—	—	970	O	180	62
X210CrW12	2,00 to 2,30	0,10 to 0,40	0,30 to 0,60	11,00 to 13,00	—	—	—	—	—	—	—	—	—	970	O	180	62
35CrMo7	0,30 to 0,40	0,30 to 0,70	0,60 to 1,00	1,50 to 2,00	0,35 to 0,55	—	—	—	—	—	—	—	—	—	—	—	f
40CrMnNiMo8-6-49	0,35 to 0,45	0,20 to 0,40	1,30 to 1,60	1,80 to 2,10	0,15 to 0,25	0,90 to 1,20 ^g	—	—	—	—	—	—	—	—	—	—	f
45NiCrMo16	0,40 to 0,50	0,10 to 0,40	0,20 to 0,50	1,20 to 1,50	0,15 to 0,35	3,80 to 4,30	—	—	—	—	—	—	—	850	O	180	52
X40Cr14 ^h	0,36 to 0,42	≤ 1,00	≤ 1,00	12,50 to 14,50	—	—	—	—	—	—	—	—	—	1010	O	180	52
X38CrMo16 ^g	0,33 to 0,45	≤ 1,00	≤ 1,50	15,50 to 17,50	0,80 to 1,30	≤ 1,00	—	—	—	—	—	—	—	—	—	—	f

^a Elements not quoted in this table shall not be intentionally added to the steel without the agreement of the purchaser, other than for the purpose of finishing the heat. All reasonable precautions shall be taken to prevent the addition from scrap or other materials used in manufacture, of such elements which affect the hardenability, mechanical properties and applicability.

^b For all steels: phosphorus ≤ 0,030 % and sulfur ≤ 0,030 % (see, however, footnote g).

^c Hardness in the cold drawn condition (+A +C) may be 20 HB higher than in the annealed condition (+A).

^d Quenching medium: A = Air, O = Oil, W = Water.

^e This material when carburized, quenched and tempered should achieve a surface hardness of 60 HRC.

^f This steel is normally supplied in the quenched and tempered condition with a hardness of approximately 300 HB.

^g By agreement, sulfur may be increased to between 0,050 % and 0,100 % and Ni may be omitted.

^h This steel may also be supplied in the pre-heated condition with a hardness of approximately 300 HB.

Table 5 — Permissible deviations between specified analysis and product analysis for alloy cold-work tool steels (see Table 4)

Steel name	Permissible deviations ^a , (% <i>m/m</i>)										
	C	Si	Mn	P	S	Cr	Mo	Ni	V	W	
105V	± 0,03	± 0,03	± 0,04	+ 0,005	+ 0,005	—	—	—	± 0,02	—	—
50WCrV8	± 0,03	± 0,05	± 0,04	+ 0,005	+ 0,005	± 0,05	—	—	± 0,02	± 0,07	—
60WCrV8	± 0,03	± 0,05	± 0,04	+ 0,005	+ 0,005	± 0,05	—	—	± 0,02	± 0,07	—
102Cr6	± 0,03	± 0,03	± 0,04	+ 0,005	+ 0,005	± 0,07	—	—	—	—	—
21MnCr5	± 0,03	± 0,03	± 0,08	+ 0,005	+ 0,005	± 0,05	—	—	—	—	—
70MnMoCr8	± 0,03	± 0,03	± 0,08	+ 0,005	+ 0,005	± 0,05	± 0,05	—	—	—	—
90MnCrV8	± 0,03	± 0,03	± 0,08	+ 0,005	+ 0,005	± 0,05	—	—	± 0,02	—	—
95MnCrW5	± 0,03	± 0,03	± 0,06	+ 0,005	+ 0,005	± 0,05	—	—	± 0,02	± 0,04	—
X100CrMoV5	± 0,03	± 0,03	± 0,04	+ 0,005	+ 0,005	± 0,10	± 0,05	—	± 0,03	—	—
X153CrMoV12	± 0,04	± 0,03	± 0,04	+ 0,005	+ 0,005	± 0,15	± 0,05	—	± 0,04	—	—
X210Cr12	± 0,05	± 0,03	± 0,04	+ 0,005	+ 0,005	± 0,15	—	—	—	—	—
X210CrW12	± 0,05	± 0,03	± 0,04	+ 0,005	+ 0,005	± 0,15	—	—	—	± 0,04	—
35CrMo7	± 0,03	± 0,03	± 0,04	+ 0,005	+ 0,005	± 0,07	± 0,05	—	—	—	—
40CrMnNiMo8-6-4 ^b	± 0,03	± 0,03	± 0,08	+ 0,005	+ 0,005	± 0,07	± 0,03	± 0,07	—	—	—
45NiCrMo16	± 0,03	± 0,03	± 0,04	+ 0,005	+ 0,005	± 0,07	± 0,03	± 0,07	—	—	—
X40Cr14	± 0,03	+ 0,05	± 0,04	+ 0,005	+ 0,005	± 0,15	—	—	—	—	—
X38CrMo16	± 0,03	+ 0,05	± 0,04	+ 0,005	+ 0,005	± 0,15	± 0,05	± 0,07	—	—	—

^a The deviations, other than when maxima only are specified, apply either above or below the specified limits of the range but not both above and below for the same element from different sample products from the same cast. When maxima only are specified the deviations are positive only. The values are valid only if the samples are selected in accordance with ISO 14284, so that they represent the average composition of the cross-section of the product.

^b If a range for the sulfur content of this grade is agreed, the permissible deviation shall be ± 0,010 %.

Table 6 — Chemical composition (cast analysis), annealed hardness, temperature for hardening, and hardness in the quenched and tempered condition for hot-work tool steels

Steel name	Chemical composition ^{a, b} , (% m/m)										Hardness (annealed) ^c			Hardening test		
	C	Si	Mn	Cr	Mo	V	W	Others	Hardness +A HB max.	Hardening temperature °C (± 10°C)	Quenching medium ^d	Tempering temperature °C (± 10°C)	Hardness HRC min.			
55NiCrMoV7 ^e	0,50 to 0,60	0,10 to 0,40	0,60 to 0,90	0,80 to 1,20	0,35 to 0,55	0,05 to 0,15		Ni: 1,50 to 1,80	248 ^f	850	O	500	429			
32CrMoV12-28	0,28 to 0,35	0,10 to 0,40	0,15 to 0,45	2,70 to 3,20	2,50 to 3,00	0,40 to 0,70		—	229	1040	O	550	46			
X37CrMoV5-1	0,33 to 0,41	0,80 to 1,20	0,25 to 0,50	4,80 to 5,50	1,10 to 1,50	0,30 to 0,50		—	229	1020	O	550	48			
X38CrMoV5-3	0,35 to 0,40	0,30 to 0,50	0,30 to 0,50	4,80 to 5,20	2,70 to 3,20	0,40 to 0,60		—	229	1040	O	550	50			
X40CrMoV5-1	0,35 to 0,42	0,80 to 1,20	0,25 to 0,50	4,80 to 5,50	1,20 to 1,50	0,85 to 1,15		—	229	1020	O	550	50			
50CrMoV13-15	0,45 to 0,55	0,20 to 0,80	0,50 to 0,90	3,00 to 3,50	1,30 to 1,70	0,15 to 0,35		—	248	1010	O	510	56			
X30WCrV9-3	0,25 to 0,35	0,10 to 0,40	0,15 to 0,45	2,50 to 3,20	—	0,30 to 0,50	8,50 to 9,50	—	241	1150	O	600	48			
X35CrWMoV5	0,32 to 0,40	0,80 to 1,20	0,20 to 0,50	4,75 to 5,50	1,25 to 1,60	0,20 to 0,50	1,10 to 1,60	—	229	1020	O	550	48			
38CrCoWV18-17-17	0,35 to 0,45	0,15 to 0,50	0,20 to 0,50	4,00 to 4,70	0,30 to 0,50	1,70 to 2,10	3,80 to 4,50	Co 4,00 to 4,50	260	1120	O	600	48			

a Elements not quoted in this table shall not be intentionally added to the steel without the agreement of the purchaser, other than for the purpose of finishing the heat. All reasonable precautions shall be taken to prevent the addition from scrap or other materials used in manufacture, of such elements which affect the hardenability, mechanical properties and applicability.

b For all steels (unless otherwise specified), phosphorus \leq 0,030 % and sulfur \leq 0,020 %.

c Hardness in the cold drawn condition (+A +C) may be 20 HB higher than in the annealed condition (+A).

d Quenching medium: O = Oil. Usual quenching media for tools are air, gas or salt bath.

e The sulfur content for this grade is \leq 0,030 %.

f For greater dimensions, this steel is normally supplied in the quenched and tempered condition with a hardness of approximately 380 HB.

g This value applies for smaller dimensions only.

Table 7 — Permissible deviations between specified analysis and product analysis for hot-work tool steels (see Table 6)

Steel name	Permissible deviations, (% m/m)										
	C	Si	Mn	P	S	Cr	Mo	Ni	Co	V	W
55NiCrMoV7	± 0,02	± 0,03	± 0,04	+ 0,005	+ 0,005	± 0,05	± 0,04	± 0,07	—	± 0,02	—
32CrMoV12-28	± 0,02	± 0,03	± 0,04	+ 0,005	+ 0,005	± 0,10	± 0,10	—	—	± 0,04	—
X37CrMoV5-1	± 0,02	± 0,05	± 0,04	+ 0,005	+ 0,005	± 0,10	± 0,05	—	—	± 0,04	—
X38CrMoV5-3	± 0,02	± 0,03	± 0,04	+ 0,005	+ 0,005	± 0,10	± 0,10	—	—	± 0,04	—
X40CrMoV5-1	± 0,02	± 0,05	± 0,04	+ 0,005	+ 0,005	± 0,10	± 0,05	—	—	± 0,05	—
50CrMoV13-15	± 0,02	± 0,05	± 0,04	+ 0,005	+ 0,005	± 0,10	± 0,05	—	—	± 0,04	—
X30WCrV9-3	± 0,02	± 0,03	± 0,04	+ 0,005	+ 0,005	± 0,10	—	—	—	± 0,04	± 0,10
X35CrWMoV5	± 0,02	± 0,05	± 0,04	+ 0,005	+ 0,005	± 0,10	± 0,05	—	—	± 0,04	± 0,07
38CrCoWV18-17-17	± 0,02	± 0,03	± 0,04	+ 0,005	+ 0,005	± 0,10	± 0,04	—	± 0,10	± 0,10	± 0,10

NOTE The deviations, other than when maxima only are specified, apply either above or below the specified limits of the range but not both above and below for the same element from different sample products from the same cast. When maxima only are specified the deviations are positive only. The values are valid only if the samples are selected in accordance with ISO 14284, so that they represent the average composition of the cross-section of the product.

Table 8 — Chemical composition (cast analysis), annealed hardness, temperature for hardening and hardness in the hardened and tempered condition for high-speed tool steels

Steel name	Chemical composition ^{a, b, c} , (% m/m)										Hardness (annealed) ^d				Hardening test ^f		
	C	Co	Cr	Mo	V	W	Si	Hardness +A HB max.	Hardening temperature °C (±10°C)	Quenching medium ^e	Tempering temperature °C (±10°C)	Hardness HRC min.					
HS0-4-1	0,77 to 0,85	—	3,90 to 4,40	4,00 to 4,50	0,90 to 1,10	—	≤ 0,65	262	1120		560	60					
HS1-4-2	0,85 to 0,95	—	3,60 to 4,30	4,10 to 4,80	1,70 to 2,20	0,80 to 1,40	≤ 0,65	262	1180		560	63					
HS18-0-1	0,73 to 0,83	—	3,80 to 4,50	—	1,00 to 1,20	17,20 to 18,70	≤ 0,45	269	1260		560	63					
HS2-9-2	0,95 to 1,05	—	3,50 to 4,50	8,20 to 9,20	1,70 to 2,20	1,50 to 2,10	≤ 0,70	269	1200		560	64					
HS1-8-1	0,77 to 0,87	—	3,50 to 4,50	8,00 to 9,00	1,00 to 1,40	1,40 to 2,00	≤ 0,70	262	1190		560	63					
HS3-3-2	0,95 to 1,03	—	3,80 to 4,50	2,50 to 2,90	2,20 to 2,50	2,70 to 3,00	≤ 0,45	255	1190		560	62					
HS6-5-2	0,80 to 0,88	—	3,80 to 4,50	4,70 to 5,20	1,70 to 2,10	5,90 to 6,70	≤ 0,45	262	1220		560	64					
HS6-5-2C ⁹	0,86 to 0,94	—	3,80 to 4,50	4,70 to 5,20	1,70 to 2,10	5,90 to 6,70	≤ 0,45	269	1210		560	64					
HS6-5-3	1,15 to 1,25	—	3,80 to 4,50	4,70 to 5,20	2,70 to 3,20	5,90 to 6,70	≤ 0,45	269	1200		560	64					
HS6-5-3C	1,25 to 1,32	—	3,80 to 4,50	4,70 to 5,20	2,70 to 3,20	5,90 to 6,70	≤ 0,70	269	1180		560	64					
HS6-6-2	1,00 to 1,10	—	3,80 to 4,50	5,50 to 6,50	2,30 to 2,60	5,90 to 6,70	≤ 0,45	262	1200		560	64					
HS6-5-4	1,25 to 1,40	—	3,80 to 4,50	4,20 to 5,00	3,70 to 4,20	5,20 to 6,00	≤ 0,45	269	1210		560	64					
HS6-5-2-5 ⁹	0,87 to 0,95	4,50 to 5,00	3,80 to 4,50	4,70 to 5,20	1,70 to 2,10	5,90 to 6,70	≤ 0,45	269	1210		560	64					
HS6-5-3-8	1,23 to 1,33	8,00 to 8,80	3,80 to 4,50	4,70 to 5,30	2,70 to 3,20	5,90 to 6,70	≤ 0,70	302	1180		560	65					
HS10-4-3-10	1,20 to 1,35	9,50 to 10,50	3,80 to 4,50	3,20 to 3,90	3,00 to 3,50	9,00 to 10,00	≤ 0,45	302	1230		560	66					
HS2-9-1-8	1,05 to 1,15	7,50 to 8,50	3,50 to 4,50	9,00 to 10,00	0,90 to 1,30	1,20 to 1,90	≤ 0,70	277	1190		550	66					

^a Elements not quoted in this table shall not be intentionally added to the steel without the agreement of the purchaser, other than for the purpose of finishing the heat. All reasonable precautions shall be taken to prevent the addition from scrap or other materials used in manufacture, of such elements which affect the hardenability, mechanical properties and applicability.

^b Maximum 0,40 % Mn unless otherwise specified (see footnote g).

^c Maximum 0,030 % P and S each.

^d Hardness in the annealed plus cold drawn condition (+A+C) may be 50 HB and hardness in the annealed plus cold rolled condition (+A+CR) may be 70 HB higher than in the annealed condition (+A).

^e For the reference hardening test either oil or salt bath: in cases of dispute, however, only oil. Usual quenching media in practice are air, gas or salt bath.

^f See B.3.

⁹ A sulfur range of 0,060 % to 0,150 % may be agreed at the time of enquiry and order for this grade. In this case a max. of 0,80 % Mn applies.

Table 9 — Permissible deviations between specified analysis and product analysis for high-speed tool steels (see Table 8)

Steel name	Permissible deviations a, b, (% m/m)										
	C	Si	Mn	P	S	Co	Cr	Mo	V	W	
HS0-4-1	± 0,03	+ 0,03	+ 0,04	+ 0,005	+ 0,005	-	± 0,10	± 0,10	± 0,05	-	
HS1-4-2	± 0,03	+ 0,03	+ 0,04	+ 0,005	+ 0,005	-	± 0,10	± 0,10	± 0,07	± 0,10	
HS18-0-1	± 0,03	+ 0,03	+ 0,04	+ 0,005	+ 0,005	-	± 0,10	-	± 0,05	± 0,20	
HS2-9-2	± 0,03	+ 0,03	+ 0,04	+ 0,005	+ 0,005	-	± 0,10	± 0,10	± 0,07	± 0,10	
HS1-8-1	± 0,03	+ 0,03	+ 0,04	+ 0,005	+ 0,005	-	± 0,10	± 0,10	± 0,05	± 0,10	
HS3-3-2	± 0,03	+ 0,03	+ 0,04	+ 0,005	+ 0,005	-	± 0,10	± 0,10	± 0,10	± 0,10	
HS6-5-2	± 0,03	+ 0,03	+ 0,04	+ 0,005	+ 0,005	-	± 0,10	± 0,10	± 0,07	± 0,10	
HS6-5-2C	± 0,03	+ 0,03	+ 0,04	+ 0,005	+ 0,005	-	± 0,10	± 0,10	± 0,07	± 0,10	
HS6-5-3	± 0,03	+ 0,03	+ 0,04	+ 0,005	+ 0,005	-	± 0,10	± 0,10	± 0,10	± 0,10	
HS6-5-3C	± 0,04	+ 0,03	+ 0,04	+ 0,005	+ 0,005	-	± 0,10	± 0,10	± 0,10	± 0,10	
HS6-6-2	± 0,03	+ 0,03	+ 0,04	+ 0,005	+ 0,005	-	± 0,10	± 0,10	± 0,10	± 0,10	
HS6-5-4	± 0,04	+ 0,03	+ 0,04	+ 0,005	+ 0,005	-	± 0,10	± 0,10	± 0,10	± 0,10	
HS6-5-2-5	± 0,03	+ 0,03	+ 0,04	+ 0,005	+ 0,005	± 0,10	± 0,10	± 0,10	± 0,07	± 0,10	
HS6-5-3-8	± 0,04	+ 0,03	+ 0,04	+ 0,005	+ 0,005	± 0,10	± 0,10	± 0,10	± 0,10	± 0,10	
HS10-4-3-10	± 0,03	+ 0,03	+ 0,04	+ 0,005	+ 0,005	± 0,15	± 0,10	± 0,10	± 0,10	± 0,10	
HS2-9-1-8	± 0,03	+ 0,03	+ 0,04	+ 0,005	+ 0,005	± 0,10	± 0,10	± 0,10	± 0,05	± 0,10	

a The deviations, other than when maxima only are specified, apply either above or below the specified limits of the range but not both above and below for the same element from different sample products from the same cast. When maxima only are specified the deviations are positive only. The values are valid only if the samples are selected in accordance with ISO 14284, so that they represent the average composition of the cross-section of the product.

b If a range for the sulfur content is agreed, the permissible deviation shall be ± 0,010 %.

Dimensions in millimetres

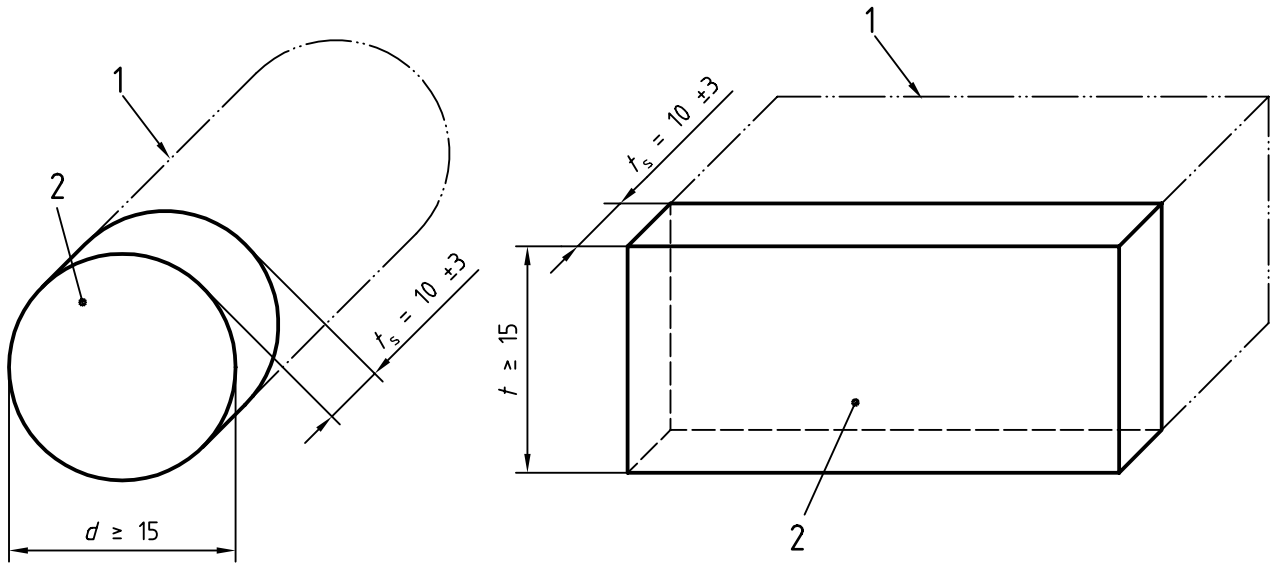

The test piece shall, according to the choice of the manufacturer:

- a) be identical with the test sample, or
- b) be taken from the sample by one cut as demonstrated below, or

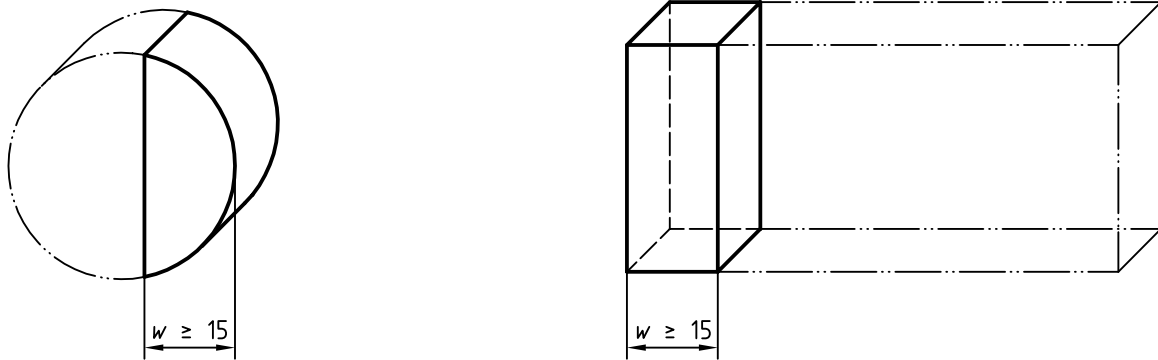

- c) be taken from the sample by two cuts as demonstrated below.

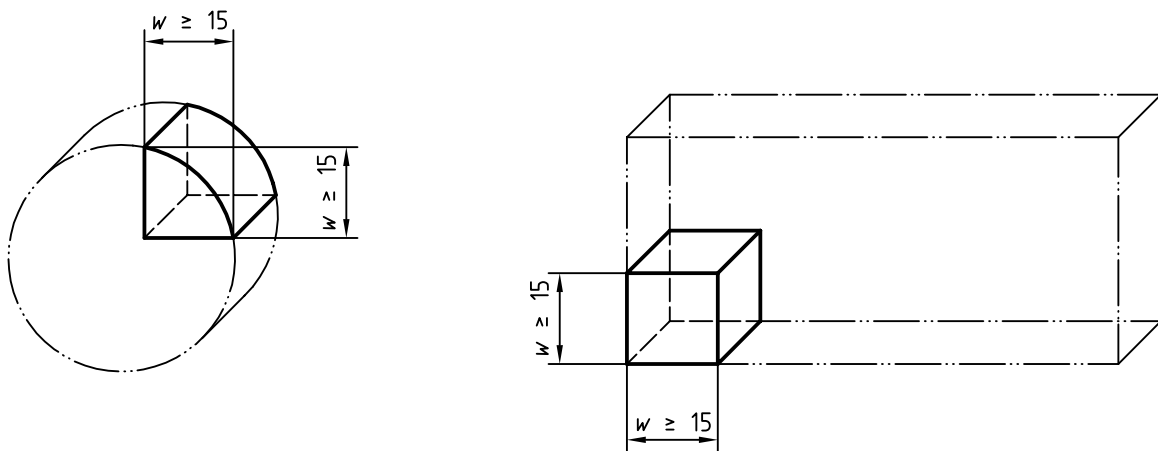

a) Product diameter or thickness ≥ 15 mm

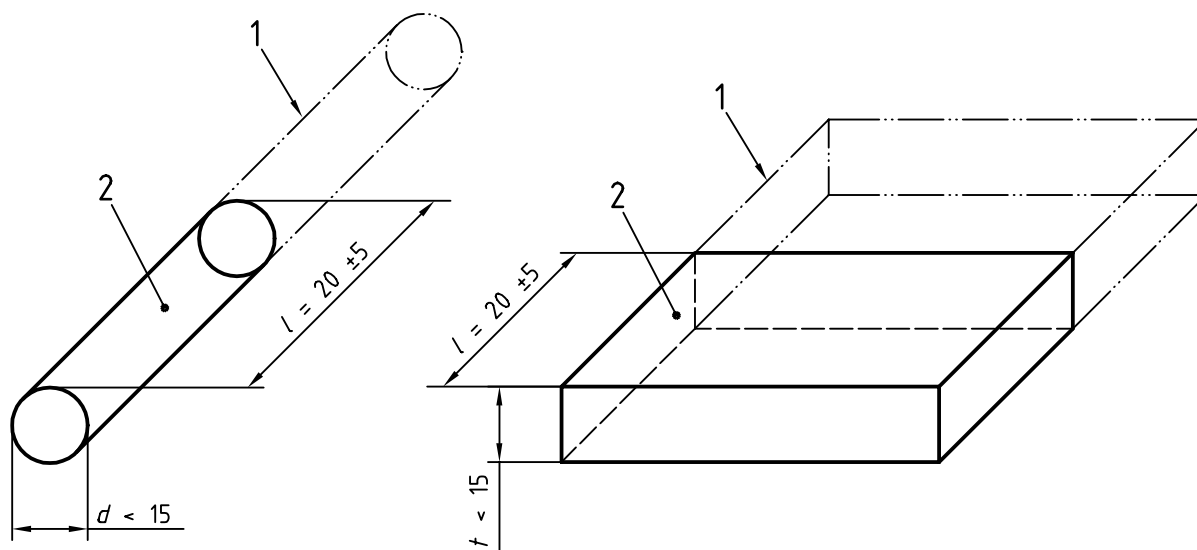

The test piece shall, according to the choice of the manufacturer, either

- a) be identical with the sample, or
- b) be taken from rectangular samples by one cut as demonstrated below.

Key

- 1 Product
- 2 Sample

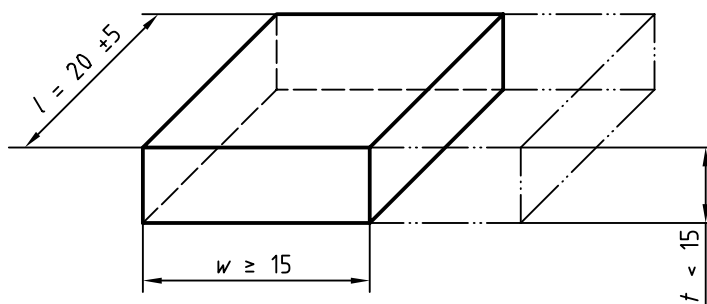

b) Product diameter or thickness < 15 mm

Figure 1 — Location of test pieces in the hardening test

Annex A (informative)

Hardness-tempering temperature-curves

In Figures A.1 to A.4 the hardness-tempering temperature-curves of the steels are given for guidance. In these figures, the austenitizing temperature and the quenching medium (W = water, O = oil, A = air) are mentioned.

NOTE The hardness-tempering temperature-curve for a certain steel type can vary to a considerable extent depending on the chemical composition of the cast, the hardening conditions and the tempering conditions. Consequently the curves in Figures A.1 to A.4 which originate from data from different sources can for the time being give only a rough guide to the tempering behaviour of the steels. They are assumed to apply with the above reservations for test pieces which have been tempered at the relevant tempering temperature but which in all other respects have been prepared according to the conditions for the hardening test (see B.3). When applying the curves for an estimation of the hardness which can be expected in quenched and tempered tools, it should be taken into account that the optimum heat-treatment conditions for the tools are not necessarily identical with those specified for the test pieces and that especially the times for heating given in B.3 are not valid for thicker tools.

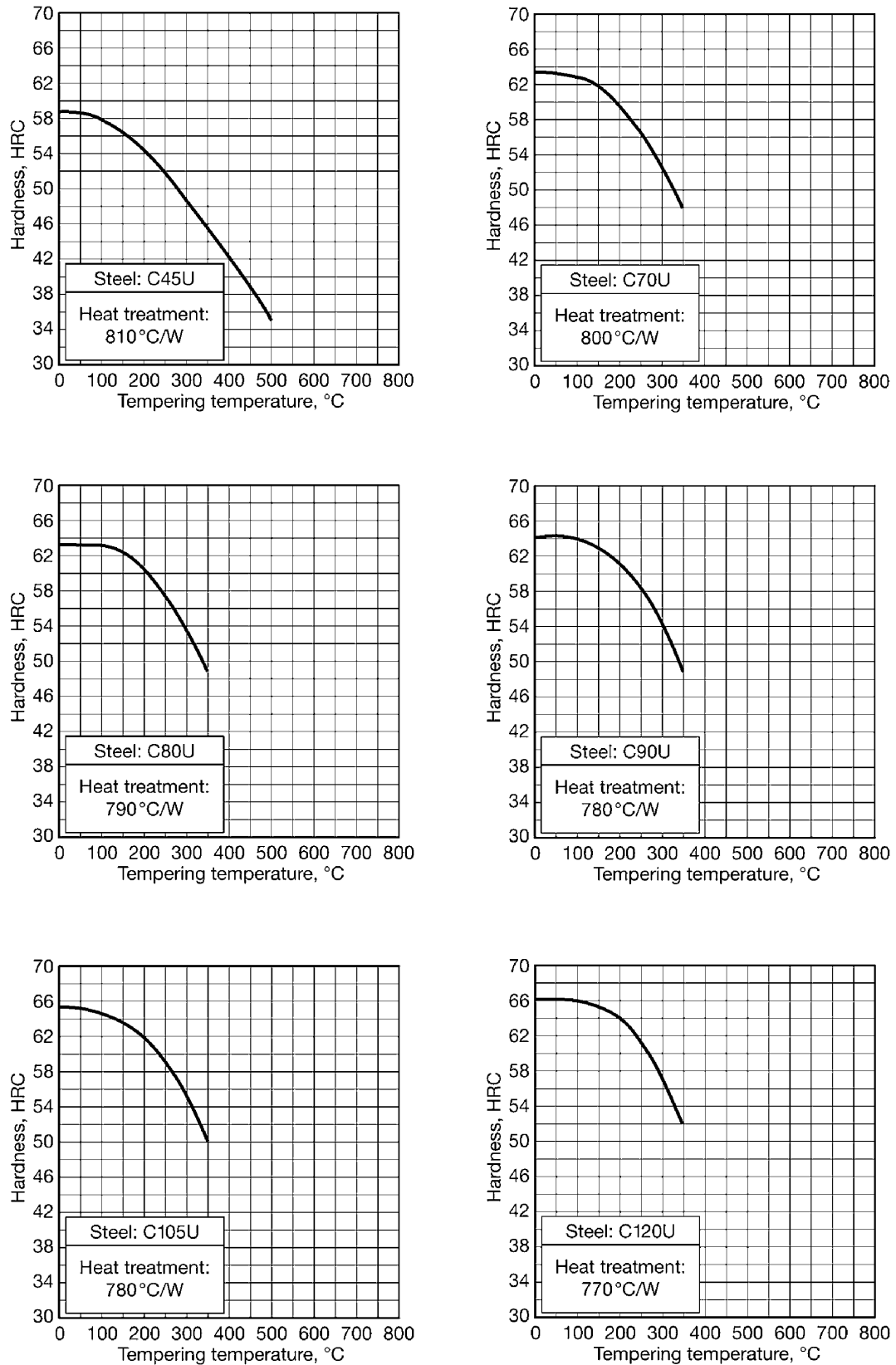

Figure A.1 — Hardness-tempering temperature-curves for unalloyed cold-work tool steels (see Table2)

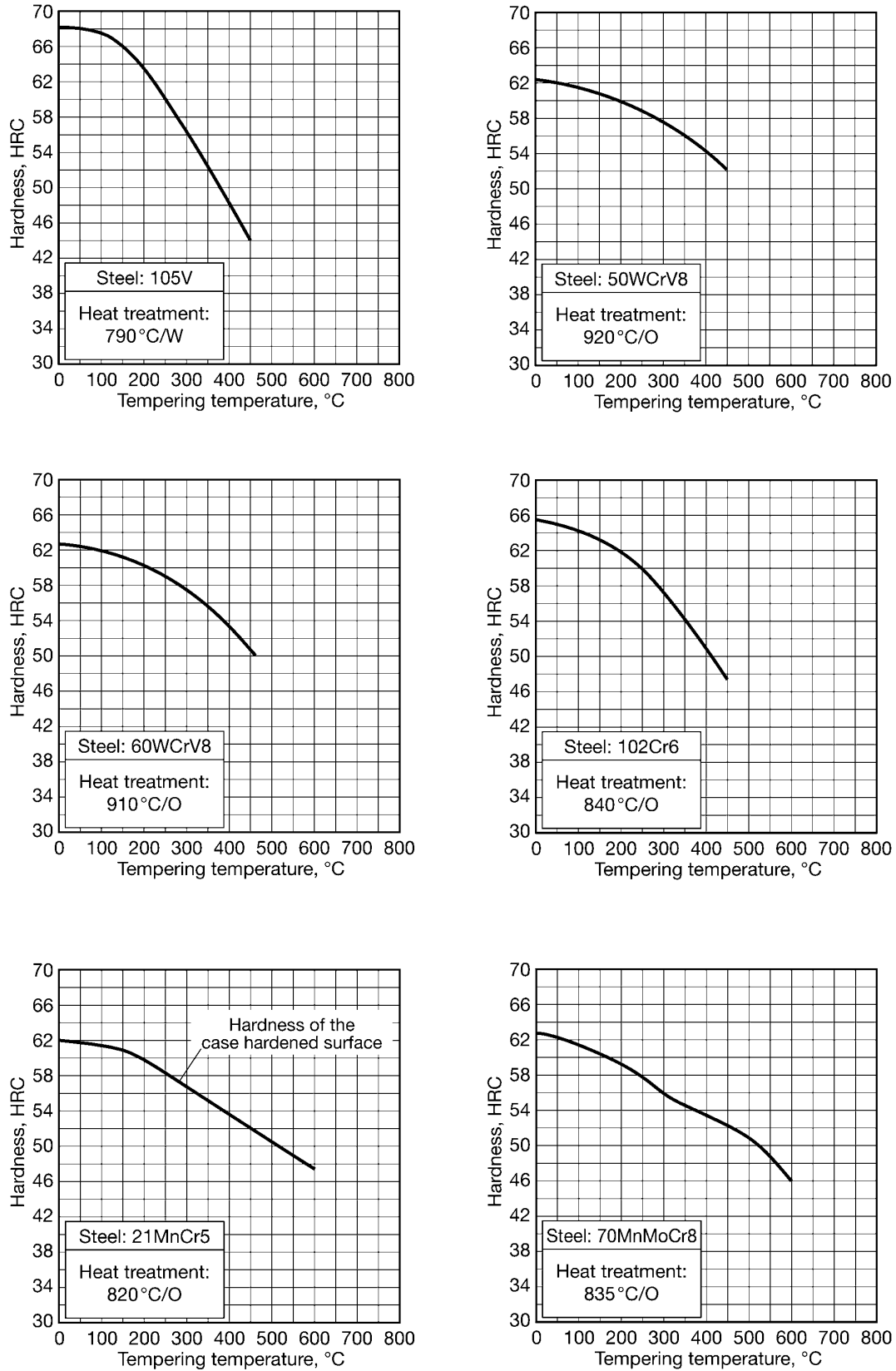

Figure A.2 — Hardness-tempering temperature-curves for alloyed cold-work tool steels (see Table 4)

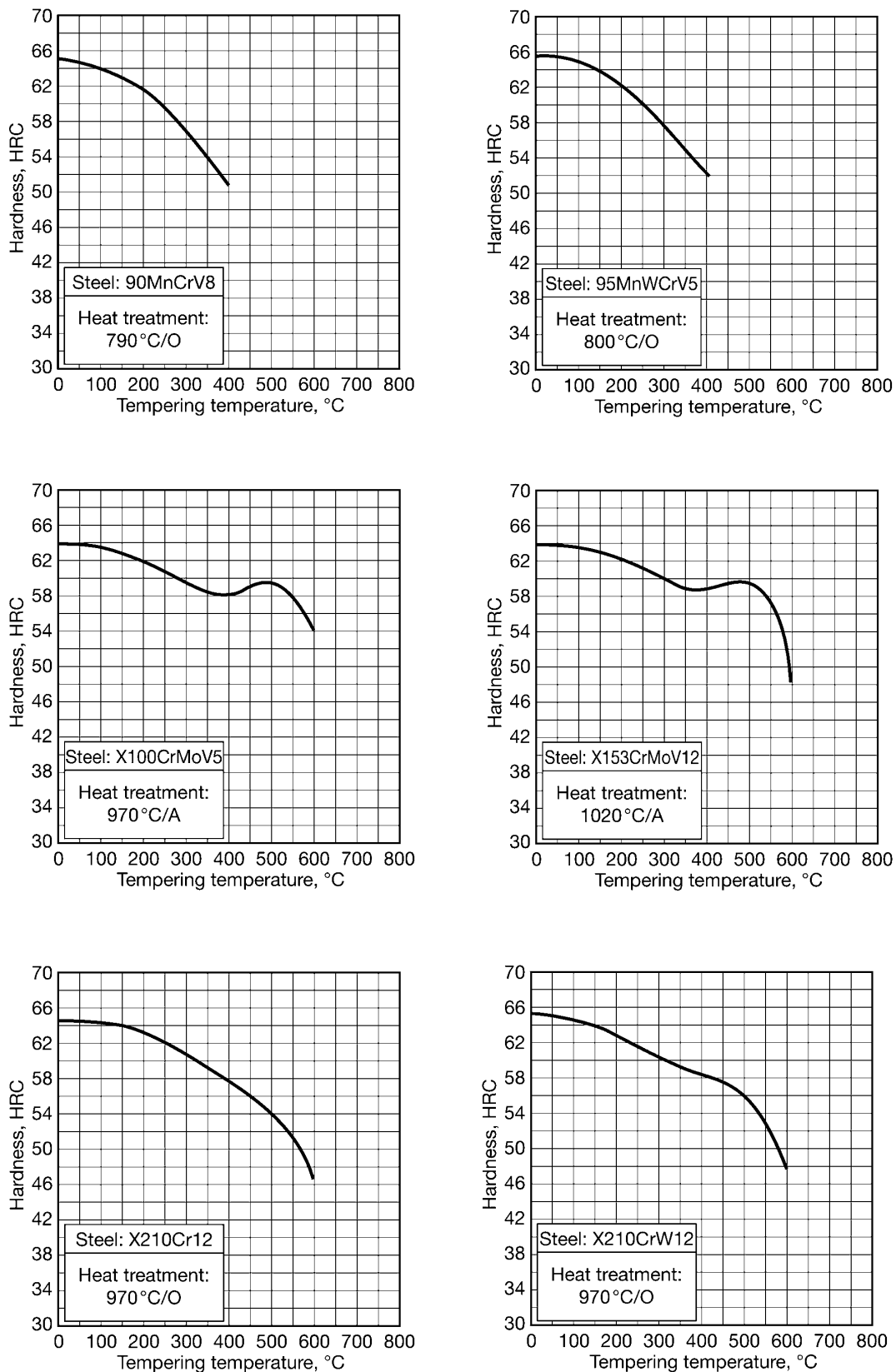

Figure A.2 (continued)

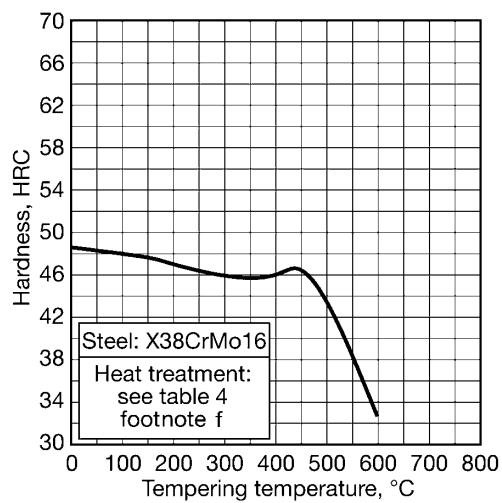
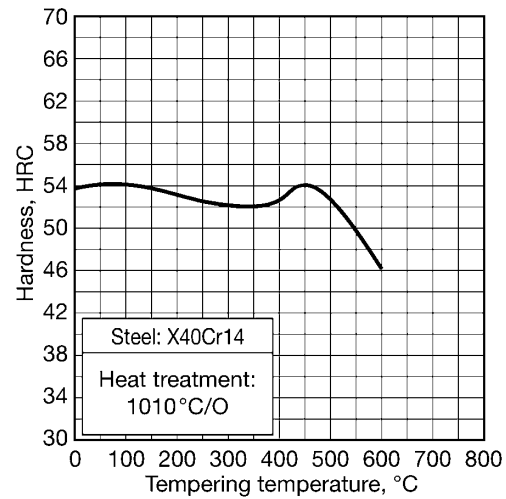
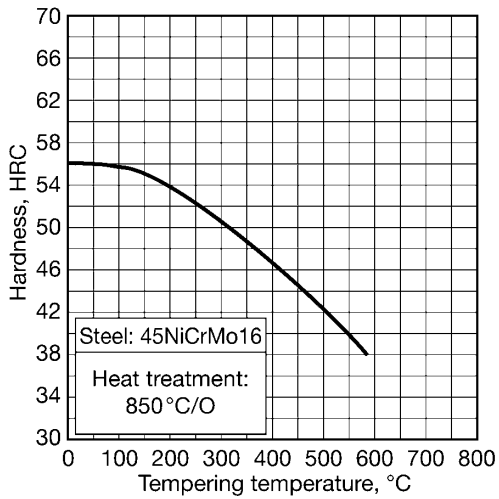
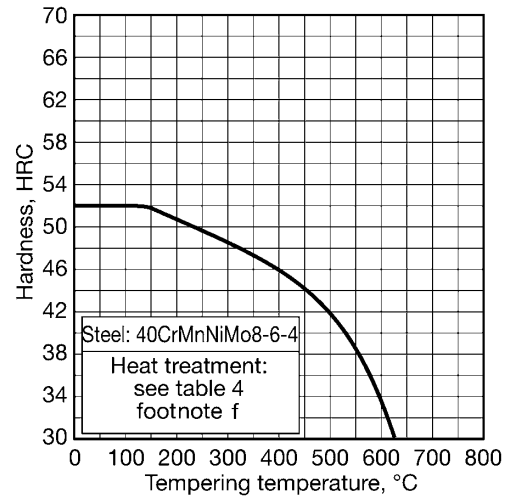
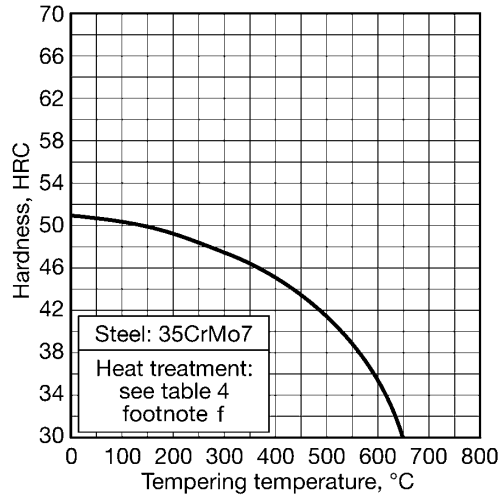

Figure A.2 (continued)

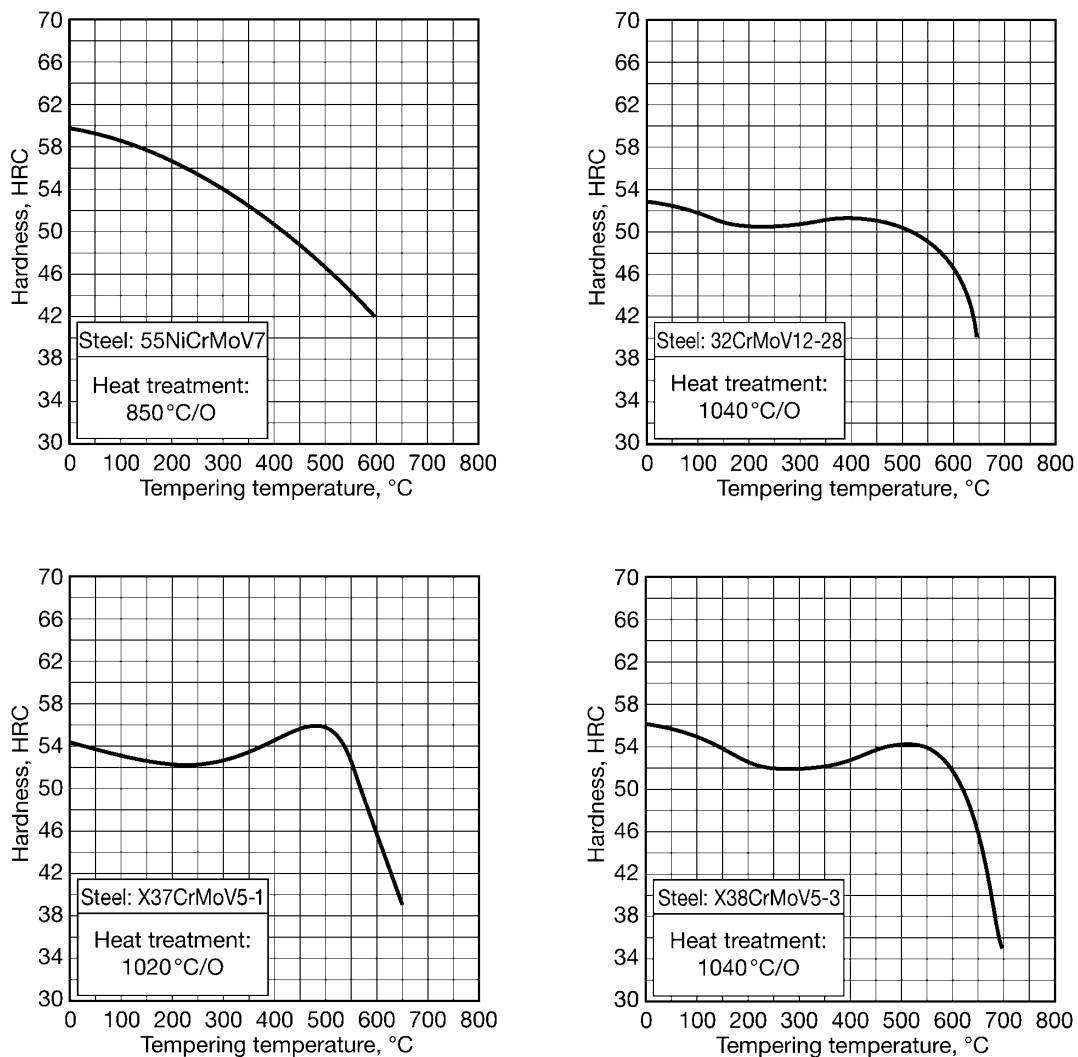

Figure A.3 — Hardness-tempering temperature-curves for hot-work tool steels (see Table 6)

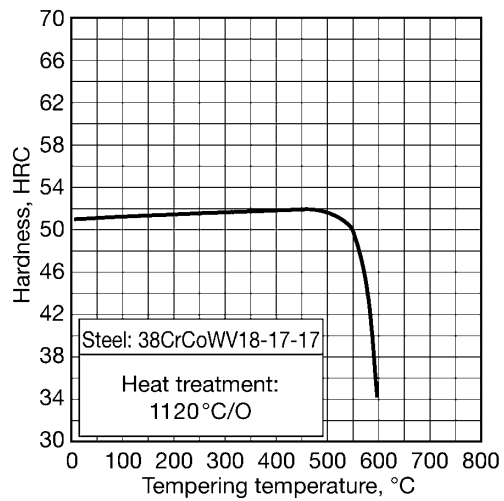
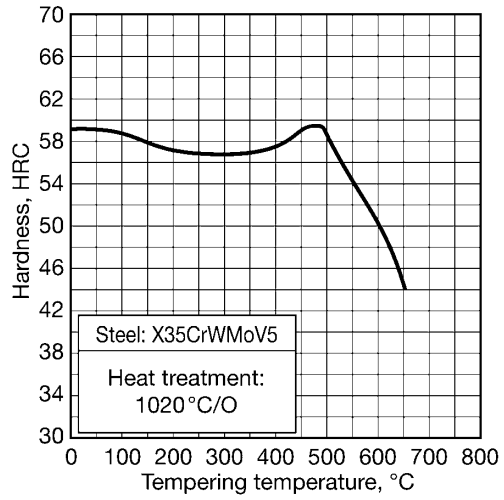
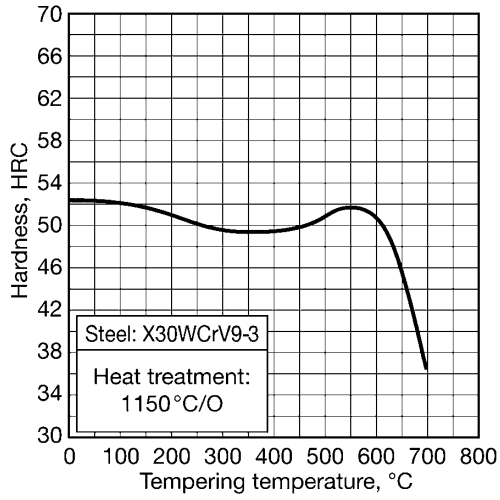
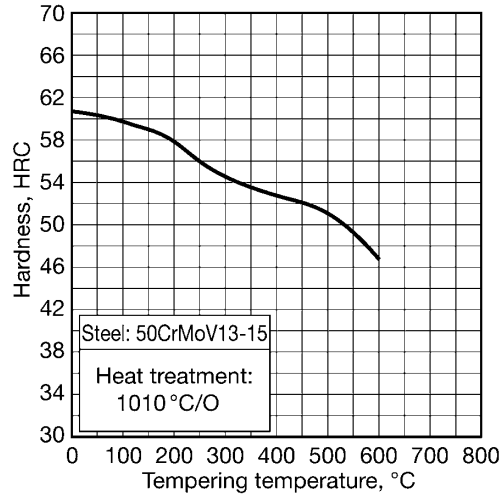
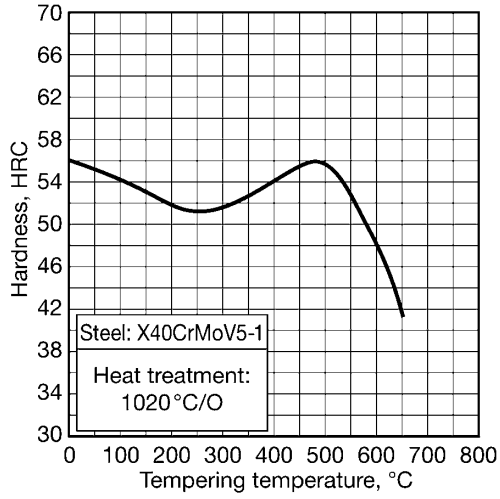

Figure A.3 (continued)

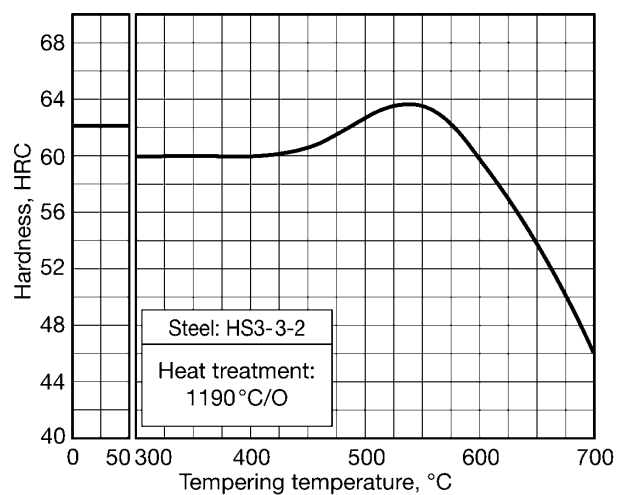
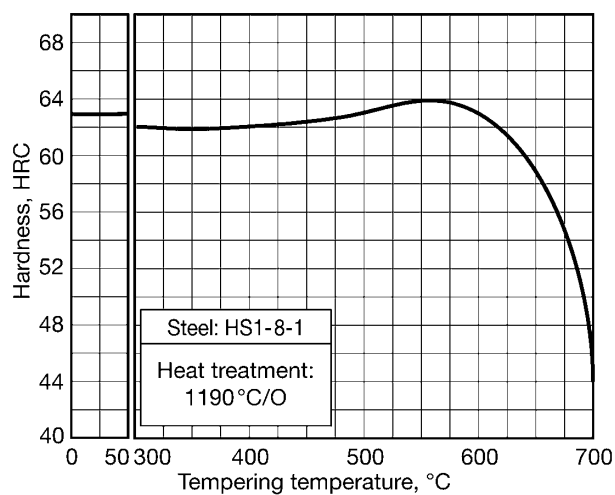
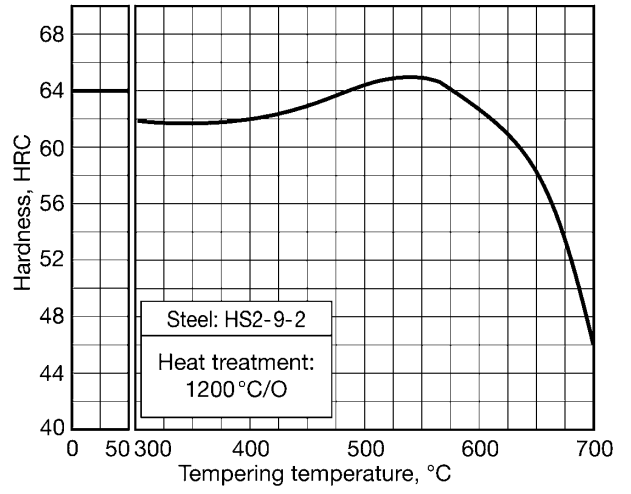
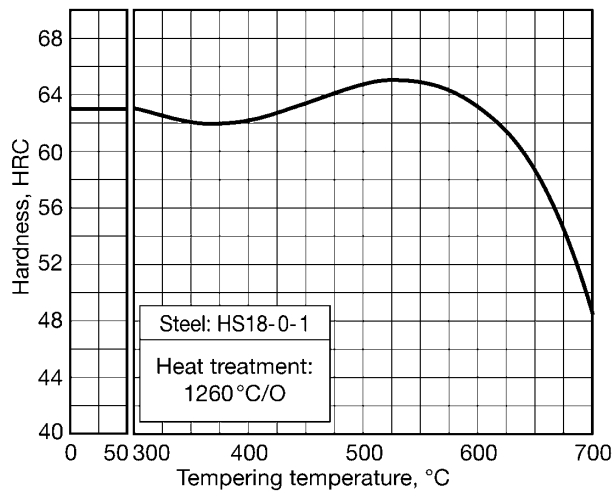
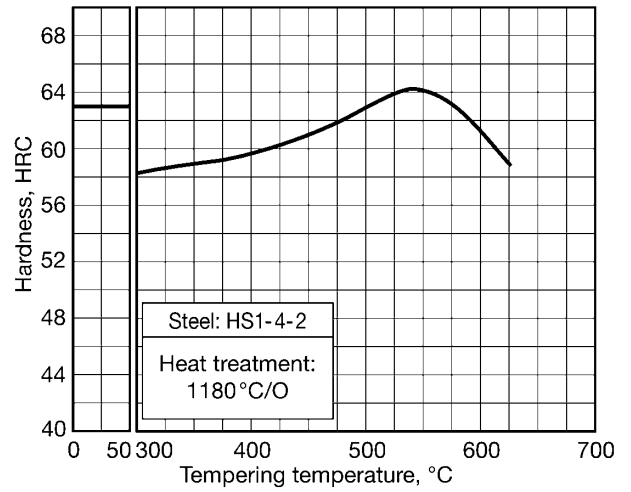
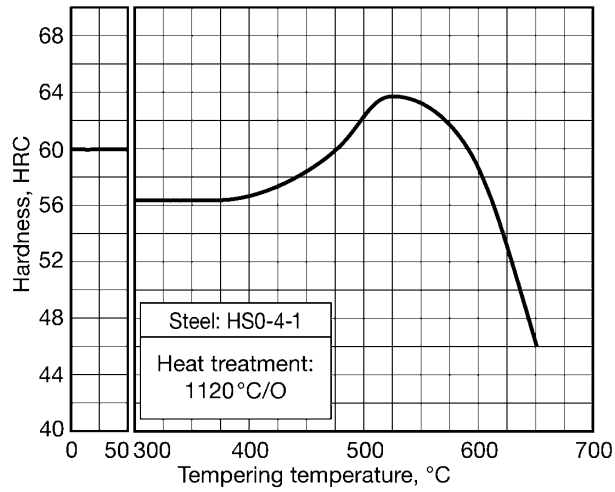

Figure A.4 — Hardness-tempering temperature-curves for high-speed tool steels (see Table 8)

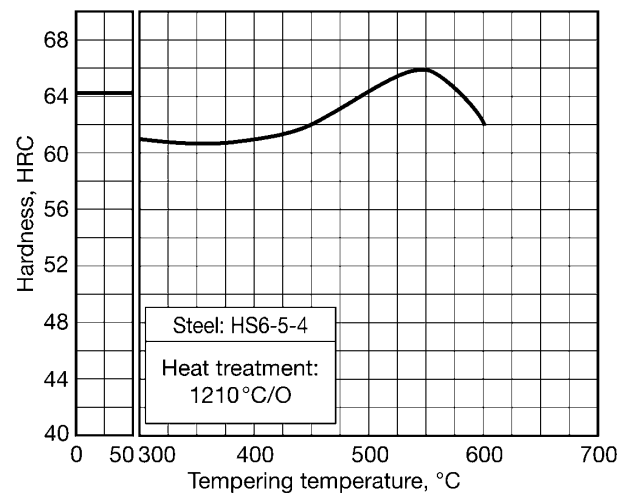
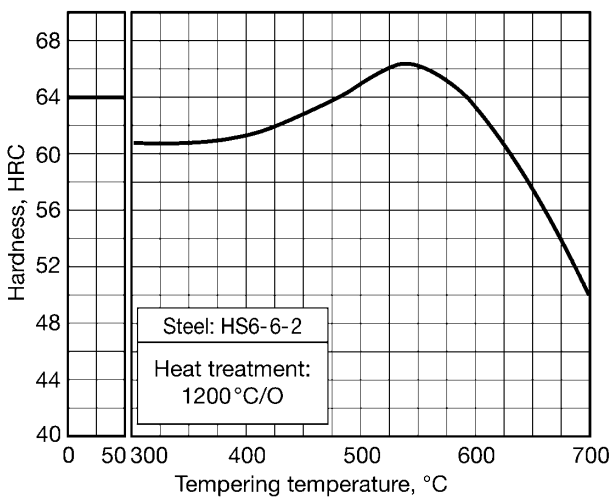
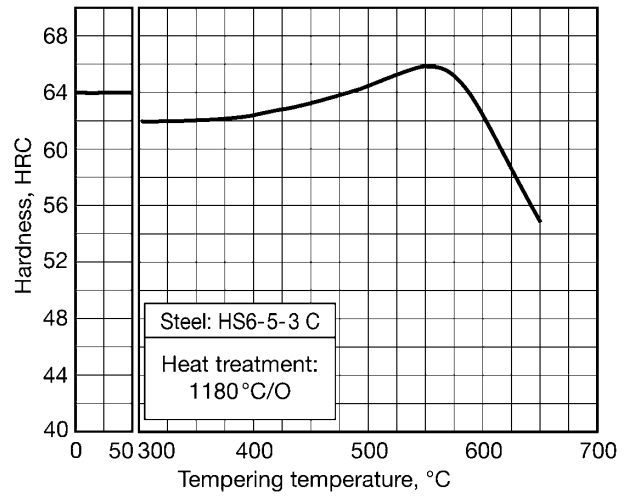
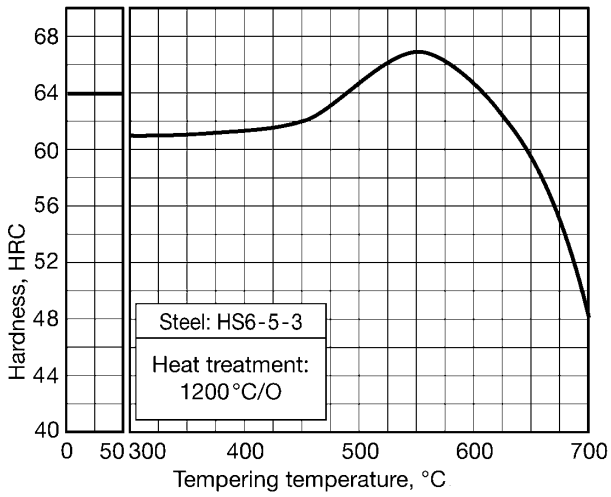
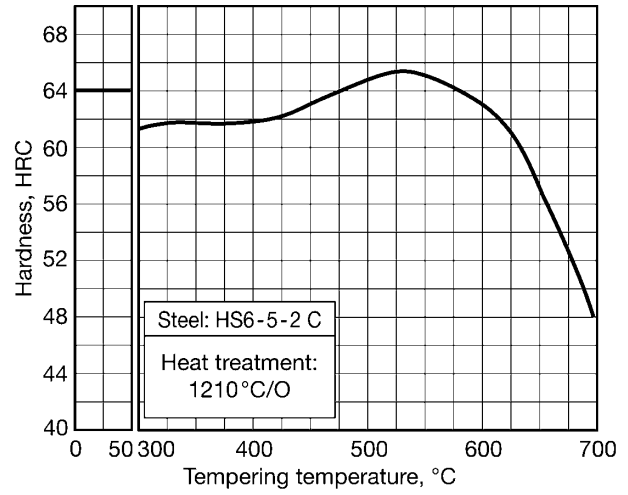
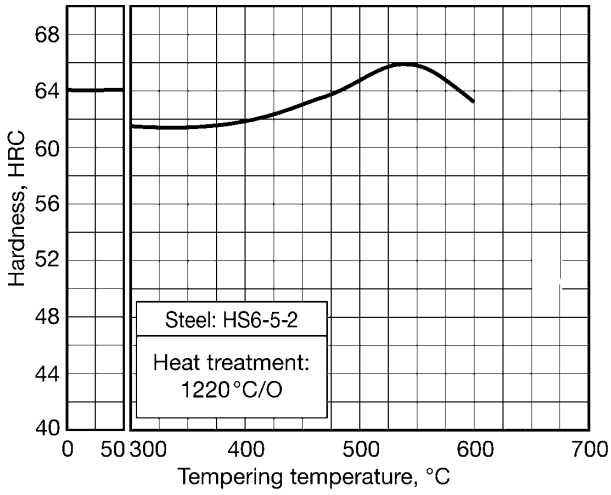

Figure A.4 (continued)

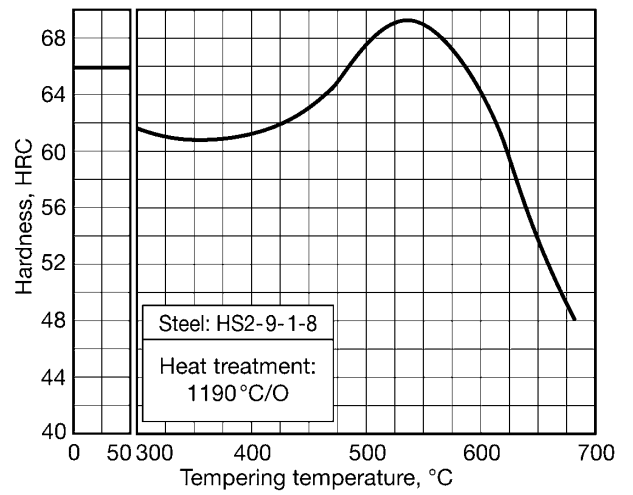
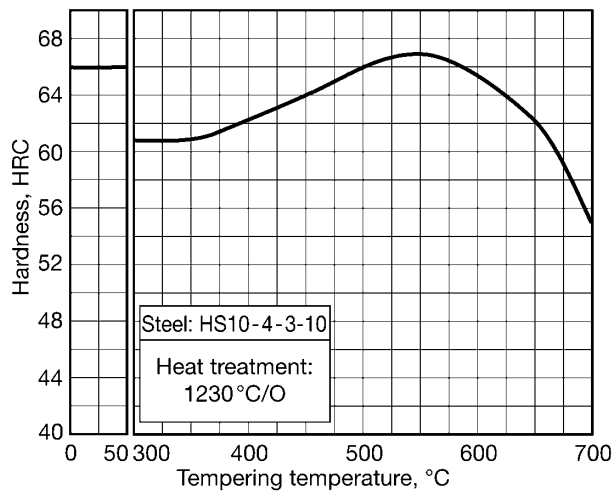
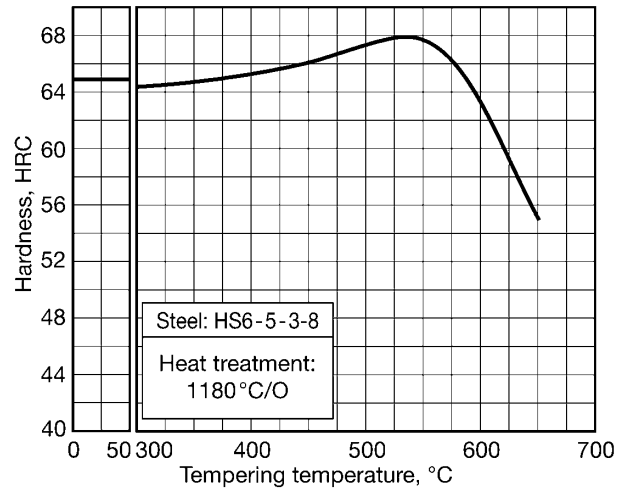
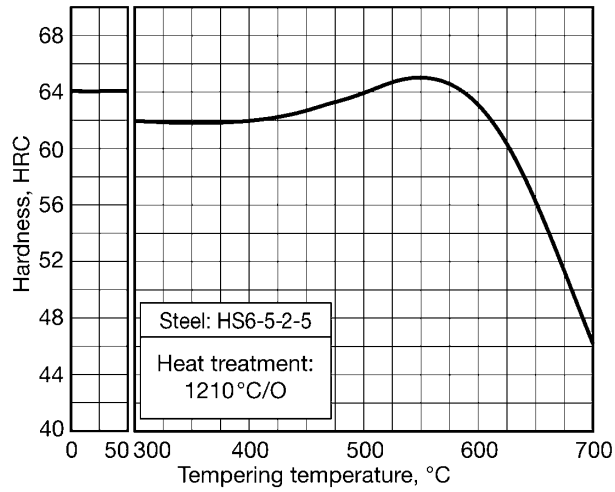

Figure A.4 (continued)

Annex B (normative)

Supplementary or special requirements

B.1 General

One or more of the following supplementary or special requirements shall be applied, but only when specified in the enquiry and order. Where necessary, details of these requirements shall be agreed upon by the manufacturer and purchaser at the time on enquiry and order.

B.2 Product analysis

One product analysis shall be carried out per cast for elements for which values are specified for the cast analysis of the steel type concerned.

The conditions for sampling shall be in accordance with ISO 14284. In the case of dispute about the analytical method, the chemical composition shall be determined in accordance with a reference method taken from one of the International Standards listed in ISO/TR 9769.

B.3 Verification of the minimum hardness in the hardening test

The minimum hardness specified for the hardening test in Tables 2, 4, 6 and 8 shall be verified under the following conditions.

For the hardening test one test piece shall be cut off from the sample product in accordance with the conditions indicated in Figure 1.

The test pieces shall be hardened and tempered under the conditions given in Tables 2, 4, 6 and 8 and under conditions which avoid decarburization. Samples of products in the untreated condition may, at the discretion of the manufacturer, be subjected to an annealing treatment before hardening and tempering is carried out. The total heating time of test pieces in a salt bath shall be as given in Table B.1 below:

Table B.1 — Total heating time of test pieces in a salt bath

Nature of steel	Total heating time for	
	hardening min	tempering min
Cold- or hot-work steels (Tables 2, 4 and 6)	25 ± 1	60
High-speed steels (Table 8)	3	minimum 2 periods of 60 each

If the test pieces are not heated in a salt bath the heating time must be extended accordingly.

The cut surface shall be prepared and the hardness be measured in accordance with ISO 6508.

B.4 Structure

The structure shall comply with the requirements agreed at the time of enquiry and order.

NOTE In the case of non-alloy cold-work tool steels as given in Table 2, the structure consists of ferrite and carbides.

In the case of alloy cold-work tool steels as listed in Table 4, with the exception of steels with 12 % Cr, the structure consists of ferrite and carbide. The carbides shall, if possible, not be concentrated at the grain boundaries. Cold working steels with ≈ 12 % Cr also contain a larger proportion of eutectic carbides. They are arranged in lines or in a network according to the degree of deformation. Their magnitude is determined by the size of ingot or powder used and the degree of forming necessitated by the final dimensions.

Hot-work tool steels (see Table 6) have a structure consisting of ferrite and carbide. In the case of large dimensions in particular, zones with segregations are permitted, provided the properties of the steel in use are not significantly affected by this. The carbides shall, if possible, not be concentrated at the grain boundaries.

The structure of high-speed tool steels (see Table 8) consists of ferrite, eutectic carbides and secondary carbides. The carbide diameters are affected by the size of ingot or powder used and the processing conditions. In the case of thicker dimensions, larger eutectic carbides are likely to occur. High speed steels with high vanadium and tungsten content have larger carbides. The eutectic carbides are arranged in lines or in a network according to the degree of forming used.

B.5 Surface quality

The surface quality shall comply with the requirements agreed at the time of enquiry and order.

Also the details for sampling and for preparation of the test pieces for testing the surface quality shall be agreed at the time of enquiry and order.

B.6 Special dimensional inspection

An agreed number of products shall be inspected for their shape and dimensions.

B.7 Tolerance on mass

The mass tolerances shall comply with the requirements agreed at the time of enquiry and order.

NOTE The following density values should be used as a basis for calculating the nominal mass of products:

For steels with about 18 % W	8,7 kg/dm ³ ,
For steels with about 12 % W	8,4 kg/dm ³ ,
For steels with about 6 % W	8,2 kg/dm ³ ,
For steels with about 3 % W (including steel 60WCrV8)	8,0 kg/dm ³ ,
For steels with about 12 % Cr	7,6 kg/dm ³ ,
For all other steels	7,85 kg/dm ³ .

B.8 Special agreements for marking

The products shall be marked in a way specially agreed upon at the time of enquiry and order.

Annex C (informative)

Designations of comparable steels

Table C.1 — Designations of the steels given in Tables 2, 4, 6 and 8 and of comparable grades covered in various regional or national standards or designation systems

ISO 4957:1999	Steel designations in accordance with	
	EN 10027-2:1992	JIS
Non-alloy cold-work tool steels		
C45U	1.1730	–
C70U	1.1520	SK7
C80U	1.1525	SK6
C90U	1.1535	SK5, SK4
C105U	1.1545	SK3
C120U	1.1555	SK2
Alloy cold-work tool steels		
105V	1.2834	SKS43
50WCrV8	1.2549	–
60WCrV8	1.2550	–
102Cr6	1.2067	–
21MnCr5	1.2162	–
70MnMoCr8	1.2824	–
90MnCrV8	1.2842	–
95MnWCr5	1.2825	–
X100CrMoV5	1.2363	SKD12
X153CrMoV12	1.2379	–
X210Cr12	1.2080	–
X210CrW12	1.2436	–
35CrMo7	1.2302	–
40CrMnNiMo8-6-4	1.2738	–
45NiCrMo16	1.2767	–
X40Cr14	1.2083	–
X38CrMo16	1.2316	–
Hot-work tool steels		
55NiCrMoV7	1.2714	SKT4
32CrMoV12-28	1.2365	SKD7
X37CrMoV5-1	1.2343	SKD6
X38CrMoV5-3	1.2367	–
X40CrMoV5-1	1.2344	SKD61
50CrMoV13-15	1.2355	–
X30WCrV9-3	1.2581	SKD5
X35CrWMoV5	1.2605	SKD62
38CrCoWV18-17-17	1.2661	SKD8

Table C.1 (continued)

ISO 4957:1999	Steel designations in accordance with	
	EN 10027-2:1992	JIS
High-speed tool steels		
HS0-4-1	1.3325	–
HS1-4-2	1.3326	–
HS18-0-1	1.3355	SKH2
HS2-9-2	1.3348	SKH58
HS1-8-1	1.3327	–
HS3-3-2	1.3333	–
HS6-5-2	1.3339	SKH51
HS6-5-2C	1.3343	–
HS6-5-3	1.3344	SKH53
HS6-5-3C	1.3345	–
HS6-6-2	1.3350	SKH52
HS6-5-4	1.3351	SKH54
HS6-5-2-5	1.3243	SKH55
HS6-5-3-8	1.3244	–
HS10-4-3-10	1.3207	SKH57
HS2-9-1-8	1.3247	SKH59

Bibliography

- [1] ISO 4955, *Heat-resisting steels and alloys*.
- [2] ISO 9722, *Nickel and nickel alloys — Composition and forms of wrought products*.
- [3] EN 10027-2, *Designation systems for steels — Part 2: Numerical system*.

BSI — British Standards Institution

BSI is the independent national body responsible for preparing British Standards. It presents the UK view on standards in Europe and at the international level. It is incorporated by Royal Charter.

Revisions

British Standards are updated by amendment or revision. Users of British Standards should make sure that they possess the latest amendments or editions.

It is the constant aim of BSI to improve the quality of our products and services. We would be grateful if anyone finding an inaccuracy or ambiguity while using this British Standard would inform the Secretary of the technical committee responsible, the identity of which can be found on the inside front cover. Tel: 020 8996 9000. Fax: 020 8996 7400.

BSI offers members an individual updating service called PLUS which ensures that subscribers automatically receive the latest editions of standards.

Buying standards

Orders for all BSI, international and foreign standards publications should be addressed to Customer Services. Tel: 020 8996 9001. Fax: 020 8996 7001.

In response to orders for international standards, it is BSI policy to supply the BSI implementation of those that have been published as British Standards, unless otherwise requested.

Information on standards

BSI provides a wide range of information on national, European and international standards through its Library and its Technical Help to Exporters Service. Various BSI electronic information services are also available which give details on all its products and services. Contact the Information Centre. Tel: 020 8996 7111. Fax: 020 8996 7048.

Subscribing members of BSI are kept up to date with standards developments and receive substantial discounts on the purchase price of standards. For details of these and other benefits contact Membership Administration. Tel: 020 8996 7002. Fax: 020 8996 7001.

Copyright

Copyright subsists in all BSI publications. BSI also holds the copyright, in the UK, of the publications of the international standardization bodies. Except as permitted under the Copyright, Designs and Patents Act 1988 no extract may be reproduced, stored in a retrieval system or transmitted in any form or by any means – electronic, photocopying, recording or otherwise – without prior written permission from BSI.

This does not preclude the free use, in the course of implementing the standard, of necessary details such as symbols, and size, type or grade designations. If these details are to be used for any other purpose than implementation then the prior written permission of BSI must be obtained.

If permission is granted, the terms may include royalty payments or a licensing agreement. Details and advice can be obtained from the Copyright Manager. Tel: 020 8996 7070.