



# Standard Guide for Measuring and Reporting Friction Coefficients<sup>1</sup>

This standard is issued under the fixed designation G115; the number immediately following the designation indicates the year of original adoption or, in the case of revision, the year of last revision. A number in parentheses indicates the year of last reapproval. A superscript epsilon ( $\epsilon$ ) indicates an editorial change since the last revision or reapproval.

## 1. Scope

1.1 This guide covers information to assist in the selection of a method for measuring the frictional properties of materials. Requirements for minimum data and a format for presenting these data are suggested. The use of the suggested reporting form will increase the long-term usefulness of the test results within a given laboratory and will facilitate the exchange of test results between laboratories. It is hoped that the use of a uniform reporting format will provide the basis for the preparation of handbooks and computerized databases.

1.2 This guide applies to most solid materials and to most friction measuring techniques and test equipment.

1.3 *Units*—The values stated in SI units are to be regarded as standard. No other units of measurement are included in this standard.

1.4 *This standard does not purport to address all of the safety concerns, if any, associated with its use. It is the responsibility of the user of this standard to establish appropriate safety and health practices and determine the applicability of regulatory limitations prior to use.*

## 2. Referenced Documents

### 2.1 *ASTM Standards*:<sup>2</sup>

- [C808](#) Guide for Reporting Friction and Wear Test Results of Manufactured Carbon and Graphite Bearing and Seal Materials
- [C1028](#) Test Method for Determining the Static Coefficient of Friction of Ceramic Tile and Other Like Surfaces by the Horizontal Dynamometer Pull-Meter Method
- [D1894](#) Test Method for Static and Kinetic Coefficients of Friction of Plastic Film and Sheeting
- [D2047](#) Test Method for Static Coefficient of Friction of Polish-Coated Flooring Surfaces as Measured by the James Machine

- [D2394](#) Test Methods for Simulated Service Testing of Wood and Wood-Base Finish Flooring
- [D2534](#) Test Method for Coefficient of Kinetic Friction for Wax Coatings
- [D2714](#) Test Method for Calibration and Operation of the Falex Block-on-Ring Friction and Wear Testing Machine
- [D3108](#) Test Method for Coefficient of Friction, Yarn to Solid Material
- [D3412](#) Test Method for Coefficient of Friction, Yarn to Yarn
- [D3702](#) Test Method for Wear Rate and Coefficient of Friction of Materials in Self-Lubricated Rubbing Contact Using a Thrust Washer Testing Machine
- [D4103](#) Practice for Preparation of Substrate Surfaces for Coefficient of Friction Testing
- [D4917](#) Test Method for Coefficient of Static and Kinetic Friction of Uncoated Writing and Printing Paper by Use of the Horizontal Plane Method (Withdrawn 2010)<sup>3</sup>
- [D4918](#) Test Method for Coefficient of Static Friction of Uncoated Writing and Printing Paper by Use of the Inclined Plane Method (Withdrawn 2010)<sup>3</sup>
- [D5183](#) Test Method for Determination of the Coefficient of Friction of Lubricants Using the Four-Ball Wear Test Machine
- [D6425](#) Test Method for Measuring Friction and Wear Properties of Extreme Pressure (EP) Lubricating Oils Using SRV Test Machine
- [E122](#) Practice for Calculating Sample Size to Estimate, With Specified Precision, the Average for a Characteristic of a Lot or Process
- [E303](#) Test Method for Measuring Surface Frictional Properties Using the British Pendulum Tester
- [E670](#) Test Method for Testing Side Force Friction on Paved Surfaces Using the Mu-Meter
- [E1911](#) Test Method for Measuring Paved Surface Frictional Properties Using the Dynamic Friction Tester
- [E2100](#) Practice for Calculating the International Runway Friction Index
- [E2101](#) Test Method for Measuring the Frictional Properties of Winter Contaminated Pavement Surfaces Using an Averaging-Type Spot Measuring Decelerometer

<sup>1</sup> This guide is under the jurisdiction of ASTM Committee G02 on Wear and Erosion and is the direct responsibility of Subcommittee G02.50 on Friction.

Current edition approved Nov. 15, 2013. Published November 2013. Originally approved in 1993. Last previous edition was approved in 2010 as G115–10. DOI: 10.1520/G0115-10R13.

<sup>2</sup> For referenced ASTM standards, visit the ASTM website, [www.astm.org](http://www.astm.org), or contact ASTM Customer Service at [service@astm.org](mailto:service@astm.org). For *Annual Book of ASTM Standards* volume information, refer to the standard's Document Summary page on the ASTM website.

<sup>3</sup> The last approved version of this historical standard is referenced on [www.astm.org](http://www.astm.org).

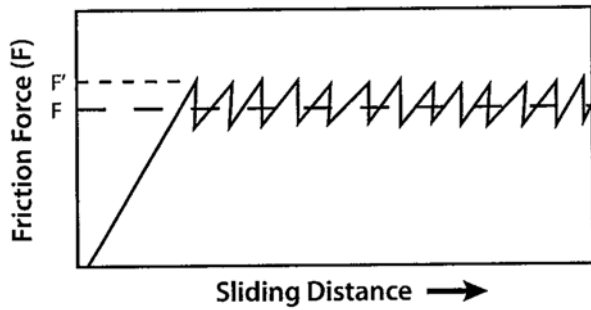

FIG. 1 Typical Force versus Distance Behavior for a System that Exhibits Stick-Slip Behavior

- F609 Test Method for Using a Horizontal Pull Slipmeter (HPS)
- F695 Practice for Ranking of Test Data Obtained for Measurement of Slip Resistance of Footwear Sole, Heel, and Related Materials
- F732 Test Method for Wear Testing of Polymeric Materials Used in Total Joint Prostheses
- G40 Terminology Relating to Wear and Erosion
- G77 Test Method for Ranking Resistance of Materials to Sliding Wear Using Block-on-Ring Wear Test
- G99 Test Method for Wear Testing with a Pin-on-Disk Apparatus
- G133 Test Method for Linearly Reciprocating Ball-on-Flat Sliding Wear
- G137 Test Method for Ranking Resistance of Plastic Materials to Sliding Wear Using a Block-On-Ring Configuration
- G143 Test Method for Measurement of Web/Roller Friction Characteristics
- G163 Guide for Digital Data Acquisition in Wear and Friction Measurements
- G164 Test Method for Determination of Surface Lubrication on Flexible Webs
- G176 Test Method for Ranking Resistance of Plastics to Sliding Wear Using Block-on-Ring Wear Test—Cumulative Wear Method
- G181 Test Method for Conducting Friction Tests of Piston Ring and Cylinder Liner Materials Under Lubricated Conditions
- G182 Test Method for Determination of the Breakaway Friction Characteristics of Rolling Element Bearings
- G194 Test Method for Measuring Rolling Friction Characteristics of a Spherical Shape on a Flat Horizontal Plane

### 3. Terminology

3.1 For definitions relating to frictional properties of materials, refer to Terminology G40.

#### 3.2 Definitions:

3.2.1 *stick-slip, n*—relaxation oscillation usually associated with a decrease in the coefficient of friction as the relative velocity increases.

3.2.1.1 *Discussion*—The usual manifestation is a cycling decrease and subsequent increase in the friction force as sliding proceeds (Fig. 1).

### 4. Summary of Guide

4.1 Current ASTM International friction test standards are tabulated in this guide so that users can review available test methods and determine which method may be most applicable for a particular application. Any of the listed tests or other accepted test may be used. General friction testing precautions are cited and a prescribed method of recording friction data is recommended. This guide is intended to promote the use of this standard reporting system and standard friction test methods.

4.2 The use of one of the test methods (Table 1) cited in this guide will give assurance of a testing procedure that has been agreed-to for a particular application. In addition, it is important to keep in mind that friction is a system property. The coefficient of friction of polystyrene on mild steel measured on a sled test (Test Method D1894) will probably be different than the coefficient of the same couple measured on a block-on-ring tester (Test Method G176) *since the coefficient of friction is a system effect.*

4.3 Data developed by others can be useful if sufficient information is presented to characterize the tribosystem used in testing. Conformance with this guide in testing and reporting should produce data that can be reviewed for applicability to a particular tribosystem.

### 5. Significance and Use

5.1 In this guide, factors that shall be considered in conducting a valid test for the determination of the coefficient of friction of a tribosystem are covered, and the use of a standard reporting format for friction data is encouraged.

5.2 The factors that are important for a valid test may not be obvious to non-tribologists, and the friction tests referenced will assist in selecting the apparatus and test technique that is most appropriate to simulate a tribosystem of interest.

5.3 The tribology literature is replete with friction data that cannot readily be used by others because specifics are not presented on the tribosystem that was used to develop the data. The overall goal of this guide is to provide a reporting format that will enable computer databases to be readily established. These databases can be searched for material couples and tribosystems of interest. Their use will significantly reduce the need for each laboratory to do its own testing. Sufficient information on test conditions will be available to determine applicability of the friction data to the engineer's specific needs.

### 6. Apparatus

6.1 Any of the devices shown schematically in Table 1 can be used to measure the friction forces in a sliding system. Wear test machines are often equipped with sensors to measure friction forces also. The appropriate device to use is the one that closely simulates a tribosystem of interest.

6.2 The key part of simulating a tribosystem is to use specimen geometries that resemble the components in the system of interest. A continuous sliding system needs to be simulated by a continuous friction test; a reciprocating system needs to be simulated by a reciprocating test. Entry geometry

**TABLE 1 ASTM Friction Tests and Applicable Materials**

Standard/Committee	Title	Measured Parameters	Test Configuration
<b>C808/D02.F0</b> on Manufactured Carbon and Graphite Products	Guide for Reporting Friction and Wear Test Results of Manufactured Carbon and Graphite Bearing and Seal Materials	Carbon versus other materials ( $\mu_s$ and $\mu_k$ )	any
<b>C1028/C21</b> on Ceramic Whitewares and Related Products	Test Method for Determining the Static Coefficient of Friction of Ceramic Tile and Other Like Surfaces by the Horizontal Dynamometer Pull-Meter Method	Static COF wet and dry	
<b>D1894/D20</b> on Plastics	Test Method for Static and Kinetic Coefficients of Friction of Plastic Film and Sheeting	Plastic film versus stiff or other solids ( $\mu_s$ and $\mu_k$ )	
<b>D2047/D21</b> on Polishes	Test Method for Static Coefficient of Friction of Polish-Coated Flooring Surfaces as Measured by the James Machine	Walking materials versus shoe heels and soles ( $\mu_s$ and $\mu_k$ )	
<b>D2394/D07</b> on Wood	Test Methods for Simulated Service Testing of Wood and Wood-Base Finish Flooring	Wood and wood base flooring versus sole leather ( $\mu_s$ and $\mu_k$ )	
<b>D2534/D02</b> on Petroleum Products and Lubricants	Test Method for Coefficient of Kinetic Friction for Wax Coatings	Kinetic coefficient of friction	

TABLE 1 Continued

Standard/Committee	Title	Measured Parameters	Test Configuration
D2714/D02 on Petroleum Products and Lubricants	Test Method for Calibration and Operation of the Faxex Block-on-Ring Friction and Wear Testing Machine	Steel ring versus steel block (lubricated with standard oil) ( $\mu_k$ )	
D3108/D13 on Textiles	Test Method for Coefficient of Friction, Yarn to Solid Material	Textile yarn versus solids ( $\mu_k$ )	 $\mu = (\ln T_2 - \ln T_1) / \phi$
D3412/D13 on Textiles	Test Method for Coefficient of Friction, Yarn to Yarn	Continuous filament and spun yarns self-mated ( $\mu_s$ and $\mu_k$ )	
D3702/D02 on Petroleum Products and Lubricants	Test Method for Wear Rate and Coefficient of Friction of Materials in Self-Lubricated Rubbing Contact Using a Thrust Washer Testing Machine	Kinetic COF	
D4103/D21 on Polishes	Practice for Preparation of Substrate Surfaces for Coefficient of Friction Testing	Vinyl and wood tiles (preparation)	any

TABLE 1 Continued



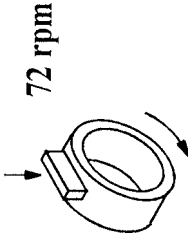
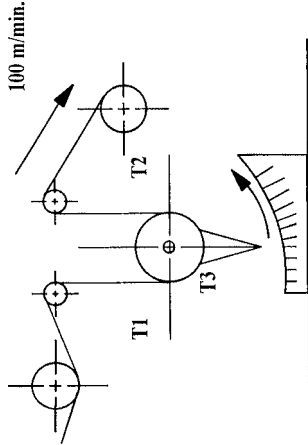
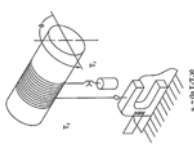
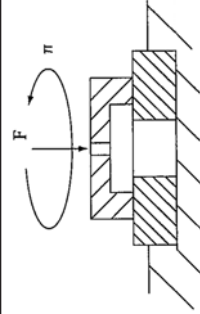

Standard/Committee	Title	Measured Parameters	Test Configuration
D4917/D06 on Paper and Paper Products	Test Method for Coefficient of Static and Kinetic Friction of Uncoated Writing and Printing Paper by Use of the Horizontal Plane Method	$\mu_s$ and $\mu_k$	
D4918/D06 on Paper and Paper Products	Test Method for Coefficient of Static Friction of Uncoated Writing and Printing Paper by Use of the Inclined Plane Method	Static COF	
D5183/D02 on Petroleum Products and Lubricants	Test Method for Determination of the Coefficient of Friction of Lubricants Using the Four-Ball Wear Test Machine	Coefficient of force for each increment of 10 kgf	
D6425/D02 on Petroleum Products and Lubricants	Test Method for Measuring Friction and Wear Properties of Extreme Pressure (EP) Lubricating Oils Using SRV Test Machine	Coefficient of friction for test (min, max, and at increments throughout the test)	
E303/E17 on Vehicle-Pavement Systems	Test Method for Measuring Surface Frictional Properties Using the British Pendulum Tester	Rubber versus pavement (BPN British Pendulum Number)	

TABLE 1 Continued

Standard/Committee	Title	Measured Parameters	Test Configuration
E670/E17 on Vehicle-Pavement Systems	Test Method for Testing Side Force Friction on Paved Surfaces Using the Mu-Meter	Tires versus pavement Mu Number (F dry – F wet)	 <p>WATER</p> <p>PULLED BY VEHICLE</p>
E1911/E17 on Vehicle-Pavement Systems	Test Method for Measuring Paved Surface Frictional Properties Using the Dynamic Friction Tester	Dynamic friction numbers (DNF) at 12, 24, 36, and 48 mph	 <p>rubber sliders</p> <p>H<sub>2</sub>O</p> <p>pavement</p>
E2100/E17 on Vehicle-Pavement Systems	Practice for Calculating the International Runway Friction Index	Friction index for snow on a runway	 <p>special trailer</p>
E2101/E17 on Vehicle-Pavement Systems	Test Method for Measuring the Friction Properties of Winter Contaminated Pavement Surfaces Using an Averaging-Type Spot Measuring Decelerometer	Friction index for pavement	 <p>braking deceleration</p>
F609/F13 on Pedestrian/Walkway Safety and Footwear	Test Method for Using a Horizontal Pull Slipmeter (HPS)	Footwear materials versus walking surfaces ( $\mu_s$ )	Same as D2047
F695/F13 on Pedestrian/Walkway Safety and Footwear	Practice for Ranking of Test Data Obtained for Measurement of Slip Resistance of Footwear Sole, Heel, and Related Materials	Footwear materials versus walking surfaces (reliable ranking of footwear for slip resistance) ( $\mu_R$ )	Same as D2047

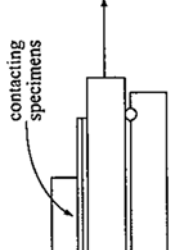
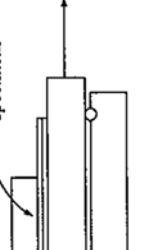
TABLE 1 Continued

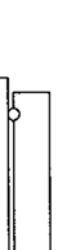

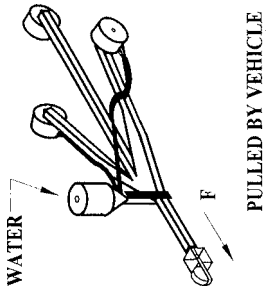
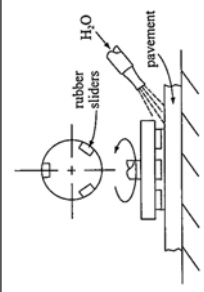
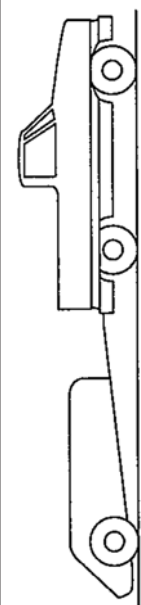
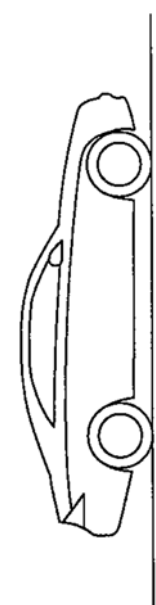

Standard/Committee	Title	Measured Parameters	Test Configuration
F732/F04 on Medical and Surgical Materials and Devices	Test Method for Wear Testing of Polymeric Materials Used in Total Joint Prostheses	Materials for human joints ( $\mu_k$ )	
G77/G02 on Wear and Erosion	Test Method for Ranking Resistance of Materials to Sliding Wear Using Block-on-Ring Wear Test	$\mu_s$ initial $\mu_k$ final $\mu_k$ final	
G99/G02 on Wear and Erosion	Test Method for Wear Testing with a Pin-on-Disk Apparatus	COF	
G133/G02 Wear and Erosion	Test Method for Linearly Reciprocating Ball-on-Flat Sliding Wear	$\mu_k$	Same as F732
G137/G02 Wear and Erosion	Test Method for Ranking Resistance of Plastic Materials to Sliding Wear Using a Block-On-Ring Configuration	$\mu_k$	

TABLE 1 Continued



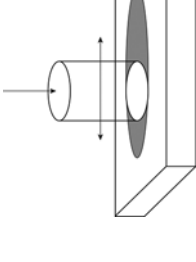

Standard/Committee	Title	Measured Parameters	Test Configuration
G143/G02 on Wear and Erosion	Test Method for Measurement of Web/Roller Friction Characteristics	$\mu_s$ $\mu_k$	
G163/G02 on Wear and Erosion	Guide for Digital Data Acquisition in Wear and Friction Measurements	Guidelines on data acquisition	Any rig
G164/G02 on Wear and Erosion	Test Method for Determination of Surface Lubrication on Flexible Webs	$\mu_s$	
G176/G02 on Wear and Erosion	Test Method for Ranking Resistance of Plastics to Sliding Wear using Block-on-Ring Wear Test—Cumulative Wear Method	$\mu_s$ initial $\mu_k$ $\mu_k$ final	
G181/G02 on Wear and Erosion	Practice for Conducting Friction Tests of Piston Ring and Cylinder Liner Materials Under Lubricated Conditions	Average coefficient of friction	

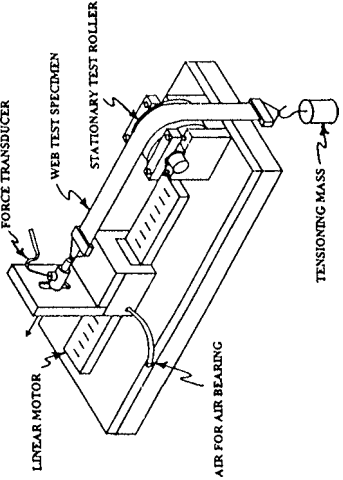

TABLE 1 Continued

Standard/Committee	Title	Measured Parameters	Test Configuration
G182/G02 on Wear and Erosion	Test Method for Determination of the Breakaway Friction Characteristics of Rolling Element Bearings	$\mu_s$	
G194/G02 on Wear and Erosion	Test Method for Measuring Rolling Friction Characteristics of a Spherical Shape on a Flat Horizontal Plane	Coefficient of rolling resistance (CORR)	

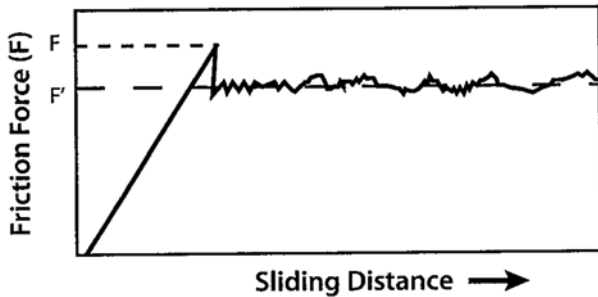

**FIG. 2 Typical Force versus Distance Recording for a System that has a Static Friction that is Higher than its Kinetic Friction**

and specimen alignment are especially important in lubricate tests. Similarly, the geometry (radius and so forth) of leading edges and application of force are very important. They should be like the application. Other important factors to simulate are normal force (contact pressure), velocity, type of motion (reciprocating versus unidirectional), and environment. For example, if an application involves flat surfaces in contact under relatively light loads and with low slip velocities, a sled device may be applicable. If an application involves materials such as friction composites, one of the brake-type dynamometer tests may be appropriate.

6.3 A very important consideration in selecting a test apparatus is stiffness of the friction force-measuring system. If the sliding member in a test couple is set into motion by a metal rod, chain, or similar device, there will be very little elastic strain in the pulling device before initiation of motion, and the force-measuring transducer may not record a “breakaway” force, a force spike that is higher than the mean force measured during steady state sliding. This breakaway force is commonly used to calculate static friction (Fig. 2). If initial friction is of interest in a test, it is advisable to use a force-measuring system with substantial elasticity. In sled-type devices, this is often accomplished by using a nylon or similar plastic filament to produce motion of the sliding member. The appropriate force-measuring system to use is the one that best simulates the tribosystem of interest pulling plastic film over a roll and probably involves significant elasticity in the system (from the low elastic modulus or the plastic). In this case, an elastic friction-measuring system would be appropriate. When pulling a steel cable over the same roll, it would be more appropriate to use a stiff testing system. (**Warning**—More “elastic” systems may be more prone to produce stick-slip behavior. In addition, elastic beams containing strain gauges may produce different friction responses than a more rigid load cell even if used on the same friction testing machine.)

6.4 Initial friction force spikes will occur in many test systems. Test surfaces that are prone to blocking or interlocking of surface features are particularly prone to showing a breakaway force spike. (Blocking is a term used to describe the tendency of some plastic materials to stick to each other after long periods of contact.) Plasticized vinyl materials often block when self mated. Plasticizer migration can be the cause.

## 7. General Precautions

7.1 The precautions listed in 7.1.1 – 7.1.10 are provided to supplement those included in any ASTM International or other friction test.

7.1.1 Avoid skin contact with the test surfaces. Fingerprints can leave a film several micrometres thick that can affect results. The method of cleaning the test surfaces and the elapsed time between surface cleaning and friction testing should be documented.

7.1.2 Test in ambient conditions (atmosphere, temperature, and humidity) that are the same as the tribosystem of interest. Samples should be in equilibrium with their environment. It is advisable to incubate test samples that can be affected by humidity (plastics and other non-metals) for 24 h in the desired ambient conditions prior to testing.

7.1.3 Use test samples with the same surface texture and directionality as the tribosystem of interest. A nondirectional lapped surface is sometimes preferred for research studies. The test report should indicate how the test surface textures were produced (for example, lapping, longitudinal grinding, and so forth) and the orientation of surface lay to the sliding direction.

7.1.4 Be meticulous in cutting test samples, and eliminate burred edges and errors of form (dents, scratches, bow, and so forth).

7.1.5 Thoroughly document the test specimens: material designation, composition, heat treatment, processing, and manufacturer.

7.1.6 If friction is measured in a wear test, be aware that the measured friction coefficient is for altered counterfaces; the surfaces are probably separated by wear debris. Friction characteristics of virgin surfaces may be significantly different from those of a system involving surfaces separated by wear debris. If worn surfaces are likely in the tribosystem of interest, then it is appropriate to measure friction coefficients in a wear test.

7.1.7 The frictional characteristics of many couples can be affected by sliding velocity and normal force. It is advisable to check systems for sensitivity to these factors. Hold normal force constant and vary velocity and vice versa.

7.1.8 Run-in may cause friction force transitions. Therefore, a steady-state value of friction force may or may not be achieved under given test conditions. The reported friction coefficient ( $\mu_k$ ) should be the steady-state value unless specific reference to transient behavior is to be reported.

7.1.9 Inspect surfaces after testing to determine if the surfaces are altered by the test (are they scratched, worn, deformed, and so forth). If the test goal is to test virgin surfaces, it may be necessary to use less severe test conditions. If unexpected damage occurs under all test conditions of interest, note this in the test results. The occurrence of surface damage may be a significant test output.

7.1.10 When using a digital acquisition system to record friction force, results can be affected by the sampling rate of the duration or the sampling period (see Guide G163).

## 8. Test Specimens and Sample Preparation

8.1 Friction measurements are extremely dependent on the condition of the contacting surfaces on the test specimens. The

surfaces should be in exactly the same condition as the tribosystem under study or as prescribed in an applicable ASTM International or test standard. If the subject tribosystem involves molded surfaces, do not test with machined surfaces.

## 8.2 Cleaning:

8.2.1 Avoid cleaning surfaces with solvents that may leave films that may not be present in the tribosystem of interest. If perfectly clean metal surfaces are to be tested for friction characteristics, cleaning with refluxed solvent vapors is very effective. Trichlorethylene is commonly used in a vapor degreaser for this purpose. There is some evidence that cleaning in chlorinated solvents can leave films that affect friction results. If this is a consideration, acetone or a similar non-chlorinated solvent can be used. Cleaning details should be included in the test report.

8.2.2 Plastics, ceramics, and other non-metals can have their surface characteristics significantly affected by solvent cleaning. Many plastics can be effectively cleaned with commercial glass detergents (except those containing wax) followed by a distilled water rinse. This same procedure will work on many ceramics. Alcohols should be avoided on ceramics since there is some evidence that they alter surface properties. Alcohols should be avoided for cleaning in general because they may not effectively remove common surface contaminants such as fingerprints and oil.

8.2.3 The cleaning method that has shown to produce uniformly clean surfaces on metals and most rigid materials is abrasive cleaning with bonded abrasive. Abrading with a fresh sheet of abrasive paper on a flat surface plate (use a grit size that will produce the desired surface roughness) will usually be sufficient to produce a surface that is free of contaminating films. Frequent changes in sample orientation can be used to generate a multidirectional scratch pattern. Debris from abrasion should be removed by a blast from an aerosol can of laboratory grade, clean, dry air. Abrasion is the only effective way of removing silicones, graphite, molybdenum disulfide, and similar materials. Any abrasion or lapping produces some risk of embedding abrasive. If it is felt that a test material is prone to embedding, surface analysis techniques (X-ray fluorescence and the like) can be used to confirm if a particular surface preparation process is producing embedding. Usually embedding is not a concern unless fine abrasives (<10  $\mu\text{m}$ ) are used. In any case, specimens shall be checked for embedding.

8.2.4 In summary, cleaning of friction test surfaces is one of the most important considerations, and the best system to use is the one that produces surface conditions that will be present in tribosystems of interest. For research studies, freshly abraded surfaces are likely to be clean and free from the contaminant films that may affect results.

## 9. Procedure

9.1 Simulate the velocity, type of motion, normal force, and environment of the tribosystem of interest. If a standard test is being used (ASTM International and so forth), use designated test conditions. Try to use fresh samples for replicate tests. If this is impractical, examine samples for wear after each test; discontinue testing if there is an upward or downward trend or if the surface texture is altered in any way (unless worn

surfaces are of interest). For example, it may be possible to do a dozen replicate tests on hard steel samples without alteration of surfaces, but plastic samples may wear (by surface deformation, scratching, and so forth) after only one test. Statistical techniques can be used to determine the number of replicates required (Practice E122) but usually 5 to 10 replicates are adequate. The variability of the test will often determine how many replicates are needed, but it is usually desirable to have a coefficient of variation less than 0.1 for a valid test.

9.2 The sliding distance used in a friction test should be adequate to ensure equilibrium friction conditions. If the friction force increases and decreases continuously through a test, this may be an indication that a longer sliding distance is needed. If friction is measured in a wear test, this should be stated in the data sheet.

## 10. Calculation of Coefficient of Friction

10.1 The equations commonly used to calculate coefficients of friction are shown in Fig. 3. The inclined plane test (Fig. 3) only yields the static coefficient of friction. It is recommended that the term static friction coefficient,  $\mu_s$ , be used to describe a coefficient calculated using a breakaway force in a friction test rig that moves a specimen with a mechanism other than gravity.

10.2 The kinetic coefficient of friction,  $\mu_k$ , may not be constant for a given time of sliding. It is common to calculate  $\mu_k$  from averaged force readings for the duration of sliding, but other techniques may be used. It is strongly recommended that friction force readings be taken from continuously recorded (analog or digital) force data. If a test is very fast and initial friction is of concern, a recording oscilloscope or high-speed data acquisition system can be used to optimize recorder response. If suitable equipment is available to record friction force and normal force at preset time intervals (instantaneous), these values can be averaged to yield a  $\mu_k$  for a test. Whatever the method used, the technique should be described in sufficient detail so that it can be reproduced by others.

### 10.3 Interpretation of Friction Force Recordings:

10.3.1 Stick-slip behavior occurs in many sliding systems, and when it does, the coefficient of friction of the system is so variable that it is common practice to simply report “stick-slip behavior” for the test result rather than a numerical result. Typical friction-force-versus-time (distance) recordings are presented in Fig. 1, Fig. 2, and Fig. 4.

10.3.2 In the examples of typical friction force tracers (Fig. 1, Fig. 2, and Fig. 4), the kinetic coefficient of friction is usually calculated from the friction force,  $F$ . The static coefficient is usually calculated from force,  $F'$ ; the behavior in the example in Fig. 1 is usually reported as stick-slip. This type of behavior may not be apparent if the moving body is translated by a rigid screw mechanism or similar device. Tribosystems that display stick-slip behavior often produce vibration or noise. Stick-slip usually occurs in tribosystems in which there is considerable elasticity. It usually does not occur if the static coefficient of friction ( $\mu_s$ ) is equal to the kinetic coefficient of

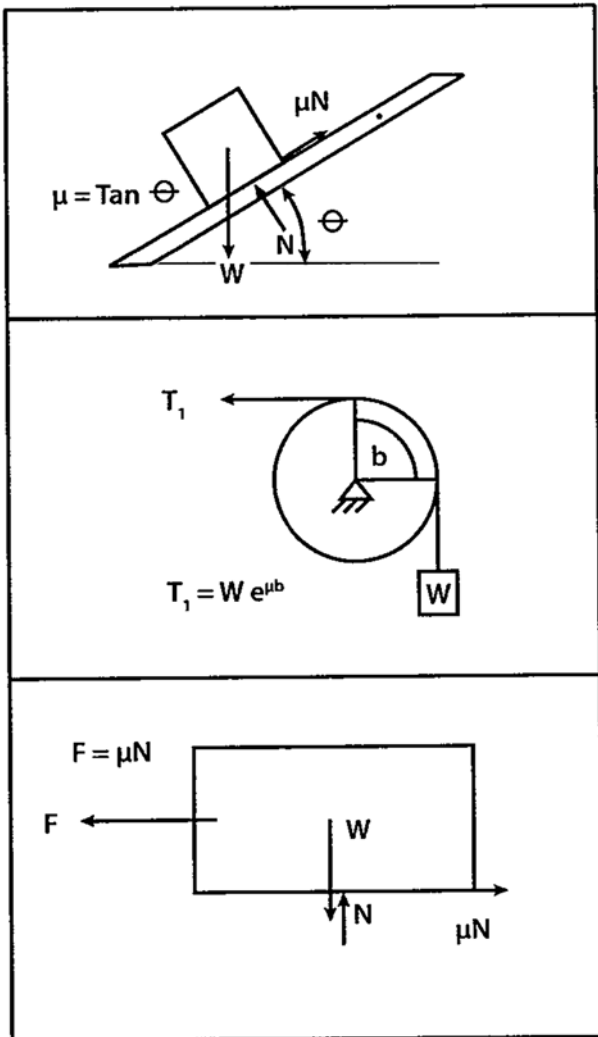

**FIG. 3 Formulas for Calculation of Friction Coefficients,  $\mu$**   
 F = Friction force, w = mass, N = Normal force  
 b = angle of wrap (radians)

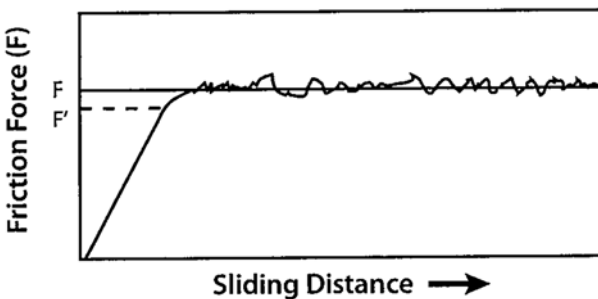
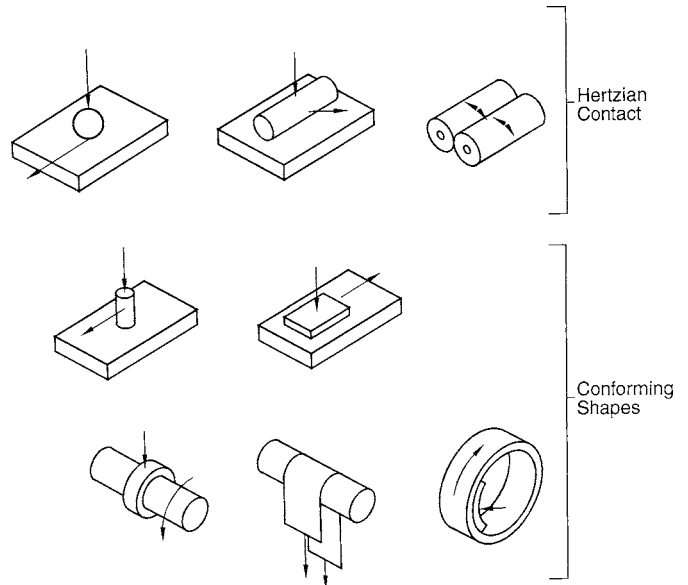

**FIG. 4 Typical Force versus Distance Recording for a System that Does Not Exhibit a High Breakaway Force**

friction ( $\mu_k$ ), and it often occurs in systems in which there is a negative slope to the coefficient of friction versus velocity curve.

**11. Report**

11.1 The minimum data for tabulation in friction database is included in items 11.1.1 to 11.1.9.



**FIG. 5 Friction Testing Specimen Configuration Options**

- 11.1.1 Material Couple (A) \_\_\_\_\_  
 (B) \_\_\_\_\_ (generic names of materials).<sup>4</sup>
- 11.1.2 Specimen Description (pin, disk, shaft, bushing, block, and so forth).
- 11.1.3 Kinetic Coefficient of Friction,  $\mu_k$  \_\_\_\_\_.
- 11.1.4 Static Coefficient of Friction,  $\mu_s$  \_\_\_\_\_.
- 11.1.5 System Configuration (see Fig. 5 for options) \_\_\_\_\_.
- 11.1.6 ASTM International or other procedure \_\_\_\_\_.
- 11.1.7 *Comments*—In addition to 11.1.1 through 11.1.6, it is always advisable to include a “comments” section in a data sheet to prompt inclusion of important tribological behavior that may not show up in making the measurements in 11.1.1 through 11.1.6. For example, some couples may show stick-slip behavior, some may squeal, some materials may deform, and so forth. Note here if sample surfaces were visibly altered during the friction test.
- 11.1.8 *Test Conditions (Starting)*—For conforming surfaces (Fig. 5), this is the normal force/apparent area of contact; Hertz stress equations can be used for nonconformal geometries.
  - 11.1.8.1 Apparent contact pressure, MPa \_\_\_\_\_.
  - 11.1.8.2 Normal force, N \_\_\_\_\_.
  - 11.1.8.3 Velocity, m/s \_\_\_\_\_.
  - 11.1.8.4 Type of motion (reciprocating, steady sliding, and so forth) \_\_\_\_\_.
  - 11.1.8.5 Total sliding distance, m \_\_\_\_\_.
  - 11.1.8.6 Sample bulk temperature, °C \_\_\_\_\_.
  - 11.1.8.7 Temperature measurement technique (location of sensor, and so forth).
  - 11.1.8.8 Test atmosphere (surrounding gases, ambient pressure, and so forth) \_\_\_\_\_.
  - 11.1.8.9 Relative humidity, % \_\_\_\_\_.
  - 11.1.8.10 Lubricant \_\_\_\_\_.

<sup>4</sup> Many plastics, ceramics, and cermets are proprietary in nature; for these materials, use trade names but reference the manufacturer.

11.1.8.11 *Generic Type (Petroleum Oil) Specifies*—Mobil 10/60, and so forth.

11.1.8.12 Friction measured as part of a wear test \_\_\_yes \_\_\_no.

11.1.9 *Test Materials*—Complete description of stationary members and moving members should include:

11.1.9.1 *Generic Name*—(1020) steel, acetal homopolymer, aluminum oxide, and so forth.

11.1.9.2 *Specification*—AISI, ASTM, UNS.

11.1.9.3 *Form*—Wrought, cast, extruded, hot pressed, and so forth.

11.1.9.4 *Treatments*—Hardened to 60 HRC, annealed, as extruded, carburized, plated with 1  $\mu\text{m}$ -thick hard chromium, and so forth.

11.1.9.5 *Surface Texture*—RA, RZ, lay, method of surface preparation, relationship of lay to sliding direction, and so forth.

11.1.10 *Cleaning*—Solvent type, how performed, elapsed time before testing, and so forth.

NOTE 1—If one or both members are coated or subject to some surface treatment, the details of this process should be noted. If a coating is the subject of a friction test, the coating(s) may be listed as a test member(s).

## 12. Precision and Bias

12.1 Since this guide encompasses the use of many types of test methods and types of apparatus, no specific data for precision and bias can be given. Some general comments on values that might be expected and on factors that can affect precision are given in the following paragraphs.

*ASTM International takes no position respecting the validity of any patent rights asserted in connection with any item mentioned in this standard. Users of this standard are expressly advised that determination of the validity of any such patent rights, and the risk of infringement of such rights, are entirely their own responsibility.*

*This standard is subject to revision at any time by the responsible technical committee and must be reviewed every five years and if not revised, either reapproved or withdrawn. Your comments are invited either for revision of this standard or for additional standards and should be addressed to ASTM International Headquarters. Your comments will receive careful consideration at a meeting of the responsible technical committee, which you may attend. If you feel that your comments have not received a fair hearing you should make your views known to the ASTM Committee on Standards, at the address shown below.*

*This standard is copyrighted by ASTM International, 100 Barr Harbor Drive, PO Box C700, West Conshohocken, PA 19428-2959, United States. Individual reprints (single or multiple copies) of this standard may be obtained by contacting ASTM at the above address or at 610-832-9585 (phone), 610-832-9555 (fax), or service@astm.org (e-mail); or through the ASTM website (www.astm.org). Permission rights to photocopy the standard may also be secured from the ASTM website (www.astm.org/COPYRIGHT/).*

12.2 The repeatability of tests on the same material will depend upon material homogeneity, machine and material interaction, and careful adherence to the specified procedure by the machine operator.

12.3 Industrial experience has shown that carefully conducted unlubricated inclined plane and sled friction tests have produced within-laboratory coefficient of variation of 10 % or less for friction coefficients on an identical tribosystem. Coefficients of variation may be 25 % or higher when friction measurements are derived from wear tests. Precision is worst on systems in which test conditions produce surface damage. It is the responsibility of the user to determine acceptable coefficients of variation, but the above sentences reflect observations made in unlubricated metal-to-metal and metal-to-plastic friction tests.

12.4 Sample wear during friction tests can result in unacceptable test variability. Care should be taken to prevent surface alteration during friction testing caused by wear unless wear is part of the tribosystem of interest.

12.5 Friction coefficients of material couples obtained on one type of test apparatus may be significantly different from coefficients of the same material couples tested on a different apparatus. A friction coefficient is a system effect, so appropriate caution shall be used when comparing or using data from different sources and systems.

## 13. Keywords

13.1 coefficient of friction; data analysis; friction coefficients; friction/frictional properties; kinetic coefficient of friction; static coefficient of friction; triboelements