



Standard Test Method for Evaluating Edge Cleaning Effectiveness of Vacuum Cleaners¹

This standard is issued under the fixed designation F2797; the number immediately following the designation indicates the year of original adoption or, in the case of revision, the year of last revision. A number in parentheses indicates the year of last reapproval. A superscript epsilon (ϵ) indicates an editorial change since the last revision or reapproval.

1. Scope

1.1 This test procedure provides a quantitative laboratory method for determining the edge cleaning effectiveness of a vacuum cleaner along walls and baseboards.

1.2 This test method is applicable to household and commercial types of upright, canister, combination, stick and hand held vacuum cleaners.

1.3 The values stated in SI units are to be regarded as standard. The values given in parentheses are for information only.

1.4 *This standard does not purport to address all of the safety concerns, if any, associated with its use. It is the responsibility of the user of this standard to establish appropriate safety and health practices and determine the applicability of regulatory limitations prior to use.*

2. Referenced Documents

2.1 ASTM Standards:²

D75 Practice for Sampling Aggregates

E177 Practice for Use of the Terms Precision and Bias in ASTM Test Methods

E691 Practice for Conducting an Interlaboratory Study to Determine the Precision of a Test Method

F608 Test Method for Evaluation of Carpet Embedded Dirt Removal Effectiveness of Household/Commercial Vacuum Cleaners

2.2 Other Standards:

IEC 60312 Vacuum cleaners for household use – Methods of measuring the performance, 4th Edition³

3. Terminology

3.1 Definitions:

¹ This test method is under the jurisdiction of ASTM Committee F11 on Vacuum Cleaners and is the direct responsibility of Subcommittee F11.21 on Cleanability. Current edition approved Feb. 1, 2010. Published July 2010. DOI: 10.1520/F2797-10.

² For referenced ASTM standards, visit the ASTM website, www.astm.org, or contact ASTM Customer Service at service@astm.org. For *Annual Book of ASTM Standards* volume information, refer to the standard's Document Summary page on the ASTM website.

³ Available from International Electrotechnical Commission (IEC), 3 rue de Varembé, Case postale 131, CH-1211, Geneva 20, Switzerland, <http://www.iec.ch>.

3.1.1 *cleaning ability, dry, n*—the potential of a vacuum cleaner to remove dirt from a surface (sometimes referred to in the industry as cleanability, dry).

3.1.2 *model, n*—the designation of a group of vacuum cleaners having identical mechanical and electrical construction with only cosmetic or nonfunctional differences.

3.1.3 *population, n*—the total of all units of a particular model vacuum cleaner being tested.

3.1.4 *sample, n*—a group of vacuum cleaners taken from a large collection of vacuum cleaners of one particular model which serves to provide information that may be used as a basis for making a decision concerning the larger collection.

3.1.5 *test run, n*—the definitive procedure that produces a singular measured result.

3.1.6 *unit, n*—a single vacuum cleaner of the model being tested.

4. Significance and Use

4.1 This test method provides an indication of how close to a wall or baseboard a vacuum cleaner removes dirt/dust. The amount of dirt removed in the laboratory test may not be the same as in a home; however, it will show that, in most cases, a vacuum cleaner that performs well in the laboratory will perform well in a home. Laboratory results may differ due to variations in the homes: carpets, dirt, and other factors.

NOTE 1—The primary goal of this test method is not to evaluate the degree or the amount of dirt or dust debris that a given product removes, but rather how close to a wall or baseboard a vacuum has performed some measure of cleaning.

4.2 In order to provide a uniform basis for measuring the performance described in 1.1, a standardized test carpet and test dust are employed in this procedure.

5. Apparatus

5.1 *Weighing Scale for Weighing Test Dirt*, accurate to 0.10 g (0.0035 oz) and having a weighing capacity of at least 500 g (1.1 lb).

5.2 *Stopwatch*, with a second hand or other type of equipment capable of establishing the specified rate of movement and total cycle time.

5.3 *Voltmeter*, to measure input volts to the vacuum cleaner, to provide measurements accurate to within $\pm 1\%$.

5.4 *Voltage-Regulator System*, to control the input voltage to the vacuum cleaner. The regulator shall be capable of maintaining the vacuum cleaner's rated voltage $\pm 1\%$ and rated frequency ± 1 Hz, having a wave form that is essentially sinusoidal with 3% maximum harmonic distortion for the duration of the test.

5.5 *Dirt Dispenser*—Dispensing system that provides the operator with a method to distribute the test dirt uniformly on the carpet test area.

5.6 *Rotating Agitator Conditioning Vacuum Cleaner/Equipment*, for conditioning new test carpets and removing residual dirt from the test carpet before each test run. This cannot be the unit being tested.

5.7 *Temperature and Humidity Indicators*, to provide temperature measurements accurate to within $\pm \frac{1}{2}^{\circ}\text{C}$ ($\pm 1^{\circ}\text{F}$) and humidity measurements accurate to within 2% relative humidity.

5.8 *Supporting Surface*—A flat surface consisting of a piece of 19-mm ($\frac{3}{4}$ -in.) thick exteriorgrade plywood with the "A" surface upward to support the test carpet. The test carpet may be fastened to the supporting surface, but only the four corners, by any acceptable means.

5.9 *T-bar Guide*—A "T-bar" constructed of wood (or other suitable material) per Fig. 1. Construction shall be to ensure T-bar does not move during testing.

5.10 *Measurement Scale*—A measurement scale with an accuracy and resolution of 0.04 in. (1 mm).

6. Materials

6.1 *Debris Dust*—Wedron 504 sand or equivalent in accordance with Test Method F608, Annex A1.

6.2 *Test Carpet*—Wilton Wool in accordance with IEC 60312, paragraph 5.1.1.2.

7. Sampling, Test Specimens, and Test Units

7.1 A minimum of three units of the same model vacuum cleaner selected at random in accordance with good statistical practice shall constitute the population sample.

7.1.1 To determine the best estimate of edge cleaning effectiveness for the population of the vacuum cleaner model being tested, the arithmetic mean of the edge cleaning effectiveness rating of the sample from the population shall be established by testing it to a 90% confidence level within $\pm 5\%$ of the mean value.

7.1.2 Annex A1 provides a procedural example for determining the 90% confidence level and when the sample size shall be increased.

8. Conditioning

8.1 *Test Room*—Maintain the test room in which all conditioning and vacuum cleaner test is performed at $21 \pm 3^{\circ}\text{C}$ ($70 \pm 5^{\circ}\text{F}$) and 45 to 55% relative humidity.

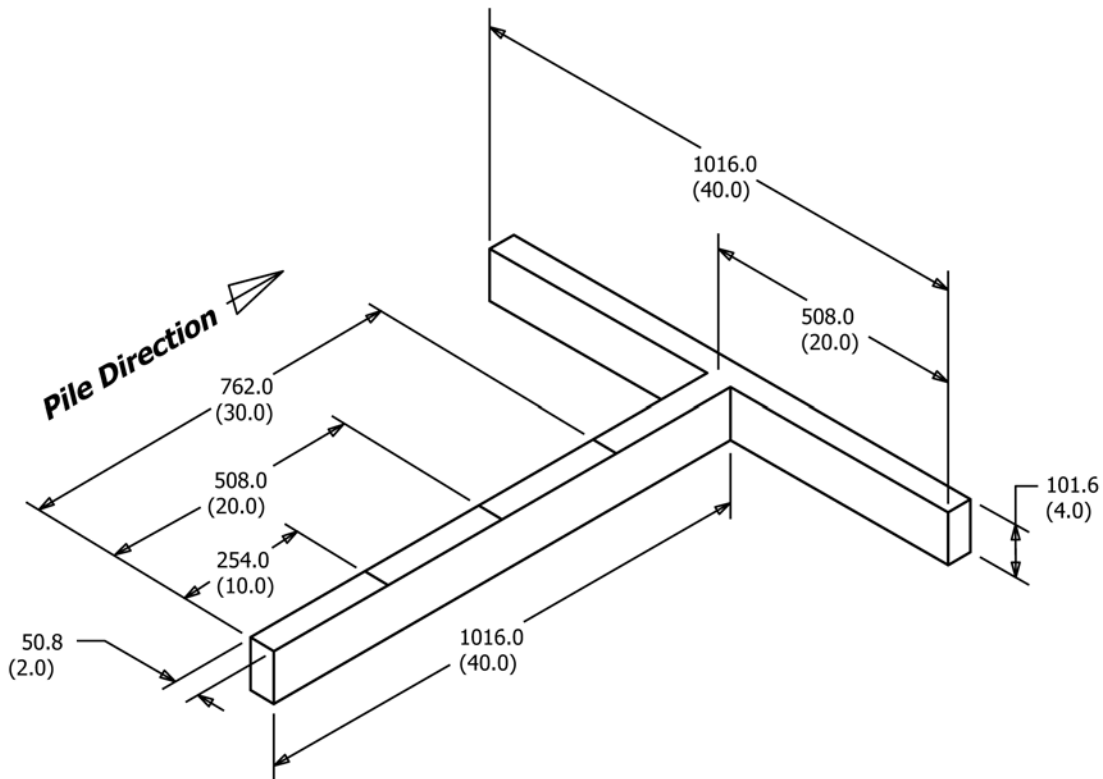

FIG. 1 T-Bar Guide Rail in Units of Millimetres (Inches)

8.2 All components involved in the test shall remain and be exposed in the controlled environment for at least 16 h prior to the start of the test.

9. Test Carpets

9.1 New test carpets shall conform to IEC 60312, paragraph 5.1.1.2.

9.1.1 Cut a sample of each test carpet to a size of 1220 by 1830 mm (48 by 72 in.) minimum. If the warp direction or “lay” of the carpet can be determined, it shall be in the 1830 mm (72 in.) direction. (It is recommended that the carpets be bound on all sides to prevent fraying during handling.)

9.2 *Precondition New Test Carpet Samples*—Precondition the entire area of the carpet by cleaning with the rotating agitator conditioning vacuum cleaner for 5 min. If more than 2 g of fiber is removed after 5 min of vacuuming, repeat vacuuming in 2-min sessions until less than 1 g of fiber is removed.

9.3 *Reconditioning Used Test Carpet Samples*—To remove the residual dirt, clean the carpet with a rotating agitator conditioning vacuum cleaner until no dirt is visible on the carpet surface.

10. Test Vacuum Cleaners

10.1 *New Test Vacuum Cleaners:*

10.1.1 *Preconditioning a New Test Vacuum Cleaner*—Run the vacuum cleaner in at rated voltage $\pm 1\%$ and rated frequency ± 1 Hz with filters in place.

10.1.1.1 *Preconditioning Rotating Agitator Type Vacuum Cleaner*—In a stationary position, operate the vacuum cleaner for 1 h with the bristles not engaged on any surface.

10.1.1.2 *Preconditioning a Straight-Air Canister Vacuum Cleaner*—Operate the vacuum cleaner for 1 h with a wide-open inlet (without hose).

10.2 *Used Test Vacuum Cleaners:*

10.2.1 Recondition a used test vacuum cleaner; prior to each test run as follows:

10.2.1.1 Thoroughly remove excess dirt from the vacuum cleaner. Without using tools for disassembly, clean the entire outer surface, brushes, nozzle chamber, ductwork, inside of chamber surrounding the primary filter, and inside hose and wands.

10.2.1.2 For vacuum cleaners using disposable filters as the primary filters, use a new disposable primary filter from the manufacturer for each test. Follow the manufacturer’s instructions for the filter installation.

10.2.1.3 For vacuum cleaners using water as the primary filter, empty the receptacle and refill as recommended by the manufacturer.

10.2.1.4 For vacuum cleaners using non-disposable dirt receptacles, empty in accordance with the manufacturer’s instructions after each test run and clean the receptacle. Primary filter shall be thoroughly cleaned per manufacturer’s instructions.

10.3 *Test Vacuum Cleaner Settings*—If various settings are provided, set the motor speed setting, suction regulator, nozzle height, or combination thereof using the manufacturer’s speci-

fications as provided in the instruction manual for the carpet type. Contact the manufacturer if no instructions are given, or if the instructions are unclear or inadequate.

11. Procedure

11.1 Clean and prepare the carpet test panel in accordance with 9.2 for new carpets or 9.3 for used carpets.

11.2 Prepare test cleaners and dirt receptacles in accordance with Section 10.

11.3 Ensure the vacuum cleaner settings have been set in accordance with 10.3.

11.4 *Test Dirt Preparation*—Weigh 200 ± 0.1 g (7 ± 0.005 oz) of test dust.

11.5 Using the dirt dispenser and any convenient spreading method, distribute test dust uniformly down the center area of the carpet test surface approximately 254 mm wide by 1016 mm long (10 by 40 in.). Ensure good visible coverage.

11.6 Place the T-bar over the middle of the dust covered area of the carpet test surface. The middle leg of the T-bar shall be placed parallel to the carpet lay such that the first cleaning stroke will be conducted in the direction of the carpet pile lay.

11.6.1 Test dust must be spread out a minimum of 76 mm (3 in.) from each side/edge of the T-bar.

11.7 Energize the cleaner for 2 min at nameplate rated voltage ($\pm 1\%$) and frequency (± 1 Hz) immediately preceding the test sequence of 11.8. For vacuum cleaners with dual nameplate voltage ratings, conduct testing at the highest voltage.

11.7.1 For a rotating agitator-type vacuum cleaner, place it such that the bristles clear the supporting surface and no loose dirt is picked up.

11.7.2 For a straight-air canister vacuum cleaner, operate with the rug tool unrestricted, positioned such that no loose dirt is picked up from the supporting surface.

11.8 Immediately following the 2-min “run-in” of 11.7, de-energize the vacuum cleaner and place the vacuum cleaner nozzle on the test carpet directly in front of the target cleaning area.

11.8.1 Reasonable efforts shall be made to maintain the handle height at 800 mm (31.5 in.) during each test run for vacuum cleaners with a pivoting handle.

11.8.2 Reasonable efforts shall be made to maintain the vacuum cleaner’s nozzle parallel to the test carpet surface during each test run for vacuum cleaners with non-pivoting handles.

11.9 Tilt or lift the nozzle off the carpet, energize the vacuum cleaner and adjust the voltage to rated voltage $\pm 1\%$. Allow the vacuum cleaner to run and expand the filter bag, if one is present.

11.10 Lower the nozzle onto the carpet before the test area. Again, adjust the voltage to rated voltage $\pm 1\%$; then perform one forward stroke and one backward stroke at a rate of 0.254 m/s (10.0 in./s) without lifting the nozzle from the carpet along one side of the leg of the T-bar.

11.11 At the end of the return stroke, de-energize the vacuum cleaner.

11.12 Reposition cleaner on opposite side of T-bar to test alternate side of the test vacuum cleaner nozzle. Repeat steps 11.9 – 11.11.

11.13 Using an accurate scale measure the width of the visible uncleaned area (edge of cleaning) to the nearest millimetre (0.040 in.), at increments of 25, 50, and 75 cm (10, 20, and 30 in.) down the middle leg of the T-bar. Record the three measurements along the T-bar and calculate the arithmetic average of the three measurements for a given side.

NOTE 2—The primary goal of this test method is not to evaluate the degree or the amount of sand debris that a given product removes, but rather how close to the T-Bar a vacuum has performed some measure of cleaning. It is therefore not necessary that a vacuum remove all of the visible debris in determining the line or edge of cleaning. Credit should be given to a vacuum for evidence of some debris removal in determining this line or edge of cleaning. The photographs in Annex A2 have been provided to assist in determining this edge of cleaning for a variety of results.

11.14 Repeat 11.13 for opposite side of T-bar. This constitutes one test run.

11.15 Repeat Section 11 two additional times with the same test cleaner.

12. Calculation or Interpretation of Results

12.1 The edge cleaning effectiveness for each individual test vacuum cleaner from the population sample is the arithmetic mean of the three test run averages meeting the repeatability statement in Section 14 for each side of the vacuum cleaner nozzle (left and right). See Annex A1 for a procedural example and whether further test runs need to be conducted.

12.2 A minimum of two additional test sample units of the same model shall be selected in accordance with the sampling statement of Section 7. Repeat the test procedure in Section 11 for each new test sample unit selected.

12.3 The edge cleaning effectiveness for the population of the vacuum cleaner model being tested is the arithmetic mean of the edge cleaning measurements of the samples from the population meeting the requirements of Section 7.

13. Report

13.1 For each vacuum cleaner sample from the population being tested, report the following information:

13.1.1 Manufacturer's name, product model name and number.

13.1.2 Type of cleaner; for example, upright, canister, etc.

13.1.3 The arithmetic mean edge cleaning effectiveness for the left and right sides of the nozzle.

14. Precision and Bias

14.1 *Precision*—An interlaboratory test is currently in progress but is not complete. No official precision statements regarding the repeatability and reproducibility of this test method are available at this time. An estimate of the repeatability of this procedure within a single lab is provided below in 14.1.1 and is based on interlab testing of four (4) laboratories to date (July 27, 2009).

14.1.1 *Repeatability Limit*—The 95 % repeatability limit $r = 6.35$ mm (0.25 in.). This means that we can state with 95 % confidence that, within a single laboratory, a set of measured results derived from testing a unit should be considered suspect if the difference between any two of the three values is greater than 6.35 mm (0.25 in.).

14.2 *Bias*—No justifiable statement can be made on the accuracy of this test method, since the true value of the property cannot be established by an acceptable referee method.

15. Keywords

15.1 carpet; cleaning; edge; vacuum cleaner

ANNEXES

(Mandatory Information)

A1. MATHEMATICAL METHOD FOR DETERMINING WITH 90 % CONFIDENCE THE EDGE CLEANING EFFECTIVENESS OF A POPULATION OF VACUUM CLEANERS

A1.1 Theory

A1.1.1 The most common and ordinarily the best estimate of the population mean, μ , is simply the arithmetic mean, \bar{X} , of the individual scores (measurements) of the units comprising a sample taken from the population. The average score of these units will seldom be exactly the same as the population mean; however, it is expected to be fairly close so that in using the following procedure it can be stated with 90 % confidence that the true mean of the population, μ , lies within a determined

interval of the calculated mean, \bar{X} , of the sample taken from the population as stated in Section 7.

A1.1.2 The following procedure provides a confidence interval about the sample mean which is expected to bracket μ , the true population mean, $100(1 - \alpha)$ % of the time where α is the chance of being wrong. Therefore, $1 - \alpha$ is the probability or level of confidence of being correct.

A1.1.3 The desired level of confidence is $1 - \alpha = 0.90$ or 90 % as stated in Section 7. Therefore, $\alpha = 0.10$ or 10 %.

A1.1.4 Compute the mean, \bar{X} , and the standard deviation, s , of the individual scores of the sample taken from the population:

$$\bar{X} = \frac{1}{n} \sum_{i=1}^n X_i \tag{A1.1}$$

$$s = \sqrt{\frac{n \sum_{i=1}^n X_i^2 - \left(\sum_{i=1}^n X_i\right)^2}{n(n-1)}} \tag{A1.2}$$

where:

- n = number of units tested, and
 - X_i = value of the individual test unit score of the i th test unit.
- As will be seen in the procedural example to follow, this is the average value of the results from three test runs performed on an individual test unit with the resulting set of data meeting the repeatability requirements of Section 14.

A1.1.5 Determine the value of the t statistic for $n - 1$ df, from Table A1.1 at a 95 % confidence level.

NOTE A1.1—The value of t is defined as t and is read as “ t at 95 % confidence.”

$$t \text{ statistic} = t_{1-\alpha/2} = t_{0.95} \tag{A1.3}$$

where:

$$1 - \alpha/2 = 1 - 0.10/2 = 1 - 0.05 = 0.95 \text{ or } 95 \%$$

A1.1.6 The following equations establish the upper and lower limits of an interval centered about \bar{X} that will provide the level of confidence required to assert that the true population mean lies within this interval.

$$CI_U = \bar{X} + ts/\sqrt{n} \tag{A1.4}$$

$$CI_L = \bar{X} - ts/\sqrt{n} \tag{A1.5}$$

TABLE A1.1 Percentiles of the t Distribution^A

df	$t_{0.95}$	$t_{0.975}$
1	6.314	12.706
2	2.920	4.303
3	2.353	3.182
4	2.132	2.776
5	2.015	2.571
6	1.943	2.447
7	1.895	2.365
8	1.860	2.306
9	1.833	2.262
10	1.812	2.228
11	1.796	2.201
12	1.782	2.179
13	1.771	2.160
14	1.761	2.145
15	1.753	2.131

^A Adapted by permission from *Introduction to Statistical Analysis*, 2nd ed., W. J. Dixon and F. J. Massey, Jr., Eds., McGraw-Hill Book Co., Inc., 1957. Entries originally from Table III of *Statistical Tables* by R. A. Fisher and F. Yates, Oliver and Boyd, Ltd., London, 1938.

where:

- CI = confidence interval (U-upper limit; L-lower limit),
- \bar{X} = mean score of the sample taken from population,
- t = t statistic from Table A1.1 at 95 % confidence level,
- s = standard deviation of the sample taken from the population, and
- n = number of units tested.

A1.1.7 It is desired to assert with 90 % confidence that the true population mean, μ , lies within the interval, CI_U to CI_L centered about the sample mean, \bar{X} . Therefore, the quantity $ts\sqrt{n}$ shall be less than some value, A .

NOTE A1.2—Generally, the value of A is stated as a percentage of the estimated population mean.

A1.1.8 As $n \rightarrow \infty, ts\sqrt{n} \rightarrow 0$. As this relationship indicates, a numerically smaller confidence interval may be obtained by using a larger number of test units, n , for the sample. Therefore, when the standard deviation, s , of the sample is large and the level of confidence is not reached after testing three units, a larger sample size, n , shall be used.

A1.2 Procedure —Graphical flowchart for the procedure shown in Fig. A1.1.

A1.2.1 Select three units from the population for testing as the minimum sample size.

A1.2.2 Obtain individual test unit scores by averaging the results of three test runs performed on each of the three individual test units. The data set resulting from the three test runs performed on each individual test unit shall meet the respective repeatability requirement found in Section 14.

A1.2.3 Compute \bar{X} and s of the sample.

A1.2.4 Determine the statistic t for $n - 1$ df from Table A1.1 where n = number of test units.

A1.2.5 Compute $ts\sqrt{n}$ for the sample and compare it to the value of A .

A1.2.6 If the value of $ts\sqrt{n} > A$, an additional unit from the population shall be selected and tested, and the computations of A1.2.2 – A1.2.6 are repeated.

A1.2.7 If the value of $ts\sqrt{n} < A$, the desired 90 % confidence level has been obtained. The value of the final \bar{X} may be used as the best estimate of the particulate level for a specific particle size for the population.

A1.3 Example —The following data is chosen to illustrate how the mean value of the left cleaning edge, for the population of a vacuum cleaner model is derived.

A1.3.1 Select three test units from the vacuum cleaner model population. A minimum of three test runs shall be performed using each test unit.

A1.3.2 Test run scores of Test Unit No. 1 (note that each score below is the average of the 3 left cleaning edge

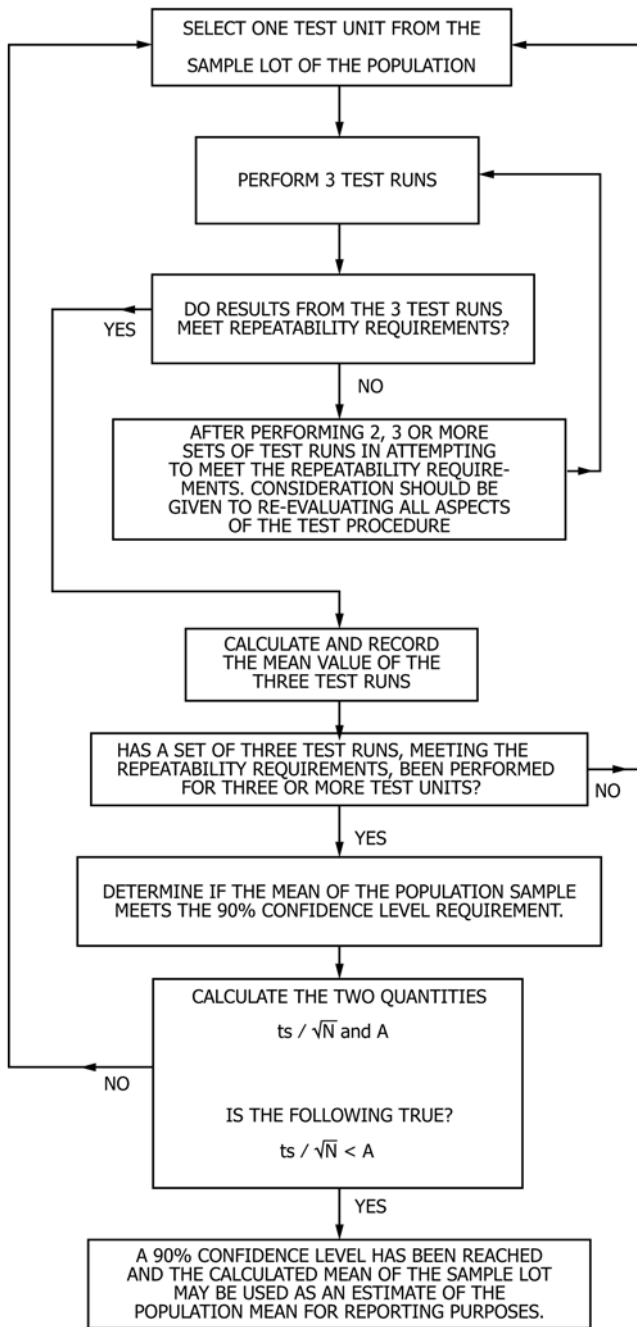

FIG. A1.1 Flow Chart for Procedure in A1.2

measurements of a single test trial):

- Test Run No. 1 = 7 mm (0.276 in.)
- Test Run No. 2 = 8 mm (0.315 in.)
- Test Run No. 3 = 16 mm (0.630 in.)

A1.3.3 Maximum spread = 16 – 7 = 9 mm (0.354 in.). The repeatability value listed in Section 14 has been exceeded by the data spread so the results are to be discarded and three additional test runs performed.

A1.3.4 Test run average scores for Test Unit No. 1 (note that each score below is the average of the 3 left edge measurements of a single test trial):

- Test Run No. 4 = 7 mm (0.276 in.)
- Test Run No. 5 = 9 mm (0.354 in.)
- Test Run No. 6 = 10 mm (0.394 in.)

A1.3.5 Maximum spread = 10 – 7 = 3 mm (0.118 in.). This value of the spread is less than the repeatability value of Section 14.

A1.3.6 Unit No. 1 score = (7 + 9 + 10)/3 = 8.7 mm (0.343 in.).

NOTE A1.3—If it is necessary to continue repeated test run sets (7,8,9 - 10,11,12, and so forth) because the spread of data within a data set is not less than the repeatability limit requirement stated in Section 14, there may be a problem with the test equipment, the execution of the test procedure, or any of the other factors involved in the test procedure. Consideration should be given to reevaluating all aspects of the test procedure for the cause(s).

A1.3.7 A minimum of two additional test units must be tested, each meeting the repeatability limit requirement. For this procedural example, assume those units met the repeatability requirements and the individual unit scores are:

- Score of Test Unit No. 1 = 8.7 mm (0.343 in.)
- Score of Test Unit No. 2 = 8.4 mm (0.330 in.)
- Score of Test Unit No. 3 = 8.8 mm (0.345 in.)

A1.3.8

$$\bar{X} = (8.7 + 8.4 + 8.8) / 3 = 8.63 \text{ mm (0.340 in.)}$$

A1.3.9

$$s = \sqrt{\frac{3[(8.7)^2 + (8.4)^2 + (8.8)^2] - [8.7 + 8.4 + 8.8]^2}{3(3 - 1)}}$$

and

$$s = 0.21 \text{ mm (0.008 in.)}$$

A1.3.10

$$A = 0.05(8.63) = 0.432 \text{ mm (0.017 in.)}$$

A1.3.11 Degrees of freedom, $n - 1 = 3 - 1 = 2$ and $t_{0.95}$ statistic = 2.920

A1.3.12

$$\frac{ts}{\sqrt{n}} = \frac{2.920(0.21)}{\sqrt{3}} = 0.354 \text{ mm (0.014 in.)}$$

A1.3.13 0.354 mm < 0.432 mm (0.014 in. < 0.017 in.)

A1.3.13.1 The requirement has been met because ts/\sqrt{n} is smaller than A.

A1.3.14 Thus, the value of \bar{X} , 8.63 mm (0.340 in.) represents the left edge cleaning score for the vacuum cleaner model tested and may be used as the best estimate of the for the population mean. The right edge cleaning score is to be evaluated in the same manner.

A2. PHOTOGRAPHIC GUIDES FOR DETERMINING THE LINE/EDGE OF CLEANING

A2.1 See Figs. A2.1-A2.5

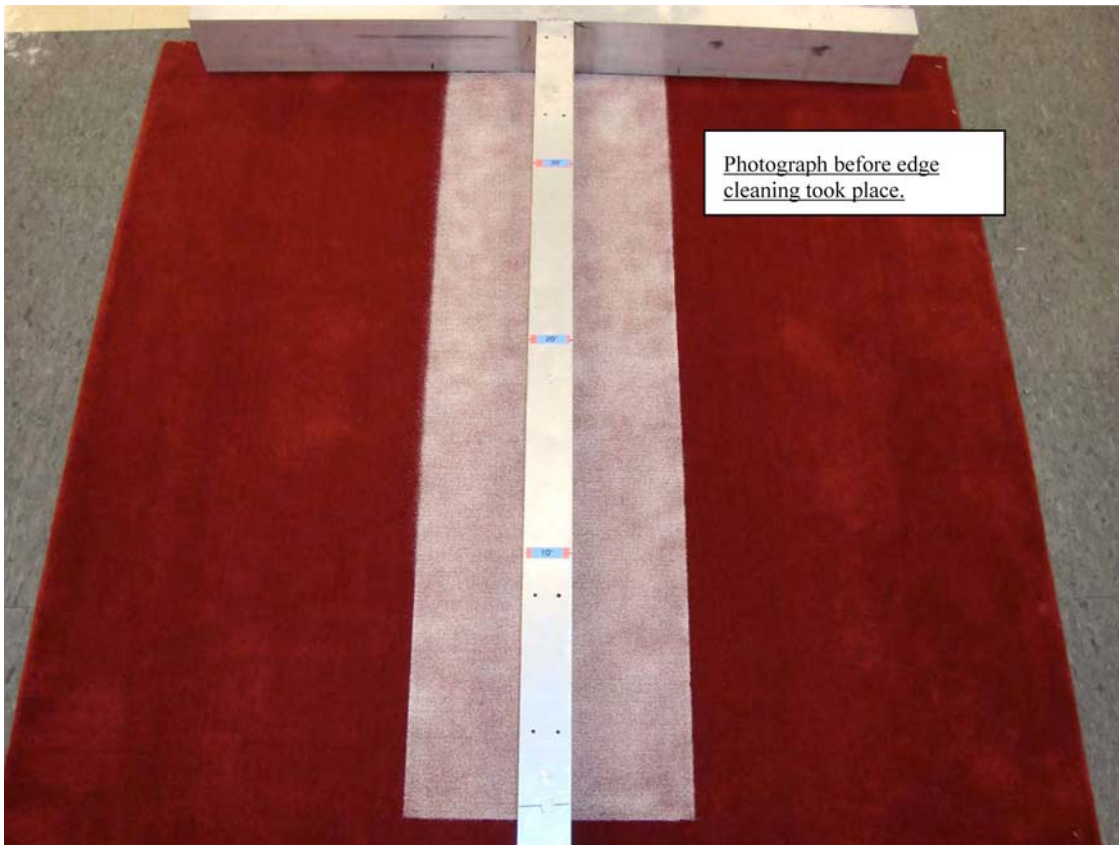

FIG. A2.1 Before Edge Cleaning

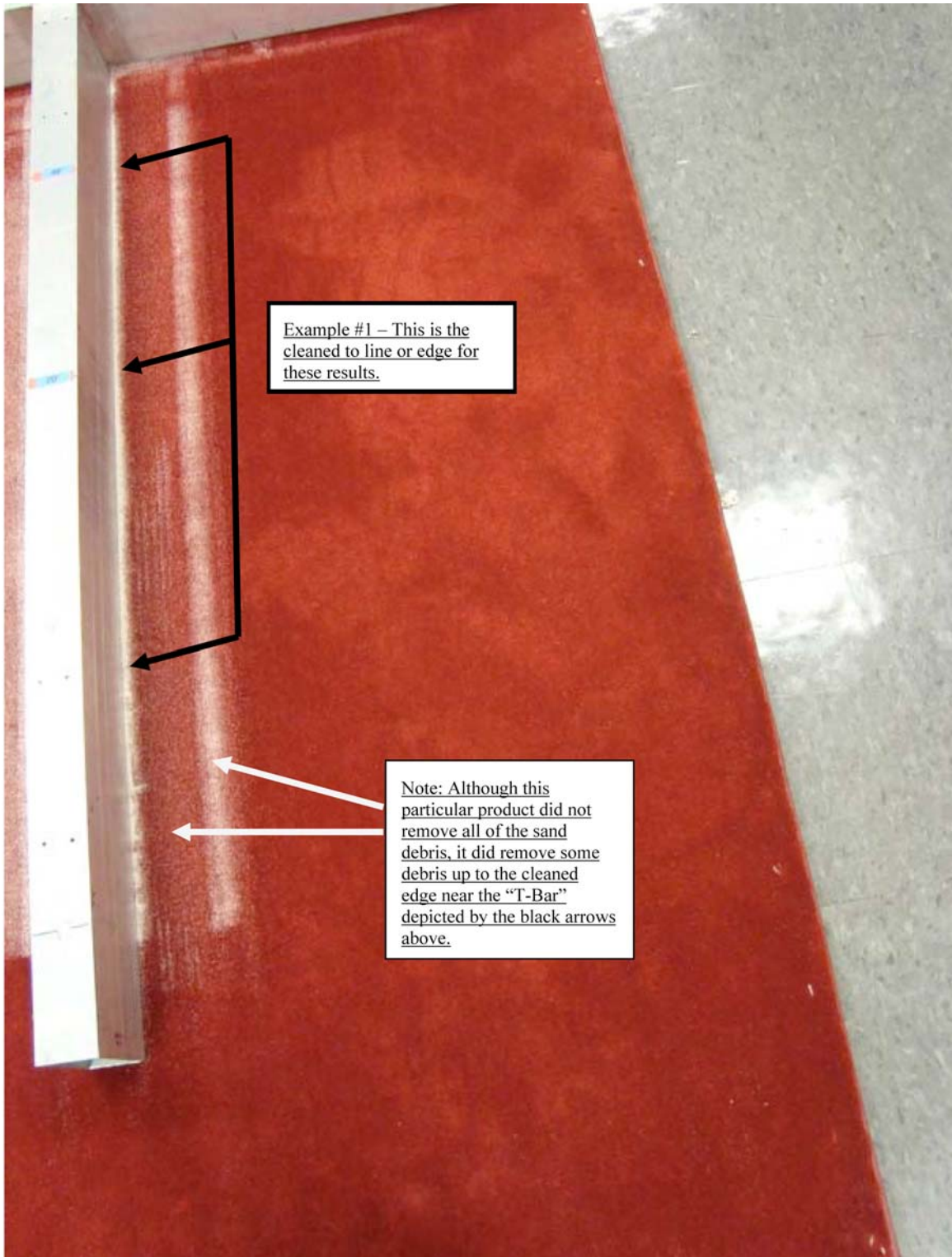

FIG. A2.2 Example #1

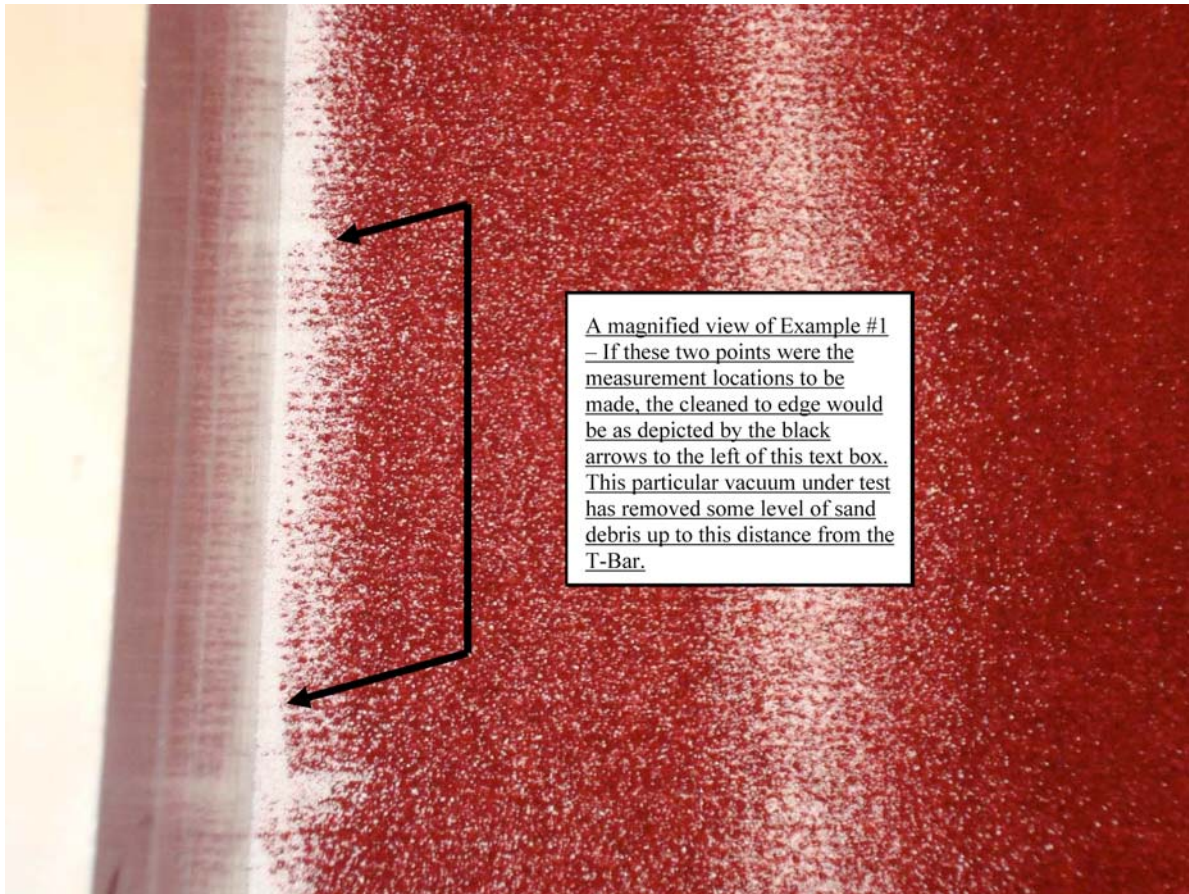

FIG. A2.3 Magnified View of Example #1

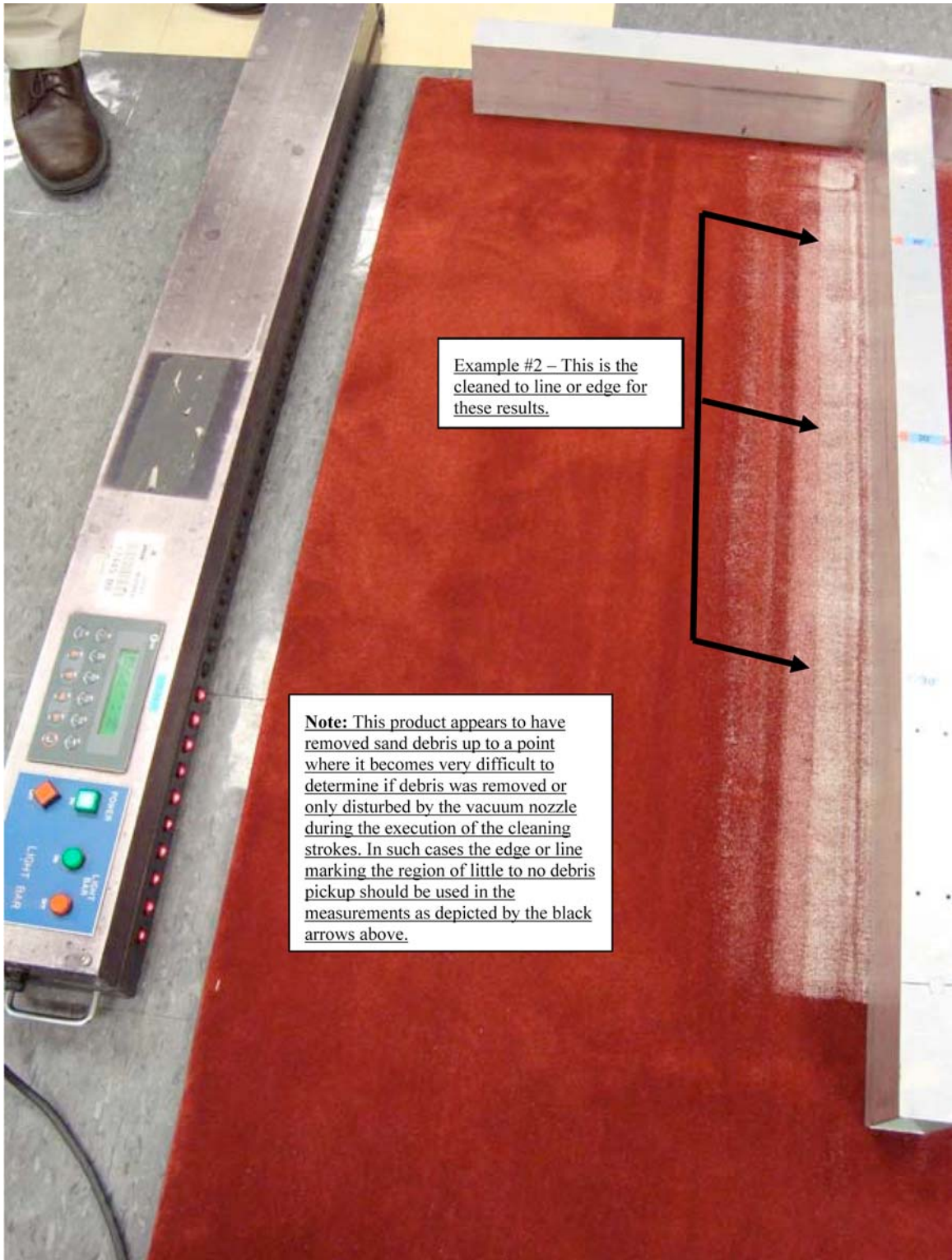

FIG. A2.4 Example #2

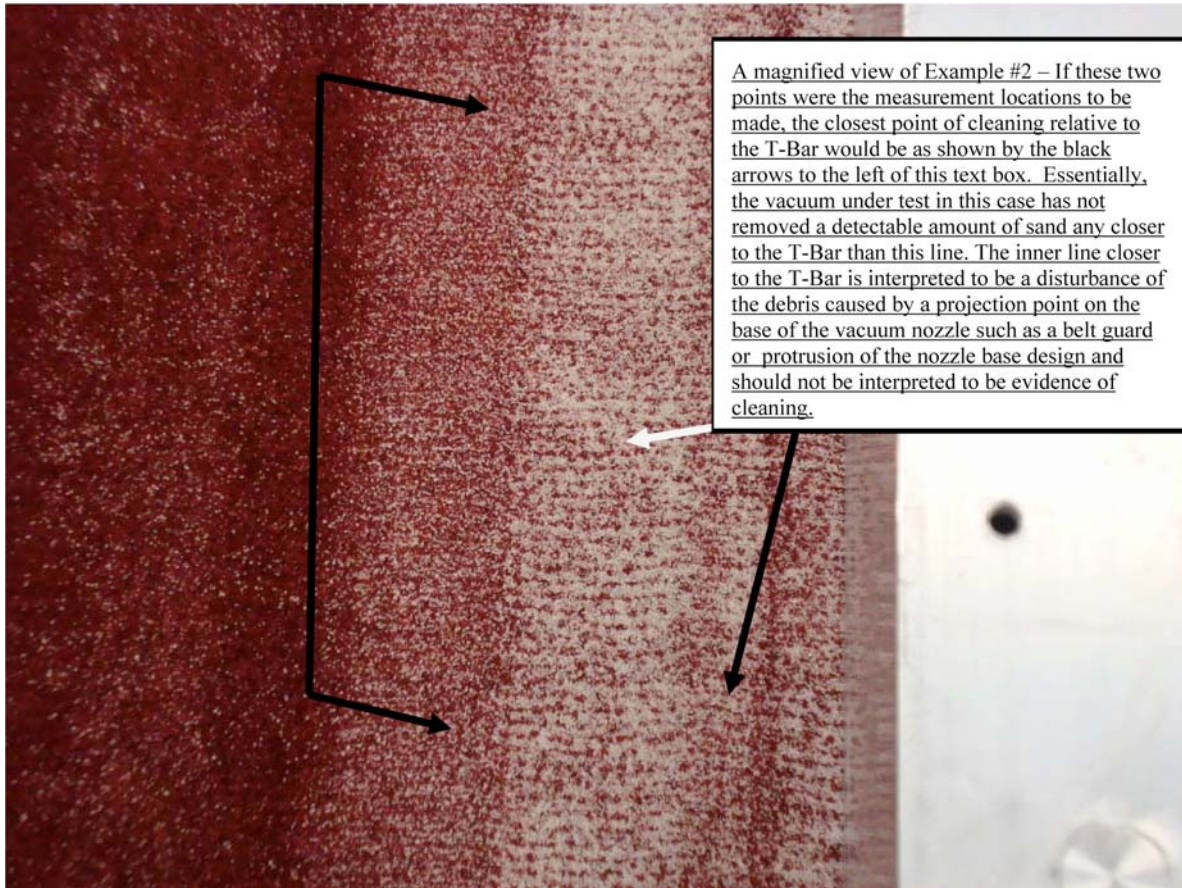

FIG. A2.5 Magnified View of Example #2

ASTM International takes no position respecting the validity of any patent rights asserted in connection with any item mentioned in this standard. Users of this standard are expressly advised that determination of the validity of any such patent rights, and the risk of infringement of such rights, are entirely their own responsibility.

This standard is subject to revision at any time by the responsible technical committee and must be reviewed every five years and if not revised, either reapproved or withdrawn. Your comments are invited either for revision of this standard or for additional standards and should be addressed to ASTM International Headquarters. Your comments will receive careful consideration at a meeting of the responsible technical committee, which you may attend. If you feel that your comments have not received a fair hearing you should make your views known to the ASTM Committee on Standards, at the address shown below.

This standard is copyrighted by ASTM International, 100 Barr Harbor Drive, PO Box C700, West Conshohocken, PA 19428-2959, United States. Individual reprints (single or multiple copies) of this standard may be obtained by contacting ASTM at the above address or at 610-832-9585 (phone), 610-832-9555 (fax), or service@astm.org (e-mail); or through the ASTM website (www.astm.org). Permission rights to photocopy the standard may also be secured from the Copyright Clearance Center, 222 Rosewood Drive, Danvers, MA 01923, Tel: (978) 646-2600; http://www.copyright.com/