



Standard Test Method for Dust Erosion Resistance of Optical and Infrared Transparent Materials and Coatings¹

This standard is issued under the fixed designation F1864; the number immediately following the designation indicates the year of original adoption or, in the case of revision, the year of last revision. A number in parentheses indicates the year of last reapproval. A superscript epsilon (ϵ) indicates an editorial change since the last revision or reapproval.

1. Scope

1.1 This test method covers the resistance of transparent plastics and coatings used in aerospace windscreens, canopies, and viewports to surface erosion as a result of dust impingement. This test method simulates flight through a defined particle cloud environment by means of independent control of particle size, velocity, impact angle, mass loading, and test duration.

1.2 *This standard does not purport to address all of the safety concerns, if any, associated with its use. It is the responsibility of the user of this standard to establish appropriate safety and health practices and determine the applicability of regulatory limitations prior to use.*

2. Referenced Documents

2.1 ASTM Standards:²

- D618 Practice for Conditioning Plastics for Testing
- D1003 Test Method for Haze and Luminous Transmittance of Transparent Plastics
- D1193 Specification for Reagent Water
- E11 Specification for Woven Wire Test Sieve Cloth and Test Sieves
- E168 Practices for General Techniques of Infrared Quantitative Analysis (Withdrawn 2015)³

3. Terminology

3.1 Definitions of Terms Specific to This Standard:

3.1.1 *mass loading, n*—the mass of dust per unit of total exposed surface area (including the sample holder) that impinges on the specimens.

¹ This test method is under the jurisdiction of ASTM Committee F07 on Aerospace and Aircraft and is the direct responsibility of Subcommittee F07.08 on Transparent Enclosures and Materials.

Current edition approved April 1, 2016. Published April 2016. Originally approved in 1998. Last previous edition approved in 2010 as F1864–05 (2010). DOI: 10.1520/F1864-16.

² For referenced ASTM standards, visit the ASTM website, www.astm.org, or contact ASTM Customer Service at service@astm.org. For *Annual Book of ASTM Standards* volume information, refer to the standard's Document Summary page on the ASTM website.

³ The last approved version of this historical standard is referenced on www.astm.org.

3.1.2 *mean IR transmission, n*—for the purposes of this standard, the average percentage of light transmitted by a material in the 8- to 12- μm bandwidth.

3.1.3 *sweep time, n*—the time required for one translation pass.

3.1.4 *translation pass, n*—the translation of the specimen platform from the vertical or horizontal limit to the corresponding vertical or horizontal limit.

3.1.5 *translation cycle, n*—the translation of the specimen platform from the vertical or horizontal limit to the corresponding vertical or horizontal limit and back to the initial vertical or horizontal limit. Two translation passes are equivalent to one translation cycle.

3.2 Symbols:

- A_s = reference surface area of specimen platform (cm^2),
- C_c = simulated cloud concentration (g/m^3),
- h_o = percent haze before exposure,
- h_e = percent haze after exposure,
- \dot{m}_p = rate of particle mass impacting the reference surface area (g/min),
- \dot{m}_i = incremental mass loading (g/cm^2),
- m_T = total mass loading (g/cm^2),
- N = number of increments,
- V_p = particle impact velocity (m/s),
- t_s = sweep time(s),
- T_e = optical or mean infrared (IR) transmission after exposure (%),
- T_o = optical or mean IR transmission before exposure (%),
- α = impact angle (normal incidence = 90°),
- Δt_i = exposure time (min) for loading increment i ,
- ϕ_i = incremental dust load (g/cm^2) for loading increment i ,

- Φ = total dust load (g/cm^2),
- Δh = change in percent haze, and
- ΔT = change in optical or IR transmission.

4. Summary of Test Method

4.1 This test method consists of: (1) measuring and recording the light transmission properties, at visual or infrared wavelengths, of test coupons; (2) mounting the coupons in a test fixture; (3) exposing the coupons to a dust particle stream;

and (4) remeasuring the light transmission properties to determine changes in these properties.

4.2 The dust particle stream simulates flight at a specified velocity through a dust cloud of specified density. Simulation is accomplished through control of particle size distribution, mean particle velocity, particle mass flow rate, and angle of impact.

4.3 The degree of abrasion is measured by the amount of change in haze and luminous transmittance for materials transparent in the visual wavelengths and by the amount of change in IR spectral transmission for materials transparent in the infrared wavelengths.

5. Significance and Use

5.1 All materials on exterior aircraft surfaces are subject to abrasion from airborne particles of various sizes and shapes. Transparent materials are particularly vulnerable to abrasion, since their performance is based on their ability to transmit light with a minimal amount of scatter. Scratches, pitting, and coating removal and delamination as a result of abrasion may increase scatter, reduce transmission, and degrade the performance of transparent materials. Visually transparent materials are required for pilot and air crew enclosures, such as canopies, windshields, and viewpoints. Materials transparent in the IR region (8 to 12 μm) are required for tracking, targeting, and navigational instrumentation.

5.2 This test method is intended to provide a calibrated and repeatable means of determining the relative abrasion resistance of materials and coatings for optical and IR transparent materials and coatings. The test parameters for this test method can be directly related to dust cloud densities and velocities to which transparent materials are exposed in the field.

6. Apparatus

6.1 *Dust Erosion Abrader*, as illustrated in Fig. 1. The test apparatus simulates flight through dust environments by blowing crushed silica particles, at a controlled mass flow rate and velocity, onto samples that are stationary in the direction of particle flow. The dust erosion abrader consists of four distinct subsystems: transport gas system, dust particle delivery system, dust velocity calibration system, and specimen platform.

6.1.1 The transport gas system carries the dust particles at specified velocity. The transport gas for the particles shall be dry air or nitrogen. The transport gas shall be controlled by a system of precision regulators and pressure transducers and routed through a nozzle which produces stable flow for the particle sizes and velocities of interest. Dust particles are accelerated to target velocities in a circular jet formed by the expansion of compressed gas in the nozzle. The nozzles conforming to Fig. 2 have been shown to produce stable flow for inlet pressures in the range 5.50 to 620 kPa (0.800 to 90.0 psi). The nozzle consists of converging-diverging sections,

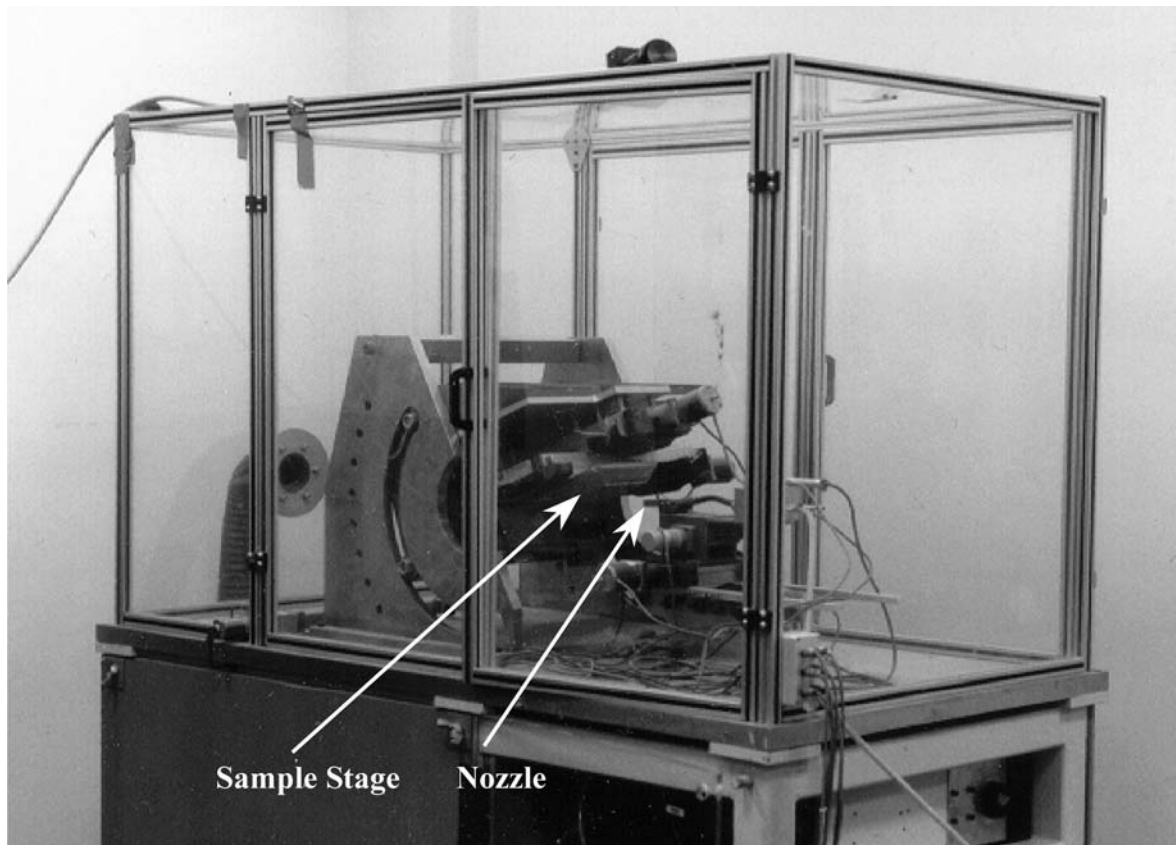
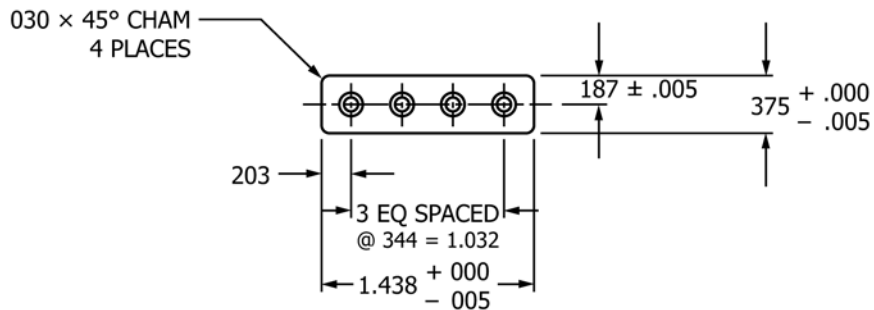
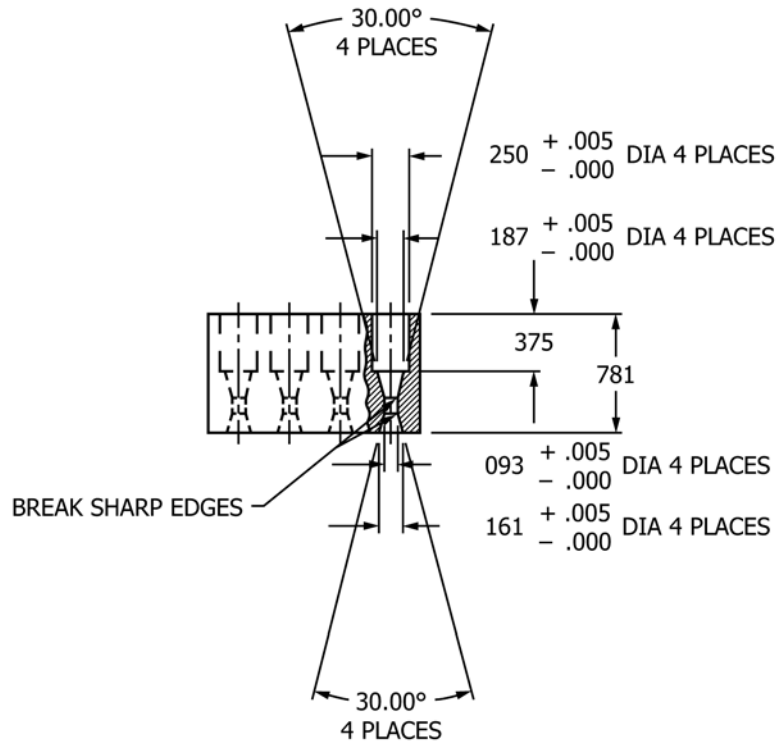

FIG. 1 Dust Erosion Chamber



1. MATERIAL AISI S2 TOOL STEEL
NOTES:

FIG. 2 Recommended Nozzle Configuration

which accelerate the gas phase to supersonic speeds, and a constant diameter extension which provides sufficient resident time for particle acceleration. Fig. 3 shows typical stable velocities that can be achieved using the nozzle in Fig. 2. The nozzle mount shall include adjustments for convenient access to the specimen platform during mounting of the specimen holder and for positioning the nozzle a distance of 25.4 mm (1.00 in.) from the specimen after mounting.

6.1.2 The dust particle delivery system directs particles into the transport gas stream. The delivery system shall deliver uniform and consistent mass flow over the range of 0.200 to 10.0 g/min. The system consists of a pressurized holding container for the dust and a mechanism for directing the dust into the transport gas stream. A screw feeder system housed in a pressurized plenum (Fig. 4) has been demonstrated to provide the required mass flow. The particle delivery system shall

possess control instrumentation separate from the transport gas control system so that mass flow rate of the dust can be controlled independent of the transport gas velocity.

6.1.3 The dust velocity calibration system shall consist of a noninvasive velocity measurement system (VMS) such that particle velocity may be calibrated to transport gas pressure and dust mass flow rate. The laser doppler velocimeter (LDV) shown in Figs. 5 and 6 has been demonstrated to provide the required velocity measurements. In-situ monitoring of velocity during dust exposure is recommended. However, if the size or configuration of the noninvasive VMS prohibits in-situ monitoring, pre- and post-exposure calibration shall be conducted to ensure that the velocity/pressure calibration has remained valid through the test.

6.1.4 The specimen platform and test bed consists of stages and fixtures onto which test specimens and the nozzle are

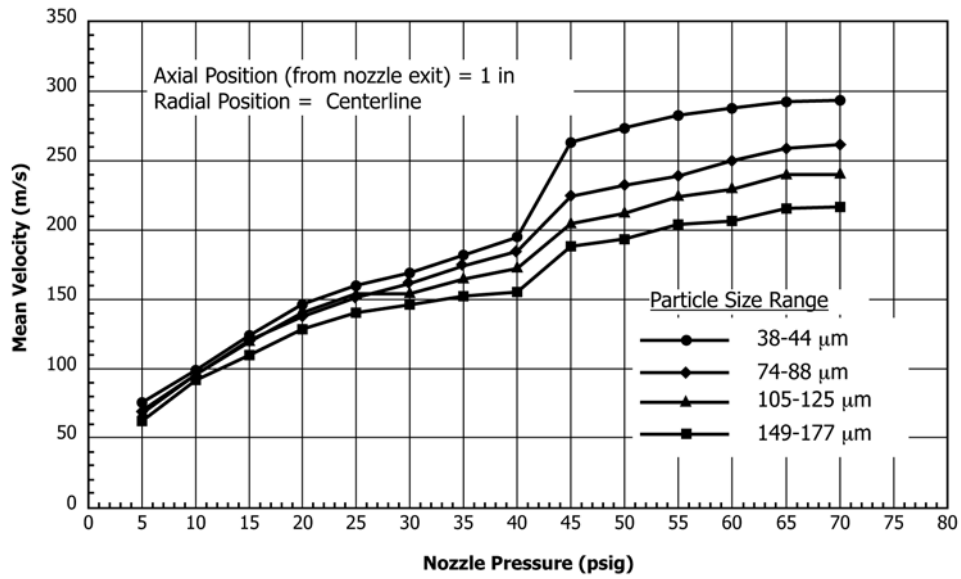

FIG. 3 Typical Velocity/Pressure Profile for Fig. 2 Nozzle

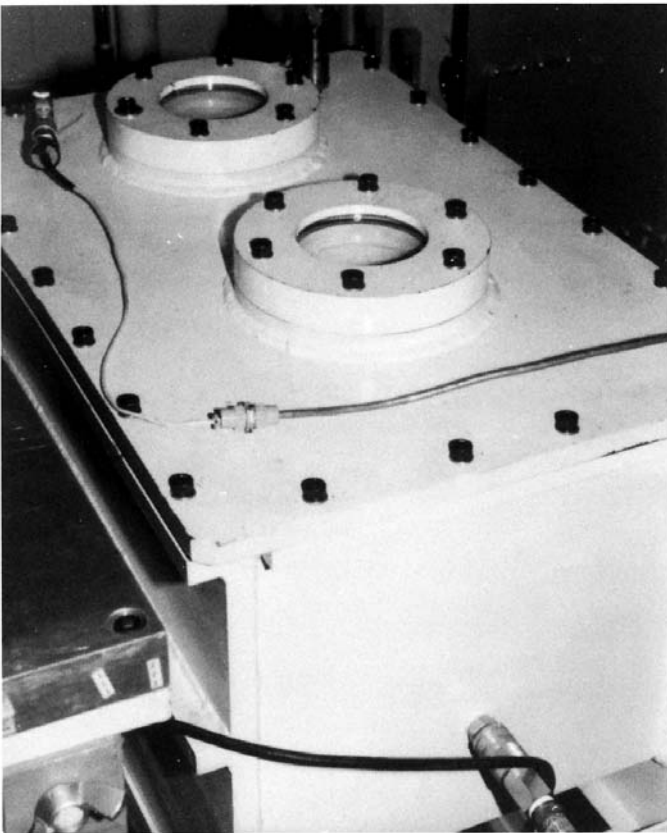

FIG. 4 Screw Feeder and Pressurized Plenum

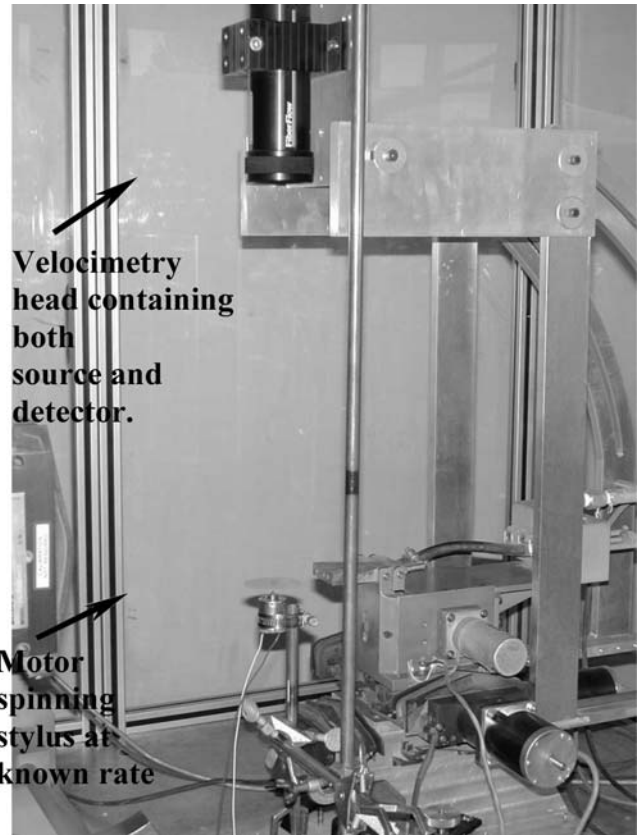

FIG. 5 Laser Doppler Velocimeter Calibration

mounted. The test bed shall include adjustments such that dust particle incidence angles range from normal to 70° off-normal. Because the particle stream is substantially smaller than the specimen holder, the specimen platform shall translate both horizontally and vertically through the particle stream to ensure uniform coverage of all specimens. Screw-type mechanisms or stepper motors are recommended for platform translation.

Translation rates shall be adjustable from 0 to 30 translation cycles per minute horizontally and 0 to 4 translation cycles per minute vertically. The translation range shall be sufficient to permit the outermost specimens to translate completely past the dust jet in all directions. The specimen platform shall accommodate a variety of test sample geometries. Samples ranging in size from 25.4 mm (1.00 in.) in diameter to 152 mm (6.00 in.) square have been exposed in the test bed shown in Fig. 7. The

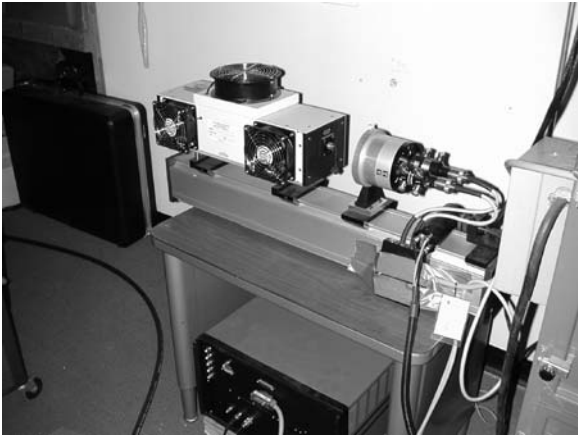

FIG. 6 Laser Doppler Power Supply and Instrumentation

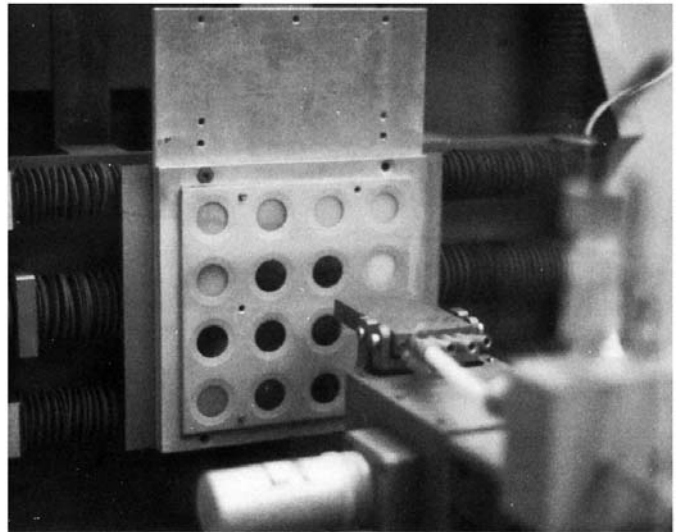

FIG. 8 Typical Frontal Mask



FIG. 7 Dust Erosion Test Bed with Programmable Stepper Motors

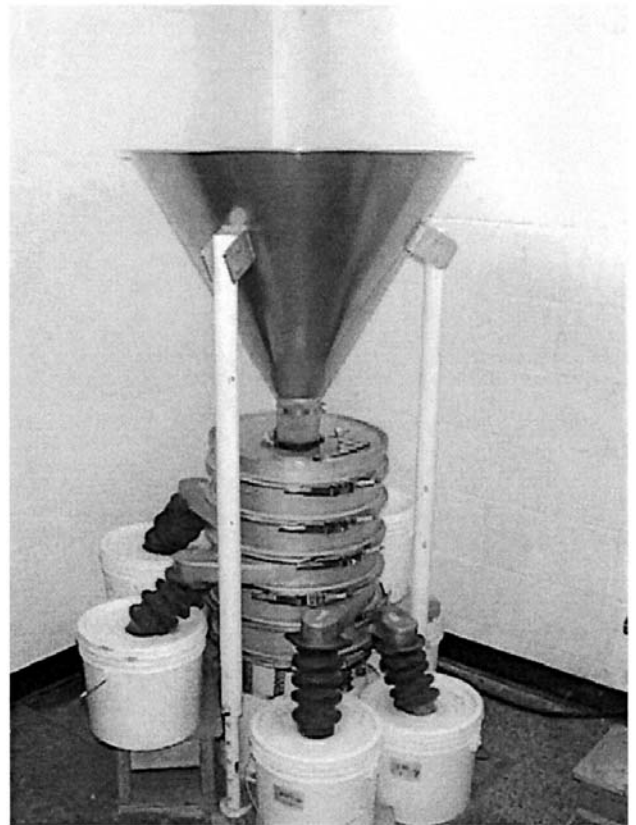

FIG. 9 Continuous Flow Vibrating Sieve

specimen platform shall include adjustment for convenient mounting of samples. Sample holders shall include a frontal mask to control the abraded area and prevent abrasion near sample edges. The frontal mask shall include tapered edges (Fig. 8) to direct the dust flow onto the sample.

6.2 A wire-cloth particle sieve shall be used to obtain specific particle-size ranges. A continuous flow vibrating sieve system (Fig. 9) is recommended for optimum and efficient sieving of bulk sand. Sieve nominal dimensions and permissible variations shall comply with the U.S.A. Standard Test Sieves Standard Series as detailed in Specification E11.

6.3 *Integrating Sphere Photoelectric Photometer*, as described in Test Method D1003, shall be used to measure the light transmitted and scattered by the abraded surface of optically transparent materials and coatings.

6.4 *Fourier Transform Infrared (FTIR) Spectrometer* shall be used to measure the IR transmission properties of IR transparent materials and coatings. The spectrometer shall be capable of measuring percent transmission in the 8- to 12- μm bandwidth. A number of self-contained commercial FTIR

systems existing on the market have been demonstrated to provide the required measurements. Spectrometers used in this test method shall comply with applicable sections of Practice E168.

7. Materials and Reagents

7.1 *Purity of Water*—Unless otherwise indicated, references to water shall be understood to mean reagent water as defined by Type II of Specification D1193.

7.2 *Crushed Silica Sand*—The dust particles shall consist of crushed silica sand. The sand shall be dry, nonclogging, and have corners and edges that have not been rounded by other than the crushing process. Bulk dust particle sizes shall be uniformly distributed in the range 10 to 250 μm .

7.3 *Compressed Air or Nitrogen*—The transport gas shall be dry and pressurized to a minimum of 827 kPa (120 psi) at the source.

7.4 *Isopropyl Alcohol Solution*—Mix isopropyl alcohol ($\text{C}_3\text{H}_7\text{OH}$) with water in a volumetric ratio of 1:1.

8. Test Specimens

8.1 *Optically Transparent Materials*—Test specimens shall be clean flat samples of the material or substrate/coating system to be evaluated. Sample dimensions, including thickness, shall be of any convenient dimension that can be accommodated by the specimen platform and test bed, with a minimum exposed surface area of 363 mm^2 (0.750 in.^2). Samples ranging in size from 25.4 to 152 mm (1.00 to 6.00 in.) square have been found to accommodate most test requirements. Sides of samples shall be substantially plane and parallel. Edge chipping and coating delamination resulting from sample fabrication or preparation shall not extend into the unmasked portion of the sample.

8.2 *IR Transparent Materials*—Test specimens shall be clean flat samples of the material or substrate/coating system to be evaluated. Sample dimensions, including thickness, may be of any convenient dimension that can be accommodated by the specimen platform and test bed, with a minimum exposed surface area of 363 mm^2 (0.750 in.^2). Samples 25.4 mm (1.00 in.) in diameter have been found to be suitable for most test requirements. Edge chipping and coating delamination resulting from sample fabrication or preparation shall not extend into the unmasked portion of the sample.

8.3 Apply specimen ID numbers to the edges of specimens using a permanent marker suitable for the material being exposed.

8.4 For each exposure condition, prepare and test a minimum of three samples.

8.5 For storage purposes, wrap samples in lint-free tissue or other suitable materials to prevent scratching or marring of the surface.

9. Preparation of Apparatus

9.1 Identify the distribution of dust particles to be used in the exposure and sieve the bulk sand to the desired distribution. Follow the operating directions of automated sieving equip-

ment if used. (**Warning**—Sieving of the bulk sand can create small airborne dust particles that can irritate the nose, throat, and lungs. Wear a breathing mask appropriate for the particle size being sieved to minimize the hazard of inhaling airborne dust particles.)

9.2 Fill the pressurized holding chamber with the dust required for the exposure run.

9.2.1 If the holding container requires simple replenishment of dust, remove the chamber lid and add the required amount of dust. Check all pressure seals for damage, and replace if damaged or worn. Carefully replace the lid, ensuring the chamber is adequately sealed.

9.2.2 If the subsequent exposure run requires exchanging dust sizes, remove the chamber lid and remove the dust from the previous run. Thoroughly clean all chamber and delivery system components (disassemble if necessary) to remove all traces of the previous dust. Wipe holding chamber surfaces with a lint-free towel dampened with isopropyl alcohol solution. Add the required amount of dust for the next exposure run. Check all pressure seals for damage, and replace those that are damaged or worn. Carefully replace the lid, ensuring the chamber is adequately sealed.

10. Calibration and Standardization

10.1 *Pressure in Transport System and Dust Delivery System*—Calibrate transducers with 0- to 1.00-MPa (0- to 150-psig) range in accordance with manufacturer specifications. If none are available, calibrate the transducer by comparison to a secondary standard. Connect the pressure transducer and a high resolution dial gage (0 to 1.5 MPa/0 to 220 psig) to the holding chamber. Zero the transducer, and pressurize the chamber to 690 kPa (100 psig). Compare the output transducer to the dial gage. If the transducer reading does not agree with the gage, adjust the scale of the output reading device to bring the transducer into agreement.

10.2 *Dust Mass Flow*—Calibrate the dust mass flow rate for the dust delivery system in accordance with manufacturer specifications. For a screw feeder system, calibrate the dust mass flow rate to the screw size, screw speed, and particle size distribution by measuring the accumulated mass delivered by the screw feeder over a number of selected time intervals.

10.3 *Dust Velocity*—If in-situ dust velocity measurement is not performed, calibrate the dust velocity to the transport gas pressure for the particle size used in the exposure. Locate the noninvasive velocity measurement system such that the dust particle stream intersects the probe volume at the same distance from the nozzle exit as the specimens will be placed during the exposure. Perform the calibration with the dust delivery system ON.

NOTE 1—Calibrating the air velocity to transport gas pressure without dust in the transport gas stream will produce erroneous calibration. The presence of dust significantly affects the transport gas flow and must be included in calibration.

10.3.1 Measure the mean particle velocity for gas transport pressures from 0 to 69 kPa (1 to 10 psi) in increments of 6.9 kPa (1 psi). Measure the mean particle velocity from 690 to 483 kPa (10 to 70 psi) in increments of 34.5 kPa (5 psi).

10.3.2 Identify the pressure increments bounding the velocity of interest. For a lower pressure bound greater than 69 kPa (10 psi), measure the mean particle velocity for pressure increments of 6.9 kPa (1 psi), starting at the lower bound and continuing until the target velocity is exceeded. Repeat the process in increments of 0.690 kPa (0.1 psi), starting at the pressure immediately before the target velocity was exceeded and continuing until the target velocity is achieved or slightly exceeded. Use this pressure for the exposure of specimens. For a lower bound less than 69 kPa (10 psi), measure the mean particle velocity for pressure increments of 0.690 kPa (0.1 psi), starting at the lower bound and continuing until the target velocity is achieved or slightly exceeded. Use this pressure for the exposure of specimens.

NOTE 2—For the Fig. 2 nozzle configuration, the velocity/pressure calibration is a strong function of particle size, but not of particle mass flow rate. A low flow rate is recommended for velocity calibration to conserve sieved dust.

10.4 Obtain specific particle size ranges by sieving bulk (crushed) silica sand using the wire-cloth screens in accordance with 6.2. Simulate a specific particle size distribution by selecting appropriate mass fractions of particles from the size ranges obtained from sieving. The size ranges available are defined by the specific sieve sizes. Determine the mass fraction within each size range by the specified particle distribution being simulated.

11. Conditioning

11.1 Condition optically transparent specimens in accordance with Procedure A of Practice D618.

11.2 Condition IR transparent specimens in accordance with Practice E168.

12. Procedure

12.1 Identify the specific dust erosion environment to be simulated. Specify the following parameters:

12.1.1 Dust cloud density,

12.1.2 Dust impingement velocity, and

12.1.3 Dust impingement angle.

12.2 Based on the specified parameters of 12.1, calculate the dust mass flow rate using Eq 1.

$$\dot{m}_p = \frac{C_c V_p A_s \sin \alpha}{166.7} \quad (1)$$

Select the nozzle inlet pressure to produce the desired velocity for the selected particle size distribution.

12.3 Adjust the particle delivery system controls to deliver dust at the mass flow rate calculated from Eq 1 for the selected particle size distribution.

12.4 Specify the total mass loading and desired number of increments. Calculate the required incremental loading from Eq 2. Calculate the required sweep time using Eq 3.

$$m_i = \frac{m_T}{N} \quad (2)$$

$$t_s = \frac{m_i A_s}{\dot{m}_p} \quad (3)$$

12.5 Adjust the vertical sweep rate such that one vertical translation pass requires t_s seconds to complete. Adjust the horizontal sweep rate for 18 to 20 horizontal translation passes per vertical translation pass.

12.6 Measure the haze and luminous transmission of optically transparent materials in accordance with Test Method D1003. Measure the spectral transmission and average transmission over the range 8 to 12 μm for IR transparent materials in accordance with FTIR manufacturer specifications and Practice E168.

12.7 Secure test specimens to the mounting plate with frame and retainer strips appropriate for the dimensions of the specimens being exposed. Secure the mounting plate to the specimen platform on the test bed.

12.8 Adjust the specimen impact angle by rotating the specimen platform. Secure in place. Position the nozzle at the distance from the specimen platform for which velocity calibration was performed. (**Warning**—Keep hands and all loose articles of clothing away from moving components and potential pinch points during securing of the specimen platform and subsequent motion of the translation systems.)

12.9 Operate the vertical and horizontal translation systems to verify complete coverage of all mounted specimens and to verify sweep rates. Deactivate the translations systems such that the specimen platform stops at the upper or lower limit of vertical travel and the left or right limit of horizontal travel in preparation for test initiation. Ensure that the dust jet will not impinge on any specimens when the sample platform is in this position.

12.10 Open the transport gas valve and adjust the flow to achieve the specified nozzle pressure. Allow the nozzle pressure to stabilize. Activate the dust delivery system. Observe the flow of particles and ensure that particles are flowing smoothly. Adjust the transport gas valve as necessary to reestablish the specified nozzle pressure after introduction of dust particles. Allow the pressure and dust flow to stabilize. Steady dust flow should be impinging on the specimen platform but outside the range of the specimens. (**Warning**—Significant airborne dust and noise may be generated during exposure, particularly at high dust mass flow rate and transport gas velocity. Wear appropriate dust mask and hearing protection during test equipment operation.)

12.11 Activate the horizontal and vertical translation systems. Simultaneously record start time or initiate timer. Monitor dust accelerator and specimen translator operation during exposure. After the required number of vertical translation passes, terminate the exposure by stopping the vertical translation with the specimen platform at either the upper or lower limits of travel. Simultaneously record stop time.

12.12 Terminate horizontal translation and deactivate dust delivery system. Close transport gas valves and depressurize transport gas lines and dust container. Position specimen platform a convenient distance from the nozzle (or vice versa) to permit access to the specimen holder. Remove the specimen holder.

12.13 Carefully remove specimens from the specimen holder, handling by the edges only. Remove residual dust from the abraded surface by washing specimens under a water stream for a minimum of 10 s. Dry the specimens by blowing with dry filtered air, nitrogen, or other compressed gas compatible with the test specimen material. Clean samples with isopropyl alcohol solution and lint-free cloth and dry as above. Remove water marks by a second water wash if required and dry as above.

12.14 Measure the appropriate transmission per 12.4.

12.15 Prepare photomicrographs of the damaged surface, if desired. Magnification in the range 20 to 200× is recommended for general surface morphology studies.

12.16 Repeat 12.5 – 12.13 until desired total dust load is achieved.

13. Calculation and Interpretation of Results

13.1 *Actual Dust Load*—Calculate actual incremental dust load, ϕ , using Eq 4, and the total dust load, Φ , using Eq 5.

$$\phi_i = \frac{\dot{m}_i \Delta t_i}{A_s} \quad (4)$$

$$\Phi = \sum_i \phi_i \quad (5)$$

13.2 *Change in Transmission*—Calculate the change in optical or IR transmission as a result of incremental or total dust load as the difference in transmission before and after exposure:

$$\Delta T = T_o - T_e \quad (6)$$

13.3 *Change in Percent Haze*—Calculate the change in percent haze (optically transparent materials only) as a result of incremental or total dust load as the difference in percent haze before and after exposure.

$$\Delta h = h_e - h_o \quad (7)$$

14. Report

14.1 Report the following information for each specimen:

14.1.1 Type of material or substrate/coating being evaluated, including coating thickness. Include manufacturing data if appropriate.

14.1.2 The exposure conditions, including impact angle, particle size distribution, mean impact velocity, simulated cloud density, and incremental and total dust load at each increment.

14.1.3 A spectral transmission plot (8 to 12 μm) before exposure and after each incremental dust load for IR transparent specimens.

14.1.4 The change in transmission characteristics: percent luminous transmittance and percent haze for optically transparent specimens or average percent transmission for IR transparent materials.

14.1.5 A summary of damaged surface morphology if photomicrographs were produced.

15. Precision and Bias

15.1 *Precision*:

15.1.1 No statement of interlaboratory (between-laboratory) reproducibility can be made because insufficient laboratories exist to conduct a round-robin test program.

15.1.2 Intralaboratory (within-laboratory) repeatability has been determined for a single facility based on tests conducted over a twelve-month period.

15.1.2.1 The precision of dust velocity is a function of the calibration technique, the particle size distribution, and the repeatability of flow conditions. For dust velocities of the order of 800 ft/s, the 1σ spread in velocity is approximately $\pm 10\%$. The variability includes both the effects of the particle size distribution and aerodynamics. The repeatability of the mean velocity measurements is on the order of 1 % or less. Considering the repeatability of flow conditions and velocity spread as a result of particle size range, two mean velocity measurements should be considered statistically identical if they differ by less than 5 %.

15.1.2.2 The precision to which the mass loading can be measured depends on the precision of the dust delivery system calibration, the area swept out by the specimen translation system, and the dust flow uniformity. Dust mass can be measured by most laboratory balances to ± 0.1 g. With the uncertainty in stop and start time, and the specimen area covered by the dust flow, the repeatability of the total dust load is estimated to be on the order of $\pm 5\%$.

15.1.2.3 The precision of haze and luminous transmittance is as given in Test Method D1003.

15.2 *Bias*—The procedure in Test Method F1864 has no bias because the value of dust erosion resistance is defined in terms of this test method.

16. Keywords

16.1 abrasion; dust erosion; IR window; transparent material

ASTM International takes no position respecting the validity of any patent rights asserted in connection with any item mentioned in this standard. Users of this standard are expressly advised that determination of the validity of any such patent rights, and the risk of infringement of such rights, are entirely their own responsibility.

This standard is subject to revision at any time by the responsible technical committee and must be reviewed every five years and if not revised, either reapproved or withdrawn. Your comments are invited either for revision of this standard or for additional standards and should be addressed to ASTM International Headquarters. Your comments will receive careful consideration at a meeting of the responsible technical committee, which you may attend. If you feel that your comments have not received a fair hearing you should make your views known to the ASTM Committee on Standards, at the address shown below.

This standard is copyrighted by ASTM International, 100 Barr Harbor Drive, PO Box C700, West Conshohocken, PA 19428-2959, United States. Individual reprints (single or multiple copies) of this standard may be obtained by contacting ASTM at the above address or at 610-832-9585 (phone), 610-832-9555 (fax), or service@astm.org (e-mail); or through the ASTM website (www.astm.org). Permission rights to photocopy the standard may also be secured from the Copyright Clearance Center, 222 Rosewood Drive, Danvers, MA 01923, Tel: (978) 646-2600; http://www.copyright.com/