



Standard Specification for Minimum Performance and Safety Requirements for Anesthesia Breathing Systems¹

This standard is issued under the fixed designation F 1208; the number immediately following the designation indicates the year of original adoption or, in the case of revision, the year of last revision. A number in parentheses indicates the year of last reapproval. A superscript epsilon (ε) indicates an editorial change since the last revision or reapproval.

1. Scope

1.1 This specification covers breathing systems and components employed with anesthesia gas machines for humans. This specification considers the circle system as a whole and some of its components individually. A particular emphasis is placed upon component arrangement in the circle absorber-type system, and submits a system of standard description and notation. Excluded are ventilators for use during anesthesia, Mapelson nonbreathing type systems, as well as breathing systems and related components of dental *analgesia* machines. (For rationale, see [Appendix X1](#).)

1.2 *This standard does not purport to address all of the safety concerns, if any, associated with its use. It is the responsibility of the user of this standard to establish appropriate safety and health practices and determine the applicability of regulatory limitations prior to use.*

1.3 This specification is arranged as follows:

Scope	1
Referenced Documents	2
Terminology	3
System Classification	4
Graphic Notations	
Diagramatic Rules	
Functional Segments of the Circle System	
Test Procedures—General	5
Sterilization	6
Systems	7
Leakage of Breathing System	
Resistance of Breathing Systems	
Volume of Gas Not Delivered to Patient Due to Internal Compliance	
Monitoring Requirements	

Adjustable Pressure-Limiting (APL) Valves	8
Reservoir Bags	9
CO ₂ Absorbers	10
Unidirectional Valves	11
Requirements	
Test Procedure	
Optional Components	12
Breathing Tubes	13
Fresh Gas Inlet and Fresh Gas Supply Tube or Hose	14
Connectors	15
Pressure Gauges	16
Y-Piece and Breathing Tubes	17
Information in Labeling	18
Rationale	Appendix X1

2. Referenced Documents

2.1 ASTM Standards:²

F 1054 Specification for Conical Fittings³

F 1204 Specification for Anesthesia Reservoir Bags³

F 1205 Specification for Anesthesia Breathing Tubes

2.2 ANSI/ASME Standard:

ANSI/ASME B40.1M-1985 Standard for Pressure Gauge⁴

3. Terminology

3.1 Definitions:

3.1.1 *absorber assembly*—a container(s) for CO₂ absorbent, and may include, but need not be limited to, the inspiratory and expiratory unidirectional valves, APL valve, and bag mount.

3.1.2 *adjustable pressure limiting valve (APL valve)*—a user-adjustable valve which releases gas and is intended to provide control of the breathing system pressure.

3.1.3 *breathing system*—a gas pathway in direct connection with the patient through which gas flows occur at respiratory

¹ This specification is under the jurisdiction of ASTM Committee F29 on Anesthetic and Respiratory Equipment and is the direct responsibility of Subcommittee F29.10 on Anesthesia Workstations.

Current edition approved May 1, 2005. Published May 2005. Originally approved in 1989. Last previous edition approved in 2000 as F 1208 – 89 (2000)^{ε1}.

² For referenced ASTM standards, visit the ASTM website, www.astm.org, or contact ASTM Customer Service at service@astm.org. For *Annual Book of ASTM Standards* volume information, refer to the standard's Document Summary page on the ASTM website.

³ Withdrawn.

⁴ Available from the American National Standards Institute, 25 W. 43rd St., 4th Floor, New York, NY 10036.

pressures, in which directional valves may be present, and into which a mixture of controlled composition may be dispensed.

3.1.4 *circle breathing system*—a breathing system in which circular gas flow (through separate inspiratory and expiratory pathways) is determined by unidirectional valves.

3.1.5 *common gas outlet*—that port through which the mixture dispensed from the anesthesia gas machine is delivered to the breathing system.

3.1.6 *compliance*—the change of volume per unit change in pressure within a closed system. Units of compliance are: L/kPa or L/cm H₂O (litres per kilopascal or litres per centimetre of water).

3.1.7 *expiratory pathway*—that portion of the gas pathway through which expired gases flow at respiratory pressures.

3.1.8 *fresh gas inlet*—that port on breathing systems to which the fresh gas supply is attached.

3.1.9 *fresh gas supply tube (or hose)*—that conduit conveying gases from the common gas outlet, or other gas source, to the fresh gas inlet of the breathing system.

3.1.10 *inspiratory pathway*—that portion of the gas pathway through which inspiratory gases flow at respiratory pressures.

3.1.11 *kilopascal (kPa)*—SI unit of pressure, 1 kPa approximates 10 cm of H₂O.

3.1.12 *labeling*—information and literature accompanying the device (for example, brochure, package insert, manual, etc.).

3.1.13 *marking*—information directly on a device.

3.1.14 *may*—denotes an optional feature or consideration.

3.1.15 *resistance*—the pressure difference from inlet to outlet of the device per unit of flow, expressed in kPa/L/s (kilopascals per litre per second). For the purposes of this specification, pressure drops are noted at flows of 0.5 L/s and 1.0 L/s.

3.1.16 *room temperature and pressure, dry gas (rtpd)*—for the purposes of this specification, 20 ± 3°C, at ambient barometric pressure.

3.1.17 *shall*—denotes a mandatory feature or consideration.

3.1.18 *should*—denotes a desirable but not mandatory feature or consideration.

4. System Classification

4.1 Symbols were devised, diagrammatic rules established, and a standard method of notation utilized. In addition, these symbols, diagrammatic rules, and method of notation may be used in labeling and marking.

4.1.1 *Notation*—The method of notation consists of two parts: that of graphic notation (see Fig. 1), and that of numeric designation of functional segments of the circle system (see section 3.2 and Fig. 2).

4.1.1.1 *Diagrammatic Rules:*

(1) Gas flow in circuit proceeds in counter-clockwise direction.

(2) Patient end symbol is on the right side of circle.

(3) Reservoir bag symbol is on the left side of circle opposite the patient symbol.

4.1.2 *Functional Divisions of the Circle System—Segmentation*—The circle system is divided into four segments (see Fig. 2) to illustrate specific functional characteristics.

These segments include the following areas where components may be located, or in some cases, shall be located.

Segment 1—From patient to expiratory valve.

Segment 2—From expiratory valve to reservoir bag.

Segment 3—From reservoir bag to inspiratory valve.

Segment 4—From inspiratory valve to patient.

An example of the use of these symbols in a circle system is shown in Fig. 3 and is presented for illustrative purposes only.

5. Test Procedures

5.1 *General*—The test methods are included after each requirement (and each requirement will be referenced by section number in parentheses) to provide a means to substantiate compliance with the requirement. Other test methods may be employed if they can be shown to be equivalent.

5.1.1 *Accuracy*—Unless otherwise specified, accuracy shall be ±5 % of reading for each variable to be measured, and flow meters shall be compensated for pressure.

5.1.2 *Environmental Conditions*—Run all tests at rtpd except where otherwise stated.

5.1.3 *Test Gases*—All tests shall be performed with dry oxygen, or dry medical air, or dry nitrogen, unless otherwise specified in a particular test method.

6. Sterilization

6.1 *Disassembly*—The reusable components of the breathing system, including the absorber and valves, shall be capable of being disassembled as required for cleaning and sterilization.

6.1.1 *Methods*—The manufacturer shall state suitable means of sterilization. The reusable components of the breathing system should be sterilizable by autoclaving.

6.2 *Test Procedure:*

6.2.1 Disassemble according to instructions in the labeling.

6.2.2 Verify by reading the appropriate instructions in the labeling.

7. Systems

7.1 *Requirements*—The requirements of this section refer to breathing system assemblies as supplied complete by the manufacturer, that is, absorber, inspiratory and expiratory valves, APL valve, breathing tubes, Y-piece, and right angle connector (but excluding the reservoir bag and other components). Any component accessory to the breathing system which permits only unidirectional flow (such as some Peep valves and cascade humidifiers) or any device whose correct function depends upon the direction of gas flow through it shall be marked with an arrow indicating the proper directional flow, or the words “inlet” and “outlet,” or both.

7.1.1 *Leakage of Breathing System*—The maximum leakage of the breathing system as described above, shall not exceed 300 mL/min when pressurized to 3.0 kPa (30 cm H₂O).

7.1.1.1 The maximum leakage of a Y-piece and right-angle connector, with two breathing tubes shall not exceed 75 mL/min when pressurized to 3 kPa (30 cm H₂O).

7.1.1.2 The maximum leakage of that portion of the breathing system not specified in 7.1.1.1 shall not exceed 225 mL/min when pressurized to 3.0 kPa (30 cm H₂O).

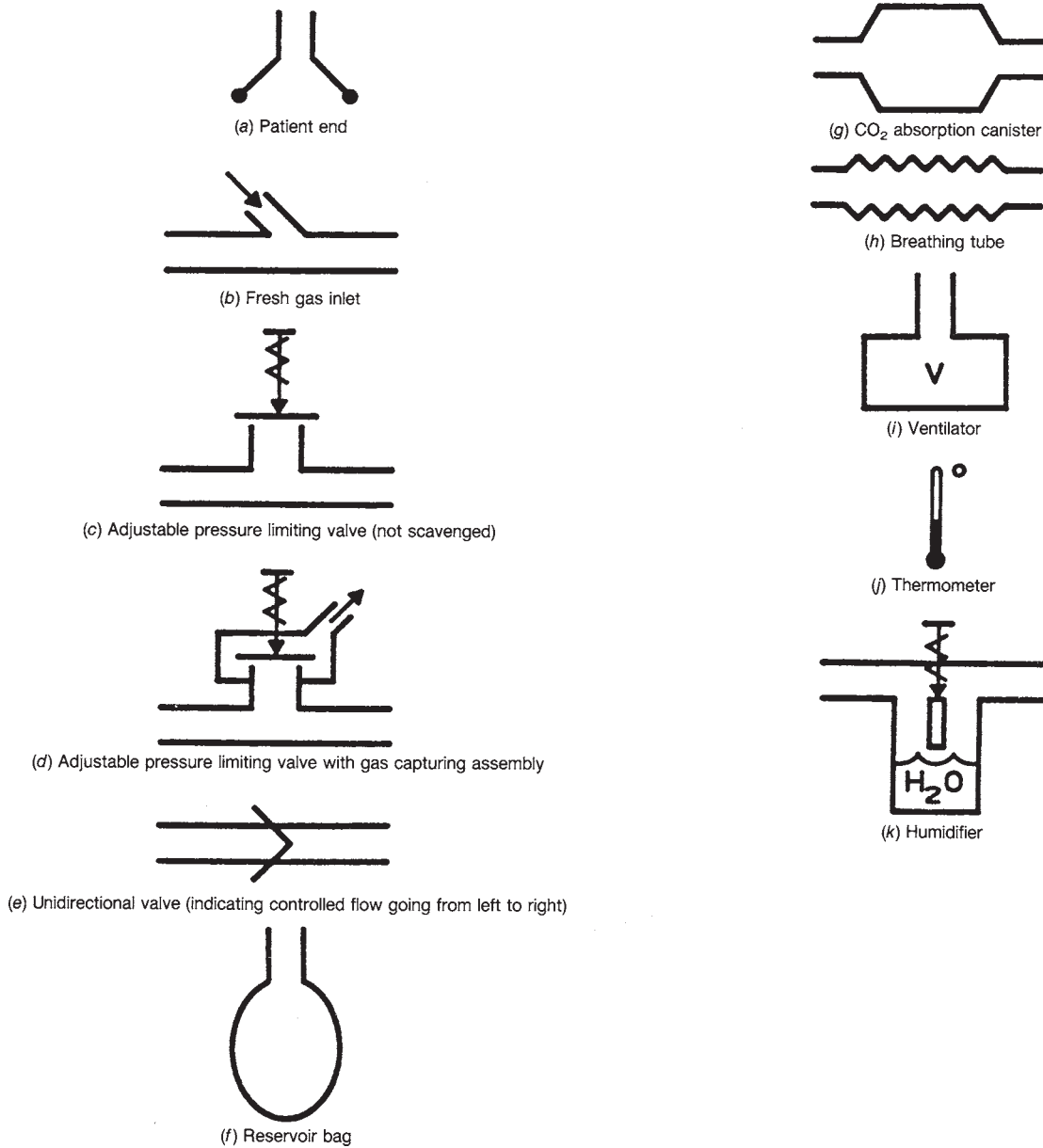

FIG. 1 Symbols

7.1.1.3 Manufacturers shall disclose in their labeling conformance with 7.1.1.

7.1.2 *Resistance of Breathing Systems (see 7.2.2)*—Manufacturers shall disclose in their labeling the typical pressure drops due to inspiratory and expiratory gas flow in their breathing system at reference flows of 0.5 and 1.0 L/s. For pediatric systems resistance at appropriately lower flow rates should be disclosed.

7.1.2.1 *Expiratory Pathway Resistance:*

(1) The maximum expiratory pathway resistance shall not exceed 0.65 kPa (6.5 cm H₂O) at a flow of 1.0 L/s from the patient connection port to the reservoir bag mount, with the APL valve closed.

(2) The maximum resistance of an expiratory tube plus Y-piece or T-piece, with right-angle connector shall not exceed 0.15 kPa (1.5 cm H₂O) per metre length, at a flow of 1.0 L/s.

7.1.2.2 *Inspiratory Pathway Resistance*—The maximum inspiratory pathway resistance shall not exceed 0.65 kPa (6.5 cm

Symbols

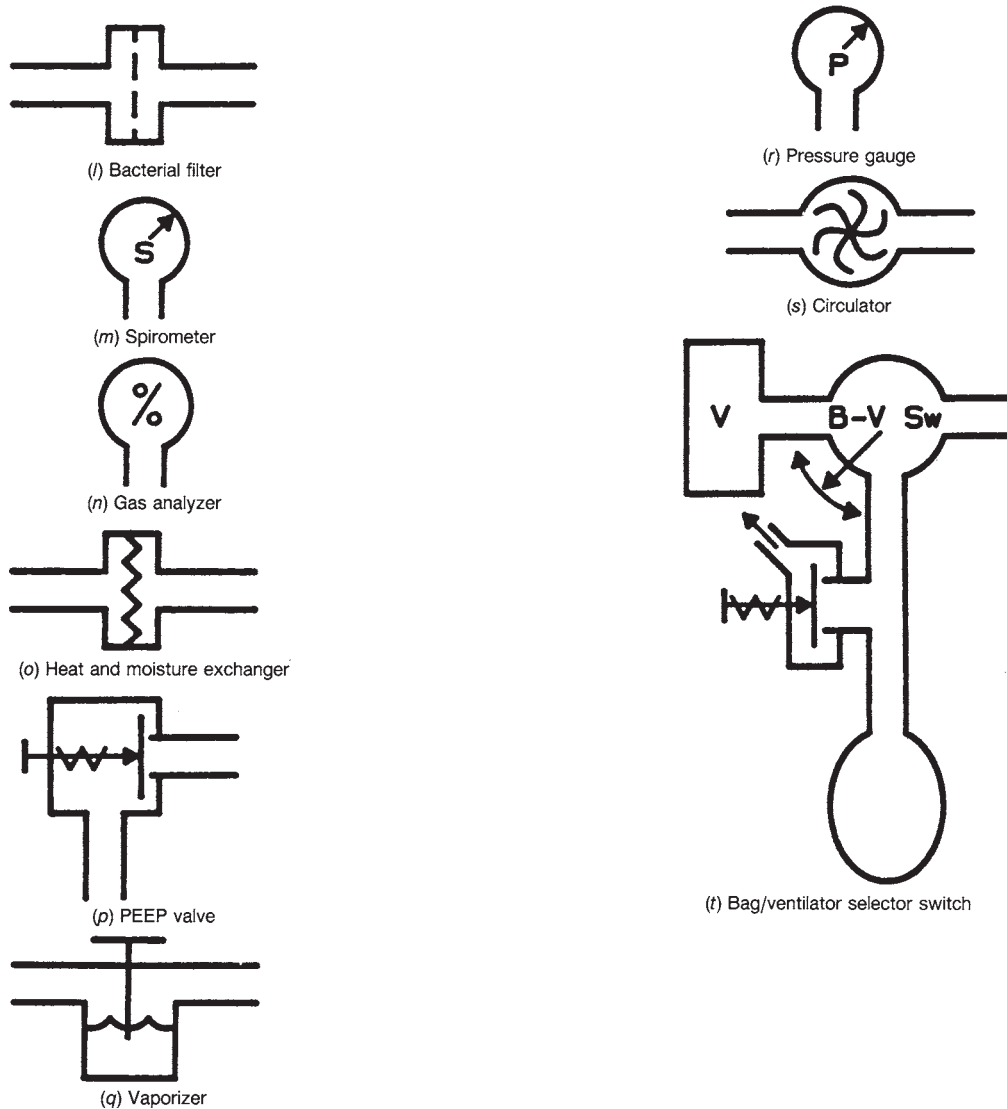

FIG. 1 (continued)

H₂O) at a flow of 1.0 L/s from the reservoir bag mount to inspiratory patient connection port with APL valve closed.

7.1.3 *Volume of Gas Not Delivered to Patient Due to Internal Compliance*—This value, at 2 kPa (20 cm H₂O) and 4 kPa (40 cm H₂O), shall be stated in the labeling.

7.1.4 *Monitoring Requirements*—Breathing systems shall be equipped with a means to accept sensors or with sample extraction ports for monitoring O₂ concentration, breathing pressure, and either exhaled volume or ventilatory CO₂.

7.2 *Test Procedures:*

7.2.1 *Leakage of Breathing System:*

7.2.1.1 *Apparatus Required*—Pressure measuring device and flowmeter(s).

7.2.1.2 *Procedure*—Remove the reservoir bag and seal the bag port and patient connection. The pressure tap should be at the patient connection port. Introduce gas into the system or the component(s) until pressure is stabilized at 3.0 kPa (30 cm

H₂O). Then record the flowmeter reading as the leak. If the system or component(s) incorporate(s) valves designed to allow gas to leak at pressures below 3.0 kPa (30 cm H₂O), seal them for the test.

7.2.2 *Resistance of Breathing System:*

7.2.2.1 *Resistance Measurement of the Inspiratory Pathway*—Seal the expiratory pathway and close the APL valve. Inject air at both 0.5 L/s and 1.0 L/s and measure pressure at the bag port with the patient port open.

7.2.2.2 *Resistance Measurement of the Expiratory Pathway*—The inspiratory limb is sealed and the APL valve is closed. Inject air at both 0.5 L/s and 1.0 L/s and measure pressure at the patient port with bag port open.

7.2.3 *Measurement of Internal Compliance:*

7.2.3.1 The absorber shall be filled with fresh absorbent for this test. Seal the bag and patient ports as well as instrumentation ports and check that the system is gas tight. Add

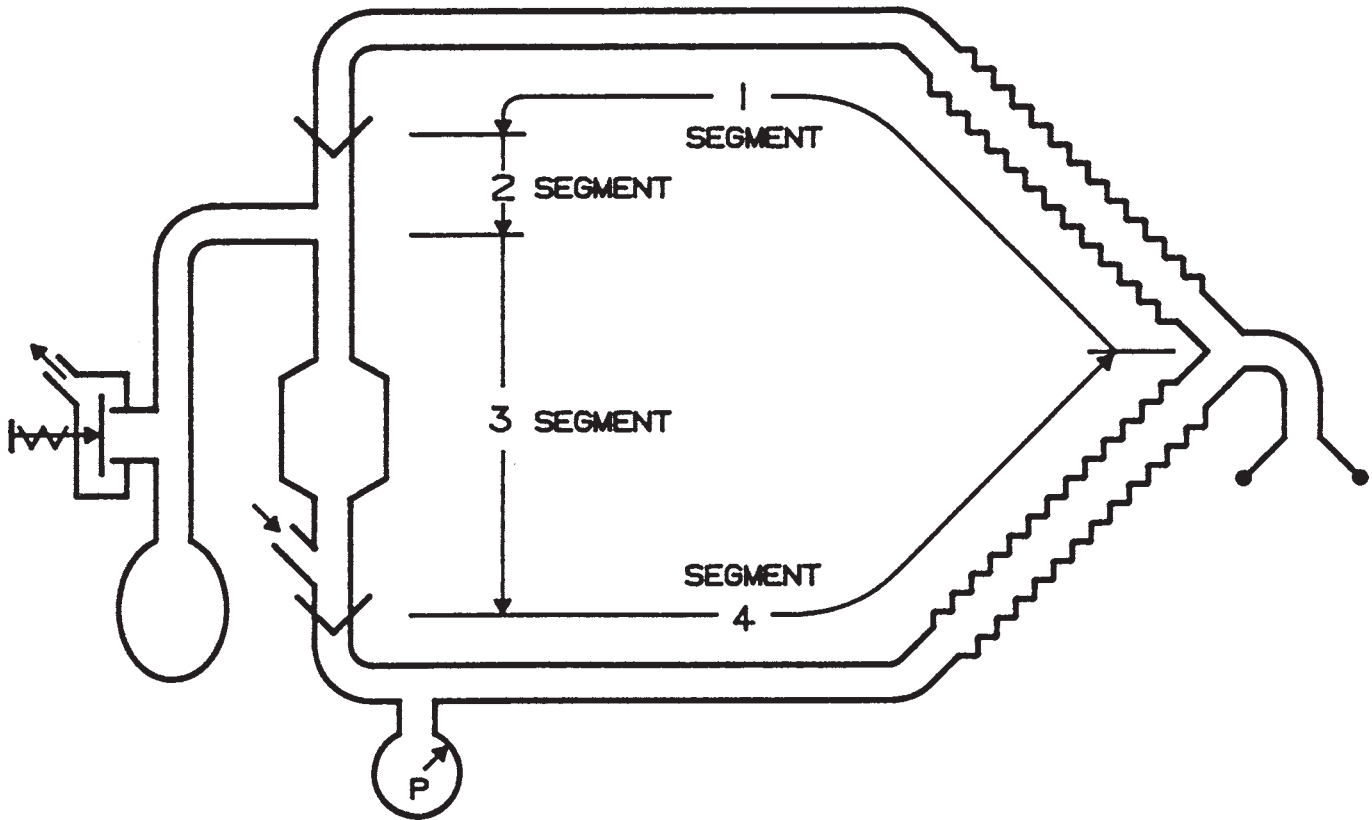

Segment 1—From patient to expiratory valve.
 Segment 2—From expiratory valve to reservoir bag.
 Segment 3—From reservoir bag to inspiratory valve.
 Segment 4—From inspiratory valve to patient.

FIG. 2 Functional Segments of a Circle System

measured volumes of gas through the fresh gas inlet until 2.0 kPa (20 cm H₂O) and then 4.0 kPa (40 cm H₂O) pressures are achieved.

7.2.3.2 Internal compliance is the added volume (divided by 20) needed to achieve 20 cm H₂O pressure and the total of the two added volumes needed to achieve 40 cm H₂O pressure (divided by 40).

8. Adjustable Pressure-Limiting (APL) Valves

8.1 Requirements—These requirements apply to APL valves as separate components and as part of a gas collection assembly.

8.1.1 Placement—In a circle system an APL valve shall not be placed between the inspiratory valve and the patient (segment 4) though it may be placed at the Y-piece. The APL valve should be located in segment 2 or immediately adjacent to the bag mount.

8.1.2 Marking—An arrow or other marking shall be provided to indicate the direction of movement required to close the valve.

8.1.3 Pressure-Flow Characteristics—The influence of flow and control setting on the resistance of the APL valve shall be illustrated in the manual by charting the pressure-flow data curve between 0.5 and 1.0 L/s. For pediatric systems the data should be given for appropriately lower flows with the valve fully open.

8.1.4 Direction of Motion—Valves with rotating controls shall be so designed that a clockwise motion increases the limiting pressure and closes the valve. The full range of relief pressures should be adjusted by less than one full turn of the control.

8.1.5 Resistance at Low Flow—Fully open valves should have a pressure drop of between 0.1 and 0.3 kPa (1.0 and 3.0 cm H₂O) at an air flow of 3.0 L/min.

8.1.6 Resistance at High Flow—Valves, when adjusted to the fully open position, should have a pressure drop at 30 L/min of not less than 0.1 kPa (1.0 cm H₂O) and not greater than 0.5 kPa (5.0 cm H₂O).

8.2 Test Procedures:

8.2.1 Apparatus Required—Flowmeters and a water manometer.

8.2.2 Procedure—This system, shown in Fig. 4, is used to determine the pressure drop across the valve. The valve is isolated and connected as shown. A buffer chamber may be necessary to minimize pressure fluctuation. The proper flowmeter must be selected for each test. Valves must be in fully open position or adjusted as necessary.

8.2.3 Resistance at Low Flow—Increase the flow through the valve gradually until 3.0 L/min is reached. At that constant flow, measure the pressure drop across the valve. The valve

This example of the Use of these symbols in a circle system is for illustrative purposes only.

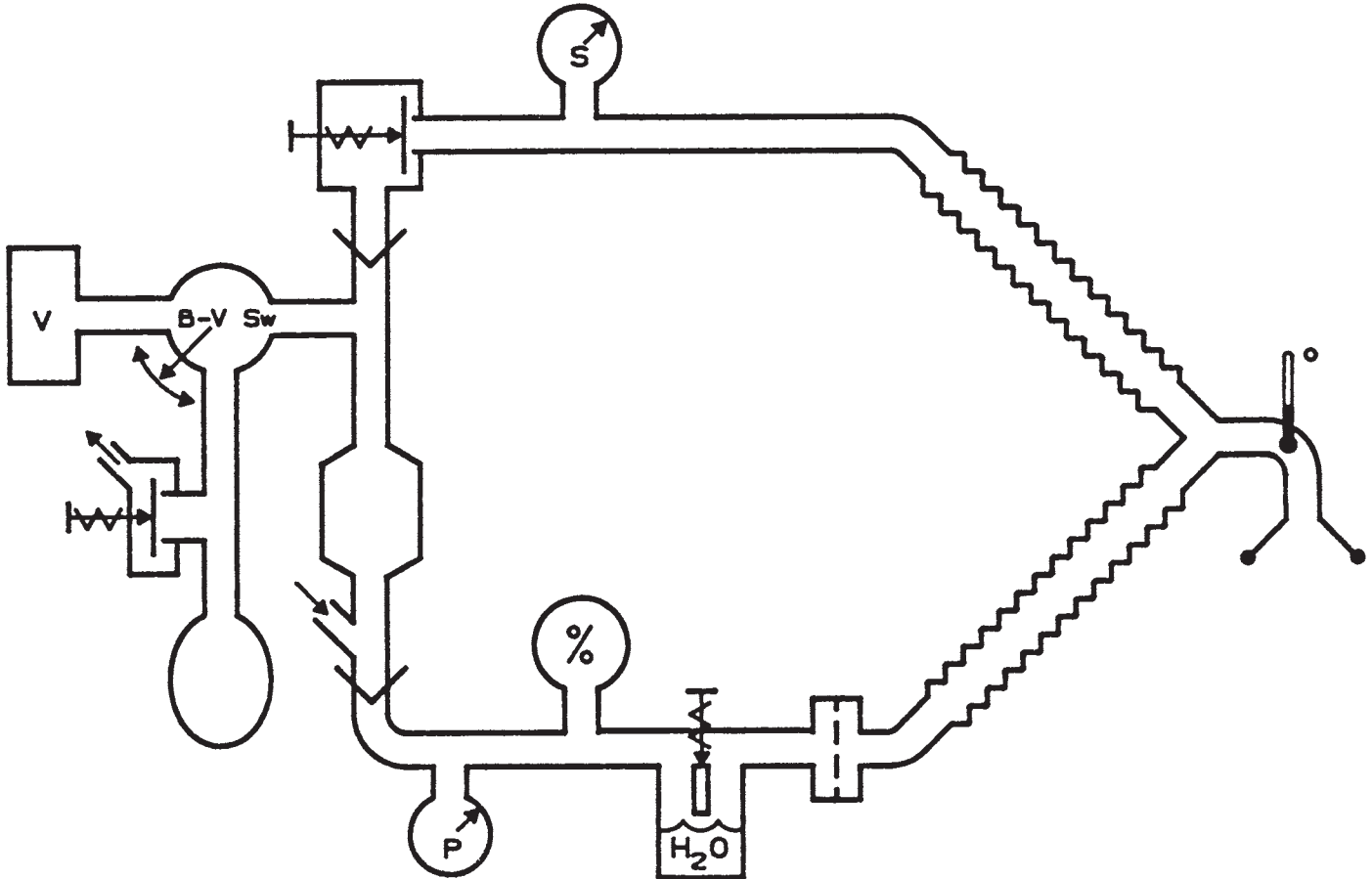

Figure 3 is presented for illustrative purposes only.

FIG. 3 Illustration of the Use of Graphic Notation (Symbols) in a Circle Absorber System

passes the test if the pressure drop is not less than 0.1 kPa (1.0 cm H₂O) and not more than 0.3 kPa (3.0 cm H₂O).

8.2.4 *Resistance at High Flow*—Increase the flow to 30 L/min and measure the pressure drop across the valve. The valve passes the test if the pressure drop is not less than 0.1 kPa (1.0 cm H₂O) and not greater than 0.5 kPa (5.0 cm H₂O).

9. Reservoir Bag Connectors and Reservoir Bags

9.1 *Requirements*—See Specification F 1204.

9.1.1 *Placement*—Reservoir bag connectors shall not be placed on the patient side of the inspiratory or the expiratory valves in a circle system (segments 1 and 4).

9.1.2 The reservoir bag connector shall be male nominal 22 mm outside diameter. The outside configuration may be cylindrical, tapered, or manufacturer-specific in design.

9.2 *Test Procedure:*

9.2.1 Verify by visual inspection.

9.2.2 Verify by visual inspection and measurement.

10. CO₂ Absorbers

10.1 *Requirements:*

10.1.1 *Placement*—The absorber in the circle system should not be placed in segment 1 (from patient to expiratory valve) or at the patient end of segment 4 (from inspiratory valve to patient).

10.1.2 *CO₂ Absorbent Container*—The walls of the container of CO₂ absorbent should be constructed of a transparent material that is compatible with any of the commonly used absorbents and with anesthetic agents at concentrations commonly encountered in the breathing system.

10.1.3 *Drain*—If the design of an absorber so necessitates, a means of draining water from the bottom of the absorber shall be provided.

10.1.4 *Capacity*—The maximum volume of the CO₂ absorbent held in the container shall be stated in the labeling.

10.1.5 *Resistance*—The resistance of a freshly filled absorber assembly measured at 1.0 L/s flow shall be stated in the labeling. The absorbent used shall be stated.

10.1.6 *Instructions*—Instructions for the changing of the absorbent, and for the cleaning, sterilization, and maintaining the gas tightness of the absorber assembly shall be given in the marking or the labeling.

10.1.7 *Prefilled Container for CO₂ Absorbent*—When container(s) are filled with CO₂ absorbent by the manufacturer, they shall be packaged in a way that permits immediate identification of the presence of the wrapper, which must be removed prior to use.

10.2 *Test Procedures:*

10.2.1 (10.1.3) Verify by visual inspection.

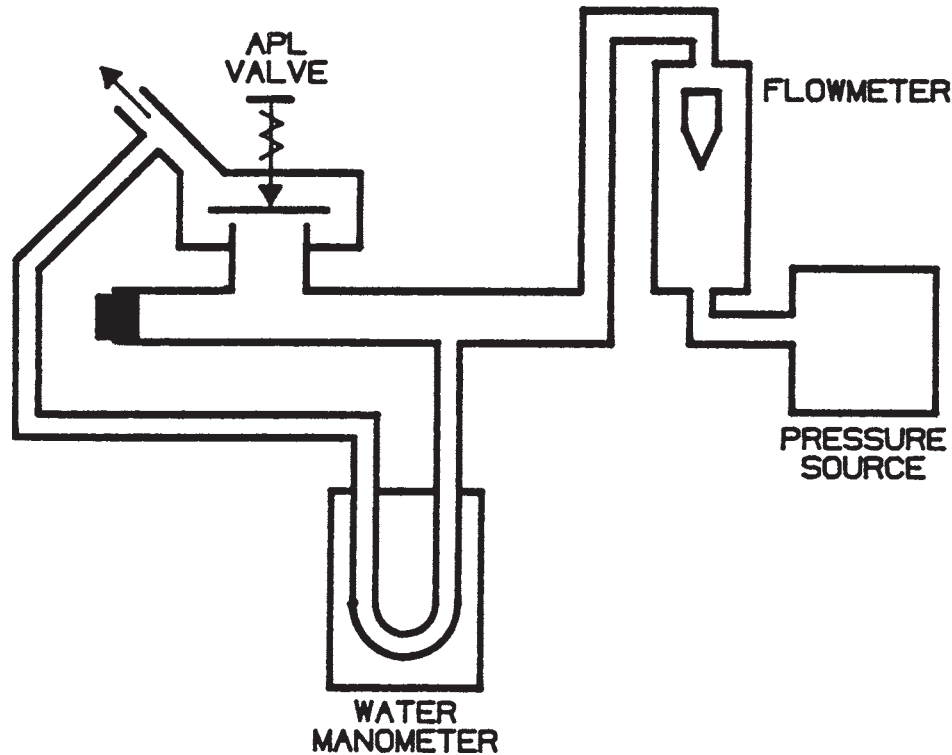

FIG. 4 Arrangement of Apparatus for Resistance Test

- 10.2.2 (10.1.4) Verify by visual inspection.
- 10.2.3 (10.1.5) Verify by visual inspection.
- 10.2.4 (10.1.6) Verify by visual inspection.
- 10.2.5 (10.1.7) Verify by visual inspection.

11. Unidirectional Valves

11.1 Requirements:

11.1.1 *Placement*—Inspiratory and expiratory unidirectional valves shall not be placed in a Y-piece.

11.1.2 *Flow Direction*—The direction of the intended gas flow shall be permanently marked on the valve housing or near its associated hose terminal, with either a directional arrow or with the marking “inspiration,” or “expiration,” so that it is visible to the user when the equipment is being assembled for use.

11.1.3 *Visibility*—The functioning of valves should be visible.

11.1.4 *Resistance*—The resistance of dry and moist inspiratory or expiratory valve assemblies shall not exceed a pressure drop of 0.15 kPa (1.5 cm H₂O) at 1.0 L/s flow.

11.1.5 *Opening Pressure*—The pressure to open moist inspiratory and expiratory valves should not exceed 0.15 kPa (1.5 cm H₂O).

11.1.6 *Reverse Flow and Valve Dislocation*—Reverse flow shall not exceed 60 mL/min at any differential pressure to 0.5 kPa (5 cm H₂O). The valve shall not become dislocated with a reversed differential pressure of 5.0 kPa (50 cm H₂O).

11.1.7 *Sterilization*—Reusable unidirectional valves should be capable of withstanding sterilization by autoclaving, or the manufacturer shall state another means of sterilization that may be used.

11.2 Test Procedures:

11.2.1 Verify by visual inspection that no directional valves are present in the Y-piece.

11.2.2 (11.1.4) *Resistance*—Introduce a 1.0-L/s flow of gas through the valve and measure the pressure drop.

11.2.2.1 To test a moist valve, first condition the valve with a flow of test gas heated and humidified such that the inner surface of the valve dome, or the visible surface of the valve itself has visible condensate. When all surfaces are saturated, turn off the flow of gas to allow the valve to close. Adjust the flow of gas (heated and humidified) to 1.0 L/s and measure the pressure drop.

11.2.3 (11.1.5) Opening Pressure:

11.2.3.1 *Apparatus Required*—Pressure measuring device, flowmeter, and a rigid container (see Fig. 5).

11.2.3.2 *Procedure*—To test a moist valve, first condition the valve with a flow of test gas heated and humidified such that the inner surface of the valve dome or the visible surface of the valve itself has visible condensate. Turn off the flow of gas to allow the valve to close. Reintroduce the flow of gas at 20 mL/min (heated and humidified) while recording the pressure rise at the inlet to the valve. The peak pressure obtained is the moist valve opening pressure.

11.2.4 (11.1.7) Reverse Flow:

11.2.4.1 *Apparatus Required*—(Pressure measuring device(s), flowmeter(s), and a rigid container of 5.0-L capacity (see Fig. 6).

11.2.4.2 *Procedure*—Adjust the flowmeter to maintain a constant flow of 1.0 mL/s. Connect the unidirectional valve—in a reverse direction—to the flowmeter, a rigid container, and the pressure measuring device (see Fig. 6). The pressure must rise to 0.5 kPa (5.0 cm H₂O) in 5 min or less.

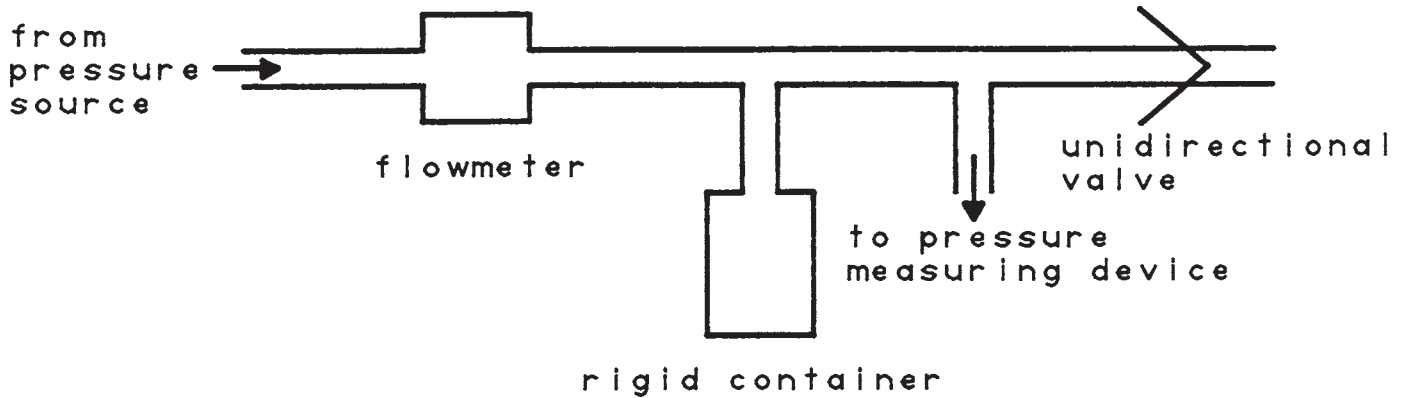

FIG. 5 Arrangement of Apparatus to Test for Opening Pressure

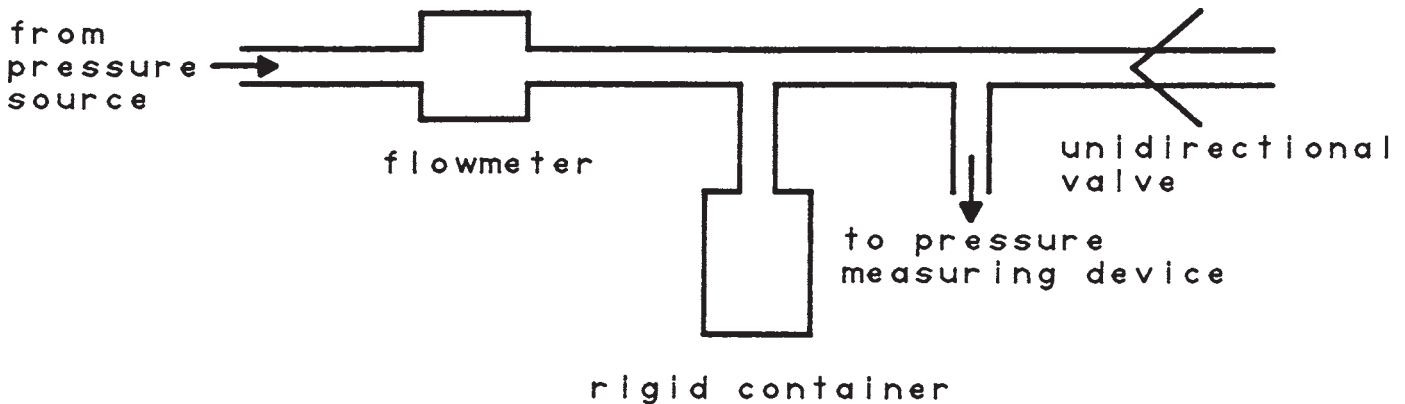

FIG. 6 Arrangement of Apparatus to Test for Reverse Flow

Adjust the flowmeter as necessary to pressurize the valve assembly to 5.0 kPa (50 cm H₂O), inspect the valve for dislocation, and repeat reverse flow test.

12. Optional Components

12.1 Requirements:

12.1.1 Components such as humidifiers, bacterial filters, and respirometers also may be used in the anesthesia breathing system. If these optional components are supplied by the manufacturer of the breathing system, they shall not cause the system to exceed the maximum permitted leakage of the total breathing system. Any manufacturer who sells these devices separately shall disclose in the component labeling the maximum leakage of the device at 3 kPa (30 cm H₂O), its resistance at 0.5 and 1.0 L/s flow, and its compliance at 2.0 and 4.0 kPa (20 and 40 cm H₂O) in a similar manner to those requirements and tests listed in Section 7.

12.1.2 *Flow Direction—Sensitive Components*—Any component or accessory to the breathing system which permits only unidirectional flow (such as PEEP valves and cascade humidifiers) or any device whose correct function depends on the direction of gas flow through it shall be so labeled by the manufacturer, and shall be marked with an arrow indicating the proper direction of flow or the words “inlet” and “outlet,” or both.

12.1.3 *Bag/Ventilator Selector Switch*—The bag/ventilator selector switch shall be designed such that selection of the

ventilator mode automatically excludes the APL valve from the breathing system or closes the valve.

12.2 Test Procedures:

12.2.1 *Leakage, Resistance, and Compliance*—Read the manual or verify by visual inspection, or both.

12.2.2 *Flow Direction-Sensitive Components*—Read the manual, then verify by visual inspection.

12.2.3 *Bag/Ventilator Selector Switch*—Open the APL valve, move the switch to the ventilator mode, and pressurize the breathing system. If the system cannot be pressurized, or if the system loses pressure through the APL valve, the requirement in 12.1.3 is not met.

13. Breathing Tubes

13.1 *Requirements*—Breathing tubes shall comply with the requirements of Specification F 1205.

14. Fresh Gas Inlet and Fresh Gas Supply Tube or Hose

14.1 Requirements:

14.1.1 *Placement*—The fresh gas inlet shall not be placed in segment 1 (from patient to expiratory valve) and should be in segment 3 (from reservoir bag to inspiratory valve) of a circle system.

14.1.2 *Fresh Gas Inlet*—The fresh gas inlet port, or nipple, if provided, should be of a manufacturer-specific design with a nominal inside diameter of at least 4.0 mm (see Fig. 7 for possible designs).

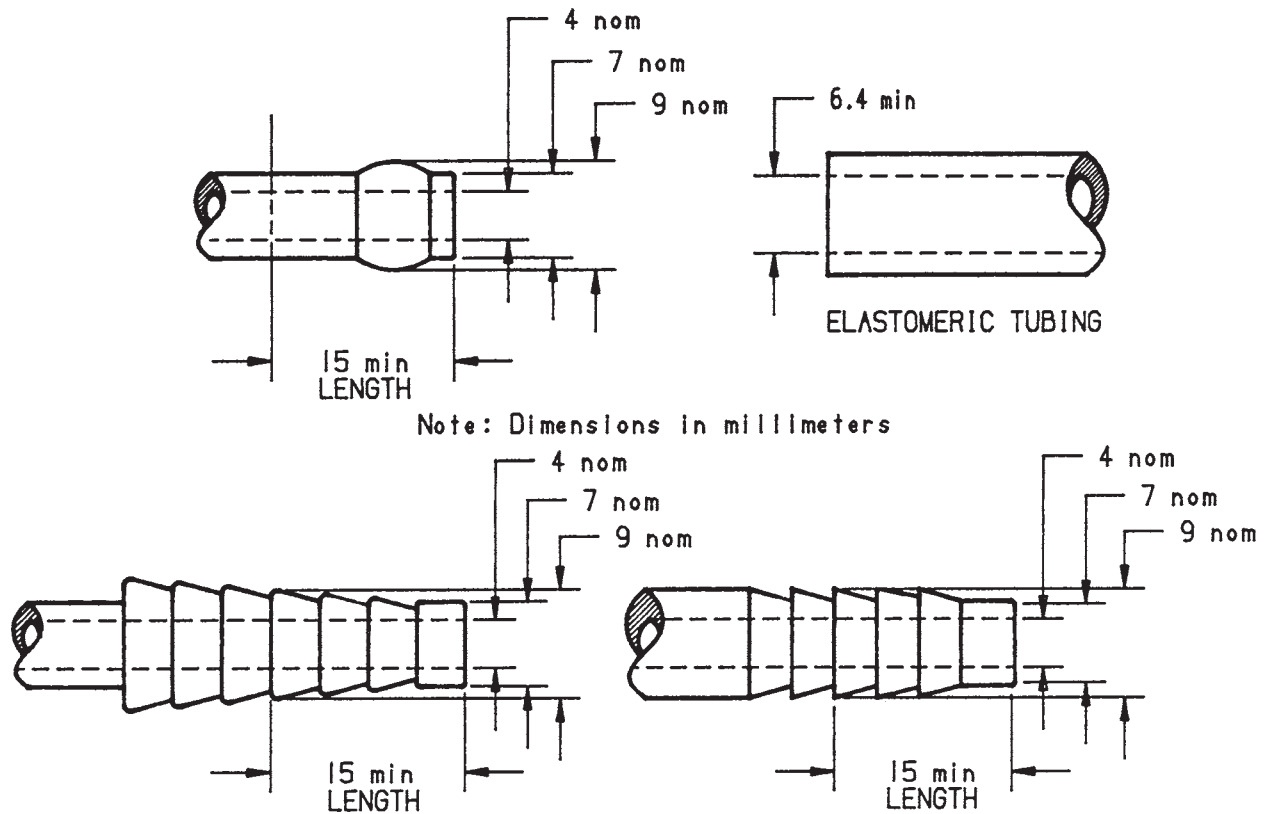

Alternative configurations of the nipple are permissible providing requirements for the basic dimensions are met.

FIG. 7 Examples of Fresh Gas Inlet Nipples

14.1.3 *Fresh Gas Delivery Tube or Hose*—If provided, the fresh gas delivery tubing shall have a nominal inside diameter of at least 6.4 mm and shall have an anesthesia machine end connector that mates to the common gas outlet and a breathing system end connector that mates with the fresh gas inlet.

14.2 *Test Procedures:*

14.2.1 (14.1.1) Verify by visual inspection.

14.2.2 (14.1.3) Verify by measurement that the fresh gas delivery tube or hose has a nominal inside diameter of at least 6.4 mm. Verify by connection and engagement that the anesthesia machine end connector mates with the common gas outlet and the breathing system and connectors mate with the fresh gas inlet.

15. **Connectors**

15.1 Except for the reservoir bag connectors, the 15-mm and 22-mm fittings mentioned in this specification shall comply with Specification F 1054 - 87^{e1}. More specifically, the inspiratory port and the expiratory port (traditionally mounted on the absorber) shall be 22-mm conical male fittings.

16. **Pressure Gauges (Pressure Indicators)**

16.1 Pressure gauges, if provided, shall be marked in units of kilopascals or centimetres H₂O, or both. Bourdon tube type pressure gauges shall conform to the appropriate requirements of ANSI/ASME B40.1M-1985. Units of calibration shall be

marked on the gauge or indicator. The gauges should be easily detachable to permit sterilization of other components of the breathing system.

17. **Y-Pieces and Breathing Tubes**

17.1 The Y-piece and breathing tubes shall comply with the requirements given in Section 7. The patient connection port on the Y-piece shall have a 22-mm male fitting coaxial with the 15-mm female. The Y-piece may be designed so that the 15/22-mm coaxial patient port swivels.

18. **Information in Labeling**

18.1 The following information shall be provided by the manufacturer in the labeling for complete systems—or for components addressed by this specification, if sold separately as original equipment:

18.1.1 Illustration or schematic of total system showing recommended placement of components.

18.1.2 Expiratory resistance of breathing system (as per 7.1.2).

18.1.3 Inspiratory resistance of breathing system (as per 7.1.2).

18.1.4 A statement that the pressure to open moist inspiratory and expiratory valves meets the requirements of 11.1.5.

18.1.5 Volume of gas lost due to internal compliance of the breathing system, or of components (as per 7.1.3).

18.1.6 Leakage of breathing system (as per 7.1.1).

- 18.1.7 Information required by Specification **F 1204**.
- 18.1.8 Information required by Specification **F 1205**.
- 18.1.9 Pressure-flow data for APL valves (as per **8.1.3**).
- 18.1.10 Absorber capacity of CO₂ absorbent in volume (as per **10.1.4**).
- 18.1.11 Resistance of the absorber assembly (as per **10.1.5**).
- 18.1.12 Instructions for changing absorbent (as per **10.1.6**).
- 18.1.13 Instructions for draining absorber assembly.
- 18.1.14 Recommended sterilization method(s) for reusable equipment (as per Section **6**). The manufacturer shall provide the user a method for determining whether a sterilized device retains characteristics for clinical re-use.

18.1.15 Devices that meet the requirements of this specification should be so marked or labeled by the manufacturer, for example, “Meets ASTM Standard Specification for Anesthesia Breathing Systems F1208.”

18.2 Verify any, or all of the above by visual inspection.

19. Keywords

19.1 anesthesia absorber assembly; anesthesia breathing systems; anesthesia breathing system components; (symbols for); anesthesia breathing system pressure gauge; anesthesia circle system

APPENDIX

(Nonmandatory Information)

X1. RATIONALE

X1.1 This appendix gives the rationale on which the requirements of this specification and, where necessary, test methods are based. To the extent possible, it summarizes the discussions of the participants in the meetings of the writing group. What follows is not a continuous text but rather a sequence of annotation to specific sections of the specification. Each rationale statement references the corresponding requirement in parentheses, by requirement number.

X1.1.1 *General*—In many cases the methods of testing and limitations in performance of the components given in this specification are those developed under an FDA-sponsored contract **(1)**,⁵ later modified during committee discussion.

X1.2 *System Classification* (Section **4**)—The circle absorption anesthesia breathing system is designed to:

X1.2.1 Convey the mixture of gases and vapor dispensed by the anesthesia apparatus to the patient.

X1.2.2 Eliminate some or all of the expired CO₂ from the system.

X1.2.3 Minimize atmospheric exposure to waste gases and vapors in anesthetizing locations.

X1.2.4 Minimize resistance to the patients’ spontaneous ventilatory efforts.

X1.2.5 Permit assisted or artificial ventilation.

X1.3 *Sterilization* (Section **6**)—The manufacturer cannot control the number of times a device will be sterilized, nor may he be able to quantitatively predict the effects of sterilization on performance. Therefore the user should at least be provided an operational test to verify that the device is suitable for reuse (even though the device may no longer meet original performance specifications).

X1.4 *Systems* (Section **7**):

X1.4.1 *Leakage of Breathing Systems* (**7.1.1**)—The limit of 300 mL/min for the entire system was established for two reasons (1) to restrict the loss of gas volume intended to be delivered to the patient, and (2) to limit anesthesia gas pollution in the anesthetizing locations. This limit was considered minimally acceptable in view of all the other potential sources of gas leaks. The committee allocated for leaks between the various components of the anesthesia breathing system. The maximum limit of leak (300 mL/min) was based on realistic data, such as found in Ref **(1)**. Individual component limits were established to allow flexibility in design; for example, a design can include a swivel adapter on the Y-piece, a potential source of increased leak, provided the rest of the components or connections, or both, leak minimally. In this case, the tubes plus Y-piece could perform at the maximum permitted leak of 75 mL/min, if the absorber leak is held to less than 225 mL/min and all other components are manufactured to close tolerances.

X1.4.2 *Resistance of the Breathing System* (**7.1.2**)—Total expiratory and total inspiratory resistance were established at a maximum of 0.65 kPa (6.5 cm H₂O) each in order to reduce the work of breathing for the spontaneously breathing patient and to restrict positive end-expiratory pressure. In setting the maximum, the committee considered the resistances of commercially available devices and selected a value between those considered and the ideal of zero resistance. A resistance of 0.65 kPa (6.5 cm H₂O) was considered to be a generally acceptable physiological maximum by clinicians.

X1.4.2.1 Since there are cases where one would require a system with resistance much less than the maximum or require the use of components that would increase the resistance above the maximum, the requirement for disclosure of the actual system’s resistances was included to provide information for informed use.

X1.4.3 *Volume of Gas Lost Due to Internal Compressible Volume* (**7.1.3**)—It is important when providing a patient with artificial ventilation to know the volume of gas *actually* delivered to the patient’s lungs. Gas will be compressed within

⁵ The boldface numbers in parentheses refer to the references at the end of this standard.

both the rigid and distensible components as the pressure rises. To provide the user with a guide to the additional volume of ventilation required, compliance data is required to be stated at the commonly achieved pressures of 2.0 kPa and 4.0 kPa (20 cm H₂O and 40 cm H₂O).

X1.4.4 Monitoring Requirements (7.1.4)—It is important when administering anesthesia to be able to monitor the oxygen concentration, breathing pressure, and either exhaled volume or expiratory CO₂. Knowledge of oxygen concentration whenever the machine is in use is required for the safe administration of anesthesia and cannot be obtained without appropriate ports for gas sampling within the breathing circuit. It is equally essential for safe anesthesia to have sampling sites available to monitor “continuing pressure” and “high pressure” as mentioned in the anesthesia gas machine standard as well as sampling for monitoring either exhaled volume or ventilatory carbon dioxide. The reasons for this are as follows: excessive high airway pressure, or prolonged airway pressure may impede venous return, drop cardiac output, interfere with ventilation or cause barotrauma (for example, pneumothorax). The varying physical condition of patients or different disease processes will affect the susceptibility of a given patient to high airway pressure or continuing airway pressure. Monitoring ventilation by the use of exhaled volume or ventilatory CO₂ will aid in detecting inadvertent changes in ventilation caused by malfunction or disconnections within the breathing system. In addition measurement of exhaled CO₂ will provide evidence of alveolar hypoventilation, metabolic changes such as malignant hyperthermia, esophageal intubation, and pulmonary embolic phenomena.

X1.5 APL Valves (Section 8):

X1.5.1 Placement (8.1.1)—An open APL valve in segment 4 permits free return of exhaled gas into the inspiratory pathway with subsequent rebreathing.

X1.5.1.1 An APL valve in segment 2 or opposite the reservoir bag, with the fresh gas inflow and absorber in segment 3, will facilitate the removal of the maximum amount of CO₂—containing expired gas by permitting the retrograde flow of fresh gas during expiration. This will minimize exhaustion of the absorbent use and conserve fresh gas for delivery to the patient.

X1.5.2 Pressure-Flow Characteristics (8.1.3)—The authors of the breathing system study (1) stated that the APL valve was a component that has a significant effect on CO₂ elimination, work of breathing, and inadvertent positive end-expiratory pressure. Information on its function is paramount for patient safety. It was thus required that the resistance of the valve at different flows and valve settings be stated in the labeling.

X1.5.3 Direction of Motion (8.1.4)—Since rotary flow control valves are typically closed by clockwise rotation, the committee felt it necessary to standardize this to prevent inappropriate valve adjustment.

X1.5.4 Resistance at Low Flow (8.1.5)—The valve must offer some resistance at low flow in order to create a small positive pressure to keep the anesthesia reservoir bag from collapsing.

X1.5.5 Resistance at High Flow (8.1.6)—Valve resistance, although it must be present to keep the reservoir bag from collapsing, it must not be so high as to impede emptying of the lung.

X1.6 Reservoir Bags (Section 9):

X1.6.1 Placement (9.1.1)—A reservoir bag on the patient side of either unidirectional valve will fill with exhaled gas, which will be rebreathed on subsequent inhalation.

X1.6.2 (9.1.2) Previous experience has shown that the reservoir bag connection using a standard 22-mm male conical fitting did not always provide for a secure attachment of the reservoir bag to the reservoir bag connector. For this reason, it was decided to allow variations in designs centered around a nominal 22-mm outside diameter dimension.

X1.7 CO₂ Absorbers (Section 10):

X1.7.1 Placement (10.1.1)—An absorber in segment 1 will be exposed to CO₂-laden, exhaled, gas which normally would be partially expelled from the system before reaching the absorber, thereby wasting absorbent. An absorber at the patient end of segment 4 offers the likeliest possibility of absorbent dust being delivered to the patient.

X1.7.2 CO₂ Absorbent Container (10.1.2)—It is desirable to see the actual absorbent material to determine color change in order to know when to replace spent absorbent.

X1.7.3 Drain (10.1.3)—Water is produced during the process of CO₂ absorption.

X1.7.4 Absorbent Capacity (10.1.4)—After taking into account other factors (such as gas flows, minute volume, and breathing system arrangement), the user can utilize these pieces of information to make an intelligent estimate of how long the absorbent charge will last.

X1.7.5 Resistance— See **X1.4.2**.

X1.7.6 Instruction (10.1.6)—Instructions for proper use, such as changing the absorbent, sterilization of the assembly, and obtaining a gas-tight seal, are necessary to ensure correct functioning.

X1.7.7 Prefilled Container (10.1.7)—Failure to remove the wrapper from prefilled containers has resulted in lack of CO₂ absorption or total obstruction of the breathing system, or both.

X1.8 Unidirectional Valves (Section 11):

X1.8.1 Placement (11.1.1)—A Y-piece with valves could be placed in reverse orientation to another set of unidirectional valves on an absorber, making ventilation impossible.

X1.8.2 Flow Direction (11.1.3)—Direction of flow markings reduce the possibility of incorrect placement of the valve and harm to the patient.

X1.8.3 Resistance (11.1.4)—Maximum resistance was set in order to limit the work of breathing for the spontaneously breathing patient. In setting the maximum, the committee considered the resistances of commercially available devices and selected a value between those considered and the ideal of zero resistance. (Also read the rationale in **X1.4.2**.) Testing of a dry valve is not necessary since valve resistance is always greater when a valve is moist.

X1.8.4 *Opening Pressure (11.1.5)*—The pressure to open moist unidirectional valves may be higher than that to open dry valves. The value is chosen to limit the work of breathing (also see X1.8.3).

X1.8.5 *Reverse Flow and Dislocation (11.1.6)*—Reverse flow, dislocation, or incompetence of inspiratory or expiratory valves could result in rebreathing of end-expiratory gases and a reduction of CO₂ elimination. The most significant leak with disk-type valves may be at low pressures, whereas with flapper valves, the most significant leak may be closer to a pressure of 0.5 kPa (5.0 cm H₂O). A60-mL/min reverse flow was considered clinically acceptable, and obtainable using current manufacturing techniques. This flow is detectable by currently available volume monitors.

X1.8.6 *Sterilization (11.1.7)*—For reusable valves, this information is necessary in order not to damage the valves.

X1.9 *Optional Components (Section 12)*—This requirement is an attempt to deal with breathing systems that may include various components supplied by the system manufacturer, or other manufacturers, or both. The basic system leakage and resistance requirements (7.1.1 and 7.1.2) are for a defined set of components. If other components are included in the breathing system, or are sold for use in breathing systems, it is recommended that their leakage be considered in regard to the overall system leakage and that resistance values be disclosed to the user.

X1.9.1 *Flow Direction-Sensitive Components (12.1.2)*—Reverse connection of a flow direction-sensitive component may result in no flow to or from the patient. An example would be the reverse connection of a cascade humidifier. The same situation could arise if a circulator were connected backwards in a breathing system so that flow from the circulator was directed toward the patient exhalation port. Also when the sensor of a pressure alarm is located downstream from the expiratory valve (segments 2 and 3), a low pressure alarm may not be activated despite zero pressure at the Y-piece, since substantial pressure is generated at the sensor with each positive pressure breath. See Refs (2-5).

X1.9.2 *Bag/Ventilator Selector Switch (12.1.3)*—Failure of the operator to manually close the APL valve (in the ventilator mode) has resulted in inadequate ventilation. Pressure alarms with relatively low thresholds (such as 8 cm of water) may be

satisfied despite a substantial leak out the APL valve with each positive pressure breath. See Ref (6).

X1.10 *Fresh Gas Inlet and Fresh Gas Supply Tube (Section 14)*:

X1.10.1 *Placement (14.1.1)*—If the fresh gas inlet is placed in segment 1, loss of between fresh gas through the APL valve will occur. If the fresh gas inlet is placed between the expiratory valve and the absorber, the humidification of the fresh gas mixture will be enhanced; however, with this arrangement loss of fresh gas through the APL valve may occur if the latter is not placed at a sufficient distance from the fresh gas inlet. Placement in segment 4 vents that fresh gas flow which passes by the Y-piece during exhalation. This prevents the use of a spirometer in the exhalatory limb of the breathing system. Placement in segment 3 provides greater overall economy of the anesthetic agent and CO₂ absorbent.

X1.10.2 *Fresh Gas Inlet (14.1.2)*—The use of a manufacturer-specific fresh gas inlet would minimize the potential hazard of mismatching breathing systems and gas machines, and also prevents potentially dangerous increases in pressure behind (proximal to) the fresh gas inlet.

X1.10.3 *Fresh Gas Delivery Tube or Hose (14.1.3)*—Same as X1.10.2.

X1.11 *Connectors (Section 15)*—See X1.6.2.

X1.12 *Pressure Gauges or Indicators (Section 16)*—Consistent scale marking will reduce reading errors. Gauges are easily damaged by current methods of sterilization.

X1.13 *Y-Pieces (Section 17)* (see X1.5.1.1)—A 15/22-mm coaxial patient fitting on the Y-piece is mandatory to permit connection of the breathing system to either a mask or a tracheal tube.

X1.14 *Information in Manual (Section 18)*—The initial statement is written to require that manufacturers of complete breathing systems, and manufacturers of components sold separately, provide the information with the original sales of equipment and components but *not* with replacement parts. This information permits the user to reasonably predict the performance of a total breathing system even though the component parts may have been obtained from different manufacturers.



REFERENCES

- (1) Saklad, M., et al, Final Report FDA Contract No. 223-76-5021, "Testing and Evaluating the Characteristics and Arrangements of Components in the Gas Conduction System of Continuous-Flow Anesthesia Machines," 1978.
- (2) Schreiber, P., *Safety Guidelines for Anesthesia Systems*, Telford, PA: North American Drager, 1985, p. 34.
- (3) Rendell-Baker, L., "Problems With Anesthetic and Respiratory Therapy Equipment," *International Anesthesiology Clinic*, fall 1982; 20: 3, p. 60.
- (4) Dorsch, J. A., Dorsch, S. E., *Understanding Anesthesia Equipment*, Second Edition, Williams and Wilkins, Baltimore, 1984, p. 157.
- (5) Andrews, J. J., "Anesthesia Systems," Barash, P. G., Cullen, B. F., Stoelting, R. K., eds. *Clinical Anesthesia*, Philadelphia, J. B. Lippincott, in press.
- (6) Dorsch, J. A., Dorsch, S. E., *Understanding Anesthesia Equipment*, Second Edition, Williams and Wilkins, Baltimore, 1984, pp. 303 and 306.

ASTM International takes no position respecting the validity of any patent rights asserted in connection with any item mentioned in this standard. Users of this standard are expressly advised that determination of the validity of any such patent rights, and the risk of infringement of such rights, are entirely their own responsibility.

This standard is subject to revision at any time by the responsible technical committee and must be reviewed every five years and if not revised, either reapproved or withdrawn. Your comments are invited either for revision of this standard or for additional standards and should be addressed to ASTM International Headquarters. Your comments will receive careful consideration at a meeting of the responsible technical committee, which you may attend. If you feel that your comments have not received a fair hearing you should make your views known to the ASTM Committee on Standards, at the address shown below.

This standard is copyrighted by ASTM International, 100 Barr Harbor Drive, PO Box C700, West Conshohocken, PA 19428-2959, United States. Individual reprints (single or multiple copies) of this standard may be obtained by contacting ASTM at the above address or at 610-832-9585 (phone), 610-832-9555 (fax), or service@astm.org (e-mail); or through the ASTM website (www.astm.org).