



Designation: E384 – 17

# Standard Test Method for Microindentation Hardness of Materials<sup>1</sup>

This standard is issued under the fixed designation E384; the number immediately following the designation indicates the year of original adoption or, in the case of revision, the year of last revision. A number in parentheses indicates the year of last reapproval. A superscript epsilon ( $\epsilon$ ) indicates an editorial change since the last revision or reapproval.

*This standard has been approved for use by agencies of the U.S. Department of Defense.*

## 1. Scope\*

1.1 This test method covers determination of the microindentation hardness of materials.

1.2 This test method covers microindentation tests made with Knoop and Vickers indenters under test forces in the range from  $9.8 \times 10^{-3}$  to 9.8 N (1 to 1000 gf).

1.3 This test method includes an analysis of the possible sources of errors that can occur during microindentation testing and how these factors affect the precision, bias, repeatability, and reproducibility of test results.

1.4 Information pertaining to the requirements for direct verification and calibration of the testing machine and the requirements for the manufacture and calibration of Vickers and Knoop reference hardness test blocks are in Test Method E92.

NOTE 1—While Committee E04 is primarily concerned with metals, the test procedures described are applicable to other materials.

1.5 *Units*—The values stated in SI units are to be regarded as standard. No other units of measurement are included in this standard.

1.6 *This standard does not purport to address all of the safety concerns, if any, associated with its use. It is the responsibility of the user of this standard to establish appropriate safety and health practices and determine the applicability of regulatory limitations prior to use.*

1.7 *This international standard was developed in accordance with internationally recognized principles on standardization established in the Decision on Principles for the Development of International Standards, Guides and Recommendations issued by the World Trade Organization Technical Barriers to Trade (TBT) Committee.*

<sup>1</sup> This test method is under the jurisdiction of ASTM Committee E04 on Metallography and is the direct responsibility of Subcommittee E04.05 on Microindentation Hardness Testing. With this revision the test method was expanded to include the requirements previously defined in E28.92, Standard Test Method for Vickers Hardness Testing of Metallic Material that was under the jurisdiction of E28.06

Current edition approved June 1, 2017. Published August 2017. Originally approved in 1969. Last previous edition approved in 2016 as E384 – 16. DOI: 10.1520/E0384-17

## 2. Referenced Documents

### 2.1 ASTM Standards:<sup>2</sup>

C1326 Test Method for Knoop Indentation Hardness of Advanced Ceramics

C1327 Test Method for Vickers Indentation Hardness of Advanced Ceramics

E3 Guide for Preparation of Metallographic Specimens

E7 Terminology Relating to Metallography

E92 Test Method For Vickers Hardness of Metallic Materials

E140 Hardness Conversion Tables for Metals Relationship Among Brinell Hardness, Vickers Hardness, Rockwell Hardness, Superficial Hardness, Knoop Hardness, Scleroscope Hardness, and Leeb Hardness

E175 Terminology of Microscopy

E177 Practice for Use of the Terms Precision and Bias in ASTM Test Methods

E691 Practice for Conducting an Interlaboratory Study to Determine the Precision of a Test Method

E766 Practice for Calibrating the Magnification of a Scanning Electron Microscope

E1268 Practice for Assessing the Degree of Banding or Orientation of Microstructures

E2554 Practice for Estimating and Monitoring the Uncertainty of Test Results of a Test Method Using Control Chart Techniques

E2587 Practice for Use of Control Charts in Statistical Process Control

### 2.2 ISO Standard:<sup>3</sup>

ISO/IEC 17025 General Requirements for the Competence of Testing and Calibration Laboratories

## 3. Terminology

3.1 *Definitions*—For definitions of terms used in this test method, see Terminology E7.

### 3.2 *Definitions of Terms Specific to This Standard:*

<sup>2</sup> For referenced ASTM standards, visit the ASTM website, www.astm.org, or contact ASTM Customer Service at service@astm.org. For *Annual Book of ASTM Standards* volume information, refer to the standard's Document Summary page on the ASTM website.

<sup>3</sup> Available from International Organization for Standardization (ISO), 1, ch. de la Voie-Creuse, Case postale 56, CH-1211, Geneva 20, Switzerland, http://www.iso.org.

\*A Summary of Changes section appears at the end of this standard

3.2.1 *calibrating*, *v*—determining the values of the significant parameters by comparison with values indicated by a reference instrument or by a set of reference standards.

3.2.2 *Knoop hardness number, HK, n*—an expression of hardness obtained by dividing the force applied to the Knoop indenter by the projected area of the permanent impression made by the indenter.

3.2.3 *Knoop indenter, n*—a rhombic-based pyramidal-shaped diamond indenter with edge angles of  $\angle A = 172^\circ 30'$  and  $\angle B = 130^\circ 0'$  (see Fig. 1).

3.2.4 *microindentation hardness test, n*—a hardness test using a calibrated machine to force a diamond indenter of specific geometry into the surface of the material being evaluated, in which the test forces range from 1 to 1000 gf ( $9.8 \times 10^{-3}$  to 9.8 N), and the indentation diagonal, or diagonals, are measured with a light microscope after load removal; for any microindentation hardness test, it is assumed that the indentation does not undergo elastic recovery after force removal.

NOTE 2—Use of the term microhardness should be avoided because it implies that the hardness, rather than the force or the indentation size, is very low.

3.2.5 *verifying*, *v*—checking or testing the instrument to assure conformance with the specification.

3.2.6 *Vickers hardness number, HV, n*—an expression of hardness obtained by dividing the force applied to a Vickers indenter by the surface area of the permanent impression made by the indenter.

3.2.7 *Vickers indenter, n*—a square-based pyramidal-shaped diamond indenter with face angles of  $136^\circ$  (see Fig. 2).

3.3 *Formulae*—The formulae presented in 3.3.1 – 3.3.4 for calculating microindentation hardness are based upon an ideal tester and conditions. The measured value of the microindentation hardness of a material is subjected to several sources of errors. Based on Eq 1-9, variations in the applied force,

geometrical variations between diamond indenters, and human errors in measuring indentation lengths will affect the precision of the calculated material hardness. The magnitude of the error that variations of each of these parameters have on the calculated value of a microindentation measurement is discussed in Section 10.

3.3.1 For Knoop hardness tests, in practice, test loads are in grams-force and indentation diagonals are in micrometers. The Knoop hardness number is calculated using the following:

$$HK = 1.000 \times 10^3 \times (P/A_p) = 1.000 \times 10^3 \times P/(c_p \times d^2) \quad (1)$$

or

$$HK = 14229 \times P/d^2 \quad (2)$$

$$c_p = \frac{\tan \frac{\angle B}{2}}{2 \tan \frac{\angle A}{2}} \quad (3)$$

where:

- $P$  = force, gf,
- $d$  = length of long diagonal,  $\mu\text{m}$ ,
- $A_p$  = projected area of indentation,  $\mu\text{m}^2$
- $\angle A$  = included longitudinal edge angle,  $172^\circ 30'$
- $\angle B$  = included transverse edge angle,  $130^\circ 0'$  (see Fig. 1 and,
- $c_p$  = indenter constant relating projected area of the indentation to the square of the length of the long diagonal, ideally 0.07028.

3.3.2 The Knoop hardness,  $\text{kgf}/\text{mm}^2$  is determined as follows:

$$HK = 14.229 \times P_1/d_1^2 \quad (4)$$

where:

- $P_1$  = force, kgf, and
- $d_1$  = length of long diagonal, mm.

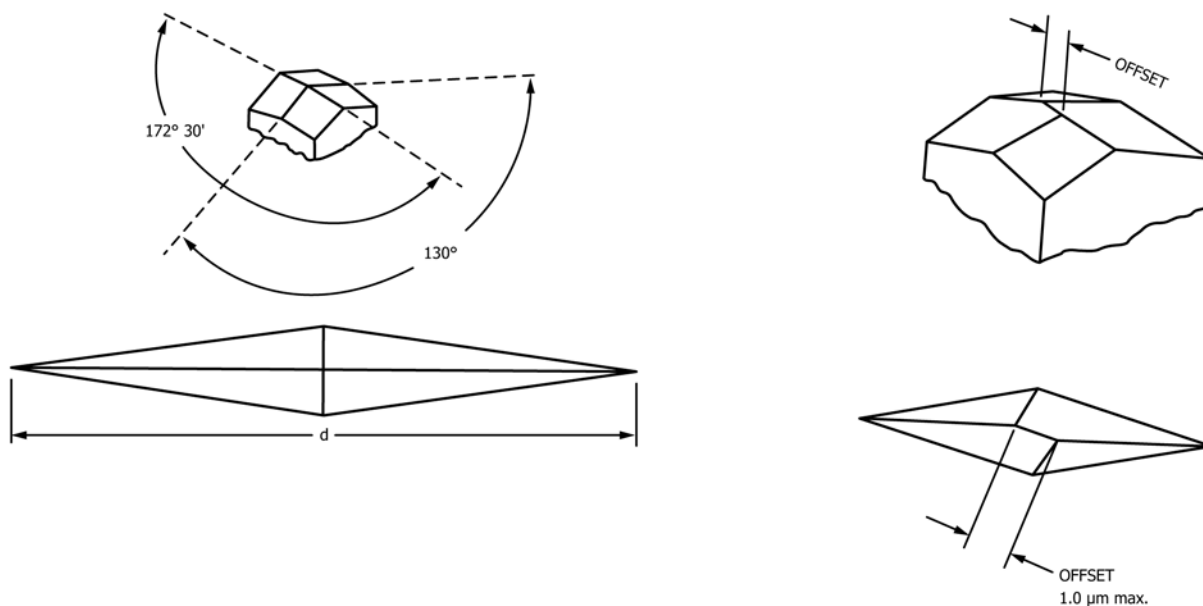

FIG. 1 Knoop Indenter

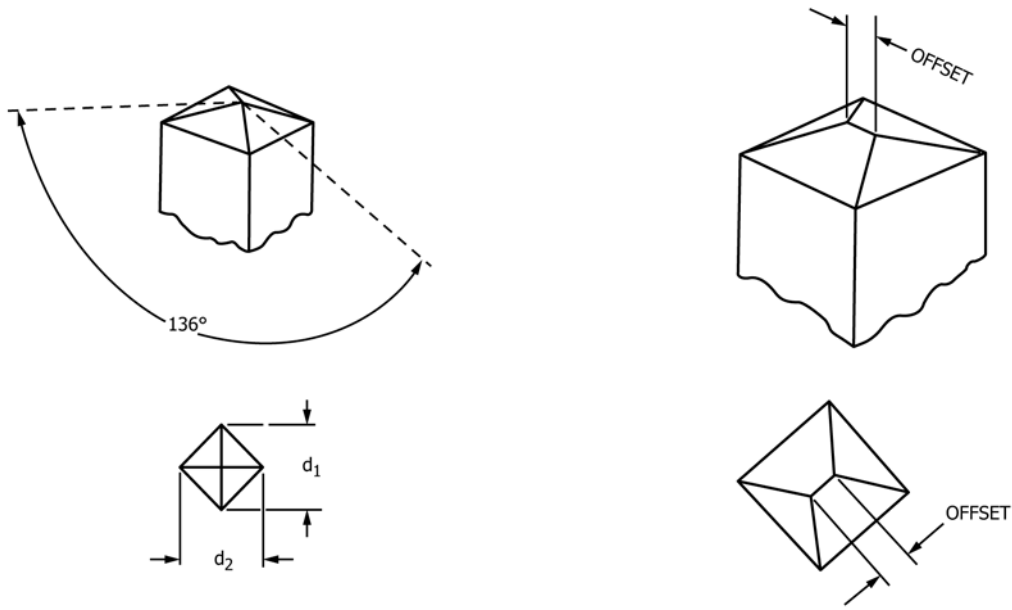

FIG. 2 Vickers Indenter

3.3.3 The Knoop hardness reported with units of GPa is determined as follows:

$$HK = 0.014229 \times P_2/d_2^2 \quad (5)$$

where:

$P_2$  = force, N, and  
 $d_2$  = length of the long diagonal of the indentation, mm.

3.3.4 For the Vickers hardness test, in practice, test loads are in grams-force and indentation diagonals are in micrometers. The Vickers hardness number is calculated as follows:

$$HV = 1.000 \times 10^3 \times P/A_s = 2.000 \times 10^3 \times P \sin(\alpha/2)/d^2 \quad (6)$$

or

$$HV = 1854.4 \times P/d^2 \quad (7)$$

where:

$P$  = force, gf,  
 $A_s$  = surface area of the indentation,  $\mu\text{m}^2$ ,  
 $d$  = mean diagonal length of the indentation,  $\mu\text{m}$ , and  
 $\alpha$  = face angle of the indenter,  $136^\circ 0'$  (see Fig. 2).

3.3.5 The Vickers hardness,  $\text{kgf}/\text{mm}^2$  is determined as follows:

$$HV = 1.8544 \times P_1/d_1^2 \quad (8)$$

where:

$P_1$  = force, kgf, and  
 $d_1$  = mean diagonal length of the indentations, mm.

3.3.6 The Vickers hardness reported with units of GPa is determined as follows:

$$HV = 0.0018544 \times P_2/d_2^2 \quad (9)$$

where:

$P_2$  = force, N, and  
 $d_2$  = mean diagonal length of the indentations, mm.

3.4 Equations for calculating % Error and Repeatability for periodic verification is determined as follows:

$$E = 100 \left( \frac{\bar{d} - d_{ref}}{d_{ref}} \right) \quad (10)$$

where:

$E$  = % error in performance of the periodic verification,  
 $\bar{d}$  = the measured mean diagonal length in  $\mu\text{m}$ , and  
 $d_{ref}$  = the reported certified mean diagonal length,  $\mu\text{m}$ .

$$R = 100 \left( \frac{d_{max} - d_{min}}{\bar{d}} \right) \quad (11)$$

where:

$R$  = repeatability in performance of the periodic verification,  
 $d_{max}$  = the longest diagonal length measurement on the standardized test block,  $\mu\text{m}$ ,  
 $d_{min}$  = the shortest diagonal length measurement on the standardized test block,  $\mu\text{m}$ , and  
 $\bar{d}$  = the measured mean diagonal length in  $\mu\text{m}$ .

#### 4. Summary of Test Method

4.1 In this test method, a hardness number is determined based on the formation of a very small indentation by application of a relatively low force, in comparison to traditional bulk indentation hardness tests.

4.2 A Knoop or Vickers indenter, made from diamond of specific geometry, is pressed into the test specimen surface under an applied force in the range of 1 to 1000 gf using a test machine specifically designed for such work.

4.3 The size of the indentation is measured using a light microscope equipped with a filar type eyepiece, or other type of measuring device (see Terminology E175).

4.4 The Knoop hardness number is based upon the force divided by the projected area of the indentation. The Vickers hardness number is based upon the force divided by the surface area of the indentation.

4.5 It is assumed that elastic recovery does not occur when the indenter is removed after the loading cycle, that is, it is assumed that the indentation retains the shape of the indenter after the force is removed, but this is not always true. In Knoop testing, it is assumed that the ratio of the long diagonal to the short diagonal of the impression is the same as for the indenter, 7.114, but this is not always true due to elastic recovery.

## 5. Significance and Use

5.1 Hardness tests have been found to be very useful for materials evaluation, quality control of manufacturing processes and research and development efforts. Hardness, although empirical in nature, can be correlated to tensile strength for many metals and alloys, and is also an indicator of machinability, wear resistance, toughness and ductility.

5.2 Microindentation tests are utilized to evaluate and quantify hardness variations that occur over a small distance. These variations may be intentional, such as produced by localized surface hardening, for example, from shot blasting, cold drawing, flame hardening, induction hardening, etc., or from processes such as carburization, nitriding, carbonitriding, etc.; or, they may be unintentional variations due to problems, such as decarburization, localized softening in service, or from compositional/microstructural segregation problems. Low test forces also extend hardness testing to materials too thin or too small for macroindentation tests. Microindentation tests permit hardness testing of specific phases or constituents and regions or gradients too small for evaluation by macroindentation tests.

5.3 Because microindentation hardness tests will reveal hardness variations that commonly exist within most materials, a single test value may not be representative of the bulk hardness. Vickers tests at 1000 gf can be utilized for determination of the bulk hardness, but, as for any hardness test, it is recommended that a number of indents are made and the average and standard deviation are calculated, as needed or as required.

5.4 Microindentation hardness testing is generally performed to quantify variations in hardness that occur over small distances. To determine these differences requires a very small physical indentation. Testers that create indents at very low test forces must be carefully constructed to accurately apply the test forces exactly at the desired location and must have a high-quality optical system to precisely measure the diagonal (or diagonals) of the small indents. Test forces in the upper range of the force range defined in 1.2 may be used to evaluate bulk hardness. In general, the Vickers indenter is better suited for determining bulk (average) properties as Vickers hardness is not altered by the choice of the test force, from 25 to 1000 gf, because the indent geometry is constant as a function of indent depth. The Knoop indentation, however, is not geometrically identical as a function of depth and there will be variations in Knoop hardness, particularly at test forces <200 gf, over the force range defined in 1.2 (and above this range); consequently,

Knoop hardness is not normally used to define bulk hardness, except at 500 gf where E140 gives conversions to other test scales, and Knoop tests should not be performed at test forces above 1000 gf. The majority of Knoop tests of case hardness variations are conducted at forces from 100 to 500 gf. If the test is being conducted to meet a specified bulk hardness value, such as HRC, then most such tests will be conducted with Knoop at a 500 gf load. Because of the large difference between the long and short Knoop diagonals, the Knoop indenter is often better suited for determining variations of hardness over very small distances compared to the Vickers indenter. Vickers and Knoop tests at forces  $\leq 25$  gf are susceptible to imprecision due to the difficulty in measuring extremely small indents ( $<20 \mu\text{m}$ ) by light microscopy with high precision and reproducibility. Tests made at forces  $\leq 25$  gf should be considered to be qualitative in nature. Likewise, test forces that create indents  $<20 \mu\text{m}$  in length should be avoided whenever possible and should be considered to be qualitative in nature. The success of the specimen preparation procedure in removing preparation-induced damage can, and will, influence test results; this problem becomes more critical as the test force decreases.

## 6. Apparatus

6.1 *Test Machine*—The test machine must support the test specimen and control the movement of the indenter into the specimen under a preselected test force, and should have a light optical microscope to select the desired test locations and to measure the size of the indentations produced by the test. The plane of the surface of the test specimen must be perpendicular to the axis of the indenter and the direction of the force application. The plane of the test specimen surface must be flat, and free of surface relief, in order to obtain valid, usable test data. The hardness test machine must meet the verification requirements defined in Test Method E92.

6.1.1 *Force Application*—The test machine shall be capable of applying the test forces according to the following:

6.1.1.1 The time from the initial application of the force until the full test force is reached shall not exceed 10 s.

6.1.1.2 The indenter shall contact the specimen at a velocity between 15 and 70  $\mu\text{m/s}$ . Indenter velocity is not usually adjustable by the user.

6.1.1.3 The full test force shall be applied for 10 to 15 s unless otherwise specified.

6.1.1.4 For some applications it may be necessary to apply the test force for longer times. In these instances the tolerance for the time of the applied force is  $\pm 2$  s.

6.1.2 *Vibration Control*—During the entire test cycle, the test machine should be protected from shock or vibration. To minimize vibrations, the operator should avoid contacting the machine, or the support table, in any manner during the entire test cycle.

6.2 *Vickers Indenter*—The Vickers indenter normally produces geometrically-similar indentation shapes at all test forces. Except for tests at very low forces that produce indentations with diagonals smaller than about 20  $\mu\text{m}$ , the Vickers hardness number will be the same, within statistical precision limits, as produced using test forces that produce

diagonal lengths  $\geq 20 \mu\text{m}$ , using either a microindentation test machine up to 1000 gf or a macroindentation test machine with test forces  $\geq 1 \text{ kgf}$ , as long as the material being tested is reasonably homogeneous and the magnification and image quality are optimal (see [Appendix X4](#)). For isotropic materials, the two diagonals of a Vickers indentation are equal in size. Metals/alloys with preferred crystallographic textures may produce distorted indents and invalid or questionable test results. The Vickers indenter must meet the verification requirements defined in Test Method [E92](#).

6.2.1 The ideal Vickers indenter is a highly polished, pointed, square-based pyramidal diamond with face angles of  $136^\circ 0'$ . The effect that geometrical variations of these angles have on the measured values of Vickers hardness is discussed in Section [10](#).

6.2.2 The four faces of the Vickers indenter shall be equally inclined to the axis of the indenter (within  $\pm 30'$ ) and shall meet at a sharp point. The line of junction between opposite faces (offset) shall be not more than  $0.5 \mu\text{m}$  in length as shown in [Fig. 2](#).

6.3 *Knoop Indenter*—The Knoop indenter does not produce geometrically-similar indentation shapes as a function of test force and indent depth. Consequently, the Knoop hardness will vary with test force (see [Appendix X4](#)). Due to its rhombic shape, the indentation depth is shallower for a Knoop indentation compared to a Vickers indentation under identical test conditions. But, for the same test force, the Knoop long diagonal will be substantially longer than the mean of the two Vickers diagonals. The two diagonals of a Knoop indentation are markedly different. Ideally, the long diagonal is 7.114 times longer than the short diagonal, but this ratio is influenced by elastic recovery. Because of its shape, the Knoop indenter is very useful for evaluating hardness gradients or thin coatings. The Knoop test is not recommended for use above a 1 kgf test load. The Knoop indenter must meet the verification requirements defined in Test Method [E92](#).

6.3.1 The Knoop indenter is a highly polished, pointed, rhombic-based, pyramidal diamond **(1)**.<sup>4</sup> The ideal included longitudinal edge angles are  $172^\circ 30'$  and  $130^\circ 0'$ . The ideal indenter constant,  $c_p$ , is 0.07028. The effect that geometrical variations of these angles have on the measured values of Knoop hardness is discussed in Section [10](#).

6.3.2 The four faces of the Knoop indenter shall be equally inclined to the axis of the indenter (within  $\pm 30'$ ) and shall meet at a sharp point. The line of junction between opposite faces (offset) shall be not more than  $1.0 \mu\text{m}$  in length for indentations greater than  $20 \mu\text{m}$  in length, as shown in [Fig. 1](#). For shorter indentations, the offset should be proportionately less.

6.3.3 Indenters should be examined periodically and replaced if they become worn, dulled, chipped, cracked or separated from the mounting material. Never touch the indenter tip with your finger.

6.4 *Measuring Equipment*—The test machine's measuring device should report the diagonal lengths in  $0.1 \mu\text{m}$  increments for indentations with diagonals from 1 to  $200 \mu\text{m}$ .

NOTE 3—This is the reported length and not the resolution of the system used for performing the measurements. As an example, if a length of  $200 \mu\text{m}$  corresponds to 300 filar units or pixels, the corresponding calibration constant would be  $200/300 = 0.66666667$ . This value would be used to compute diagonal lengths, but the reported length would only be reported to the nearest  $0.1 \mu\text{m}$ .

6.4.1 The optical portion of the measuring device should utilize Köhler illumination. Consult the manufacturer's instruction manual for the adjustments that can be made on your tester.

6.4.2 To obtain maximum resolution, the measuring microscope should have high quality objectives with adequate numerical apertures, a suitable eyepiece, adjustable illumination intensity, adjustable alignment and aperture and field diaphragms. These are adjusted in the same manner as on a reflected light microscope or metallograph. Some systems are now designed using computer monitors and indent length detection by image analysis and may not utilize a traditional eyepiece, but have a projection lens connected to a CCD camera. While a traditional eyepiece has a circular field of view, the computer monitor is rectangular and its height-to-width ratio can vary.

6.4.3 Magnifications should be provided so that the diagonal can be enlarged to greater than 25 % but less than 75 % of the field width. If the computer screen has a 4 to 3 ratio of width to height, or a greater difference between the screen width and height, the maximum field height must be  $<75\%$  of the width to measure both Vickers diagonals. A  $40\times$  or  $50\times$  objective may not be adequate for precise measurement of indents  $<30 \mu\text{m}$  in length. Measurements of diagonal lengths  $<20 \mu\text{m}$  in length with the light microscope may be imprecise, regardless of the objective magnification used, with the problem becoming more acute as the diagonal length decreases below  $20 \mu\text{m}$ .

## 7. Test Specimen

7.1 For optimum accuracy of measurement, the test should be performed on a flat specimen with a polished surface free of preparation-induced damage. The surface must be free of any problems that could affect the indentation or the subsequent measurement of the diagonals. Conducting tests on non-planar surfaces is not recommended. Results will be affected even in the case of the Knoop test where the radius of curvature is in the direction of the short diagonal.

7.1.1 In all tests, the indentation perimeter, and the indentation tips in particular, must be clearly defined in the microscope field of view.

7.1.2 For best results, the specimen surface should not be etched before making an indentation **(2)**, although etching is often necessary to aid indent location. Deeply etched surfaces will obscure the edge of the indentation, making an accurate measurement of the size of the indentation difficult or impossible. When determining the microindentation hardness of an isolated phase or constituent, or when evaluating segregated compared to non-segregated areas, and other similar situations, a light etch is required to delineate the object or area of interest

<sup>4</sup> The boldface numbers in parentheses refer to the list of references at the end of this standard.

so that the indentations can be placed in the desired locations. The necessary quality of the required surface preparation does vary with the forces and magnifications used in microindentation hardness testing. The lighter the force and the smaller the indentation size, the more critical is the surface preparation. Some materials are more sensitive to preparation-induced damage than others. In general, face-centered cubic metals (for example, austenitic stainless steels, copper and its alloys, nickel and its alloys, gold and silver) exhibit a larger deformation field around the indent than an indent of the same test force made in a body-centered cubic metal (for example, ferritic and martensitic steels).

7.1.3 Due to the small size of the indentations, special precautions must be taken during specimen preparation. It is well known that improper preparation can alter test results. Specimen preparation must remove any damage introduced during these steps, either due to excessive heating or cold work, for example.

7.1.4 Specimen preparation should be performed in accordance with Guide E3.

7.2 In many instances, it is necessary to mount the specimen for convenience in preparation and for best edge retention. When mounting is required, the specimen must be adequately supported by the mounting medium so that the specimen does not move during force application, such as might happen in an improperly cured polymer mount.

## 8. Procedure

8.1 Turn on the illumination system and power for the tester.

8.2 Select the desired indenter. If it is necessary to physically change indenters, refer to the manufacturer's instructions. With some machines, both indenters can be mounted on the turret and changed by a simple switch or computer command. Occasionally clean the indenter with a cotton swab and alcohol. Avoid creating static charges during cleaning. Never touch the indenter tip with your fingers as this will alter the measurements.

8.3 Place the specimen on the stage or in the stage clamps, so that the specimen surface is perpendicular to the indenter axis. A top-referenced clamping system for mounts is an excellent device for aligning the test plane perpendicular to the indenter, particularly if the back face of the mount is not parallel to the polished front surface. If clay is used on a slide, use very stiff clay and use high pressure when seating the specimen against the clay.

8.4 Focus the measuring microscope with a low power objective so that the specimen surface can be observed.

8.5 Adjust the light intensity and adjust the apertures for optimum resolution and contrast. Zero the measuring device according to the manufacturer's recommended method.

8.6 Select the area desired for hardness determination. Before applying the force, make a final focus using the measuring objective.

8.7 Adjust the tester so that the indenter is in the proper place for force application. Select the desired force.

8.8 Activate the tester so that the indenter is automatically lowered and makes contact with the specimen for the normally required time period. Then, remove the force either manually or automatically.

8.9 After the force is removed, switch to the measuring mode, and select the proper objective lens. Focus the image, adjust the light intensity if necessary, and adjust the apertures for maximum resolution and contrast.

8.10 Examine the indentation for its position relative to the desired location and for its symmetry.

8.10.1 If the indentation did not occur at the desired spot, the tester is out of alignment. Consult the manufacturer's instruction manual for the proper procedure to produce alignment. Make another indentation and recheck the indentation location. Readjust and repeat as necessary.

8.10.2 For a Knoop indentation, if one half of the long diagonal is more than 10 % longer than the other diagonal half, or if both ends of the indentation are not in sharp focus, the test specimen surface may not be perpendicular to the indenter axis. Such an indent may yield incorrect data and the calculated HK based upon it should be reported outside these limits. Check the specimen alignment and make another test to be sure that the test data is correct.

8.10.3 For a Vickers indentation, if one half of either diagonal is more than 5 % longer than the other half of that diagonal, or if the four corners of the indentation are not in sharp focus, the test surface may not be perpendicular to the indenter axis. Such an indent may yield incorrect data and the calculated HV based upon it should be reported outside these limits. Check the specimen alignment and make another test to be sure that the test data is correct.

8.10.4 If the diagonal legs are unequal as described in 8.10.2 or 8.10.3, rotate the specimen 90° and make another indentation in an untested region. If the nonsymmetrical aspect of the indentations has rotated 90°, then the specimen surface is not perpendicular to the indenter axis. If the nonsymmetrical nature of the indentation remains in the same orientation, check the indenter for misalignment or damage.

8.10.5 Some materials may have nonsymmetrical indentations even if the indenter and the specimen surface are perfectly aligned. Tests on single crystals or on textured materials may produce such results. When this occurs, check the alignment using a test specimen, such as a standard, known to produce uniformly shaped indentations.

8.10.6 Brittle materials, such as ceramics, may crack as a result of being indented. Specific details for testing ceramics are contained in Test Methods C1326 and C1327.

8.11 Measure the long diagonal of a Knoop indentation, or both diagonals of a Vickers indentation, in accordance with the manufacturer's instruction manual.

8.11.1 Determine the length of the long diagonal of a Knoop indentation or both diagonals of a Vickers indentation to within 0.1 μm (see 6.3). For the Vickers indentations, average the two diagonal length measurements.

8.12 Compute the Knoop or Vickers hardness number using the appropriate equation in Section 3 or using tables supplied with the tester, respectively. Modern testers usually give an

automatic readout of the hardness after the diagonal or diagonals have been measured.

8.13 *Spacing of Indentations*—Generally, more than one indentation is made on a test specimen. It is necessary to ensure that the spacing between indentations is large enough so that adjacent tests do not interfere with each other. Because face-centered cubic (FCC) metals (for example, austenitic stainless steels, copper, nickel, silver and gold) work harden more dramatically than body-centered cubic (BCC) metals (ferritic steels, for example), the indent spacing distance is more critical for FCC metals as the deformation zone around the indent is larger than for a BCC metal, as mentioned in 7.1.2.

8.13.1 For most testing purposes, the minimum recommended spacing between separate tests and the minimum distance between an indentation and the surface of the specimen, are illustrated in Fig. 3.

8.13.2 For some applications, closer spacing of indentations than those shown in Fig. 3 may be necessary. If a closer indentation spacing is used, it shall be the responsibility of the testing laboratory to verify the accuracy of the testing procedure. Parallel, staggered bands of indents from the surface inward can be utilized to obtain closer overall spacing of indents with respect to the distance from the surface than can be safely done with a single line of indents from the surface inward, or within the interior of the specimen.

## 9. Report

9.1 Report the following information:

9.1.1 The number of tests and, where appropriate or required, the mean, standard deviation and 95% confidence interval for the tests. Due to the long history of hardness calculations, and because the traditional  $\text{kg}/\text{mm}^2$  unit is not part of the SI system, the calculated numbers will be reported without mention of the units. Also, due to the general unfamiliarity of the metallurgical community with hardness numbers

in GPa, and the rather narrow range of GPa values for metals, a “soft” SI system approach is recommended.

9.1.2 Test force, and

9.1.3 Any unusual conditions encountered during the test.

9.2 The symbols HK for Knoop hardness and HV for Vickers hardness shall be used with the reported numerical values.

9.2.1 For this standard, the microindentation hardness test results can be reported in several different ways. For example, if the Knoop hardness was found to be 400, and the test force was 100 gf, the test results may be reported as follows:

9.2.1.1 For microindentation hardness tests, where the test force is generally in gram force units, with test forces  $\leq 1000$  gf, this result can be reported as 400 HK 0.1, for example, when a test at 100 gf yields a Knoop hardness of 400. The same approach is used to report the Vickers hardness.

9.2.1.2 In the SI system the hardness would be reported as 3.92 GPa, but this practice is not preferred for the reasons stated in 9.1.1.

9.2.1.3 For nonstandard dwell times, other than 10 to 15 s, the hardness would be reported as 400 HK 0.1/22 s. In this case, 22 s would be the actual time of the full load dwell time.

9.2.1.4 For macro-Vickers tests with forces  $> 1$  kgf, see Test Method E92 for the recommended notation.

9.3 Examples of the calculation of measurement uncertainty are given in Test Method E92.

## 10. Precision and Bias

10.1 The precision and bias of microindentation hardness measurements depend on strict adherence to the stated test procedure and are influenced by instrumental and material factors and indentation measurement errors.

10.2 The consistency of agreement for repeated tests on the same material is dependent on the homogeneity of the material,

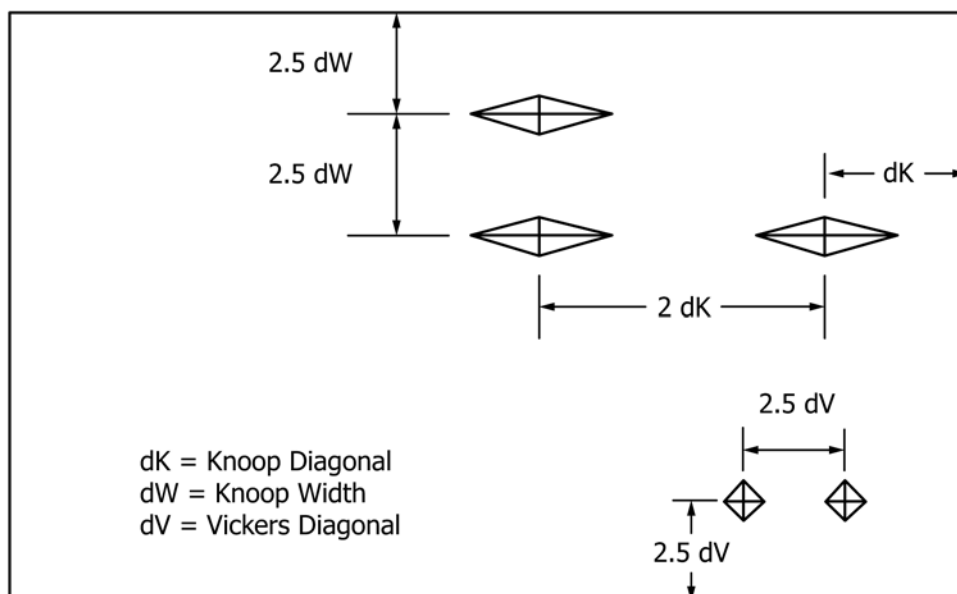

FIG. 3 Minimum Recommended Spacing for Knoop and Vickers Indentations

reproducibility of the hardness tester, and consistent, careful measurement of the indents by a competent operator.

10.3 Instrumental factors that can affect test results include: accuracy of loading; inertia effects; speed of loading; vibrations; the angle of indentation; lateral movement of the indenter or specimen; and, indentation and indenter shape deviations.

10.3.1 Vibrations during indenting will produce larger indentations with the potential influence of vibrations becoming greater as the force decreases (2, 3).

10.3.2 The angle between the indenter and specimen surface should be within 2° of perpendicular. Greater amounts of tilting may produce non-uniform indentations and incorrect test results.

10.4 Material factors that can affect test results include: specimen homogeneity, orientation or texture effects; improper specimen preparation; low specimen surface reflectivity; and, transparency of the specimen.

10.4.1 Residual deformation from mechanical polishing must be removed, particularly for low-force ( $\leq 200$  gf) testing.

10.4.2 Distortion of the indentation shape, due to either crystallographic or microstructural texture, influences diagonal lengths and the validity of the calculated hardness.

10.4.3 Plastic deformation during indentation can produce ridging around the indentation periphery that will affect diagonal measurement accuracy.

10.4.4 Testing of etched surfaces, depending on the extent of etching, may produce results that are different from those obtained on unetched surfaces (2).

10.5 Measurement errors that can affect test results include: inaccurate calibration of the measuring device; inadequate resolving power of the objective; insufficient magnification; operator bias in sizing the indentations; poor image contrast; non-uniform illumination; and, improper zeroing of the measuring device.

10.5.1 The accuracy of microindentation hardness testing is strongly influenced by the accuracy to which the indentations can be measured.

10.5.2 The error in measuring the diagonals increases as the numerical aperture of the measuring objective decreases (4, 5). In general, indents  $< 30$   $\mu\text{m}$  in length should be measured with objectives having greater magnification than 40 or 50 $\times$ . Image contrast between the indent and the specimen is critical for precise measurement of diagonal length.

10.5.3 Bias is introduced if the operator consistently under-sizes or over-sizes the indentations.

10.6 Some of the factors that affect test results produce systematic errors that influence all test results while others primarily influence low-force ( $\leq 25$  gf) test results (6). Some of these problems occur continually, others may occur in an undefined, sporadic manner. Low-force hardness tests are influenced by these factors to a greater extent than higher force tests.

10.7 For both the Vickers and Knoop hardness tests, the calculated microindentation hardness is a function of three variables: force, indenter geometry and diagonal measurement. For the Vickers test, the error in measuring the diagonals has a

bigger effect on the precision of the HV value than a larger error in the test force or the face geometry. For the Knoop test, an error in measuring the long diagonal has a bigger influence on the precision of the HK value than a larger error in the test force. But, errors in the two face angles, Fig. 1, have a very significant effect on the precision of the HK value.

10.8 Three separate interlaboratory studies have been conducted in accordance with Practice E691 to determine the precision, repeatability, and reproducibility of this test method. The three studies are defined as follows: (a) Knoop and Vickers tests, six test forces in the micro range, twelve laboratories, manual measurements, and seven different hardness level specimens (see 10.8.1 and Appendix X1). Results were published in 1989 (7, 8) and in ASTM Research Report RR:E04-1004.<sup>5</sup> (b) Knoop and Vickers tests, two test forces in the micro range, seven laboratories, image analysis and manual measurements, four different hardness level specimens (see 10.8.2, Appendix X2 and ASTM Research Report RR:E04-1006).<sup>6</sup> (c) Knoop and Vickers tests, six test forces in the micro range, twenty-five laboratories, manual measurements, six different hardness level specimens (see 10.8.3, Appendix X3 and ASTM Research Report RR:E04-1007).<sup>7</sup>

10.8.1 An interlaboratory test program was conducted in accordance with Practice E691 to develop information regarding the precision, repeatability, and reproducibility of the measurement of Knoop and Vickers indentations (supporting data have been filed at ASTM Headquarters; request RR:E04-1004).<sup>5</sup> The test forces were 25, 50, 100, 200, 500, and 1000 gf on three ferrous and four nonferrous specimens (7, 8). Twelve laboratories measured the indentations, five of each type at each force on each sample. Additional details of this study are given in Appendix X1.

10.8.1.1 Tests of the three ferrous specimens revealed that nine laboratories produced similar measurements while two laboratories consistently undersized the indentations and one laboratory consistently oversized the indentations; that is, biased results were produced. These latter results were most pronounced as the force decreased and specimen hardness increased (that is, as the diagonal size decreased) and were observed for both Vickers and Knoop indentations. Results for the lower hardness nonferrous indentations produced better agreement. However, none of the laboratories that obtained higher or lower results on the ferrous specimens measured the nonferrous indentations.

10.8.1.2 *Repeatability Interval*—The difference due to test error between two test results in the same laboratory on the same material increases with increasing specimen hardness and with decreasing test force (see X1.4.4).

10.8.1.3 *Reproducibility Interval*—The difference in test results on the same material tested in different laboratories

<sup>5</sup> Supporting data have been filed at ASTM International Headquarters and may be obtained by requesting Research Report RR:E04-1004. Contact ASTM Customer Service at service@astm.org.

<sup>6</sup> Supporting data have been filed at ASTM International Headquarters and may be obtained by requesting Research Report RR:E04-1006. Contact ASTM Customer Service at service@astm.org.

<sup>7</sup> Supporting data have been filed at ASTM International Headquarters and may be obtained by requesting Research Report RR:E04-1007. Contact ASTM Customer Service at service@astm.org.



increased with increasing specimen hardness and with decreasing test force (see [X1.4.5](#)).

10.8.1.4 The within-laboratory and between-laboratory precision values improved as specimen hardness decreased and test force increased. The repeatability interval and reproducibility interval were generally larger than the precision estimate, particularly at low test forces and high specimen hardness.

10.8.2 An interlaboratory test program was conducted in accordance with Practice [E691](#) to develop information regarding the repeatability and reproducibility of Knoop and Vickers measurements made with automated image analysis systems compared to measurements by manual procedures. Four ferrous specimens were used in the round robin. The tests were conducted at 100 gf and 300 gf. The participants in the test program measured the same indentations on the four specimens. Seven labs measured the specimens using both procedures. The Knoop indentations on specimen C1 were too long for accurate measurements to be made by one lab; hence, only six sets of measurements were made on this specimen. Near the end of the test program, specimen B1 was lost in shipping; thus only six sets of measurements were made on this specimen. Additional details of the study are contained in [Appendix X2](#).

10.8.2.1 Repeatability concerns the variability between individual test results obtained within a single laboratory by a single operator with a specific set of test apparatus. For both the manual and automated measurements, the repeatability interval increased with specimen hardness and decreasing test force, [Appendix X2](#). For equivalent testing conditions, the repeatability interval for automated measurements was slightly larger than for manual measurements.

10.8.2.2 Reproducibility deals with the variability between single test results obtained by different laboratories applying the same test methods to the same or similar test specimens. For both the manual and automated measurements, the reproducibility interval increased with specimen hardness and decreasing test force, [Appendix X2](#). For equivalent testing conditions, the reproducibility interval for automated measurements was slightly larger than for manual measurements.

10.8.2.3 Neither Practice [E691](#), nor any other ASTM standard, deals with comparing test results of a single property

made by two different test methods. Hence, it is not possible to statistically and accurately compare the hardness measurements made by the manual and automated procedures. However, this information is graphically represented for comparative purposes, [X2.6](#).

10.8.3 Tests of six ferrous alloys with hardness values of <20 HRC, 30, 40, 50, 60 and 67 HRC were tested using Knoop and Vickers tests at a variety of test forces, usually 25, 50, 100, 300, 500 and 1000 gf (except that the lowest test forces for Vickers tests of the 60 and 67 HRC specimens were not performed). Twenty-five different laboratories tested the steels using the Vickers test while thirteen different laboratories tested the steels using the Knoop test. Additional details of this study are given in [Appendix X3](#).

10.8.3.1 Repeatability and reproducibility statistics were determined for the Knoop and Vickers diagonal measurements. Results are tabulated in [Table X3.1](#) and [Table X3.2](#) and are shown graphically in [Fig. X3.1](#) and [Fig. X3.2](#).

10.8.3.2 Repeatability and reproducibility statistics were determined for the Knoop and Vickers hardness values. Results are tabulated in [Table X3.3](#) and [Table X3.4](#) and are shown graphically in [Fig. X3.3](#) and [Fig. X3.4](#).

## 11. Conversion to Other Hardness Scales or Tensile Strength Values

11.1 There is no generally accepted method for precise conversion of Knoop or Vickers microindentation hardness numbers to other hardness scales or tensile strength values. Such conversions are empirical and are limited in precision and should be used with caution, except for special cases where a reliable basis for the conversion has been obtained by comparison tests. For loads  $\geq 25$  gf microindentation Vickers hardness numbers are in statistical agreement with macro-Vickers hardness numbers. Refer to Standard Hardness Conversion Tables in [E140](#).

## 12. Keywords

12.1 hardness; indentation; Knoop; microindentation; Vickers

## ANNEXES

### (Mandatory Information)

#### A1. VERIFICATION OF KNOOP AND VICKERS HARDNESS TESTING MACHINES AND INDENTERS

##### A1.1 Scope

A1.1.1 [Annex A1](#) specifies three types of procedures for verifying microindentation (Knoop and Vickers) hardness testing machines: direct verification, indirect verification, and periodic verification. This annex also contains geometric specifications for the indenter. A control chart method for monitor-

ing the consistency of microindentation measurements based on the periodic verification tests and detecting measurement deviations is described in Practices [E2554](#) and [E2587](#).

A1.1.2 Direct verification is a process normally performed by the manufacture for verifying that critical components of the hardness testing machine are within allowable tolerances by

direct measurement of the applied test forces, the indentation measuring system, and the testing cycle. For additional information about direct verification see Test Method E92.

A1.1.3 Indirect verification is a process performed by the user of the machine, or by an outside certification agency, to periodically verify the performance of the testing machine by means of standardized test blocks. For additional information about the indirect verification procedure, see Test Method E92.

A1.1.4 The periodic (formerly called “weekly”) verification is a process for monitoring the performance of the testing machine between indirect verifications by means of standardized test blocks and is performed by the user.

## A1.2 General Requirements

A1.2.1 The testing machine shall be verified at specific instances and at periodic intervals as specified in Table A1.1, and when circumstances occur that may affect the performance of the testing machine. See Annex A1 in Test Method E92 for interval details for direct and indirect verifications.

A1.2.2 All instruments used to make measurements required by this Annex shall be calibrated traceable to national standards when a system of traceability exists, except as noted otherwise.

A1.2.3 Periodic verification and the indirect verification of the testing machine shall be performed at the location where the tester is used.

A1.2.4 Direct verification of newly manufactured or rebuilt testing machines may be performed at the place of manufacture, rebuild or the location of use. Details of this procedure can be found in Test Method E92.

NOTE A1.1—It is recommended that the calibration agency that is used to conduct the verifications of microindentation hardness testing machines be accredited to the requirements of ISO 17025 (or an equivalent) by a recognized accrediting body that operates to the requirements of ISO Guide 58.

A1.2.5 *Verification of Indenter*—The geometry of the indenter is verified at the time of manufacturing and it is mandatory for new machines. Subsequent verifications of the indenter are performed by visual inspection of the resulting indentation; it is usually sufficient for the user to verify the absence of defects from the shape of indentations performed on test blocks. Details of this process are given in Test Method E92.

## A1.3 Periodic Verification

A1.3.1 The periodic (formerly known as the “weekly”) verification is intended as a tool for the user to monitor the performance of the testing machine between indirect verifications. At a minimum, the periodic verification shall be per-

formed in accordance with the schedule given in Table A1.1 for each microindentation hardness indenter that will be used.

A1.3.2 It is recommended that the periodic verification procedures be performed whenever the indenter is changed, that is, if one indenter is physically removed from the port and another is inserted into its place. This is not required with machines that have both types of indenter mounted on the same turret. It is also recommended to perform a periodic verification when loads are changed (to verify that the load is not “hanging up”).

A1.3.3 *Periodic Verification Procedures*—The procedure to use when performing a periodic verification is as follows.

A1.3.3.1 At least one standardized test block that meets the requirements of Annex A2 shall be used for each microindentation hardness indenter to be used. When test blocks are commercially available, the hardness level of the test blocks shall be chosen at approximately the same hardness value as the material to be measured. If various hardness ranges are to be made, it is recommended to take a test block from each range of hardness as described in Table A1.2.

A1.3.3.2 The indenter to be used for the periodic verification shall be the indenter that is normally used for testing.

A1.3.3.3 Before performing the periodic verification tests, ensure that the testing machine is working freely, the stage and test block are clean, and the measuring device is properly adjusted and zeroed.

A1.3.3.4 Make at least three hardness measurements on each of the verification test blocks. The tests shall be distributed uniformly over the surface of the test blocks.

A1.3.3.5 Let  $\bar{d}$  be the average of the measurements. Determine the error  $E$  and the repeatability  $R$  in the performance of the testing machine using Eq 10 and Eq 11 from 3.4 for each standardized test block that is measured.

(1) If the error  $E$  and the repeatability  $R$  calculated for each test block is within the tolerances given in Table A1.3, the testing machine with the indenter may be regarded as performing satisfactorily.

(2) If the error  $E$  and the repeatability  $R$  calculated for any of the test blocks is outside the tolerances, the periodic verification may be repeated with a different indenter. If the average of the hardness measurements again falls outside of tolerances for any of the test blocks, an indirect verification shall be performed.

A1.3.3.6 If a testing machine fails a periodic verification, the hardness tests made since the last valid periodic verification may be suspect.

NOTE A1.2—It is highly recommended that the results obtained from the periodic verification testing be recorded using accepted Statistical Process Control techniques, such as, but not limited to,  $\bar{X}$ -bar (measurement averages) and  $R$ -charts (measurement ranges), and histograms (see Practices E2554 and E2587).

**TABLE A1.1 Verification Schedule for a Microindentation Hardness Testing Machine**

| Verification Procedure | Schedule  |
|------------------------|---|
| Periodic Verification  | Required each week that the machine is used.<br>Recommended whenever the indenter is physically removed and replaced by another indenter. |

**TABLE A1.2 Hardness Ranges Used for Periodic Verification**

| Range | Knoop   | Vickers |
|-------|---------|---------|
| Low   | < 250   | < 240   |
| Mid   | 250–650 | 240–600 |
| High  | > 650   | > 600   |

**TABLE A1.3 Repeatability and Error of Test Machines— Periodic Verification by Standardized Test Blocks Based on Measured Diagonal Lengths<sup>A</sup>**

| Hardness Range of Standardized Test Blocks |                | Force, gf      | R<br>Maximum Repeatability (%) | E<br>Maximum Error (%) |
|--|----------------|----------------|--------------------------------|------------------------|
| Knoop                                      | Vickers        |                |                                |                        |
| HK > 0                                     | HV > 0         | 1 ≤ F < 100    | 13                             | 3                      |
| HK < 100                                   | HV < 100       | 100 ≤ F ≤ 1000 | 13                             | 3                      |
| 100 ≤ HK ≤ 250                             | 100 ≤ HV ≤ 240 | 100 ≤ F < 500  | 13                             | 2                      |
| 250 < HK ≤ 650                             | 240 < HV ≤ 600 |                | 5                              | 2                      |
| HK > 650                                   | HV > 600       |                | 4                              | 2                      |
| 100 ≤ HK ≤ 250                             | 100 ≤ HV ≤ 240 | 500 ≤ F ≤ 1000 | 8                              | 2                      |
| 250 < HK ≤ 650                             | 240 < HV ≤ 600 |                | 4                              | 2                      |
| HK > 650                                   | HV > 600       |                | 3                              | 2                      |

<sup>A</sup> In all cases, the repeatability is the greater of the percentage given or 1 μm; the maximum error is the greater of the value obtained or 0.5 μm.

### A1.4 Verification Report

A1.4.1 A verification report is required for direct and indirect verifications. A verification report is not required for a periodic verification. Additional details concerning creation of the verification report can be found in Test Method E92.

A1.4.2 The verification report shall be produced by the person performing the verification and include the following information when available as a result of the verification performed.

A1.4.2.1 Full details of the verification report can be found in Test Method E92.

A1.4.2.2 The basic components of the verification report, as defined in detail in Test Method E92, are summarized below.

(1) Identification of the hardness testing machine and the indenters used.

(2) Means of verification (test blocks, elastic proving devices, etc.) with statements defining traceability to a national standard.

(3) The microindentation hardness scale(s) verified.

(4) The individual or calculated results used to determine whether the testing machine meets the requirements of the verification performed. Measurements made to determine the as-found condition of the testing machine shall be included whenever they are made.

(5) Description of adjustments or maintenance done to the testing machine.

(6) Date of verification and reference to the verifying agency or department.

(7) Signature of the person performing the verification.

## A2. CALIBRATION OF STANDARDIZED HARDNESS TEST BLOCKS FOR MICROINDENTATION HARDNESS TEST MACHINES

### A2.1 Scope

A2.1.1 The calibration of standardized hardness test blocks used to verify microindentation hardness test machines is described in Test Method E92. The standardizing machine shall meet the direct verification method described in Test Method E92.

A2.1.2 Re-polishing of the test block will invalidate the standardization and is not recommended. Cleaning of the polished test block surface is often required in normal usage but must not alter the hardness or quality of the polished test surface.

### A2.2 Certification of Standardized Test Block

A2.2.1 The certificate accompanying each standardized hardness test block shall include the following information: the arithmetic mean of each group of five impression diagonals; the arithmetic mean and standard deviation of all impression diagonals, the corresponding hardness value, the test force, serial number of the test block, name of the manufacturer and certifying organization, magnification used, and the date.

## APPENDIXES

### (Nonmandatory Information)

## X1. RESULTS OF INTERLABORATORY TEST OF THE MEASUREMENT OF MICROINDENTATIONS

### X1.1 Introduction

X1.1.1 This interlaboratory test program (7, 8) was conducted to develop precision and bias estimates for the measurement of both Knoop and Vickers indentations using forces of 25 to 1000 gf for ferrous and nonferrous specimens covering a wide range of hardness (see Research Report RR:E04-1004).<sup>5</sup>

### X1.2 Scope

X1.2.1 This interlaboratory test program provides information on the measurement of the same indentations by different laboratories according to the procedures of Practice E691.

### X1.3 Procedure

X1.3.1 Five indentations were made under controlled conditions at each force (25, 50, 100, 200, 500, and 1000 gf), with both Knoop and Vickers indenters using three ferrous and four nonferrous specimens.

X1.3.2 Twelve laboratories measured the indentations on the ferrous specimens and the nonferrous specimens. Two laboratories measured the hardness of both groups.

X1.3.3 Each laboratory used the same stage micrometer to calibrate their measuring device.

X1.3.4 Results were tabulated and analyzed in accordance with Practice E691.

### X1.4 Results

X1.4.1 For the three ferrous specimens, results from nine laboratories showed general agreement as to the diagonal sizes. Two other laboratories consistently undersized the indentations (higher hardness) and one laboratory consistently oversized the indentations (lower hardness). This bias was observed with both Vickers and Knoop indentations sized by these laboratories with the degree of bias increasing as the indentation size decreased and the specimen hardness increased. Test on the four nonferrous specimens produced general agreement, but none of the three laboratories that produced biased results for the ferrous specimens measured the nonferrous specimens.

X1.4.2 For the Vickers test data, the calculated hardness increased with increasing force and then became reasonably constant. This trend was apparent in the data from the nine consistent laboratories (ferrous specimens) and for the laboratory that oversized the indentations. The two laboratories that consistently undersized the Vickers indentations exhibited substantial data scatter for the tests with forces of less than 100 gf. However for higher forces, their indentation measurements were relatively constant. The force at which the hardness became relatively constant increased with increasing specimen

hardness. For specimens below about 300 HV, there was relatively little difference in HV over the test force range.

X1.4.3 For the Knoop test data, most of the laboratories agreed that the hardness decreased continually with increasing test force and then became reasonably constant. However, the two laboratories that exhibited outlier data for the ferrous specimens did show the opposite trend; this is highly unusual. The difference in HK values between low forces and high forces increased with increasing specimen hardness. For specimens with hardness below about 300 HK, the difference in hardness was quite small over the test force range.

X1.4.4 *Repeatability Interval*—The difference due to test error between two test results in the laboratory on the same material was calculated using the  $(S_r)_j$  values, the pooled within-laboratory standard deviation.  $(S_r)_j$  increased with diagonal size and the relationship varied for each material and test type. Table X1.1 lists regression equations that show the relationship between  $(S_r)_j$  and the diagonal length,  $\mu\text{m}$ . The repeatability interval  $(I_r)_j$ , was calculated based on the relationships in Table X1.1. Because the repeatability intervals are also a function of diagonal length, regression equations were also calculated, Table X1.2. The repeatability intervals, in terms of Knoop and Vickers values for ferrous and nonferrous specimens, are shown in Figs. X1.1-X1.4.

X1.4.5 *Reproducibility Interval*—The difference in test results on the same material in different laboratories was calculated using the  $(S_R)_j$  values, the between-laboratory estimate of precision.  $(S_R)_j$  increased with diagonal size and the relationship varied for each material and test type. Table X1.3 lists the regression equations that show the relationship between  $(S_R)_j$  and the diagonal length,  $\mu\text{m}$ . The reproducibility intervals  $(I_R)_j$ , were calculated based on the relationships shown in Table X1.3. Because the reproducibility intervals are also a function of diagonal length, regression equations were also calculated, Table X1.4. The reproducibility intervals, in terms of Knoop and Vickers values for the ferrous and nonferrous specimens, are shown in Figs. X1.1-X1.4.

X1.4.6 The within-laboratory and between-laboratory precision values were calculated from  $(V_r(\%))_j$  and  $(V_L(\%))_j$  which are the coefficients of variation for within-laboratory and between-laboratory tests. Both are a function of the length of the diagonal. The within-laboratory and between-laboratory precision values were relatively similar for both Vickers and Knoop test data, either ferrous or nonferrous. In general, the repeatability intervals and reproducibility intervals were larger than the precision estimates, particularly at low test forces and high specimen hardness.

**TABLE X1.1 Relationship Between Diagonal Length and  $(S_r)_j$ , the Pooled Within-Laboratory Standard Deviation**

| Material   | Test    | Regression Equation                   | Correlation Coefficient |
|------------|---------|---------------------------------------|-------------------------|
| Ferrous    | Vickers | $(S_r)_j = 0.231 + 0.00284 \bar{d}_1$ | 0.535                   |
| Ferrous    | Knoop   | $(S_r)_j = 0.216 + 0.006 \bar{d}_1$   | 0.823                   |
| Nonferrous | Vickers | $(S_r)_j = 0.373 + 0.008 \bar{d}_1$   | 0.862                   |
| Nonferrous | Knoop   | $(S_r)_j = 0.057 + 0.0177 \bar{d}_1$  | 0.8196                  |

**TABLE X1.2 Relationship Between the Diagonal Length and  $(I_r)_j$ , the Repeatability Interval**

| Material   | Test    | Regression Equation                   |
|------------|---------|---------------------------------------|
| Ferrous    | Vickers | $(I_r)_j = 0.653 + 0.008 \bar{d}_1$   |
| Ferrous    | Knoop   | $(I_r)_j = 0.614 + 0.017 \bar{d}_1$   |
| Nonferrous | Vickers | $(I_r)_j = 1.0556 + 0.0226 \bar{d}_1$ |
| Nonferrous | Knoop   | $(I_r)_j = 0.161 + 0.05 \bar{d}_1$    |

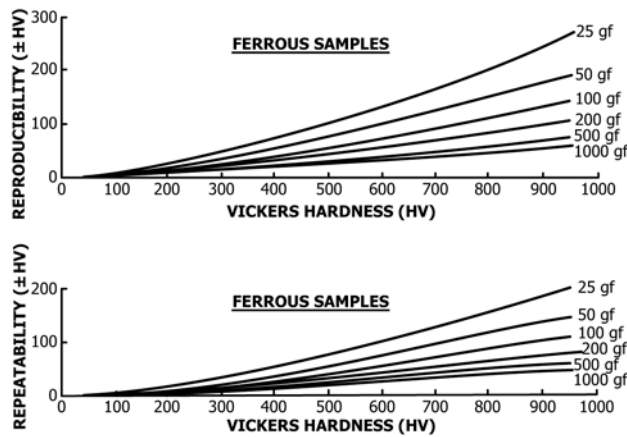

**FIG. X1.1 Repeatability and Reproducibility Intervals in Terms of Vickers Hardness ( $\pm$ ) for the Ferrous Sample as a Function of Test Load and Specimen Hardness**

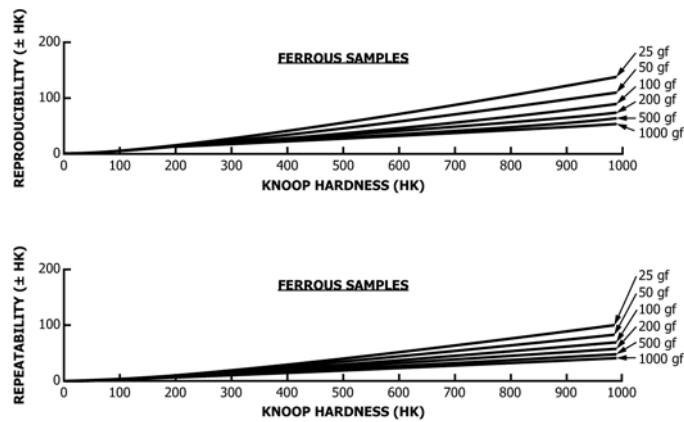

**FIG. X1.2 Repeatability and Reproducibility Intervals in Terms of Knoop Hardness ( $\pm$ ) for the Ferrous Samples as a Function of Test Load and Specimen Hardness**

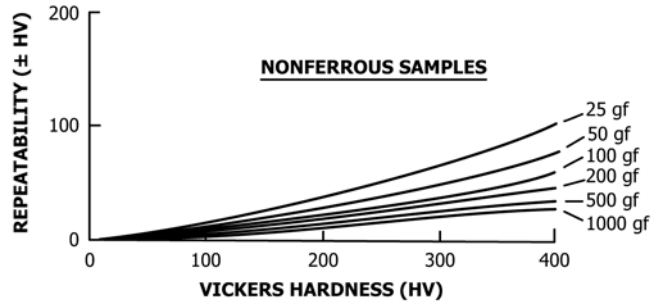
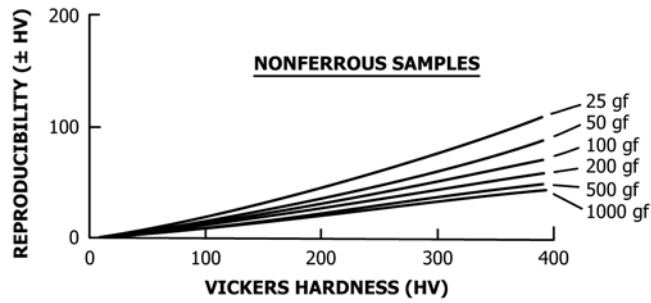

FIG. X1.3 Repeatability and Reproducibility Intervals in Terms of Vickers Hardness ( $\pm$ ) for the Nonferrous Samples as a Function of Test Load and Specimen Hardness

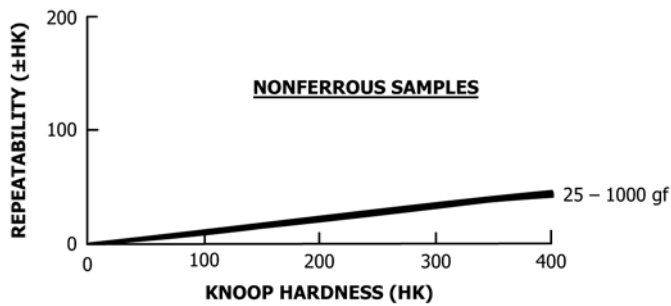
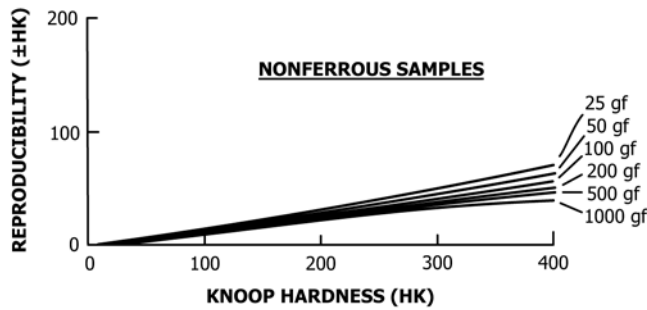

FIG. X1.4 Repeatability and Reproducibility Intervals in Terms of Knoop Hardness ( $\pm$ ) for the Nonferrous Samples as a Function of Test Load and Specimen Hardness

**TABLE X1.3 Relationship Between Diagonal Length and  $(S_R)_j$ , the Between-Laboratory Estimate of Precision**

| Material   | Test    | Regression Equation                  | Correlation Coefficient |
|------------|---------|--------------------------------------|-------------------------|
| Ferrous    | Vickers | $(S_R)_j = 0.31 + 0.004 \bar{d}_1$   | 0.747                   |
| Ferrous    | Knoop   | $(S_R)_j = 0.333 + 0.007 \bar{d}_1$  | 0.899                   |
| Nonferrous | Vickers | $(S_R)_j = 0.357 + 0.0156 \bar{d}_1$ | 0.8906                  |
| Nonferrous | Knoop   | $(S_R)_j = 0.378 + 0.0177 \bar{d}_1$ | 0.8616                  |

**TABLE X1.4 Relationship Between the Diagonal Length and  $(I_R)_j$ , the Repeatability Interval**

| Material   | Test    | Regression Equation                   |
|------------|---------|---------------------------------------|
| Ferrous    | Vickers | $(I_R)_j = 0.877 + 0.0113 \bar{d}_1$  |
| Ferrous    | Knoop   | $(I_R)_j = 0.946 + 0.0198 \bar{d}_1$  |
| Nonferrous | Vickers | $(I_R)_j = 1.0103 + 0.0441 \bar{d}_1$ |
| Nonferrous | Knoop   | $(I_R)_j = 1.07 + 0.05 \bar{d}_1$     |

## X2. RESULTS OF AN INTERLABORATORY TEST COMPARING MICROINDENTATION HARDNESS TESTING USING MANUAL AND AUTOMATED MEASURING SYSTEMS

### X2.1 Introduction

X2.1.1 An interlaboratory test program was conducted to develop information comparing Knoop and Vickers microindentation hardness tests made with measurements using automated image analysis systems and by the standard manual procedure. Four ferrous specimens were used in the test program (see Research Report RR:E04-1006).<sup>6</sup>

### X2.2 Scope

X2.2.1 This interlaboratory test program provides information on measurements of the same indentations made by different laboratories using two different measuring methods according to the procedures of Practice E691.

### X2.3 Procedure

X2.3.1 The test was conducted under controlled conditions using loads of 100 gf and 300 gf. Ten Knoop and ten Vickers indentations were made for each load, a total of 40 indentations. The participants in the test program measured the same indentations on the four specimens. Seven laboratories measured the specimens using both procedures. The results of these seven sets of measurements were used for the analysis. The Knoop indentations on specimen C1 were too long for accurate measurements to be made by one lab; hence, only six sets of measurements were made on this specimen. Near the end of the test program, specimen B1 was lost in shipping; thus only six sets of measurements were made on this specimen.

### X2.4 Repeatability

X2.4.1 Repeatability concerns the variability between individual test results obtained within a single laboratory by a single operator with a specific set of test apparatus. For both the manual and automated measurements, the repeatability interval increased with specimen hardness and decreasing test force, Tables X2.1-X2.4, and Figs. X2.1-X2.4. For equivalent testing conditions, the repeatability interval for automated measurements was slightly larger than for manual measurements.

### X2.5 Reproducibility

X2.5.1 Reproducibility deals with the variability between single test results obtained by different laboratories applying the same test methods to the same or similar test specimens. For both the manual and automated measurements, the reproducibility interval increased with specimen hardness and decreasing test force, Tables X2.1-X2.4, and Figs. X2.1-X2.4. For equivalent testing conditions, the reproducibility interval for automated measurements was slightly larger than for manual measurements.

### X2.6 Comparisons

X2.6.1 Neither Practice E691, nor any other ASTM standard, deals with comparing test results of a single property made by two different test methods. Hence, it is not possible to statistically and accurately compare the hardness measurements made by the manual and automated procedures. However, this information is graphically represented for comparative purposes, Figs. X2.5-X2.8.

**TABLE X2.1 Precision Statistics for Manual and Automated Knoop Tests at 100 gf Load**

| Manual    |      |        |       |       |       |       |        |
|-----------|------|--------|-------|-------|-------|-------|--------|
| Spec.     | Labs | Mean   | Sx    | Sr    | SR    | r     | R      |
| C1        | 7    | 228.62 | 6.88  | 9.30  | 11.18 | 26.03 | 31.32  |
| D1        | 7    | 344.80 | 10.54 | 9.80  | 14.06 | 27.44 | 39.36  |
| A2        | 7    | 491.48 | 28.67 | 14.87 | 31.95 | 41.63 | 89.45  |
| B1        | 6    | 901.67 | 62.40 | 21.17 | 65.55 | 59.28 | 183.55 |
| Automated |      |        |       |       |       |       |        |
| Spec.     | Labs | Mean   | Sx    | Sr    | SR    | r     | R      |
| C1        | 7    | 232.07 | 7.29  | 9.54  | 11.62 | 26.72 | 32.55  |
| D1        | 7    | 348.97 | 10.74 | 9.54  | 14.04 | 26.70 | 39.32  |
| A2        | 7    | 510.13 | 30.35 | 19.53 | 35.56 | 54.69 | 99.56  |
| B1        | 6    | 914.72 | 57.82 | 29.22 | 64.13 | 81.83 | 179.56 |

**TABLE X2.2 Precision Statistics for Manual and Automated Knoop Tests at 300 gf Load**

| Manual    |      |        |       |       |       |       |       |
|-----------|------|--------|-------|-------|-------|-------|-------|
| Spec.     | Labs | Mean   | Sx    | Sr    | SR    | r     | R     |
| C1        | 6    | 215.81 | 5.49  | 7.66  | 9.10  | 21.44 | 25.49 |
| D1        | 7    | 330.64 | 6.99  | 7.49  | 9.97  | 20.98 | 27.92 |
| A2        | 7    | 466.95 | 17.99 | 11.45 | 21.02 | 32.06 | 58.85 |
| B1        | 6    | 827.47 | 20.41 | 16.13 | 25.51 | 45.16 | 71.43 |
| Automated |      |        |       |       |       |       |       |
| Spec.     | Labs | Mean   | Sx    | Sr    | SR    | r     | R     |
| C1        | 6    | 217.82 | 5.73  | 6.87  | 8.68  | 19.24 | 24.31 |
| D1        | 7    | 335.76 | 12.23 | 8.22  | 14.50 | 23.03 | 40.61 |
| A2        | 7    | 476.97 | 23.46 | 10.56 | 25.51 | 29.58 | 71.44 |
| B1        | 6    | 821.00 | 24.62 | 10.89 | 26.70 | 30.50 | 74.76 |

**TABLE X2.3 Precision Statistics for Manual and Automated Vickers Tests at 100 gf Load**

| Manual    |      |        |       |       |       |       |        |
|-----------|------|--------|-------|-------|-------|-------|--------|
| Spec.     | Labs | Mean   | Sx    | Sr    | SR    | r     | R      |
| C1        | 7    | 205.31 | 6.36  | 6.82  | 9.07  | 19.10 | 25.40  |
| D1        | 7    | 299.52 | 6.07  | 7.65  | 9.46  | 21.43 | 26.50  |
| A2        | 7    | 482.76 | 21.58 | 12.29 | 24.53 | 34.42 | 68.69  |
| B1        | 6    | 821.56 | 46.01 | 24.02 | 51.35 | 67.25 | 143.77 |
| Automated |      |        |       |       |       |       |        |
| Spec.     | Labs | Mean   | Sx    | Sr    | SR    | r     | R      |
| C1        | 7    | 203.30 | 6.94  | 6.47  | 9.27  | 18.12 | 25.95  |
| D1        | 7    | 299.78 | 14.36 | 5.23  | 15.19 | 14.63 | 42.54  |
| A2        | 7    | 482.86 | 32.07 | 16.50 | 35.69 | 46.19 | 99.93  |
| B1        | 6    | 808.17 | 47.72 | 21.30 | 51.82 | 59.63 | 145.09 |

**TABLE X2.4 Precision Statistics for Manual and Automated Vickers Tests at 300 gf Load**

| Manual    |      |        |       |       |       |       |       |
|-----------|------|--------|-------|-------|-------|-------|-------|
| Spec.     | Labs | Mean   | Sx    | Sr    | SR    | r     | R     |
| C1        | 7    | 197.07 | 3.40  | 5.32  | 6.09  | 14.91 | 17.06 |
| D1        | 7    | 298.91 | 5.47  | 7.38  | 8.89  | 20.68 | 24.89 |
| A2        | 7    | 474.58 | 18.00 | 12.45 | 21.53 | 34.86 | 60.28 |
| B1        | 6    | 810.60 | 29.67 | 16.50 | 33.55 | 46.21 | 93.94 |
| Automated |      |        |       |       |       |       |       |
| Spec.     | Labs | Mean   | Sx    | Sr    | SR    | r     | R     |
| C1        | 7    | 196.37 | 6.44  | 5.57  | 8.33  | 15.60 | 23.32 |
| D1        | 7    | 297.88 | 10.42 | 6.69  | 12.20 | 18.72 | 34.15 |
| A2        | 7    | 483.72 | 18.96 | 12.30 | 22.26 | 34.44 | 62.34 |
| B1        | 6    | 809.55 | 20.55 | 11.60 | 23.31 | 32.49 | 65.27 |



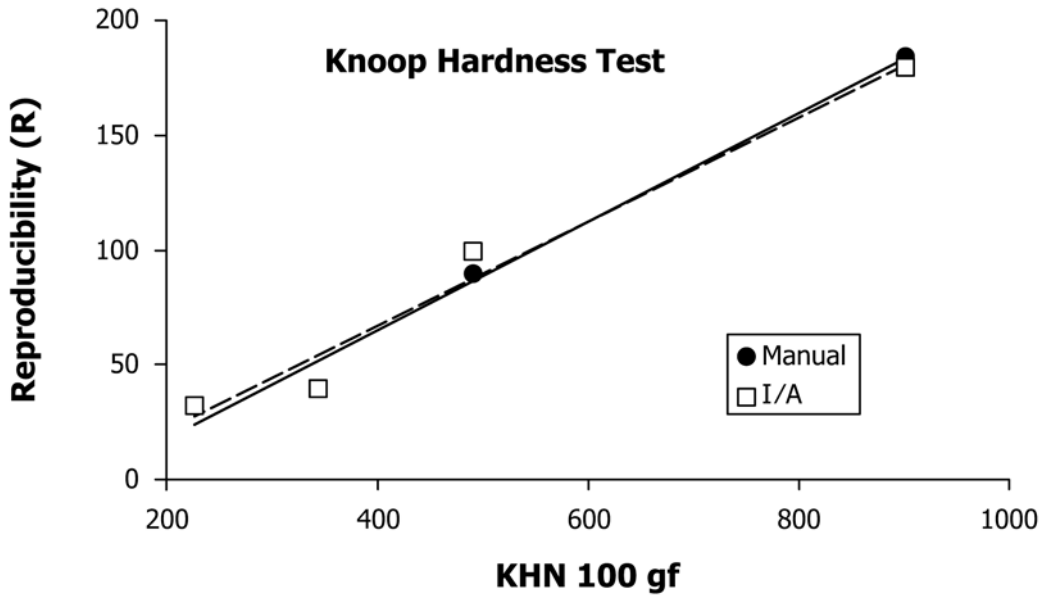

FIG. X2.1 Reproducibility of the Knoop 100 gf Manual and Automated Microindentation Hardness Tests

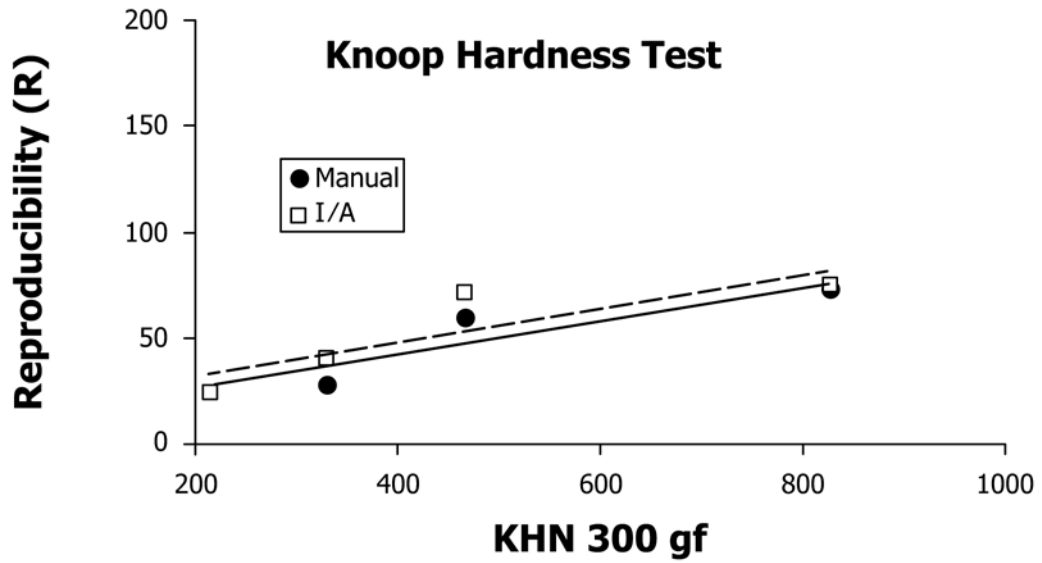

FIG. X2.2 Reproducibility of the Knoop 300 gf Manual and Automated Microindentation Hardness Tests

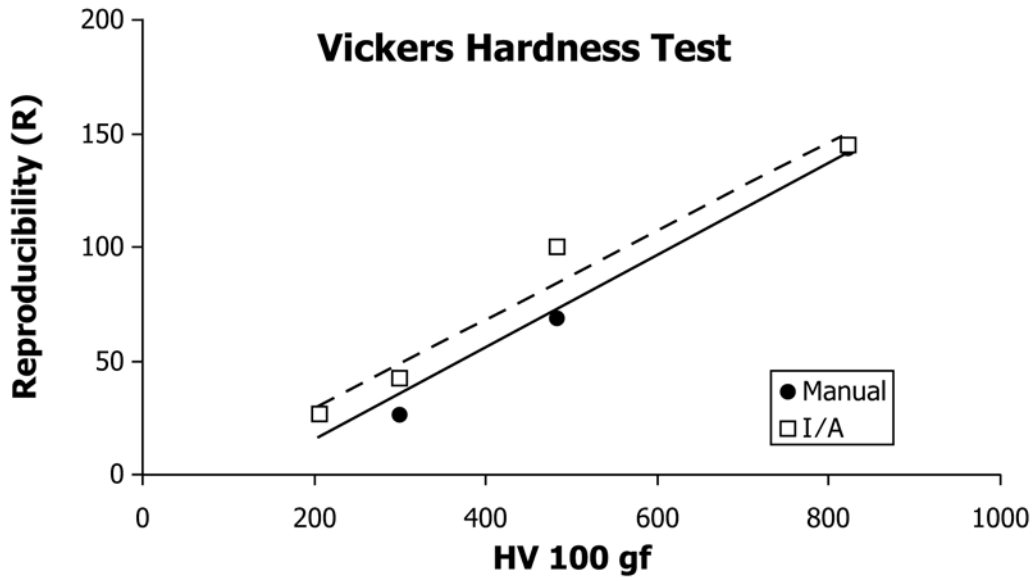

FIG. X2.3 Reproducibility of the Vickers 100 gf Manual and Automated Microindentation Hardness Tests

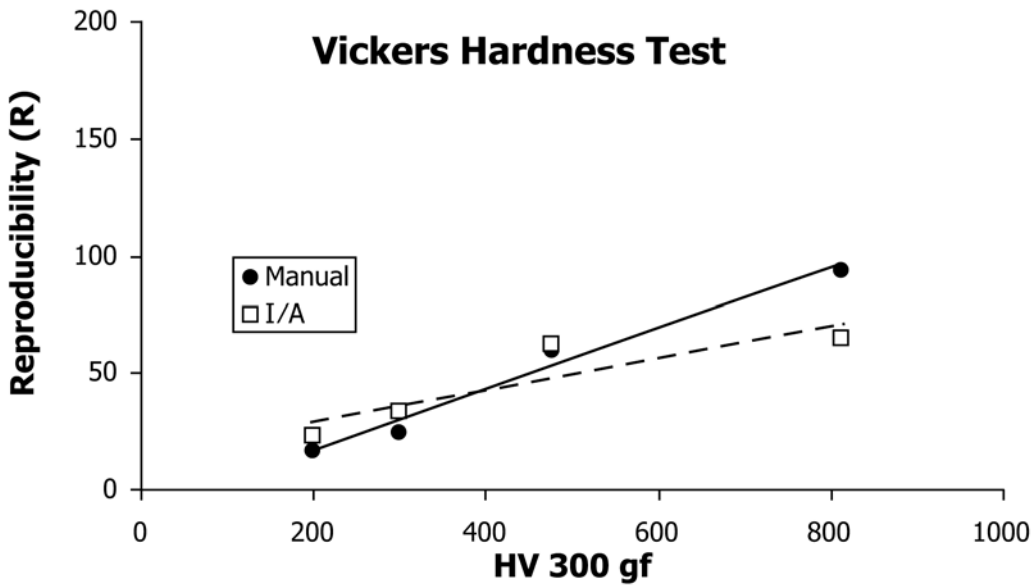

FIG. X2.4 Reproducibility of the Vickers 300 gf Manual and Automated Microindentation Hardness Tests

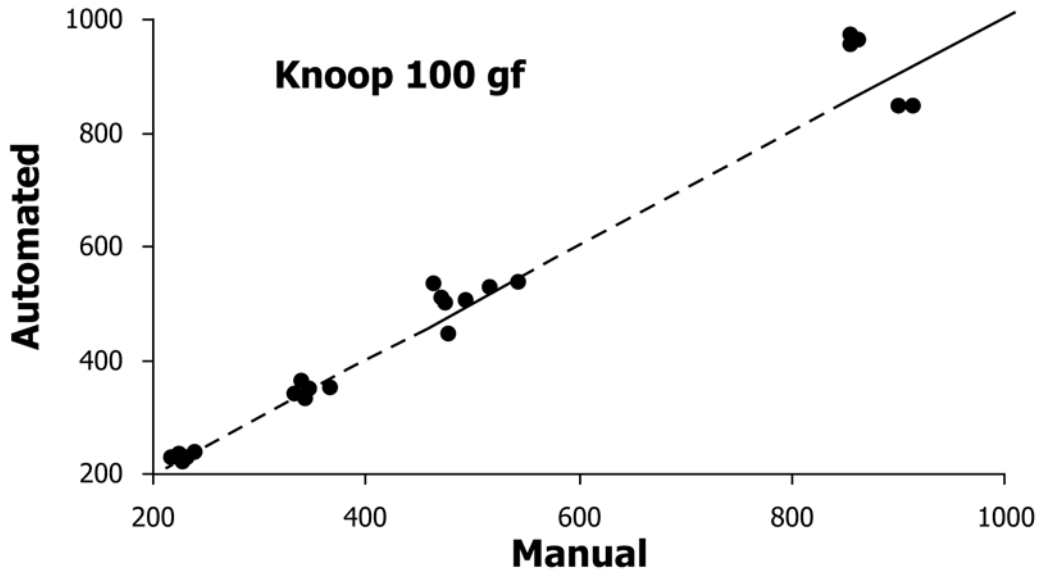

FIG. X2.5 Comparison between Knoop 100 gf Manual and Automated Microindentation Hardness Tests

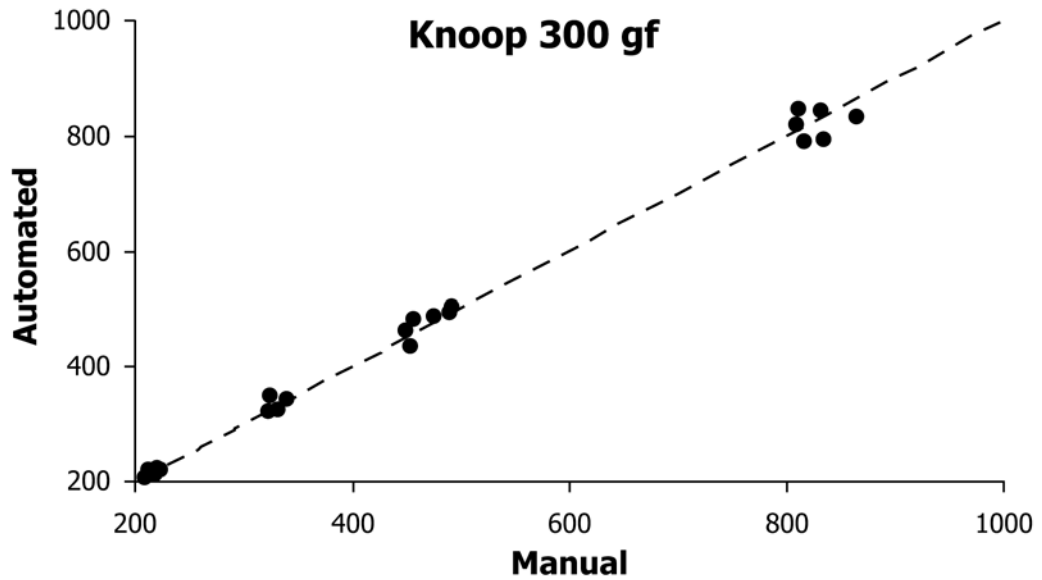

FIG. X2.6 Comparison between Knoop 300 gf Manual and Automated Microindentation Hardness Tests

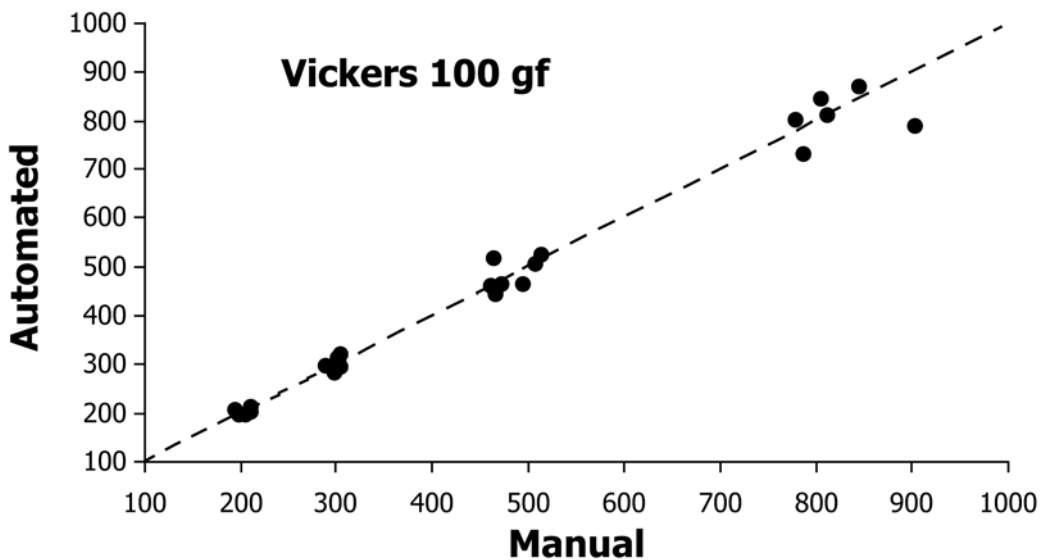

FIG. X2.7 Comparison between Vickers 100 gf Manual and Automated Microindentation Hardness Tests

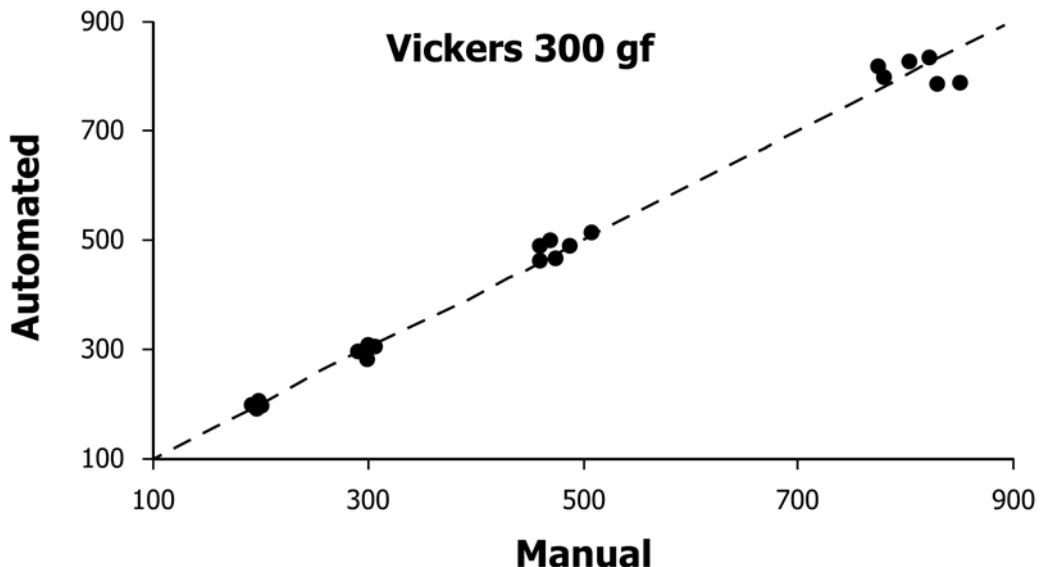

FIG. X2.8 Comparison between Vickers 300 gf Manual and Automated Microindentation Hardness Tests

### X3. RESULTS OF INTERLABORATORY TEST OF THE MEASUREMENT OF MICROINDENTATIONS

#### X3.1 Introduction

X3.1.1 The interlaboratory program was conducted on steels to develop precision statistics for Knoop and Vickers tests (see Research Report RR:E04-1007).<sup>7</sup>

#### X3.2 Scope

X3.2.1 Twenty five laboratories tested six steel specimens for Vickers hardness and thirteen laboratories tested the six steel specimens for Knoop hardness, all as a function of test forces ranging from 25 to 1000 gf, except for the hardest specimens.

X3.2.2 The precision statement was determined through statistical examination of results from twenty-five laboratories, on six ferrous materials. These six ferrous materials were described as:

- Specimen A: H13, mill annealed, hardness less than 20 HRC
- Specimen B: H13, austenitized, quenched, and tempered to ~ 50 HRC
- Specimen C: H13, austenitized, quenched, and tempered to ~ 40 HRC
- Specimen D: H13, austenitized, quenched, and tempered to ~ 30 HRC
- Specimen E: O1, austenitized, quenched and tempered O1 steel to ~ 60 HRC
- Specimen T: T15, P/M, austenitized, quenched and tempered to ~ 67 HRC

NOTE X3.1—To judge the equivalency of two test results, it is recommended to choose the material closest in characteristics to the test material.

### X3.3 Results

X3.3.1 Details of this study can be obtained from ASTM; request Research Report RR:E04-1006.<sup>6</sup>

X3.3.2 *Repeatability limit (r)*—Two test results obtained within one laboratory were judged not equivalent if they differed by more than the “r” value for that material; “r” is the interval representing the critical difference between two test results for the same material, obtained by the same operator using the same equipment on the same day in the same laboratory.

X3.3.3 Repeatability limits in diagonal lengths ( $\mu\text{m}$ ) are listed [Table X3.1](#) and [Table X3.2](#) and in hardness units (HK, HV) in [Table X3.3](#) and [Table X3.4](#).

X3.3.4 *Reproducibility limit (R)*—Two test results shall be judged not equivalent if they differ by more than the “R” value

for that material; “R” is the interval representing the critical difference between two test results for the same material, obtained by different operators using different equipment in different laboratories.

X3.3.5 Reproducibility limits in diagonal lengths ( $\mu\text{m}$ ) are listed in [Table X3.1](#) and [Table X3.2](#) and [Fig. X3.1](#) and [Fig. X3.2](#) and in hardness units (HK, HV) in [Table X3.3](#) and [Table X3.4](#) and [Fig. X3.3](#) and [Fig. X3.4](#).

X3.3.6 The above terms (repeatability limit and reproducibility limit) are used as specified in Practice [E177](#).

X3.3.7 Any judgment in accordance with statements [X3.3.2](#) and [X3.3.4](#) would have an approximate 95% probability of being correct.

X3.3.8 The data are listed in Tables 1-4. and are shown graphically in Figs. 1- 4.

**TABLE X3.1 Precision Statistics for an Interlaboratory Study of the Knoop Microindentation Hardness Test for Ferrous Specimens in Diagonal Units ( $\mu\text{m}$ )**

| Specimen | Test Force (gf) | Average Diagonal ( $\mu\text{m}$ ) | Standard Deviation ( $\mu\text{m}$ ) | Repeatability Standard Deviation ( $\mu\text{m}$ ) | Reproducibility Standard Deviation ( $\mu\text{m}$ ) | Repeatability Limit ( $\mu\text{m}$ ) | Reproducibility Limit ( $\mu\text{m}$ ) |
|----------|-----------------|------------------------------------|--------------------------------------|--|--|---------------------------------------|---|
|          |                 | $\bar{d}$                          | $S_x$                                | $S_r$  | $S_R$  | r                                     | R                                       |
| A        | 25              | 35.61                              | 1.40                                 | 0.72   | 1.54   | 2.00                                  | 4.31                                    |
|          | 50              | 51.77                              | 1.33                                 | 1.11   | 1.66   | 3.12                                  | 4.66                                    |
|          | 100             | 74.84                              | 1.65                                 | 1.77   | 2.28   | 4.95                                  | 6.40                                    |
|          | 300             | 132.28                             | 2.63                                 | 2.57   | 3.50   | 7.20                                  | 9.79                                    |
|          | 500             | 171.51                             | 2.07                                 | 2.46   | 3.02   | 6.89                                  | 8.45                                    |
|          | 1000            | 243.11                             | 1.72                                 | 2.96   | 3.16   | 8.29                                  | 8.84                                    |
| B        | 25              | 23.66                              | 0.95                                 | 0.48   | 1.04   | 1.34                                  | 2.91                                    |
|          | 50              | 34.33                              | 0.94                                 | 0.56   | 1.07   | 1.57                                  | 2.99                                    |
|          | 100             | 49.61                              | 1.12                                 | 0.65   | 1.26   | 1.82                                  | 3.54                                    |
|          | 300             | 88.64                              | 1.39                                 | 0.88   | 1.59   | 2.45                                  | 4.46                                    |
|          | 500             | 115.48                             | 1.68                                 | 1.11   | 1.95   | 3.11                                  | 5.46                                    |
|          | 1000            | 164.38                             | 1.65                                 | 1.52   | 2.14   | 4.25                                  | 5.98                                    |
| C        | 25              | 27.62                              | 1.33                                 | 0.49   | 1.41   | 1.38                                  | 3.93                                    |
|          | 50              | 39.47                              | 1.14                                 | 0.50   | 1.22   | 1.39                                  | 3.43                                    |
|          | 100             | 56.66                              | 1.05                                 | 0.64   | 1.20   | 1.79                                  | 3.35                                    |
|          | 300             | 100.14                             | 1.25                                 | 0.81   | 1.44   | 2.26                                  | 4.03                                    |
|          | 500             | 130.19                             | 1.50                                 | 0.83   | 1.68   | 2.33                                  | 4.69                                    |
|          | 1000            | 184.84                             | 1.79                                 | 1.19   | 2.08   | 3.33                                  | 5.82                                    |
| D        | 25              | 31.04                              | 1.04                                 | 0.46   | 1.11   | 1.28                                  | 3.12                                    |
|          | 50              | 44.64                              | 0.85                                 | 0.46   | 0.95   | 1.30                                  | 2.65                                    |
|          | 100             | 64.22                              | 1.08                                 | 0.67   | 1.24   | 1.89                                  | 3.47                                    |
|          | 300             | 113.94                             | 0.94                                 | 0.82   | 1.19   | 2.29                                  | 3.33                                    |
|          | 500             | 148.16                             | 1.16                                 | 0.74   | 1.33   | 2.06                                  | 3.73                                    |
|          | 1000            | 210.10                             | 2.03                                 | 1.64   | 2.50   | 4.58                                  | 7.00                                    |
| E        | 25              | 20.02                              | 0.72                                 | 0.48   | 0.84   | 1.36                                  | 2.34                                    |
|          | 50              | 29.03                              | 1.00                                 | 0.48   | 1.09   | 1.34                                  | 3.05                                    |
|          | 100             | 42.21                              | 1.15                                 | 0.52   | 1.24   | 1.46                                  | 3.46                                    |
|          | 300             | 76.03                              | 1.00                                 | 0.53   | 1.11   | 1.48                                  | 3.10                                    |
|          | 500             | 99.25                              | 1.06                                 | 0.49   | 1.15   | 1.37                                  | 3.21                                    |
|          | 1000            | 141.67                             | 1.27                                 | 0.85   | 1.48   | 2.39                                  | 4.15                                    |
| T        | 25              | 17.14                              | 0.88                                 | 0.48   | 0.98   | 1.35                                  | 2.76                                    |
|          | 50              | 25.59                              | 1.03                                 | 0.47   | 1.12   | 1.32                                  | 3.12                                    |
|          | 100             | 37.20                              | 1.45                                 | 0.52   | 1.52   | 1.46                                  | 4.26                                    |
|          | 300             | 67.43                              | 1.39                                 | 0.65   | 1.51   | 1.82                                  | 4.22                                    |
|          | 500             | 88.27                              | 1.11                                 | 0.66   | 1.26   | 1.85                                  | 3.53                                    |
|          | 1000            | 126.96                             | 1.47                                 | 0.75   | 1.61   | 2.09                                  | 4.52                                    |

**TABLE X3.2 Precision statistics for an Interlaboratory Study of the Vickers Microindentation Hardness Test for Ferrous Specimens in Diagonal Units ( $\mu\text{m}$ )**

| Specimen | Test Force (gf) | Average Diagonal ( $\mu\text{m}$ ) | Standard Deviation ( $\mu\text{m}$ ) | Repeatability Standard Deviation ( $\mu\text{m}$ ) | Reproducibility Standard Deviation ( $\mu\text{m}$ ) | Repeatability Limit ( $\mu\text{m}$ ) | Reproducibility Limit ( $\mu\text{m}$ ) |
|----------|-----------------|------------------------------------|--------------------------------------|--|--|---------------------------------------|---|
|          |                 | $\bar{d}$                          | $S_x$                                | $S_r$  | $S_R$  | $r$                                   | $R$                                     |
| A        | 25              | 13.89                              | 0.75                                 | 0.30   | 0.80   | 0.85                                  | 2.24                                    |
|          | 50              | 19.81                              | 0.61                                 | 0.34   | 0.68   | 0.95                                  | 1.91                                    |
|          | 100             | 28.10                              | 0.57                                 | 0.45   | 0.70   | 1.26                                  | 1.96                                    |
|          | 300             | 49.19                              | 0.75                                 | 0.72   | 0.99   | 2.02                                  | 2.77                                    |
|          | 500             | 63.65                              | 0.81                                 | 0.88   | 3.16   | 2.47                                  | 1.13                                    |
|          | 1000            | 90.48                              | 0.98                                 | 1.31   | 1.53   | 3.66                                  | 4.28                                    |
| B        | 25              | 9.35                               | 0.40                                 | 0.25   | 0.46   | 0.69                                  | 1.28                                    |
|          | 50              | 13.06                              | 0.37                                 | 0.23   | 0.42   | 0.63                                  | 1.18                                    |
|          | 100             | 18.51                              | 0.39                                 | 0.39   | 0.52   | 1.09                                  | 1.47                                    |
|          | 300             | 32.11                              | 0.43                                 | 0.30   | 0.50   | 0.84                                  | 1.41                                    |
|          | 500             | 41.68                              | 0.51                                 | 0.36   | 0.60   | 1.00                                  | 1.69                                    |
|          | 1000            | 59.21                              | 0.55                                 | 0.52   | 0.72   | 1.46                                  | 2.03                                    |
| C        | 25              | 10.81                              | 0.53                                 | 0.19   | 0.56   | 0.54                                  | 1.56                                    |
|          | 50              | 15.13                              | 0.42                                 | 0.20   | 0.46   | 0.57                                  | 1.29                                    |
|          | 100             | 21.34                              | 0.40                                 | 0.22   | 0.45   | 0.62                                  | 1.25                                    |
|          | 300             | 36.85                              | 0.38                                 | 0.21   | 0.43   | 0.59                                  | 1.20                                    |
|          | 500             | 47.68                              | 0.55                                 | 0.24   | 0.59   | 0.67                                  | 1.64                                    |
|          | 1000            | 67.60                              | 0.58                                 | 0.33   | 0.65   | 0.93                                  | 1.83                                    |
| D        | 100             | 24.50                              | 0.43                                 | 0.29   | 0.50   | 0.82                                  | 1.40                                    |
|          | 300             | 42.52                              | 0.41                                 | 0.28   | 0.48   | 0.80                                  | 1.35                                    |
|          | 500             | 55.02                              | 0.50                                 | 0.25   | 0.55   | 0.70                                  | 1.54                                    |
|          | 1000            | 78.14                              | 0.70                                 | 0.34   | 0.77   | 0.97                                  | 2.15                                    |
| E        | 100             | 15.61                              | 0.40                                 | 0.18   | 0.43   | 0.52                                  | 1.20                                    |
|          | 300             | 27.25                              | 0.41                                 | 0.25   | 0.46   | 0.70                                  | 1.30                                    |
|          | 500             | 35.26                              | 0.43                                 | 0.20   | 0.46   | 0.55                                  | 1.30                                    |
|          | 1000            | 50.06                              | 0.41                                 | 0.24   | 0.46   | 0.67                                  | 1.29                                    |
| T        | 300             | 23.94                              | 0.47                                 | 0.17   | 0.49   | 0.49                                  | 1.38                                    |
|          | 500             | 31.00                              | 0.51                                 | 0.21   | 0.55   | 0.59                                  | 1.53                                    |
|          | 1000            | 44.12                              | 0.50                                 | 0.25   | 0.55   | 0.69                                  | 1.53                                    |

**TABLE X3.3 Precision statistics for an Interlaboratory Study of the Knoop Microindentation Hardness Test for Ferrous Specimens in Hardness units (HK)**

| Specimen | Test Force<br><br>(gf) | Average<br>Diagonal<br>( $\mu\text{m}$ )<br><br>$d$ | Standard<br>Deviation<br>(HK)<br><br>$S_x$ | Repeatability                              | Reproducibility                            | Repeatability         | Reproducibility       |
|----------|------------------------|---|--|--|--|-----------------------|-----------------------|
|          |                        |   |  | Standard<br>Deviation<br>(HK)<br><br>$S_r$ | Standard<br>Deviation<br>(HK)<br><br>$S_R$ | Limit (HK)<br><br>$r$ | Limit (HK)<br><br>$R$ |
| A        | 25                     | 35.61   | 22.07                                      | 11.35                                      | 24.29                                      | 31.56                 | 68.41                 |
|          | 50                     | 51.77   | 13.64                                      | 11.39                                      | 17.03                                      | 32.05                 | 47.98                 |
|          | 100                    | 74.84   | 11.20                                      | 12.02                                      | 15.49                                      | 33.68                 | 43.61                 |
|          | 300                    | 132.28  | 9.70                                       | 9.48                                       | 12.91                                      | 26.60                 | 36.21                 |
|          | 500                    | 171.51  | 5.84                                       | 6.94                                       | 8.52                                       | 19.45                 | 23.86                 |
|          | 1000                   | 243.11  | 3.41                                       | 5.86                                       | 6.26                                       | 16.43                 | 17.52                 |
| B        | 25                     | 23.66   | 51.07                                      | 25.79                                      | 55.92                                      | 72.09                 | 157.50                |
|          | 50                     | 34.33   | 33.07                                      | 19.70                                      | 37.65                                      | 55.27                 | 105.55                |
|          | 100                    | 49.61   | 26.11                                      | 15.15                                      | 29.38                                      | 42.45                 | 82.72                 |
|          | 300                    | 88.64   | 17.04                                      | 10.79                                      | 19.49                                      | 30.04                 | 54.74                 |
|          | 500                    | 115.48  | 15.52                                      | 10.26                                      | 18.02                                      | 28.75                 | 50.50                 |
|          | 1000                   | 164.38  | 10.57                                      | 9.74                                       | 13.71                                      | 27.24                 | 38.34                 |
| C        | 25                     | 27.62   | 44.96                                      | 16.55                                      | 47.67                                      | 46.65                 | 134.05                |
|          | 50                     | 39.47   | 26.39                                      | 11.57                                      | 28.24                                      | 32.19                 | 79.67                 |
|          | 100                    | 56.66   | 16.43                                      | 10.01                                      | 18.78                                      | 28.02                 | 52.50                 |
|          | 300                    | 100.14  | 10.63                                      | 6.89                                       | 12.24                                      | 19.22                 | 34.29                 |
|          | 500                    | 130.19  | 9.67                                       | 5.35                                       | 10.83                                      | 15.03                 | 30.26                 |
|          | 1000                   | 184.84  | 8.07                                       | 5.36                                       | 9.37                                       | 15.01                 | 26.24                 |
| D        | 25                     | 31.04   | 24.75                                      | 10.94                                      | 26.42                                      | 30.48                 | 74.60                 |
|          | 50                     | 44.64   | 13.60                                      | 7.36                                       | 15.20                                      | 20.80                 | 42.46                 |
|          | 100                    | 64.22   | 11.61                                      | 7.20                                       | 13.33                                      | 20.32                 | 37.34                 |
|          | 300                    | 113.94  | 5.43                                       | 4.73                                       | 6.87                                       | 13.22                 | 19.23                 |
|          | 500                    | 148.16  | 5.08                                       | 3.24                                       | 5.82                                       | 9.01                  | 16.32                 |
|          | 1000                   | 210.10  | 6.23                                       | 5.03                                       | 7.67                                       | 14.06                 | 21.49                 |
| E        | 25                     | 20.02   | 63.88                                      | 42.57                                      | 74.54                                      | 120.86                | 208.90                |
|          | 50                     | 29.03   | 58.20                                      | 27.92                                      | 63.44                                      | 78.02                 | 178.37                |
|          | 100                    | 42.21   | 43.53                                      | 19.68                                      | 46.94                                      | 55.28                 | 131.37                |
|          | 300                    | 76.03   | 19.43                                      | 10.30                                      | 21.56                                      | 28.76                 | 60.27                 |
|          | 500                    | 99.25   | 15.43                                      | 7.13                                       | 16.74                                      | 19.94                 | 46.74                 |
|          | 1000                   | 141.67  | 12.71                                      | 8.51                                       | 14.81                                      | 23.92                 | 41.55                 |
| T        | 25                     | 17.14   | 124.50                                     | 67.85                                      | 138.69                                     | 191.33                | 395.07                |
|          | 50                     | 25.59   | 87.53                                      | 39.91                                      | 95.19                                      | 112.23                | 266.90                |
|          | 100                    | 37.20   | 80.22                                      | 28.75                                      | 84.10                                      | 80.77                 | 237.05                |
|          | 300                    | 67.43   | 38.71                                      | 18.10                                      | 42.06                                      | 50.70                 | 117.74                |
|          | 500                    | 88.27   | 22.97                                      | 13.65                                      | 26.07                                      | 38.28                 | 73.09                 |
|          | 1000                   | 126.96  | 20.44                                      | 10.43                                      | 22.39                                      | 29.07                 | 62.90                 |

**TABLE X3.4 Precision statistics for an Interlaboratory Study of the Vickers Microindentation Hardness Test for Ferrous Specimens in Hardness units (HV)**

| Specimen | Test Force<br>(gf) | Average<br>Diagonal<br>( $\mu\text{m}$ ) | Standard<br>Deviation<br>(HV) | Repeatability<br>Standard<br>Deviation<br>(HV) | Reproducibility<br>Standard<br>Deviation<br>(HV) | Repeatability<br>Limit (HV) | Reproducibility<br>Limit (HV) |
|----------|--------------------|--|-------------------------------|--|--|-----------------------------|-------------------------------|
|          |                    | $d$                                      | $S_x$                         | $S_r$  | $S_R$  | $r$                         | $R$                           |
| A        | 25                 | 13.89                                    | 25.99                         | 10.38  | 27.73  | 29.46                       | 78.52                         |
|          | 50                 | 19.81                                    | 14.56                         | 8.11   | 16.23  | 22.69                       | 45.77                         |
|          | 100                | 28.10                                    | 9.53                          | 7.52   | 11.70  | 21.08                       | 32.84                         |
|          | 300                | 49.19                                    | 7.01                          | 6.73   | 9.26   | 18.90                       | 25.94                         |
|          | 500                | 63.65                                    | 5.83                          | 6.33   | 22.75  | 17.78                       | 8.13                          |
|          | 1000               | 90.48                                    | 4.91                          | 6.56   | 7.66   | 18.34                       | 21.45                         |
| B        | 25                 | 9.35                                     | 45.41                         | 28.37  | 52.24  | 78.48                       | 146.56                        |
|          | 50                 | 13.06                                    | 30.81                         | 19.15  | 34.98  | 52.51                       | 98.63                         |
|          | 100                | 18.51                                    | 22.81                         | 22.81  | 30.42  | 63.85                       | 86.24                         |
|          | 300                | 32.11                                    | 14.45                         | 10.08  | 16.81  | 28.24                       | 47.43                         |
|          | 500                | 41.68                                    | 13.06                         | 9.22   | 15.37  | 25.62                       | 43.32                         |
|          | 1000               | 59.21                                    | 9.83                          | 9.29   | 12.87  | 26.09                       | 36.29                         |
| C        | 25                 | 10.81                                    | 38.95                         | 13.95  | 41.16  | 39.69                       | 115.71                        |
|          | 50                 | 15.13                                    | 22.50                         | 10.71  | 24.64  | 30.54                       | 69.32                         |
|          | 100                | 21.34                                    | 15.27                         | 8.40   | 17.18  | 23.67                       | 47.79                         |
|          | 300                | 36.85                                    | 8.45                          | 4.67   | 9.56   | 13.12                       | 26.70                         |
|          | 500                | 47.68                                    | 9.41                          | 4.11   | 10.09  | 11.46                       | 28.07                         |
|          | 1000               | 67.60                                    | 6.96                          | 3.96   | 7.80   | 11.17                       | 21.98                         |
| D        | 100                | 24.50                                    | 10.85                         | 7.31   | 12.61  | 20.69                       | 35.36                         |
|          | 300                | 42.52                                    | 5.93                          | 4.05   | 6.95   | 11.58                       | 19.55                         |
|          | 500                | 55.02                                    | 5.57                          | 2.78   | 6.12   | 7.79                        | 17.15                         |
|          | 1000               | 78.14                                    | 5.44                          | 2.64   | 5.99   | 7.54                        | 16.72                         |
|          | 1000               | 15.61                                    | 39.01                         | 17.55  | 41.94  | 50.73                       | 117.35                        |
| E        | 300                | 27.25                                    | 22.55                         | 13.75  | 25.30  | 38.50                       | 71.56                         |
|          | 500                | 35.26                                    | 18.19                         | 8.46   | 19.46  | 23.27                       | 55.03                         |
|          | 1000               | 50.06                                    | 12.12                         | 7.10   | 13.60  | 19.81                       | 38.15                         |
|          | 1000               | 23.94                                    | 38.12                         | 13.79  | 39.74  | 39.74                       | 112.09                        |
| T        | 500                | 31.00                                    | 31.75                         | 13.07  | 34.24  | 36.73                       | 95.35                         |
|          | 1000               | 44.12                                    | 21.59                         | 10.80  | 23.75  | 29.80                       | 66.11                         |

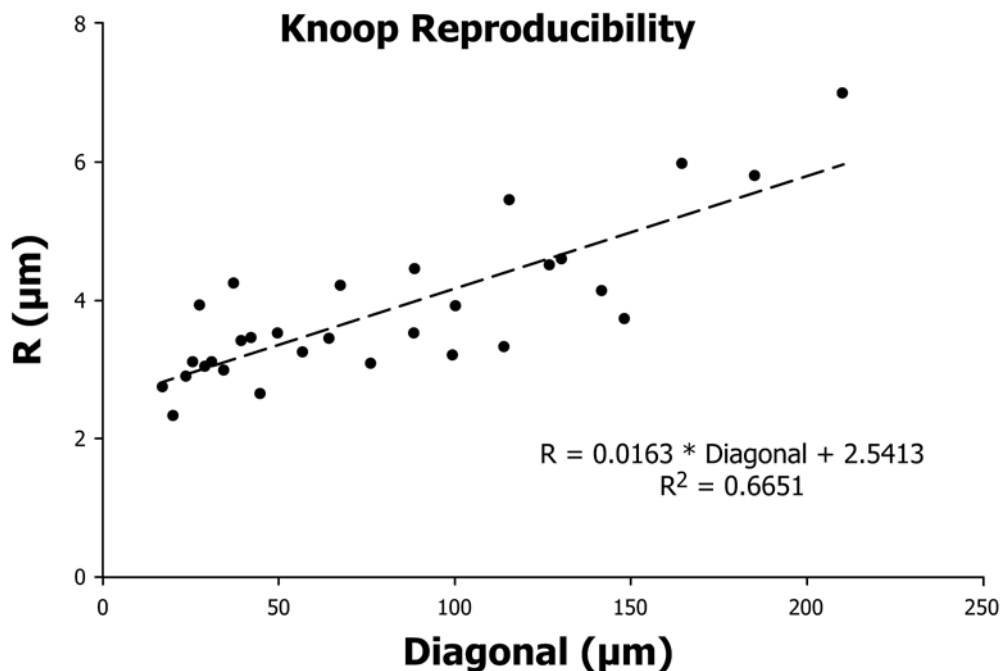

**FIG. X3.1 The Relationship between Reproducibility (R) and Diagonal length ( $d$ ) from Table X3.1 in  $\mu\text{m}$  units, for the Knoop Hardness Tests for Specimens B, C, D, E and T**



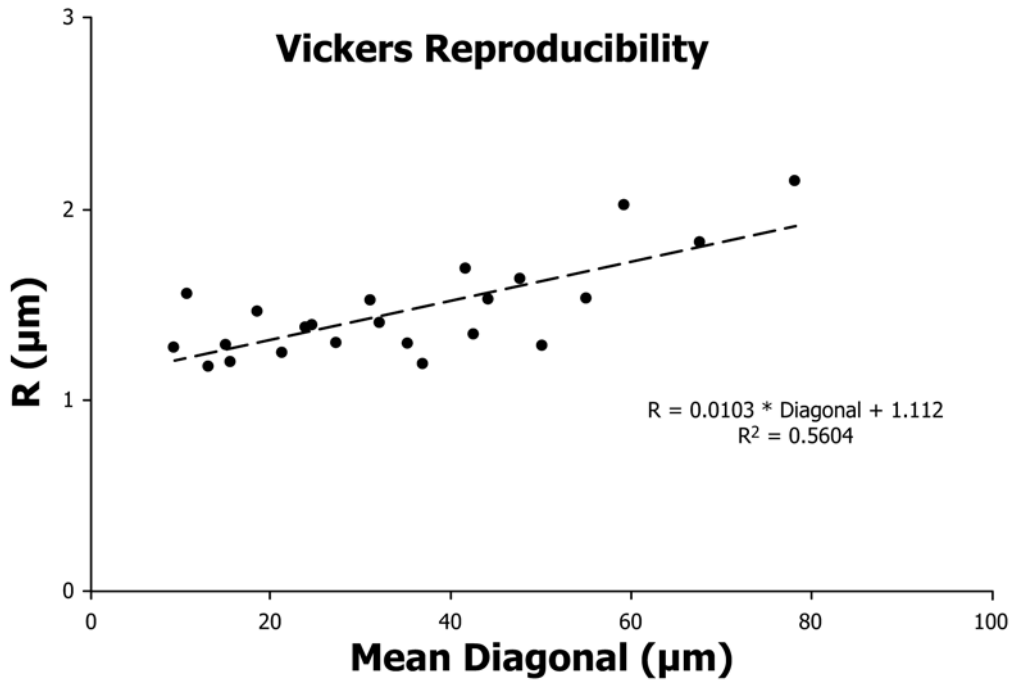

FIG. X3.2 The Relationship between Reproducibility and Diagonal length ( $d$ ) from Table X3.2 in  $\mu\text{m}$  units, for the Vickers Hardness Tests for Specimens B, C, D, E and T

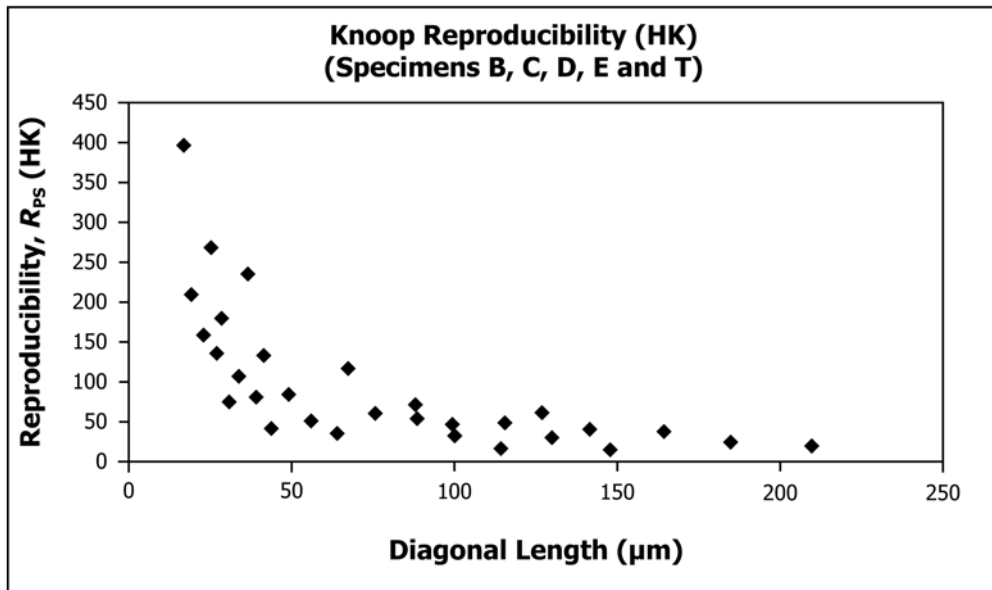

FIG. X3.3 The Relationship between Reproducibility ( $R$ ) and Diagonal length ( $d$ ) from Table X3.3 in HK units, for the Knoop Hardness Tests for Specimens B, C, D, E and T

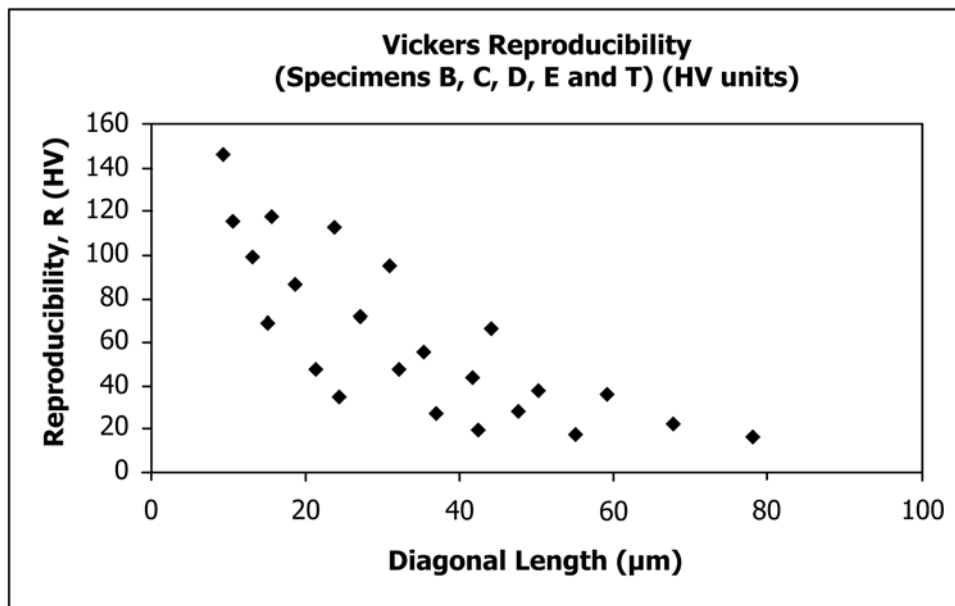

FIG. X3.4 The Relationship between Reproducibility (R) and Diagonal length (d) from Table X3.4 in HV units, for the Vickers Hardness Tests for Specimens B, C, D, E and T

#### X4. RECOMMENDATIONS FOR LIGHT FORCE MICROINDENTATION HARDNESS TESTING

##### X4.1 Introduction

X4.1.1 Microindentation hardness of materials can be determined using a variety of loads to force the indenter into the test piece. Testing is considered to be using a light force when the force in use produces indentations with a diagonal length of less than 20 µm. Both Knoop and Vickers hardness numbers increase in proportion to the inverse of the square of the indentation diagonal length, Eq 2 and Eq 7. Thus, hardness numbers obtained from indentations with diagonals measuring less than 20 µm are much more sensitive to variations of a few tenths of a micrometer in the actual or measured length of the diagonals than hardness numbers obtained by measuring larger indentations. Creation of valid indentations, and the accurate measurement of their diagonals, becomes even more imperative as the indentations become smaller. For example, consider a material with a Vickers hardness of 500. For a force of 100 gf, the diagonal length would be 19.258 µm. To maintain an error of ± 1 %, the accuracy of the diagonal measurement must be ≤ 0.096 µm. Similarly, for a material with a Knoop hardness of 500, when tested with a 20 gf force, the diagonal length would be 23.86 µm. To maintain an error of ± 1 %, the accuracy of the diagonal measurement has to be ≤ 0.12 µm. Measurements to this level of accuracy are impossible to achieve by light optical microscopy. Because of the inherent difficulties involved in obtaining and measuring indentations with diagonals less than 20 µm, and the increasing effect of possible indentation or measurement errors, light force micro-indentation hardness testing requires precautions in addition to those normally necessary. Small indentations may be due to high test piece hardness or the use of light forces, or both. In either case, some of the concerns involved with obtaining accurate hardness results are addressed in this appendix.

##### X4.2 Scope

X4.2.1 These recommendations provide guidance and suggest additional precautions for microindentation hardness testing when the measured indentation diagonals are less than 20 µm in length.

##### X4.3 Environment

###### X4.3.1 *Vibration:*

X4.3.1.1 Vibration of the microindentation hardness tester during a light force test can cause a large percentage increase in the measured diagonals. Reasonable accuracy and precision can only be achieved when the test instrument is isolated from vibration as much as possible during testing. Use of an isolation table or isolation platform is mandatory. Airborne vibrations in the vicinity of the test instrument, such as air currents and loud noises, are to be avoided.

X4.3.1.2 It is recommended that test instruments not be located above the ground floor of the building due to the increase in vibration usually experienced by the upper floors. Test instruments should be located in areas away from machinery that may cause low (<20 Hz) frequency vibrations, since low frequencies are more easily transmitted through isolation tables and platforms.

X4.3.2 *Level*—Microindentation hardness testers must be level in order to obtain usable information. Errors due to minor un-leveling become more important as the forces become lighter.

X4.3.3 *Temperature*—Control of the temperature of the specimen, testing instrumentation, and surrounding area should be considered. It is recommended that these temperatures be maintained at 23 ± 3°C. As the length of the measured

diagonal becomes smaller, it may be necessary to increase control of temperature to reduce variability.

## X4.4 Specimens

### X4.4.1 Specimen Preparation:

X4.4.1.1 Usually, test pieces require mounting. Care must be taken to ensure that the specimens are well supported in the mounting material, and that the surface to be tested can be placed into the test instrument such that it will be normal to both the loading and optical axes.

X4.4.1.2 The surface properties of the test specimen must not be altered due to specimen preparation. Metallographic specimen preparation should be performed using accepted techniques known to eliminate all preparation-induced deformation on the test surface of the specimen. Light etching followed by light re-polishing may be used to further decrease the thickness of any deformed layer. Electropolishing may provide surfaces essentially free of deformation due to preparation when properly performed. Areas to be tested must appear flat in the field of focus of the microscope used to measure the diagonals of the indentations.

X4.4.1.3 The surfaces to be tested should be as clean as possible. Care must be taken to avoid surface contaminants that may be absorbed into the surfaces of some materials such as polymers or ceramics.

X4.4.2 *Microstructure of Specimen*—If the microstructure of the test piece is on the same size scale as the indentation diagonal length, an increase in the variability of the hardness data should be expected. Indentations placed within a single grain will experience resistance to deformation somewhat dependent on the orientation of that grain to the test surface. Since these orientations are normally random, variability of results is increased. Indentation diagonal lengths can vary depending upon the number of grain boundaries traversed by the indentation. Multiphase material systems will provide indentation diagonal lengths that may be proportional to the volume percentage of each phase included within the volume of deformation caused by the indentation. In the above cases, an increase in the number of measurements taken will be necessary to provide meaningful results.

## X4.5 Instruments

X4.5.1 *Magnification of Microscope*—Classic microindentation hardness testers make use of optics that usually provide magnifications from 400 to 600 $\times$ . Higher magnifications are required when performing light force testing. Specimens may be removed from the test instrument following the indentation operation, and the diagonals of the indentations measured using a separate high quality light (or SEM measurements, see X4.7.1) microscope capable of providing higher magnifications.

X4.5.2 *Optical Quality of Microscope*—Use of highly corrected objectives with numerical apertures of 0.9 or greater is recommended. Use of dark field illumination or differential interference contrast may improve the contrast of the image and also enhance the user's ability to detect the ends of the indentations.

X4.5.3 *Diagonal Measuring Device*—The measurement technique and the devices used to perform the measurements should be capable of discerning differences in length of 0.1  $\mu\text{m}$  or less. In some cases, it may be preferable to obtain a photomicrograph of the indentation first, and measure the length of the diagonal as seen in the photomicrograph. In all cases, calibration of magnifications and measuring devices is necessary.

X4.5.4 *Accuracy of Forces*—Often, small indentation diagonal lengths are the result of the use of very light forces, in many cases 10 gf or less. Force accuracy of  $\pm 1.5\%$  is required. For light forces, this requires that no oils, dust, or other minor contaminants be present. For example, when using a force of 2.0 g, contaminants with a total mass of more than 0.02 g render the results of the test invalid.

X4.5.5 *Loading Rates*—When using light forces, the impact of the indenter on the surface of the test piece can cause significant inaccuracies to occur. Use of the slowest loading rate available for each instrument is recommended.

X4.5.6 *Indenters*—Greater repeatability, accuracy, and precision may be obtained by the careful selection of indenters. Verification of the included angles of the faces, the degree of mismatch at the vertex, and the sharpness of the edges are appropriate criteria for the selection of indenters. Using the manufacturer's certification, the exact indenter constant should be calculated and used to minimize errors.

## X4.6 Measurement of Indentations

X4.6.1 Indentations that do not appear symmetrical should not be considered valid for diagonal measurement. A difference in symmetry greater than 10 % should be addressed with concern. If consistently asymmetrical indentations are obtained, the alignment of the specimen to the indenter should be adjusted. If the problem persists, the microindentation hardness instrument should be serviced by a qualified technician.

## X4.7 Scanning Electron Microscope

X4.7.1 Measurement of indentation diagonals using a scanning electron microscope is possible. However, careful calibration of the SEM photographic image at the exact magnification to be used is essential. For these measurements, the specimen must be perpendicular to the beam, that is, the tilt angle should be 0°. The accelerating voltage and other parameters should remain as they were for calibration. (The SEM should be calibrated in both the *X* and the *Y* directions; refer to Practice E766. Indentations to be measured should not extend to the periphery of the SEM field of view, as the video signal can be distorted at the edges of the video monitor.

## X4.8 Video and Automatic Measuring Systems

X4.8.1 Typical video or computerized measuring systems lack the necessary resolution for obtaining acceptable results when indentation diagonal lengths are less than 20  $\mu\text{m}$ . Loss of resolution within the digitized image can cause a substantial decrease in the accuracy of the measurement. Extremely high resolution video cameras and monitors, when appropriately

assembled into a measuring system, may be capable of resolution sufficient to provide accurate results.

**X5. A PRIMER ON CHOOSING THE INDENTER AND TEST FORCE**

**X5.1 Introduction**

X5.1.1 Users of E384 often ponder over which indenter they should use for a given problem and also which test force is best for a given evaluation task. Although it has been claimed that etching of a specimen can lead to bad hardness data, is that only true for a deeply etched specimen, or for all etched specimens? The constancy of Vickers hardness over a wide test load range has been claimed to be poor for forces  $\leq 100$  gf. Knoop hardness does vary with test load, but by how much? Can anything be done to determine  $HK_{500}$  equivalent data at lower applied forces? This appendix offers examples for users to study and pick up advice to help them find solutions as effectively as possible.

**X5.2 Influence of the Equations Defining HV and HK on Precision**

X5.2.1 The basic definitions of HK and HV, where the applied force is multiplied by a geometric constant (Eq 2 and Eq 7, respectively) and then divided by the long diagonal squared or the mean diagonal squared, respectively, cause an inherent problem in measuring small indents, that is diagonals  $\leq 20$   $\mu\text{m}$  in length. Fig. X5.1 shows the calculated relationship between the diagonal and load and the resulting hardness for

Knoop indents while Fig. X5.2 shows this relationship for Vickers indents. As the test load decreases, and the hardness rises, the slope of the curves for diagonal versus hardness becomes nearly vertical. Hence, in this region, small variations in diagonal measurements will result in large calculated hardness variations.

X5.2.2 If we assume that the repeatability of the diagonal measurement by the average user is about  $\pm 0.5$   $\mu\text{m}$ , and we add and subtract this value from the long diagonal length or the mean diagonal length, we will calculate two hardness values. The difference between these values is  $\Delta HK$  and  $\Delta HV$ , shown in Fig. X5.3 and Fig. X5.4. From these two figures, we can see how the steepness of the slopes shown in Fig. X5.1 and Fig. X5.2 will affect the possible range of obtainable hardness values as a function of the diagonal length and test force for a relatively small measurement imprecision,  $\pm 0.5$   $\mu\text{m}$ . These figures show that the problem is greater for the Vickers indenter than for the Knoop indenter for the same diagonal length and test force. For the same specimen and the same test force, the long diagonal of the Knoop indent is 2.7 times greater than the mean of the Vickers' diagonals, as shown in Fig. X5.5.

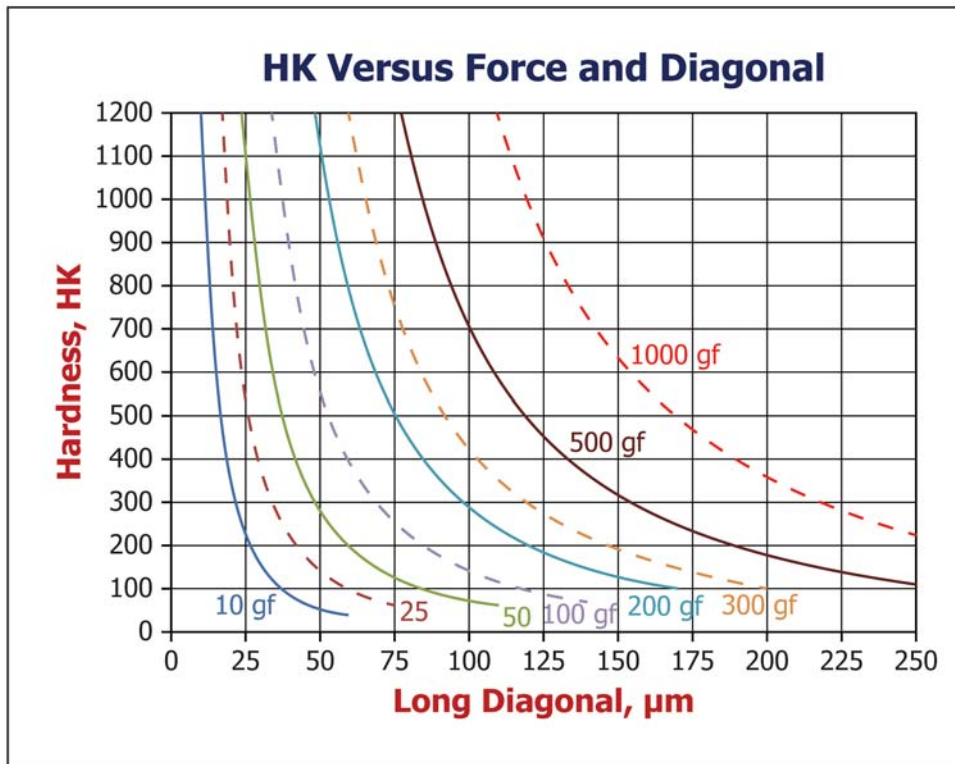

FIG. X5.1 Relationship between the long diagonal length and the Knoop hardness as a function of the test force. Note how the slope of the lines becomes more vertical as the test force decreases.

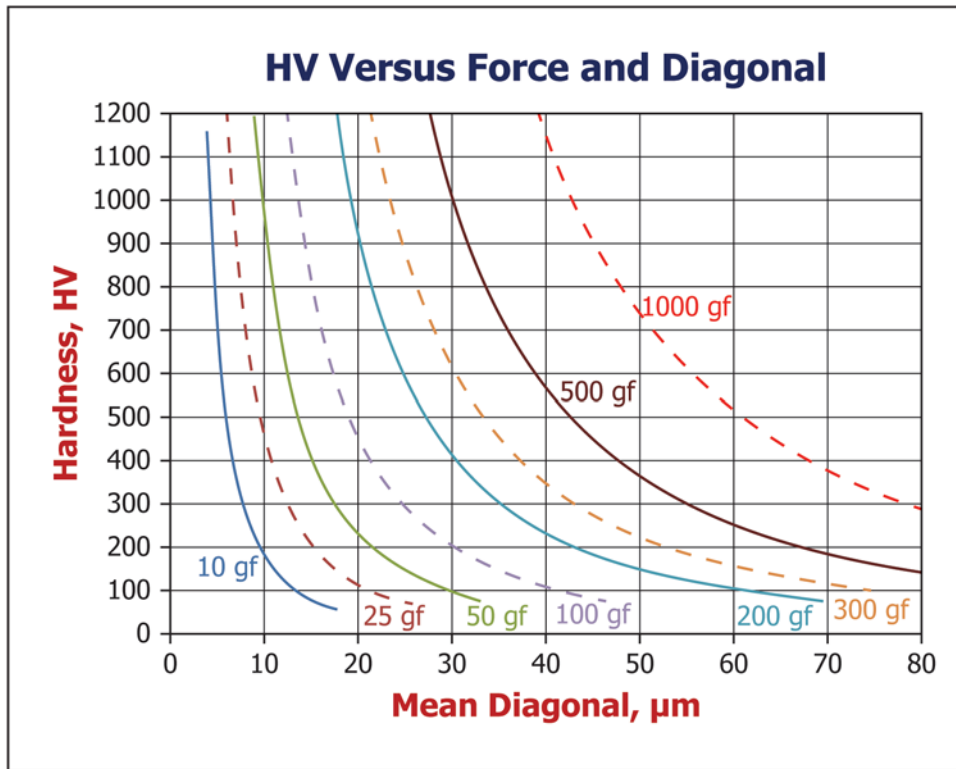

FIG. X5.2 Relationship between the mean diagonal length and the Vickers hardness as a function of the test force. Note how the slope of the lines becomes more vertical as the test force decreases.

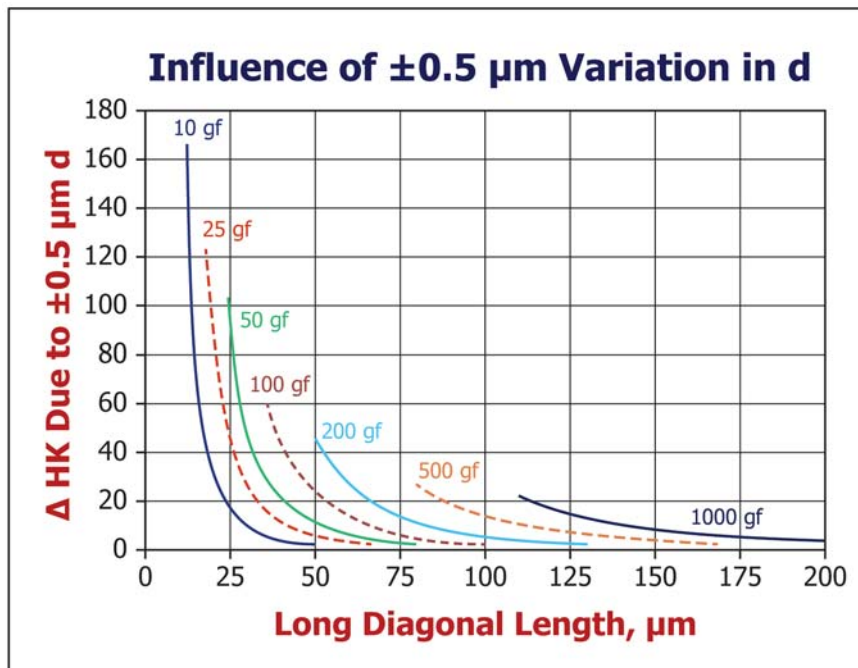

FIG. X5.3 Plot showing the possible range of Knoop hardness due to a  $\pm 0.5 \mu\text{m}$  measurement imprecision as a function of the diagonal length and the applied test force. The results are plotted for materials with a maximum HK of 1100-1200. Note that the problem for specimens with diagonals  $\leq 20 \mu\text{m}$  is greatest for 10 and 25 gf test loads

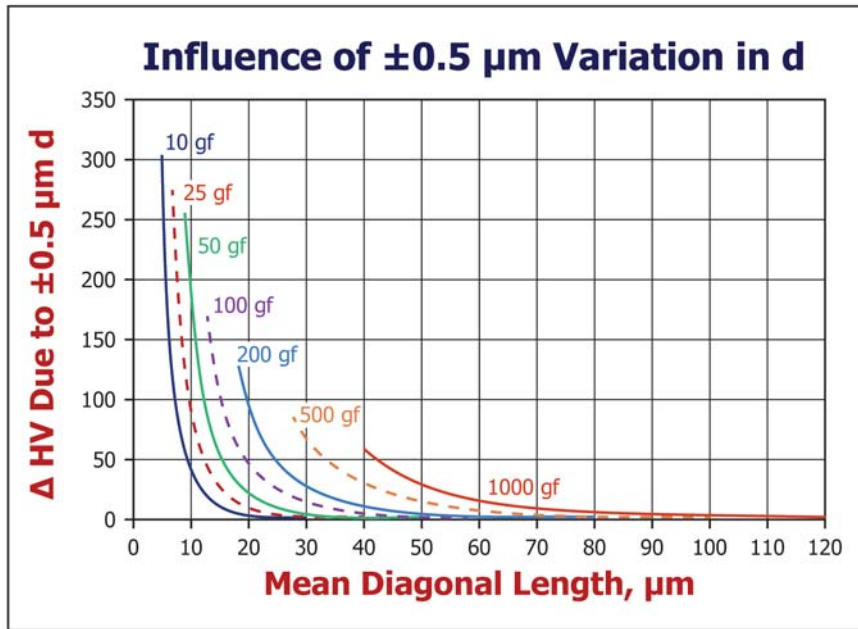

FIG. X5.4 Plot showing the possible range of Vickers hardness due to a  $\pm 0.5 \mu\text{m}$  measurement imprecision as a function of the diagonal length and the applied test force. The results are plotted for materials with a maximum HV of 1100-1200. Note that the problem for specimens with diagonals  $\leq 20 \mu\text{m}$  is greatest for 10 to 100 gf test loads.

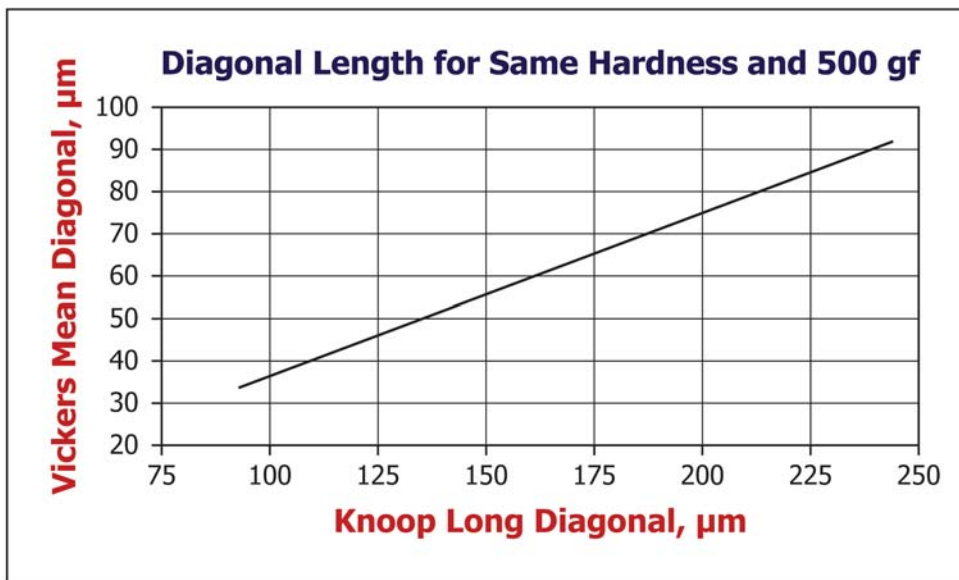

FIG. X5.5 Relationship between the Knoop long diagonal and the mean Vickers diagonal for equivalent hardness (per E 140) at a 500 gf test load. The Knoop diagonal is 2.7 times longer than the Vickers diagonal.

### X5.3 Consistency in HV for Specimens as a Function of Test Force and the “Load-Hardness” Problem

X5.3.1 Numerous studies of Knoop and Vickers tests made on metals over a range of hardness and test forces have shown an inconsistency in the hardness values, the so-called “load-hardness” problem. For the Knoop indenter, because the indent cavity is not geometrically identical as a function of indent depth, the hardness should vary somewhat with test force. Because of the difficulty in measuring small indents, and the influence of small variations in measurement, this inconsistency would be expected to be greater for high hardness

materials than for soft materials. On the other hand, the Vickers indenter does produce geometrically identically-shaped indent cavities as a function of depth, so the Vickers hardness should be constant with test force. However, many studies conducted using test forces  $\leq 1000 \text{ gf}$  have shown deviations from constancy at test loads  $\leq 100 \text{ gf}$ . In almost all cases, this problem has been attributed to interactions between dislocations and the indenter at these low loads. A review of more than 60 publications (9) about such studies has revealed four different published load-HV trends. They are (from most common to least common): (1) at test loads  $\leq 100 \text{ gf}$ , the HV

decreases; (2) at test forces  $\leq 100$ -200 gf, the HV rises slightly and then decreases; (3) at test loads  $\leq 100$  gf, the HV increases; and, 4) at test forces from 1000 gf to either 10 or 25 gf, the HV was constant. Trend number 1 was by far the most commonly observed trend. An example of such a study (9) is shown in Fig. X5.6. In this experiment, five indents made at each test force, from 5 to 500 gf, were measured at 500X magnification using five HRC test blocks covering a wide hardness range. Note that trends 1 and 2 are observed in this data. In the interlaboratory study (see Appendix X1 and (7, 8)), all four trends were observed for the same indents measured by different laboratories. The literature claimed that macro-Vickers testers were immune from this problem, however, no published examples of work like that shown in Fig. X5.6 could be found in the literature for macro-Vickers testers using test loads from 1 to 120 kgf, or from 1 to 50 kgf. Consequently, the same HRC test blocks were evaluated as a function of applied test force from 1 to 50 kgf revealing results (9), shown in Fig. X5.7, that exhibit trends 1 and 2. These indents were measured using 100X magnification, typically used with macro-Vickers systems. These results clearly suggest that the inconsistency in HV at low test loads is a visual perception problem due to inadequate resolution and perhaps inadequate image contrast.

X5.3.2 If higher magnification optics with high numerical aperture ratings are utilized, can the “load-hardness” problem be overcome? To test this, Vickers indents (six at each test load) were made over a range of test forces varying from 10 gf to 10 kgf and the indents were measured with objectives varying from 10X to 100X using four HRC test blocks with a range of hardness (10). Fig. X5.8 shows that the results were much better than those shown in Fig. X5.6 (5 to 500 gf) and Fig. X5.7 (1 to 50 kgf). All indents made with a 10 gf load were  $< 8 \mu\text{m}$  in length; all of the indents made with a 25 gf load were

$< 12.5 \mu\text{m}$  in length; and, all indents made with a 50 gf load were  $< 17.5 \mu\text{m}$  in length. Despite these very small sizes due to the light loads, measurements using a 100X objective (0.95 NA) gave reasonably good data. The overall results are much better than the results in Fig. X5.6 and Fig. X5.7, as well those reported in (7, 8), the first interlaboratory study (Research Report RR:E04-1004).<sup>8</sup>

### X5.4 Variability in HK as a Function of Applied Force

X5.4.1 Unlike the Vickers square-based indenter, the rhombohedral-shaped Knoop indenter does not produce geometrically identical indent cavities as a function of depth and the hardness should vary with the applied force. In general, this variation is small over the range from 200 to 1000 gf. As the force decreases below 200 gf, the increase in HK becomes greater. Unlike the Vickers indents, the Knoop indents are more likely to be undersized than oversized when they are smaller in size. This error also increases the HK value and adds to the usual upward trend observed as the test force decreases. The literature contains many examples of this trend. However, in the first interlaboratory test (7, 8) (see Appendix X1 and Research Report RR: RR:E04-1004) a few laboratories actually showed the opposite trend, decreasing HK with decreasing test force below 200 gf, never published previously. The four test blocks evaluated for Vickers hardness, Fig. X5.8, were also evaluated for Knoop hardness, using six indents at each test force and a range from 10 to 1000 gf. The results are shown in Fig. X5.9. All of the indents made with a 10 gf load were  $< 20 \mu\text{m}$  in length; all of the indents made with a 25 gf load were

<sup>8</sup> Supporting data have been filed at ASTM International Headquarters and may be obtained by requesting Research Report RR:E04-1004. Contact ASTM Customer Service at [service@astm.org](mailto:service@astm.org).

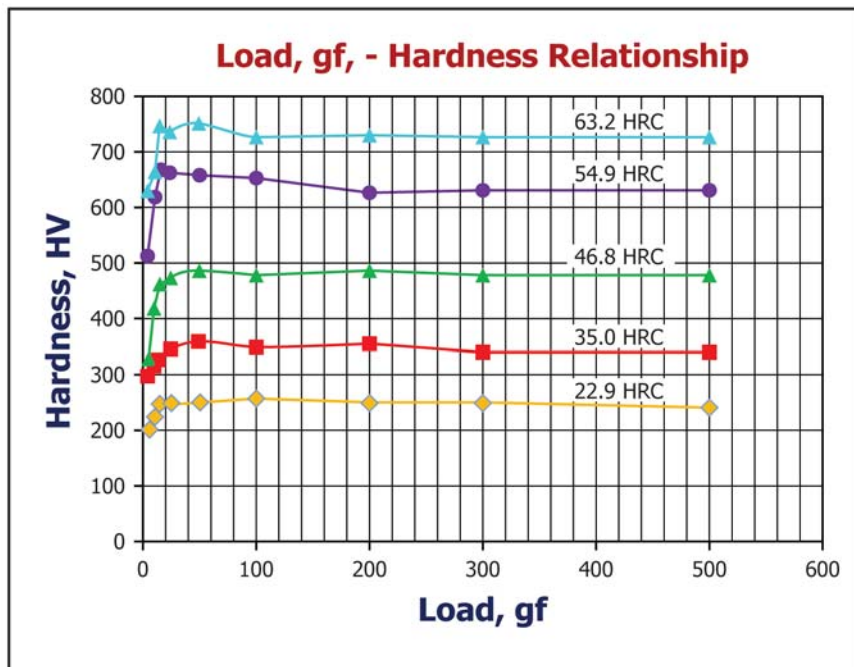

FIG. X5.6 Vickers hardness as a function of test load from 5 to 500 gf for five HRC test blocks revealing trends 1 and 2. Measurements were made at 500X.

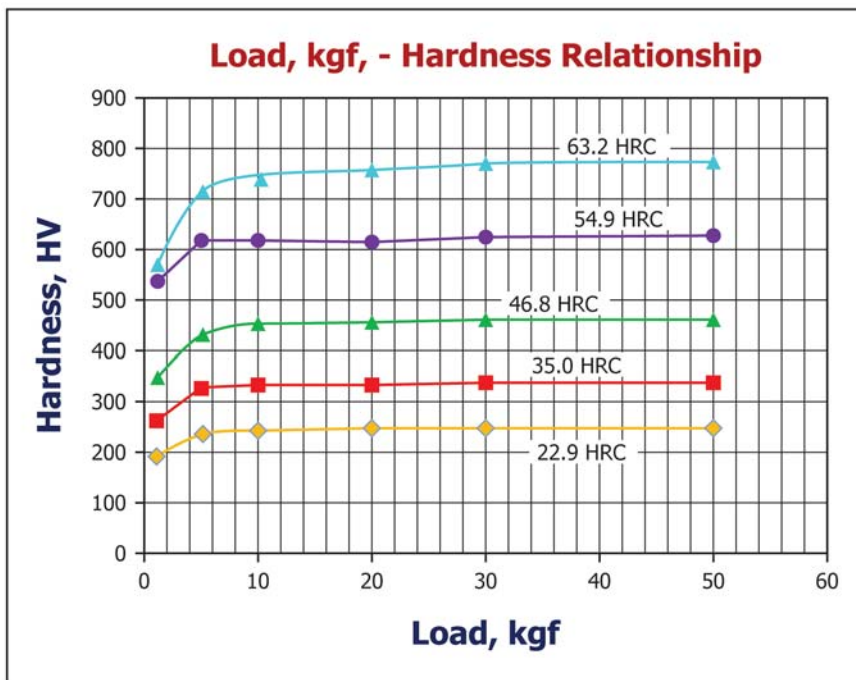

FIG. X5.7 Vickers hardness as a function of test load from 1 to 50 kgf for five HRC test blocks revealing trends 1 and 2. Measurements were made at 100X.

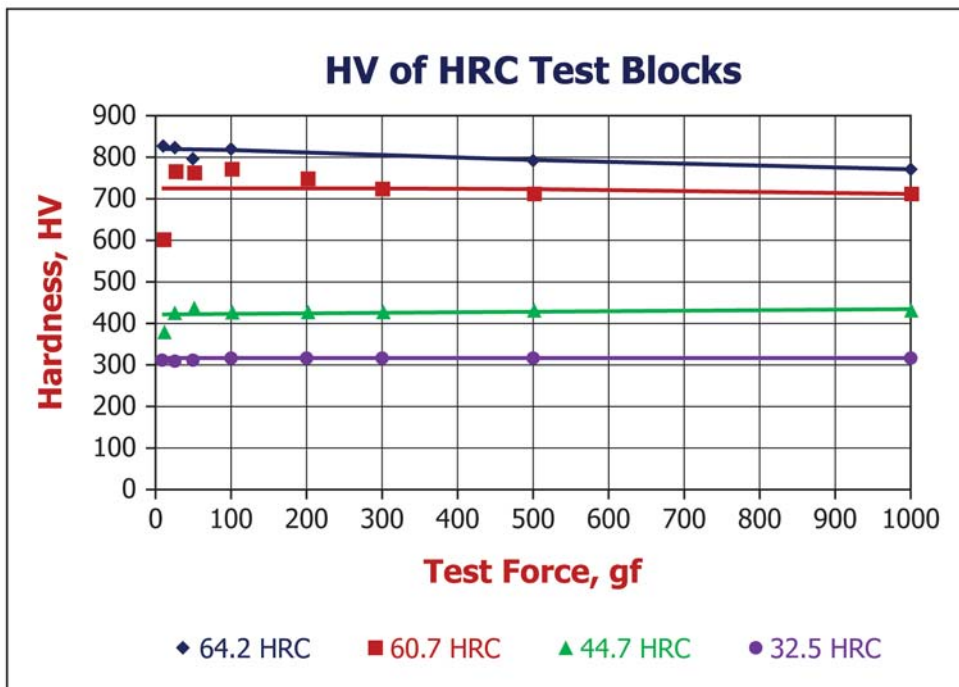

FIG. X5.8 Vickers indents made on four HRC test blocks at test forces from 10 gf to 10 kgf and measured using 10X to 100X objectives. The indents made with test forces of 10, 25, 50 and 100 gf averaged ~4.7 to 7.7  $\mu\text{m}$ , ~7.5 to 12.2  $\mu\text{m}$ , ~10.8 to 17.2  $\mu\text{m}$  and ~15.0 to 24.3  $\mu\text{m}$  for the four blocks – all but the 100 gf tests for the 44.7 and the 32.5 HRC test blocks were in the range  $\leq 20 \mu\text{m}$  where measurements are very difficult.

<31  $\mu\text{m}$  in length; all of the indents made with a 50 gf load were <45  $\mu\text{m}$  in length; and, all of the indents made with a 100 gf load were <65  $\mu\text{m}$  in length. For the same specimen and test load, the Knoop long diagonal is ~2.7 times longer than the Vickers mean diagonal which improves the precision in deter-

mining HK values, versus HV values, at low loads. However, the variation in HK with test force is a constraint to using the Knoop test at varying test loads and then trying to compare that data to results from other hardness scales. Being able to correct for this deviation would be advantageous.



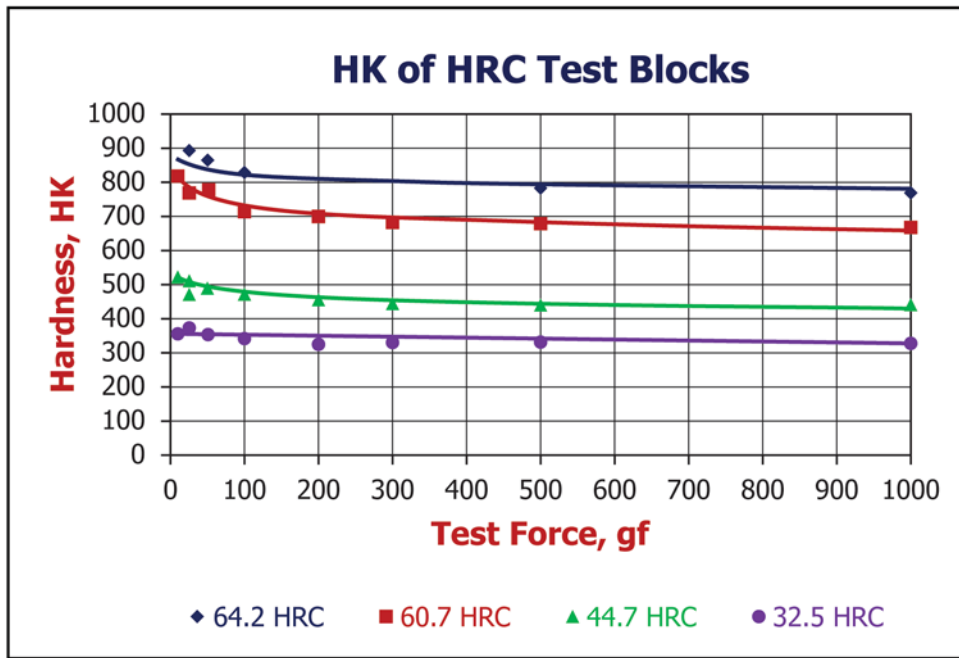

FIG. X5.9 Knoop hardness indents were made on four HRC test blocks at test forces from 10 to 1000 gf and were measured using 10X to 100X objectives. The indents made with test forces of 10, 25, 50 and 100 gf averaged ~13.2 to 19.9µm, ~20 to 30.7 µm, ~28.7 to 44.5 µm and ~41.4 to 64.4µm for the four blocks – only the 10 gf values had long diagonal lengths <20 µm.

### X5.5 Examples of the Use of HK and HV at Various Loads to Evaluate Specimens

X5.5.1 The metallographer is often required to use micro-indentation testing as an aid to solving various characterization tasks both for research purposes and in production work for process control and specification conformance. There are many such processes that are evaluated both metallographically and by microindentation hardness testing; for example, case hardening by flame or induction heating, surface compositional modifications followed by heat treatment, as in carburizing or carbonitriding, or preceded by heat treatment, as in nitriding. Banding and other forms of segregation are evaluated both

metallographically and by microindentation hardness testing. A few examples will be presented as an aid to the user.

X5.5.2 Induction hardening is widely performed but control of the process can be challenging because the heat is applied for only a few seconds and there will be a substantial temperature gradient from the surface inward. Fig. X5.10 shows evaluation of the induction hardened case of 1053 carbon steel using Knoop and Vickers indents. The Knoop hardness for indents made at 50 gf applied force are consistently greater than the 200 gf Knoop values, a classic problem with the Knoop test. The Vickers data at 100 and 200 gf is in better agreement, but there are numerous locations where the

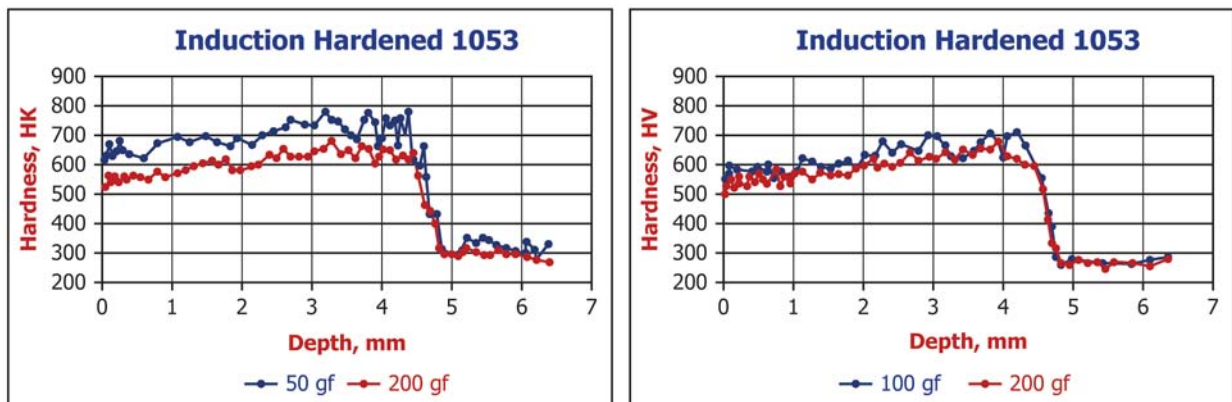

FIG. X5.10 Knoop testing at 50 and 200 gf (left) is compared to Vickers testing at 100 and 200 gf (right) revealing relatively similar hardness trends and illustration of the change from the hardened case to the unhardened core at the same location. Note the characteristic increase in hardness from the surface to the end of the case. The Knoop indents reveal more of the minor hardness variability but the 50 gf data are higher for the case than the 200 gf data, which is to be expected for the Knoop test. If the depth to an equivalent HRC value must be determined, the increase in HK as the load decreases below 500 gf must be corrected in some way. The Vickers data at 100 and 200 gf are in good agreement, although some of the 100 gf data points are higher.

100 gf HVs are significantly higher than the 200 gf HVs. For both tests, it is clear that the surface hardness is lower than at the end of the case due to the temperature gradient and its affect on grain size and retained austenite content. The transition from the case to core is defined well by both tests. The core hardness defined by both tests at all test loads are in good agreement, mainly due to the larger size of the lower hardness core indents.

X5.5.3 Carburized specimens are commonly evaluated metallographically and by microindentation hardness tests. Fig. X5.11 shows evaluation of the carburized case after a subsequent hardening treatment for an 1141 carbon steel using Knoop tests at 100, 200, 300 and 500 gf and Vickers tests at 200, 300 and 500 gf. For the Vickers tests, a test force of 100 gf gave indent diagonals <20 μm. Consequently 100 gf HV was not used. The Knoop data at the four test loads does show a continuous increasing hardness trend with decreasing test force, as expected, while the Vickers data at the three test loads also shows some variation in HV, but less than the HK data. Both sets of data show a drop in hardness near the extreme surface, but this is defined better with the Knoop data, except for the 200 gf data. As these tests were performed at different locations along the surface, the 200 gf result at the surface could be due to a composition/microstructural difference at that location. The Knoop surface hardness data for the 300 and 500 gf indents are identical.

X5.5.4 Nitrided parts are also frequently evaluated both metallographically and with microindentation hardness tests to define the effective case depth. There are a number of nitriding processes and some, like ion-nitriding and ferritic nitro-carburizing, do exhibit very thin cases where the Knoop indent is required. Those with thicker cases, such as the nitrided H13 mold (no compound layer) shown in Fig. X5.12, can be evaluated using either the Knoop or the Vickers indenter. As expected, the HK values using test forces from 100 to 500 gf show a wider spread in HK at all locations compared to the HV data. For the HK data, the maximum case hardness was obtained at a depth of 0.021, 0.030, 0.045 and 0.050 mm for

applied loads from 100 to 500 gf. For the HV data, the maximum case hardness was obtained with the first indent at 0.0127 mm for the 100 gf data, while the higher applied forces revealed decreased hardness at the extreme surface with the maximum case hardness at: 0.050, 0.051 and 0.050 mm for applied loads of 200, 300 and 500 gf. The average case hardness, Fig. X5.13, except for the 100 gf data, was higher for the HV data than for the HK data. The conversion tables in E140 list that the HV equivalent hardness is higher than the equivalent HK equivalents for 67 and 68 HRC, while for 66 HRC and below, the equivalent HK value is greater than the equivalent HV value. The tests shown in Fig. X5.12 agree with that unexpected trend. Fig. X5.13 shows the average case hardness and the hardness at the end of the case (the end of the dark-etching surface layer at 0.14 mm)

X5.5.5 Segregation of various types is often evaluated by metallographic methods and by microindentation hardness testing (see, for example, Practice E1268). While Practice E1268 utilizes microindentations, it is limited to determining the mean HK of the alternating bands (long axis parallel to the bands). This procedure can be expanded as shown in the following example for an offshore plate steel (Fe – 0.13% C – 1.40% Mn – 0.33% Si – 0.026% Nb) with bands of ferrite alternating with bands of variable martensite, bainite and pearlite content. Several parallel bands of HV and HK indents were made over the same segregation bands at each test load from 25, 50, 100, 200, 300 and 500 gf (only HV at 500 gf – results not plotted here; HK indents at 500 gf were too long to measure) as shown in Fig. X5.14.

X5.5.5.1 The test results can also be examined by plotting the mean and standard deviations of the measurements with each indenter at each test force, as shown in Fig. X5.15, and by plotting the maximum and the minimum HK and HV value at each test force, as shown in Fig. X5.16. Note how the minimum values do not change much, regardless of the test load or indenter type. These identical trends have been observed in all such banded specimens evaluated by this technique.

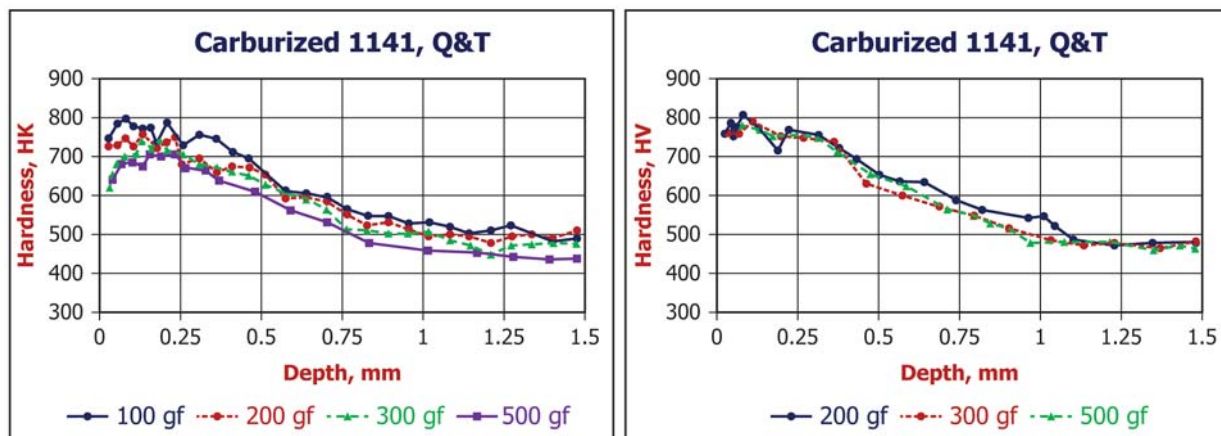

FIG. X5.11 Evaluation of the carburized surface of 1141 carbon steel after heat treatment using four test forces for the Knoop indents (left) and three for the Vickers indents (right). Note that three of the test forces using the Knoop indenter revealed a decrease in hardness at the extreme surface but this was not detected as well using the three test forces and the Vickers indenter. Retained austenite was present in the case to a depth of ~0.32 mm while grain boundary ferrite began to be observed at a depth of ~1.25 mm.

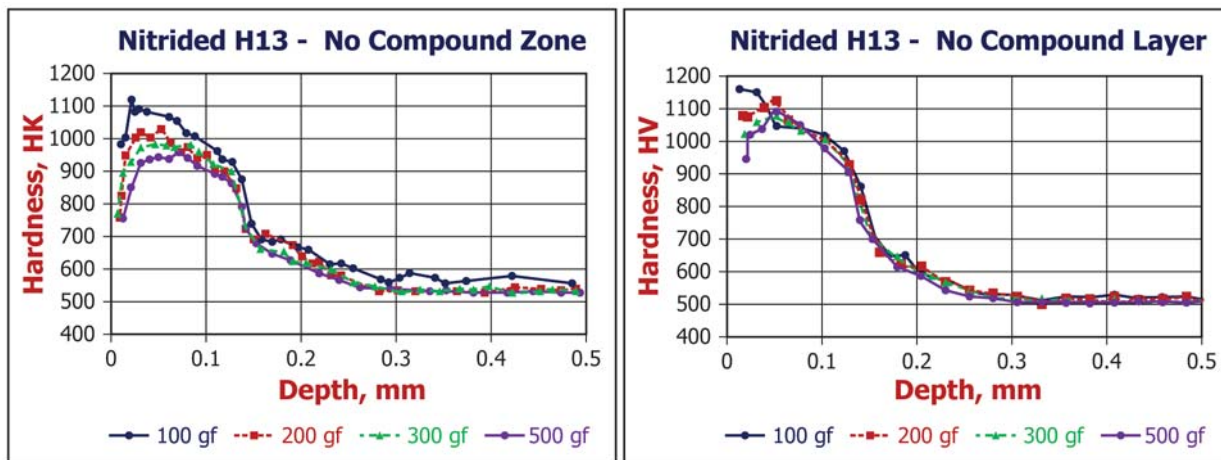

FIG. X5.12 Evaluation of a nitrided H13 die using 100, 200, 300 and 500 gf test forces with both the Knoop and Vickers indenters. Note that, as before, the range of HK at each location using these four test loads is broader than the HV range. The HV range is tight, except at the near surface area. All four HK traces show a drop in hardness at the surface while the 200-500 gf HV indents show a similar, but lesser, trend. The dark-etching case ended at ~0.14 mm.



FIG. X5.13 Plots of the average case hardness (left) and the hardness at the end of the dark-etching case at ~0.14 mm (right) for the nitrided H13 mold. For HV values of 900 and greater, the conversion chart (Table 1 of E140) shows lower HK numbers; while the reverse is shown for HV values <900.

### X5.6 Correlating Knoop Data made at <500 gf to the Equivalent HK500 Value

X5.6.1 The above tests results point out some excellent characteristics of the Knoop test, but also one very significant problem – the increase in HK with decreasing test force. It is possible to develop correction factors, although these factors have some inherent imprecision and will probably vary from operator to operator. An individual’s own variation in HK between 500 gf and lower test forces can be easily checked and compared to the data shown below by performing a number of indents, for example, 5, at various test loads from 500 gf and below on a certified test block, such as an HRC test block. An example of such tests made on a number of steel tensile bars covering a wide range of HK is given in Fig. X5.17. Fig. X5.18 shows the approximate shift in HK as the applied force decreases and as the  $HK_{500}$  value increases. Table X5.1 lists these approximate correction values as a function of the applied load and the  $HK_{500}$  value.

### X5.7 Influence of Etching upon Microindentation Hardness Results

X5.7.1 In general, if the structure is deeply etched, the metallographer will be unable to see the indent tips. For example, when the nitrided H13 specimen in X5.6 above was etched with nital, the nitrided case was a dark black and the indents tips could not be detected optically. In general, if the etching results are not excessively dark, there was no significant difference observed for the microindentation values in the etched vs. un-etched condition. Two examples are shown in Fig. X5.19. The first is a thick carburized case on 8620 alloy steel which was subsequently heat treated with an isothermal hold to form lower bainite in the case while the core was tempered low-carbon martensite. The first observance of martensite was at a depth of ~0.5 mm and the structure was fully martensitic after a depth of ~0.69 mm. Overall, the difference in hardness between the as-polished specimen and the etched specimen was not significant, except for the slightly higher HK

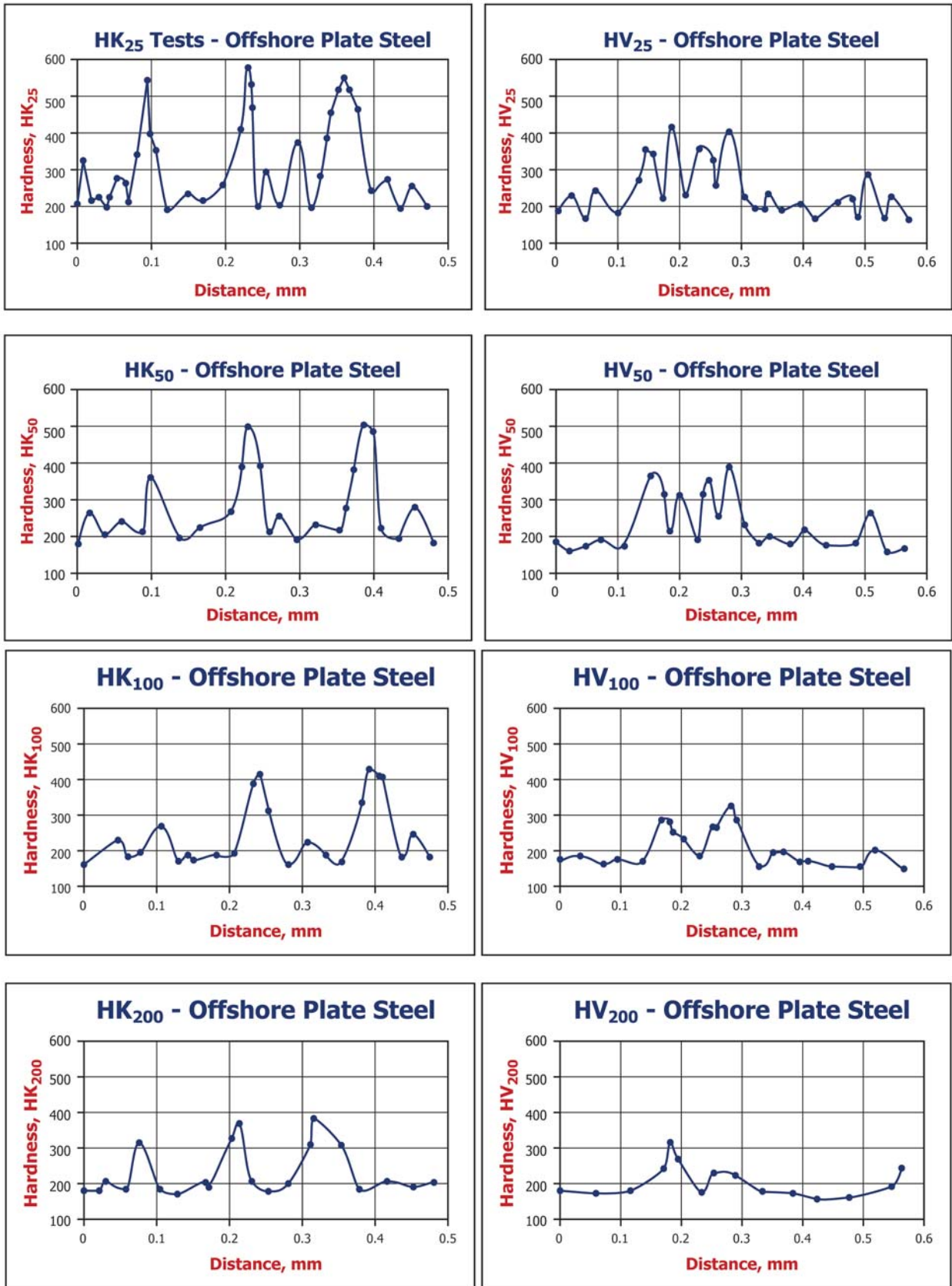

FIG. X5.14 Evaluation of banding heterogeneity of an offshore plate steel using test forces from 25 to 300 gf reveals that the Knoop indenter, due to its long narrow shape better reveals the variability in hardness, best seen at the lowest test load. Some of the bands contained varying amounts of martensite, bainite and pearlite and these patches are small; hence, the Knoop 25 gf indenter was better able to detect the extreme hardness variations. At each test force, the Knoop indenter gave more detail of the hardness variations than the Vickers indenter.

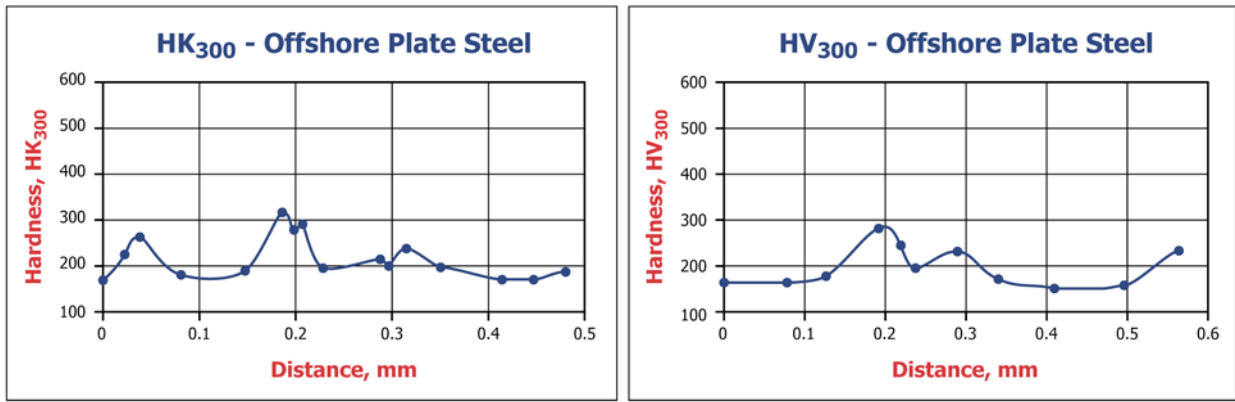

FIG. X5.14 (continued)

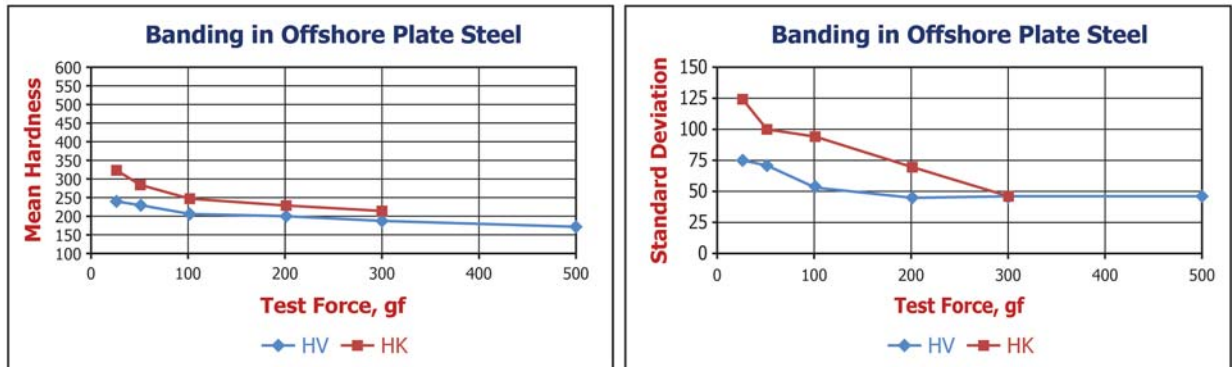

FIG. X5.15 Examination of the test data shown in Fig. X5.14 (plus the 500 gf HV data not shown) reveals that the mean Knoop hardness was greater than the mean Vickers hardness at all loads (left), with this difference increasing with decreasing applied load, as would be expected. But, the rise in mean HV at 25 and 50 gf reflects the better ability of the smaller Vickers and Knoop indents to sense the hardness variations within the bands. In line with this, the standard deviations for the 25 and 50 gf Vickers indents are notably greater than the nearly constant standard deviation from 100 to 500 gf (right). The much higher standard deviations for the Knoop indents made  $\leq 200$  gf are in agreement with the data plots in Fig. X5.14.

in the core from a depth of  $\sim 1.5$  to  $2.25$  mm. The second example shows the measurement of decarburization depth in quenched and tempered 41S50 alloy steel. Overall, the differences are insignificant, although the two tests at depths of  $\sim 0.05$  and  $0.09$  mm are slightly lower in the etched condition

than in the as-polished condition. In both cases, the second run was performed near the first run. If there is concern, and the structure must be etched to locate the indents, etch as lightly as possible

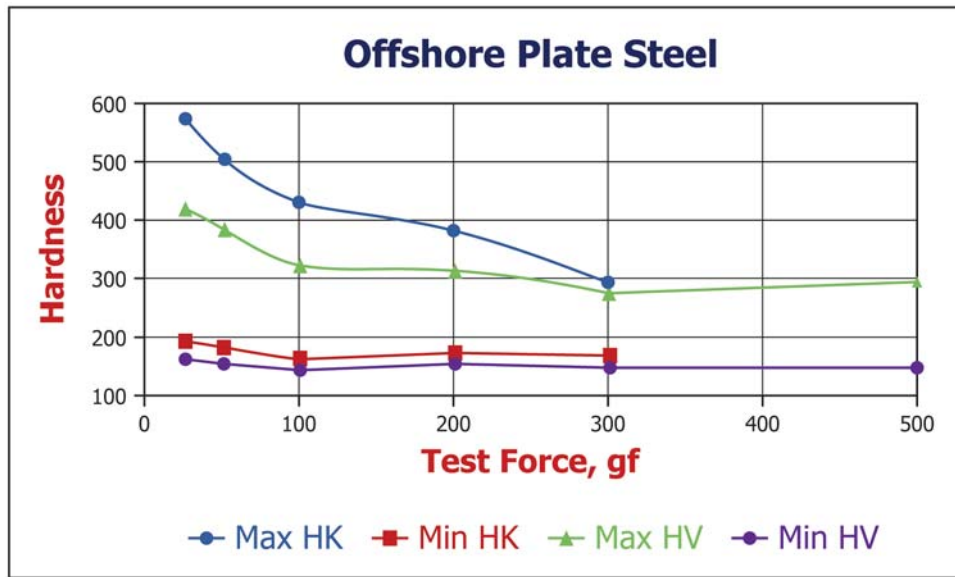

FIG. X5.16 Further evaluation of the data for the banded offshore plate steel microindentation hardness data reveals that the minimum HK is slightly greater than the minimum HV data at each test force (in agreement with the correlation between HV and HK in E140), and that the minimum HK and HV varied very little over the test load range. The maximum hardness at each test force, however, increased at forces <300 gf, with substantially greater HK values at each test force. This is mainly due to the greater ability of the elongated Knoop indenter to sense hardness increases within the narrow bands containing martensite, bainite and pearlite.

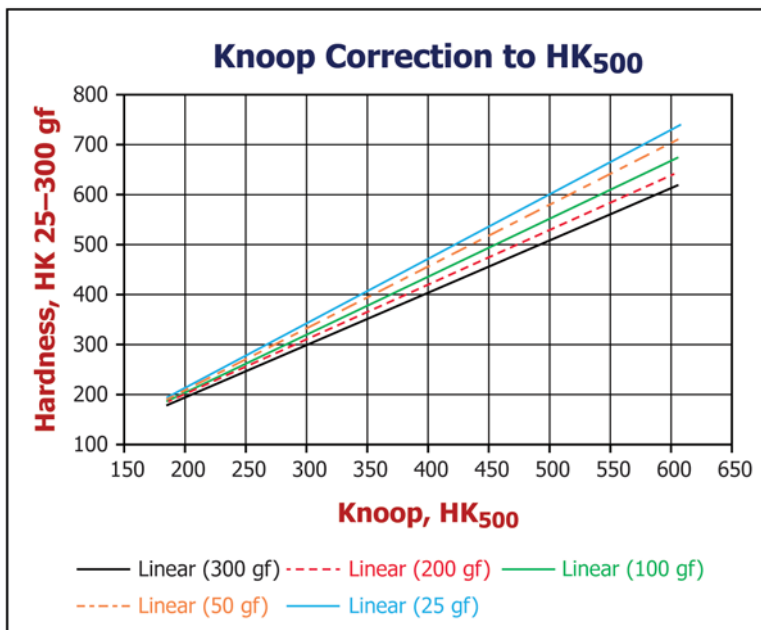

FIG. X5.17 Linear regression analysis was performed on HK data made at test forces of 25, 50, 100, 200, 300 and 500 gf.

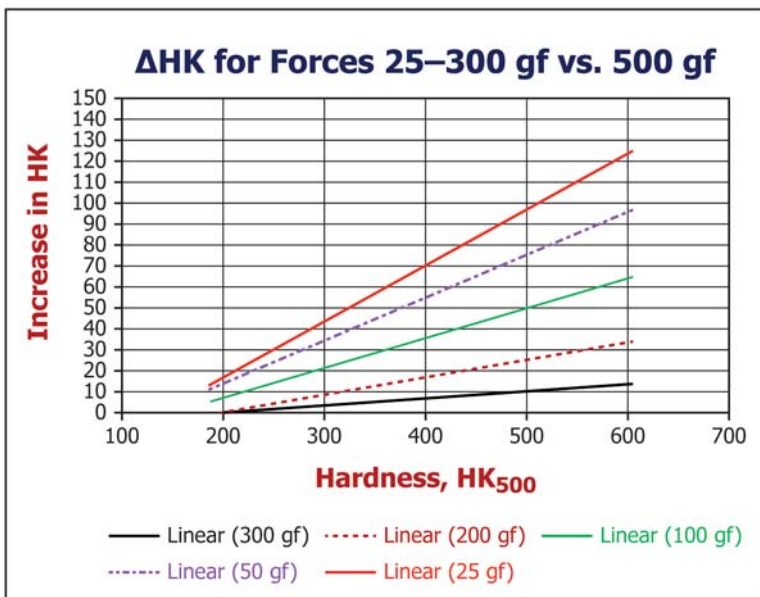

FIG. X5.18 Graph based upon the data shown in X5.17 showing the increase in HK compared to the HK<sub>500</sub> value for test forces 25, 50, 100, 200 and 300 gf. These values would be subtracted from the HK value at test loads from 25 to 300 gf to approximate the HK<sub>500</sub> value.

TABLE X5.1 Approximate Correction Values for Reducing Knoop Values at Test Forces from 25 to 300 gf to an Equivalent HK<sub>500</sub> Value

| HK <sub>500</sub> | 25 gf | 50 gf | 100 gf | 200 gf | 300 gf |
|-------------------|-------|-------|--------|--------|--------|
| 150               | 1.88  | 1.96  | 0      | 0      | 0      |
| 200               | 15.4  | 12.4  | 6.5    | 0      | 0      |
| 250               | 28.9  | 22.8  | 13.7   | 4.1    | 0.7    |
| 300               | 42.44 | 33.2  | 20.8   | 8.3    | 2.4    |
| 350               | 55.96 | 43.6  | 27.9   | 12.4   | 4.1    |
| 400               | 69.48 | 54    | 35     | 16.5   | 5.8    |
| 450               | 83    | 64.5  | 42.1   | 20.7   | 7.5    |
| 500               | 96.5  | 74.9  | 49.3   | 24.8   | 9.3    |
| 550               | 110   | 85.3  | 56.4   | 28.9   | 11     |
| 600               | 123.6 | 95.7  | 63.5   | 33.1   | 12.7   |
| 650               | 137.1 | 106.1 | 70.6   | 37.2   | 14.4   |
| 700               | 150.6 | 116.5 | 77.7   | 41.3   | 16.1   |

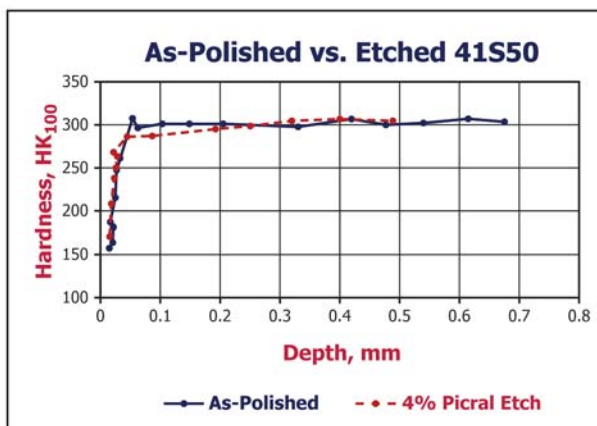
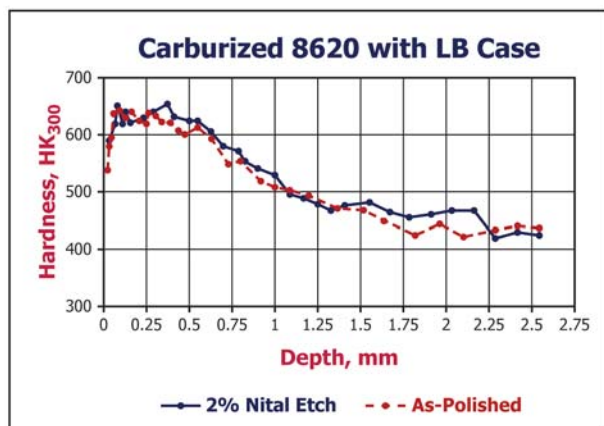

FIG. X5.19 Two examples of extensive microindentation hardness test runs on adjacent locations before and after etching.

## REFERENCES

- (1) Knoop, F., et al., “A Sensitive Pyramidal-Diamond Tool for Indentation Measurements,” *Journal of Research National Bureau of Standards*, Vol. 23, July 1939, pp. 39-61.
- (2) Campbell, R.F., et al., “A New Design of Microhardness Tester and Some Factors Affecting the Diamond Pyramid Hardness Number at Light Loads,” *Trans. ASM*, Vol 40, 1948 , pp. 954-982.
- (3) Kennedy, R.G., and Marrotte, N.W., “The Effect of Vibration on Microhardness Testing,” *Materials Research and Standards*, Vol 9, November 1969, pp. 18-23.
- (4) Brown, A.R.G., and Ineson, E., “Experimental Survey of Low-Load Hardness Testing Instruments,” *Journal of the Iron and Steel Inst.*, Vol 169, 1951, pp. 376-388.
- (5) Thibault, N.W., and Nyquist, H.L., “The Measured Knoop Hardness of Hard Substances and Factors Affecting Its Determination,” *Trans. ASM*, Vol 38, 1947, pp. 271-330.
- (6) Tarasov, L.P., and Thibault, N.W., “Determination of Knoop Hardness Numbers Independent of Load,” *Trans. ASM*, Vol 38, 1947, pp. 331-353.
- (7) Vander Voort, G.P., “Results of an ASTM E04 Round Robin on the Precision and Bias of Measurements of Microindentation Hardness,” *Factors that Affect the Precision of Mechanical Tests, ASTM STP 1025*, ASTM, Philadelphia, 1989, pp. 3-39.
- (8) Vander Voort, G.F., “Operator Errors In the Measurement of Microindentation Hardness,” *Accreditation Practices for Inspections, Tests, and Laboratories, ASTM STP 1057*, ASTM, Philadelphia, 1989, pp. 47-77.
- (9) Vander Voort, G. F., *Metallography: Principles and Practice*, McGraw-Hill Book Co., NY, 1984; ASM International, Materials Park, OH, 1999, pp. 356, 357, 380 and 381.
- (10) Vander Voort, G. F. and Fowler, R., “Low-Load Vickers Microindentation Hardness Testing”, *Advanced Materials & Processes*, Vol. 170, April 2012, pp. 28-33.

## SUMMARY OF CHANGES

Committee E04 has identified the location of selected changes to this standard since the last issue (E384 – 16) that may impact the use of this standard. (Approved June 1, 2017.)

- (1) **Appendix X5** was added.

Committee E04 has identified the location of selected changes to this standard since the last issue (E384 – 11<sup>e1</sup>) that may impact the use of this standard. (Approved February 1, 2016.)

- (1) This test method was heavily revised. Changes were made throughout the text.

*ASTM International takes no position respecting the validity of any patent rights asserted in connection with any item mentioned in this standard. Users of this standard are expressly advised that determination of the validity of any such patent rights, and the risk of infringement of such rights, are entirely their own responsibility.*

*This standard is subject to revision at any time by the responsible technical committee and must be reviewed every five years and if not revised, either reapproved or withdrawn. Your comments are invited either for revision of this standard or for additional standards and should be addressed to ASTM International Headquarters. Your comments will receive careful consideration at a meeting of the responsible technical committee, which you may attend. If you feel that your comments have not received a fair hearing you should make your views known to the ASTM Committee on Standards, at the address shown below.*

*This standard is copyrighted by ASTM International, 100 Barr Harbor Drive, PO Box C700, West Conshohocken, PA 19428-2959, United States. Individual reprints (single or multiple copies) of this standard may be obtained by contacting ASTM at the above address or at 610-832-9585 (phone), 610-832-9555 (fax), or service@astm.org (e-mail); or through the ASTM website (www.astm.org). Permission rights to photocopy the standard may also be secured from the Copyright Clearance Center, 222 Rosewood Drive, Danvers, MA 01923, Tel: (978) 646-2600; http://www.copyright.com/*