



# Standard Practice for Sampling Industrial Chemicals<sup>1</sup>

This standard is issued under the fixed designation E300; the number immediately following the designation indicates the year of original adoption or, in the case of revision, the year of last revision. A number in parentheses indicates the year of last reapproval. A superscript epsilon ( $\epsilon$ ) indicates an editorial change since the last revision or reapproval.

*This standard has been approved for use by agencies of the U.S. Department of Defense.*

## 1. Scope

1.1 This practice covers procedures for sampling several classes of industrial chemicals. It also includes recommendations for determining the number and location of such samples, to ensure their being representative of the lot in accordance with accepted probability sampling principles.

1.2 Although this practice describes specific procedures for sampling various liquids, solids, and slurries, in bulk or in packages, these recommendations only outline the principles to be observed. They should not take precedence over specific sampling instructions contained in other ASTM product or method standards.

1.3 These procedures are covered as follows:

	Sections
Statistical Considerations	7 – 11
Simple Liquids	12 – 27
Solids	28 – 35
Slurries	36 – 41

1.4 *This standard does not purport to address all of the safety concerns, if any, associated with its use. It is the responsibility of the user of this standard to establish appropriate safety and health practices and determine the applicability of regulatory limitations prior to use.* Specific precautionary statements are given in Sections 6, 19, 20, 30, 34 and 37.

## 2. Referenced Documents

2.1 *ASTM Standards:*<sup>2</sup>

**D270 Method of Sampling Petroleum and Petroleum Products**<sup>3</sup>

**D2234/D2234M Practice for Collection of a Gross Sample of Coal**

<sup>1</sup> This practice is under the jurisdiction of ASTM Committee E15 on Industrial and Specialty Chemicals and is the direct responsibility of Subcommittee E15.01 on General Standards.

Current edition approved Oct. 1, 2009. Published December 2009. Originally approved in 1966. Last previous edition approved in 2003 as E300 – 03. Discontinued 2001. Reinstated as E300 – 03. DOI: 10.1520/E0300-03R09.

<sup>2</sup> For referenced ASTM standards, visit the ASTM website, www.astm.org, or contact ASTM Customer Service at service@astm.org. For *Annual Book of ASTM Standards* volume information, refer to the standard's Document Summary page on the ASTM website.

<sup>3</sup> Withdrawn. The last approved version of this historical standard is referenced on www.astm.org.

**E180 Practice for Determining the Precision of ASTM Methods for Analysis and Testing of Industrial and Specialty Chemicals** (Withdrawn 2009)<sup>4</sup>

## 3. Terminology

3.1 *Definitions:*

3.1.1 *simple liquid*—a single-phase liquid having a Reid vapor pressure of less than 110 kPa at 37.8°C (16 psi at 100°F) and a Saybolt viscosity of less than 10 000 s (2160 cSt) at 25°C.

3.1.2 *lot*—a discreet quantity of material. It may contain a single batch or several batches, or be the product of continuous process broken into units on the basis of time or shipment. It is very desirable that individual batches in a lot be specifically identified so that they may become individual or stratified units for inspection.

3.1.3 *average sample*—one that consists of proportionate parts from all sections of the container.

3.1.4 *spot sample*—a sample taken at a specific location in a tank or from a flowing stream in a pipe at a specific time.

3.1.5 *composite sample*—a blend of spot samples mixed in proportion to the volumes of material from which the spot samples were obtained.

3.1.6 *all-levels sample*—one obtained by submerging a closed sampler to a point as near as possible to the draw-off level, then opening the sampler and raising it at a rate such that it is about three fourths full as it emerges from the liquid. An all-levels sample is not necessarily an average sample because the tank volume may not be proportional to the depth and because the operator may not be able to raise the sampler at the variable rate required for proportionate filling. The rate of filling is proportional to the square root of the depth of immersion.

NOTE 1—The tube sampling procedure, 26.3, may be used to obtain an all-levels sample from a drum.

3.1.7 *upper sample*—a spot sample obtained from the middle of the upper third of the tank contents (Fig. 1).

<sup>4</sup> The last approved version of this historical standard is referenced on www.astm.org.

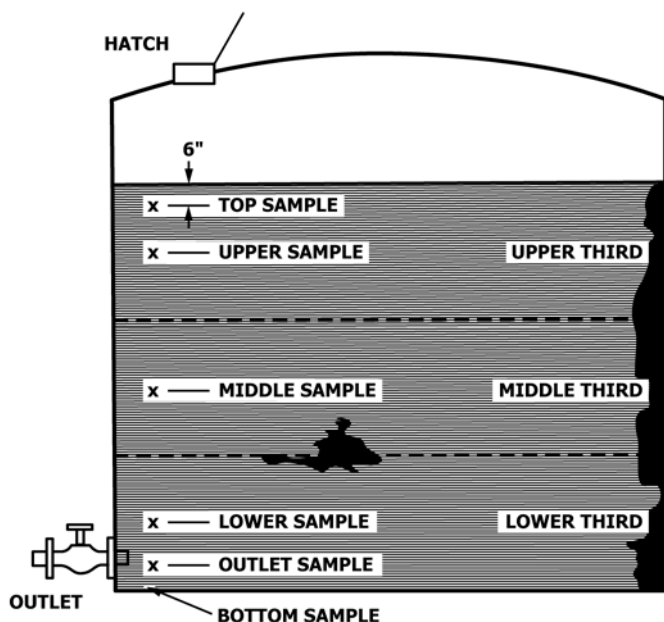

FIG. 1 Sampling Depths

NOTE 2—The taking of samples from various levels of the tank permits the detection of variation in composition of the contents caused by stratification. If it is known that the contents are not subject to this variation, the taking of samples at multiple levels may be eliminated.

3.1.8 *middle sample*—a spot sample obtained from the middle of the tank contents (Fig. 1) (Note 2).

3.1.9 *lower sample*—a spot sample of liquid from the middle of the lower one-third of the tank’s content (a distance of one-half of the depth of liquid below the liquid’s surface) (Fig. 1).

3.1.10 *single-tank composite sample*—a blend of the upper, middle, and lower samples. For a tank of uniform cross section, such as an upright cylindrical tank, the blend consists of equal parts of the three samples. For a horizontal cylindrical tank, the blend consists of the three samples in the proportions shown in Table 1.

3.1.11 *compartment-tank composite sample (ship, barge, etc.)*—a blend of individual all-levels samples from each compartment, which contains the product being sampled, in proportion to the volume of material in each compartment.

3.1.12 *top sample*—a spot sample normally obtained 150 mm (6 in.) below the top surface of the tank contents (Fig. 1).

3.1.13 *outlet sample*—a spot sample normally obtained with the inlet opening of the sample apparatus at the level of the bottom of the tank outlet (either fixed or a swing line outlet) (Fig. 1).

3.1.14 *continuous sample*—a spot sample obtained from a pipeline conveying the product in such a manner as to give a representative average of the stream throughout the period of transit.

3.1.15 *jar sample*—a spot sample obtained by placing a jar into the path of a free-flowing stream so as to collect a definite volume from the full cross section of the stream.

3.1.16 *mixed sample*—a spot sample obtained after mixing or vigorously stirring the contents of the original container, and then pouring out or drawing off the quantity desired.

3.1.17 *tube or thief sample*—a spot sample obtained with a sampling tube or special thief, either as a core sample or spot sample from the specified point in the container.

3.1.18 *drain sample*—a spot sample obtained from the draw-off or discharge valve. Occasionally, a drain sample may be the same as a bottom sample, as in the case of a tank car.

3.1.19 *bottom sample*—a spot sample obtained from the material on the bottom surface of the tank, container, or line at its lowest point (Fig. 1). (Drain and bottom samples are usually taken to check for water, sludge, scale, etc.).

3.1.20 *laboratory sample*—that portion of the sample which is sent for laboratory testing.

#### 4. Summary of Practice

4.1 This practice describes procedures to be followed for obtaining samples of several classes of industrial chemicals. It addresses in detail the various factors which need to be considered to obtain a representative laboratory sample. This practice also covers the statistical considerations in sampling of industrial chemicals whether they are liquids, solids or slurries in bulk or in packages.

#### 5. Significance and Use

5.1 Representative samples of industrial chemicals are required for the determination of chemical and physical properties which are used to establish standard volumes, prices, and compliance with commercial and regulatory specifications.

5.2 The objective of sampling is to obtain a small portion (spot sample) of material from a selected area within a container which is representative of the material in the area or, in the case of running or all-level samples, a sample whose composition is representative of the total material in the container. A series of spot samples may be combined to create a representative sample.

5.3 *Manual and Automatic Sampling Considerations*—The selection of manual or automatic sampling devices is part of establishing a sampling plan applied under all conditions within the scope of this practice provided that the proper sampling procedures are followed. Both types of sampling are commonly used for liquid, solid, and slurry sampling and require adherence to the following:

5.3.1 An adequate frequency of sampling must be selected.

TABLE 1 Sampling Instructions for Horizontal Cylindrical Tanks

Liquid Depth, Percent of Diameter	Sampling Level, Percent of Diameter Above Bottom			Composite Sample Proportionate Parts of		
	Upper	Middle	Lower	Upper	Middle	Lower
100	80	50	20	3	4	3
90	75	50	20	3	4	3
80	70	50	20	2	5	3
70	...	50	20	1	5	4
60	...	50	20	...	5	5
50	...	40	20	...	4	6
40	...	...	20	...	...	10
30	...	...	15	...	...	10
20	...	...	10	...	...	10
10	...	...	5	...	...	10

5.3.2 The equipment to support manual or automatic sampling systems may be obtained commercially, fabricated from the designs presented in this practice, or constructed as needed to satisfy process design or other specific requirements.

5.3.3 The sampling equipment must be maintained on a regular basis, and the sampling plan adopted must be strictly followed.

## 6. Safety Precautions

6.1 This practice covers procedures and sampling equipment used to sample industrial chemicals that may be potentially hazardous to personnel or the environment. Accordingly, it is emphasized that all applicable safety rules, regulations, and procedures must be followed in handling and processing the chemicals. Furthermore, this practice does not purport to cover all safety aspects associated with sampling. However, it is presumed that the personnel performing sampling operations are adequately trained with regard to safe application of the procedures contained herein for the specific sampling situation.

6.2 The characteristics of the material to be sampled will govern the type of protective equipment required. Since sampling may present such hazards as splashing or spilling, protective clothing must be worn when the chemical is capable of producing eye or skin irritation or burns. During such potential exposures, chemical-type goggles or face shield and protective gloves, or combination thereof, must be worn.

6.3 Respiratory protection, where required, must be in good condition and must be suitable to protect against chemicals being handled.

6.4 When sampling chemicals that may be dangerous to life by skin absorption, oral ingestion, or by breathing the vapor, unusual precautions will be indicated. In such cases, full-body protection such as supplied by a gas-tight or one-piece air-supplied suit should be worn. A second person must be continuously present to summon help and render aid in the event of an emergency.

## STATISTICAL CONSIDERATIONS<sup>5</sup>

### 7. Objectives

7.1 The sampling and testing of industrial chemicals may have one or more of the following objectives:

7.1.1 The objective may be to estimate the average quality characteristic of a given lot of material and to establish confidence limits for this average. This would be the main objective, for example, if a dollar value is to be placed on the material for customs purposes or for sale.

7.1.2 The objective may be to decide whether the average value for the lot meets a specification. This calls for an acceptance sampling plan with the criterion being related to the estimated mean of the lot.

7.1.3 The objective may be to estimate or make decisions about the variability of a quality characteristic within the lot.

7.1.4 The objective may be to obtain simultaneous estimates of the mean and variance or to make decisions about some joint combination of these estimates.

7.1.5 If the material comes in containers or can be viewed as coming in clearly demarked units, the objective may be that of estimating the number of such units outside of specifications, that is, the “fraction defective.”

NOTE 3—Procedures are given below for estimating average quality and for applying acceptance sampling inspection based on the lot mean.

### 8. General Sampling Considerations

8.1 To obtain samples that are representative in a statistical sense, one must consider such factors as physical form, uniformity, type and number of containers, etc. All of these factors influence the choice of method for performing the sampling operation, as well as the number and location of the required samples. Two commonly used practices for selecting the sequence or location of the individual samples are described.

8.2 *Random Sampling* is achieved when every part of the lot has an equal chance of being drawn into the sample.

8.2.1 Designate all units in the lot, choosing numbers in sequence or other serial code so that sampling by random numbers can be employed.

8.2.2 Preferably, this sequence should be in direct relation to order of manufacture of packaging as an aid to observing, from the sample results, any evidence of stratification.

8.2.3 Random selection of the numbers should be accomplished by chance or preferably by the use of a table of random numbers.

8.3 *Stratified Sampling* can be employed to estimate average quality when it is known or suspected that the value of a property of the material varies in non-random fashion throughout the lot for the following typical reasons: (a) the lot may contain several production batches, (b) the lot may contain units produced by different procedures, equipment, shifts, etc., or (c) the lot may be non-uniform because of subsequent size segregation, moisture pickup, surface oxidation, etc. If the assumed pattern is correct, the variance of the population mean estimate will be less than that based on random sampling. If the assumptions are incorrect, the estimate of the mean may be biased. A stratified sample can be obtained as follows:

8.3.1 Based on the known or suspected pattern, divide the lot into a number of real or imaginary strata.

8.3.2 If these sections are not equal in size, the number of samples to be taken from each stratum must be proportional to the size of the various strata.

8.3.3 Further subdivide the major strata into real or imaginary subsections and select the required number of samples by chance or preferably by means of a table of random numbers.

### 9. Estimate of Average Quality

9.1 *Determination of the Variance of a Sample Mean*—If the material comes in, or can be viewed as coming in, realizable primary units, each of which are to be divided into realizable secondary units, and if  $n_b$  primary units are selected at random from a lot of  $N$  primary units, and if  $n_w$  secondary units are selected from each primary unit with  $k$  tests being made on

<sup>5</sup> Prepared by an Ad Hoc Committee of ASTM Committee E11 on Statistical Methods.

each secondary unit drawn, then the variance of the mean of the results is given as follows (Note 4 and Note 5):

$$\sigma_{\bar{x}}^2 = (\sigma_b^2/n_b) \times [(N - n_b)/N] + [\sigma_w^2/(n_b \times n_w)] + (\sigma_t^2/n_t) \quad (1)$$

where:

- $\sigma_{\bar{x}}^2$  = variance of the mean,
- $\sigma_b^2$  = variance of primary units (the material in cars, tanks, cans, drums, bottles, or other containers) in the lot,
- $\sigma_w^2$  = average variance of secondary units (all-level, tube, thief, or similar samples) from a primary unit,
- $\sigma_t^2$  = variance of tests on a homogeneous sample,
- $N$  = number of primary units in the lot,
- $n_b$  = number of randomly selected primary units from which secondary units are drawn,
- $n_w$  = number of randomly drawn secondary units from each of the  $n_b$  primary units, and
- $n_t$  = total number of tests made on all units, including replicates.

9.1.1 Eq 1 is also applicable when the  $n_b \times n_w$  secondary units are composited into a single sample before testing. If there is no compositing and  $k$  tests are made on each secondary unit,  $\bar{X}$  will be an arithmetic average of  $n_t = k \times n_b \times n_w$  test results. If the secondary units are composited and  $k_c$  tests are made on the composite sample,  $\bar{X}$  will be an arithmetic average of  $n_t = k_c$  results.

NOTE 4—Uniform quantities (weight or volume, as appropriate) in the primary units and in the secondary units are assumed. If the departure from uniformity is such that a material error would be introduced by using a simple mean, a weighted average should be used or, if the secondary units are composited, proportional compositing must be adhered to.

NOTE 5—The factor  $(N - n_b)/N$  is the correction for sampling from a finite population. A corresponding correction is generally not necessary for secondary units and tests.

9.1.2 For homogeneous liquids  $\sigma_w^2 = 0$ , so that Eq 1 reduces to Eq 2:

$$\sigma_{\bar{x}}^2 = (\sigma_b^2/n_b) \times [(N - n_b)/N] + (\sigma_t^2/n_t) \quad (2)$$

9.1.3 If  $n_b = N$ , Eq 1 and Eq 2 reduce, respectively, to Eq 3 and Eq 4:

$$\sigma_{\bar{x}}^2 = [\sigma_w^2/(n_b \times n_w)] + (\sigma_t^2/n_t) \quad (3)$$

$$\sigma_{\bar{x}}^2 = \sigma_t^2/n_t \quad (4)$$

9.2 *Determination of  $n_b$ ,  $n_w$ , and  $n_t$  When Basic Variances are Known*—When reliable estimates of the variances  $\sigma_b^2$ ,  $\sigma_w^2$ , and  $\sigma_t^2$  are available from experience with lots of the type involved, a set of equivalent combinations of  $n_b$ ,  $n_w$ , and  $n_t$  may be calculated from Eq 1, each combination based on the same desired or specified variance of the mean,  $\sigma_{\bar{x}}^2$ . Similarly, sets of equivalent combinations may be calculated from Eq 2 and Eq 3.

NOTE 6—If the precision of the test method has been properly evaluated in accordance with Practice E180, an adequate estimate of  $\sigma_t^2$  can be obtained from the repeatability standard deviation ( $s_d$ ) based on approximately 30 degrees of freedom.

9.2.1 Choice of a particular combination in a set for a specific lot is optional. In general, one combination in a set is most economical under given cost conditions and is therefore to be preferred.

9.3 *Procedure When Basic Variances are Unknown:*

9.3.1 Select at random a likely or convenient number,  $n_1$  (10 or more), of primary units from the lot, take one secondary unit from each, and test each secondary unit. Estimate the variance of a measurement of a primary unit,  $s_1^2$  (a variance that includes between and within unit variability as well as test variability), using Eq 5:

$$s_1^2 = \sum (X - \bar{X}_1)^2 / (n_1 - 1) \quad (5)$$

where  $\bar{X}_1$  is the mean of the individual test results on the  $n_1$  primary units, with one secondary unit per primary unit and one test per secondary unit.

9.3.2 Decide to estimate the mean of the lot from single tests on single secondary units from  $n_2$  primary units where  $n_2 > n_1$  and the  $n_2$  units include the  $n_1$  preliminary units, the value on  $n_2$  being determined from Eq 6:

$$n_2 = s_1^2 / T_{S^2_{\bar{x}}} \quad (6)$$

where  $T_{S^2_{\bar{x}}}$  is the target value of an estimate of the variance of  $\bar{X}$ . The target value  $T_{S^2_{\bar{x}}}$  will depend on the width of the desired confidence interval. If it is hoped to have a 0.95 confidence interval of width  $2\Delta$ , then for  $n_2 > 30$ ,  $T_{S^2_{\bar{x}}}$  should be taken as  $(\Delta/1.96)^2$ . For smaller values of  $n_2$ , the 1.96 should be replaced by the 0.025 values from a  $t$ -table.

9.3.3 Estimate the variance of the mean after  $n_2$  tests from Eq 7:

$$s_{\bar{x}}^2 = \sum (X - \bar{X})^2 / n_2(n_2 - 1) \quad (7)$$

9.4 *A Confidence Limits for the Mean of the Lot:*

9.4.1 If the basic variances are known and two-stage sampling (primary and secondary units) is employed, then 0.95 confidence limits for the mean of the lot  $\mu$  are given by Eq 8:

$$0.95 \text{ confidence limits for } \mu = \bar{X} \pm 1.96 \sigma_{\bar{x}} \quad (8)$$

where  $\sigma_{\bar{x}}$  is obtained from the  $\sigma_{\bar{x}}^2$  value given by Eq 1.

9.4.2 If the basic variances are unknown and the variance of  $\bar{X}$  is estimated as in 9.3 ( $n_s$  sample primary units with one secondary unit per sample primary unit and one test per secondary unit), then 0.95 confidence limits for the mean of the lot  $\mu$  are given by Eq 9:

$$0.95 \text{ confidence limits for } \mu = \bar{X} \pm t_{0.025, s_{\bar{x}}} \quad (9)$$

where  $s_{\bar{x}}$  is obtained from the  $s_{\bar{x}}^2$  value given by Eq 7 and  $t_{0.025}$  can be taken as equal to 1.96 if  $n_2$  is greater than 30, but otherwise should be taken from a table of  $t$ -values for  $n_2 - 1$  degrees of freedom.

## 10. Acceptance Sampling for a Lot Mean—Basic Variances Unknown

NOTE 7—This section describes a simple random sampling plan for the acceptance inspection of an isolated lot and provides for buyer's and seller's risks of making a wrong decision. If a series of lots is to be inspected and knowledge of the basic variances is available, significant savings may be realized by testing composites.

10.1 *Introduction*—If a specification requires, for example, that the average purity or assay of a lot be no less than 98.0 %, it is sometimes assumed that the sampling and testing plan will accept all lots of 98.0 % or higher, but will detect or reject any

lot falling below this value. This ideal situation is not statistically realistic, as the required degree of discrimination can be approached only if the lot units are essentially uniform and the test procedure is capable of attaining a very high level of precision. It is necessary, therefore, that the contracting parties realize that any sampling plan based on a low probability of rejecting a lot which, in fact, is 98.0 % or higher in purity, may also permit acceptance of some lots below this specification minimum. Accordingly, such specifications must be viewed as incorporating both a buyer's and seller's risk. The following procedures are based on this concept.

10.2 Single Lower Specification Limit (L); Simple Random Sampling from a Large Lot:

10.2.1 Procedure:

10.2.1.1 Step 1—Note the value of the lower specification limit for average lot quality and designate it by  $L$ . Assume this value to represent a quality level for which the probability of acceptance should be high and the risk of rejection low. In this procedure, the seller's risk is taken to be 0.05.

10.2.1.2 Step 2—Establish a lower value for the barely tolerable lot quality for which the level of acceptance should be low and designate it by  $L - \Delta$ . Here, this buyer's risk is taken to be 0.10.

10.2.1.3 Step 3—Take a preliminary sample of  $n_1$  (equals 10 or more) units at random from the lot and compute

$$\bar{X} = \sum_{i=1}^{n_1} X_i/n_1, \text{ and} \tag{10}$$

$$s_i = \sqrt{\sum_{i=1}^{n_1} (X_i - \bar{X})^2 / (n_1 - 1)} \tag{11}$$

$$\text{Set } \hat{\sigma}_1 = s_1 \tag{12}$$

10.2.1.4 Step 4—Note the value of  $\Delta$  agreed to in Step 2. Compute  $\lambda_1 = \Delta / \hat{\sigma}_1$  and find from Table 2 the value of  $n$  that comes closest to that given by the computed value of  $\lambda_1$ . Call this  $n_2$ .

10.2.1.5 Step 5—Randomly select  $n_2 - n_1$  additional units from the lot. Compute

$$\bar{X}_2 = \sum_{i=1}^{n_2} X_i/n_2, \text{ and} \tag{13}$$

$$s_2 = \sqrt{\sum_{i=1}^{n_2} (X_i - \bar{X})^2 / (n_2 - 1)} \tag{14}$$

TABLE 2 Values<sup>A</sup> of Sample Size ( $n$ ) for Agreed Upon Values of  $\Delta$

$\lambda = \Delta / \sigma$	Sample Size ( $n$ )
2.76	3
2.16	4
1.61	5
1.26	7
1.00	10
0.79	15
0.68	20
0.54	30
0.42	50
0.33	75
0.29 <sup>B</sup>	100

<sup>A</sup> Values of  $\lambda$  were read from Fig. 13.31 of Bowker and Lieberman, *Handbook of Industrial Statistics*.

<sup>B</sup> For larger size samples, take  $n = (2.927)^2 / \lambda^2 = 8.57 / \lambda^2$ .

10.2.1.6 Step 6—Check on the adequacy of  $n_2$  by taking  $\hat{\sigma}_2 = s_2$ . Compute  $\lambda_2 = \Delta / \hat{\sigma}_2$ . Enter Table 2 and find the value of  $n$  corresponding to  $\lambda_2$ . Call this  $n_3$ . If  $n_3$  is much greater than  $n_2$ , for example, more than 20 %, randomly select  $n_3 - n_2$  additional units from the lot and return to Step 5. If  $n_3$  is not much greater than  $n_2$ , proceed with Step 7.

10.2.1.7 Step 7—Using the final values obtained above, calculate the following and accept the lot if

$$[(L - \bar{X}) / (s_{\bar{x}} \sqrt{n})] \leq t_{0.05} \tag{15}$$

where  $n = n_1, n_2$ , or  $n_3$ , whichever is applicable,  $t_{0.05}$  is the upper 0.05 point of a  $t$ -distribution for  $n - 1$  degrees of freedom, and  $s = s_2$  or  $s_1$  whichever is applicable. Otherwise, reject the lot.

10.2.2 Example:

10.2.2.1 Assume that a contract covered the purchase of a packaged material with a minimum purity specification of 98.0 %. The buyer and seller agreed that the probability of rejecting a lot of 98.0 % purity should be no greater than 0.05 and that of accepting a lot as low as 97.0 % should be no greater than 0.10. In this case, the pertinent levels are:

$$L = 98.0 \tag{16}$$

$$L - \Delta = 97.0$$

$$\Delta = 1.0$$

10.2.2.2 On testing samples from ten units, selected at random, the lot standard deviation was estimated to be:

$$s_{\bar{x}} = s_1 = 0.8 \tag{17}$$

The values for  $\bar{X}$  and  $\lambda_1$  were also calculated:

$$\bar{X} = 97.5 \% \tag{18}$$

$$\lambda_1 = \Delta / s_1 = 1.0 / 0.8 = 1.25$$

10.2.2.3 Entering Table 2, the sample size  $n$  for  $\lambda_1 = 1.25$  is found to be 7. Accordingly, no further sampling is required.

10.2.2.4 Substituting the above values in Eq 15:

$$(L - \bar{X}) / (s_{\bar{x}} \sqrt{n}) = (98.0 - 97.5) / (0.8 / \sqrt{10}) \tag{19}$$

$$= (0.5 \times \sqrt{10}) / 0.8 = 1.97$$

Since 1.97 is greater than 1.833 (the value for the upper 0.05 point of the  $t$ -distribution for 9 degrees of freedom), the lot should be rejected.

10.3 Single Upper Specification Limit (U); Simple Random Sampling from a Large Lot—The procedures of 10.2 will apply here except that  $U$  will replace  $L$  and  $U + \Delta$  will replace  $L - \Delta$ . The criterion for acceptance will be:

$$(\bar{X} - U) / (s_{\bar{x}} \sqrt{n}) \leq t_{0.05} \tag{20}$$

10.4 Both Lower and Upper Specification Limits: Simple Random Sampling from a Large Lot—Use the following sampling plan: Determine  $n$ ,  $\bar{X}$ , and  $s$  as in 10.2.1. Accept the lot if

$$(L - \bar{X}) / (s_{\bar{x}} \sqrt{n}) \leq t_{0.05}, \text{ and} \tag{21}$$

$$(\bar{X} - U)/(s_x/\sqrt{n}) \leq t_{0.05} \quad (22)$$

for  $n - 1$  degrees of freedom. Otherwise, reject the lot.

### 10.5 General Remarks:

10.5.1 If  $\Delta$  is small relative to the lot standard deviation, a large sample size will be required to attain the low 0.10 consumer's and 0.05 producer's risks.

10.5.2 If the estimate of the lot standard deviation is less than the true lot standard deviation, the sample size given by the above procedures will produce a sampling plan whose risks will be different from those planned for. There will be a greater seller's risk of having a lot rejected whose mean is equal to the desired  $L$  level. Also, the buyer's risk of accepting a lot, whose mean is below the  $L - \Delta$  level for barely acceptable quality, will also be greater than 0.10 (how much greater depends on how far off the estimate of the lot standard deviation may be).

10.5.3 If the estimate of the lot standard deviation is greater than the true lot standard deviation, then the above procedures will give a sample size ( $n$ ) that is greater than necessary to yield the agreed upon risks. It will thus unnecessarily increase sampling costs.

10.5.4 The risks stated in this practice are based on the assumption that variability among units of the lot follows a normal distribution and that the total quantity of material in subsamples taken for testing does not exceed 10 % of the total quantity in the lot. If variability among units shows evidence of considerable skewness, the logarithms of the data (or other transformation) should be used.

10.5.5 If the sample units are taken from bulk material by a given sampling device, these risks are also based on the assumption that the sampling device is used in taking both the preliminary sample and the total sample.

## 11. Acceptance Sampling for the Mean of a Lot from a Stream of Batched Material for Which the Basic Variances Have Been Previously Estimated

11.1 *Some Basic Considerations*—To understand the recommendations of this section, it is helpful to review briefly the nature of an operating characteristic (OC) curve for an acceptance sampling plan.

11.1.1 The OC curve of acceptance sampling plan gives the probability of acceptance of a lot with reference to a hypothetical stream of lots. Two types of streams are generally considered. These are designated as Type A and Type B. A Type A stream is a stream of lots that are identical in every respect to the lot currently being inspected. A Type B stream of lots of the same size as the lot currently being inspected that would be generated by a controlled process. When we are faced with the inspection of an isolated lot, it seems appropriate to view the risks of the sampling inspection with reference to a Type A stream. We have little or no knowledge of the process from which the lot came and a decision on the lot would seem best based on data from that lot alone. This is the case considered in Section 10 of this practice; the isolated lot with unknown standard deviation.

11.1.2 In the present section, reference is to a process that is producing a stream of lots in batches. We assume that the within-batch and between-batch variations are independent and

random with constant variances and on the basis of these assumptions we run a pilot study of variances that we take to hold valid for subsequent lots from the process. The current lot being inspected is recognized from the start as being one of the stream of lots coming from the given process and, as such, we are willing to use information about within-batch and between-batch variances obtained in the pilot study as part of the total information on which a decision about the lot is based. In this section, therefore, the probability of acceptance will be with reference to a Type B stream of lots, that is, with reference to a stream of lots from a controlled process. It follows in this case that the variance of a sample lot mean will be a function of both the within-batch and between-batch variances.

11.1.3 The recommended procedures of 11.2 call for compositing of increments and reduction for laboratory testing. As in the case of the batch variability, a preliminary study is made of the compositing and reduction processes and preliminary estimates are made of the reduction variance and the testing variance. It is again assumed that these same variances continue valid for the reduction and testing procedure employed in the inspection of the *current* lot. Recommended procedures for estimating the batch variances and the reduction and testing variances are given in the Annex. In the sections that follow, it will be assumed these estimates have been made.

11.1.4 *A Word of Advice*— Before a particular program is instituted, it would be desirable to review it with a statistician to be sure that the recommendations of Section 11 are thoroughly understood.

### 11.2 Acceptance Tests Based on Current Samples:

11.2.1 *Introduction*— With knowledge of the basic variances for the product and for the method of reduction and testing, the acceptability of a *current* lot from the given stream of material can be determined as follows:

11.2.2 *Formation of Composite Samples*—For the purpose of determining the acceptability of a current lot from the given stream of lots, proceed as follows: Let the lot consist of  $n_1$  batches of material where  $n_1$  is an integer. Presumably  $n_1$  is determined by the needs of the purchaser with respect to his inventories, production, etc. (Note 9). Let  $n_2$  increments of material be taken at random from each of the  $n_1$  batches that make up the given lot and let  $n_2$  be an even number. (The determination of  $n_2$  is discussed in 11.2.4). If the batches are not distinct, take  $n_1 n_2$  increments at random from the lot. Form a composite of all the odd numbered increments and another composite of all the even numbered increments. Call the first composite *A*, the second composite *B*. Reduce each composite separately and under uniform conditions run two tests on each composite.

NOTE 8—A fraction of a batch should be treated as a whole batch in determining  $n_1$ .

11.2.3 *Variance Formula*— The variance formula for the mean ( $\bar{X}$ ) of the two composite samples with two tests per composite is

$$\sigma_{\bar{x}}^2 = \frac{\hat{\sigma}_b^2}{n_1} + \frac{\hat{\sigma}_w^2}{n_1 n_2} + \frac{\hat{\sigma}_r^2}{2} + \frac{\hat{\sigma}_t^2}{4} \quad \dots \quad (23)$$

where:

- $\hat{\sigma}_b^2$  = estimate made in the preliminary study of the between-batch variance,
- $\hat{\sigma}_{w_2}^2$  = estimate of the within-batch variance,
- $\hat{\sigma}_r^2$  = estimate of the reduction variance, and
- $\hat{\sigma}_t^2$  = estimate of the testing variance.

**11.2.4 Determination of the Value of  $n_2$  with a Single Lower Specification Limit ( $L$ )**—For a single lower specification limit, the procedure for determining the value of  $n_2$  is as follows:

**11.2.4.1 Step 1**—Note the value of the lower specification limit for average product quality and designate it by  $L$ . Assume this value to represent a quality level for which the probability of lot acceptance should be high and the risk of lot rejection low. In the procedure for determining  $n_2$ , the seller's risk is taken to be 0.05.

**11.2.4.2 Step 2**—Determine a barely tolerable product quality for which the probability of lot acceptance should be low and designate this by  $L - \Delta$ . Here the buyer's risk is taken to be 0.10.

**11.2.4.3 Step 3**—Take  $n_2$  as the even integer just greater than

$$n_2 = \frac{\hat{\sigma}_w^2}{n_1[(\Delta^2/8.5673) - (\hat{\sigma}_b^2/n_1) - (\hat{\sigma}_r^2/2) - (\hat{\sigma}_t^2/4)]} \quad \dots \quad (24)$$

This  $n_2$  will for the stated variances make the probability of lot acceptance for product quality  $L$  equal approximately to 0.95 and the probability of lot acceptance for product quality  $L - \Delta$  equal to 0.10.

**11.2.5 Determination of the Value of  $n_2$  with a Single Upper Specification ( $U$ )**—The procedure is the same as that of **11.2.4** except that  $U$  replaces  $L$  and  $U + \Delta$  replaces  $L - \Delta$ . The formula for  $n_2$  is the same.

**11.2.6 Determination of the Value of  $n_2$  with Both a Lower and Upper Specification Limit**—The procedure is exactly the same as that of **11.2.4** and the formula for  $n_2$  is the same. It is assumed that the spread between specification limits is at least  $3\sigma_{\bar{x}}$ .

**11.2.7 Sample Checks on the Basic Variances**—Before using **Eq 1** in an acceptance test, a check should be made to see if the values previously determined for  $\hat{\sigma}_b^2$ ,  $\hat{\sigma}_{w_2}^2$ ,  $\hat{\sigma}_r^2$ , and  $\hat{\sigma}_t^2$  are still valid. To check on  $\hat{\sigma}_t^2$ , compute the difference between the two tests for composite  $A$  and also the difference between the two tests for composite  $B$  and plot the two differences on an extension of Control Chart (4) described in the Annex. Proceed only if both of the two differences fall within the control limits. To check the remaining variances, set up a chart called Control Chart (5); the limits for which shall be

$$0 \text{ and } 3.686 \left( \frac{\hat{\sigma}_b^2}{n_1} + \frac{2\hat{\sigma}_w^2}{n_1 n_2} + \hat{\sigma}_r^2 + \frac{\hat{\sigma}_t^2}{2} \right)^{1/2} \quad (25)$$

and the central line on which shall be

$$1.128 \left( \frac{\hat{\sigma}_b^2}{n_1} + \frac{2\hat{\sigma}_w^2}{n_1 n_2} + \hat{\sigma}_r^2 + \frac{\hat{\sigma}_t^2}{2} \right)^{1/2} \quad (26)$$

Plot on this chart the absolute value of the difference between the mean of composite  $A$  and the mean of composite  $B$ . Again proceed only if the difference falls below the upper

limit and does not, with previous points, yield a run of seven or more above the central line.

**NOTE 9**—If a point falls above the upper limit, this means that the purchaser's testing variance is probably greater than  $\hat{\sigma}_t^2$ . An estimate of the former based on additional data would consequently have to be made. The acceptance procedure could thus continue with the purchaser's test variance in place of the original  $\hat{\sigma}_t^2$ . This new estimate should be based on at least 20 degrees of freedom.

**11.2.8 Acceptance Test when there is a Single Lower Specification Limit ( $L$ ):**

**11.2.8.1 Step 1**—Compute

$$\bar{X}_{La} = L - 1.645 \left( \hat{\sigma}_b^2/n_1 + \hat{\sigma}_w^2/n_1 n_2 + \hat{\sigma}_r^2/2 + \hat{\sigma}_t^2/4 \right)^{1/2} \quad \dots \quad (27)$$

**11.2.8.2 Step 2**—Accept the lot if  $\bar{X} \geq \bar{X}_{La}$ .

**11.2.9 The Acceptance Test when there is a Single Upper Specification Limit ( $U$ ):**

**11.2.9.1 Step 1**—Compute

$$\bar{X}_{Ua} + U + 1.645 \left( \hat{\sigma}_b^2/n_1 + \hat{\sigma}_w^2/n_1 n_2 + \hat{\sigma}_r^2/2 + \hat{\sigma}_t^2/4 \right)^{1/2} \quad \dots \quad (28)$$

**11.2.9.2 Step 2**—Accept the lot if  $\bar{X} \leq \bar{X}_{Ua}$ .

**11.2.10 Acceptance Test when there are both a Lower Specification Limit ( $L$ ) and an Upper Specification Limit ( $U$ ):**

**11.2.10.1 Step 1**—Note whether  $U - L$  is greater than

$$3 \left( \hat{\sigma}_b^2/n_1 + \hat{\sigma}_w^2/n_1 n_2 + \hat{\sigma}_r^2/2 + \hat{\sigma}_t^2/4 \right)^{1/2} \quad (29)$$

If it is, continue to Step 2. If it is not, do not continue.

**11.2.10.2 Step 2**—Compute  $\bar{X}_{La}$  and  $\bar{X}_{Ua}$  as in **11.2.8** and **11.2.9**.

**11.2.10.3 Step 3**—Accept the lot if  $\bar{X}_{La} \leq \bar{X} \leq \bar{X}_{Ua}$ .

## SIMPLE LIQUIDS

### 12. Scope

12.1 This procedure covers the sampling of industrial chemicals which are single-phase liquids under the conditions of sampling.

**NOTE 10**—This procedure is based on Method **D270**.

### 13. Summary

13.1 Samples of simple liquids are examined using various ASTM methods for the determination of physical and chemical characteristics. It is accordingly necessary that the samples be truly representative of the simple liquids in question. The precautions required to ensure the representative character of the samples are numerous and depend upon the type of product being sampled, the tank, the carrier or container from which the sample is being obtained, the type and cleanliness of the sample container, and the sampling procedure that is to be used. A summary of the sampling procedures and their application is presented in **Table 3**. Each procedure is suitable for sampling a number of specific products under definite storage, transportation, or container conditions. The basic principle of each procedure is to obtain a sample or a composite of several samples in such manner and from such locations in the tank or other container that the sample or composite will be truly representative of the product. Although single-phase liquids are homogeneous by definition, it may be desirable to check for this condition by sampling from various sections of the container.

**TABLE 3 Summary of Sampling Procedures and Applicability**

Type of Container	Type of Sampling	Section
Storage tanks (trucks, cars, ships, barges, stationary)	Bottle sampling, thief sampling	22, 23
Storage tanks (trucks, cars, stationary)	Tap sampling	24
Pipe lines, filling lines, transfer lines	Continuous sampling	25
Drums, carboy, cans, bottles	Tube sampling	26
Free or open-discharge streams	Jar sampling	27

## 14. Sampling Equipment

14.1 *General Requirements*—all sampling apparatus and closures shall be clean, dry, free of contaminants, and constructed of materials that are inert to the product to be sampled. The sampling container and closure shall be clean, dry, and inert to the material being sampled.

14.2 *Bottles and Jars*—Bottles and jars may be made of clear or brown glass or polyethylene with necks shaped to receive a glass stopper or a screw cap made of metal or plastic material. Use of unprotected corks as closures is not recommended for general use. Where safety indicates (such as for peroxides) use corks covered with materials inert to the sample, such as cellophane, polyethylene, or aluminum foil. Clear glass is advantageous because the container may be examined visually for cleanliness and the sample may be visually inspected for foreign matter. Brown glass affords some protection for light-sensitive materials. Before using a bottle or jar, examine it to see that it is scrupulously clean. A variety of methods for cleaning glass containers may be used: washing with detergents, water, acetone, etc. The specific method used will depend upon the material to be sampled. Care should be taken that all of the cleaning agents are removed from the container prior to use. Dry the container either by passing a current of clean warm air through the container or by placing it in a dust-free cabinet at 40°C or higher. Close containers as soon as they are dry.

14.3 *Screw-Neck and Press-Cover Cans*—Cans of tin plate with seams soldered on the outside must be used. The neck should be shaped to receive a screw cap or pressed cover. Take care to ensure that cans are clean, even when new. They may be cleaned by washing with low-boiling, nonflammable solvents and blowing dry with clean air. Cap the containers as soon as they are dry.

## 15. Time and Place of Sampling

15.1 *Finished Products*—When loading or discharging finished products, take samples from both shipping and receiving tanks, and from the pipeline, if required.

15.2 *Ship or Barge Tanks*—Sample each product immediately after the vessel is loaded, or just before discharging.

15.3 *Tank Cars*—Sample the product immediately after the car is loaded, or just before unloading.

## 16. Number and Location of Samples

16.1 *Bulk Containers (Tanks, Tank Cars etc.)*—Simple liquids in bulk containers are frequently found to be homoge-

neous and only limited sampling is usually required. Upper, middle, and lower samples (22.3) or top and outlet samples (22.5) can be individually tested to confirm this, by means of simple physical tests such as refractive index, density, viscosity, etc. Complete testing can then be performed on a composite prepared as described in 22.4.

16.2 *Packaged Materials (Drums, Cans, Bottles, etc.)*—In the case of lots of drums, bottles, and cans, the homogeneity of the lot cannot be assumed, and the required number of samples should be determined in accordance with Sections 7 and 8. The specific containers to be sampled for individual testing should be chosen by means of a table of random numbers.

## 17. Sampling Operations

17.1 Procedures for sampling cannot be made explicit enough to cover all cases. Extreme care and good judgment are necessary to ensure samples are obtained which represent the general character and average condition of the material. Clean hands are important. Clean gloves may be worn but only when absolutely necessary, such as during cold weather, or for reasons of safety. Select wiping cloths so that lint is not introduced, thus contaminating samples.

17.2 Since the vapors of some industrial chemicals are toxic and flammable, avoid breathing them, igniting them from an open flame, burning embers, or a spark produced by static electricity. All safety precautions specific to the material being sampled must be followed.

17.3 When sampling relatively volatile products, the sampling apparatus shall be filled and allowed to drain before drawing the sample. If the sample is to be transferred to another container, this container shall have been cleaned and dried as described in Section 14 and also be rinsed with some of the volatile product and then drained. When the actual sample is emptied into this container, the sampling apparatus should be upended into the opening of the sample container and remain in this position until the contents have been transferred so that no unsaturated air will be entrained in the transfer of the sample.

17.4 When sampling non-volatile liquid products, the sampling apparatus shall be filled and allowed to drain before drawing the actual sample. If the actual sample is to be transferred to another container, this container shall have been cleaned and dried as described in Section 14 and also be rinsed with some of the product to be sampled and drained before it is filled with the actual sample.

17.5 A sample shall be considered suspect under any of the following circumstances and should be referred to the appropriate supervisor before analysis:

17.5.1 The sample container is damaged or defective.

17.5.2 There is any doubt as to the nature of the contents of the sample container: for example, because of the presence of an old label, incorrect markings, or insufficient identification.

17.5.3 There is evidence of an unexpected lack of uniformity; for example, a separate layer or suspended matter.

17.5.4 Obvious and unusual variations are apparent in the sample.



17.5.5 The container closure is loose, whether or not there is evidence of leakage.

17.5.6 Evidence that the closure or liner has been attacked.

**18. Size of Sample**

18.1 The quantity of sample should be as specified by the test instructions, or at least three times greater than the minimum necessary for the actual tests.

**19. Precautions**

19.1 *Volatile Samples (Reid vapor pressure 14 to 110.3 kPa at 37.8°C (2 to 16 psi at 100°F))*—It is necessary to protect volatile samples from evaporation. Transfer the product from the sampling apparatus to the sample container immediately. Keep the container closed except when material is being transferred. After delivery to the laboratory, it is recommended to cool the containers before they are opened.

19.2 *Light-Sensitive Samples*—It is important that samples sensitive to light be kept in the dark if testing is to include the determination of such properties as color, inhibitor content, stability tests, or neutralization values. Brown glass bottles may be used. Wrap or cover clear glass bottles immediately. It is a definite advantage to use covered metal or cardboard containers into which the sample bottles may be placed immediately after collection.

19.3 *Materials of High Purity*—Protect highly refined products from moisture and dust by placing paper, plastic, or metal foil over the closure and the top of the container.

19.4 *Container Outage*— Never completely fill a sample container, but allow adequate room for expansion, taking into consideration the temperature of the liquid at the time of filling and the probable maximum temperature to which the filled container may be subjected.

**20. Shipping Precautions**

20.1 To prevent the loss of liquid during shipment and to protect against moisture and dust, cover the closure of the glass bottle with plastic caps which have been swelled in water, wiped dry, placed over the top of the stoppered bottle, and allowed to shrink tightly in place. Screw-top bottles are recommended. The cap must be lined with material inert to the sample. The screw caps must be secured by use of adhesive tape or similar material.

NOTE 11—Shipping of any chemical must comply with current federal, state, and local regulations for the specific material being shipped.

**21. Labeling Sample Containers**

21.1 Label the container immediately after a sample is obtained. Use waterproof and oil-proof ink or a pencil hard enough to dent the tag, since soft pencil and ordinary ink markings are subject to obliteration from moisture, oil smearing, and handling. If gummed labels are used, they should be further secured with transparent sealing tape. Sufficient detail should be written on the label to completely identify the sample. The following information is frequently desired:

21.1.1 Date and time (and for continuous and dipper samples the hour and minute of collection),

21.1.2 Name of sampler,

21.1.3 Name or number and owner of the vessel, car, or container,

21.1.4 Brand name, grade of material, and code number, and

21.1.5 Reference symbol and necessary identification number.

21.1.6 Hazard ratings.

**22. Bottle Sampling**

22.1 The bottle sampling procedure is applicable for sampling simple liquids in tank cars, tank trucks, shore tanks, ship tanks, and barge tanks. A suitable sampling bottle, as shown in Fig. 2, is required. The diameter of the openings in the bottles should be 19 mm (3/4 in.). Stopper and label bottles immediately after taking them and deliver them to the laboratory in the original sampling bottle.

NOTE 12—The designs and dimensions which follow are intended only as guides to the form that the sampling apparatus may take. When metal is required for construction of the sampling apparatus, a corrosion-resistant type steel should be selected (Type 316L may be suitable). If flammable materials are to be sampled, a nonmagnetic low-spark generating stainless steel is required. When sampling flammable liquids, exercise extreme care not to sharply strike the container being sampled with the sampling apparatus. Alternative procedures may be used if a mutually satisfactory agreement has been reached by the parties involved.

22.2 *All-Level Sample*— Lower the weighted, stoppered bottle as near as possible to the draw-off level, pull out the stopper with a sharp jerk of the twine or chain (spark-proof) attached to the stopper, and raise the bottle at such a rate that it is about three-fourths full as it emerges from the liquid.

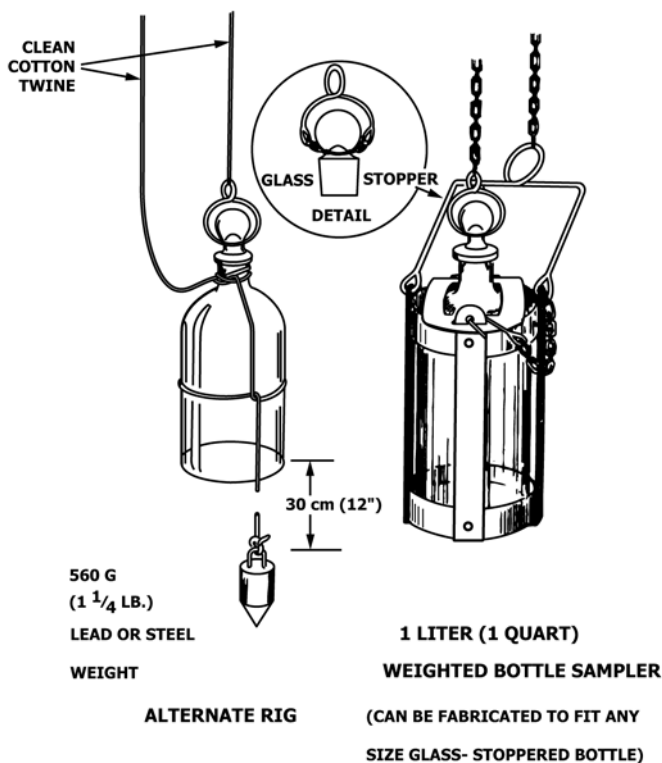

FIG. 2 Assembly for Bottle Sampling

22.3 *Upper, Middle, and Lower Samples*—Lower the weighted, stoppered bottle to the proper depths (Fig. 1), which are as follows:

Upper sample	middle of upper third of the tank contents
Middle sample	middle of the tank contents
Lower sample	middle of lower third of the tank contents.

Pull out the stopper with a sharp jerk of the twine or chain (spark-proof) attached to the stopper and allow the bottle to fill completely at the selected level, as evidenced by the cessation of air bubbles. When full, raise the bottle, pour off a small amount, and stopper immediately.

22.4 *Composite Sample*—Prepare a composite sample in the laboratory (not in the field) by mixing portions of all-levels samples as specified in 3.1.11 or by mixing portions of the upper, middle, and lower samples as specified in 3.1.10.

22.5 *Top and Outlet Samples*—Obtain these samples (Fig. 1) in the same manner as specified in 3.1.12 and 3.1.13, but at the following depths:

Top sample	150 mm (6 in.) below the top surface of the tank contents
Outlet sample	opposite the tank outlet (either fixed or swing line outlet)

**23. Thief Sampling**

23.1 The thief sampling procedure is applicable for obtaining bottom samples (Fig. 1), of liquids with Reid vapor

pressure of 14 kPa at 37.8°C (2 psi at 100°F) or less, in tank cars and storage tanks.

23.2 *Thief*—The thief shall be designed so that a sample can be obtained within 13 mm (½ in.) of the bottom of the car or tank. Two types of thieves are illustrated in Fig. 3. One type is lowered into the tank with valves open to permit the liquid to flush through the container. When the thief strikes the bottom of the tank, the valves shut automatically to trap a bottom sample. The other type has a projecting stem on the valve rod which opens the valves automatically as the stem strikes the bottom of the tank. The sample enters the container through the bottom valve and air is released simultaneously through the top. The valves snap shut when the thief is withdrawn.

23.3 *Procedure*—Lower the clean, dry thief through the dome of the tank car or tank hatch until it strikes the bottom. When full, remove the thief and transfer the contents to the sample container. Close and label the container immediately, and deliver it to the laboratory.

**24. Tap Sampling**

24.1 The tap sampling procedure is applicable for sampling simple liquids in tanks which are equipped with suitable taps or lines. The assembly for tap sampling is shown in Fig. 4.

24.2 *Tank Taps*—The tank should be equipped with at least three sampling taps placed equidistant throughout the tank

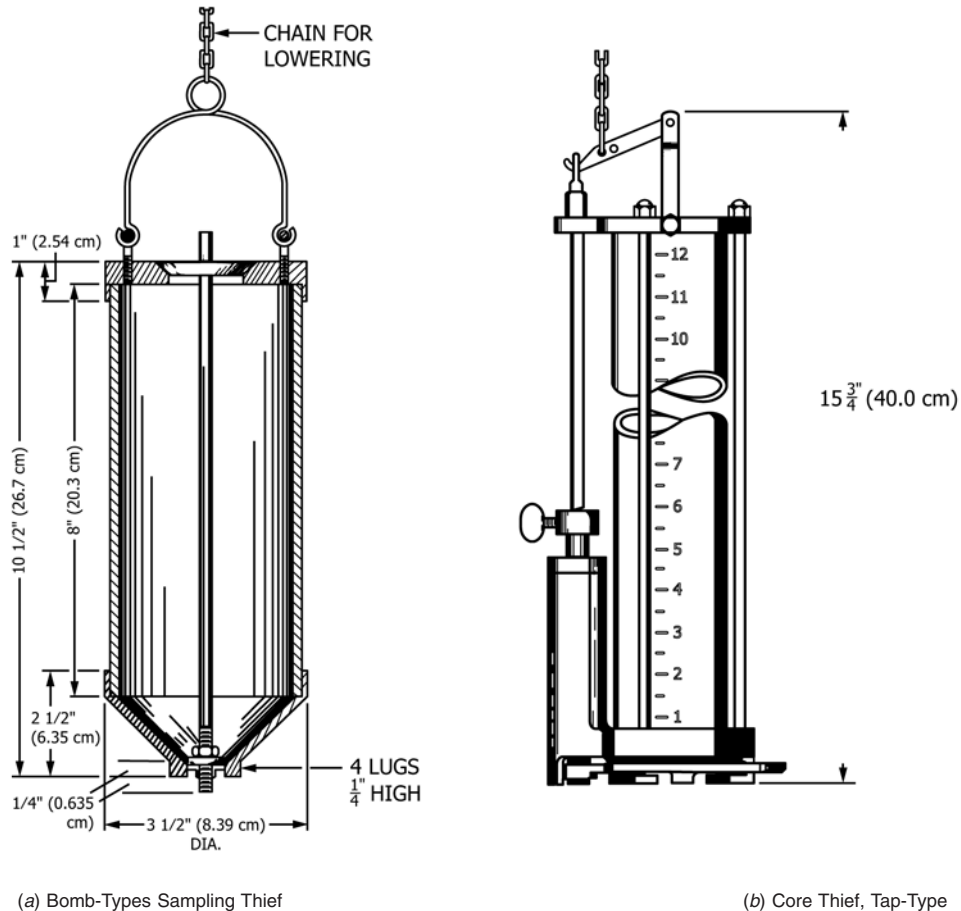

FIG. 3 Sampling Thiefs

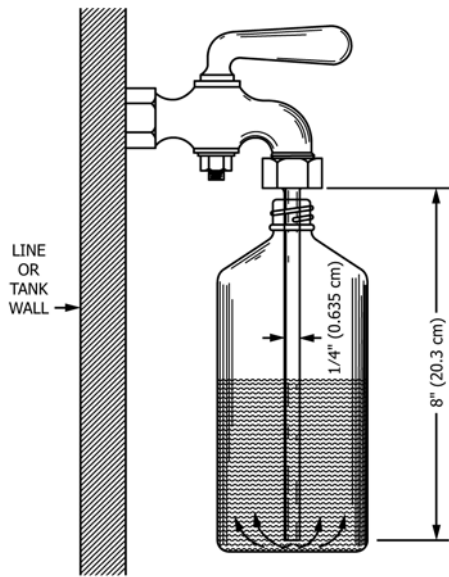

FIG. 4 Assembly for Tap Sampling

height and extending at least 0.9 m (3 ft) inside the tank shell. A standard 6-mm (1/4-in.) pipe with suitable valve is satisfactory.

24.3 *Tube*—A delivery tube which will not contaminate the product being sampled and long enough to reach to the bottom of the sample container is required to allow submerged filling.

24.4 *Procedure*—Before a sample is drawn, flush the tap (or gage glass drain cock) and line until they are purged completely. Connect the clean delivery tube to the tap. Draw upper, middle, or lower samples directly from the respective taps after the flushing operation. Stopper and label the sample container immediately after filling, and deliver it to the laboratory.

## 25. Continuous Sampling

25.1 The continuous sampling procedure is applicable for sampling simple liquids in pipe lines, filling lines, and transfer lines. The continuous sampling may be done manually or by using automatic devices.

25.1.1 **Warning**—Purge the sample line three times before the sample is taken and take special precautions to minimize exposure to the chemical being sampled.

25.2 *Sampling Probe*—The function of the sampling probe is to withdraw from the flow stream a portion that will be representative of the entire stream. The apparatus assembly for continuous sampling is shown in Fig. 5. Probe designs that are commonly used are as follows:

25.2.1 A tube extending to the center of the line and beveled at a 45° angle facing upstream.

25.2.2 A long-radius elbow or bend extending to the center line of the pipe and facing upstream. The end of the probe should be reamed to give a sharp entrance edge.

25.2.3 A tube extending across the pipeline with holes or slots facing upstream. The position and size of the probe should be such that it will minimize stratification and dropping out of heavier particles within the tube.

NOTE 13—Although this discussion is limited to simple liquids which are assumed to be uniform in composition, it is possible that under certain conditions, temporary stratification (caused by pressure, temperature gradients, etc.) may exist and, therefore, certain precautions are advised to ensure obtaining representative samples.<sup>6</sup>

25.2.4 To control the rate at which the sample is withdrawn, the probe or probes must be fitted with valves or plug cocks.

<sup>6</sup> Rushton, J. H., and Hillestad, J. G., "Sampling of Nonhomogeneous Flow in Pipes," Preprint No. 52-64. *Proceedings*, American Petroleum Institute, PPTIA, Vol. 44, Section 3, 1964, pp. 517-534.

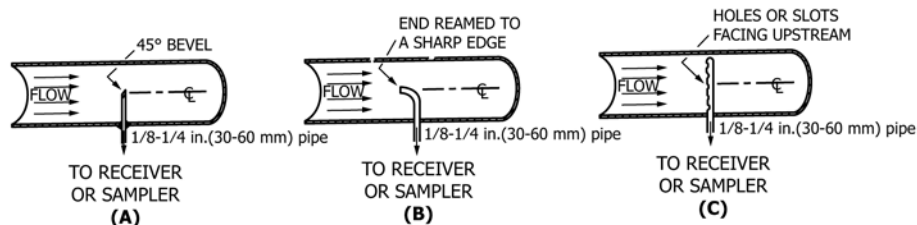

NOTE: PROBE MAY BE FITTED WITH VALVES OR PLUG COCKS.  
PROBE MAY BE DISPOSED HORIZONTALLY OR VERTICALLY.

### PROBES FOR CONTINUOUS SAMPLING

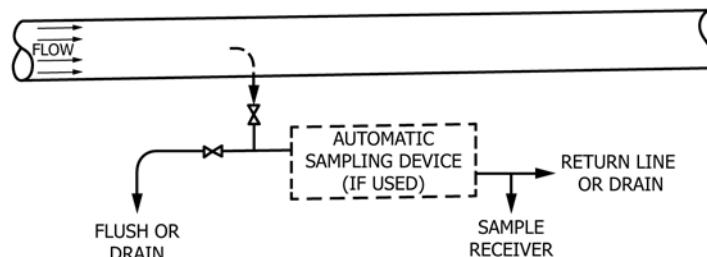

(D) TYPICAL ASSEMBLY FOR CONTINUOUS SAMPLING

FIG. 5 Probes for Continuous Sampling

25.2.5 A clean, dry container of convenient size shall be used to receive the sample. All connections from the sample probe to the sample container must be free of leaks. The container shall be constructed in such a way that it retards evaporation loss and protects the sample from extraneous material such as rain, snow, dust, and trash. The construction should allow cleaning, interior inspection, and complete mixing of the sample prior to removal. The container should be provided with a suitable vent.

25.3 Automatic Sampling Devices:

25.3.1 Time Cycle (Nonproportional) Types—A sampler designed and operated in such a manner that it transfers equal increments of liquid from the pipeline to the sample container at a uniform rate of one or more increments per minute is a continuous sampler.

25.3.2 Intermittent Sampler—A sampler that is designed and operated in such a manner that it transfers equal increments of liquid from a pipeline to the sample container at a uniform rate of less than one increment per minute.

25.3.3 Flow-Response (Proportional) Type—A sampler that is designed and operated in such a manner that it will automatically adjust the quantity of sample in proportion to the rate of flow is a flow-response (proportional) sampler. Adjustment of the quantity of sample may be made either by varying the frequency or transferring equal increments while maintaining a constant frequency of transferring the increments to the sample container.

25.4 Procedure:

25.4.1 Nonautomatic Sample—Adjust the valve or plug cock from the sampling probe so that a steady stream is drawn from the probe. Measure and record the rate of sample withdrawn as gallons per hours. Divert the sample stream to the sampling container continuously or intermittently, to provide a quantity of sample that will be sufficient size for analysis. Label the sample and deliver it to the laboratory in the container in which it was collected.

25.4.2 Automatic Sampling—Purge the sampler and the sampling lines immediately before the start of a sampling operation. If the sampler design is such that complete purging is not possible, circulate a continuous stream from the probe past or through the sampler and back into the line. Withdraw the sample from the side stream through the automatic sampler using the shortest possible connections. Adjust the sampler to deliver not less than 1 and not more than 160 L (40 gal) of sample during the desired sampling period. For time-cycle

samplers, record the rate at which sample increments were taken per minute. For flow-responsive samplers, record the proportion of sample to total stream. Label the samples and deliver them to the laboratory in the containers in which they were collected.

NOTE 14—For time-cycle samplers, deviations in quantity of the sample taken should not exceed  $\pm 5\%$  of the average rate for a given setting. For flow-responsive samplers the deviation in quantity of sample taken per 168 000 L (42 000 gal) of flowing stream should not exceed  $\pm 5\%$  of the chosen average.

26. Tube Sampling

26.1 The tube sampling procedure is applicable for sampling liquids in drums and cans.

26.2 Tube—Either Type 316L stainless steel or other material suitable for the particular liquid may be used. The tube should be designed so that it will reach to within about 3 mm ( $\frac{1}{8}$  in.) of the bottom of the container and have a capacity of approximately 0.5 L (1 pt) or 1 L (approximately 1 qt). A metal tube suitable for sampling 207-L (55-gal) drums is shown in Fig. 6. Two rings, attached to opposite sides of the tubes at the upper end, are convenient for holding it by slipping two fingers through the rings—thus leaving the thumb free to close the opening. An alternative tube sampling apparatus is shown in Fig. 7. This tube is also designed to reach within 3 mm ( $\frac{1}{8}$  in.) of the bottom.

26.3 Procedure for Drums:

26.3.1 Stand the drum upright and sample from the top. If the drum does not have a top bung, place the drum on its side with the bung facing upwards. Thorough mechanical agitation of the drum prior to sampling will ensure that its contents are uniform. If detection of water, rust, or other insoluble contaminants is desired, let the drum remain in the sampling position long enough to permit the contaminants to collect at the top or bottom, and take a top and a bottom sample. Remove the bung and place it beside the bung hole with the wet side up. Close the upper end of the clean, dry sampling tube with the thumb, and lower the tube into the liquid for a depth of about 300 mm (1 ft). Remove the thumb, allowing the liquid to flow into the tube. Again close the upper end with the thumb and withdraw the tube. Rinse the tube with the liquid by holding it nearly horizontal and turning it so that the liquid comes in contact with that part of the inside surface which will be immersed when the sample is taken. Avoid handling any part of the tube that will be immersed in the liquid during the sampling

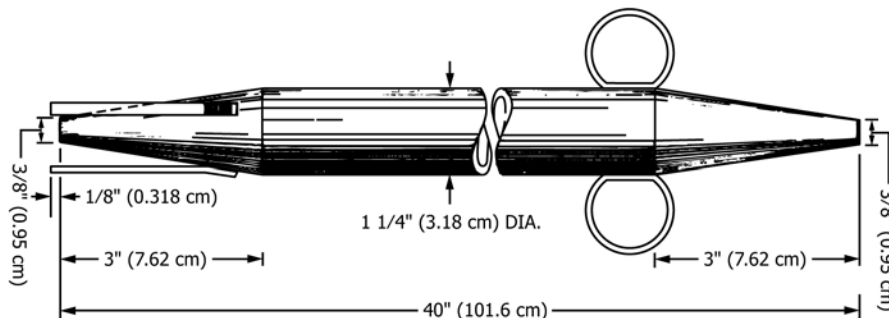

FIG. 6 Sampling Tube

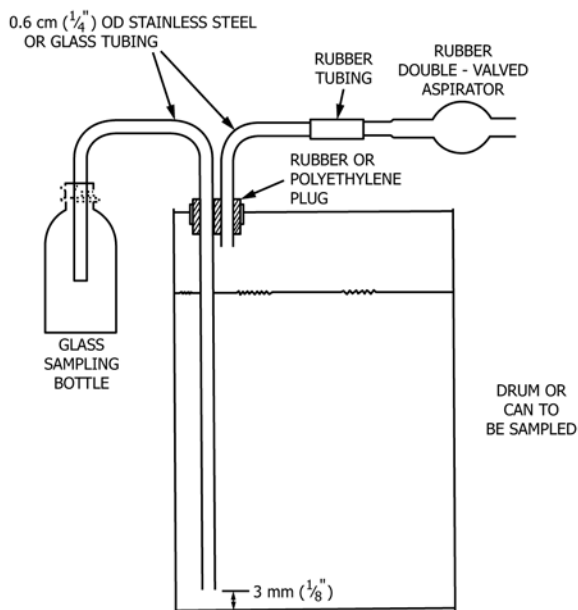

FIG. 7 Alternative Tube Sampling Assembly

operation. Discard the rinse liquid and allow the tube to drain. Insert the tube into the liquid again, holding the thumb against the upper end. (If an all-levels sample is desired, insert the tube with the upper end open.) When the tube reaches the bottom, remove the thumb and allow the tube to fill. Replace the thumb, withdraw the tube quickly, and transfer the contents to the sample container. Do not allow the hands to come in contact with any part of the sample. Close the sample container; replace and tighten the bung in the drum. Label the sample container and deliver it to the laboratory.

26.3.2 In using the alternative sampling device, the sample shall be pumped directly into the sample bottle by means of a double-valve aspirator bulb. Samples at various levels may be obtained by adjusting the depth of the tube in the drum or can. Before collecting the sample, thoroughly flush the device with the material being sampled.

26.4 Procedure for Cans—Obtain samples from cans of 20-L (5-gal) capacity or larger in the same manner as from drums (26.3.1) using a tube of proportionately smaller dimensions. For cans of less than 20-L (5-gal) capacity, use the entire contents as the sample, choosing cans as prescribed by the selected sampling plan section or in accordance with agreement between the purchaser and the seller.

## 27. Jar Sampling

27.1 The jar sampling procedure is applicable for sampling liquids where a free or open-discharge stream exists as in small filling and transfer pipelines (50 mm (2 in.) in diameter or less) and filling apparatus for bottles and cans.

NOTE 15—Jar sampling is particularly subject to contamination of the material being sampled. Great care should be exercised to be sure that foreign matter is not introduced into the sample from the air or surroundings.

27.1.1 Jar—Use a clean, dry, glass jar with screw cap. The cap must be lined with material inert to the sample.

27.1.2 Procedure—Insert a jar in the free-flowing stream so that a portion is collected from the full cross-section of the stream. Observe appropriate safety measures. Take portions at time intervals chosen so that a complete sample proportional to the pumped quantity is collected. Samples collected may be analyzed individually or composited to provide an average sample of the material pumped.

## SOLIDS

### 28. Scope

28.1 This practice covers equipment and procedures for sampling materials that are solids (see 29.1) at the time of sampling. The equipment and procedures that are described in these sections are intended to supplement the experience of the sampler as a guide in selecting methods that are applicable to the material being sampled.

28.2 Subjects covered in these sections appear in the order shown in Table 4.

### 29. Terminology

#### 29.1 Description of Terms:

29.1.1 *solid*—a state of matter in which the relative motion of molecules is restricted and in which molecules tend to retain a definite fixed position relative to each other. A solid may be said to have a definite shape and volume.

29.1.2 *sampling*—the process of extracting a small fraction of material from a larger bulk, so that it will be sufficiently representative of the bulk for the intended purpose.

29.1.3 *lot*—a discrete quantity of material. It may contain a single batch or several batches, or be the product of continuous process broken into units on the basis of time or shipment. It is very desirable that individual batches in a lot be specifically identified so that they may become individual or stratified units for inspection.

29.1.4 *increments*—portions of material selected from various parts of a lot, which may be tested individually or composited and tested as a unit.

29.1.5 *gross sample*— a composite prepared by mixing the increments.

29.1.6 *subsample*—a smaller sample produced in a specified manner by the reduction in volume or quantity of the gross sample.

TABLE 4 Summary of Procedures for Sampling Solids

	Section
Terminology	29
General Principles and Precautions	30
Sampling Equipment	31
Hand Scoop	31.1
Stream Sampling Cup	31.2
Shovel Sampler	31.3
Thief Samplers	31.4
Soil Sample Auger	31.5
Machine Samplers	31.6
Application of Sampling Equipment	32
Preparation of Reduction of Sample	33
Laboratory Sample and Storage Precautions	34
Labeling Sample Containers	35

29.1.7 *laboratory sample*—that portion of the subsample which is sent to the laboratory for testing.

### 30. General Principles and Precautions

30.1 Every sample must be collected and prepared in strict accordance with a specified procedure.

30.2 Because of many variations in the conditions under which solids must be sampled, and in the nature of the material being sampled, it is essential that the samples be collected by a trained and experienced sampler. Because of variations in the manner of handling the solid, it is impossible to specify rigid rules describing the exact manner of sample collection. Correct sampling principles must be applied to conditions as they are encountered.

30.3 To be able to make probability, or confidence statements about the property of a lot, the sampling procedure must allow for some element of randomness in selection because of the possible variations in the quality of the material. Generally, where segregation is known to exist, and random variation of quality is not possible, the sampling should be designed to allow for this. The sampler should always be on the alert for possible biases arising from the use of a particular sampling device or from unexpected segregation in the material. Generally, where sampling is to be applied to the output of a given process on a continuous basis, it will be desirable before adopting a particular sampling plan, to undertake an extensive preliminary study of variation in the material and possible biases in sampling instruments and methods of reduction.

30.4 The statistical principles governing the number and location of the samples taken from packaged lots of solid materials are essentially those outlined in Sections 7, 8, 9, 10, and 11, on statistical considerations.

30.5 Whenever possible, nonpackaged, bulk materials should be sampled while the material is in motion rather than in static piles, carloads, etc. Such occasions are frequently ideal for the application of falling-stream samplers.

30.6 Sampling of bulk solids from boxcars, barges, etc., introduces additional problems because of possible nonuniformity in particle size, moisture, impurities, etc. The statistical treatment is complex and beyond the scope of this practice. For a typical example, see Test Methods D2234/D2234M, and Ref (1).<sup>7</sup>

30.7 All auger methods and all scoop methods used on materials not being loaded or transferred fail a prime sampling requirement—that of random selection of the particles or portions selected as samples. Scoops and shovels are limited to use at or near the top surface. Augers and thieves are normally inserted in a preset pattern. Consequently, particles on the bottoms or along certain sides of containers never have an opportunity to be included in a sample. For heterogeneous or valuable material, this alone may furnish sufficient reason to go to a falling-stream sampler.

<sup>7</sup> The boldface numbers in parentheses refer to the list of references appended to this practice.

30.8 Because of the above factors, the recommended procedures that follow are limited to the mechanical operations of taking the required number of increments called for in another standard or in a purchase contract (2,3).

30.9 The sampling equipment, sample preparation equipment, containers, etc., used in sampling must be clean, dry, uncontaminated, and inert to the material being sampled, and protection from heat, cold, light, loss or gain of moisture may be necessary.

### 31. Sampling Equipment

31.1 *Hand Scoop*, for sampling powders from containers and conveyors:

31.1.1 This implement is used for taking small equal portions at either random or regular intervals from the mass of material to be sampled. It is most frequently used to sample drums, bags, barrels, or other containers, but may also be used to take portions from a flowing stream, such as a belt conveyor, in a chute, etc.

31.1.2 The scoop can be of any suitable size or shape, depending, in part, on the size and shape of the particles in the material to be sampled and the quantity of sample required.

31.1.3 A sample of a flowing stream should be taken by a single motion of the scoop in such a way as to take a complete cross section of the stream. The scoop should not overflow during this single motion.

31.1.4 Scoop sampling of static material consists of taking samples at or near the surface, and requires nearly perfect homogeneity, a condition that rarely exists for all characteristics of the material. The larger particles, especially if they approach the size of the scoop, will frequently be rejected in the sample taking.

31.2 *Stream Sampling Cup*, for sampling powders from conveyors and chutes:

31.2.1 The cup is used for selecting samples from a flowing stream, such as a conveyor, a chute, or a belt.

31.2.2 The size of the cup depends upon the diameter of the particle being sampled and the width of the stream of powder. The mouth width of the sampling cup should be at least three times the diameter of the largest particles being sampled. The mouth length of the cup must be sufficient to cut the entire stream of material as the material drops from a transfer belt. Fig. 8 indicates a design of a suitable cup.

31.2.3 The cup is passed through the entire stream of material as it drops from a belt or a chute. The approximate discharge time must be predetermined in order to secure a minimum of ten alternating, and equally timed, spaced cuts. The cup should be passed through the entire stream in a uniform motion, at the predetermined intervals throughout the loading operation regardless of the size of the sample or number of passes required. Stream sampling is not recommended normally for many materials unless a uniform continuous flow of materials is maintained for at least 3 min while the lot is sampled.

31.3 *Shovel*, for sampling large bulks:

31.3.1 A shovel is used for taking samples from larger bulk shipments such as freight cars, boats, and truck loads. It is most

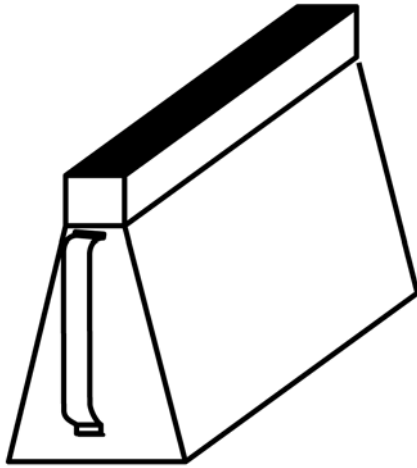

FIG. 8 Stream Sampling Cup

advantageous when material is being loaded or unloaded, or moved by shoveling. It suffers the same disadvantages as the hand scoop.

31.4 Thief Samplers:

31.4.1 Split Tube Thief:

31.4.1.1 This instrument is essentially a tube, usually 19 mm (¾ in.) in diameter, with a slot running the entire length of the cylinder (Fig. 9). The end of the tube has a sharp, angled point.

31.4.1.2 Insert the thief into the material far enough to reach the opposite side (or the bottom) of the container. Then carefully withdraw the thief and extrude the increment into the sample container.

31.4.1.3 The split tube thief is especially suitable for sticky material, in which case the sample may need to be removed with a spatula or other suitable device.

31.4.2 Concentric Tube Thiefs:

31.4.2.1 This equipment is used for taking samples of free-flowing materials like grains from drums, cans, bags, and other containers. Two types are described.

31.4.2.2 Multi-Slot Tube Thief—This apparatus consists of two tubes, one fitting snugly inside the other. One end of the outer tube is fitted with a point. Oblong holes about 125 by 25 mm (5 by 1 in.) apart are cut through the tubes in corresponding positions. The holes are opened or closed by rotating the inner tube (Fig. 10).

31.4.2.3 Insert the thief in the material with the inner tube holes closed. Rotate the inner tube to an open position to extract a sample of the material and to a closed position before withdrawing the thief from the container.

31.4.2.4 Single-Slot Tube Thief—This apparatus consists of two tubes fitting snugly into each other. The inner tube has a slot running lengthwise and has a pointed end. The outer tube slides over the inner one to expose or cover the slot (Fig. 11).

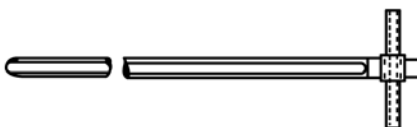

FIG. 9 Split Tube Thief

31.4.2.5 Close the sample thief so that the lower end of the outer tube rests on the shoulder at the bottom of the inner tube, and the inner tube is locked in position with the thumb screw. Then push the sample thief into the material diagonally or horizontally, as applicable. The outer tube is then unlocked and raised a few inches to expose the slot of the inner tube to the material. The slot is facing upward. Shake or jar the drum to cause the powder to enter the thief at the level of the slot opening. Then shake the container while opening the sample thief progressively to allow material from all levels to enter the thief. After the sample is in the inner tube, push the outer tube down to its original position. Then remove the thief from the material and invert it so that the sample drops into the sample bottle through the open end. It may be necessary to rap the thief sharply in order to dislodge the powder.

31.4.2.6 These concentric tube samplers have limited applicability. Material that is not free-flowing or is hard-packed is excluded, thus usually eliminating fine powders. On the other hand, the sampling of material containing granules or particles exceeding one third of the slot width should not be attempted, or bridging and resulting bias in favor of the small particles may result. Because of their pointed ends, these devices cannot sample the bottoms of the containers. If material has been vertically segregated into horizontal strata through vibration, or any other reason, the lowest strata will be inadequately represented. These problems are common to both tubes.

31.4.3 Compartmental Thiefs (Triers):

31.4.3.1 This equipment is used for taking samples of free-flowing materials like fertilizers, grain, and other powders from bags, drums, cans, piles, carloads, and bins. Two types are described.

31.4.3.2 Grain Probe— This apparatus consists of two tubes, one fitting snugly inside the other. One end of the outer tube may be tapered or fitted with an auger point. The trier is 1600-mm (63-in.) long, with an outside diameter of 35 mm (1⅜ in.); an inside diameter of 28 mm (1⅛ in.) with eleven compartments 90-mm (3½-in.) long; separated by 35-mm (1⅜-in.) long plugs (Fig. 12). The outer tube consists of slots that correspond to the compartments of the inner tube. The outer tube slides over the inner tube.

31.4.3.3 Insert the trier into the material vertically but do not point toward the center of the load. Open the tube with the slots facing upward, then close the tube, and withdraw the sample. The sample shall be discharged into a receiver as long as the sampling tube.

31.4.3.4 Missouri Trier— This apparatus consists of two tubes, one fitting snugly inside the other. The trier is an interrupted core-compartmental double tube. The trier is 1500-mm (59-in.) long, with an outside diameter of 28 mm (1⅛ in.), an inside diameter of 22 mm (7/8 in.), and with eight compartments 75 mm (3 in.) in size. The outer tube consists of slots that correspond to the compartments of the inner tube. The trier operates in the same fashion as the grain probe. Insert the trier as specified in 31.4.3.3. The slot width shall be at least three times the diameter of the largest particles to be sampled (Fig. 13).

31.4.3.5 It has been found that these triers secured samples that were closely comparable and most nearly representative of

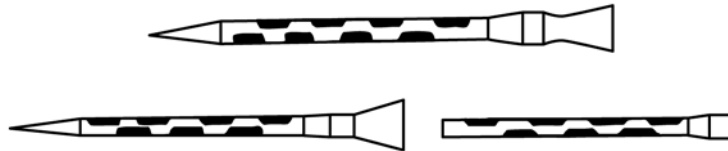

FIG. 10 Multi-Slot Tube Thief

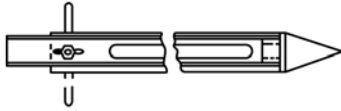

FIG. 11 Single-Slot Tube Thief



FIG. 12 Grain Probe



FIG. 13 Missouri Trier

the material being sampled. These triers have the tendency to secure samples that are biased to varying degrees in selecting more of the smaller size particles and less of the larger particles fraction. The triers are at the present time being used by the fertilizer industry (4).

31.4.3.6 Because of the close clearances, double-tube thieves and triers will impart a grinding action to the material being sampled. Soft granules are affected by such action, and thieves should not be used for such material if product sizing is important.

31.5 *Soil Sample Auger*, for sampling compact materials:

31.5.1 This is a screw-or-worm-type instrument useful for taking samples of compacted materials (Fig. 14).

31.5.2 The auger is turned into the material and then pulled straight out. The sample is removed from the auger with a spatula or other suitable device. The process is repeated at different locations as dictated by the sampling plan.

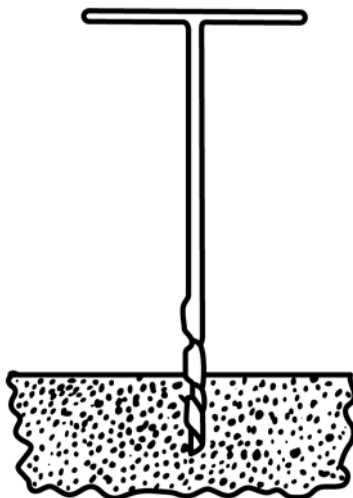

FIG. 14 Auger Sampler

31.6 *Machine Samplers*, for sampling powders from conveyors, bins, and containers:

31.6.1 *Vacuum Probe Samplers*, for large bulk containers:

31.6.1.1 This equipment can be used for extracting large samples from freight cars, barges, bins, boats, and truckloads, but only where air exposure does not affect significant properties of the material, such as moisture content. This type of sampler develops bias, if sizing is important. It preferentially selects fines.

31.6.1.2 The apparatus (Fig. 15) consists of a combination cyclone separator and motor driven blower, a probe and connection tubing.

31.6.1.3 This equipment works the same way as a vacuum cleaner. The probe burrows its way into the material being sampled and sucks the material into the sample collector.

31.6.2 In general, augering probably offers the best combination of economy, penetration ability, and sample representation, if the material is packaged in drums or similarly sized containers that are to be moved or transhipped without dumping. Although there are many designs, augers fall into the two general categories of open and enclosed augers.

31.6.3 *Powered Open Auger*—One of the most useful varieties of the open type is a ship auger about 30-mm (1<sup>3</sup>/<sub>16</sub>-in.) diameter, powered by a hand-operated 20-mm (3/4-in.) drill. The augering is performed through a hole in a catch pan that collects the sample brought to the top. Contents of the pan are then dumped into a sample container. Open augering may not give good vertical representation of the container because material at the top may be preferentially removed at the expense of the lower layers. Since many materials are frequently segregated vertically, a biased sample may result.

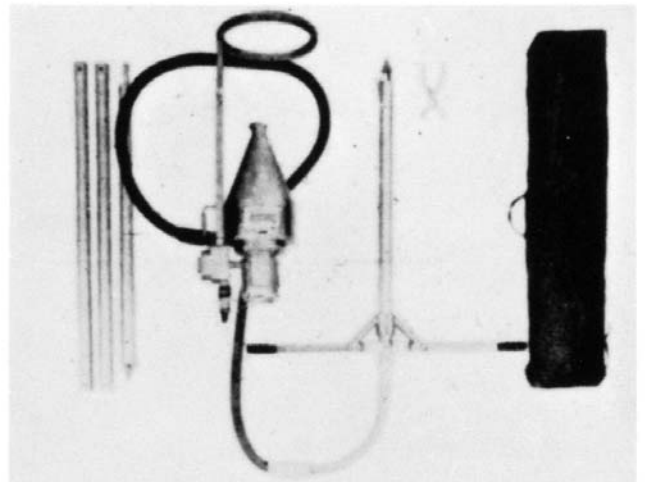

FIG. 15 Vacuum Sampler



31.6.4 *Enclosed Auger:*

31.6.4.1 Enclosed augers may either be the ship-auger type or have a central shaft with one or more flights. In either case, it will be surrounded by a sharpened cylindrical sheath which does not rotate. Material removed in drilling may be discharged through a side hose at the top, or it may be stored in the sheath for discharge by reversing the auger after withdrawal from the drum.

31.6.4.2 Because of the power required for the penetration drive and withdrawal, as well as the rotary motion, a fixed, permanent installation is required for an enclosed auger. Therefore, it is applicable only when a large number of similar drums or containers are to be sampled over a long period of time. An enclosed auger will obtain much improved vertical representation over an open auger, although it is also deficient in sampling the bottom 25 to 50 mm (1 to 2 in.) of a container.

31.6.5 *Gravity-Flow Auger Sampler:*

31.6.5.1 The equipment is designed for use in conveyor pipes, spouts, or hopper bottoms where material flows by gravity. It is suitable and very convenient for sampling products of nearly perfect homogeneity (Fig. 16).

31.6.5.2 The gravity-flow auger sampler works on the principle of rotating a slotted sample collection tube in a flowing mass. The material captured in the sample tube is augered out of the tube by an internal worm screw. A solenoid switch actuates the motor-driven auger at preset intervals and simultaneously engages a clutch to rotate the auger tube. The combination of auger pitch and rotation must be such as to remove the collected material to a collection chute before the sample can fall out on the opposite side through the more slowly rotating slot.

31.6.5.3 This sampling device has the advantages of relative simplicity and little occupied space. Another variation of this design is one in which the open slot is always upward and does not rotate, in which case the rotating auger must carry away the collected sample before bridging or overfilling can occur. For both designs, slot width and length, auger pitch and variation of pitch along axis, rotational speeds, flow rate of the bulk mass,

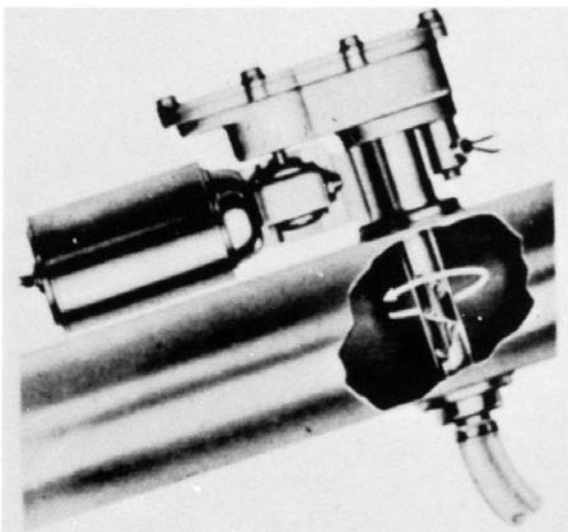

FIG. 16 Gravity-Flow Auger Sampler

and the amount of sample required must all be properly matched for accurate sampling. The disadvantage is that such a device cuts only part of the stream part of the time. Therefore, if the flowing stream is at all segregated in its cross section, a nonrepresentative sample will result unless all segregated layers are proportionately cut.

31.6.6 *Falling-Stream Samples:*

31.6.6.1 The most reliable method of removing a sample from a bulk mass employs a falling-stream system where a moving cutter removes all of the falling stream part of the time. Such cutters fall into the two general categories of arc-path and straight-path samplers. Slot widths of the cutter should be at least three times the diameter of the largest particles to be sampled; four times or more is preferable. Obviously, the speed of travel through the stream is one control of the sample size collected, but the speed of the cutter should not be so great as to knock the particles away (Fig. 17).

31.6.6.2 *Arc-Path Samples*—The most popular and probably the best performer of the arc-path samplers is the Vezin-type shown in the left half of Fig. 17. The material falls from a belt or vibratory feeder or is fed through a chute as a vertically falling stream that is cut by the radially rotating oriented slots of the cutter. Such a device will have one to usually not more than four slots. Material collected by the slots falls into the sample chute while the bulk of the material falls by into the reject stream. Mechanically, the Vezin sampler has the advantage of simple rotary motion, but it will not cut equal percentage from all parts of a stream if the slot sides are not perfect radii. The quantity of sample collected is controlled by slot width, number of slots, frequency of the slots passing through the stream (rotational velocity), and the rate of stream flow.

31.6.6.3 *Straight-Path Samplers*—With a straight-path sampler, the bulk material falls from a moving belt or other feeder, in a vertical stream through which passes a rectangular slot as shown in the right half of Fig. 17. Sample collected is usually diverted through an angled chute into a sample receptacle, and the gross reject material falls directly downward. The amount of sample collected is controlled by feed rate, slot width, cutter speed, and frequency. This sampler cuts every part of any shaped stream proportionately, and is potentially the most accurate type. Many variations occur in slot design and orientation and in the drive mechanism. The common Geary-Jennings type has a drive in which the cutter carriage is actuated by a heavy, motor-driven screw.

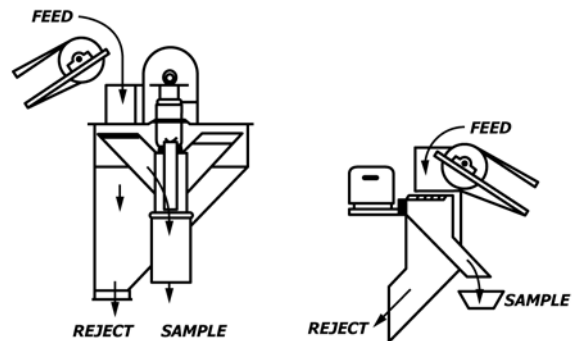

FIG. 17 Falling-Stream Samplers

31.6.6.4 The cross-cut sampler is a specific model of a straight-path sampler intended for installation in a spout or chute as shown in Fig. 18. Because of the limiting enclosure, the material sampled must be free-flowing. The apparatus consists of an air-actuated head in a box, a control box, and an airline connection. Collected sample is discharged through a flexible tube at the bottom of the sampler.

**32. Example of the Application of Sampling Equipment**

*32.1 Thief Sampling from a Container (5) :*

32.1.1 Remove a thief sample from each of the shipping containers selected for sampling in accordance with Sections 7 – 11 on statistical considerations.

32.1.2 Nearly all containers are filled in such a way that segregation occurs in the filling. For example, the large or heavier particles roll to the outside and the small, or light particles remain under the pouring spout where they fall. Additional segregation will probably result from the vibration of shipping. Therefore, sampling patterns are devised so that samples are taken in locations to represent as accurately as possible the segregated layers or regions. Cylindrical containers, or structures such as solidified metal pours, will commonly exhibit radial segregation and occasionally angular segregation (variation is observed along the circular path around the center). Sampling positions are calculated so as to represent annular rings of constant volume in proceeding from the center to the periphery. Angular or pie-shaped segments would be preferred but are usually impractical.

32.1.3 Except where a definite sampling pattern as previously described is to be followed, the sample equipment should usually be inserted diagonally into the container (4).

32.1.4 Individual samples from a single container may be composited if necessary to obtain a sample of adequate size for that container.

*32.2 Machine Sampling from a Flowing Stream:*

32.2.1 Sampling a material in motion, especially in a free-falling stream, is the preferred method for obtaining the most representative sample.

32.2.2 Arc-path or straight path samplers may be combined to give a series of two or more stages of sampling. In the design and operation of such a system, care must be taken to avoid air flows for dust collection, etc., which might bias the sample.

32.2.3 If operations are short term so as not to justify installation of a complete falling-stream system, the falling stream sampling may be attempted manually. The place should be accessible and safe for the person taking the sample. A scoop or slot (see 31.2) with parallel sides should be swept through the stream at a steady but sufficiently rapid rate so that it does not overflow on one pass. Passes should be timed and made at exactly regular intervals. Sampling under gondola cars is particularly difficult and should be replaced with sampling from a conveyor belt if possible.

*32.3 Auger or Shovel Sampling from Cars, Ships, Barges, etc.:*

32.3.1 The following is a typical example of the top sampling of an open railroad car.

32.3.2 Superimpose an imaginary grid above the material, and take samples at the intersections (Fig. 19), preferably by auger or thief if practical, or by digging a series of holes (pick and shovel) below the surface of the material before any portion of the contents has been removed.

32.3.3 Collect and identify the individual increments.

*32.4 Pattern Sampling of Bulk Material:*

32.4.1 Pattern sampling was developed to prevent bias in sampling of material in bulk form. This method of sampling takes into consideration the variation of particle size and composition around the loading point (4), for a particular type of loading.

32.4.2 The core locations of sampling patterns shall be as follows: 1 and 2 within 380 mm (15 in.) of loading point; 3, 4, 5, 6, midway between loading point and side or end; and 7, 8, 9, and 10 within 460 mm (15 in.) of corners and aimed toward bottom center (Fig. 20). The sampling device shall be inserted vertically in all locations.

**33. Preparation and Reduction of Sample**

33.1 *Appearance*—Visual inspection of the sample is recommended to determine if the material contains gross contamination, or if it is equal to the standard. It may show if the material has picked up excessive moisture, or if further laboratory processing is required to reduce the material to a more uniform particle size. Unusual appearance should terminate further testing until another sample is obtained, and the cause for the abnormality has been established.

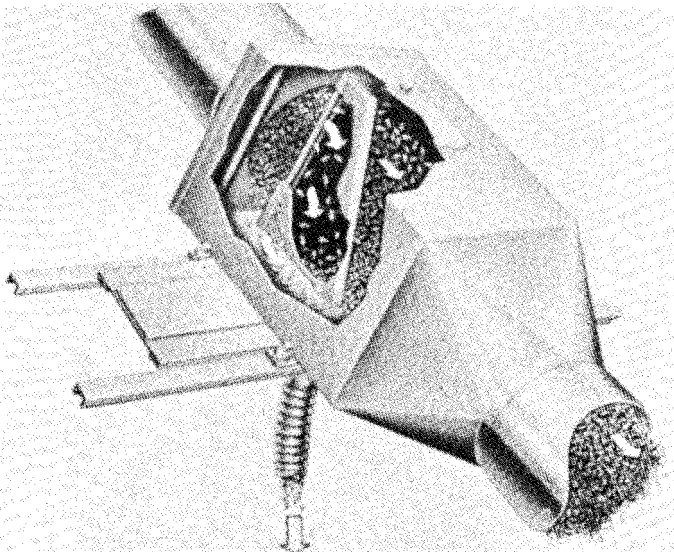

FIG. 18 Cross-Cut Sampler

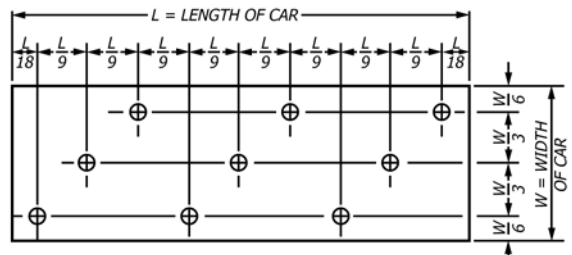

FIG. 19 Location of Sampling Points from the Exposed Surface of the Car

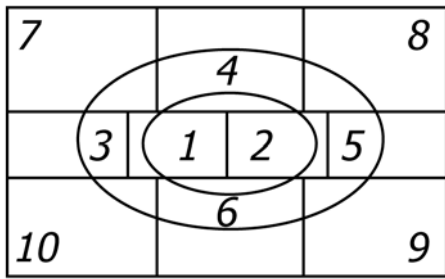

FIG. 20 Pattern Sampling

33.2 *Screening*—If extraneous matter is detected, a decision must be made as to whether it belongs in the sample. Tools, gloves, etc., are obviously misplaced. Dirt or other contamination may actually be in the lot and properly belong, in its proportionate part, in the sample. A careful consideration of each individual case must be made, to determine if the contaminant should be removed by passing the sample through an appropriate screen.

33.3 *Grinding*—Coarse or nonuniform samples may require grinding in a mortar, a mill, or other suitable mechanical devices to obtain a more uniform sample. The entire sample may be subjected to grinding; or it may be more efficient to screen off the oversize, grind it, and then blend all portions together.

33.4 *Minimum Sample Size*—Where analysis of a composite sample is specified or permitted, individual sample increments are combined and reduced. Many gross samples are unsuitable for laboratory handling or analysis, because they may be too heterogeneous or too large for the analyst to obtain good representation with his small sample. For every bulk solid, with its particular size distribution, there is a minimum amount of material which must be taken in the sampling operation in order for the sample to adequately represent the solid. This minimum quantity is called the minimum sample size, and the goal of any sample preparation is to make this minimum sample size. Although a thorough discussion of minimum sample size is beyond the scope of this practice, an excellent presentation by Benedetti-Pichler may be found in Ref (6).

33.5 *Sample Preparation Scheme*—In general, a sample preparation scheme will consist of particle size reduction, blending, splitting, and a repeat of this series of operations until the desired minimum sample size is attained. It is difficult to write a general scheme for the reduction of a sample for all types of material because of the nature of the material and the purpose of the sample. It is important, however, that any splitting operation be immediately preceded by blending. Two standard operations are given by the following procedures:

33.5.1 *Cone-and-Quarter Method*—Transfer the individual increments onto a clean canvas sheet (or other material suitable for use with the sample), and shovel into a pile, placing each shovelful on top of the pile. Flatten the apex of the cone with a shovel or a board until it is about one fourth its original height. Divide the pile into four equal parts by drawing a board twice through the center of the pile, making right-angle cuts. Discard the opposite quarters, chosen at random, and combine the remaining quarters into a cone-shaped pile. Repeat the

above operation until the desired quantity of sample is obtained. Place the final sample on a clean canvas, and mix by alternately raising opposite corners of the canvas sheet.

33.5.2 *Sample Splitter or Riffle:*

33.5.2.1 The sample splitter or riffle (Fig. 21) should be constructed of a material suitable for use with material under test. It consists of a series of chutes that are directed alternately to opposite sides. The slot width should be at least three or more times the diameter of the largest particle to be passed through to prevent bridging and, therefore, biased splitting.

33.5.2.2 Pass the composite or gross sample through the riffle to divide it into two approximately equal portions. Pass one of these portions, selected at random again through the riffle. Continue this operation until the sample size is reduced to either that required or the minimum sample size beyond which additional grinding is necessary.

33.6 *Blending*—Sample homogeneity must be assured by thorough blending prior to analysis. This operation must be performed on all samples in such a way that they will not be changed because of light sensitivity, hygroscopicity, etc. Do not fill sample containers more than approximately half full, and do not open a container for sample removal until it has been tumbled on a mechanical blender designed for the purpose or rotated by hand, end over end, at least 25 revolutions. On any sample, blending must be done after screening or grinding, or both.

34. Final Laboratory Sample and Storage Precautions

34.1 At least four times as much reduced sample should be prepared as is required for one laboratory to perform a complete analysis. Retain one portion of the well-blended sample for the manufacturer or seller, one for the purchaser, one for the umpire, if necessary, and one reserve to replace breakage or loss.

34.2 Samples that are to be stored over long periods, that may be affected by atmospheric exposure, or that may become seriously contaminated in contact with paper or cardboard should be packaged in widemouth, home-canning type mason jars having two-piece, metal caps. Best results are obtained if the sample is compatible, by vacuum sealing such bottles (6). Widemouth, screwcapped glass jars with caps and liners of suitable inert material are generally satisfactory.

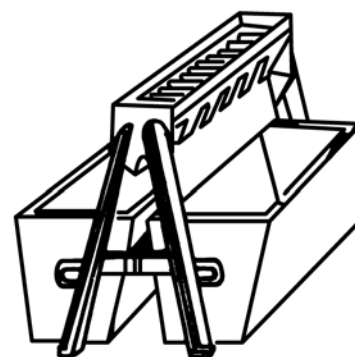

FIG. 21 Riffle Sampler

34.3 For materials in which water content is important or composition is subject to change upon atmospheric exposure, plastic containers are generally unsuitable because of their permeability. In other cases, tight, leakproof paper sample envelopes or cardboard cartons with or without plastic liners or coatings, or even tin cans, may be used to hold samples.

34.4 Where corrosion or atmospheric exposure cause problems it is usually better to use widemouth glass jars with suitable screw caps and liners (see 34.2).

### 35. Labeling Sample Containers

35.1 Label the container immediately after a sample is obtained. Use waterproof and oil-proof ink or pencil hard enough to dent the tag, since soft pencil and ordinary ink markings are subject to obliteration from moisture, oils smearing, and handling. If gummed labels are used, secure them further with transparent sealing tape. Write sufficient detail on the label to completely identify the sample. The following information is frequently desired:

35.1.1 Date and time.

35.1.2 Name of supplier.

35.1.3 Name or number and owner of the vessel, car, or container.

35.1.4 Brand name, grade of material, and code number.

35.1.5 Reference symbol and necessary identification number.

35.1.6 Hazard ratings.

## SLURRY SAMPLING

### 36. Scope

36.1 This practice describes equipment and procedures for sampling materials which are slurries at the time of sampling. A slurry is considered to be a suspension of solid particles in a liquid which can be separated by filtration or sedimentation (does not include emulsions). The equipment and procedures that are described in this practice are intended to supplement the experience of the sampler and to serve as a guide in selecting methods that are applicable to the material being sampled.

### 37. General Principles and Precautions

37.1 Quite often the value or quality of material being tested in the sample is related to particle size. When this is the case, any segregation of the particles tends to affect these values. Liquids that carry solid particles must have a certain velocity to keep the solids in suspension. To overcome the problem of segregation of materials by size or weight requires application of certain fundamentals of good sampling practice. The slurry should be stirred rapidly before sampling to assure uniform distribution of the solids.

37.2 At the time the sample is taken, all particles should be uniformly distributed throughout the liquid carrier. This will help to obtain a uniform sample.

37.3 The sampling of slurries with any degree of accuracy is quite difficult. This is particularly true when sampling a normally static system such as storage tank or vat. Arrange-

ment must be made to agitate thoroughly the content of such storage units prior to sampling. The most desirable and convenient place to sample a slurry is from a pipeline as the material moves through the line. Even here it is difficult to obtain an accurate sample, because slurries subjected to shearing will tend to change in composition due to the loss of the liquid. Fittings, bends, and other constructions in the line will tend to create nonuniformity in solids content. Lines that are smaller than 25 mm (1 in.) in diameter are usually not suitable for handling slurries because of frequent plugging. The use of a continuous running sample line provided with an orifice to reduce slurry velocity seems quite satisfactory.

37.4 If only a portion of any slurry sample can be used for analysis, shake the sample and dump a portion. Attempts to pour out a predetermined volume are unsatisfactory because the solids have time to separate during the pouring.

37.5 Slurry solids must be washed only with the filtrate, unless it has been proven that the proposed wash liquid does not dissolve out any fraction of the solids. Large errors can be introduced by washing out soluble fractions of a slurry.

37.6 Sampling practice adhering to above techniques will produce a reliable sample. The sample is accepted as representing the entire stream at the time it was taken. The more frequently the subsamples are taken, the more accurately will the sample represent the total stream.

### 38. Continuous Sampling

38.1 *Sample Cutter of a Slurry Stream*—Continuous samples are taken at various locations in the plant by a properly designed sample cutter. The opening in the cutter must be sufficiently large that collision of particles will not restrict their entrance into the cutter. The cutter must hold all of the sample without overflowing, and must move completely through the stream at a uniform speed.

38.2 *Stationary Sampling Probe, Horizontal Pipe:*

38.2.1 A continuous sample may also be taken in pipes by a stationary sampling probe which should be located at 20 pipe diameters (PD) and preferably 40 PD or more downstream from any elbow, valve, or other fitting.

38.2.2 The probe opening should be placed at the center of the cross-section of the pipe and pointed precisely upstream.

38.2.3 The sample should be withdrawn at a rate such that the velocity of flow (feet per second) through the probe opening is equal to the centerline velocity (isokinetic). However, for practical purposes, the sample can be withdrawn at 1.2 multiplied by the average velocity of flow.

38.2.4 The average concentration in the pipe is calculated by dividing the composition of the sample by a value  $V$  (determined from Fig. 22).

38.2.5 Openings flush with the pipe wall, elbow wall, (Fig. 23) or pump wall do not yield reproducible results for systems that are difficult to suspend. Such systems are those whose settling ratios,  $S$ , are above 1.0 ( $S$  is the ratio of bottom to top concentration in a settling device). For systems whose settling ratios,  $S$  are below 1.0, and whose concentration gradient,  $-m$  is less than 0.1, a side-wall tap will give satisfactory results (7).

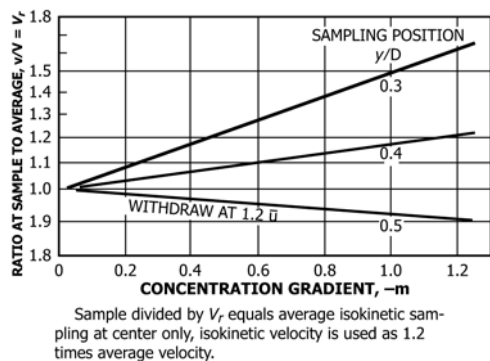

**FIG. 22 Average Concentration from Sample Concentration**

38.2.6 Use of a circular port probe under the conditions described in the preceding paragraphs, (see 38.2.1 – 38.2.4) will result in samples whose reproducible average will be within 8 % of a stream composition for a wide variety of systems and within 2 % for a large majority of suspensions likely to be encountered in petroleum operations (7).

38.3 *Sampling in a vertical pipe, upward flow, pipe precisely vertical.*

38.3.1 The sample probe opening must be pointed downward, precisely vertical, and at least 3 PD above any elbow or fitting.

38.3.2 Place the probe opening at the center of the pipe cross-section.

38.3.3 Withdraw the sample at a rate such that the velocity of flow through the probe opening is equal to the centerline velocity of the flowing stream. However, for practical purposes, the sample can be withdrawn at 1.2 multiplied by the average velocity of flow.

38.3.4 Use of a circular probe under the conditions described in 38.3.1 – 38.3.3 will result in samples that will equal the average composition within  $\pm 0.05$  absolute volume percent. It is not necessary to use an adjustment factor as is the case for the condition described in 38.2.4 for the horizontal pipe (7).

38.3.5 The withdrawal probe, used as recommended, will give a sample that can be accurately related to the average composition that flows through the pipe, and deviations in position and withdrawal velocity will result in a change of sample composition. Such changes are primarily the result of the settling rate of the dispersed phase, the rate of withdrawal of the sample, and the rate of flow in the pipe.

38.4 In order to reduce the volume of this continuous primary sample so that the amount of material is correct for the analysis, the primary sample is reduced in size by an automatic sampler to provide an increment sample. This increment is discharged into a small agitator to keep the solids in suspension until the sample is analyzed (1).

NOTE 16—The isokinetic sampling (where the linear velocity through the opening of the sampling probe is equal to the linear velocity in the pipe in front of the opening) is recommended for sampling in both vertical and horizontal pipes. Nonisokinetic sampling can be done with equally accurate results, but a knowledge of concentration gradient (which is a function of settling velocity, pipe size, and rate of flow) is necessary so

that the ratio between sample composition and average pipeline composition can be determined.

### 39. Sampling of a Slurry in Tanks, Tank Cars, Drums, and Other Storage Containers

39.1 *Mixing*—Mix the full tank containing the slurry for 1 h by using mechanical agitation with a four-arm and a rake-bottom sweep agitator moving at 4 rpm, so that the slurry is thoroughly uniform. Stop the mixing and take the samples immediately while the contents of the tank are still in motion.

39.2 *Sampling:*

39.2.1 The sampling bottle is a 1-L (32-oz) weighted bottle attached to a cord and a stopper with an attached chain (see Fig. 24).

39.2.2 Sample bottles are three 1-L (32-oz) wide-mouth polyethylene jars with proper seals, labeled 1, 2, and 3.

39.2.3 Drop the weighted stoppered sampling bottle into the slurry to a depth well under the surface and well away from the side of the tank near the center point if practical. Pull the stopper, allow the bottle to fill, and then pull to the surface. Initially, run other location checks to determine uniformity of the slurry.

39.2.4 Fill each numbered 1-L (32-oz) sample bottle one third full from the sampling jar (see Fig. 24) in the numerical order of 1, 2, and 3.

39.2.5 Refill the sampling jar and fill the sample bottles about two thirds full in the numerical order of 2, 3, and 1.

39.2.6 Fill the sampling jar and fill the sample bottle within about 50 mm (2 in.) of the top in the numerical order of 3, 1, and 2.

39.2.7 Determine the temperature of the slurry to the closest 1°C during the final sampling step.

39.2.8 Take the three sample bottles to the laboratory, wash them, wipe the lips and seals clean and dry, and reseal.

39.2.9 Seal the sample kept as a retainer with a new cap, and then further seal by a plastic wrap, covering the entire cover.

### 40. Settling Rate Test (7)

40.1 The settling rate test will distinguish between those suspensions which are easy or difficult to suspend and, consequently, those which are easy or difficult to sample. A suspension can be withdrawn from a flowing stream and used in the test. Low values of the settling ratio means that the suspension is insensitive to the method and rate of sampling, whereas high values show that the recommendations given above must be adhered to.

### 41. Consistency of Slurry Suspensions (8)

41.1 *Scope*—This test method describes the determination of the consistency of slurry suspensions and is applicable to aqueous slurry suspensions containing 0 to 1, 1 to 4, 4 to 15, and 15 to 25% of dry solids. Slurry consistency (more properly “concentration”) is defined as the mass of oven-dry solids in 100 g of the slurry.

41.2 *Apparatus:*

41.2.1 *Sampling Cup* of about 200-mL capacity with a height approximately equal to its diameter and with a smooth lip. If the slurry to be sampled is to be taken from a source

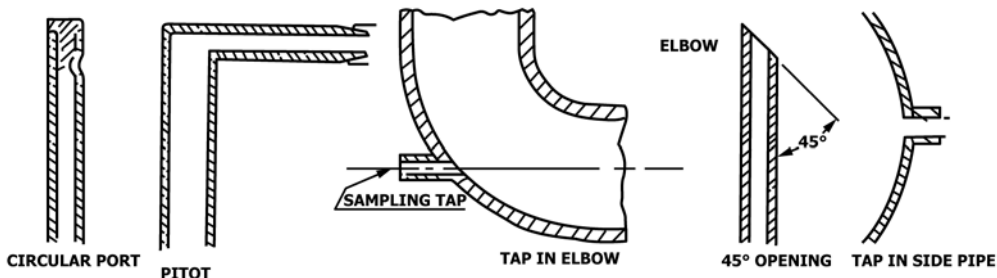

FIG. 23 Sampling Probes and Taps

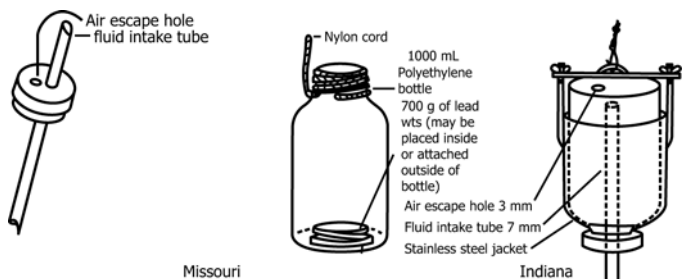

FIG. 24 Missouri and Indiana Weighted Restricted-Fill Fluid Fertilizer Sampling Bottles Designed to Fill While Being Lowered (and Raised) in Storage Tanks

where it is being well mixed, it is preferable to use a larger sampling cup or jug having a capacity of about 1 L.

41.2.2 *Beakers*, 600 to 1500-mL, tared to the nearest 0.1 g.

41.2.3 *Containers*—A 10-L (3-gal) bucket and a 40-L (12-gal) container, both tared.

41.2.4 *Mixing Device*, for the 10 and 40-L containers, preferably a portable electric stirrer.

41.2.5 *Balances*, 40-kg capacity, accurate to 50 g, a 2-kg capacity accurate to 0.1 g.

41.2.6 *Büchner Funnel and Flask*, 150-mm.

41.2.7 *Filter Paper*, 150-mm diameter, coarse texture.

41.2.8 *Drier or Steam Cylinder*, with wire mesh cover, large enough to accommodate 150-mm filter papers, controlled within a range from 110 to 150°C.

41.2.9 *Laboratory Drying Oven with Balance*, oven maintained at  $105 \pm 3^\circ\text{C}$ , the balance having a capacity of at least 100 g and accurate to 0.01 g.

41.3 *Sampling*—Take the sample at the point of where the sample is uniform and in such a manner as to be representative of the solid water mixture.

41.4 *Procedure*:

41.4.1 *Mixtures Containing Less Than 1 % of Solids*:

41.4.1.1 Use the sampling cup to withdraw five representative portions of approximately 100 g each. Each time, deposit the entire contents in the tared 600-mL beaker. Carefully dry the outside of the beaker and weigh it and its contents to the nearest 0.1 g to determine the net mass of the specimen.

41.4.1.2 Place a tared filter paper in the Büchner funnel, moisten with water, then apply suction to the flask and filter the slurry. Remove the resulting pad and filter paper and heat on the dryer until it ceases to steam. Place the paper and pad on the weighing pan of the laboratory oven balance and make

successive measurements after additional drying until a constant weight is obtained. Weigh to the nearest 0.01 g.

41.4.1.3 The percentage consistency concentration of the sample is then:

$$[(w - f)/g] \times 100 \quad (30)$$

where:

- $w$  = mass of the moisture-free mat and filter paper, g,
- $f$  = mass of the moisture-free filter paper, g, and
- $g$  = net mass of the original sample in the 600-mL beaker, g.

NOTE 17—After removing filter paper and pad from Büchner funnel, ensure all solids are wiped clean from the inside surface of the funnel and deposited onto the pad. This can be done with the finger.

NOTE 18—Drying can be sped up if the pad is pressed between blotters in a hydraulic press before drying.

NOTE 19—If the pad tends to stick to the cylinder, place the pad between dry blotters. The surface of the cylinder may be treated with a silicone spray to prevent sticking.

41.4.2 *Mixtures Containing 1 to 4 % Solids*:

41.4.2.1 Use the sampling cup to withdraw ten consecutive representative portions of solids slurry; fill the cup each time and empty the entire contents into the tared 1500-mL beaker. Weigh the contents to the nearest 0.5 g and determine the mass of the specimen.

41.4.2.2 Deposit the specimen into the tared 10-L bucket and dilute to 0.5 % consistency concentration or less, using some of the water to rinse all the solids from the beaker. Weigh and determine the net mass of the contents to the nearest 10 g.

41.4.2.3 Determine the percentage consistency concentration of the stock in the bucket as in 41.4.1, stirring the stock vigorously with the sampling cup before withdrawing a portion. The percentage consistency of the original sample is then

$$p \times (W/w) \quad (31)$$

where:

- $p$  = percentage consistency concentration of the diluted stock,
- $W$  = net mass of the contents of the bucket, g and
- $w$  = mass of specimen, g.

41.4.3 *Mixtures Containing 4 to 15 % Solids*:

41.4.3.1 With the sampling cup, withdraw ten consecutive portions of solids slurry, filling the cup approximately half full each time and emptying the contents into the tared 1500-mL beaker. Weigh the beaker and its contents to the nearest 0.5 g and determine the mass of the specimen.

41.4.3.2 Deposit the specimen into the tared 40-L container and dilute to less than 0.5 % consistency using some of the

water to rinse all the solids into the beaker. Insert and adjust the electric mixer for thorough agitation of the suspension.

41.4.3.3 Proceed as in 41.4.1.2.

41.4.4 For mixtures containing 15 to 25 % solids, proceed as in 41.4.3, except instead of ten, take five representative portions of the original stock of approximately 100 g each.

## 42. Keywords

42.1 sampling; simple liquids; slurry; solids; statistical

## ANNEX

### (Mandatory Information)

#### A1. DETERMINATION OF THE BASIC VARIANCES FROM AN INITIAL PILOT STUDY OF THE MANUFACTURING PROCESS

##### A1.1 Introduction

A1.1.1 The procedures of this practice assume that the manufacturing process turns out material in batches and that there is variation within batches and between batches. It also assumes that the variation within batches and the variation between batches are both random. Furthermore, it assumes that the variance of the within-batch variation is the same for all batches and the variance of the between-batch variation is constant over time. A preliminary step, therefore, is to determine whether these hypotheses are acceptable for a given process. If they are accepted, then the next step is to estimate the within-batch and between-batch variances. If the hypotheses are rejected, the next step is either (a) to make engineering changes in the process that will lead to the hypotheses becoming valid or (b) to find a more sophisticated model for describing the process.

##### A1.2 Determination of Randomness of Within-Batch and Between-Batch Variation

A1.2.1 *Step 1*—Take 2 “increments of material” at random for each of 25 *consecutive* batches produced by the given process. If the material comes in packaged form, the 2 increments of material could be 2 randomly selected packages. If it comes in bulk form, the 2 increments could be 2 “shovel fulls” or the like. For packaged material this is piled in order, the 2 packages should be selected by the use of random numbers. Material that comes in bulk is probably best sampled as it is moved, on a conveyor belt or otherwise, and the increments should then be selected at random intervals of time, random numbers again being employed. In the latter case, the precise nature of the sampling instrument (shovel, etc.) must be specified and also the size of the increment it selects.

A1.2.2 *Step 2*—Prepare for laboratory testing each of the 50 increments taken as called for in Step 1 and make a single measurement on each under as uniform conditions as possible (same laboratory, same analyst, same day, if possible).

A1.2.3 *Step 3*—Prepare 3 control charts for the 50 measurements called for above.<sup>8</sup> These should be:

- (1) A range chart for the 2 increments from each batch,
- (2) A chart of the means of the 2 tests made on each batch, and
- (3) A moving range chart of the batch means.

A1.2.4 *Step 4*—If there is no point above the upper limit on Chart (1) and no run of 7 or more points above or below the center line or other evidence of nonrandom variation, accept the hypothesis that the basic within-batch variability is random with the same variance.

A1.2.5 *Step 5*—If on Chart (2) there is no trend, no runs of 7 or longer above the average or no other evidence of nonrandom variation and also if on Chart (3) there is no point above the upper control limit or no run of 7 or more above the center line or other evidence of nonrandom variation, then accept the hypothesis that the variation from batch to batch is random with constant variance.

A1.2.6 If the process passes all of the above tests without exception, the data can be used without modification to measure the basic variances as described in A1.3. If any exceptions occur, a statistician should be consulted as to what information about basic variances may be obtained from the data and just how this should be done. In fact, it might be helpful even prior to this to have the advice of a statistician in interpreting the control charts, in Steps 3 and 4.

##### A1.3 Determination of Basic Material Variances

A1.3.1 Given that the process meets the randomness requirements of Section A1.2, a “components of variance analysis” should be performed to estimate the within-batch variance and the between-batch variance. The procedure is as follows:

A1.3.1.1 *Step 1*—Compute

$$s_w^2 = \sum_i \sum_j (X_{ij} - \bar{X}_{i.})^2 / 25(2 - 1) \quad (A1.1)$$

$$s_b^2 = 2 \sum_i (X_{i.} - \bar{X}_{..})^2 / (25 - 1) \quad (A1.2)$$

where:

$\bar{X}_{i.}$  =  $\sum_j X_{ij} / 2$  is the mean of the test made on the 2 increments from the  $i^{th}$  batch, and

$\bar{X}_{..}$  = is the mean of the whole (25) (2) = 50 tests.

<sup>8</sup> See any standard book on control charts, for example, Duncan, A. J., *Quality Control and Industrial Statistics*, or Grant, E. L., *Statistical Quality Control*.

A1.3.1.2 *Step 2*—Take  $\hat{\sigma}_w^2 = S_w^2 - \hat{\sigma}_r^2$  as an unbiased estimate of the within-batch variance where  $\hat{\sigma}_r^2$  is determined as in A1.4.

A1.3.1.3 *Step 3*—Take  $\hat{\sigma}_w^2 = [(s_b^2 - s_w^2)/2]$  as an unbiased estimate of the between batch variance.

#### A1.4 Determination of Basic Variances of Reduction and Analysis

A1.4.1 *Step 1*—Take 20 increments from each of 5 batches. From physical composites of the 1st, 2nd, 3rd, ..., 20th increments from each of the 5 batches making a total of 20 composites. Reduce each composite to the size of a laboratory sample by whatever method of reduction is standard for the given material and prepare each of the 20 laboratory samples for testing. Run two tests on the laboratory sample from each composite.

A1.4.2 *Step 2*—Construct a control chart on the differences between the two tests for each of the 20 composites. This is to check on the uniformity of the testing procedure. Call the chart Control Chart (4).

A1.4.3 *Step 3*—Construct a moving range chart on the means of the two tests for each of the 20 composites to check on the uniformity in the reduction procedure.

A1.4.4 *Step 4*—If the hypothesis of uniformity is satisfied in each case, compute

$$s_r^2 = \sum_k \sum_i (X_{ki} - X_k)^2 / 20(2 - 1) \quad (\text{A1.3})$$

$$s_r^2 = 2 \sum_k (X_k - \bar{X})^2 / (20 - 1) \quad (\text{A1.4})$$

where:

$\bar{X}_k$  = mean of the test made on the  $i^{\text{th}}$  composite, and  
 $\bar{X}$  = mean of the whole (20) (2) = 40 tests.

A1.4.5 *Step 5*—Take  $\hat{\sigma}_r^2 = s_r^2$  as an unbiased estimate of the testing variance.

A1.4.6 *Step 6*—Take  $\hat{\sigma}_r^2 = [(s_r^2 - s_t^2)/2]$  as an unbiased estimate of the variance of reduction.

#### REFERENCES

- (1) Cook, P. E., "Continuous Sampling for X-Ray Analysis," Denver Equipment Co., (Bulletin No. S1-B12) 1400 17th St., Denver, CO 80217.
- (2) Duncan, A. J. "Bulk Sampling: Problems and Lines of Attack," *Technometrics*, TCMTA, Vol 4, No. 3, August, 1962, p. 319.
- (3) Bicking, C. A. "The Sampling of Bulk Materials," *Materials Research and Standards*, MTRSA, Vol 7, No. 3, March, 1967, p. 95.
- (4) Gehrke, C. W., Baker, W. L., Krause, G. F. and Russell, C. H., "Sampling of Bulk Fertilizers," *Journal of the Association of Official Analytical Chemists*, JANCA, Vol 50, April, 1967.
- (5) Jones, R. J., Ed., "Selected Measurement Methods for Plutonium and Uranium in the Nuclear Fuel Cycle," Division of Technical Information, U. S. Atomic Energy Commission, 1963, pp. 49–50.
- (6) Berl, W. G., Ed., *Physical Methods in Chemical Analysis*, Academic Press, Inc., New York, 1956, Vol 3, pp. 183–201.
- (7) Rushton, J. H. and Hillestad, J. G., "Sampling of Nonhomogeneous Flow in Pipes," Paper for Presentation to a session on General Engineering during the 29th Midyear Meeting of the American Petroleum Institute Division of Refining in Chase Park Plaza Hotel, St. Louis, MO, May 13, 1964.
- (8) "Consistency (Concentration) of Pulp Suspensions," T-240, SU-67, TAPPI Standard 360, Technical Association of Pulp and Paper Industry. One Dunwood Park, Atlanta, GA 30341.

*ASTM International takes no position respecting the validity of any patent rights asserted in connection with any item mentioned in this standard. Users of this standard are expressly advised that determination of the validity of any such patent rights, and the risk of infringement of such rights, are entirely their own responsibility.*

*This standard is subject to revision at any time by the responsible technical committee and must be reviewed every five years and if not revised, either reapproved or withdrawn. Your comments are invited either for revision of this standard or for additional standards and should be addressed to ASTM International Headquarters. Your comments will receive careful consideration at a meeting of the responsible technical committee, which you may attend. If you feel that your comments have not received a fair hearing you should make your views known to the ASTM Committee on Standards, at the address shown below.*

*This standard is copyrighted by ASTM International, 100 Barr Harbor Drive, PO Box C700, West Conshohocken, PA 19428-2959, United States. Individual reprints (single or multiple copies) of this standard may be obtained by contacting ASTM at the above address or at 610-832-9585 (phone), 610-832-9555 (fax), or service@astm.org (e-mail); or through the ASTM website (www.astm.org). Permission rights to photocopy the standard may also be secured from the Copyright Clearance Center, 222 Rosewood Drive, Danvers, MA 01923, Tel: (978) 646-2600; http://www.copyright.com/*