



# Standard Test Methods for Bend Testing of Material for Ductility<sup>1</sup>

This standard is issued under the fixed designation E290; the number immediately following the designation indicates the year of original adoption or, in the case of revision, the year of last revision. A number in parentheses indicates the year of last reapproval. A superscript epsilon ( $\epsilon$ ) indicates an editorial change since the last revision or reapproval.

*This standard has been approved for use by agencies of the U.S. Department of Defense.*

## 1. Scope\*

1.1 These test methods cover bend testing for ductility of materials. Included in the procedures are four conditions of constraint on the bent portion of the specimen; a guided-bend test using a mandrel or plunger of defined dimensions to force the mid-length of the specimen between two supports separated by a defined space; a semi-guided bend test in which the specimen is bent, while in contact with a mandrel, through a specified angle or to a specified inside radius ( $r$ ) of curvature, measured while under the bending force; a free-bend test in which the ends of the specimen are brought toward each other, but in which no transverse force is applied to the bend itself and there is no contact of the concave inside surface of the bend with other material; a bend and flatten test, in which a transverse force is applied to the bend such that the legs make contact with each other over the length of the specimen.

1.2 After bending, the convex surface of the bend is examined for evidence of a crack or surface irregularities. If the specimen fractures, the material has failed the test. When complete fracture does not occur, the criterion for failure is the number and size of cracks or surface irregularities visible to the unaided eye occurring on the convex surface of the specimen after bending, as specified by the product standard. Any cracks within one thickness of the edge of the specimen are not considered a bend test failure. Cracks occurring in the corners of the bent portion shall not be considered significant unless they exceed the size specified for corner cracks in the product standard.

1.3 The values stated in SI units are to be regarded as standard. Inch-pound values given in parentheses were used in establishing test parameters and are for information only.

1.4 *This standard does not purport to address all of the safety concerns, if any, associated with its use. It is the responsibility of the user of this standard to establish appropriate*

*appropriate safety and health practices and determine the applicability of regulatory limitations prior to use.*

## 2. Referenced Documents

2.1 *ASTM Standards:*<sup>2</sup>

- E6 Terminology Relating to Methods of Mechanical Testing
- E8/E8M Test Methods for Tension Testing of Metallic Materials
- E18 Test Methods for Rockwell Hardness of Metallic Materials
- E190 Test Method for Guided Bend Test for Ductility of Welds

## 3. Summary of Test Methods

3.1 Four methods for ductility testing employing bending are included in these test methods. Three methods have subgroups with specific procedures.

3.1.1 *Guided Bend:*

- 3.1.1.1 Guided Bend, No Die,
- 3.1.1.2 Guided Bend, U-Bend,
- 3.1.1.3 Guided Bend, V-Bend,
- 3.1.1.4 Guided Bend, V-Bend for cold rolled sheet,

3.1.2 *Semi-guided Bend:*

- 3.1.2.1 *Arrangement A*, specimen held at one end.
- 3.1.2.2 *Arrangement B*, for thin material.
- 3.1.2.3 *Arrangement C*, mandrel contact force in the bend.

3.1.3 *Free-Bend:*

- 3.1.3.1 *Type 1*, 180° bend.
- 3.1.3.2 *Type 2*, bend flat on itself.

3.1.4 *Bend and Flatten:*

3.2 A guided-bend test for ductility of welds is described in Method E190 and may be used for flat-rolled materials when specified by the product standard. The essential features of this bending method are employed in 3.1.1.2, Guided Bend, U-Bend.

3.3 Bend tests are made in one of two directions relative to the principal working direction employed in production processing of the material.

<sup>1</sup> This test method is under the jurisdiction of ASTM Committee E28 on Mechanical Testing and is the direct responsibility of Subcommittee E28.02 on Ductility and Formability.

Current edition approved May 1, 2014. Published September 2014. Originally approved in 1966. Last previous edition approved in 2013 as E290 – 13. DOI: 10.1520/E0290-14.

<sup>2</sup> For referenced ASTM standards, visit the ASTM website, www.astm.org, or contact ASTM Customer Service at service@astm.org. For *Annual Book of ASTM Standards* volume information, refer to the standard's Document Summary page on the ASTM website.

\*A Summary of Changes section appears at the end of this standard

3.3.1 Longitudinal tests use a specimen with its long dimension aligned with the processing direction such that the bend is formed across the processing direction, as shown in Fig. 1.

3.3.2 Transverse tests use a specimen with the long dimension perpendicular to the processing direction so that the bend axis is aligned with the processing direction, as shown in Fig. 2. The axis of bend is the center of the bend radius.

3.3.3 Thin sheet products are generally produced by reducing the thickness of stock in rolling mills and from this the term rolling direction is used to identify the principal processing direction. Similarly, a product produced in coil form may have the processing direction referred to as the coiling direction.

3.4 The location of the force application to the specimen relative to the bend itself and the amount of bending differentiate the four methods of bending covered in these test methods. The two semi-guided bend test procedures provide radiused surfaces over which the bend is formed. The results obtained by different test procedures may not be the same, especially for material with a tendency to crack or fracture.

3.5 The test is completed when the designated angle of bend, or other specified condition, has been reached.

3.5.1 If a defined amount of cracking is permitted by the product standard, the convex surface of the bend region is examined for cracks and surface irregularities.

3.5.2 Surface irregularities, such as orange peel, loss of coating adherence, or imperfections resulting from the bend, shall be noted as required by the product specification.

3.6 *Guided Bend*—The guided-bend test is made by supporting the specimen near each end on pins, rollers, or flat surfaces with appropriate end radii and applying a force through a pin, mandrel, plunger, or male die midway between two supports, as shown schematically in Fig. 3, Fig. 4, Fig. 5, and Fig. 6 until the desired bend is formed. No force is applied directly to the outer face of the bend when no female die is used (3.1.1.1). Some force may be applied by the female die to the outer face of the bend in the case of U-bend (3.1.1.2) and V-bends (3.1.1.3 and 3.1.1.4). In some cases, for U-bend and V-bends it may be necessary for the specimen to bottom out in the female die to ensure the correct amount of bending.

3.6.1 The radii of the plunger and of the two supports shall be defined in the product specification as related to the thickness ( $t$ ) of the specimen being tested. A clearance of three thickness with a tolerance of one half thickness shall be provided between the pins, plunger, and specimen in the initial bend fixture.

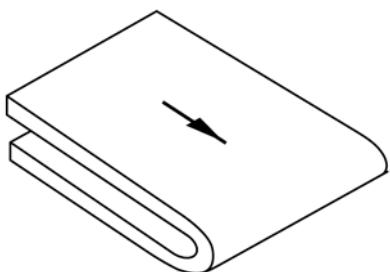

NOTE 1—Arrow indicates direction of processing.  
**FIG. 1 Longitudinal Bend Test**

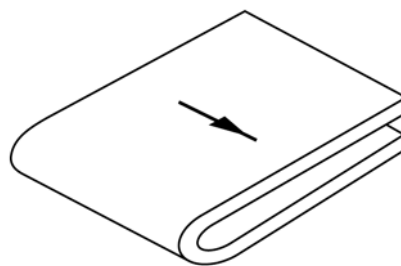

NOTE 1—Arrow indicates direction of processing.  
**FIG. 2 Transverse Bend Test**

3.6.1.1 The distance between supports ( $C$ ) shall be three thicknesses plus twice the plunger radius, with a tolerance of one-half thickness, as shown in Fig. 3.

3.6.1.2 When female dies are used for U-bend and V-bend, they shall conform approximately to the geometries shown in Fig. 4, Fig. 5, and Fig. 6.

3.6.2 The surfaces of the supports and plunger shall be hard enough to resist plastic deformation and wear that can be observed after the test. If visible flattening, wear, or other permanent deformation of the test fixtures does occur, the test is invalid.

NOTE 1—Supports and plungers hardened to at least 20 HRC have been found to be generally suitable for this test. It is recommended that checking by the unaided eye for flattening, wear, or other deformation of the test fixtures take place after testing different and potentially harder materials than usual.

3.6.3 The supports can be fixed or free to rotate. A lubricant may be applied to the supports and plunger.

3.6.4 The width of the guided-bend fixture, including the supports and plunger, shall be such that the bend region of the specimen is subject to the bending force across its width ( $w$ ) during bending.

3.6.5 When the thickness or strength of the specimen, or capacity of the guided-bend test fixture (shown in Fig. 3) does not produce the required amount of bending, the specimen can be removed from the fixture and the bend completed by applying force against the ends of the specimen, as shown schematically in Fig. 7. A spacer with a thickness equal to twice the required bend radius is inserted at the location of the bend. The edges at the ends shall be constrained so the specimen cannot eject from the fixture under the bending force.

3.6.6 Surface cracks and imperfections resulting from the bend shall be evaluated and reported.

3.7 *Semi-guided Bend*—The semi-guided bend test employs a constraining force on the inside of the bend during the initiation of the bending and continuing until the final bend condition is achieved.

3.7.1 The semi-guided bend test is made by applying a force transversely to the specimen's long axis in the portion that is being bent.

3.7.2 The angle of bend in the semi-guided bend test is measured while the specimen is held stationary under the force forming the bend.

3.7.3 The location of the bend along the length of the specimen is unimportant. The specimen is clamped or supported by one of the methods shown schematically in Figs.

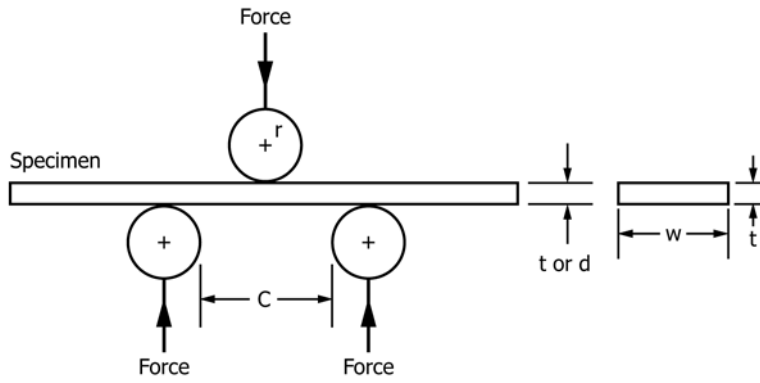

$$C = 2r + 3t \pm t/2$$

NOTE 1— $C$  = distance between lower supports,  
 $r$  = radius of the end of the mandrel or plunger,  
 $t$  = sheet specimen thickness,  
 $d$  = round specimen diameter, and  
 $w$  = sheet specimen width.

FIG. 3 Schematic Fixture for the Guided Bend, No Die Test

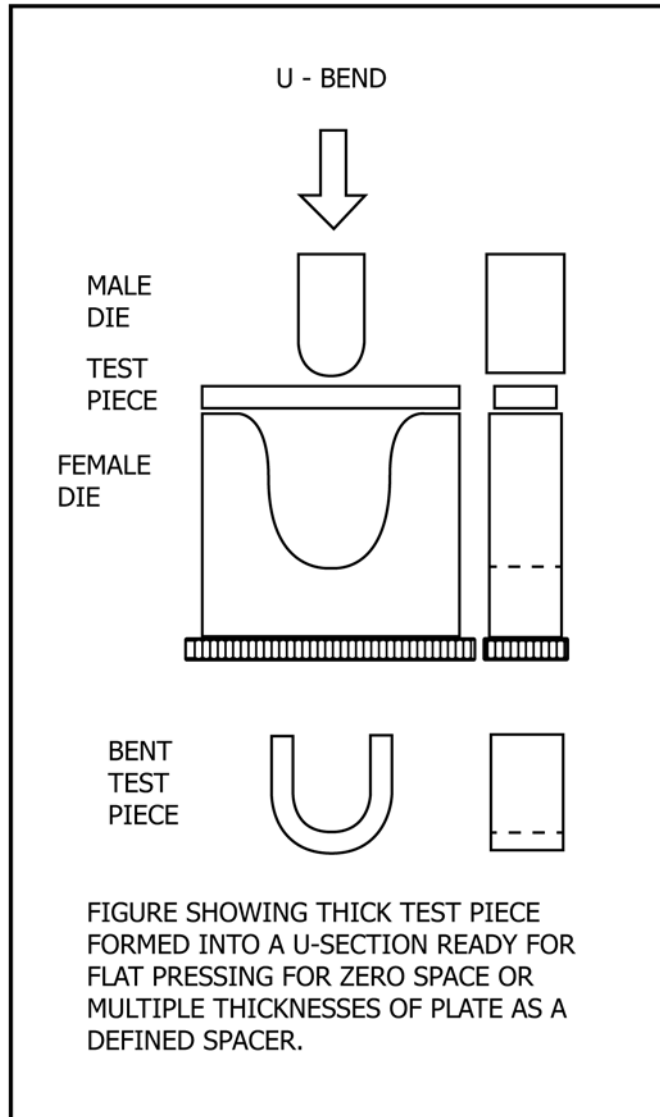

FIG. 4 Schematic Fixture for the Guided Bend, U-bend Test

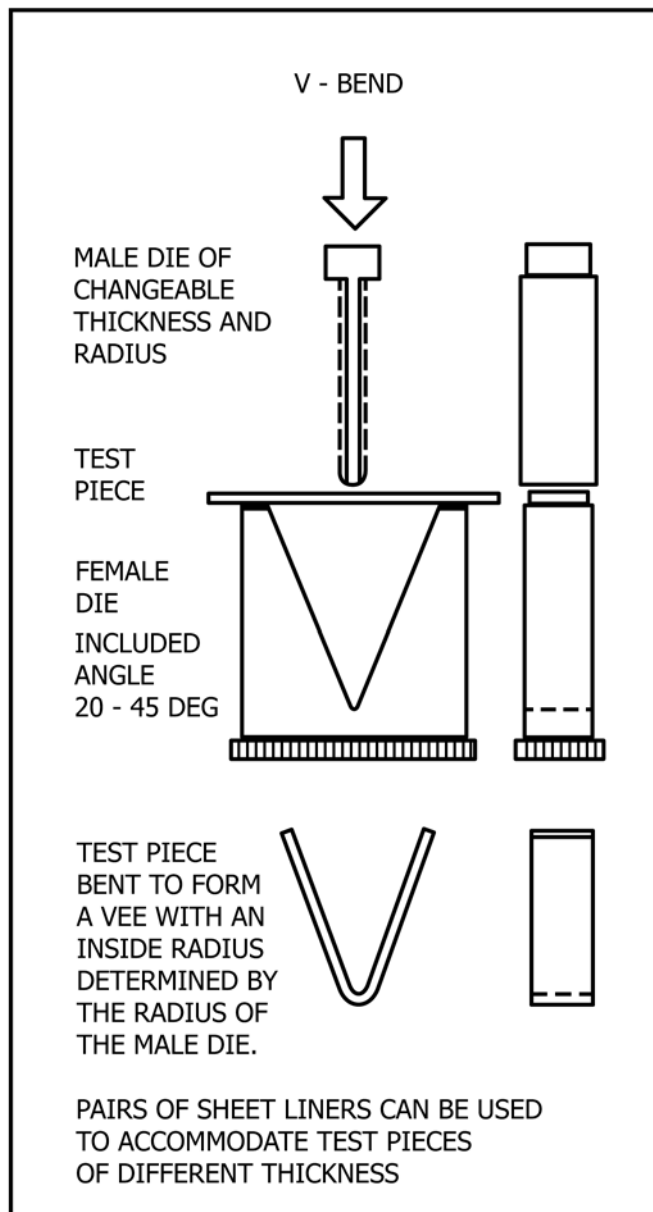

FIG. 5 Schematic Fixture for the Guided Bend, V- Bend Test

8-10. It is possible that different results will be obtained with the use of different devices. The method used shall be described in the test report on the ductility of the material being evaluated.

3.7.4 *Arrangement A—One End Held*—Arrangement A involves holding one end of the semi-guided bend specimen and applying a force transversely near the free end as in Fig. 8. The bend is formed around a stationary pin, mandrel, or roller of a specified radius. Bending is continued until failure occurs or the specified angle of bend has been achieved.

3.7.5 *Arrangement B—Thin Materials*—Arrangement B is for semi-guided bend tests of thin specimens, and includes a support between the clamp and the bend radius, as shown schematically in Fig. 9. No tension force is applied to the

specimen during the bending. The results should be the same for tests using either Arrangement A, or Arrangement B.

3.7.6 *Arrangement C—Mandrel Contact on Outer Surface*—Arrangement C employs a stationary pin, or mandrel, over which the semi-guided bend specimen is bent by the force of a roller, or mandrel, in contact with the outer surface of the bend (as shown schematically in Fig. 10). This may exert a small tension force in the bend. The test is sometimes referred to as a *wrap*, but it is distinct from the *wrap around wire* test described in Method E6.

3.7.7 Surface cracks and irregularities resulting from the bend shall be evaluated and reported.

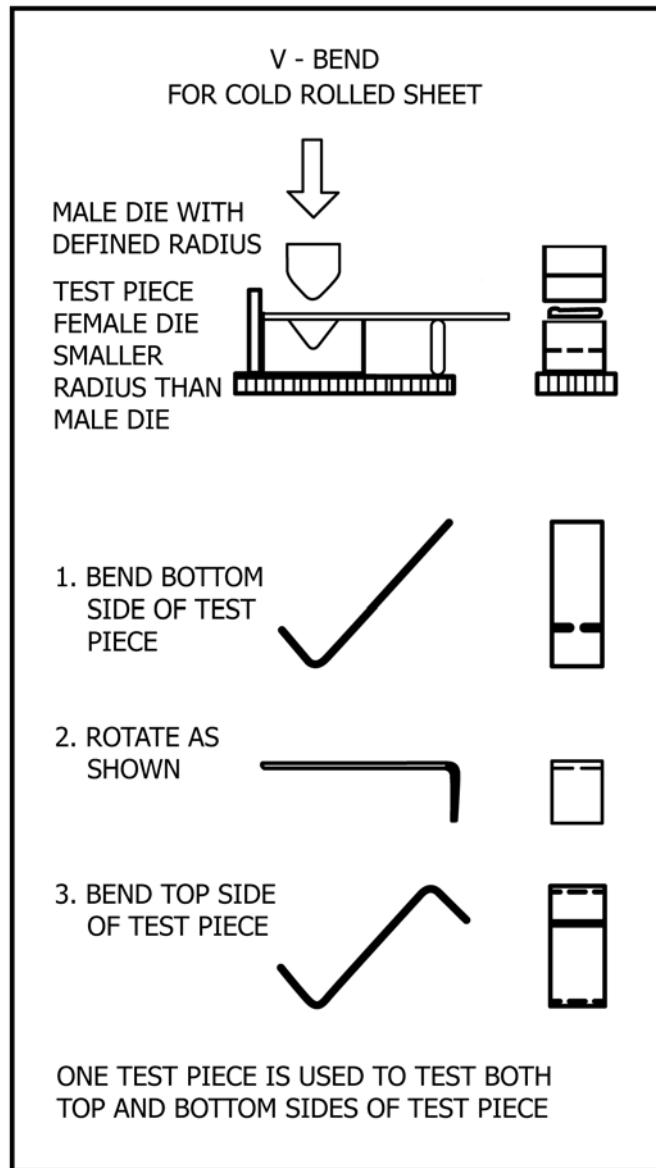

FIG. 6 Schematic Fixture for the Guided Bend, V- Bend Test for Cold Rolled Sheet

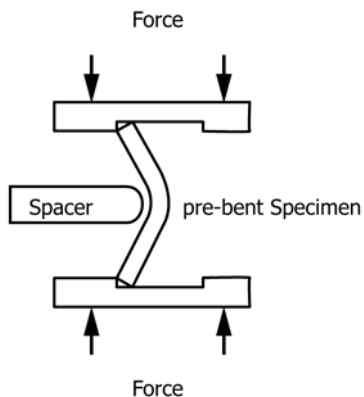

FIG. 7 Schematic Fixture for Completing the Guided-Bend Test Started as Shown in Fig. 3

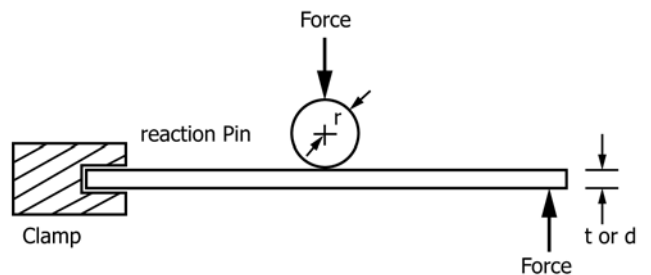

FIG. 8 Schematic Fixture for Semi-Guided Bend Test Arrangement A—One End Held—Force Applied Near Free End

3.8 *Free-Bend*—The free-bend test is made with no external force applied to the specimen in the immediate area of the bend.

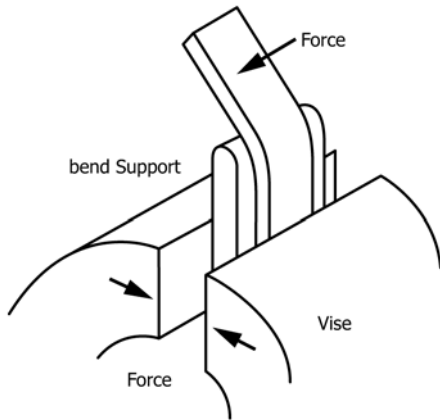

FIG. 9 Arrangement B for Semi-Guided Bend Test of Thin Specimens—One End Held

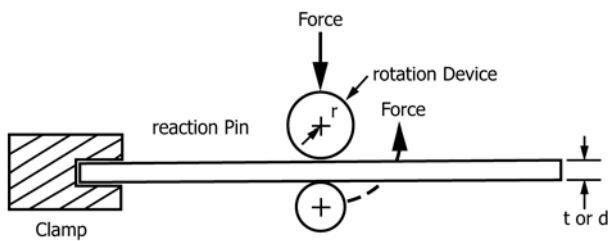

FIG. 10 Schematic Fixture for Semi-Guided Bend Test Arrangement C—One End Held—Force Applied Near Mandrel

3.8.1 The force to initiate bending for a free-bend test shall be applied at, or within one width distance from, the ends of the specimen. This may be done by gripping the specimen. If the material is too stiff to respond to such force it shall be supported at the mid-length (as shown schematically in Fig. 11) over a span of at least the specimen width while the initial force is applied near the two ends of the specimen.

3.8.2 The angle of a free-bend is measured once the specimen has been removed from the bending fixture and is under no constraining force. There is no radius of bend measurement required for a free-bend test.

3.8.3 *Type 1-Free-Bend-180° Bend*—The bending is initiated as described in 3.8.1 and is then continued until a 180° bend is developed by applying force to bring the legs of the specimen to a parallel position (as shown schematically in Fig. 12).

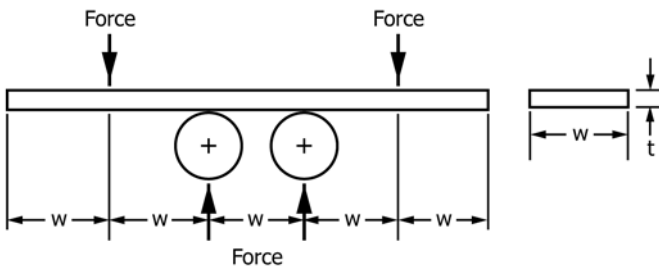

FIG. 11 Free Bend Support and Force

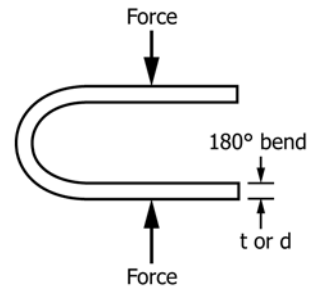

FIG. 12 Type 1 180° Free Bend

3.8.4 *Type 2-Free Bend (Flat on Itself Bend)*—The legs of the specimen are placed under flat platens and compressed to contact no closer than one width of specimen distance from the outer extension of the bend (as shown schematically in Fig. 13).

3.8.5 The bending force is more severe in a Type 2-Free-Bend test than in a Type 1-Free-Bend test. For this reason, the type of bending used shall be described in the report.

3.8.6 Materials that age harden at room temperature shall be tested within the allowed period of time, as defined in the product standard.

3.8.7 After completing the free-bend, the surface is examined for cracks and imperfections.

3.9 *Bend and Flatten*—For the bend and flatten test for ductility, an initial 180° bend is made as described in 3.8.1 and 3.8.3. The specimen is then placed between two parallel platens extending beyond the bent portion of the specimen and wider than the specimen width.

3.9.1 Force is exerted to clamp the specimen and cause the two legs to contact at the bend, exclusive of the eye of the bend (as shown schematically in Fig. 14).

3.9.2 Examination for cracks in the outer surface of the bend is done after removing the specimen from the bending force and allowing springback. The allowed number and size of cracks on the outer surface of the bend shall be as specified in the product standard.

3.9.3 Any surface imperfections resulting from the bend test shall be noted and reported.

#### 4. Significance and Use

4.1 Bend tests for ductility provide a simple way to evaluate the quality of materials by their ability to resist cracking or

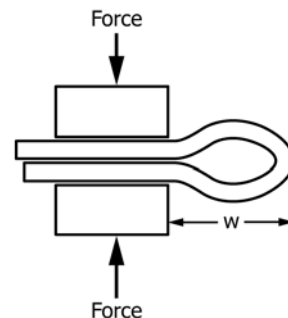

NOTE 1—The distance from the clamping platens to the outer bend shall not be less than the width ( $w$ ) of the bend specimen.

FIG. 13 Type 2 Flat-on-Itself Free Bend

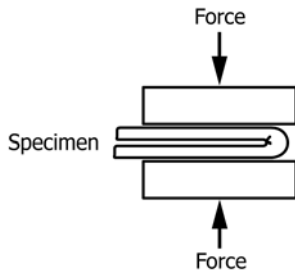

**FIG. 14 Bend and Flatten**

other surface irregularities during one continuous bend. No reversal of the bend force shall be employed when conducting these tests.

4.2 The type of bend test used determines the location of the forces and constraints on the bent portion of the specimen, ranging from no direct contact to continuous contact.

4.3 The test can terminate at a given angle of bend over a specified radius or continue until the specimen legs are in contact. The bend angle can be measured while the specimen is under the bending force (usually when the semi-guided bend test is employed), or after removal of the force as when performing a free-bend test. Product requirements for the material being tested determine the method used.

4.4 Materials with an as-fabricated cross section of rectangular, round, hexagonal, or similar defined shape can be tested in full section to evaluate their bend properties by using the procedures outlined in these test methods, in which case relative width and thickness requirements do not apply.

## 5. Apparatus

5.1 To prevent the introduction of uncontrolled forces while accomplishing the bend, the following clamping and force application devices shall be used.

5.2 *Guided-Bend Test*—The shape of the material during bending is controlled by employing a pair of pins, rollers, or flat surfaces with end radii, to support the specimen while a guided plunger bends the material at its mid-length, as shown schematically in Fig. 3. A more detailed description of a fixture used for this test is given in Method E190.

5.2.1 When the guided-bend test is to be finished by bending through a 180° bend that cannot be achieved using the fixture shown in Fig. 3 or Fig. 4, a fixture shown schematically in Fig. 7 can be used to position the ends of the specimen and prevent it from being ejected while a compression force is applied to bring the legs of the specimen together until they are parallel to each other. A spacer with a thickness equal to twice the required radius is inserted at the bend to stop the force at the specified spacing.

5.3 *Semi-guided Bend Tests*—For a semi-guided bend, the inside of the bend is controlled by contact with a pin or mandrel having a defined radius.

5.3.1 *Semi-guided Bend—Arrangement A*—This arrangement involves holding one end of the specimen while a reaction pin, or mandrel, bears against the specimen at an intermediate location, usually the mid-length. A device (as

shown schematically in Fig. 8) is used to apply the bending force near the free end of the specimen.

5.3.2 *Semi-guided Bend—Arrangement B for thin material*—The specimen is placed against a support with a suitable end radius and clamped in a bench vise, as shown schematically in Fig. 9. This controls the location of the bend away from the clamping force.

5.3.3 *Semi-guided Bend—Arrangement C*—The specimen is held at one end while a reaction pin, or mandrel, contacts the inside surface of the specimen at the location of the bend. A rotating device applies the bending force against the opposite side of the specimen to make it conform to the pin, or mandrel, as shown schematically in Fig. 10.

5.4 *Free Bend Tests*—No bending force is applied directly to the bend area in a free bend test during the final bending. An initial bend can be made using a semi-guided bend device.

5.4.1 A uniaxial force, such as a clamping vise, or a compression testing machine, is used to bend the specimen. A support (as shown in Fig. 11) may be necessary to initiate the bend. No tension loading along the length of the specimen is permitted.

5.5 *Bend and Flatten Test*—The outer surfaces of the legs of the specimen in the flat sections near the bend are subjected to a compressive force during a flattening test.

5.5.1 The test is initiated in the same manner as the free bend. A compressive force is then applied to the bend portion of the specimen. The force shall be sufficient to close the eye of the bend until the two outer surfaces of the bend are parallel, exclusive of the outer radius of the bend (as shown in Fig. 14.)

5.6 The radius of any pin, mandrel, or roller, used in each arrangement of the several bend test methods shall not differ by more than  $\pm 5\%$  of the specified nominal value for the radius.

5.7 The length of all pins, mandrels, rollers, and radiused flats used in bend testing shall exceed the width of the specimen. They shall be strong enough and sufficiently rigid to resist significant deformation.

## 6. Sampling

6.1 Sampling for a bend test shall be performed in accordance with the requirements of relevant standards, specifications, and codes.

## 7. Test Specimens

7.1 Specimens shall be selected from the material to be tested using one of the following procedures:

7.1.1 *Full-Cross-Section Specimens*—If the smallest dimension of the cross-section is equal to or less than 38 mm (1½ in.), the specimen can be of the full thickness provided there is sufficient specimen length to permit bending to the specified angle.

7.1.2 *Full-Thickness Specimens*—Any material that is tested for ductility in the as-fabricated condition may be subjected to a bend test, provided the specimen width and length are sufficient.

7.1.2.1 When it is not practicable to test full-cross-section specimens, but when it is still practicable to test full-thickness specimens from materials not exceeding 38 mm (1½ in.)

nominal thickness, the specimens shall be of the thickness of the material and the ratio of width to thickness shall be either:

(a) 2:1, provided that the minimum width shall be 18 mm ( $\frac{3}{4}$  in.) regardless of thickness.

(b) 8:1, or greater for thin sheet where it is impractical to use specimens of type (a).

7.1.2.2 A width of 38 mm ( $1\frac{1}{2}$  in.) may be used for bend tests of steel products tested in the as-finished thickness.

7.1.2.3 Laboratories using 20 mm wide blanks for preparing tension test specimens may perform the bend test using a similar 20 mm wide specimen. Refer to Test Methods **E8/E8M**. Refer to Test Methods **E8/E8M** for the use of  $-\frac{3}{4}$  in. wide blanks.

7.1.3 The length of the specimen shall be sufficient to permit bending to the specified angle without introducing external constraining forces that would adversely affect the bend test results. The test specimen width-to-thickness ratio can affect bend ductility.

7.1.4 *Machined Surface of Specimens*—For materials exceeding 13 mm ( $\frac{1}{2}$  in.) in nominal thickness, distance across flats, or diameter, the specimen may be machined from the material when full-section, or full-thickness specimens are not used. The thickness, or diameter, of the specimen shall be at least 13 mm ( $\frac{1}{2}$  in.). The ratio of width to thickness of rectangular specimens shall be 2:1, and the length sufficient to permit bending to the angle specified.

7.1.5 When machined specimens must be bent around a stated axis with respect to the major dimensions of the product, the axis of bending shall be suitably marked on the specimen.

7.1.6 When samples are taken by core drilling, a 13mm by 13 mm ( $\frac{1}{2}$  in. by  $\frac{1}{2}$  in.) square cross section specimen may be machined from the core to make a bend test specimen.

7.1.7 One major surface of rectangular specimens of reduced thickness shall be an as-fabricated surface of the section.

7.2 *Surface Finishing of Specimen Edges*—The longitudinal edges of a rectangular specimen may be rounded to a radius not exceeding 1.5 mm ( $\frac{1}{16}$  in.) for specimens equal to or less than 50 mm (2 in.), and rounded to a radius not exceeding 3 mm ( $\frac{1}{8}$  in.) for specimens over 50 mm (2 in.) in thickness. Flame cut surfaces shall be machined to remove metal affected by the flame cutting. Sheared edge surfaces shall be either machined or smoothed with a belt sander, file, or similar abrasive, to remove metal affected by the shearing.

7.3 *Determination of Test Direction for Specimens from Wrought Materials*:

7.3.1 For a longitudinal test specimen, the length shall be parallel to the direction of rolling, forging, stretching, drawing, or extrusion (as indicated in **Fig. 1**). Refer to **3.3.1**.

7.3.2 For a transverse test specimen, the length shall be at an angle of  $90^\circ$  to the direction of rolling, forging, drawing, or extrusion (as indicated in **Fig. 2**). Refer to **3.3.2**.

7.4 *Marking for Identification*:

7.4.1 Specimens shall be stamped or otherwise suitably identified.

7.4.2 The identification shall be near the end of the specimen when practicable.

7.4.3 No stamping or marking shall be done in the bend region of the specimen.

## 8. Procedure

8.1 *Direction of Test*:

8.1.1 In tests of longitudinal specimens, the axis of the bend shall be  $90^\circ$  to the direction of rolling, forging, drawing, or extrusion, as shown in **Fig. 1**. Refer to **3.3.1**.

8.1.2 In tests of transverse specimens, the axis of the bend shall be parallel to the direction of rolling, forging, drawing, or extrusion, as shown in **Fig. 2**. Refer to **3.3.2**.

8.1.3 For round specimens machined from sections other than round sections, the surface of the specimen shall be parallel to the surface of the parent product.

8.2 *Surface Subjected to Tension*—In tests of reduced-thickness specimens, the tension surface shall be the as-fabricated surface of the section.

8.3 *Procedure for the Guided-Bend Test*:

8.3.1 Place the specimen over two rounded supports separated by a clearance ( $C$ ) equal to  $(2r + 3t)$ ,  $\pm (t/2)$ , as shown in **Fig. 3**, where ( $r$ ) is the radius of the plunger or mandrel and ( $t$ ) is the specimen thickness.

8.3.2 Bend the specimen by applying a force through a plunger or mandrel in contact with the specimen at the mid-length between supports ( $C/2$ ) on the opposite side of the specimen from the end supports. Apply the bending force smoothly and without shock.

8.3.3 Continue bending until failure occurs, or until the specified angle of bend, or maximum angle for the fixture is achieved. The angle of bend is measured while the specimen is under the bending force.

8.3.4 When the required angle cannot be achieved in the bend fixture shown in **Fig. 3**, complete the test by pressing the specimen between suitable platens until the specified conditions of bend are obtained, as shown in **Fig. 7**. Apply the force smoothly, without shock. When it is desired not to exceed  $180^\circ$  of bend while completing the bend, place between the two legs of the specimen a spacer having a thickness twice the required bend radius.

8.4 *Procedures for Semi-Guided Bend Tests*:

8.4.1 The procedure for performing the test shall follow one of three methods: A—Held End, B—Bend Area Supported, or C—Mandrel Guided. Refer to **3.7** and **5.3**.

8.4.2 *Held-End—Arrangement A*:

8.4.2.1 Securely hold one end of the specimen so that the axis of bending lies on the centerline of the reaction pin or roller.

8.4.2.2 Bend the specimen by employing a fixture embodying the appropriate features shown in **Fig. 8**.

8.4.2.3 Apply the bending force smoothly, without shock.

8.4.2.4 Continue bending until the specified angle of bend is achieved with the specimen in the bend fixture and under the bending force, or until failure occurs.

8.4.3 *Arrangement B—Bend Area Supported—Thin Material*:



8.4.3.1 Hold one end of the specimen securely against the bend support by clamping in a vise, as shown in Fig. 9. The support shall extend a minimum of two specimen widths beyond the clamp.

8.4.3.2 Using a mallet, hammer the specimen over the rounded edge of the support. Do not strike the specimen in an area that will form any part of the bend.

8.4.3.3 Continue bending until the specified angle of bend is achieved or failure occurs. When hammer blows are the source of the bending force, the angle of bend shall be measured under no force.

8.4.3.4 In case of dispute, the Held-End Arrangement A of 8.4.2 shall be used.

8.4.4 *Mandrel-guided Bend—Arrangement C:*

8.4.4.1 Securely clamp one end of the specimen, as shown schematically in Fig. 10.

8.4.4.2 Place a reaction pin, with the specified bend radius (*r*) against the specimen. If the thickness of the specimen has been reduced by machining, the machined surface is to be placed against the pin. For bend angles of 180° or less, a radiused surface may be substituted for the pin.

8.4.4.3 Hold a second mandrel in contact with the opposite surface of the specimen and rotate this mandrel under force in an arc to maintain the inside of the bend surface against the first mandrel. The radius of the second mandrel is not critical and can be of any convenient size. The second mandrel can employ a roller as the contact surface with the specimen.

8.4.4.4 Continue bending until the material successfully reaches the specified angle or until failure in the bend occurs. The angle of bend is measured while the specimen is under the bending force.

8.5 *Procedures for Free-Bend Tests:*

8.5.1 Initiate the bend by grasping the specimen near each end and bringing the ends toward each other, provided the material is sufficiently ductile. If the material does not bend easily, use a device such as that shown in Fig. 11 to initiate the bend. Refer to 3.8 and 5.4.

8.5.2 *Type 1-Free Bend Test*—Continue bending the specimen under force in a clamping device until the two legs are parallel as shown in Fig. 12. This completes the Type 1, 180°, free bend test.

8.5.3 *Type 2-Free Bend Test*—If the test requirement is that the two legs be in contact, the force of the clamping device is increased until the condition shown in Fig. 13 is reached, without applying force at any location less than one specimen width from the outer end of the bend. This is referred to as a Type 2, flat-on-itself, free bend test.

8.6 *Procedure for the Bend and Flatten Test:*

8.6.1 Form an initial bend to an angle of approximately 180° using the procedure outlined in 8.5.1. Refer to 3.8.1 and 5.4.1.

8.6.2 Place the specimen between two platens that will cover the bent portion of the specimen. Apply force until the specimen is flattened as shown in Fig. 14.

8.6.3 The flattening operation may develop longitudinal strains exceeding the forming limit of the material. This is dependent on the material and the specimen thickness.

8.6.3.1 Bending followed by flattening imposes extreme outer fiber stresses and the material may show external cracking in the bend or there may be compressive failure of the inside surface of the eye of the bend.

8.6.3.2 The outer fiber strain is reduced when the inside of the bend collapses, as shown in Fig. 15, since this reduces the amount of stretching of the outer surface. This may be sufficient to avoid surface cracks on the outer surface of the bend.

8.6.3.3 If the inside of the bend does not collapse, it is possible for excessive strains to develop that cause the outer surface of the bend to crack, as shown in Fig. 16.

8.7 *Examination of the Surface of the Bend*—The bend specimen may be removed at any time during the bending operation for inspection of the convex surface of the bend for the presence of cracks or irregularities. Subsequent bending shall be continued immediately following the examination.

8.8 *Angle of Bend*—The angle of bend is determined by the projection of lines with the flat surfaces of the specimen outside of the bend region and is the intersecting angle of these lines. When the bending is completed, the radius of the bend throughout the bend region, under no force unless specified otherwise, shall not be smaller than the required value specified in the product standard.

8.8.1 Springback, when the bending force is released, will cause the radius and angle of bend to increase. No adjustment in the bend angle shall be made to adjust for springback.

8.8.2 If the material collapses by a localized kink, the test is not valid. An alternative procedure shall be used to control the inside bend radius.

8.8.3 The test is complete when the specified conditions of bend are achieved. If significant cracks appear in the outer surface of the bend while the bending force is being applied, the test shall be stopped and the material shall be evaluated according to the appropriate product standard.

8.8.4 Cracks occurring in the corners of the bent portion shall not be considered significant unless they exceed the size specified for corner cracks. If no crack size is specified, corner cracks not exceeding the nominal thickness of the specimen shall not be considered a failure.

8.8.5 In tests required by produce specifications, the test may be considered completed when the acceptance conditions have been met.

8.9 *Speed of Bending*—The rate of motion in forming a bend shall conform to that of the anticipated process application of

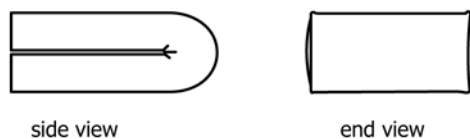

Flattened bend - collapsed eye of the bend

NOTE 1—Bend and flatten bend of material in which the eye of the bend collapsed, relieving strain on the outer surface of the bend during the Bend and Flatten test.

FIG. 15 Bend and Flatten Test (Eye of the Bend Collapsed)



Flattened bend - outer surface and edge cracks

NOTE 1—Bend and flatten bend of material in which the eye of the bend did not collapse, and the outer surface of the bend split open as cracks formed in two places during the Bend and Flatten test.

**FIG. 16 Bend and Flatten Test (Eye of the Bend Did Not Collapse)**

the material being tested. When no rate is specified, the test shall be conducted at a rate consistent with safe practice for the method.

## 9. Evaluation

9.1 Examine the convex surface of the bent specimen for cracks or other open defects, using the unaided eye (without magnification). Edge cracks associated with sample preparation shall not be considered during the evaluation. Refer to 8.8.4.

9.1.1 When the test is conducted as an acceptance criterion, the allowable crack size shall be specified by the code or specification requiring the test.

9.1.2 Material that is susceptible to age hardening shall be tested within the time allowed by the product specification.

9.1.3 Surface irregularities, loss of coating adherence, or other discontinuity developed by the bend test shall be evaluated according to the appropriate product specification.

9.1.4 Surface disturbances, such as orange peel, that develop during a bend test, where there is no penetration of the surface, are not considered a crack failure.

## 10. Report

10.1 Report the following information:

10.1.1 Specimen identification,

10.1.2 Size and type of specimen (Section 7),

10.1.3 Type of test (Section 8),

10.1.4 Radius used to form the bend,

10.1.5 If lubricated, type of lubrication,

10.1.6 Angle of bend,

10.1.7 Number and size of any visible cracks in the bend, and

10.1.7.1 When the test is conducted for informational purposes, report the size and location of any and all cracks visible to the unaided eye.

10.1.8 Whether the specimen passed or failed to meet the requirements.

## 11. Precision and Bias

11.1 No information is presented about either the precision or bias of Test Method E290 for measuring ductility by bending, since the test is non-quantitative.

## 12. Keywords

12.1 bend; crack; ductility; flattened bend; forming limit; fracture; free bend; guided bend; mandrel; pin; plunger; roller

## SUMMARY OF CHANGES

Committee E28 has identified the location of selected changes to this standard since the last issue (E290–13) that may impact the use of this standard.

(1) 3.6.2 was revised.

*ASTM International takes no position respecting the validity of any patent rights asserted in connection with any item mentioned in this standard. Users of this standard are expressly advised that determination of the validity of any such patent rights, and the risk of infringement of such rights, are entirely their own responsibility.*

*This standard is subject to revision at any time by the responsible technical committee and must be reviewed every five years and if not revised, either reapproved or withdrawn. Your comments are invited either for revision of this standard or for additional standards and should be addressed to ASTM International Headquarters. Your comments will receive careful consideration at a meeting of the responsible technical committee, which you may attend. If you feel that your comments have not received a fair hearing you should make your views known to the ASTM Committee on Standards, at the address shown below.*

*This standard is copyrighted by ASTM International, 100 Barr Harbor Drive, PO Box C700, West Conshohocken, PA 19428-2959, United States. Individual reprints (single or multiple copies) of this standard may be obtained by contacting ASTM at the above address or at 610-832-9585 (phone), 610-832-9555 (fax), or service@astm.org (e-mail); or through the ASTM website (www.astm.org). Permission rights to photocopy the standard may also be secured from the Copyright Clearance Center, 222 Rosewood Drive, Danvers, MA 01923, Tel: (978) 646-2600; http://www.copyright.com/*