



Standard Test Method for Conducting Drop-Weight Test to Determine Nil-Ductility Transition Temperature of Ferritic Steels¹

This standard is issued under the fixed designation E208; the number immediately following the designation indicates the year of original adoption or, in the case of revision, the year of last revision. A number in parentheses indicates the year of last reapproval. A superscript epsilon (ϵ) indicates an editorial change since the last revision or reapproval.

This standard has been approved for use by agencies of the U.S. Department of Defense.

INTRODUCTION

This drop-weight test was developed at the Naval Research Laboratory in 1952 and has been used extensively to investigate the conditions required for initiation of brittle fractures in structural steels. Drop-weight test facilities have been established at several Naval activities, research institutions, and industrial organizations in this country and abroad. The method is used for specification purposes by industrial organizations and is referenced in several ASTM specifications and the ASME Boiler and Pressure Vessel Code. This procedure was prepared to ensure that tests conducted at all locations would have a common meaning. This test method was originally published as Department of the Navy document NAVSHIPS-250-634-3.

1. Scope*

1.1 This test method covers the determination of the nil-ductility transition (NDT) temperature of ferritic steels, $\frac{5}{8}$ in. (15.9 mm) and thicker.

1.2 This test method may be used whenever the inquiry, contract, order, or specification states that the steels are subject to fracture toughness requirements as determined by the drop-weight test.

1.3 The values stated in inch-pound units are to be regarded as the standard.

1.4 *This standard does not purport to address all of the safety concerns, if any, associated with its use. It is the responsibility of the user of this standard to establish appropriate safety and health practices and determine the applicability of regulatory limitations prior to use.*

2. Referenced Documents

2.1 *ASTM Adjuncts:*
Drop Weight Machine²

3. Terminology

3.1 *Definitions:*

¹ This test method is under the jurisdiction of the ASTM Committee E28 on Mechanical Testing and is the direct responsibility of Subcommittee E28.07 on Impact Testing.

Current edition approved Nov. 1, 2012. Published December 2012. Originally approved in 1963. Last previous edition approved in 2006 as E208 – 06. DOI: 10.1520/E0208-06R12.

² Detail drawings for the construction of this machine are available from ASTM Headquarters. Order ADJE0208. Original adjunct produced in 2002.

3.1.1 *ferritic*—the word ferritic as used hereafter refers to all α -Fe steels. This includes martensitic, pearlitic, and all other nonaustenitic steels.

3.1.2 *nil-ductility transition (NDT) temperature*— the maximum temperature where a standard drop-weight specimen breaks when tested according to the provisions of this method.

4. Summary of Test Method

4.1 The drop-weight test employs simple beam specimens specially prepared to create a material crack in their tensile surfaces at an early time interval of the test. The test is conducted by subjecting each of a series (generally four to eight) of specimens of a given material to a single impact load at a sequence of selected temperatures to determine the maximum temperature at which a specimen breaks. The impact load is provided by a guided, free-falling weight with an energy of 250 to 1200 ft-lbf (340 to 1630 J) depending on the yield strength of the steel to be tested. The specimens are prevented by a stop from deflecting more than a few tenths of an inch.

4.2 The usual test sequence is as follows: After the preparation and temperature conditioning of the specimen, the initial drop-weight test is conducted at a test temperature estimated to be near the NDT temperature. Depending upon the results of the first test, tests of the other specimens are conducted at suitable temperature intervals to establish the limits within 10°F (5°C) for break and no-break performance. A duplicate test at the lowest no-break temperature of the series is conducted to confirm no-break performance at this temperature.

*A Summary of Changes section appears at the end of this standard

4.3 In 1984, the method of applying the crack-starter weld bead was changed from a two-pass technique to the current single-pass procedure, and the practice of repair-welding of the crack-starter weld bead was prohibited. For steels whose properties are influenced by tempering or are susceptible to temper embrittlement, the nil-ductility transition (NDT) temperature obtained using the single-pass crack-starter weld bead may not agree with that obtained using the previous two-pass crack-starter weld bead, or when the crack-starter bead was repaired.

5. Significance and Use

5.1 The fracture-strength transitions of ferritic steels used in the notched condition are markedly affected by temperature. For a given “low” temperature, the size and acuity of the flaw (notch) determines the stress level required for initiation of brittle fracture. The significance of this test method is related to establishing that temperature, defined herein as the NDT temperature, at which the “small flaw” initiation curve, Fig. 1, falls to nominal yield strength stress levels with decreasing temperature, that is, the point marked NDT in Fig. 1.

5.2 Interpretations to other conditions required for fracture initiation may be made by the use of the generalized flaw-size, stress-temperature diagram shown in Fig. 1. The diagram was derived from a wide variety of tests, both fracture-initiation and fracture-arrest tests, as correlated with the NDT temperature established by the drop-weight test. Validation of the NDT concept has been documented by correlations with numerous service failures encountered in ship, pressure vessel, machinery component, forged, and cast steel applications.

6. Apparatus

6.1 The drop-weight machine is of simple design based on the use of readily available structural steel products.² The principal components of a drop-weight machine are a vertically guided, free-falling weight, and a rigidly supported anvil which provides for the loading of a rectangular plate specimen as a

simple beam under the falling weight. Fig. 2(a) illustrates a typical drop-weight machine built of standard structural shapes.

6.2 A rail, or rails, rigidly held in a vertical position and in a fixed relationship to the base shall be provided to guide the weight. The weight shall be provided with suitable devices which engage the rail, or rails, and ensure that it will drop freely in a single, vertical plane. The weight may be raised by any convenient means. A weight-release mechanism, functioning similarly to that shown in Fig. 2(b), shall be provided to release the weight quickly without affecting its free fall. The weight shall be made in one piece, or if made of several pieces, its construction shall be rigid to ensure that it acts as a unit when it strikes the specimen. The striking tup of the weight shall be a steel cylindrical surface with a radius of 1 in. (25.4 mm) and a minimum hardness of HRC 50 throughout the section. The weight shall be between 50 and 300 lb (22.7 and 136 kg). The rails and hoisting device shall permit raising the weight various fixed distances to obtain potential energies of 250 to 1200 ft-lbf (340 to 1630 J).

6.3 A horizontal base, located under the guide rails, shall be provided to hold and position precisely the several styles of anvils required for the standard specimens. The anvil guides shall position the anvil with the center-line of the deflection stops under the center-line of the striking tup of the weight. In general, the base will also support the guide rails, but this is not a requirement. The base shall rest on the rigid foundation. The base-foundation system shall be sufficiently rigid to allow the normal drop-weight energy (Table 1) to deflect a standard specimen to the stop at temperatures above the NDT. The base shall not jump or shift during the test, and shall be secured to the foundation if necessary to prevent motion.

6.4 A guard screen, similar to that shown in Fig. 2(c), is recommended to stop broken specimen halves of the very brittle steels which break into two pieces with both halves being ejected forcefully from the machine.

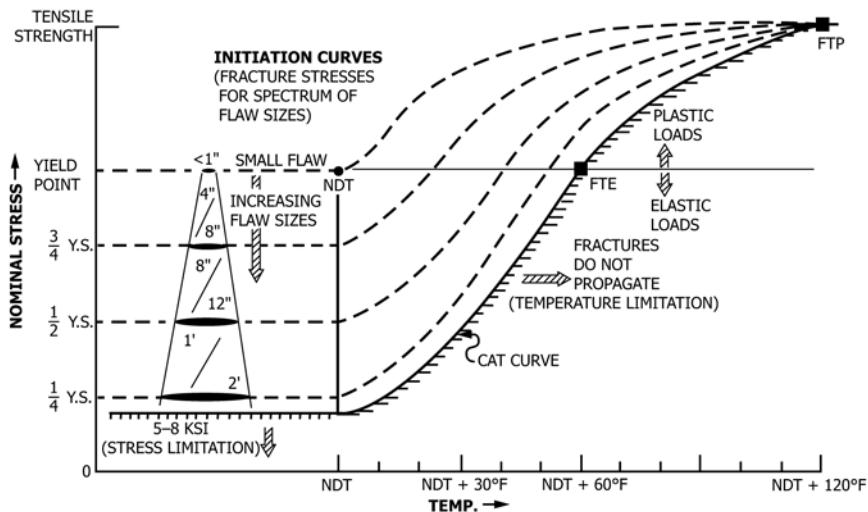
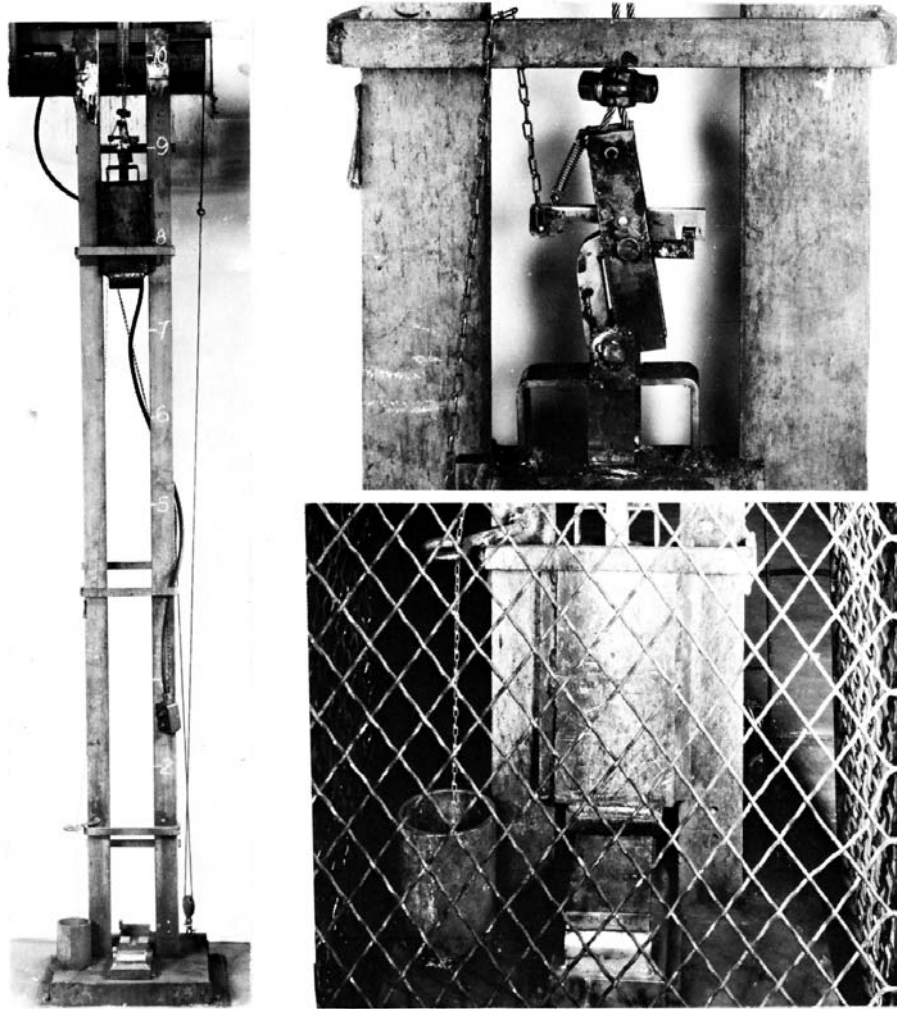

FIG. 1 Generalized Fracture Analysis Diagram Indicating the Approximate Range of Flaw Sizes Required for Fracture Initiation at Various Levels of Nominal Stress, as Referenced by the NDT Temperature^{3, 4}



(a) Left—Complete Assembly
 (b) Upper Right—Quick Release Mechanism
 (c) Lower Right—Guard Screen

FIG. 2 Drop-Weight Test Apparatus

TABLE 1 Standard Drop-Weight Test Conditions

Type of Specimen	Specimen Size, in. (mm)	Span, in. (mm)	Deflection Stop, in. (mm)	Yield Strength Level, ksi (MPa)	Drop-Weight Energy for Given Yield Strength Level ^A	
					ft-lbf	J
P-1	1 by 3½ by 14 (25.4 by 89 by 356)	12.0 (305)	0.3 (7.6)	30 to 50 (210 to 340)	600	800
				50 to 70 (340 to 480)	800	1100
				70 to 90 (480 to 620)	1000	1350
				90 to 110 (620 to 760)	1200	1650
P-2	¾ by 2 by 5 (19 by 51 by 127)	4.0 (102)	0.06 (1.5)	30 to 60 (210 to 410)	250	350
				60 to 90 (410 to 620)	300	400
				90 to 120 (620 to 830)	350	450
				120 to 150 (830 to 1030)	400	550
P-3	⅝ by 2 by 5 (15.9 by 51 by 127)	4.0 (102)	0.075 (1.9)	30 to 60 (210 to 410)	250	350
				60 to 90 (410 to 620)	300	400
				90 to 120 (620 to 830)	350	450
				120 to 150 (830 to 1030)	400	550

^A Initial tests of a given strength level steel shall be conducted with the drop-weight energy stated in this column. In the event that insufficient deflection is developed (no-test performance) an increased drop-weight energy shall be employed for other specimens of the given steel.

6.5 The general characteristics of two of the anvils required are illustrated in Fig. 3. The anvils shall be made in accordance with the dimensions shown in Fig. 4. The anvil supports and deflection stops shall be steel-hardened to a minimum hardness of HRC 50 throughout their cross section. The space between the two stops is provided as clearance for the crack-starter weld on the specimen. The deflection stops may be made in two separate pieces, if desired. The anvil-base system shall be sufficiently rigid to allow the normal drop-weight energy (Table 1) to deflect the specimen to the stop at temperatures well above the NDT.

6.6 A measuring system shall be provided to assure that the weight is released from the desired height for each test, within the limits of +10, –0 %.

6.7 Modifications of the equipment or assembly details of the drop-weight machine shown in Fig. 2 are permitted provided that the modified machine is functionally equivalent. Fig. 5 illustrates a portable machine design used by an industrial concern for drop-weight tests of materials used for pressure vessel components at different fabrication sites.

7. Precautions

7.1 The drop-weight test was devised for measuring fracture initiation characteristics of 5/8-in. (15.9-mm) and thicker structural materials. This test is not recommended for steels less than 5/8-in. thick.

7.2 This test method establishes standard specimens and conditions to determine the NDT temperature of a given steel. The use of standard specimens with nonstandard test condi-

tions or the use of nonstandard specimens shall not be allowed for specification purposes.

7.3 This test method employs a small weld bead deposited on the specimen surface, whose sole purpose is to provide a brittle material for the initiation of a small, cleavage crack-flaw in the specimen base material during the test. Anomalous behavior may be expected for materials where the heat-affected zone created by deposition of the crack-starter weld is made more fracture resistant than the unaffected plate. This condition is developed for quenched and tempered steels of high hardness obtained by tempering at low temperatures. The problem may be avoided by placing the crack-starter weld on these steels before conducting the quenching and tempering heat treatment. Except for other cases which may be readily rationalized in metallurgical terms (for example, it is possible to recrystallize heavily cold-worked steels in the heat-affected zone and to develop a region of improved ductility), the heat-affected zone problem is not encountered with conventional structural grade steels of a pearlitic microstructure or quenched and tempered steels tempered at high temperatures to develop maximum fracture toughness.

8. Test Specimens

8.1 *Identification of Material*—All sample material and specimens removed from a given plate, shape, forging, or casting product shall be marked to identify their particular source (heat number, slab number, etc.). A simple identification system shall be used which can be employed in conjunction with an itemized table to obtain all the pertinent information.

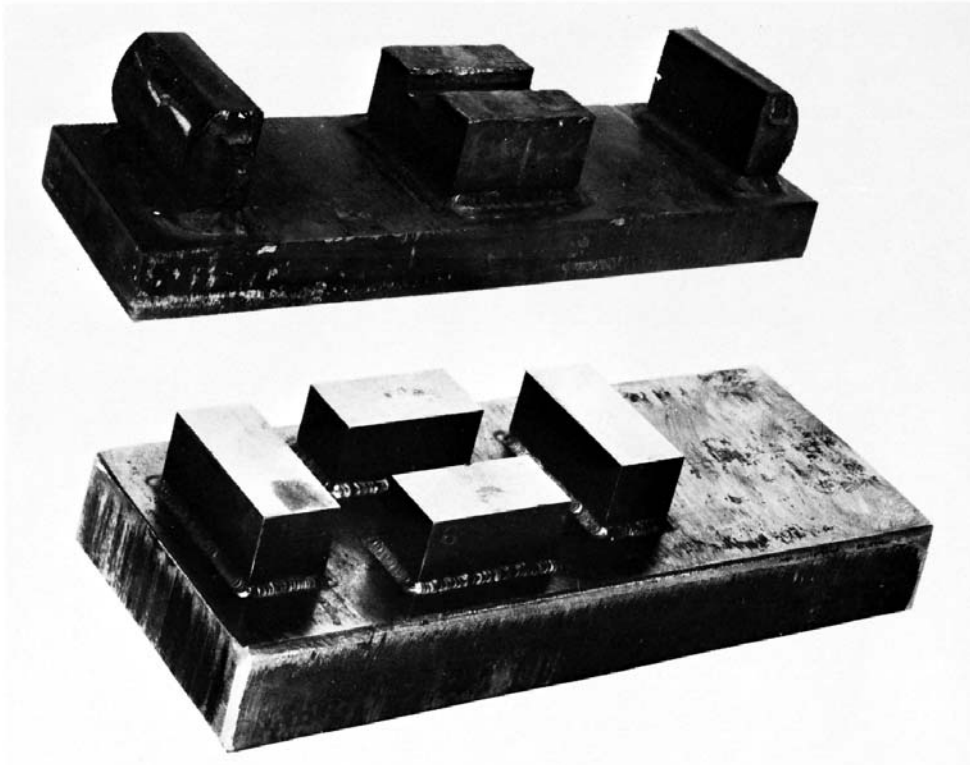
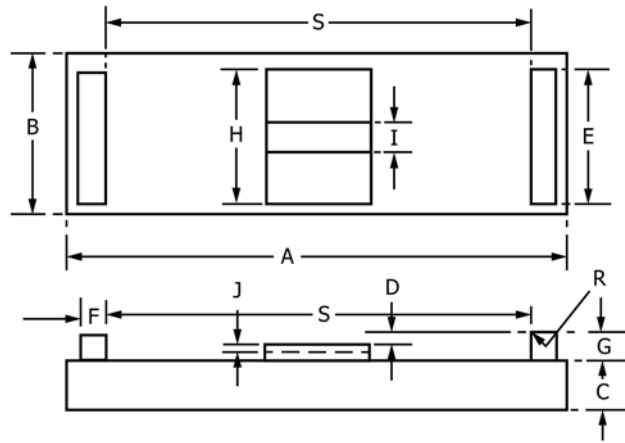

FIG. 3 General Appearance of the Anvils Required for Drop-Weight NDT Tests



Anvil Dimension	Units	Specimen Type			Tolerance
		P-1	P-2	P-3	
S, Span	in.	12.0	4.0	4.0	±0.05
	mm	305	100	100	±1.5
D, Deflection stop	in.	0.30	0.060	0.075	±0.002
	mm	7.60	1.50	1.90	±0.05
A, Anvil length	← not critical →				
B, Anvil width	← not critical →				
C, Anvil thickness	in.	1.5 min	1.5 min	1.5 min	
	mm	38 min	38 min	38 min	
E, Support length	in.	3.5 min	2.0 min	2.0 min	
	mm	90 min	50 min	50 min	
F, Support width	← not less than G →				
G, Support height	in.	2.0	2.0	2.0	±1
	mm	50	50	50	±25
R, Support radius	in.	0.075	0.075	0.075	±0.025
	mm	1.0	1.0	1.0	±0.1
H, Stop width	in.	3.5 min	2.0 min	2.0 min	±2
	mm	90 min	50 min	50 min	±50
I, Weld clearance	in.	0.9	0.9	0.9	±0.1
	mm	22	22	22	±3
J, Weld clearance depth	in.	0.4 min	0.4 min	0.4 min	
	mm	10 min	10 min	10 min	

FIG. 4 Anvil Dimensions

8.2 *Orientation*—The drop-weight test is insensitive to specimen orientation with respect to rolling or forging direction. However, unless otherwise agreed to, all specimens specified by the purchaser shall be of the same orientation and it shall be noted in the test report.

8.3 *Relation to Other Specimens*—Unless otherwise specified by the purchaser, the specimens shall be removed from the material at positions adjacent to the location of other type test specimens (for example, mechanical test specimens) required for evaluation of other material properties.

8.4 *Special Conditions for Forgings and Castings*—Where drop-weight testing of cast or forged material is specified, the size and location of integrally attached pad projections or prolongations to be used for specimen fabrication shall be agreed to in advance by the purchaser. If the design of the casting or forging does not allow an attached test-material coupon, the following requirements shall apply:

8.4.1 Drop-weight specimens cast or forged separately to the dimensions required for testing shall be allowed only where the product dimensions are equivalent and the purchaser agrees.

8.4.2 Specimens may be taken from a separately produced test-material coupon if the supplier can demonstrate that it is equivalent to the product with respect to chemical composition, soundness, and metallurgical conditions. The material shall be from the same heat and shall have been fabricated under identical conditions as the product. The specimens shall be machine-cut from locations agreed to in advance by the purchaser.

8.4.3 Specifically, in the case of casting requiring X-ray quality standard, the separate test-material coupon shall be cast separately but simultaneously with the product. Chills shall not be used. The test-material coupon shall be in proportion to the thickness, T , in the cast product, where T is diameter of the

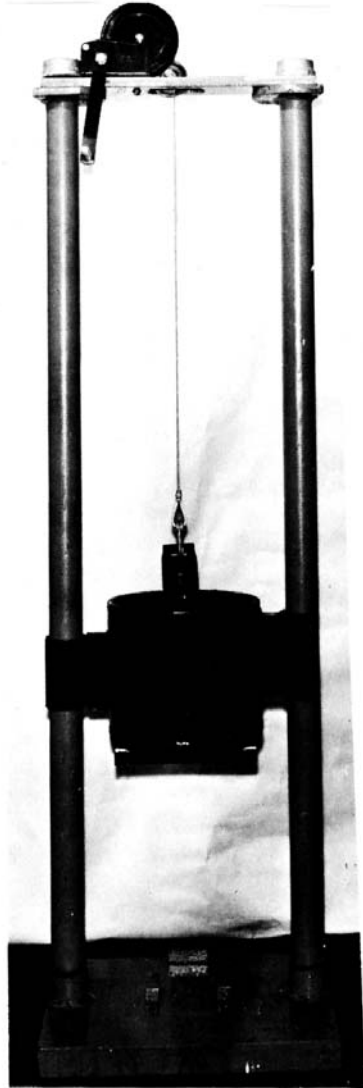

FIG. 5 Portable Drop-Weight Test Machine Used for Tests at Different Fabrication Sites

NDT temperatures, within $\pm 10^{\circ}\text{F}$ ($\pm 5^{\circ}\text{C}$), are determined for a given steel with tests using any of the standard specimens. As may be convenient for the particular thickness of material, any of the standard specimens shown in Fig. 6 and prepared as described in Section 8 may be chosen for this method. The results obtained with standard test conditions shall comply with the requirements of this method for determining the NDT temperature.

8.6 *Specimen Cutting*—The specimen sample material and the specimen ends may be flame-cut. The specimen sides shall be saw-cut or machined, using adequate coolant to prevent specimen overheating, and shall be a minimum of 1 in. from any flame-cut surface. Products thicker than the standard specimen thickness shall be machine-cut to standard thickness from one side, preserving an as-fabricated surface unless otherwise specified, or agreed to, in advance by the purchaser. The as-fabricated surface so preserved shall be the welded (tension) surface of the specimen during testing.

8.7 *Crack-Starter Weld*—The crack-starter weld, which is a centrally located weld bead, approximately 2 in. (50 mm) long (WL of Fig. 6) and $\frac{1}{2}$ in. (12.7 mm) wide, shall be deposited on the as-fabricated tension surface of the drop-weight specimen in a single pass. To assist the welding operator in centering the weld deposit properly on the test piece, two punch marks spaced to the appropriate WL dimension of Fig. 6 shall be positioned as A and D as shown in Fig. 7(a). As an alternative to the punch marks, a copper template containing a centrally positioned slot, 1 in by WL + $\frac{1}{2}$ in. (25 mm by WL + 13 mm) Fig. 7(b), may be used. See Note 1 and Fig. 7(b). The weld shall start from either Point A or D and shall proceed without interruption as a stringer bead (no weaving) to the other point. The bead appearance is determined by the amperage, arc voltage, and speed of travel used. A current of 180 to 200 A, a medium arc length, and a travel speed that will result in a moderately high-crowned bead have been found to be suitable conditions. An enlarged view of an as-deposited crack-starter weld is shown in Fig. 7(c). “Each lot of electrodes shall be checked by the user in accordance with the requirements of 8.10 for suitability with the material the user is testing. Providing a heat sink under P-2 and P-3 specimens during welding is recommended but not required in order to minimize microstructural changes to these smaller specimens. Both metallic and water-box heat sinks have been used for this purpose.

NOTE 1—The copper template is especially recommended for the Type P-2 and P-3 specimens since in addition to heat sink advantages it eliminates weld spatter which may interfere with proper seating of the specimen during test.

8.7.1 *Microstructure of Base Metal*—Data presented show that the method of depositing the weld bead can influence the microstructure of the heat-affected zone under the weld notch which in turn can influence the NDT determined especially in heat-treated steels.⁵

8.8 *Weld Notch*—The final preparation of the specimen consists of notching the deposited weld at the center of the

⁵ Tsukada, H., Suzuki, I. I., and Tanaka, Y., “A Study on Drop-Weight Test Using A508 Class 2 Steel,” *Japan Steel Works, Ltd.*, December 1, 1981.

largest circle that can be inscribed in any cross section of the casting, or where T is defined in advance by the purchaser as the nominal design thickness, as follows:

Thickness, T , in. (mm)	Separately Cast, Nonchilled, Test-Coupon Size
$\frac{1}{2}$ (12.7) and less	None required
$\frac{5}{8}$ to 2 (15.9 to 50.8)	When several small castings are poured from one heat, one casting shall be used to provide test specimens, if adaptable
$\frac{5}{8}$ to 1 (15.9 to 25.4)	T by 2 by 5 in. (127 mm) for irregularly shaped castings
>1 to 3 (25.4 to 76.2)	T by 4.5 T by 4.5 T
>3 to 5 (76.2 to 127)	T by 3 T by 3 T
Over 5 (127)	T by 3 T by 3 T for castings that are representative of cast plates
Over 5 (127)	T by T by $6\sqrt{T}$ for castings that are representative of cast plates

8.4.4 Specimens showing casting or metallurgical faults on broken fracture surfaces shall be “No-Test.”

8.5 *Size of Blank*—Dimensions of the blank size required for standard test specimens are shown in Fig. 6. Equally significant

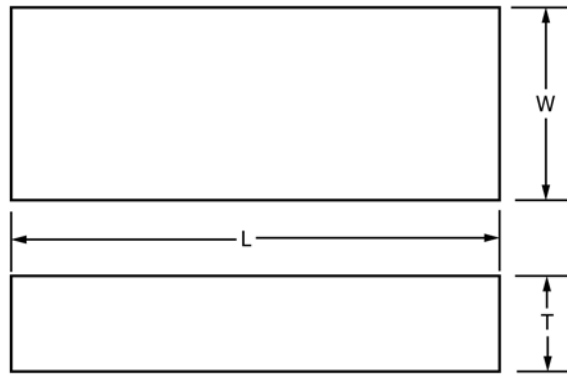

Dimension	Units	Specimen Type					
		P-1		P-2		P-3	
		Dimension	Tolerance	Dimension	Tolerance	Dimension	Tolerance
T, Thickness	in.	1.0	±0.12	0.75	±0.04	0.62	±0.02
	mm	25	±2.5	19	±1.0	16	±0.5
L, Length	in.	14.0	±0.5	5.0	±0.5	5.0	±0.5
	mm	360	±10	130	±10	130	±10
W, Width	in.	3.5	±0.1	2.0	±0.04	2.0	±0.04
	mm	90	±2.0	50	±1.0	50	±1.0
WL, Weld length	in.	2.5	±1	1.75	±1.0	1.75	±1.0
	mm	63.5	±25	44.5	±25	44.5	±25.0

NOTE 1—The length of the weld bead is not critical, provided that the crack-starter notch is at the center of specimen and that the weld bead does not contact the support fixture when the specimen is fully deflected.

FIG. 6 Standard Drop-Weight Specimen Dimensions

bead length. Care shall be taken to ensure that only the weld deposit is notched and that the cutting tools do not contact the specimen surface. The notch may be cut with thin abrasive disks, as shown in Fig. 8, or other convenient cutting tools such as mechanical saws, hack saws, etc., or electrical discharge machining. The weld-notch details and a representative example of a notched weld are given in Fig. 9.

8.9 *Measuring Weld-Notch Depth*—The depth of the notch from the crown of the weld will vary with expected variations in weld-crown dimensions. The depth of the notch is not measured, since it is the thickness of the weld remaining above the specimen and under the bottom of the notch that has been standardized, as shown in Fig. 9. This weld thickness above the specimen shall be maintained across as much of the weld width as permitted by the bead contour. Fig. 10 illustrates an optional device for measuring the thickness of weld metal at the bottom of the notch. The adjustable dial indicator with bridge-support is set at zero while in position on the specimen with the indicator tip contacting the specimen surface immediately adjacent to the notch. The bridge is then placed over the weld with the indicator tip resting on the bottom of the notch to measure the weld metal thickness directly. After the operator has gained experience in the preparation of a few specimens, the instrument need be used only in the final checking of the finished notch.

8.10 *Other Crack-Starter Welds*—The satisfactory completion of drop-weight tests is dependent upon the “crack-starting” conditions developed by the notched weld. As shown schematically in Fig. 11, the specimen deflection, D_C , that cracks the weld, is significantly less than the allowable anvil stop deflection, D_A , for all standard thickness, T , specimens tested on the proper span, S . The carefully prepared and specially

handled electrode (described in 8.7) has been proved successful for crack-starting purposes for all temperatures up to approximately 400°F (200°C). Other weld materials shall be considered to perform satisfactorily as crack-starters if they also develop cleavage cracks at suitably high test temperatures at or near the instant that yielding occurs in the surface fibers of the test specimen. Weld materials, other than those described in 8.7, may be used for the crack-starter bead provided the following requirements are met:

8.10.1 Using standard conditions as specified in Table 1, three standard Type P-2 specimens ($\frac{3}{4}$ by 2 by 5 in.) (19 by 51 by 127 mm) shall be drop-weight tested at a temperature 100°F (55°C) or more above the NDT temperatures of the plate material.

8.10.2 If the three tests demonstrate that the weld notch is always cracked upon deflection of the specimen tension surface to the maximum amount permitted by the proper anvil stop, the other crack-starter weld shall be authorized and considered to conform to the requirements of this method.

8.10.3 Welding procedures or crack-starter weld dimensions other than those described in 8.7 shall be considered to perform satisfactorily as crack-starters if they are demonstrated to develop cleavage cracks at suitably high test temperatures at or near the instant that yielding occurs in the surface fibers of the test specimens. For example, a $\frac{3}{4}$ to 1-in. long crack-starter weld deposited in one direction only with the welding conditions and the electrodes described in 8.7 has been used successfully as a crack-starter weld for the Type P-3 specimen. The shorter weld reduces to total heat input into the specimen and is considered less likely to cause metallurgical changes in the specimen base materials of the low-alloy, high-tensile strength pressure vessel steels. For the Type P-1 specimen, the



(a) Punch Marks

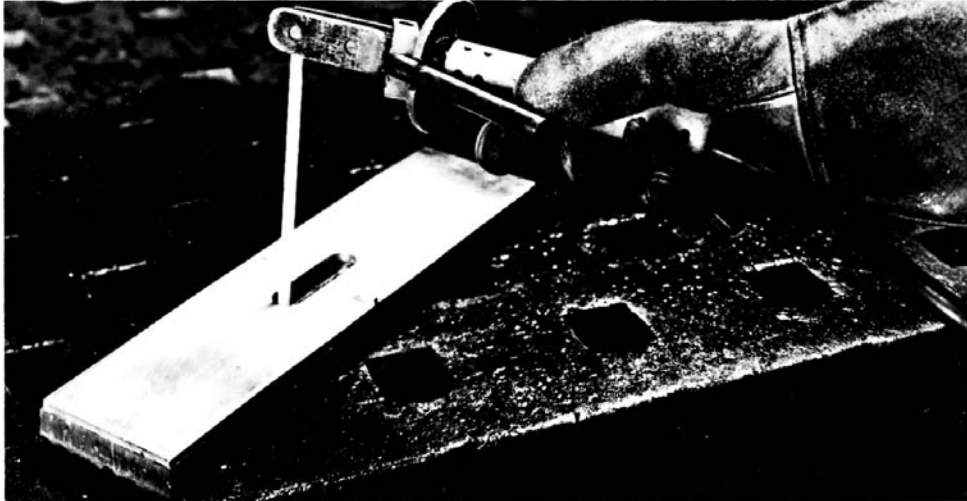

(b) Copper Template

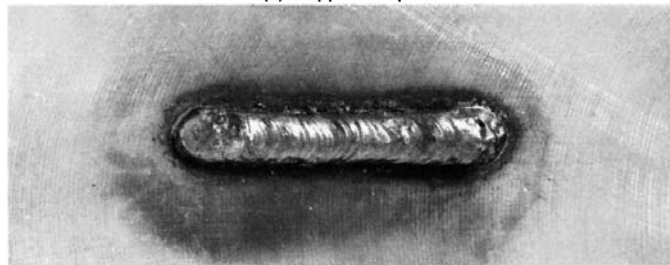

(c) Crack-Starter Weld

FIG. 7 Methods of Locating the Weld Deposit Properly on the Test Specimen



NOTE 1—The weld shown does not comply with the current procedure which specifies that the weld shall start from either end and shall proceed without interruption.

FIG. 8 Notching of Crack-Starter Weld Deposit

shorter weld does not provide the reproducibility or consistency for crack-starting purposes obtained with the standard

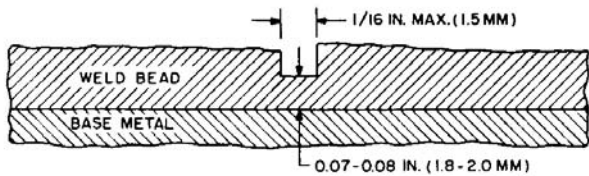
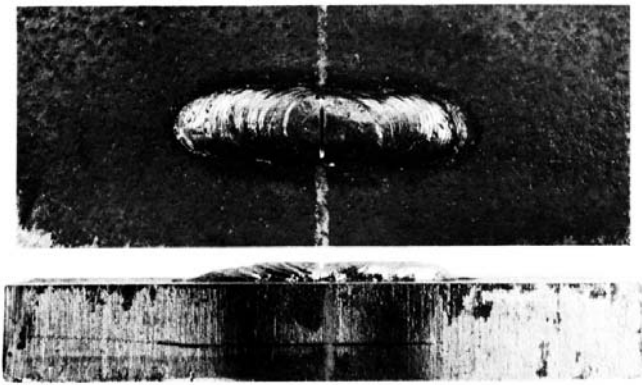

FIG. 9 Weld-Notch Details and Example of a Notched Weld

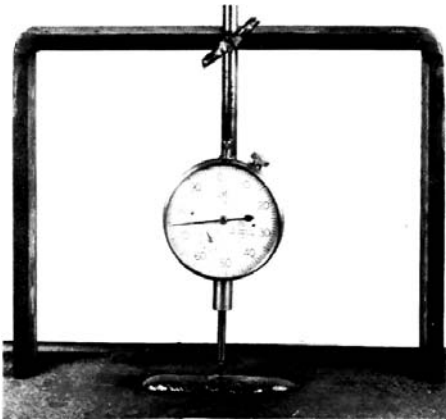

FIG. 10 Method for Measuring Weld Metal Thickness at the Bottom of the Notch

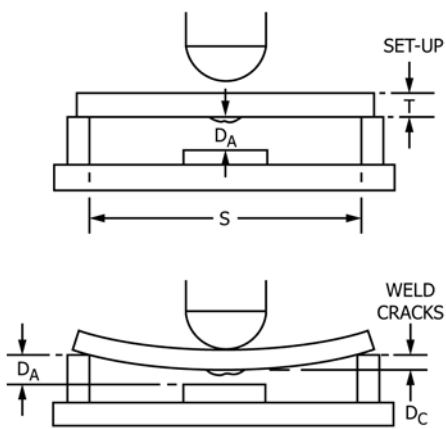

FIG. 11 Drop-Weight Test Method

may be used as the crack-starter bead for a given standard type (P-1, P-2, or P-3) specimen provided that three specimens are tested in accordance with 8.10.1 and results obtained in accordance with 8.10.2.

9. Procedure—General

9.1 Some care and thought are necessary to make a successful drop-weight determination of the NDT temperature. Adequate auxiliary equipment and a definite procedure will aid in making the test. The following sections will define in detail and in orderly fashion the equipment and procedure requirements:

9.2 Conduct the test by placing a specimen in a heating or cooling device until it is at the desired temperature. Then place it with minimum loss of time (see 13.4) on the anvil and align where it will be struck squarely by the weight. Allow the weight to drop from a known preselected height on the specimen. Examine the specimen after the strike to determine its condition as defined by the requirements of this method. Repeat this process until the NDT temperature has been determined.

9.3 The number of specimens required to determine the NDT temperature is a function of the experience of the operator with the material and of the use of an adequate procedure. A skilled operator working with known material can determine the NDT temperature with as few as three specimens. Generally, six to eight specimens are required.

10. Specimen—Anvil Alignment

10.1 *Anvil Requirements*—Test each type of drop-weight specimen only on the anvil designated for that type specimen in accordance with Table 1.

10.2 *Specimen-Anvil Alignment*—In order to obtain a valid test properly align the specimen on the anvil. Align the specimen, anvil, and weigh so the specimen is struck under the following conditions:

10.2.1 The specimen shall be horizontal and the ends shall rest on the anvil supports.

10.2.2 The striking tip of the weight shall strike within ± 0.1 in. (± 2.5 mm) of a line on the compression side of the specimen, normal to a long edge and directly opposite the notch in the crack-starter weld.

10.2.3 No part of the crack-starter weld will touch the deflection stops at any time during the test.

10.2.4 The specimen sides and ends shall be free from any interference during the test.

10.3 *Alignment Tool*—The **optional** technique shown in Fig. 12 has been used successfully to achieve longitudinal and angular specimen alignment of the specimen. Draw a wax-pencil line on the compression surface of the specimen normal to a long edge and directly opposite the notch. Place the specimen on the anvil so this line coincides with the edge of a removable guide bar. Place the bar against the machine rails so that its edge defines the striking line of the tip on the weight.

11. Selection of Test Energy

11.1 Strike the specimen by a free-falling weight having adequate energy to deflect the specimen sufficiently to crack

crack-starter weld described in 8.7. Other welding procedures or crack-starter weld dimensions than those described in 8.7

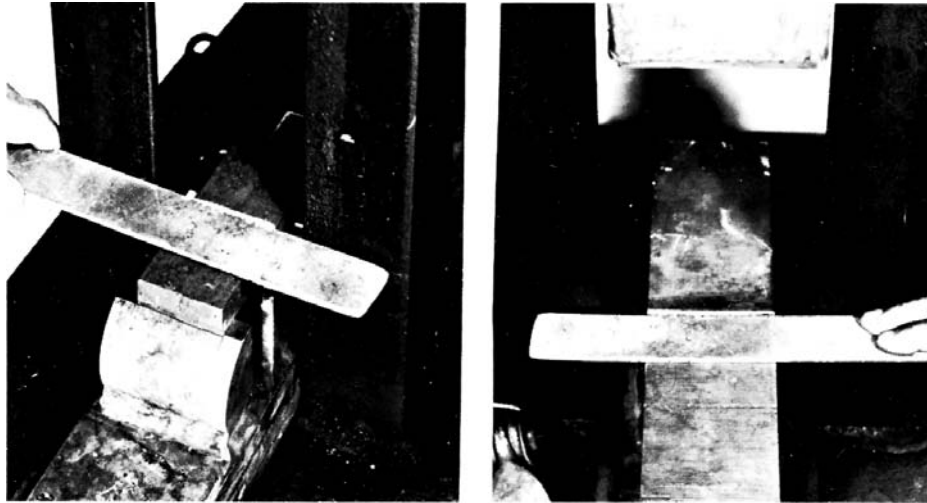

FIG. 12 Method for Alignment of Specimen

the weld deposit and to make the tension surface contact the anvil stop. The design of the machine permits the use of various impact energies to accommodate the different strength levels of the various materials tested. The standard test conditions shown in Table 1 have been developed by experience and shall be used for the test series of a given steel unless “No-Test” performance is experienced. The indicated energies can be obtained by lifting the weight the required distance from the compression surface of the specimen.

11.2 Proper contact of the tension surface of the specimen with the deflection stop may be defined as follows: Scribe a wax-pencil line on the tension surface of a standard specimen parallel to and in line with the mechanical notch cut in the crack-starter weld deposit, Fig. 13(a). Apply clean masking tape, or a similar material, to the top surface of the anvil deflection stop blocks, Fig. 13(b). Align the test specimen on

the anvil and strike once by the weight with the standard conditions, Table 1, for the steel involved. Transfer of the wax-pencil line from specimen to the tape or visible evidence of specimen contact with the tape shall indicate that the specimen was bent sufficiently (Fig. 13(c)). The above procedure, to ensure proper contact of the tension surface of the specimen with the deflection stop blocks, is considered a “built-in” standardization feature of the test method, and it shall be employed for each drop-weight test to preclude “No-Test” performance as described in 14.2.3 and 14.3.

11.3 If the weld crack and anvil stop contact criteria are not met by the Table 1 energies, increase the drop-weight energy in 100-ft-lb increments for the Type P-1 specimens or 50-ft-lb (68-J) increments for the Type P-2 and P-3 specimens until they are met. Do not use drop-weight energies above those

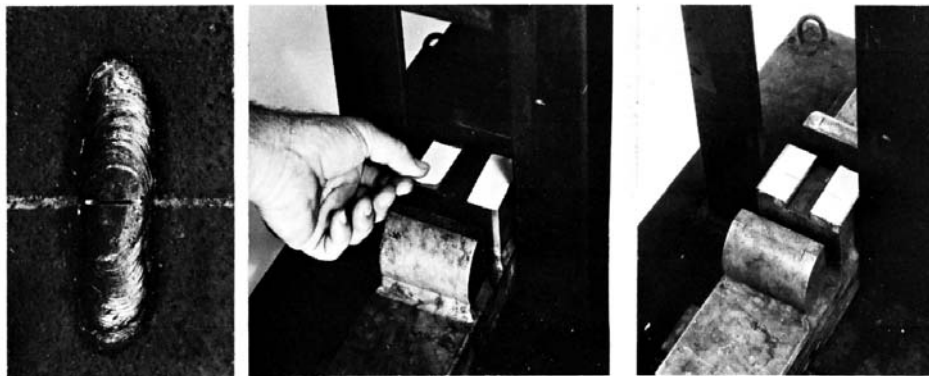

(a)

(b)

(c)

- (a) Wax Pencil Line Scribed on Tension Side of a Specimen
- (b) Application of Masking Tape to Anvil Stop Surfaces
- (c) Transfer of Wax Lines to the Tape When the Specimen Hits the Stop

FIG. 13 Method Employed to Indicate Contact of the Specimen with the Anvil Stop

posted on the table unless the above procedure has been followed to determine the excess energy requirements.

12. Selection of Test Temperatures

12.1 The selection of test temperatures is based on finding, with as few specimens as possible, a lower temperature where the specimen breaks and an upper temperature where it does not break, and then testing at intervals between these temperatures until the temperature limits for break and no-break performance are determined within 10°F (5°C). The NDT temperature is the highest temperature where a specimen breaks when the test is conducted by this procedure. Test at least two specimens that show no-break performance at a temperature 10°F (5°C) above the temperature judged to be the NDT point.

12.2 Conduct the initial test at a temperature estimated to be near the NDT. This temperature and all subsequent test temperatures shall be integral multiples of 10°F or 5°C. Additional tests can be conducted at temperatures based on the experience of the operator or on those suggested in [Table 2](#).

13. Measurement of Specimen Temperatures

13.1 The entire test specimen shall be at a known and uniform temperature during the test. It shall be assumed that if it is fully immersed in a stirred-liquid, constant temperature bath of known temperature and separated from an adjacent specimen by a minimum of 1 in. (25.4 mm) all around for a period of at least 45 min prior to the test, the specimen temperature shall be the same as the bath temperature. If a gas heat-transfer medium is used, increase the required minimum holding time to 60 min. If it can be shown by appropriate test techniques, such as using a thermocouple buried in the center of a dummy test specimen, that specimen equilibrium temperatures can be developed in a shorter period, the tester can reduce the specimen-holding period provided that he has prior approval of the purchaser. The constant-temperature baths or ovens may be of any type that will heat or cool the specimens to a known and uniform temperature.

13.2 Measure the bath temperature by a device with calibration known to $\pm 2^\circ\text{F}$ or $\pm 1^\circ\text{C}$.

13.3 Any convenient means may be used to remove the specimen from the temperature bath and transfer it to the test machine provided it shall not affect the specimen temperature control. Tongs, if used, shall be kept in the temperature bath to maintain a temperature equivalent to the specimen tempera-

ture. Rubber-gloved hands, in general, are the most convenient handling tool. The specimen shall be handled away from the fracture area.

13.4 If more than 20 s elapse in the period of removing the specimen from the bath prior to release of the weight, temperature control shall presume to have been lost and the specimen shall be returned to the bath.

13.5 Considerable experience has been accumulated with baths of the following type, and it is described here for the convenience and **option** of the tester. A deep, insulated metal container holding from ½ to 10 gal (1.9 to 38 L) of a suitable heat-transfer liquid, such as alcohol, will maintain a given temperature for the required specimen-holding period with minor manual adjustments. By immersing an open basket of cracked dry ice or a high-wattage electrical heat in the bath, its temperature can be adjusted slightly or can be lowered or raised to a new constant level in a short period. For low-density heat-transfer liquids, a walnut-sized piece of dry ice added to the bath will sink and bubble vigorously and help stir it. If this type of bath is used, it should be deep enough to cover the specimens fully. It has been found by experience that standing the specimens on one end in the bath with their upper ends leaning on the vessel wall is most satisfactory. Specimens placed horizontally in the bath should be laid on a screen held at least ¼ in. (6.4 mm) from the bottom. If multiple specimens are placed in one bath, they should be spaced a minimum of 1 in. apart to ensure adequate heat-transfer liquid flow around each. The most convenient method of bath temperature measurement is to use a bare thermocouple connected to an automatic recorder.

14. Interpretation of Test Results

14.1 The success of the drop-weight test depends upon the development of a small cleavage crack in the crack-starter weld after a minute bending of the test specimen. The test evaluates the ability of the steel to withstand yield point loading in the presence of a small flaw. The steel either accepts initiation of fracture readily under these test conditions and the test specimen is broken, or initiation of fracture is resisted and the specimen bends the small, additional amount permitted by the anvil stop without complete fracturing.

14.2 After completion of each drop-weight test, the specimen shall be examined and the result of the test shall be recorded in accordance with the following criteria:

TABLE 2 Suggested Sequence of Drop-Weight Test Temperatures

Specimen Condition After Test at Temperature T_n	Suggested Test Temperature for Succeeding Test
No crack in weld notch	No-Test performance (see 14.2.3 and 14.3)
Weld crack extending less than ¼ in. (1.6 mm) into specimen surface	$T_n - 60^\circ\text{F}$ $T_n - 30^\circ\text{C}$
Weld crack extending ¼ to ½ in. (3.2 to 6.4 mm) into specimen surface	$T_n - 40^\circ\text{F}$ $T_n - 20^\circ\text{C}$
Weld crack extending approximately ½ the distance between specimen edge and toe of crack-starter weld bead	$T_n - 20^\circ\text{F}$ $T_n - 10^\circ\text{C}$
Weld crack extending to within ¼ in. (6.4 mm) of specimen edge	$T_n - 10^\circ\text{F}$ $T_n - 5^\circ\text{C}$
Specimen "Breaks" (see 14.2.1)	$T_n + 40^\circ\text{F}$ $T_n + 20^\circ\text{C}$
	Continue testing as described in 12.1 and 12.2

14.2.1 *Break*—A specimen is considered broken if fractured to one or both edges of the tension surface. Complete separation at the compression side of the specimen is not required for break performance. Typical examples of break performance are illustrated in Fig. 14.

NOTE 2—To aid in determining whether a tightly closed crack extends across the tension surface to a corner it may be helpful to first heat-tint or dye the specimen and then to fracture it in two pieces by any convenient means. The amount of fracturing that initially occurred is then readily apparent.

NOTE 3—Should any crack, whether initiated at the crack-starter or not, propagate to the specimen edge on the tension face, consider the test a break-performance.

14.2.2 *No-Break*—The specimen develops a visible crack in the crack-starter weld bead that is not propagated to either edge of the tension surface. Typical examples of no-break performance are illustrated in Fig. 15.

14.2.3 *No-Test*—The test shall be considered not valid if either weld-deposit notch is not visibly cracked after completion of a test, or if the drop-weight specimen is not deflected fully to contact the anvil stop as evidenced by transfer of the wax-pencil lines to the masking tape on the anvil deflection stop.

14.3 A No-Test performance (14.2.3) may result from the use of insufficient impact energy, the use of a too-ductile weld metal for crack-starter purposes, or misalignment of the speci-

men so that the weld-crown obstructs full deflection to the anvil stop. The No-Test sample shall be discarded and a retest, using another sample, shall be required. Retests, or tests of additional specimens, of a given steel found to develop insufficient deflections with the standard test condition, Table 1, shall be conducted with higher impact energies (see 11.3).

15. Report

15.1 Report the following information:

15.1.1 Type of steel and heat treatment,

15.1.2 Identification of product tested—heat number, plate number, etc.,

15.1.3 Identification, orientation, and location of test specimens,

15.1.4 Specimen type, test conditions and test temperatures employed,

15.1.5 Result of test (break, no-break, or no-test) for each specimen, and

15.1.6 Deviations, if any, from this test method.

16. Use of Test for Material-Qualification Testing

16.1 Specification tests conducted at a given test temperature, on a go, no-go basis, shall require that a minimum of two drop-weight specimens be tested. All specimens thus tested shall exhibit no-break performance to ensure that the

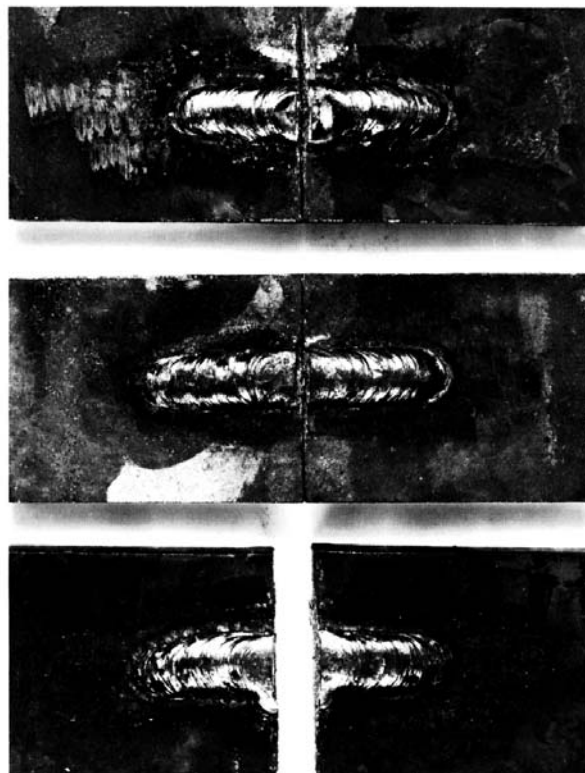

NOTE 1—The weld shown does not comply with the current procedure which specifies that the weld shall start from either end and shall proceed without interruption.

FIG. 14 Typical Examples of Broken Drop-Weight Specimens. Fracture Reaches to at Least One Edge

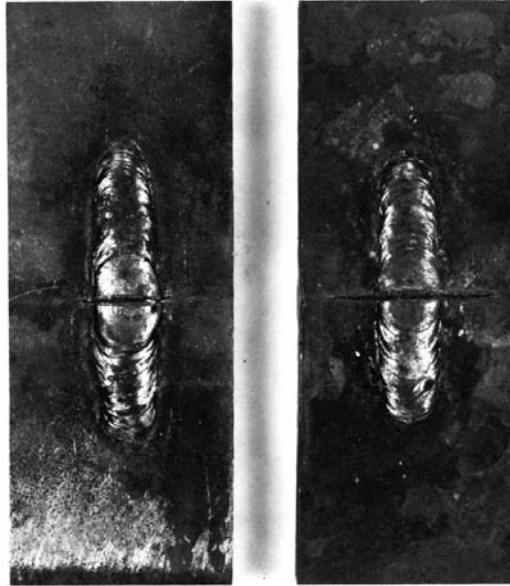

FIG. 15 Typical Examples of No-Break Performance in Drop-Weight Specimens. Fracture Does Not Reach Edge

NDT temperature of the steel under test is below the specification test temperature. The breaking of one (or more) specimens at the test temperature shall indicate the NDT temperature of the material to be at or above the specification test temperature.

17. Precision and Bias

17.1 No information is presented about either the precision or bias of Test Method E208 since the test result is non-quantitative.

17.2 *Bias*—There is no basis for determining the bias of this test method.

ADDITIONAL REFERENCES

*Selected References Relating to Development of Drop-Weight Test:*

- (1) Pellini, W. S., "Notch Ductility of Weld Metal," *Welding Journal*, Am. Welding Soc., Vol 35, May, 1956, p. 217-s.
- (2) Pellini, W. S., Brandt, F. A., and Layne, E. E., "Performance to Cast and Rolled Steels in Relation to the Problem of Brittle Fracture," *Transactions*, Am. Foundryman's Soc., Vol 61, 1953, p. 243.
- (3) Pellini, W. S., and Srawley, J. E., "I. Evaluating Fracture Toughness in Pressure Vessels for Space, Aerospace, and Hydrospace—A Symposium," *Journal of Metals*, March, 1961, pp. 195–198.
- (4) Puzak, P. P., and Babecki, A. J., "Normalization Procedures for NRL Drop-Weight Test," *Welding Journal*, Am. Welding Soc., Vol 38, May, 1959, p. 209-s.
- (5) Puzak, P. P., and Pellini, W. S., "Evaluation of the Significance of Charpy Tests for Quenched and Tempered Steels," *Welding Journal*, Am. Welding Soc., Vol 35, No. 6, 1956, p. 275-s.
- (6) Puzak, P. P., Schuster, M. E., and Pellini, W. S., "Applicability of Charpy Test Data," *Welding Journal*, Am. Welding Soc., Vol 33, September, 1954, p. 443-s.
- (7) Puzak, P. P., Schuster, M. E., and Pellini, W. S., "Crack Starter Tests of Ship Fracture and Project Steels," Appendix entitled, "Procedures for NRL Drop Weight Test," *Welding Journal*, Am. Welding Soc., Vol 33, No. 10, October, 1954, p. 481-s.

Selected References Relating to Correlation of NDT to Service Failures:

- (8) Babecki, A. J., Puzak, P. P., and Pellini, W. S., "Report of Anomalous 'Brittle' Failures of Heavy Steel Forgings at Elevated Temperatures," *Paper No. 59-MET-6*, Am. Soc. Mechanical Engrs., May, 1959.

- (9) Lange, E. A., and Klier, E. P., "A Study of Fracture Development and Materials Properties in PVRC Vessels 1 and 2," *Welding Journal*, Am. Welding Soc., Vol 41, February, 1962, p. 53-s.
- (10) Pellini, W. S., Steele, L. E., and Hawthorne, J. R., "Analysis of Engineering and Basic Research Aspects of Neutron Embrittlement of Steels," *NRL Report 5780*, April 17, 1962; also *Welding Journal*, Am. Welding Soc., October, 1962.
- (11) Puzak, P. P., Babecki, A. J., and Pellini, W. S., "Correlations of Brittle Fracture Service Failures with Laboratory Notch-Ductility Tests," *Welding Journal*, Am. Welding Soc., Vol 37, No. 9, September, 1958, p. 391-s.

Selected References Relating to Neutron Irradiation Embrittlement:

- (12) Hawthorne, J. R., and Steele, L. E., "Effect of Neutron Irradiation on Charpy-V Drop Weight Test Transition Temperatures of Various Steels and Weld Metals," *ASTM STP 286*, Am. Soc. Testing Mats., 1960, pp. 33–56.
- (13) Hawthorne, J. R., Steele, L. E., and Pellini, W. S., "Effects of Properties of Reactor Structural Materials," *Paper No. 61-WA-332*, Am. Soc. Mechanical Engrs., October 1961.
- (14) Steele, L. E., and Hawthorne, J. R., "Effect of Irradiation Temperature on Neutron-Induced Changes in Notch Ductility of Pressure-Vessel Steels," *NRL Report 5629*, June 28, 1961.

SUMMARY OF CHANGES

Committee E28 has identified the location of selected changes to this standard since the last issue (E208–95a(2001^{e1})) that may impact the use of this standard.

- | | |
|---|-------------------------|
| (1) Added additional information to the Introduction statement. | (4) Revised footnote 4. |
| (2) Revised 8.7. | (5) Revised 11.2. |
| (3) Deleted footnote 3. | (6) Revised Section 17. |

ASTM International takes no position respecting the validity of any patent rights asserted in connection with any item mentioned in this standard. Users of this standard are expressly advised that determination of the validity of any such patent rights, and the risk of infringement of such rights, are entirely their own responsibility.

This standard is subject to revision at any time by the responsible technical committee and must be reviewed every five years and if not revised, either reapproved or withdrawn. Your comments are invited either for revision of this standard or for additional standards and should be addressed to ASTM International Headquarters. Your comments will receive careful consideration at a meeting of the responsible technical committee, which you may attend. If you feel that your comments have not received a fair hearing you should make your views known to the ASTM Committee on Standards, at the address shown below.

This standard is copyrighted by ASTM International, 100 Barr Harbor Drive, PO Box C700, West Conshohocken, PA 19428-2959, United States. Individual reprints (single or multiple copies) of this standard may be obtained by contacting ASTM at the above address or at 610-832-9585 (phone), 610-832-9555 (fax), or service@astm.org (e-mail); or through the ASTM website (www.astm.org). Permission rights to photocopy the standard may also be secured from the Copyright Clearance Center, 222 Rosewood Drive, Danvers, MA 01923, Tel: (978) 646-2600; http://www.copyright.com/