



Standard Test Method for Electromagnetic Shielding Effectiveness of Durable Rigid Wall Relocatable Structures¹

This standard is issued under the fixed designation E1851; the number immediately following the designation indicates the year of original adoption or, in the case of revision, the year of last revision. A number in parentheses indicates the year of last reapproval. A superscript epsilon (ϵ) indicates an editorial change since the last revision or reapproval.

This standard has been approved for use by agencies of the U.S. Department of Defense.

1. Scope

1.1 This test method covers the determination of the electromagnetic shielding effectiveness of durable relocatable shielded enclosures.

1.1.1 The intended application of this test method is for virgin shielded enclosures that do not have any equipment or equipment racks. It is recommended that tests be conducted before the interior finish work begins. However, the shield assembly including all enclosure penetrations shall be completed and required penetration protection devices shall be installed in accordance with the design specification. The test method can also be used on existing shielded enclosures after repair work is done to verify workmanship, but it may be necessary to remove equipment or equipment racks to gain access to a test area.

1.1.2 The test procedures delineated in this document are comprehensive and may require several days to complete for a room-size shielded enclosure. A user can apply this test method for a first article test that requires proof of concept and validation of design and fabrication technique. **Appendix X2** provides guidance on choosing test points so shielding effectiveness tests on a room-size shielded enclosure may be completed in about one-half day for which it applies to shielded enclosures coming off an assembly line.

1.2 This test method is for use in the following frequency ranges: 140 to 160 kHz, 14 to 16 MHz, 300 to 500 MHz, 900 to 1000 MHz, and 8.5 to 10.5 GHz. Specific test frequencies within these ranges are required (see **11.1.1** and **11.2.1**). Additional measurements in the range of 10 kHz to 10.5 GHz may be performed. For specific applications, the frequency range may be extended from 50 Hz to 40 GHz. **Appendix X1** provides guidance on selecting measurement frequencies.

¹ This test method is under the jurisdiction of ASTM Committee E06 on Performance of Buildings and is the direct responsibility of Subcommittee E06.53 on Materials and Processes for Durable Rigidwall Relocatable Structures.

Current edition approved Sept. 1, 2015. Published September 2015. Originally approved in 1997. Last previous edition approved in 2009 as E1851-09. DOI: 10.1520/E1851-15.

1.3 This test method is not applicable to individual components such as separate walls, floors, ceilings, or shielded racks.

1.4 This standard may involve hazardous materials, operations, equipment, or any combination.

1.5 The values stated in SI units are to be regarded as the standard. The values in parentheses are for information only.

1.6 *This standard does not purport to address all of the safety concerns, if any, associated with its use. It is the responsibility of the user of this standard to establish appropriate safety and health practices and determine the applicability of regulatory limitations prior to use.*

2. Referenced Documents

2.1 *ASTM Standards*:²

E631 Terminology of Building Constructions

E1749 Terminology Relating to Rigid Wall Relocatable Shelters

2.2 *IEEE Standards*:³

IEEE Std 299-1997 IEEE Standard Method for Measuring the Effectiveness of Electromagnetic Shielding Enclosures
IEEE Std C95.1-1991 IEEE Standard for Safety Levels with Respect to Human Exposure to Radio Frequency Electromagnetic Fields, 3 kHz to 300 GHz

2.3 *Military Standard*:⁴

MIL-STD-188-125 High Altitude Electromagnetic Pulse (HEMP) Protection for Ground Based C⁴I Facilities Performing Critical, Time-Urgent Missions

2.4 *OSHA Standard*:⁵

OSHA Regulation, 29 CFR 1910, Department of Labor, July 1992

² For referenced ASTM standards, visit the ASTM website, www.astm.org, or contact ASTM Customer Service at service@astm.org. For *Annual Book of ASTM Standards* volume information, refer to the standard's Document Summary page on the ASTM website.

³ Available from Institute of Electrical and Electronics Engineers, Inc. (IEEE), 445 Hoes Ln., Piscataway, NJ 08854-4141, <http://www.ieee.org>.

⁴ Available from DLA Document Services, Building 4/D, 700 Robbins Ave., Philadelphia, PA 19111-5094, <http://quicksearch.dla.mil>.

⁵ Available from Occupational Safety and Health Administration (OSHA), 200 Constitution Ave., NW, Washington, DC 20210, <http://www.osha.gov>.

3. Terminology

3.1 *Definitions*—See Terminologies E631 and E1749 for definitions of general terms used in this test method.

4. Summary of Test Method

4.1 *Test Configuration*—A transmitting antenna is connected to an electromagnetic source set to a specific frequency and amplitude. A receiving antenna is placed a specified distance from the transmitting antenna, and the received electromagnetic field level is recorded as a reference or calibration measurement. The transmitting antenna and electromagnetic source are placed outside the shielded enclosure. The receiving antenna and associated test equipment are placed inside the shielded enclosure. The transmitting and receiving antenna’s separation, frequency, and amplitude are the reference measurements. The transmitting and receiving antennas are at the same height for a given test point. The received electromagnetic field level is recorded as the test measurement. The ratio of the test measurement to the reference measurement is the electromagnetic shielding effectiveness of the shielded structure at the measurement location and frequency. The logarithm of this ratio is typically used in expressing the shielding effectiveness in decibels.

4.2 *Test Frequencies*—A summary of nominal test frequencies and corresponding test configurations is shown in Table 1.

5. Significance and Use

5.1 This standard provides measurement procedures for determining the electromagnetic shielding effectiveness of durable rigid wall relocatable shielded enclosures. This standard specifies a method for comparing the shielded enclosure performance of structures provided by different suppliers. In addition, this standard is written to minimize variations in measured shielding effectiveness at a given frequency and test point regardless of test personnel, equipment, and test site. Therefore, the shielding effectiveness of a durable rigid wall relocatable shielded enclosure of any size from any supplier can be determined. This standard specifies a minimum set of measurements at a given frequency and a minimum set of frequencies to determine shielding effectiveness.

5.2 *Source Fields*—Performance of a shielded enclosure is to be assessed for two source fields: magnetic and plane wave.

5.2.1 *Magnetic Field Measurements*—The attenuation provided by a shielded enclosure is assessed by using a local source to generate the near field. The magnetic field measurements are specified for two narrow frequency bands: 140 to 160 kHz and 14 to 16 MHz.

5.2.2 *Plane Wave Measurements*—The attenuation provided by a shielded enclosure is assessed by using a locally generated distant source or plane wave field. The plane wave measure-

ments are specified for three narrow frequency bands: 300 to 500 MHz, 900 to 1000 MHz, and 8.5 to 10.5 GHz.

6. Interferences

6.1 *Interference with Electronic Equipment*—Care shall be taken to avoid interference with other electronic equipment operating in the vicinity.

6.2 *Operational Impact Analysis and Risk*—The electromagnetic barrier must remain intact during the shielding effectiveness measurement sequence, and use of electrically noisy equipment must be restricted. Therefore, construction activity or unusual operations (facility modification or maintenance) may be affected. Radiated signal levels should present no hazard to equipment, but frequency adjustments may be required to avoid self interference or interference with nearby facilities. Record the actual test frequencies. Normal electrical safety precautions apply.

7. Apparatus

7.1 The required apparatus is identified in Table 2. Choose test equipment that provides a dynamic range of at least 10 dB (20 dB is preferable (see Note 1)) in excess of the shielding effectiveness requirement at the test frequency.

TABLE 2 Test Apparatus

Equipment	Characteristics
Oscillator(s)	140 to 160 kHz, 14 to 16 MHz, 300 to 500 MHz, 900 to 1000 MHz, 8.5 to 10.5 GHz
Power Amplifier(s)	140 to 160 kHz, 14 to 16 MHz, 300 to 500 MHz, ^A 900 to 1000 MHz, ^A 8.5 to 10.5 GHz, amplification and noise figures as required for dynamic range
Preamplifier(s)	140 to 160 kHz, 14 to 16 MHz, 300 to 500 MHz, 900 to 1000 MHz, 8.5 to 10.5 GHz, amplification and noise figures as required for dynamic range
Receiver(s)/Spectrum Analyzer(s)	140 to 160 kHz, 14 to 16 MHz, 300 to 500 MHz, 900 to 1000 MHz, 8.5 to 10.5 GHz
Antenna Kit	140 to 160 kHz, ^B 14 to 16 MHz, ^B 300 to 500 MHz, ^C 900 to 1000 MHz, ^C 8.5 to 10.5 GHz ^D
Miscellaneous Cables and Attenuators as Required ^E	

^A The power amplifier output is usually matched to an unbalanced to balanced (balun) transformer; the balanced output is matched to a balanced dipole.

^B Circular loop antenna whose diameter is 30 cm (1 ft) shall be used. The shielded circular receiving antenna can have multiple turns, but the total length of wire forming the loop shall be less than 1/6 wavelength.

^C Any antenna that radiates at the prescribed frequencies may be used. However, antennas that require a large clear space in the direction of wave propagation shall not be used where clear space is limited for testing. Examples of such antennas are linearly polarized log periodic dipole and circularly polarized conical spiral antennas. Procedures are written assuming use of dipole antennas for plane wave measurements. If a dipole antenna is used as a receiving antenna, its length shall be less than 1/6 of wavelength. The receiving antenna is usually connected to a balun then to an attenuator.

^D Any antenna that radiates at the prescribed frequencies may be used except a linearly polarized log periodic dipole antenna or circularly polarized conical spiral antenna. Procedures are written assuming use of aperture antennas for high frequency plane wave measurements. An isolator is usually used between the source and its antenna to minimize variation of power between reference and test measurements.

^E Well shielded coaxial cable such as flexible semi-rigid coaxial cable, RG-214 or RG-223, shall be used.

TABLE 1 Test Frequencies and Test Configurations

Nominal Test Frequency	Corresponding Test Configuration
150 kHz and 14 MHz	Fig. 1
400 MHz, 1000 MHz, and 10 GHz	Fig. 2

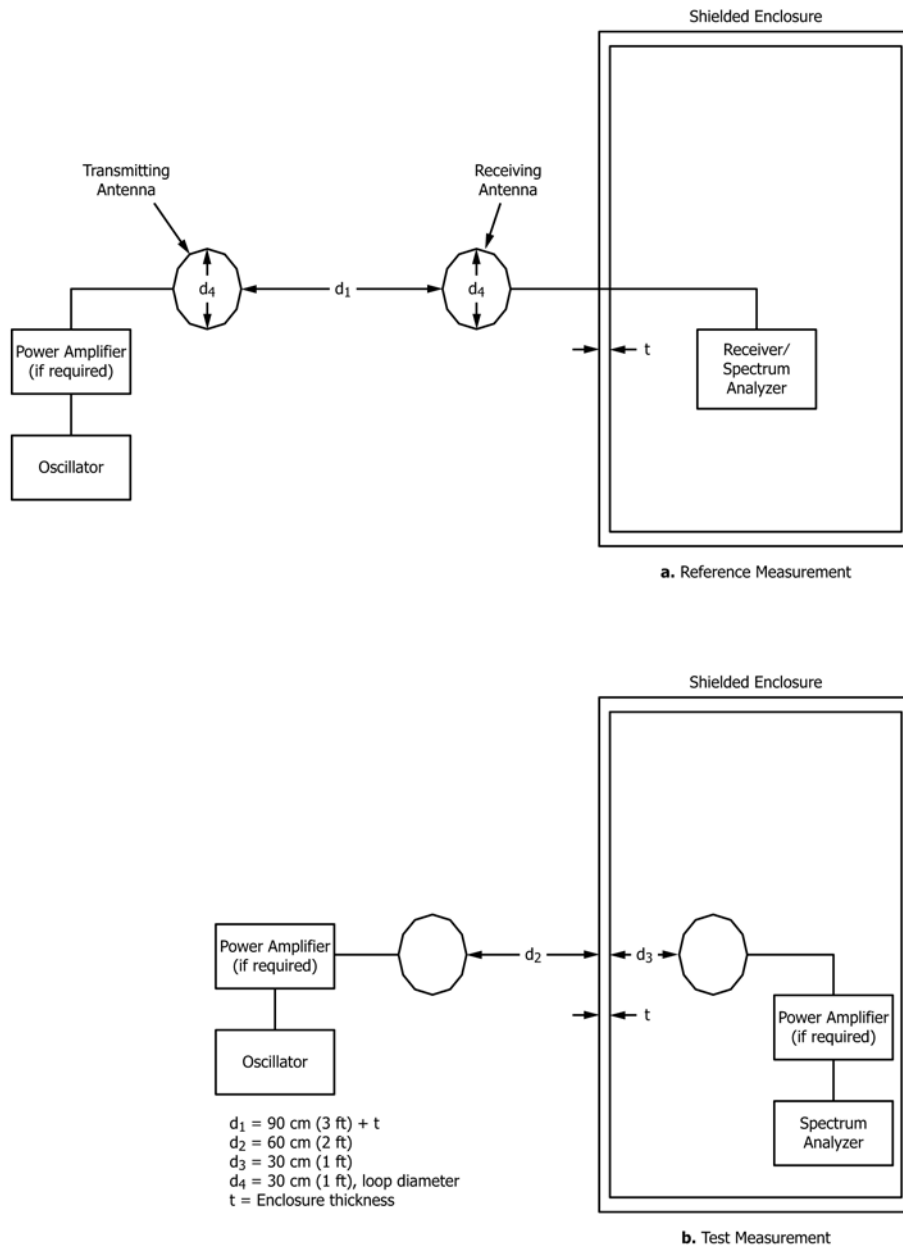

FIG. 1 Magnetic Field Test Procedures

NOTE 1—20 dB of dynamic range makes the test easier to perform by less experienced personnel. The standard uses a minimum of 10 dB because it offers a lower cost solution to testing durable rigid wall relocatable structures. If the existing test equipment has 20 dB of dynamic range then 20 dB of dynamic range should be used. It makes the hot spots stand out more clearly from the background noise on the LCD displays on spectrum analyzers.

8. Hazards

8.1 For human exposure to electromagnetic energy in controlled environments, the maximum permissible exposure to electric and magnetic field strengths shall be minimized to the maximum extent possible. Acceptable levels can be found in IEEE Std C95.1-1991 and OSHA Regulation, 29, CFR.

9. Preparation of Apparatus

9.1 *New and Existing Durable Relocatable Enclosure Testing*—Testing of new durable rigid wall relocatable shielded enclosures can be conducted at the manufacturing site. Manufacturing site testing can locate structural defects or weaknesses or both and corrections may be easily implemented. For existing structures, weaknesses can be determined and corrected during maintenance or periodic retesting.

9.2 *Movable Equipment*—Moveable equipment containing metal, not normally housed in the enclosure or attached outside the enclosure, shall be removed from the enclosure prior to making measurements.

9.3 Preliminary Procedures—Perform the following preliminary test on all accessible shielding faces to detect weak points and to permit remedy of shielding defects caused by faulty assembly and poor workmanship prior to actual measurement.

9.3.1 With the transmitting antenna turned off, perform a continuous wave (cw) measurement at each frequency to be used for testing to ensure that no emitters are nearby that may cause interference. Frequency adjustments may be necessary to avoid interference. Setup for this measurement is the reference measurement (see Section 10 and Fig. 1a and Fig. 2a).

9.3.2 Additionally, perform a receiving equipment coupling measurement. The setup for this measurement is the reference measurement (Section 10) with the following exceptions. Disconnect the receiving antenna from the nearest cable and replace the receiving antenna with a dummy load (resistive load matched to the characteristic impedance of the receiving system) as shown in Fig. 3. Measured levels shall be negligible so the required dynamic ranges are maintained. If the measured levels are larger than expected, determine the penetration points and correct the identified leakage points. Repeat the

receiving equipment coupling measurements until negligible levels are maintained.

9.3.3 Perform a noise measurement with the following equipment setup. Place the receiving antenna and equipment inside the enclosure and turn off the transmitting antenna placed outside the enclosure (see Fig. 4). The receiving antenna can be placed outside the enclosure. When this is done an attenuator shall be inserted between the receiving antenna and receiving equipment, and it shall be set to a shielding effectiveness level of the enclosure being tested. Measure the noise level at each frequency to be used for testing.

9.3.4 After noise levels have been found negligible (or the test equipment has been modified to make the penetration negligible), position the transmitting and receiving antennas in accordance with the procedures detailed in Section 11. For each location, use the receiving antenna as a probe to locate areas of maximum penetration. Alternatively, a commercial leak detector may be used. Check all penetrations such as doors, power line filters, air vents, seams, and coaxial cable fittings. If the performance of the enclosure appears to be inadequate for its design, remedial measures are suggested

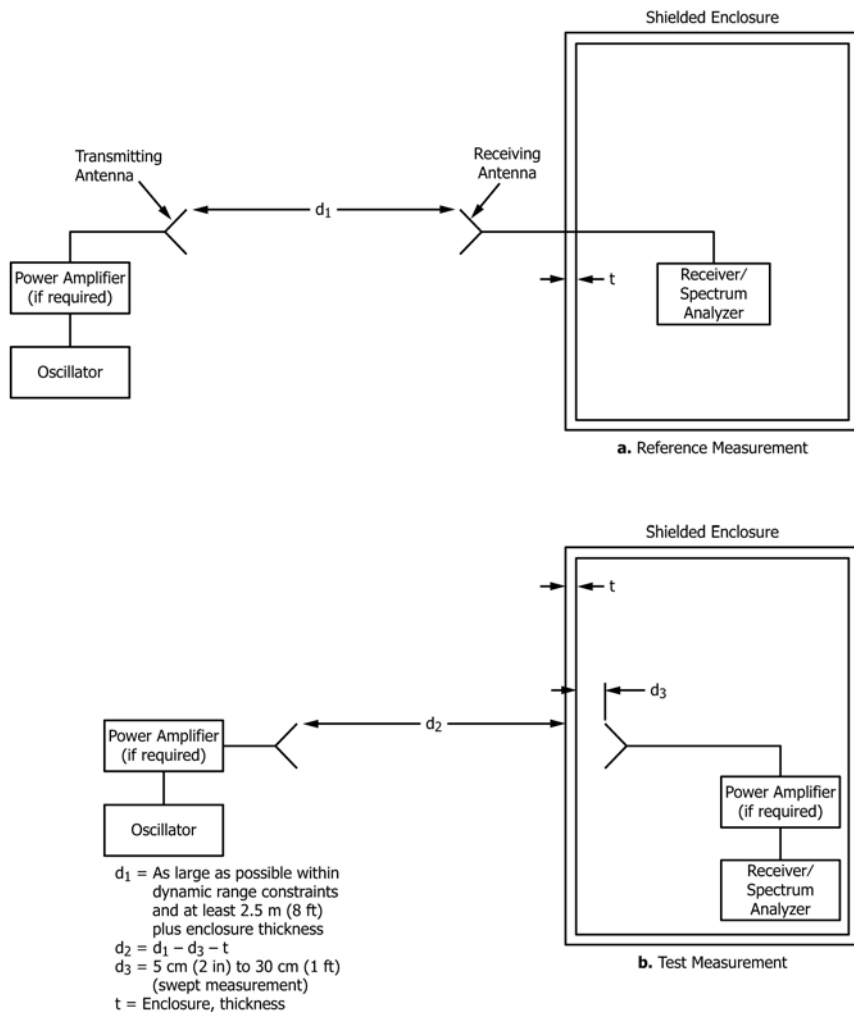
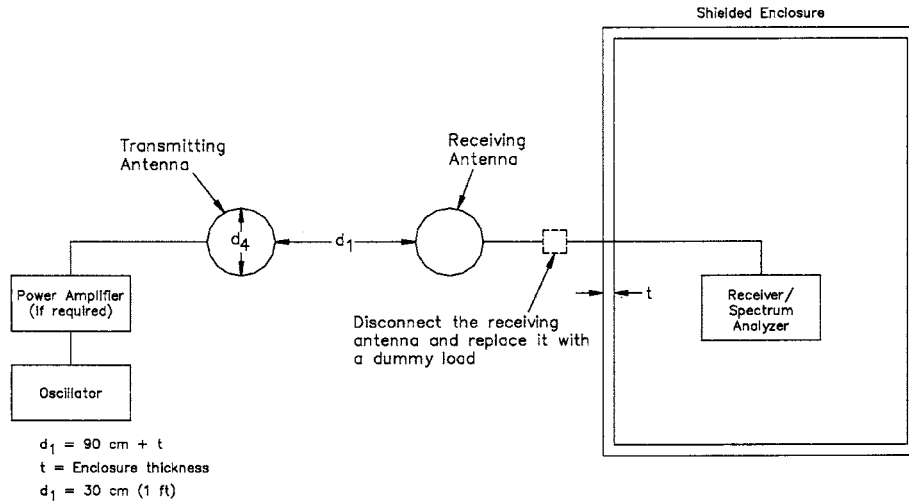
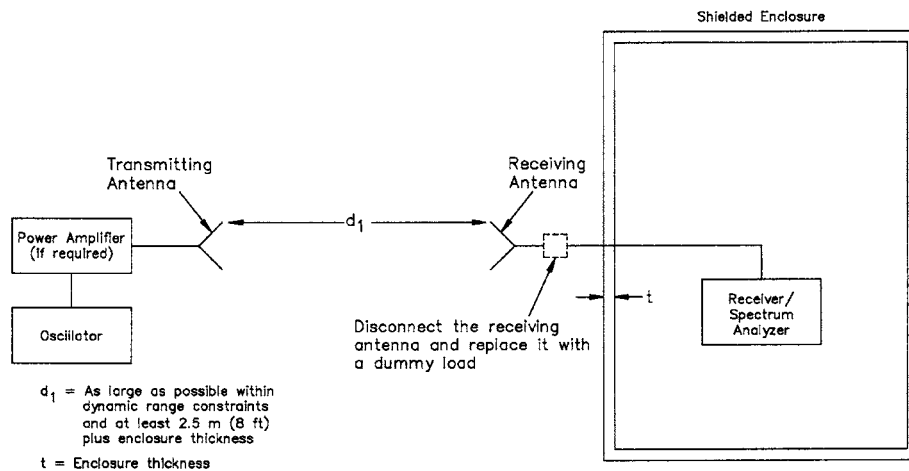

FIG. 2 Plane Wave Field Test Procedures



a. Magnetic Field Equipment Coupling



b. Plane Wave Equipment Coupling

FIG. 3 Equipment Coupling Measurement

prior to complete testing. Identify regions of significantly greater field penetration for later measurements.

10. Calibration Procedures

10.1 *Magnetic Field Calibration Procedure*—Conduct the calibration for magnetic field measurements for each magnetic field test frequency as shown in Fig. 1a. Choose test equipment that provides a dynamic range of at least 10 dB (20 dB is preferable (see Note 1)) in excess of the shielding effectiveness requirement at the test frequency. Place the loops of the transmitting and receiving antennas in a coplanar configuration. Place the transmitting and receiving antennas so the distance between them is 90 cm (3 ft) plus the thickness of the enclosure (see Fig. 1a). If an attenuator is used as the basis for the desired measurement, the attenuator shall be calibrated and the results shall be documented. The attenuator impedance

shall match the system transmission line impedance. Place the receiving system, but not the receiving antenna, inside the enclosure.

10.1.1 During calibration no other equipment or electromagnetic reflectors (except ground) shall be closer than three times the antenna separation. The antennas shall be at least 1 m (3.3 ft) above the ground.

10.1.2 Record the received signal strength for each frequency and transmitting antenna polarization as the calibration signal (V_c) for that configuration. Record all equipment settings, including generator loop current or transmit power.

10.2 *Plane Wave Calibration Procedure*—Conduct the calibration for plane wave measurements for each plane wave test frequency and antenna polarization as shown in Fig. 2a. Choose test equipment that provides a dynamic range of at least 10 dB (20 dB is preferable (see Note 1)) in excess of the

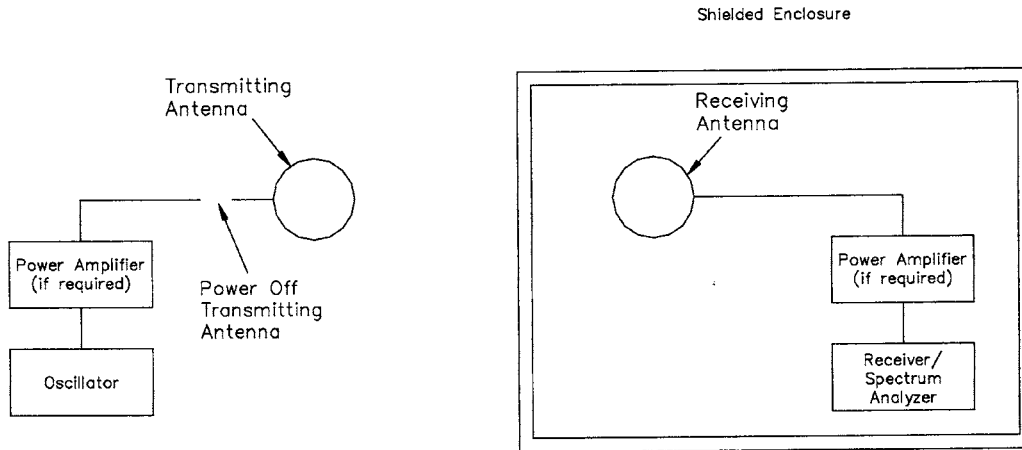

a. Magnetic Field Noise Measurement

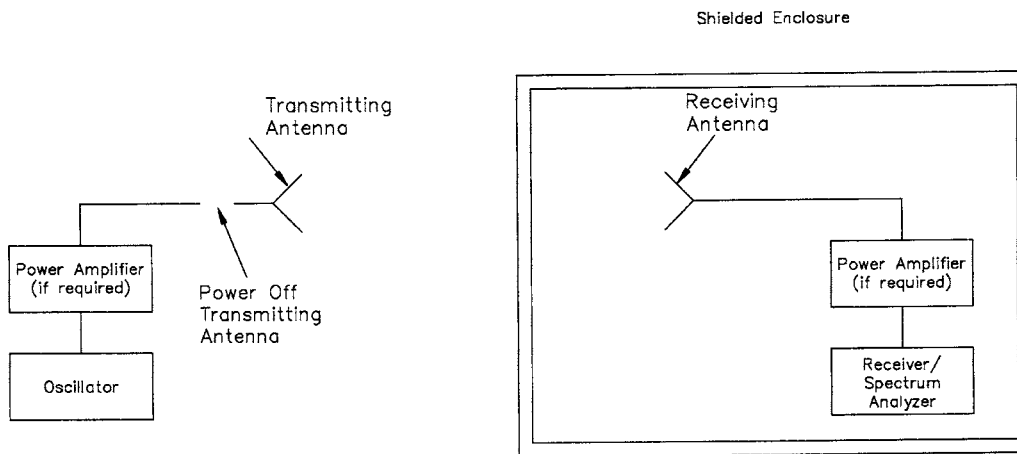

b. Plane Wave Noise Measurement

FIG. 4 Noise Measurement Procedures

shielding effectiveness requirement at the test frequency. For dipole antennas, place the transmitting and receiving antennas so both antennas lie in the same plane (coplanar) and their elements are parallel. For aperture antennas, place the transmitting and receiving antennas so their apertures are parallel. Separation distance between the antennas shall be as large as possible within dynamic range constraints, but at least 2.5 m (8.2 ft) plus enclosure thickness. Place the receiving system, but not the receiving antenna, inside the enclosure. Vary the receiving antenna position ± 0.3 m (1 ft) from its nominal location toward and away from the transmitting antenna to measure the local maximum, but do not vary the antenna alignment or polarization.

10.2.1 During calibration, no other equipment or electromagnetic reflectors (except ground) shall be closer than three

times the antenna separation. The antennas shall be at least 1 m (3.3 ft) above the ground.

10.2.2 Record the highest received signal strength for each frequency and both antenna polarizations as the calibration signal (V_c) for that configuration. Record all equipment settings, including generator output.

10.3 *Antenna Coverage*—Measure the maximum test area during the calibration. Place the vertically polarized transmitting antenna at least 2.5 m (8.2 ft) away from the vertically polarized receiving antenna, move the receiving antenna horizontally from left to right from its center, and measure the distance X (m) between the -3 dB points (below the peak amplitude). Repeat the above procedure by moving the receiving antenna up and down from its center position without

changing either antenna polarizations and measure the distance Y (m) between the -3 dB points.

11. Test Measurement Procedures

11.1 *Magnetic Field Test Measurement Procedure*—Conduct the magnetic field test measurement as shown in Fig. 1b. Use the same equipment, antennas, cables, loop current or transmit power, and equipment settings (except attenuator settings) that were used in the calibration sequences.

11.1.1 *General Test Procedures:*

11.1.1.1 Place the transmitting antenna outside the test structure and center it on the test point. Place the antennas in coplanar orientation with the coplanar normal to the surface of the shield surface. The distance from the transmitting antenna to the test point shall be 0.6 m (2 ft) (see Fig. 1).

11.1.1.2 Place the receiving antenna inside the test structure maintaining the same polarization. Sweep the receiving antenna along the seams or edges within the test point area keeping the receiving antenna 0.3 m (1 ft) from the test point surface until a maximum signal is received. Both horizontal and vertical coplanar measurements shall be performed at each section test point (see 11.1.4) and other openings (see 11.1.6). Cross-polarization measurements are not required. Record only the maximum received signal strength as the swept measured signal (V_m) for that test point, frequency, and transmitting antenna polarization.

11.1.1.3 After completion of a series of test measurements, not to exceed 4 h, repeat the reference level calibration determined in Section 10 to ensure there has been no deviation greater than 1 or 2 dB for the duration of the measurement

period. If only a small deviation is found (1 or 2 dB), do not adjust the data in determining the shielding effectiveness. If a greater deviation is found, investigate the transmitter and receiver hardware, cables, connectors, and other test equipment. When the source of the deviation is located, repair or replace the faulty hardware and retest the affected test points.

11.1.2 *Test Frequencies*—Obtain the magnetic field loop measurements at 150 kHz and 14 MHz. These test frequencies may be adjusted if the interference conditions described in 6.2 occur. Additional measurements may be performed within 10 kHz to 20 MHz if specified by the procuring agency.

11.1.3 *Corners and Edges:*

11.1.3.1 *Test Point Assignment*—For rectangular enclosures, a corner is formed where three panels meet. Assign three test points to each corner. Locate these three corner test points at a distance of 0.3 m (1 ft) from the interior corner along the three edges where three panels meet as shown in Fig. 5.

(a) An edge is formed where two non-planar panels meet. Determine the length of an edge by measuring the distance along the edge between the corner test points. The edge length determination applies to curvilinear surfaces as well. Assign edge test points that are uniformly spaced along the edge by dividing the edge length into equal segments not to exceed 0.6 m (2 ft) as shown in Fig. 6. Assign an additional test point if any test point interval exceeds 0.6 m (2 ft).

11.1.3.2 *Antenna Orientation*—For fully accessible corners, place the transmitting and receiving antennas in a coplanar orientation with the line between the center of antennas angled at 45° to the interior shielding surfaces at each test point (see

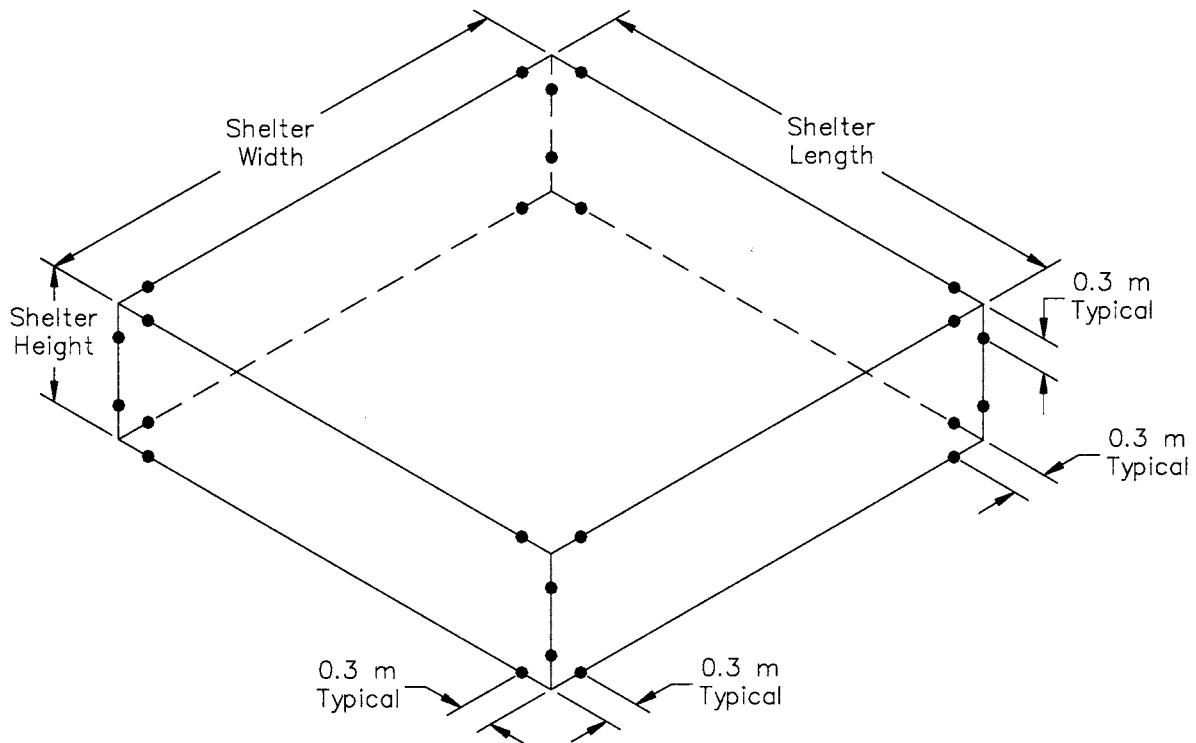
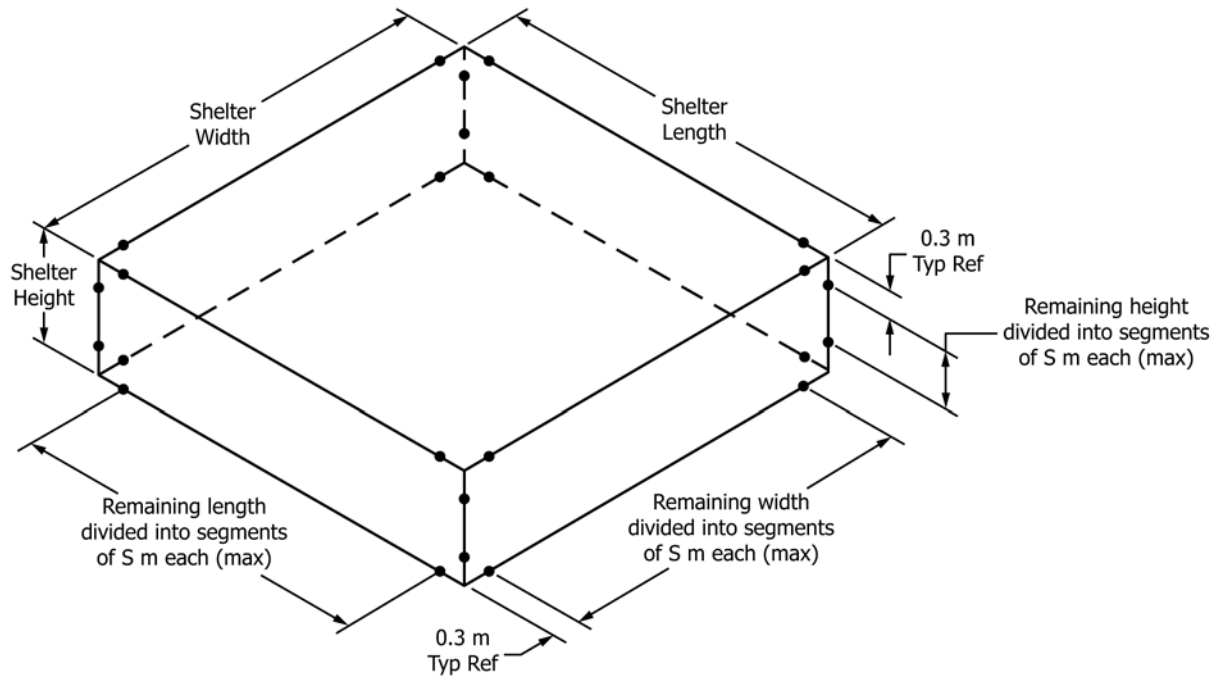

FIG. 5 Corner Test Point Assignment



$S \leq 0.6$ m (2 ft) for magnetic field test point assignment or
 S = Distance between 3dB fall off points measured during the calibration (see 10.2) for plane wave test area measurement.

FIG. 6 Edge Seam Test Point Assignment

Fig. 7e). For partially accessible corners, orient the transmitting and receiving antennas as shown in Fig. 7d. Position the antennas for edge test points as shown in Fig. 7e. Obtain one test measurement for each corner test point and each edge test point.

11.1.4 Sections and Seams:

11.1.4.1 Test Point Assignment—A shielded enclosure is usually comprised of one or more integrally fabricated sections such as a roof panel or a formed knee-wall panel. These sections are attached together directly or to a common supporting frame. Seams are formed as a result of connecting sections together.

(a) Sections made of metallic panels do not require testing except where seams are formed. Floor sections do not require testing even if they have seams, unless otherwise specified by a procuring agency. Assign seam test points that are spaced uniformly along each seam at a spacing not to exceed 0.6 m (2 ft) as shown in Fig. 6. The seam test point spacing applies to curvilinear surfaces as well. For seams less than 0.6 m (2 ft) long, assign a single test point at the seam midpoint. Assign an additional test point if any interval exceeds 0.6 m (2 ft). Any test points that overlap with each other can be eliminated.

11.1.4.2 Antenna Orientation—Place the transmitting and receiving antennas in coplanar orientation as indicated in 11.1 with the coplane of antennas perpendicular to the seam line at each seam test point. Obtain one measurement for each seam test point with the coplane of the antennas perpendicular to the seam line.

11.1.5 Doors:

11.1.5.1 Test Point Assignment—Assign one test point for each door corner. In addition, the vertical seam test points consist of two test points at one-third the distance from the top of the door and one-third the distance from the bottom of the door. The horizontal seam test points are the center of each horizontal door seam. See Fig. 7a and Fig. 7b.

11.1.5.2 Antenna Orientation—Place the transmitting and receiving antennas in coplanar orientation as indicated in 11.1 with the coplane of antennas perpendicular to the door seam at each test point (see Fig. 7a). Door corner test points require two measurements, first with the transmitting antenna vertically polarized and then horizontally polarized.

(a) Obtain one measurement for each door seam test point and obtain two measurements for each door corner test point (see Fig. 7). Record the highest signal and the corresponding antenna polarization.

11.1.6 Other Openings—This section describes test procedures for openings such as hatches, power/signal entry panels, ventilation/environmental control unit openings, and so forth.

11.1.6.1 Test Point Assignment—Assign one test point at the geometric center of the opening. For each opening larger than 0.6 m (2 ft) by 0.6 m (2 ft) assign additional test points to cover the entire opening. Any test points that overlap with each other can be eliminated.

11.1.6.2 Antenna Orientation—Place the transmitting and receiving antennas in coplanar orientation as indicated in 11.1. Obtain two measurements for each opening test point with the coplane of the antennas perpendicular and then parallel to the nearest seam.

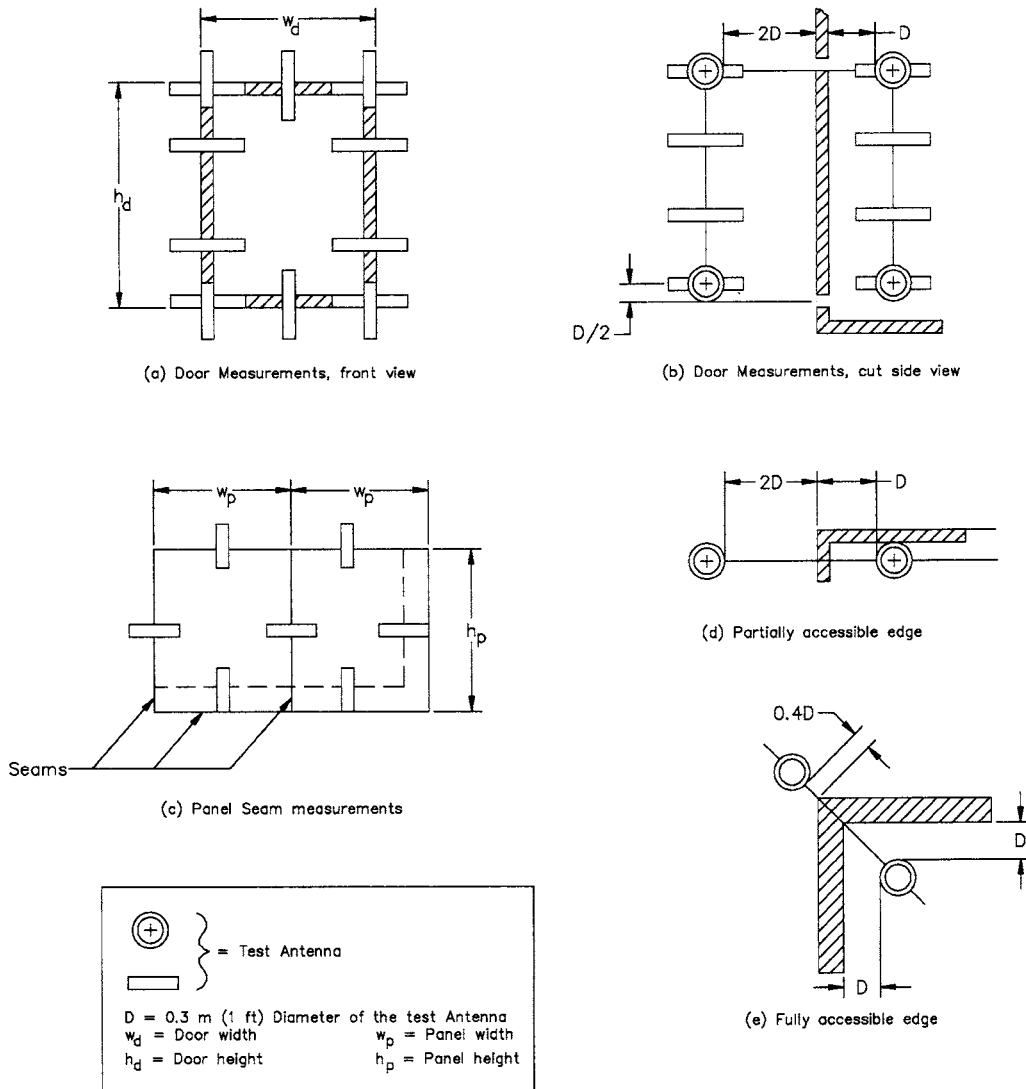

FIG. 7 Door, Seam, and Edge Measurements for Magnetic Field

11.1.7 *Isolated Penetrations*—This section describes test procedures for isolated enclosure penetrations such as drain holes, pressure relief valves, electrical and other connectors, and door handles and hinges.

11.1.7.1 *Test Point Assignment*—Assign one test point to the geometric center of each isolated test point. Any isolated test point that overlaps with other test points can be eliminated.

11.1.7.2 *Antenna Orientation*—Place the transmitting and receiving antennas in coplanar orientation as in 11.1 with the line between antenna centers passing through the opening. Obtain two measurements for each test point with two orthogonal orientations of the coplane.

11.2 *Plane Wave Test Measurement Procedure*—The general plane wave field test procedure is shown in Fig. 2b. Use the same equipment, antennas, cables, generator output levels, and equipment settings (except attenuator settings) that were used in the calibration sequences. The following paragraphs require four antenna polarization measurement combinations:

transmit vertical—receive vertical and horizontal and transmit horizontal—receive horizontal and vertical. Systems that transmit circular polarization or simultaneously transmit horizontally and vertically polarized fields using separate (within a few kHz) signals are also acceptable, as long as all received polarization combinations are measured.

11.2.1 *General Test Procedures:*

11.2.1.1 Place the transmitting antenna outside the enclosure and the receiving antenna inside so their propagation axes are colinear and normal to the surface of the enclosure at the test point. The separation distance between the transmitting antenna and the receiving antenna for scanning shall be the same as that of the reference measurement. Initially the receiving antenna shall be positioned 5 cm (2 in.) from the enclosure wall (see Fig. 2b).

11.2.1.2 With the receiving system inside the structure, slowly (not to exceed receiver response time) scan only the seams, openings, and penetrations within the test point area

using the receiving antenna with its antenna plane parallel to the plane of the transmit antenna. Perform the scan at a distance of 5 cm (2 in.) from the surface. At the point of highest signal, move the antenna back about $\frac{1}{2}$ wave length or up to 0.3 m (1 ft) to measure the local maximum signal. Record all required measurements at the point of highest signal. During the measurement, rotate the receiving antenna to explore both horizontal and vertical polarizations for each transmitting antenna polarization.

11.2.1.3 Change the transmit antenna polarization and repeat the measurement sequence outlined above.

11.2.1.4 Record the maximum received signal strength (V_m) for that test area. Note both the transmit and receive antenna polarizations for that maximum reading.

11.2.1.5 After completing a series of test measurements, not to exceed four hours, repeat the reference level calibration determined in Section 10 to ensure that there has been no deviation greater than 1 or 2 dB for the duration of the measurement period. If only a small deviation is found, do not adjust the data in determining the shielding effectiveness. If a greater deviation is found, investigate the transmitter and receiver hardware, cables and connectors, and other test equipment. When the source of the deviation is located, repair or replace the faulty hardware and retest the affected test points.

11.2.2 *Test Frequencies*—Obtain the plane wave measurements at 400 MHz, 1000 MHz, and 10 GHz. These frequencies may be adjusted to avoid local interference. These procedures are valid for the frequency range of 300 MHz to 10.5 GHz and additional measurements may be performed within this range.

11.2.3 *Corners and Edges*—The following paragraphs require four antenna polarization measurement combinations: transmit vertical—receive vertical and horizontal and transmit horizontal—receive horizontal and vertical. Systems that transmit circular polarization or simultaneously transmit horizontally and vertically polarized fields using separate (within a few kHz) signals are also acceptable, as long as all received polarization combinations are measured.

11.2.3.1 *Test Point Assignment*—For rectangular enclosures, a corner is formed where three panels meet. Assign three test points to each corner. Locate these three corner test points at a distance of 0.3 m (1 ft) from the interior corner along the three edges where three panels meet as shown in Fig. 5.

11.2.3.2 An edge is formed where two non-planar panels meet. Determine the length of an edge by measuring the distance along the edge between the corner test points. The edge length determination applies to curvilinear surfaces as well. Assign edge test points that are uniformly spaced along the edge by dividing the edge length into equal segments not to exceed the distance S m, where S is the minimum of X and Y as determined in the calibration procedure described in 10.3. Any test points that overlap with each other can be eliminated.

11.2.3.3 *Antenna Orientation*—For fully accessible edges, orient the transmitting and receiving antennas so their propagation axes are colinear and their coaxes pass through the corner test point at 45° from an interior wall at the three-way corner (see Fig. 8e). For partially accessible edges, orient the transmitting and receiving antennas as shown in Fig. 8d.

(a) Position the antennas for edge test points as shown in Fig. 8e for fully accessible edge test points and Fig. 8d for partially accessible edge test points. Obtain two test measurements for each corner and edge test point, first with the transmitting antenna polarization perpendicular to the edge or corner seam line being tested, then with the transmitting antenna polarization parallel to the seam line being tested. Rotate the receiving antenna during the measurements to explore both horizontal and vertical polarizations for each transmitting antenna polarization. Record the highest signal obtained and the polarizations of the transmitting and receiving antennas at each test point.

11.2.4 *Sections and Seams*—The following paragraphs require four antenna polarization measurement combinations: transmit vertical—receive vertical and horizontal and transmit horizontal—receive horizontal and vertical. Systems that transmit circular polarization or simultaneously transmit horizontally and vertically polarized fields using separate (within a few kHz) signals are also acceptable, as long as all received polarization combinations are measured.

11.2.4.1 *Test Point Assignment*—A shielded enclosure is usually comprised of one or more integrally fabricated sections such as a roof panel or a formed knee-wall panel. These sections are attached together directly or to a common supporting frame. Seams are formed as a result of connecting sections together.

(a) Assign seam test points spaced uniformly along each seam not to exceed the distance S m established during the calibration as shown in Fig. 6. The seam test point spacing applies to curvilinear surfaces as well. For seams less than S m long, assign a single test point at the seam midpoint. Any test points that overlap with each other can be eliminated.

11.2.4.2 *Antenna Orientation*—Orient the transmitting and receiving antennas so their propagation axes are colinear and normal to the plane of the section being tested at the test point as in 11.2.1.1 for both section and seam measurements.

(a) Obtain two measurements at each seam test point, first with the transmitting antenna polarization perpendicular then parallel to the seam line being tested. During the measurements, rotate the receiving antenna to explore both horizontal and vertical polarizations for each transmitting antenna polarization. Record the highest signal obtained and the corresponding polarizations of transmitting and receiving antennas at each test point.

11.2.5 *Doors*—The following paragraphs require four antenna polarization measurement combinations: transmit vertical—receive vertical and horizontal and transmit horizontal—receive horizontal and vertical. Systems that transmit circular polarization or simultaneously transmit horizontally and vertically polarized fields using separate (within a few kHz) signals are also acceptable as long as all received polarization combinations are measured.

11.2.5.1 *Test Point Assignment*—Assign a door test point at the center of the door. The maximum allowable test area is S m by S m, where S is the minimum of X and Y as determined in the calibration procedure described in 10.3. If the door is larger than the maximum test area, assign additional test points so

vertical. Systems that transmit circular polarization or simultaneously transmit horizontally and vertically polarized fields using separate (within a few kHz) signals are also acceptable as long as all receive polarization combinations are measured.

11.2.6.1 *Test Point Assignment*—Assign one test point at the geometric center of the opening. For each opening larger than S m by S m, assign additional test points to cover the entire opening. Any opening test points that overlap with each other can be eliminated.

11.2.6.2 *Antenna Orientation*—Orient the transmitting and receiving antennas so their propagation axes are colinear and normal to the plane of the opening at the test point.

(a) Obtain two measurements at each test point, first orient the transmitting antenna's polarization perpendicular then parallel to the nearest seam. During the measurement, rotate the receiving antenna to explore both horizontal and vertical polarizations for each transmitting antenna polarization. Record the highest signal obtained and the corresponding polarizations of transmitting and receiving antennas at each test point.

11.2.7 *Isolated Penetrations*—This paragraph describes test procedures for isolated, small enclosure penetrations such as drain holes, pressure relief valves, electrical and other connectors, and door handles and hinges. The following paragraphs require four antenna polarization measurement combinations: transmit vertical—receive vertical and horizontal and transmit horizontal—receive horizontal and vertical. Systems that transmit circular polarization or simultaneously transmit horizontally and vertically polarized fields using separate (within a few kHz) signals are also acceptable, as long as all received polarization combinations are measured.

11.2.7.1 *Test Point Assignment*—Assign one test point to the geometric center of each isolated penetration test point. An isolated test point that overlaps with another test point can be eliminated.

11.2.7.2 *Antenna Orientation*—Orient the transmitting and receiving antennas so their axes are colinear and normal to the plane of the enclosure wall at each test point. If a well defined seam line exists, obtain measurements for the transmitting antenna polarized, perpendicular, and parallel to the seam line. For each transmitting antenna polarization, rotate the receiving antenna during the measurements to explore both horizontal and vertical polarizations. Record the highest signal obtained and the corresponding polarizations of the transmitting and receiving antennas at each test point. If a well defined seam line does not exist, an arbitrary line defined by the measurer at the test point shall be used as a substitute for an actual seam line.

12. Calculation and Interpretation of Results

12.1 The fields penetrating a shielded enclosure arise from both electric and magnetic components of the electromagnetic field. The results obtained can be in units of decibels, voltage, or power. Each result can be used to determine the shielding effectiveness of the shielded enclosure under test.

12.2 *Magnetic Field Measurement Results*—In the low range of frequencies (140 kHz to 16 MHz), shielding effectiveness (SE) is expressed in terms of magnetic field performance.

12.2.1 When magnetic field measurements are in terms of voltage, use the voltage form of the shielding effectiveness equation:

$$SE_H (dB) = 20 \log_{10} V_c/V_m \quad (1)$$

where:

V_c = Voltage measured in the absence of the enclosure (calibration measurement) and

V_m = Voltage measured in the presence of the enclosure (test measurement).

12.2.2 When magnetic field measurements are in terms of decibels, use the following shielding effectiveness equation:

$$SE_H (dB) = H_c - H_m \quad (2)$$

where:

H_c = Magnetic field measured in decibels in the absence of the enclosure (calibration measurement) and

H_m = Magnetic field measured in decibels in the presence of the enclosure (test measurement).

12.3 *Plane Wave Measurement Results*—In the high range of frequencies (300 MHz to 10.5 GHz), shielding effectiveness is expressed in terms of plane wave (PW) performance.

12.3.1 When plane wave measurements are in terms of voltage, use the voltage form of the shielding effectiveness equation:

$$SE_p (dB) = 20 \log_{10} V_c/V_m \quad (3)$$

where:

V_c = Voltage measured in the absence of the enclosure (calibration measurement) and

V_m = Voltage measured in the presence of the enclosure (test measurement).

12.3.2 When plane wave measurements are in terms of decibels, use the following shielding effectiveness equation:

$$SE_p (dB) = PW_c - PW_m \quad (4)$$

where:

PW_c = Plane wave measured in decibels in the absence of the enclosure (calibration measurement) and

PW_m = Plane wave measured in decibels in the presence of the enclosure (test measurement).

12.3.3 When plane wave measurements are in terms of power, use the following shielding effectiveness equation:

$$SE_p (dB) = 10 \log_{10} P_c/P_m \quad (5)$$

where:

P_c = Power detected in the absence of the enclosure (calibration measurement) and

P_m = Power detected in the presence of the enclosure (test measurement).

13. Report

13.1 A technical report on the performed measurements shall be prepared. Contents of the report shall be adequate to

ascertain the enclosure performance and shall contain enough detail on the measurements to assure the validity of the approach and accuracy of the instrumentation. Typical contents, in addition to a title page, are described in the following subsections.

13.2 *Background*—This section of the report will normally address the following topics:

- (1) For whom the report was prepared and by whom,
- (2) Name, model, serial number, and description of the shielded enclosure under test,
- (3) Location of shielded enclosure test,
- (4) Conditions restricting the performed measurements, and
- (5) Sketch of shelter with test points labeled.

13.3 *Measurement Procedure*—The measurement procedure shall be in accordance with this standard. Deviations from the standard procedure shall be noted, and explanations for the deviations shall be provided.

13.4 *Measurement Apparatus*—Measurement apparatus and antennas shall be identified by manufacturer, model, and serial number. Dates of latest calibration (traceable to the National Institute of Standards and Technology) shall be provided and shall not predate the measurements by more than one year.

13.5 *Results*—A typical data sheet for one frequency is shown in Fig. 9. Any format that provides the same information may be used. Summaries of data by test point or component may also be useful presentations. In addition, include pass/fail criteria, results, conclusions, and recommendations, as appropriate.

14. Precision and Bias

14.1 *Nonlinearity Effects*—Nonlinearity effects may be determined by placing source and receiving loops on opposite sides of a panel near its geometric center and measuring SE as a function of source strength. Generator strength is increased 10 dB in steps, nominally 0.1 to 1 and 10 W. If SE decreases more than 2 dB, perform intermediate level measurements. Plot the results to determine the highest level permissible for linear performance (within ± 1 dB).

14.2 *Cavity Resonances*—A measurement procedure is not recommended for frequencies in the range of the lowest cavity resonances, because considerable variability of data is found in this frequency range. The frequency range to be avoided is approximately 0.8 to 3 f_r , where f_r is the lowest cavity resonance frequency. For an enclosure of height h m and longest side l m, the lowest resonant frequency in MHz is approximately;

$$f_r = 150 \sqrt{(1/h^2) + (1/l^2)}, h < 1 \quad (6)$$

14.3 It is not practicable to specify the precision of the procedure in Test Method E1851 for measuring shielding effectiveness of a shielded enclosure because the test method measures relative numbers and the measured numbers usually vary a few decibels when repeated.

15. Keywords

15.1 electromagnetic measurements; electromagnetic shielded enclosures; magnetic field; plane wave; shielding effectiveness

Enclosure:

Date: / /

	Location	Test Level (dB)	Shielding* Effectiveness (dB)
Type measurement:	Door	1	
Frequency (nominal):		2	
Frequency (actual):		3	
Antenna separation:		4	
Antenna polarization:		5	
Calibration level (dB): Start		6	
End		10	
Receiving system noise level (dB)	Panel A	1	
NOTES:		2	
		3	
		4	
	Panel B	1	
		2	
		3	
		4	
	Panel C	1	
		2	
		3	
		4	
	Panel D	1	
		2	
		3	
		4	
	Air Vent	1	
		2	
		3	
		4	
	Filter Panel	1	
	2		
	3		
	4		
Etc.			
Signature of Test Engineer:			
Date: _____			
Date: _____			
*Shielding Effectiveness = Calibration Level - Test Level (dB)			

FIG. 9 Sample Reporting Format

APPENDIXES

(Nonmandatory Information)

X1. SELECTING MEASUREMENT FREQUENCIES

X1.1 Regulatory Note

X1.1.1 Transmitter operation must be authorized by the Federal Communications Commission (FCC). A special temporary authorization (STA) may be obtained on the basis of an existing experimental license (FCC Rules, Part 5, Paragraph 5.5.6).⁶ The STA may be obtained by letter, and the response time is usually less than 30 days. The STA is valid for 30 days of operation but allows adding new frequencies temporarily if needed for special tests.

X1.1.2 The licensed experimental equipment must be operated only under the supervision of an FCC commercial first or second class operator's license (either radiotelephone or radiotelegraph). If a licensed operator is not already a member of the testing staff, a staff member should obtain such an operator's license (see *Rules and Regulations of the FCC*, Vol 1, Part 13).⁶

X1.2 Selecting Frequencies

X1.2.1 The Table of Frequency Allocations in the FCC Rules, Part 2, Paragraph 2.106,⁶ should be studied to select frequencies that are most likely to be approved. In general, frequencies will probably be approved where no interference to other licensed radio services is likely to occur. The length of time each frequency will be used should always be stated. If frequencies are to be used intermittently, they are more likely to be approved. Under intermittent use interference tends to be minimized, and the FCC may approve intermittent use of frequencies for which continuous use could not be approved. It is advisable to limit the request in the business, industrial, and petroleum radio-service frequencies.

⁶ Available from Federal Communications Commissions (FCC), 445 12th Street SW, Washington, DC 20554, <http://www.fcc.gov>.

X1.2.2 *Frequencies to Avoid*—In general, the Domestic Public Radio Service frequencies should be avoided since this service is protected. Police and fire department frequencies should also be avoided.

X1.2.2.1 The exact frequency of a commercial broadcast station should be avoided if there is a reasonable chance that interference will occur.

X1.2.2.2 The following frequencies should not be requested: on or within the guard bands or any emergency frequencies in any of the VLF, LF, MF, or HF radio navigation channels active at or near the test locations. See FCC Rules, Part 2, Paragraph 2.106 for frequency allocations.

X1.2.2.3 Government frequencies should be avoided. Requesting government frequency or frequencies in the maritime service will slow down license processing. If government frequencies are needed, contact the local area frequency coordinator through the nearest military base communications officer. Early establishment of rapport with the area frequency coordinator is beneficial in any situation. If the coordinator is satisfied that no harmful interference to government services will occur, license authorization for government frequencies will be obtained.

X1.2.2.4 Standard frequencies such as WWV, Canadian time, and US Naval Observatory should be avoided. The FCC cannot authorize their uses in experimental radio service. Radio-astronomy frequencies active in or near the service area should also be avoided. See FCC Rules, Part 2, Paragraph 2.106 for frequency allocations.

X1.2.2.5 All requests should be for discrete frequencies. A request for a band of frequencies should include a justification of why discrete frequencies cannot be used.

X2. TEST METHODS FOR SHIELDED ENCLOSURES COMING OFF AN ASSEMBLY LINE

X2.1. Scope

X2.1.1 The test methods described in this appendix can be used to verify quality of workmanship of shielded enclosures coming off an assembly line. It is presumed that a first article of the shielded enclosure has been tested to verify its design concept in accordance with the procedures specified in the main text of this standard and that the shielded enclosure passed a shielding effectiveness test. Test methods specified in this appendix are considered a reasonably cost effective means of verifying quality of workmanship of a shielded enclosure.

X2.1.1.1 As specified in 1.1 of the main text, the intended application of the test methods is for shielded enclosures that do not have equipment or equipment racks. It is recommended

that tests be conducted before the interior finish work begins. However, the shield assembly including all enclosure penetrations shall be completed, and penetration protection devices shall be installed in accordance with the design specification if required.

X2.1.2 These test methods are not applicable to individual components such as separate walls, floors, ceilings, or shielded racks.

X2.1.3 Test methods described in this appendix may involve hazardous materials, operations, and equipment. It is the responsibility of the user of this appendix to establish appropriate safety and health practices and determine the applicability of regulatory limitations prior to use.

X2.1.4 The values stated in SI units are to be regarded as the standard. The values in parentheses are for information only.

X2.2 Summary of Test Methods

X2.2.1 The test methods described in this appendix are the same as those of the main text except test frequencies and test point assignments. Thus, a user should become familiar with the main text before using this appendix.

X2.3 Test Frequencies

X2.3.1 A nominal test frequency for magnetic fields is 150 kHz, and nominal test frequencies for plane wave field are 400 MHz and 10 GHz.

X2.4 Test Point Assignments

X2.4.1 *Magnetic Field Test Point Assignment*—Assign test points and subsequently conduct tests at all isolated penetrations and openings, including doors, as described in the main text. Any test points that overlap with each other can be eliminated.

X2.4.2 Plane Wave Field Test Point Assignment:

X2.4.2.1 *400 MHz*—Assign test points by dividing each wall and ceiling into 2.5 (8) by 2.5 m (8.2 ft) sections. Scan all seams, penetrations, openings, edges, and corners at each test point as described in the main text.

X2.4.2.2 *10 GHz*—Assign test points and subsequently conduct tests by scanning all seams, penetrations, openings, edges, and corners at each test point as described in the main text (see 11.2).

ASTM International takes no position respecting the validity of any patent rights asserted in connection with any item mentioned in this standard. Users of this standard are expressly advised that determination of the validity of any such patent rights, and the risk of infringement of such rights, are entirely their own responsibility.

This standard is subject to revision at any time by the responsible technical committee and must be reviewed every five years and if not revised, either reapproved or withdrawn. Your comments are invited either for revision of this standard or for additional standards and should be addressed to ASTM International Headquarters. Your comments will receive careful consideration at a meeting of the responsible technical committee, which you may attend. If you feel that your comments have not received a fair hearing you should make your views known to the ASTM Committee on Standards, at the address shown below.

This standard is copyrighted by ASTM International, 100 Barr Harbor Drive, PO Box C700, West Conshohocken, PA 19428-2959, United States. Individual reprints (single or multiple copies) of this standard may be obtained by contacting ASTM at the above address or at 610-832-9585 (phone), 610-832-9555 (fax), or service@astm.org (e-mail); or through the ASTM website (www.astm.org). Permission rights to photocopy the standard may also be secured from the Copyright Clearance Center, 222 Rosewood Drive, Danvers, MA 01923, Tel: (978) 646-2600; <http://www.copyright.com/>