



# Standard Test Method for Measuring the Toxicity of Sediment-Associated Contaminants with Freshwater Invertebrates<sup>1</sup>

This standard is issued under the fixed designation E1706; the number immediately following the designation indicates the year of original adoption or, in the case of revision, the year of last revision. A number in parentheses indicates the year of last reapproval. A superscript epsilon ( $\epsilon$ ) indicates an editorial change since the last revision or reapproval.

## 1. Scope\*

1.1 This test method covers procedures for testing freshwater organisms in the laboratory to evaluate the toxicity of contaminants associated with whole sediments. Sediments may be collected from the field or spiked with compounds in the laboratory.

1.1.1 Test methods are described for two toxicity test organisms, the amphipod *Hyaella azteca* (*H. azteca*) (see 13.1.2) and the midge *Chironomus dilutus* (formerly known as *C. tentans*; Shobanov et al. 1999.(1) (see 14.1.2). The toxicity tests are conducted for 10 days in 300-mL chambers containing 100 mL of sediment and 175 mL of overlying water. Overlying water is renewed daily and test organisms are fed during the toxicity tests. Endpoints for the 10-day toxicity tests are survival and growth. These test methods describe procedures for testing freshwater sediments; however, estuarine sediments (up to 15 ppt salinity) can also be tested with *H. azteca*. In addition to the 10-day toxicity test method outlined in 13.1.2 and 14.1.2, general procedures are also described for conducting 10-day sediment toxicity tests with *H. azteca* (see 13.1.2) and *C. dilutus* (see 14.1.2).

NOTE 1—Morphological comparison of populations of *Chironomus* (*Camptochironomus*) *tentans*(Fabricius) from Europe, Asia, and North America have confirmed cytogenetic evidence that two distinct species inhabit the Palearctic and Nearctic under this name. The Palearctic species is the true *C. tentans* and the Nearctic populations constitute a new species described under the name *Chironomus* (*Camptochironomus*) *dilutus* (Shobanov et al. 1999 (1)).”

1.1.2 Guidance for conducting sediment toxicity tests is outlined in Annex A1 for *Chironomus riparius*, in Annex A2 for *Daphnia magna* and *Ceriodaphnia dubia*, in Annex A3 for *Hexagenia* spp., in Annex A4 for *Tubifex tubifex*, and in Annex A5 for the *Diporeia* spp. Guidance is also provided in Annex A6 for conducting long-term sediment toxicity tests with *H. azteca* by measuring effects on survival, growth, and reproduc-

tion. Guidance is also provided in Annex A7 for conducting long-term sediment toxicity tests with *C. dilutus* by measuring effects on survival, growth, emergence, and reproduction. 1.6 outlines the data that will be needed before test methods are developed from the guidance outlined in Annex A1 to Annex A7 for these test organisms. General procedures described in Sections 1 – 14 for sediment testing with *H. azteca* and *C. dilutus* are also applicable for sediment testing with the test organisms described in Annex A1 to Annex A7.

1.2 Procedures outlined in this test method are based primarily on procedures described in the United States Environmental Protection Agency (USEPA) (2-9)<sup>2</sup>, Test Method E1367, and Guides E1391, E1525 and E1688.

1.3 Additional research and methods development are now in progress to: (1) evaluate additional test organisms, (2) further evaluate the use of formulated sediment, (3) refine sediment dilution procedures, (4) refine sediment toxicity identification evaluation (TIE) procedures (10), (5) refine sediment spiking procedures, (6) develop *in situ* toxicity tests to assess sediment toxicity and bioaccumulation under field conditions, (7) evaluate relative sensitivities of endpoints measured in tests, (8) develop methods for new species, (9) evaluate relationships between toxicity and bioaccumulation, and (10) produce additional data on confirmation of responses in laboratory tests with natural populations of benthic organisms. Some issues that may be considered in interpretation of test results are the subject of continuing research including the influence of feeding on bioavailability, nutritional requirements of the test organisms, and additional performance criteria for organism health. See Section 6 for additional detail. This information will be described in future editions of this standard.

1.4 The USEPA (2) and Guide E1688 also describes 28-day bioaccumulation methods for the oligochaete *Lumbriculus variegatus*.

1.5 Results of tests, even those with the same species, using procedures different from those described in the test method may not be comparable and using these different procedures

<sup>1</sup> This test method is under the jurisdiction of ASTM Committee E50 on Environmental Assessment, Risk Management and Corrective Action and are the direct responsibility of Subcommittee E50.47 on Biological Effects and Environmental Fate.

Current edition approved Sept. 1, 2010. Published January 2011. Originally approved in 1995. Last previous edition approved in 2005 as E1706 – 05<sup>ε1</sup>. DOI: 10.1520/E1706-05R10.

<sup>2</sup> The boldface numbers in parentheses refer to the list of references at the end of this standard.

\*A Summary of Changes section appears at the end of this standard

may alter bioavailability. Comparison of results obtained using modified versions of these procedures might provide useful information concerning new concepts and procedures for conducting sediment tests with aquatic organisms. If tests are conducted with procedures different from those described in this test method, additional tests are required to determine comparability of results. General procedures described in this test method might be useful for conducting tests with other aquatic organisms; however, modifications may be necessary.

1.6 Selection of Toxicity Testing Organisms:

1.6.1 The choice of a test organism has a major influence on the relevance, success, and interpretation of a test. Furthermore, no one organism is best suited for all sediments. The following criteria were considered when selecting test organisms to be described in this standard (Table 1 and Guide E1525). A test organism should: (1) have a toxicological data base demonstrating relative sensitivity and discrimination to a range of chemicals of concern in sediment, (2) have a database for interlaboratory comparisons of procedures (for example, round-robin studies), (3) be in contact with sediment [e.g., water column vs benthic organisms], (4) be readily available through culture or from field collection, (5) be easily maintained in the laboratory, (6) be easily identified, (7) be ecologically or economically important, (8) have a broad geographical distribution, be indigenous (either present or historical) to the site being evaluated, or have a niche similar to organisms of concern, (for example, similar feeding guild or behavior to the indigenous organisms), (9) be tolerant of a broad range of sediment physico-chemical characteristics (for example, grain size), and (10) be compatible with selected exposure methods and endpoints. The method should also be (11) peer reviewed and (12) confirmed with responses with natural populations of benthic organisms (see 1.6.8).

1.6.2 Of the criteria outlined in Table 1, a data base demonstrating relative sensitivity to contaminants, contact with sediment, ease of culture in the laboratory, interlaboratory comparisons, tolerance of varying sediment physico-chemical characteristics, and confirmation with responses of natural benthos populations were the primary criteria used for selecting *H. azteca* and *C. dilutus* to be described as test methods in

the current version of this standard (see Sections 13 and 14). Procedures for conducting sediment tests with organisms in accordance with Annex A1 to Annex A7 do not currently meet all the required selection criteria listed in Table 1. A similar data base must be developed before these or other test organisms can be included as standard test methods instead of as guidance in future versions of these this method.

1.6.3 An important consideration in the selection of specific species for test method development is the existence of information concerning relative sensitivity of the organisms both to single chemicals and complex mixtures. A number of studies have evaluated the sensitivity of *H. azteca*, *C. dilutus*, and *L. variegatus*, relative to one another, as well as other commonly tested freshwater species. For example, Ankley et al (11) found *H. azteca* to be as, or slightly more, sensitive than *Ceriodaphnia dubia* to a variety of sediment elutriate and pore-water samples. In that study, *L. variegatus* were less sensitive to the samples than either the amphipod or the cladoceran. West et al (12) found the rank sensitivity of the three species to the lethal effects of copper in sediments from the Keweenaw Waterway, MI was (from greatest to least): *H. azteca* > *C. dilutus* > *L. variegatus*. In short-term (48 to 96 h) exposures, *L. variegatus* generally was less sensitive than *H. azteca*, *C. dubia*, or *Pimephales promelas* to cadmium, nickel, zinc, copper, and lead (13). Of the latter three species, no one species was consistently the most sensitive to the five metals.

1.6.3.1 In a study of contaminated Great Lakes sediment, *H. azteca*, *C. dilutus*, and *C. riparius* were among the most sensitive and discriminatory of 24 organisms tested (14-17). Kemble et al (18) found the rank sensitivity of four species to metal-contaminated sediments from the Clark Fork River, MT to be (from greatest to least): *H. azteca* > *C. riparius* > *Oncorhynchus mykiss* (rainbow trout) > *Daphnia magna*. Relative sensitivity of the three endpoints evaluated in the *H. azteca* test with Clark Fork River sediments was (from greatest to least): length > sexual maturation > survival.

1.6.3.2 In 10-day water-only and whole-sediment tests, *Hyalella azteca* and *C. dilutus* were more sensitive than *D. magna* to fluoranthene-spiked sediment (19).

TABLE 1 Rating of Selection Criteria for Freshwater Sediment Toxicity Testing Organisms. A “+” or “-” Rating Indicates a Positive or Negative Attribute (“NA” = Not Applicable)

Criterion	<i>Hyalella azteca</i>	<i>Diporeia spp.</i>	<i>Chironomus dilutus</i>	<i>Chironomus riparius</i>	<i>Lumbriculus variegatus</i>	<i>Tubifex tubifex</i>	<i>Hexagenia spp.</i>	Molluscs	<i>Daphnia spp.</i> and <i>Ceriodaphnia spp.</i>
Relative sensitivity toxicity data base	+	-	+	-	+	-	-	-	-
Round-robin studies conducted	+	-	+	-	-	-	-	-	-
Contact with sediment	+	+	+	+	+	+	+	+	-
Laboratory culture	+	-	+	+	+	+	-	-	+
Taxonomic identification	+	+/-	+/-	+/-	+	+	+	+	+
Ecological importance	+	+	+	+	+	+	+	+	+
Geographical distribution	+	+/-	+	+	+	+	+	+	+/-
Sediment physicochemical tolerance	+	+	+/-	+	+	+	-	+	NA
Response confirmed with benthos populations	+	+	+	+	+	+	+	-	+
Peer reviewed	+	+	+	+	+	+	+	-	+/-
Endpoints monitored	S,G,M	S,B,A	S,G,E	S,G,E	B,S	S,R	S,G	B	S,G,R

S = survival, G = Growth, B = Bioaccumulation, A = avoidance  
R = Reproduction, M = Maturation, E = Emergence

1.6.3.3 Ten-day, water-only tests also have been conducted with a number of chemicals using *H. azteca*, *C. dilutus*, and *L. variegatus* ((19) and Table 2). These tests all were flow-through exposures using a soft natural water (Lake Superior) with measured chemical concentrations that, other than the absence of sediment, were conducted under conditions (for example, temperature, photoperiod, feeding) similar to those being described for the standard 10-day sediment test in 13.1.2. In general, *H. azteca* was more sensitive to copper, zinc, cadmium, nickel, and lead than either *C. dilutus* or *L. variegatus*. *Chironomus dilutus* and *H. azteca* exhibited a similar sensitivity to several of the pesticides tested. *Lumbriculus variegatus* was not tested with several of the pesticides; however, in other studies with whole sediments contaminated by dichlorodiphenyltrichloroethane (DDT) and associated metabolites, and in short-term (96-h) experiments with organophosphate insecticides (diazinon, chlorpyrifos), *L. variegatus* has proved to be far less sensitive than either *H. azteca* or *C. dilutus*. These results highlight two important points germane to these test methods. First, neither of the two test species selected for estimating sediment toxicity (*H. azteca*, *C. dilutus*) was consistently most sensitive to all chemicals, indicating the importance of using multiple test organisms when performing sediment assessments. Second, *L. variegatus* appears to be relatively insensitive to most of the test chemicals, which perhaps is a positive attribute for an organism used for bioaccumulation testing (9).

1.6.3.4 Using the data from Table 2, sensitivity of *H. azteca*, *C. dilutus*, and *L. variegatus* can be evaluated relative to other freshwater species. For this analysis, acute and chronic toxicity data from water quality criteria (WQC) documents for copper, zinc, cadmium, nickel, lead, DDT, dieldrin, and chlorpyrifos, and toxicity information from the AQUIRE data base (20) for 1,1-dichloro-2,2-bis(p-chlorophenyl)ethane (DDD) and dichlorodiphenyldichloroethylene (DDE), were compared to assay results for the three species (19). The sensitivity of *H. azteca* to metals and pesticides, and *C. dilutus* to pesticides was comparable to chronic toxicity data generated for other test species. This was not completely unexpected given that the 10-day exposures used for these two species are likely more similar to chronic partial life-cycle tests than the 48 to 96-h exposures traditionally defined as acute in the WQC documents.

**TABLE 2 Water-Only, 10-Day LC50 (µg/L) Values for *Hyalella azteca*, *Chironomus dilutus*, and *Lumbriculus variegatus* for Chemicals Tested at ERL-Duluth in Soft Water (Hardness 40 mg/L as CaCO<sub>3</sub>; (19))**

Chemical	<i>H. azteca</i>	<i>C. dilutus</i>	<i>L. variegatus</i>
Copper	35	54	35
Zinc	73	1125 <sup>1</sup>	2984
Cadmium	2.8 <sup>2</sup>	NT <sup>3</sup>	158
Nickel	780	NT	12 160
Lead	<16	NT	794
p,p'-DDT	0.07	1.23	NT
p,p'-DDD	0.17	0.18	NT
p,p'-DDE	1.39	3.0	>3.3
Dieldrin	7.6	1.1	NT
Chlorpyrifos	0.086	0.07	NT

<sup>1</sup> 50 % mortality at highest concentration tested.

<sup>2</sup> 70 % mortality at lowest concentration tested.

<sup>3</sup> NT, not tested.

Interestingly, in some instances (for example, dieldrin and chlorpyrifos), LC50 data generated for *H. azteca* or *C. dilutus* were comparable to or lower than any reported for other freshwater species in the WQC documents. This observation likely is a function not only of the test species, but of the test conditions; many of the tests on which early WQC were based were static, rather than flow-through, and report unmeasured contaminant concentrations.

1.6.3.5 Measurable concentrations of ammonia are common in the pore water of many sediments and have been found to be a common cause of toxicity in pore water (21, 22, 23). Acute toxicity of ammonia to *H. azteca*, *C. dilutus*, and *L. variegatus* has been evaluated in several studies. As has been found for many other aquatic organisms, the toxicity of ammonia to *C. dilutus* and *L. variegatus* has been shown to be dependent on pH. Four-day LC50 values for *L. variegatus* in water-column (no sediment) exposures ranged from 390 to 6.6 mg/L total ammonia as pH was increased from 6.3 to 8.6 Schubauer-Berigan et al.(24). For *C. dilutus*, 4-day LC50 values ranged from 370 to 82 mg/L total ammonia over a similar pH range (Schubauer-Berigan et al.) (24). Ankley et al. (25) reported that the toxicity of ammonia to *H. azteca* (also in water-only exposures) showed differing degrees of pH-dependence in different test waters. In soft reconstituted water, toxicity was not pH dependent, with 4-day LC50 values of about 20 mg/L at pH ranging from 6.5 to 8.5. In contrast, ammonia toxicity in hard reconstituted water exhibited substantial pH dependence with LC50 values decreasing from >200 to 35 mg/L total ammonia over the same pH range. Borgmann and Borgmann (26) later showed that the variation in ammonia toxicity across these waters could be attributed to differences in sodium and potassium content, which appear to influence the toxicity of ammonia to *H. azteca*.

(1) Although these studies provide benchmark concentrations that may be of concern in sediment pore waters, additional studies by Whiteman et al. (27) indicated that the relationship between water-only LC50 values and those measured in sediment exposures differs among organisms. In sediment exposures, the 10-day LC50 for *L. variegatus* and *C. dilutus* occurred when sediment pore water reached about 150 % of the LC50 determined from water-only exposures. However, experiments with *H. azteca* showed that the 10-day LC50 was not reached until pore water concentrations were nearly 10× the water-only LC50, at which time the ammonia concentration in the overlying water was equal to the water-only LC50. The authors attribute this discrepancy to avoidance of sediment by *H. azteca*. Thus, it appears that water-only LC50 values may provide suitable screening values for potential ammonia toxicity, higher concentrations may be necessary to actually induce ammonia toxicity in sediment exposures, particularly for *H. azteca*. Further, these data underscore the importance of measuring the pH of pore water when ammonia toxicity may be of concern. Ankley Schubauer-Berigan (28) and Besser et al. (29) describe procedures for conducting toxicity identification evaluations (TIEs) for pore-water or whole-sediment samples to determine if ammonia is contributing to the toxicity of sediment samples.

1.6.4 Relative species sensitivity frequently varies among chemicals; consequently, a battery of tests including organisms representing different trophic levels may be needed to assess sediment quality (14, 17, 30-33). For example, Reish (34) reported the relative toxicity of six metals (arsenic, cadmium, chromium, copper, mercury, and zinc) to crustaceans, polychaetes, pelecypods, and fishes and concluded that no one species or group of test organisms was the most sensitive to all of the metals.

1.6.4.1 Sensitivity of a species to chemicals is also dependent on the duration of the exposure and the endpoints evaluated. Annex A6 and Annex A7 describe results of studies which demonstrate the utility of measuring sublethal endpoints in sediment toxicity tests with the amphipod *H. azteca* and the midge *C. dilutus*.

1.6.5 The sensitivity of an organism to chemicals should be balanced with the concept of discrimination (14). The response of a test organism should provide discrimination between different levels of contamination. However, insensitive organisms may be preferred for determining bioaccumulation. The use of indigenous organisms that are ecologically important and easily collected is often very straightforward; however, indigenous organisms at a site may be insensitive to the chemicals of concern. Indigenous organisms might be more important for evaluation of bioaccumulation (9). See Guides E1525, E1688, and E1850 for additional detail on selection of test organisms.

1.6.6 Sensitivity of an organism is related to route of exposure and biochemical sensitivity to chemicals. Sediment-dwelling organisms can receive a dose from three primary sources: interstitial water, sediment particles, and overlying water. Food type, feeding rate, assimilation efficiency, and clearance rate will control the dose of chemicals from sediment (Guide E1688). Benthic invertebrates often selectively consume different particle sizes (35) or particles with higher organic carbon concentrations which may have higher chemical concentrations. Detrital feeders may receive most of their body burden directly from sediment ingestion. In amphipods (36) and clams (37) uptake through the gut can exceed uptake across the gills for certain hydrophobic compounds. Organisms in direct contact with sediment may also accumulate chemicals by direct adsorption to the body wall or by absorption through the integument (38).

1.6.7 Despite the potential complexities in estimating the dose that an animal receives from sediment, the toxicity and bioaccumulation of many chemicals in sediment such as chlordecone, fluoranthene, organochlorines, and metals have been correlated with either the concentration of these chemicals in interstitial water or in the case of nonionic organic chemicals, concentrations of an organic-carbon basis (39, 40). The relative importance of whole sediment and interstitial water routes of exposure depends on the test organism and the specific contaminant (35, 38). Because benthic communities contain a diversity of organisms, many combinations of exposure routes may be important. Therefore, behavior and feeding habits of a test organism can influence its ability to accumulate contaminants from sediment and should be considered when selecting test organisms for sediment testing.

1.6.8 The response of *H. azteca* and *C. dilutus* in laboratory toxicity studies has been compared to the response of natural populations of benthic organisms to potentially contaminated sediments.

1.6.8.1 Chironomids were not found in sediment samples that decreased the growth of *C. dilutus* by 30 % or more in 10-day laboratory toxicity tests (41). Wentsel et al (42-44) reported a correlation between effects on *C. dilutus* in laboratory tests and the abundance of *C. dilutus* in metal-contaminated sediments.

1.6.8.2 Canfield et al. (45,46,47) evaluated the composition of benthic invertebrate communities in sediments for the following areas: (1) three Great Lakes Areas of Concern (AOC; Buffalo River, NY; Indiana Harbor, IN; Saginaw River, MI), (2) the upper Mississippi River, and (3) the Clark Fork River located in Montana. Results of these benthic community assessments were compared to sediment chemistry and toxicity (28-day sediment exposures with *H. azteca* which monitored effects on survival, growth, and sexual maturation). Good concordance was evident between measures of laboratory toxicity, sediment contamination, and benthic invertebrate community composition in extremely contaminated samples. However, in moderately contaminated samples, less concordance was observed between the composition of the benthic community and either laboratory toxicity test results or sediment contaminant concentration. Laboratory sediment toxicity tests better identified chemical contamination in sediments compared to many of the commonly used measures of benthic invertebrate community composition. Benthic measures may reflect other factors such as habitat alteration in addition to responding to contaminants. Canfield et al. (45, 46, 47) identified the need to better evaluate non-contaminant factors (i.e., TOC, grain size, water depth, habitat alteration) in order to better interpret the response of benthic invertebrates to sediment contamination.

1.6.8.3 Results from laboratory sediment toxicity tests were compared to colonization of artificial substrates exposed *in situ* to Great Lakes sediment (14) Burton et al. (17) Survival or growth of *H. azteca* and *C. dilutus* in 10–28-day laboratory exposures were negatively correlated to percent chironomids and percent tolerant taxa colonizing artificial substrates in the field. Schlekot et al (48) reported general good agreement between sediment toxicity tests with *H. azteca* and benthic community responses in the Anacostia River in Washington, DC.

1.6.8.4 Sediment toxicity with amphipods in 10-day toxicity tests, field contamination, and field abundance of benthic amphipods were examined along a sediment contamination gradient of DDT (48). Survival of *Eohaustorius estuarius*, *Rhepoxynius abronius*, and *H. azteca* in laboratory toxicity tests was positively correlated to abundance of amphipods in the field and negatively correlated to DDT concentrations. The threshold for 10-day sediment toxicity in laboratory studies was about 300 µg DDT (+metabolites)/g organic carbon. The threshold for abundance of amphipods in the field was about 100 µg DDT (+metabolites)/g organic carbon. Therefore, correlations between toxicity, contamination, and field populations indicate that short-term sediment toxicity tests can

provide reliable evidence of biologically adverse sediment contamination in the field, but may be underprotective of sublethal effects.

1.7 *Limitations*— While some safety considerations are included in this standard, it is beyond the scope of this standard to encompass all safety requirements necessary to conduct sediment tests.

1.8 *This standard is arranged as follows:*

1	Scope
2	Referenced Documents
3	Terminology
4	Summary of Standard
5	Significance and Use
6	Interferences
7	Reagents and Materials
8	Hazards
9	Facilities, Equipment, and Supplies
10	Sample Collection, Storage, Manipulation, and Characterization
11	Quality Assurance and Quality Control
12	Collection, Culturing, and Maintaining Test Organisms
13	Procedure 1: Conducting a 10-day Sediment Toxicity Test with <i>Hyalella azteca</i>
14	Procedure 2: Conducting a 10-day Sediment Toxicity Test with <i>Chironomus dilutus</i>
15	Calculation
16	Report
17	Precision and Bias
18	Keywords

#### Annexes

A1.	Guidance for Conducting Sediment Toxicity Tests with <i>Chironomus riparius</i>
A2.	Guidance for Conducting Sediment Toxicity Tests with <i>Daphnia magna</i> and <i>Ceriodaphnia dubia</i>
A3.	Guidance for Conducting Sediment Toxicity Tests with <i>Hexagenia spp.</i>
A4.	Guidance for Conducting Sediment Toxicity Tests with <i>Tubifex tubifex</i>
A5.	Guidance for Conducting Sediment Toxicity Tests with <i>Diporeia spp.</i>
A6.	Guidance for Conducting a Hyalella Azteca 42-day Test for Measuring Effects of Sediment-Associated Contaminants on Survival, Growth, and Reproduction
A7.	Guidance for Conducting a Life-Cycle Test for Measuring Effects of Sediment-Associated Contaminants on <i>Chironomus dilutus</i> .
A8.	Food Preparation
A9.	Feeding Rate for the 10-day Sediment Toxicity Test Method with <i>Chironomus dilutus</i>
	References

1.9 *This standard does not purport to address all of the safety concerns, if any, associated with its use. It is the responsibility of the user of this standard to establish appropriate safety and health practices and determine the applicability of regulatory limitations prior to use.* Specific hazard statements are given in Section 8.

## 2. Referenced Documents

### 2.1 ASTM Standards:<sup>3</sup>

**D1129 Terminology Relating to Water**

**D4387 Guide for Selecting Grab Sampling Devices for Collecting Benthic Macroinvertebrates (Withdrawn 2003)<sup>4</sup>**

**D4447 Guide for Disposal of Laboratory Chemicals and Samples**

<sup>3</sup> For referenced ASTM standards, visit the ASTM website, [www.astm.org](http://www.astm.org), or contact ASTM Customer Service at [service@astm.org](mailto:service@astm.org). For *Annual Book of ASTM Standards* volume information, refer to the standard's Document Summary page on the ASTM website.

<sup>4</sup> The last approved version of this historical standard is referenced on [www.astm.org](http://www.astm.org).

**E29 Practice for Using Significant Digits in Test Data to Determine Conformance with Specifications**

**E105 Practice for Probability Sampling of Materials**

**E122 Practice for Calculating Sample Size to Estimate, With Specified Precision, the Average for a Characteristic of a Lot or Process**

**E141 Practice for Acceptance of Evidence Based on the Results of Probability Sampling**

**E177 Practice for Use of the Terms Precision and Bias in ASTM Test Methods**

**E178 Practice for Dealing With Outlying Observations**

**E456 Terminology Relating to Quality and Statistics**

**E691 Practice for Conducting an Interlaboratory Study to Determine the Precision of a Test Method**

**E729 Guide for Conducting Acute Toxicity Tests on Test Materials with Fishes, Macroinvertebrates, and Amphibians**

**E943 Terminology Relating to Biological Effects and Environmental Fate**

**E1193 Guide for Conducting *Daphnia magna* Life-Cycle Toxicity Tests**

**E1241 Guide for Conducting Early Life-Stage Toxicity Tests with Fishes**

**E1295 Guide for Conducting Three-Brood, Renewal Toxicity Tests with *Ceriodaphnia dubia***

**E1325 Terminology Relating to Design of Experiments**

**E1367 Test Method for Measuring the Toxicity of Sediment-Associated Contaminants with Estuarine and Marine Invertebrates**

**E1391 Guide for Collection, Storage, Characterization, and Manipulation of Sediments for Toxicological Testing and for Selection of Samplers Used to Collect Benthic Invertebrates**

**E1402 Guide for Sampling Design**

**E1525 Guide for Designing Biological Tests with Sediments**

**E1688 Guide for Determination of the Bioaccumulation of Sediment-Associated Contaminants by Benthic Invertebrates**

**E1847 Practice for Statistical Analysis of Toxicity Tests Conducted Under ASTM Guidelines**

**E1850 Guide for Selection of Resident Species as Test Organisms for Aquatic and Sediment Toxicity Tests**

**IEEE/ASTM-SI-10 Standard for Use of the International System of Units (SI):The Modern Metric System**

## 3. Terminology

3.1 The words “must”, “should”, “may”, “can”, and “might” have very specific meanings in this standard. “Must” is used to express an absolute requirement, that is, to state that a test ought to be designed to satisfy the specified conditions, unless the purpose of the test requires a different design. “Must” is used only in connection with the factors that relate directly to the acceptability of a test. “Should” is used to state that the specified condition is recommended and ought to be met if possible. Although the violation of one “should” is rarely a serious matter, violation of several will often render the results questionable. Terms such as “is desirable,” “is often desirable,” and “might be desirable” are used in connection with less important factors. “May” is used to mean “is (are) allowed

to,” “can” is used to mean “is (are) able to,” and “might” is used to mean “could possibly.” Thus, the classic distinction between “may” and “can” is preserved, and “might” is never used as a synonym for either “may” or “can.”

**3.2 Definitions**— For definitions of other terms used in this test method, refer to Guides [E729](#) and [E1241](#) and Terminology [E943](#) and [D1129](#). For an explanation of units and symbols, refer to [IEEE/ASTM-SI-10](#).

**3.3 Definitions of Terms Specific to This Standard:**

**3.3.1 clean**—denotes a sediment or water that does not contain concentrations of test materials which cause apparent stress to the test organisms or reduce their survival.

**3.3.2 concentration**—the ratio of weight or volume of test material(s) to the weight or volume of sediment.

**3.3.3 contaminated sediment**—sediment containing chemical substances at concentrations that pose a known or suspected threat to environmental or human health.

**3.3.4 control sediment**—a sediment that is essentially free of contaminants and is used routinely to assess the acceptability of a test. Any contaminants in control sediment may originate from the global spread of pollutants and does not reflect any substantial input from local or non-point sources. Comparing test sediments to control sediments is a measure of the toxicity of a test sediment beyond inevitable background contamination.

**3.3.5 EC50**—a statistically or graphically estimated concentration that is expected to cause one or more specified effects in 50 % of a group of organisms under specified conditions.

**3.3.6 Formulated sediment**—Mixtures of materials used to mimic the physical components of a natural sediment.

**3.3.7 IC50**—a point estimate of the toxicant concentration that would cause a 50 % reduction in a non-quantal measurement such as fecundity or growth.

**3.3.8 interstitial water or pore water**—water occupying space between sediment or soil particles.

**3.3.9 LC50**—a statistically or graphically estimated concentration that is expected to be lethal to 50 % of a group of organisms under specified conditions.

**3.3.10 lowest-observable-effect concentration (LOEC)**—in a toxicity test, the lowest tested concentration of a material at which organisms were adversely affected compared to control organisms as determined by statistical hypothesis tests—should be accompanied by a description of the statistical tests and alternative hypotheses, levels of significance, and measures of performance, for example, survival, growth, reproduction, or development—and must be above any other concentration not producing statistically significant adverse effects.

**3.3.11 no-observable-effect concentration (NOEC)**— in a toxicity test, the highest tested concentration of a material at which organisms did as well as control organisms as determined by statistical hypothesis tests—should be accompanied by a description of the statistical tests and alternative hypotheses, levels of significance, and measures of performance, for example, survival, growth, reproduction, or

development—and must be below any other concentration producing statistically significant adverse effects.

**3.3.12 overlying water**—the water placed over sediment in a test chamber during a test.

**3.3.13 reference sediment**—a whole sediment near an area of concern used to assess sediment conditions exclusive of material(s) of interest. The reference sediment may be used as an indicator of localized sediment conditions exclusive of the specific pollutant input of concern. Such sediment would be collected near the site of concern and would represent the background conditions resulting from any localized pollutant inputs as well as global pollutant input. This is the manner in which reference sediment is used in dredge material evaluations.

**3.3.14 reference-toxicity test**—a test conducted with reagent-grade reference chemical to assess the sensitivity of the test organisms. Deviations outside an established normal range may indicate a change in the sensitivity of the test organism population. Reference-toxicity tests are most often performed in the absence of sediment.

**3.3.15 sediment**—particulate material that usually lies below water. Formulated particulate material that is intended to lie below water in a test.

**3.3.16 spiked sediment**—a sediment to which a material has been added for experimental purposes.

**3.3.17 whole sediment**—sediment and associated pore water which have had minimal manipulation. The term bulk sediment has been used synonymously with whole sediment.

## 4. Summary of Standard

**4.1 Method Description**—Procedures are described for testing freshwater organisms in the laboratory to evaluate the toxicity of contaminants associated with whole sediments. Sediments may be collected from the field or spiked with compounds in the laboratory.

**4.1.1 Test methods** are described for conducting toxicity tests with two organisms: the amphipod *Hyaella azteca* (see [13.1.2](#)) and the midge *Chironomus dilutus* (formerly known as *C. tentans*; Shobanov et al. 1999.(1), (see [14.1.2](#)). The toxicity tests are conducted for 10 days in 300-mL chambers containing 100 mL of sediment and 175 mL of overlying water. Overlying water is renewed daily and test organisms are fed during the toxicity tests. Endpoints for the 10-day toxicity tests are survival and growth. Length or weight is reported as the average of the surviving organisms at the end of the test (Sections [13](#) and [14](#)). Another approach for reporting growth might be as biomass (dry weight of surviving organisms divided by the initial number of organisms). The rationale for evaluating biomass in toxicity testing is that small differences in either growth or survival may not be statistically significantly different from the control; however, a combined estimate of biomass may increase the statistical power of the test. While USEPA ([3](#)) recommend reporting biomass as a measure of growth in effluent toxicity tests, the approach has not yet been routinely applied in sediment testing. Therefore, biomass is not listed as a primary endpoint in the methods described in Sections [13](#) and [14](#) or in [Annex A1](#) to [Annex A7](#). The standard

describes procedures for testing freshwater sediments; however, estuarine sediments (up to 15 ppt salinity) can also be tested with *H. azteca*. In addition to the 10-day toxicity test methods outlined in 13.1.2 and 14.1.2, general procedures are also described for conducting sediment toxicity tests with *H. azteca* (see 13.1.2) and *C. dilutus* (see 14.1.2).

4.1.2 Guidance for conducting sediment toxicity tests is provided in Annex A1 for *Chironomus riparius*, in Annex A2 for *Daphnia magna* and *Ceriodaphnia dubia*, in Annex A3 for *Hexagenia spp.*, in Annex A4 for *Tubifex tubifex*, and in Annex A5 for the *Diporeia spp.*

4.1.3 Guidance for conducting long-term sediment toxicity tests with *H. azteca* by measuring effects on survival, growth, and reproduction is provided in Annex A6. The long-term sediment exposures with *H. azteca* are started with 7- to 8-day-old amphipods. On Day 28, amphipods are isolated from the sediment and placed in water-only chambers where reproduction is measured on Day 35 and 42. Endpoints measured in the long-term amphipod test include survival (Day 28, 35, and 42), growth (Day 28 and 42), and reproduction (number of young/female produced from Day 28 to 42). Guidance for conducting long-term sediment toxicity tests with *C. dilutus* by measuring effects on survival, growth, emergence, and reproduction is provided in Annex A7. The long-term sediment exposures with *C. dilutus* start with newly hatched larvae (<24-h old) and continue through emergence, reproduction, and hatching of the F<sub>1</sub> generation (about 60-day exposures). Survival and growth are determined at 20 day. Starting on Day 23 to the end of the test, emergence and reproduction of *C. dilutus* are monitored daily. The number of eggs/female is determined for each egg case, which is incubated for 6 day to determine hatching success.

4.1.3.1 The long-term toxicity testing methods for *Hyaella azteca* (Annex A6) and *Chironomus dilutus* (Annex A7) can be used to measure effects on reproduction as well as long-term survival and growth. Reproduction is a key variable influencing the long-term sustainability of populations (Rees and Crawley, (49)) and has been shown to provide valuable and sensitive information in the assessment of sediment toxicity Derr and Zabik, (50); Wentsel et al., (51); Williams et al., (52); Postma et al., (53); Sibley et al., (54), (55); Ingersoll et al., (56). Further, as concerns have emerged regarding the environmental significance of chemicals that can act directly or indirectly on reproductive endpoints (e.g., endocrine disrupting compounds), the need for comprehensive reproductive toxicity tests has become increasingly important. Reproductive endpoints measured in sediment toxicity tests with *H. azteca* and *C. dilutus* tend to be more variable compared to survival or growth (Section A6.4.6 and A7.5.4.6). Hence, additional replicates would be required to achieve the same statistical power as for survival and growth endpoints (Section 16). The procedures described in Annex A6 and Annex A7 include measurement of a variety of lethal and sublethal endpoints; minor modifications of the basic methods can be used in cases where only a subset of these endpoints is of interest (A6.1.3 and A7.1.2).

4.1.4 Paragraph 1.6 outlines the data that will be needed before test methods are developed from the guidance outlined for these test organisms in Annex A1 to Annex A7. General procedures described in Sections 1 to 14 for sediment testing with *H. azteca* and *C. dilutus* are also applicable for sediment testing with the test organisms described in Annex A1 to Annex A7.

4.2 *Experimental Design*—The following section is a general summary of experimental design. See Section 15 for additional detail.

#### 4.2.1 *Control and Reference Sediment:*

4.2.1.1 Sediment tests include a control sediment (sometimes called a negative control). A control sediment is a sediment that is essentially free of contaminants and is used routinely to assess the acceptability of a test and is not necessarily collected near the site of concern. Any contaminants in control sediment are thought to originate from the global spread of pollutants and do not reflect any substantial inputs from local or non-point sources (9). Comparing test sediments to control sediments is a measure of the toxicity of a test sediment beyond inevitable background contamination and organism health (9). A control sediment provides a measure of test acceptability, evidence of test organism health, and a basis for interpreting data obtained from the test sediments. A reference sediment is collected near an area of concern and is used to assess sediment conditions exclusive of material(s) of interest. Testing a reference sediment provides a site-specific basis for evaluating toxicity.

(1) In general, the performance of test organisms in the negative control is used to judge the acceptability of a test, and either the negative control or reference sediment may be used to evaluate performance in the experimental treatments, depending on the purpose of the study. Any study in which organisms in the negative control do not meet performance criteria must be considered questionable because it suggests that adverse factors affected the response of test organisms. Key to avoiding this situation is using only control sediments that have a demonstrated record of performance using the same test procedure. This includes testing of new collections from sediment sources that have previously provided suitable control sediment.

(2) Because of the uncertainties introduced by poor performance in the negative control, such studies should be repeated to insure accurate results. However, the scope or sampling associated with some studies may make it difficult or impossible to repeat a study. Some researchers have reported cases where performance in the negative control is poor, but performance criteria are met in reference sediment included in the study design. In these cases, it might be reasonable to infer that other samples that show good performance are probably not toxic; however, any samples showing poor performance should not be judged to have shown toxicity, since it is unknown whether the adverse factors that caused poor control performance might have also caused poor performance in the test treatments.

4.2.1.2 Natural physico-chemical characteristics such as sediment texture may influence the response of test organisms (57). The physico-chemical characteristics of test sediment

need to be within the tolerance limits of the test organism. Ideally, the limits of a test organism should be determined in advance; however, controls for factors including grain size and organic carbon can be evaluated if the limits are exceeded in a test sediment. See [12.1](#) for information on physico-chemical requirements of test organisms. If the physico-chemical characteristics of a test sediment exceed the tolerance range of the test organism, a control sediment encompassing these characteristics can be evaluated. The effects of sediment characteristics on the results of sediment tests can be addressed with regression equations ([57](#), [58](#)). The use of formulated sediment can also be used to evaluate physico-chemical characteristics of sediment on test organisms ([59](#), [60](#), [61,62](#)).

4.2.2 The experimental design depends on the purpose of the study. Variables that need to be considered include the number and type of control sediments, the number of treatments and replicates, and water quality characteristics. For instance, the purpose of the study might be to determine a specific endpoint such as an LC50 and may include a control sediment, a positive control, a solvent control, and several concentrations of sediment spiked with a chemical (see Section [10.3.2](#)). A useful summary of field sampling design is presented by ([63](#)). See Section [15](#) for additional guidance on experimental design and statistics.

4.2.2.1 The purpose of the study might be to determine if field-collected sediments are toxic and may include controls, reference sediments, and test sediments. Controls are used to evaluate the acceptability of the test (see [13.3](#), [14.3](#), [Annex A1](#) to [Annex A7](#)) and might include a control sediment, a formulated sediment (Section [7.2](#)), a sand substrate (for *C. dilutus*; see [13.2](#), [A7.2](#)), or water-only exposures (for *H. azteca*; Section [A6.3.7.8](#)). Testing a reference sediment provides a site-specific basis for evaluating toxicity of the test sediments. Comparisons of test sediments to multiple reference or control sediments representative of the physical characteristics of the test sediment (i.e., grain size, organic carbon) may be useful in these evaluations. A summary of field sampling design is presented by Green ([63](#)). See Section [15](#) for additional guidance on experimental design and statistics.

4.2.2.2 If the purpose of the study is to conduct a reconnaissance field survey to identify sites for further investigation, the experimental design might include only one sample from each site to allow for sampling a larger area. The lack of replication at a site usually precludes statistical comparisons (for example, analysis of variance (ANOVA)), but these surveys can be used to identify sites for further study or may be evaluated using regression techniques.

4.2.2.3 In other instances, the purpose of the study might be to conduct a quantitative sediment survey of chemistry and toxicity to determine statistically significant differences between effects among control and test sediments from several sites. The number of replicates/site should be based on the need for sensitivity or power (see Section [15](#)). In a quantitative survey, field replicates (separate samples from different grabs collected at the same site) would need to be taken at each site. Chemical and physical characterizations of each of these grabs would be required for each of these field replicates used in sediment testing. Separate subsamples might be used to deter-

mine within-sample variability or for comparisons of test procedures (for example, comparative sensitivity among test organisms), but these subsamples cannot be considered to be true field replicates for statistical comparisons among sites.

4.2.2.4 Sediments often exhibit high spatial and temporal variability ([64](#)). Therefore, replicate samples may need to be collected to determine variance in sediment characteristics. Sediment should be collected with as little disruption as possible; however, subsampling, compositing, or homogenization of sediment samples may be required for some experimental designs.

4.2.2.5 Site locations might be distributed along a known pollution gradient, in relation to the boundary of a disposal site, or at sites identified as being contaminated in a reconnaissance survey. Comparisons can be made in both space and time. In pre-dredging studies, a sampling design can be prepared to assess the contamination of samples representative of the project area to be dredged. Such a design should include subsampling cores taken to the project depth.

4.2.2.6 The primary focus of the physical and experimental test design and statistical analysis of the data, is the experimental unit, which is defined as the smallest physical entity to which treatments can be independently assigned (Guide [E1241](#)). Because overlying water or air cannot flow from one test chamber to another the test chamber is the experimental unit. The experimental unit is defined as the smallest physical entity to which treatments can be independently assigned and to which air and water exchange between test chambers are kept to a minimum. Because of factors that might affect results within test chambers and results of a test, all test chambers should be treated as similarly as possible. Treatments should be randomly assigned to individual test chamber locations. Assignment of test organisms to test chambers should be impartial (see Guide [E729](#)). As the number of test chambers/treatment increases, the number of degrees of freedom increases, and, therefore, the width of the confidence interval on a point estimate, such as an LC50, decreases, and the power of a significance test increases (see Section [15](#)).

## 5. Significance and Use

### 5.1 General:

5.1.1 Sediment provides habitat for many aquatic organisms and is a major repository for many of the more persistent chemicals that are introduced into surface waters. In the aquatic environment, most anthropogenic chemicals and waste materials including toxic organic and inorganic chemicals eventually accumulate in sediment. Mounting evidences exists of environmental degradation in areas where USEPA Water Quality Criteria (WQC; ([65](#))) are not exceeded, yet organisms in or near sediments are adversely affected ([66](#)). The WQC were developed to protect organisms in the water column and were not directed toward protecting organisms in sediment. Concentrations of contaminants in sediment may be several orders of magnitude higher than in the overlying water; however, bulk sediment concentrations have not been strongly correlated to bioavailability ([67](#)). Partitioning or sorption of a compound between water and sediment may depend on many factors including: aqueous solubility, pH, redox, affinity for



sediment organic carbon and dissolved organic carbon, grain size of the sediment, sediment mineral constituents (oxides of iron, manganese, and aluminum), and the quantity of acid volatile sulfides in sediment (40, 41). Although certain chemicals are highly sorbed to sediment, these compounds may still be available to the biota. Chemicals in sediments may be directly toxic to aquatic life or can be a source of chemicals for bioaccumulation in the food chain.

5.1.2 The objective of a sediment test is to determine whether chemicals in sediment are harmful to or are bioaccumulated by benthic organisms. The tests can be used to measure interactive toxic effects of complex chemical mixtures in sediment. Furthermore, knowledge of specific pathways of interactions among sediments and test organisms is not necessary to conduct the tests (68). Sediment tests can be used to: (1) determine the relationship between toxic effects and bioavailability, (2) investigate interactions among chemicals, (3) compare the sensitivities of different organisms, (4) determine spatial and temporal distribution of contamination, (5) evaluate hazards of dredged material, (6) measure toxicity as part of product licensing or safety testing, (7) rank areas for clean up, and (8) estimate the effectiveness of remediation or management practices.

5.1.3 A variety of methods have been developed for assessing the toxicity of chemicals in sediments using amphipods, midges, polychaetes, oligochaetes, mayflies, or cladocerans (Section 13 and 14; Annex A1 to Annex A5; (2), (4), (69), (70)). Several endpoints are suggested in these methods to measure potential effects of contaminants in sediment including survival, growth, behavior, or reproduction; however, survival of test organisms in 10-day exposures is the endpoint most commonly reported. These short-term exposures which only measure effects on survival can be used to identify high levels of contamination in sediments, but may not be able to identify moderate levels of contamination in sediments (USEPA (2); Sibley et al., (54); Sibley et al., (55); Sibley et al., (71); Benoit et al., (72); Ingersoll et al., (56)). Sublethal endpoints in sediment tests might also prove to be better estimates of responses of benthic communities to contaminants in the field (18). The previous version of this standard (Test Method E1706-95b) described 10-day toxicity tests with the amphipod *Hyalella azteca* and midge *Chironomus dilutus* (formerly known as *C. tentans*; Shobanov et al. 1999.(1), (see Section 13 and 14). This version of the standard now outlines approaches for evaluating sublethal endpoints in longer-term sediment exposures with these two species (Annex A6 and Annex A7).

5.1.3.1 The decision to conduct short-term or long-term toxicity tests depends on the goal of the assessment. In some instances, sufficient information may be gained by measuring sublethal endpoints in 10-day tests. In other instances, the 10-day tests could be used to screen samples for toxicity before long-term tests are conducted. While the long-term tests are needed to determine direct effects on reproduction, measurement of growth in these toxicity tests may serve as an indirect estimate of reproductive effects of contaminants associated with sediments (A6.4.5 and A7.4.6.2). Additional studies are ongoing to more thoroughly evaluate the relative sensitivity between lethal and sublethal endpoints measured in 10-day

tests (Sections 13 and 14) and between sublethal endpoints measured in the long-term tests. Results of these studies and additional applications of the methods described in Annex A6 and Annex A7 will provide data that can be used to assist in determining where application of long-term tests will be most appropriate.

5.1.3.2 Use of sublethal endpoints for assessment of contaminant risk is not unique to toxicity testing with sediments. Numerous regulatory programs require the use of sublethal endpoints in the decision-making process (Pittinger and Adams (73)) including: (1) Water Quality Criteria (and State Standards); (2) National Pollution Discharge Elimination System (NPDES) effluent monitoring (including chemical-specific limits and sublethal endpoints in toxicity tests); (3) Federal Insecticide, Rodenticide and Fungicide Act (FIFRA) and the Toxic Substances Control Act (TSCA, tiered assessment includes several sublethal endpoints with fish and aquatic invertebrates); (4) Superfund (Comprehensive Environmental Responses, Compensation and Liability Act; CERCLA); (5) Organization of Economic Cooperation and Development (OECD, sublethal toxicity testing with fish and invertebrates); (6) European Economic Community (EC, sublethal toxicity testing with fish and invertebrates); and (7) the Paris Commission (behavioral endpoints).

5.1.4 Results of toxicity tests on sediments spiked at different concentrations of chemicals can be used to establish cause and effect relationships between chemicals and biological responses. Results of toxicity tests with test materials spiked into sediments at different concentrations may be reported in terms of an LC50 (median lethal concentration), an EC50 (median effect concentration), an IC50 (inhibition concentration), or as a NOEC (no observed effect concentration) or LOEC (lowest observed effect concentration). However, spiked sediment may not be representative of chemicals associated with sediment in the field. Mixing time (74), aging (36, 75, 76), and the chemical form of the material can affect responses of test organisms in spiked sediment tests.

5.1.5 Evaluating effect concentrations for chemicals in sediment requires knowledge of factors controlling their bioavailability. Similar concentrations of a chemical in units of mass of chemical per mass of sediment dry weight often exhibit a range in toxicity in different sediments (39, 40). Effect concentrations of chemicals in sediment have been correlated to interstitial water concentrations, and effect concentrations in interstitial water are often similar to effect concentrations in water-only exposures. The bioavailability of nonionic organic compounds in sediment is often inversely correlated with the organic carbon concentration. Whatever the route of exposure, these correlations of effect concentrations to interstitial water concentrations indicate that predicted or measured concentrations in interstitial water can be used to quantify the exposure concentration to an organism. Therefore, information on partitioning of chemicals between solid and liquid phases of sediment is useful for establishing effect concentrations (40).

5.1.6 Field surveys can be designed to provide either a qualitative reconnaissance of the distribution of sediment contamination or a quantitative statistical comparison of contamination among sites.

5.1.7 Surveys of sediment toxicity are usually part of more comprehensive analyses of biological, chemical, geological, and hydrographic data. Statistical correlations may be improved and sampling costs may be reduced if subsamples are taken simultaneously for sediment tests, chemical analyses, and benthic community structure.

5.1.8 Table 3 lists several approaches the USEPA has considered for the assessment of sediment quality (77). These approaches include: (1) equilibrium partitioning, (2) tissue residues, (3) interstitial water toxicity, (4) whole-sediment toxicity and sediment-spiking tests, (5) benthic community structure, (6) effect ranges (for example, effect range median, ERM), and (7) sediment quality triad (see (78-81) for a critique of these methods). The sediment assessment approaches listed in Table 3 can be classified as numeric (for example, equilibrium partitioning), descriptive (for example, whole-sediment toxicity tests), or a combination of numeric and descriptive approaches (for example, ERM, (82). Numeric methods can be used to derive chemical-specific sediment quality guidelines (SQGs). Descriptive methods such as toxicity tests with field-collected sediment cannot be used alone to develop numerical SQGs for individual chemicals. Although each approach can be used to make site-specific decisions, no one single approach can adequately address sediment quality. Overall, an integration of several methods using the weight of evidence is the most desirable approach for assessing the effects of contaminants associated with sediment (83, 84, 85, 86). Hazard evaluations integrating data from laboratory exposures, chemical analyses, and benthic community assessments (the sediment quality triad) provide strong complementary evidence of the degree of pollution-induced degradation in aquatic communities (67, 87, 88).

5.2 Regulatory Applications of Sediment Tests:

5.2.1 The USEPA has authority under a variety of statutes to manage contaminated sediments (Table 4). USEPA’s Contami-

TABLE 4 Statutory Needs for Sediment Quality Assessment (Modified from Dickson et al (91) and Southerland et al (89))

Law <sup>A</sup>	Area of need
CERCLA	—Assess need for remedial action with contaminated sediments; assess degree of cleanup required; disposition of sediment
CWA	—NPDES permitting, especially under Best Available Technology (BAT) in water-quality-limited water —Section 403(c) criteria for ocean discharges; mandatory additional requirements to protect marine environment —Section 301(g) waivers for publically owned treatment works (PTOWs) discharging to marine waters —Section 404 permits to dredge and fill activities (administered by the Corps of Engineers)
FIFRA	—Review uses of new and existing chemicals —Pesticide labeling and registration
MPRSA	—Permits for ocean dumping
NEPA	—Preparation of environmental impact statements for projects with surface water discharges
TSCA	—Section 5: Pre-manufacture notice reviews for new chemicals —Section 4,5,6: Reviews for existing industrial chemicals
RCRA	—Assess suitability (and permit) on-land disposal or beneficial use of contaminated sediments considered “hazardous”

<sup>A</sup> CERCLA Comprehensive Environmental Response, Compensation and Liability Act (“Superfund”)  
 CWA Clean Water Act  
 FIFRA Federal Insecticide, Fungicide, and Rodenticide Act  
 MPRSA Marine Protection, Resources and Sanctuary Act  
 NEPA National Environmental Policy Act  
 TSCA Toxic Substances Control Act  
 RCRA Resource Conservation and Recovery Act

nated Sediment Management Strategy (89, 90) establishes the following four goals for contaminated sediments and describes actions that the Agency intends to take to accomplish these goals: (1) to prevent further contamination of sediments that may cause unacceptable ecological or human health risks; (2) when practical, to clean up existing sediment contamination that adversely affects the Nation’s waterbodies or their uses, or that causes other significant effects on human health or the environment; (3) to ensure that sediment dredging and the

TABLE 3 Sediment Quality Assessment Procedures (Modified from USEPA (82))

Method	Type			Approach
	Numeric	Descriptive	Combination	
Equilibrium Partitioning		*		A sediment quality value for a given contaminant is determined by calculating the sediment concentration of the contaminant that corresponds to an interstitial water concentration equivalent to the USEPA water-quality criterion for the contaminant.
Tissue Residues	*			Safe sediment concentrations of specific chemicals are established by determining the sediment chemical concentration that results in acceptable tissue residues.
Interstitial Water Toxicity	*	*	*	Toxicity of interstitial water is quantified and identification evaluation procedures are applied to identify and quantify chemical components responsible for sediment toxicity.
Benthic Community Structure		*		Environmental degradation is measured by evaluating alterations in benthic community structure.
Whole-sediment Toxicity and Sediment Spiking	*	*	*	Test organisms are exposed to sediments that may contain known or unknown quantities of potentially toxic chemicals. At the end of a specified time period, the response of the test organisms is examined in relation to a specified endpoint. Dose-response relationships can be established by exposing test organisms to sediments that have been spiked with known amounts of chemicals or mixtures of chemicals.
Sediment Quality Triad	*	*	*	Sediment chemical contamination, sediment toxicity, and benthic community structure are measured on the same sediment sample. Correspondence between sediment chemistry, toxicity, and field effects is used to determine sediment concentrations that discriminate conditions of minimal, uncertain, and major biological effects.
Sediment Quality Guidelines	*	*	*	The sediment concentration of contaminants associated with toxic responses measured in laboratory exposures or field assessments (i.e., Apparent Effects Threshold (AET), Effect Range Median (ERM), Probable Effect Level (PEL).

disposal of dredged material continue to be managed in an environmentally sound manner; and (4) to develop and consistently apply methodologies for analyzing contaminated sediments. The Agency plans to employ its pollution prevention and source control programs to address the first goal. To accomplish the second goal, USEPA will consider a range of risk management alternatives to reduce the volume and effects of existing contaminated sediments, including *in-situ* containment and contaminated sediment removal. Finally, the Agency is developing tools for use in pollution prevention, source control, remediation, and dredged material management to meet the collective goals. These tools include national inventories of sediment quality and environmental releases of contaminants, numerical assessment guidelines to evaluate contaminant concentrations, and standardized bioassays to evaluate the bioaccumulation and toxicity potential of sediment samples.

5.2.2 The Clean Water Act (CWA) is the single most important law dealing with environmental quality of surface waters in the United States. The objective of the CWA is to restore and maintain the chemical, physical, and biological integrity of the nation's waters (CWA, Section 101). Federal and state monitoring programs traditionally have focused on evaluating water column problems caused by point source dischargers. Findings in the National Sediment Quality Survey, volume I of the first biennial report to Congress on sediment quality in the U.S., indicate that this focus needs to be expanded to include sediment quality impacts (Section 1.1.2 and (92)).

5.2.3 The Office of Water (OW), the Office of Prevention, Pesticides, and Toxic Substances (OPPTS), the Office of Solid Waste (OSW), and the Office of Emergency and Remedial Response (OERR) are all committed to the principle of consistent tiered testing described in the Contaminated Sediment Management Strategy (USEPA, (90)). Agency-wide consistent testing is desirable because all USEPA programs will use standard methods to evaluate health risk and produce comparable data. It will also provide the basis for uniform cross-program decision-making within the USEPA. Each program will, however, retain the flexibility of deciding whether identified risks would trigger regulatory actions.

5.2.4 Tiered testing refers to a structured, hierarchical procedure for determining data needs relative to decision-making that consists of a series of tiers, or levels, of investigative intensity. Typically, increasing tiers in a tiered testing framework involve increased information and decreased uncertainty (USEPA, (90)). Each EPA program office intends to develop guidance for interpreting the tests conducted within the tiered framework and to explain how information within each tier would trigger regulatory action. Depending on statutory and regulatory requirements, the program specific guidance will describe decisions based on a weight of evidence approach, a pass-fail approach, or comparison to a reference site. The following two approaches are currently being used by USEPA: (1) the Office of Water-U.S. Army Corps of Engineers dredged material testing framework and (2) the OPPTS ecological risk assessment tiered testing framework. USEPA-USACE (93) describes the dredged material testing framework and Smrckek

and Zeeman (94) summarizes the OPPTS testing framework. A tiered testing framework has not yet been chosen for agency-wide use, but some of the components have been identified to be standardized. These components are toxicity tests, bioaccumulation tests, chemical criteria, and other measurements that may have ecological significance including benthic community structure, colonization rate, and *in situ* testing within a mesocosm (77).

### 5.3 Performance-based criteria:

5.3.1 The USEPA's Environmental Monitoring Management Council (EMMC) recommended the use of performance-based methods in developing standards (95). Performance-based methods were defined by EMMC as a monitoring approach which permits the use of appropriate methods that meet preestablished demonstrated performance standards (see 11.2).

5.3.2 The USEPA Office of Water, Office of Science and Technology, and Office of Research and Development held a workshop to provide an opportunity for experts in the field of sediment toxicology and staff from USEPA's Regional and Headquarters Program offices to discuss the development of standard freshwater and marine sediment testing procedures (77, 96). Workgroup participants arrived at a consensus on several culturing and testing methods. In developing guidance for culturing test organisms to be included in the USEPA's methods manual for sediment tests, it was agreed that no one method should be required to culture organisms. However, the consensus at the workshop was that success of a test depends on the health of the cultures. Therefore, having healthy test organisms of known quality and age for testing was determined to be the key consideration relative to culturing methods. A performance-based criteria approach was selected in USEPA (2) as the preferred method through which individual laboratories could use unique culturing methods rather than requiring use of one culturing method.

5.3.3 This standard recommends the use of performance-based criteria to allow each laboratory to optimize culture methods and minimize effects of test organism health on the reliability and comparability of test results. See 13.1.2 and 14.1.2 and Annex A1 to Annex A7 for a listing of performance criteria for culturing and testing.

## 6. Interferences

### 6.1 General Interferences:

6.1.1 An interference is a characteristic of a sediment or a test system that can potentially affect test organism response aside from those related to sediment-associated contaminants. These interferences can potentially confound interpretation of test results in two ways: (1) toxicity is observed in the test sediment when contamination is low or there is more toxicity than expected, and (2) no toxicity is observed when contaminants are present at elevated concentrations or there is less toxicity than expected.

6.1.2 Because of the heterogeneity of natural sediments, extrapolation from laboratory studies to the field can sometimes be difficult (Table 5; (67)). Sediment collection,

**TABLE 5 Advantages and Disadvantages for Use of Sediment Tests (Modified from Swartz (97))**

*Advantages*

- Measure bioavailable fraction of contaminant(s).
- Provide a direct measure of benthic effects, assuming no field adaptation or amelioration of effects.
- Limited special equipment is required.
- Methods are rapid and inexpensive.
- Legal and scientific precedence exist for use; ASTM standard guides are available.
- Measure unique information relative to chemical analyses or benthic community analyses.
- Tests with spiked chemicals provide data on cause-effect relationships.
- Sediment-toxicity tests can be applied to all chemicals of concern.
- Tests applied to field samples reflect cumulative effects of contaminants and contaminant interactions.
- Toxicity tests are amenable to confirmation with natural benthos populations.

*Disadvantages*

- Sediment collection, handling, and storage may alter bioavailability.
- Spiked sediment may not be representative of field contaminated sediment.
- Natural geochemical characteristics of sediment may affect the response of test organisms.
- Indigenous animals may be present in field-collected sediments.
- Route of exposure may be uncertain and data generated in sediment toxicity tests may be difficult to interpret if factors controlling the bioavailability of contaminants in sediment are unknown.
- Tests applied to field samples may not discriminate effects of individual chemicals.
- Few comparisons have been made of methods or species.
- Only a few chronic methods for measuring sublethal effects have been developed or extensively evaluated.
- Laboratory tests have inherent limitations in predicting ecological effects.
- Tests do not directly address human health effects.

handling, and storage may alter bioavailability and concentration by changing the physical, chemical, or biological characteristics of the sediment. Maintaining the integrity of a field-collected sediment during removal, transport, mixing, storage, and testing is extremely difficult and may complicate the interpretation of effects. See (62) and E1391.

6.1.3 Depletion of aqueous and sediment-sorbed chemicals resulting from uptake by an organism or test chamber may also influence availability. In most cases, the organism is a minor sink for chemicals relative to the sediment. However, within the burrow of an organism, sediment desorption kinetics may limit uptake rates. Within minutes to hours, a major portion of the total chemical may be inaccessible to the organisms because of depletion of available residues. The desorption of a particular compound from sediment may range from easily reversible (labile; within minutes) to irreversible (non-labile; within days or months (98)). Interparticle diffusion or advection and the quality and quantity of sediment organic carbon can also affect sorption kinetics.

6.1.4 Testing sediments at temperatures different from the field might affect contaminant solubility, partitioning coefficients, or other physical and chemical characteristics. Interaction between sediment and overlying water and the ratio of sediment to overlying water may influence bioavailability (74).

6.1.5 Results of sediment tests can be used to predict effects that may occur with aquatic organisms in the field as a result of exposure under comparable conditions. However, motile organisms might avoid exposure in the field. Photoinduced toxicity may be important for some compounds associated with sediment (for example, polycyclic aromatic hydrocarbons

(PAHs) (99)). However, lighting typically used to conduct laboratory tests does not include the appropriate spectrum of ultraviolet radiation to photoactivate compounds (100, 101) and thus laboratory tests may not account for toxicity expressed by this mode of action.

6.1.6 Natural physico-chemical characteristics such as sediment texture may influence the response of test organisms (57). The physico-chemical characteristics of test sediment need to be within the tolerance limits of the test organism. Ideally, the limits of the test organism should be determined in advance; however, control samples reflecting differences in factors such as grain size and organic carbon can be evaluated if the limits are exceeded in the test sediment (see 12.1). The effects of sediment characteristics can also be addressed with regression equations (57, 58). The use of formulated sediment can also be used to evaluate physico-chemical characteristics of sediment on test organisms (59, 60).

6.1.7 Indigenous organisms may be present in field-collected sediments. An abundance of the same organism or organisms taxonomically similar to the test organism in the sediment sample may make interpretation of treatment effects difficult. For example, growth of amphipods, midges, or mayflies may be reduced if high numbers of oligochaetes are in a sediment sample (102). Previous investigators have inhibited the biological activity of sediment with sieving, heat, mercuric chloride, antibiotics, or gamma irradiation (Guide E1391, (103)). However, further research is needed to determine effects on contaminant bioavailability or other modifications of sediments from treatments such as those used to remove or destroy indigenous organisms.

6.1.8 The route of exposure may be uncertain and data from sediment tests may be difficult to interpret if factors controlling the bioavailability of chemicals in sediment are unknown. Bulk-sediment chemical concentrations may be normalized to factors other than dry weight. For example, concentrations of nonionic organic compounds might be normalized to sediment organic-carbon content (82) and certain metals normalized to acid volatile sulfides (39). Even with the appropriate normalizing factors, determination of toxic effects from ingestion of sediment or from dissolved chemicals in the interstitial water can still be difficult (104).

6.1.9 The addition of food, water, or solvents to the test chambers might obscure the bioavailability of chemicals in sediment or might provide a substrate for bacterial or fungal growth. Without addition of food, the test organisms may starve during exposures (58, 105). However, the addition of the food may alter the availability of the chemicals in the sediment (35, 106) depending on the amount of food added, its composition (for example, total organic carbon (TOC)), and the chemical(s) of interest.

6.1.10 Laboratory sediment testing with field-collected sediments may be useful in estimating cumulative effects and interactions of multiple contaminants in a sample. Tests with field samples usually cannot discriminate between effects of individual chemicals. Many sediment samples contain a complex matrix of inorganic and organic chemicals with many unidentified compounds. The use of Toxicity Identification Evaluations (TIE) procedures including sediment tests with

spiked chemicals may provide evidence of causal relationships and can be applied to many chemicals of concern (10). Laboratory studies that test single compounds spiked into the sediment can be used to determine more directly the specific chemicals causing a toxic response (107).

6.1.11 Sediment spiking can also be used to investigate additive, antagonistic, or synergistic effects of specific chemical mixtures in a sediment sample (107). However, spiked sediment may not be representative of contaminated sediment in the field. Mixing time (64) and aging (36, 75, 76) of spiked sediment can affect responses of organisms.

6.1.12 Most assessments of contaminated sediment rely on acute-lethality testing methods (for example,  $\leq 10$  days; (93, 108, 109)). Acute-lethality tests are useful in identifying “hot spots” of sediment contamination, but may not be sensitive enough to evaluate moderately contaminated areas. Sediment quality assessments using sublethal responses of benthic organisms such as effects on growth and reproduction have been used to successfully evaluate moderately contaminated areas (110, 18, 56), Annex A6 and Annex A7.

6.1.13 Despite the interferences previously listed, existing sediment testing methods that include measurement of sublethal endpoints may be used to provide a rapid and direct measure of effects of contaminants on benthic communities (e.g., Canfield et al. (46)). Laboratory tests with field-collected sediment can also be used to determine temporal, horizontal, or vertical distribution of contaminants in sediment. Most tests can be completed within two to four weeks. Legal and scientific precedence exist for use of sediment tests in regulatory decision making (for example, (111, 97)). Furthermore, sediment tests with complex contaminant mixtures are important tools for making decisions about the extent of remedial action for contaminated aquatic sites and for evaluating the success of remediation activities.

6.2 *Species-Specific Interferences*—Interferences of tests for each species are described in Sections 13 and 14 and in Annex A1 to Annex A7.

## 7. Reagents and Materials

### 7.1 Water:

#### 7.1.1 Requirements:

7.1.1.1 Water used to test and culture organisms should be uniform in quality. Acceptable water should allow satisfactory survival, growth, or reproduction of the test organisms. Test organisms should not show signs of disease or apparent stress (for example, discoloration, unusual behavior). If problems are observed in the culturing or testing of organisms, it is desirable to evaluate the characteristics of the water. See USEPA (3) and Test Method E1367 for a recommended list of chemical analyses of the water supply.

7.1.1.2 When deionized water is required, the water-deionizing system should provide sufficient quantity of at least 1 M $\Omega$  of water. If large quantities of high-quality deionized water are needed, it may be advisable to supply the laboratory-grade water deionizer with preconditioned water from a mixed-bed water treatment system. Some investigators have observed that holding reconstituted water prepared from deionized water for several days before use in sediment tests may

to improve performance of test organisms (C. Hickey, National Institute of Water and Atmospheric Research, Hamilton, New Zealand, personal communication).

#### 7.1.2 Source:

7.1.2.1 A natural water is considered to be of uniform quality if monthly ranges of the hardness, alkalinity, and specific conductance are  $< 10\%$  of their respective averages and if the monthly range of pH is  $< 0.4$ . Natural waters should be obtained from an uncontaminated well or spring, if possible, or from a surface-water source. If surface water is used, the intake should be positioned to: (1) minimize fluctuations in quality and contamination, (2) maximize the concentration of dissolved oxygen, and (3) ensure low concentrations of sulfide and iron. Municipal-water supplies may be variable and may contain unacceptably high concentrations of materials such as copper, lead, zinc, fluoride, chlorine, or chloramines. Chlorinated water should not be used for culturing or testing because residual chlorine and chlorine-produced oxidants are toxic to many aquatic organisms. Dechlorinated water should only be used as a last resort since dechlorination is often incomplete (Guide E1241, (3)).

7.1.2.2 For site-specific investigations, it is desirable to have the water-quality characteristics of the overlying water as similar as possible to the site water. For certain applications the experimental design might require use of water from the site from which sediment is collected. When distilled water was added to sediment, contaminant and organic carbon distributed on smaller sediment particles (perhaps resulting from disaggregation of particles). Therefore, it may be advisable to conduct sediment tests with water representative of the site of concern (2).

7.1.2.3 Water that might be contaminated with facultative pathogens may be passed through a properly maintained ultraviolet sterilizer equipped with an intensity meter and flow controls or passed through a filter with a pore size of  $\leq 0.45\ \mu\text{m}$ .

7.1.2.4 Water might need aeration using air stones, surface aerators, or column aerators. Adequate aeration will stabilize pH, bring concentrations of dissolved oxygen and other gases into equilibrium with air, and minimize oxygen demand and concentrations of volatiles. Excessive aeration may reduce hardness and alkalinity of hard water. The concentration of dissolved oxygen in source water should be between 90 to 100 % saturation to help ensure that dissolved oxygen concentrations are acceptable in test chambers. It may be desirable to aerate dechlorinated water before use (for example, 3 days).

#### 7.1.3 Reconstituted Water:

7.1.3.1 Ideally, reconstituted water is prepared by adding specified amounts of reagent-grade<sup>5</sup> chemicals to high-purity distilled or deionized water (Guide E729, (3)). Problems have been observed with the use of reconstituted water in long-term exposures with *H. azteca* (Section 7.1.3.4.3). In some applications, acceptable high-purity water can be prepared

<sup>5</sup> *Reagent Chemicals, American Chemical Society Specifications*, American Chemical Society, Washington, DC. For suggestions on the testing of reagents not listed by the American Chemical Society, see *Analar Standards for Laboratory Chemicals*, BDH Ltd., Poole, Dorset, U.K., and the *United States Pharmacopeia and National Formulary*, U.S. Pharmaceutical Convention, Inc. (USPC), Rockville, MD.

using deionization, distillation, or reverse-osmosis units (see **9.3, (3)**). Test water can also be prepared by diluting natural water with deionized water (**18**) or by adding salts to relatively dilute natural waters.

7.1.3.2 Deionized water should be obtained from a system capable of producing at least 1 MΩ water.

7.1.3.3 Conductivity, pH, hardness, dissolved oxygen, and alkalinity should be measured on each batch of reconstituted water. The reconstituted water should be aerated before use to adjust pH and dissolved oxygen to the acceptable ranges (for example, see **7.1.3.4**). USEPA (**3**) recommends using a batch of reconstituted water for less than two weeks.

7.1.3.4 *Reconstituted Fresh Water*—To prepare 100 L of reconstituted fresh water described in Smith et al. (**112**), use the reagent grade chemicals as follows:

(1) Place about 75 L of deionized water in a properly cleaned container.

(2) Add 5 g of CaSO<sub>4</sub> and 5 g of CaCl<sub>2</sub> to a 2-L aliquot of deionized water and mix (for example, on a stir plate) for 30 min.

(3) Add 3 g of MgSO<sub>4</sub>, 9.6 g NaHCO<sub>3</sub>, and 0.4 g KCl to a second 2-L aliquot of deionized water and mix on a stir plate for 30 min or until the salts dissolve.

(4) Pour the two 2-L aliquots containing the dissolved salts into the 75 L of deionized water and fill the carboy to 100 L with deionized water.

(5) Aerate the mixture for at least 24 h before use.

(6) The water quality of the reconstituted water (reformulated moderately hard reconstituted water described by Smith et al. (**112**) and in USEPA (**2**)) should be about: hardness, 90 to 100 mg/L as CaCO<sub>3</sub>, alkalinity 50 to 70 mg/L as CaCO<sub>3</sub>, conductivity 330 to 360 μS/cm, and pH 7.8 to 8.2.

(7) McNulty et al. (**105**) and Kemble et al. (**113**), (**61**) observed poor survival of *H. azteca* in tests conducted 14 to 28 days using a variety of reconstituted waters including the reconstituted water described by Smith et al. (**112**) in **7.1.3.4**. Borgmann (**114**) described a reconstituted water that was used successfully to maintain *H. azteca* in culture; however, some laboratories have not had success with reproduction of the *H. azteca* when using this reconstituted water in the 42-day test (T.J. Norberg-King, USEPA, Duluth, MN, personal communication). Research is ongoing to develop additional types of reconstituted waters suitable for *H. azteca*. Until an acceptable reconstituted water has been developed for long-term exposures with *H. azteca*, a natural water demonstrated to support adequate survival, growth, and reproduction of amphipods is recommended for use in long-term *H. azteca* exposures (Annex **A6.2; (56, 113, 61)**).

7.1.3.5 *Synthetic Seawater*—Reconstituted salt water can be prepared by adding commercial sea salts to deionized water. A synthetic seawater formulation can be prepared with reagent grade chemicals which can be diluted with deionized water to the desired salinity (**115**). Ingersoll et al (**116**) describes procedures for culturing *H. azteca* at salinities up to 15 ppt. Reconstituted salt water was prepared by adding commercial salts to a 25:75 (v/v) mixture of freshwater (hardness 283 mg/L as CaCO<sub>3</sub>) and deionized water that was held at least two weeks before use. Synthetic seawater was conditioned by

adding 6.2 mL of nitrifying bacteria No. 9<sup>6</sup> (*Nitromonas sp.* and *Nitrobacter sp.*) to each liter of water. The cultures were maintained by using renewal of water (25 % of the culture water was replaced weekly). *Hyaella azteca* have been used to evaluate the toxicity of estuarine sediments up to 15 ppt salinity in 10-day exposures (**48, 85, 117-119**).

## 7.2 Formulated Sediment:

### 7.2.1 General Requirements:

7.2.1.1 Formulated sediments are mixtures of materials which mimic the physical components of natural sediments. Formulated sediments have not been routinely applied to evaluate sediment contamination. A primary use of formulated sediment could be as a control sediment. Formulated sediments allow for standardization of sediment testing or provide a basis for conducting sediment research. Formulated sediment provides a basis by which any testing program can assess the acceptability of their procedures and facilities. In addition, formulated sediment provides a consistent measure evaluating performance-based criteria necessary for test acceptability. The use of formulated sediment eliminates interferences caused by the presence of indigenous organisms. Spiking formulated sediments with specific chemicals would reduce variation in sediment physico-chemical characteristics and would provide a consistent method for evaluating the fate of chemicals in sediment. See (**62**) and Guide **E1391** for additional detail regarding uses of formulated sediment.

7.2.1.2 Ideally, a formulated sediment should: (1) support the survival, growth, or reproduction of a variety of benthic invertebrates, (2) provide consistent acceptable biological endpoints for a variety of species, and (3) be composed of materials that have consistent characteristics. Consistent material characteristics include: (1) consistency of materials from batch to batch, (2) contaminant concentrations below concentrations of concern, and (3) availability to all individuals and facilities (**61**).

7.2.1.3 Physico-chemical characteristics which might be considered when evaluating the appropriateness of a formulated sediment include: percent sand, percent clay, percent silt, organic carbon content, cation exchange capacity (CEC), oxidation reduction potential (redox), pH, and carbon: nitrogen:phosphorus ratios.

### 7.2.2 Sources of Materials:

7.2.2.1 A variety of methods describe procedures for making formulated sediments. These procedures often use similar constituents; however, they often include either a component or a formulation step which would result in variation from test facility to test facility. In addition, most of the procedures have not been subjected to standardization and consensus approval or round-robin (ring) testing. The procedure outlined below by Kemble et al. (**61**) was evaluated in round-robin testing with *Hyaella azteca* and *Chironomus dilutus* (formerly known as *C. tentans*; Shobanov et al. 1999. (**1**) (Section **17.6**; USEPA (**2**)).

7.2.2.2 Most formulated sediments include sand and clay/silt which meet certain specifications; however, they may be quite different. For example, three sources of clay and silt

<sup>6</sup> Nitrifying bacteria (*Nitromonas sp.* and *Nitrobacter sp.*) such as Frit-zyme® No. 9, available from Fritz Chemical Company, Dallas, TX.

include Attagel® 50, ASP® 400, and ASP® 400P.<sup>7</sup>Table 6, summarizes the characteristics of these materials. The per-

**TABLE 6 Characteristics of 3 Different Sources of Clays and Silts Used in Formulated Sediments<sup>9</sup> (See Table 8 for a List of Suppliers)**

Characteristic	Attagel® 50	ASP® 400	ASP® 400P
% Sand	0.00	0.01	0.00
% Clay	88.50	68.49	56.50
% Silt	11.50	31.50	43.50
Soil Class	Clay	Clay	Silty clay

centage of clay ranges from 56.5 to 88.5 and silt ranges from 11.5 to 43.5. These characteristics should be evaluated when considering the materials to use in a formulated sediment.

7.2.2.3 A critical component of formulated sediment is the source of organic compound. Many procedures have used peat as the source of organic carbon. Other sources of organic carbon have been evaluated including: humus, potting soil, maple leaves, composted cow manure, rabbit chow, cereal leaves,<sup>8</sup> *Chlorella*, trout chow, fish food flakes<sup>9</sup> and fish food flakes.<sup>10</sup>, and alpha cellulose. Only peat, humus, potting soil, composted cow manure, and alpha cellulose have been used successfully without fouling the overlying water in sediment testing (61). The other sources of organic carbon listed in Table 7 caused dissolved oxygen concentrations to fall to unacceptable levels (2, 61). Kemble (61) reported that conditioning of formulated sediment was not necessary when alpha cellulose was used as a source of organic carbon to prepare sediment for use as a negative control. In addition, alpha cellulose is a consistent source of organic carbon, low in contaminant concentrations of concern, and is a relatively biologically-inactive source of organic carbon. There are three forms of cellulose (alpha, beta, and gamma) that differ in their degree of polymerization, alpha cellulose has the highest degree of polymerization and is the chief constituent of paper pulp. The

beta and gamma forms have much lower degree of polymerization and are known as hemicellulose. Hence, the alpha cellulose would not serve as food source for test organisms compared to other sources of organic carbon, but would serve as a organic carbon constituent for sediment (i.e., texture or a partitioning compartment for contaminants). The use of alpha cellulose as a source of organic carbon for sediment-spiking studies has not been adequately evaluated. A recent study conducted by J. Besser (USGS, Columbia, MO, unpublished data) indicate that use of alpha cellulose as a source of organic carbon in 21-day studies resulted in some generation of sulfide in the pore water (which may affect the bioavailability of metals spiked in sediment).

7.2.2.4 An important consideration in the selection of an organic carbon source may be the ratio of carbon:nitrogen:phosphorus. As demonstrated in Table 7, percentage carbon ranged from 30 to 47, percentage nitrogen ranged from 0.7 to 45 mg/g, and percentage phosphorus ranged from below detection to 11 µg/g for several different carbon sources. These characteristics should be evaluated when considering the materials to use in a formulated sediment.

7.2.3 Procedure:

7.2.3.1 A summary of procedures that have been used to formulate sediment are listed as follows. Suppliers of various components are listed in Table 8.

(1) Walsh et al (59): Wash and sieve sand into three grain sizes: coarse (500 to 1500 µm); medium (250 to 499 µm); and fine (63 to 249 µm); Mystic White No. 85, 45, and 18-New England Silica Inc.; Note: Mystic White sands are no longer available. Kemble et al. (61) found White Quartz sand to be an acceptable substitute; Table 8). Obtain clay and silt from Engelhard Corp. Mill peat moss and sieved through a 840-µm screen. Mix constituents dry in the following quantities (by weight): coarse sand (0.6 %); medium sand (8.7 %); fine sand (69.2 %); silt (10.2 %); clay (6.4 %); and organic matter (4.9 %).

<sup>7</sup> Sources of Kaolinite such as Attagel® 50, ASP® 400, ASP® 400P®, ASP® 600, and ASP® 900 are available from Englehard Corporation, Edison, NJ or Product No. 33059 available from BDH Chemical Ltd, Poole, England.

<sup>8</sup> Ground cereal leaves, such as Cerophyl, available from Sigma Chemical Co., P.O. Box 14508, St. Louis, MO 63178, has been found suitable for this purpose.

<sup>9</sup> Fish food flakes such as Tetrafin, available from many pet food distributors, have been found suitable for this purpose.

<sup>10</sup> Fish food flakes such as Tetramin, available from many pet food distributors, have been found suitable for this purpose.

**TABLE 7 Carbon, Nitrogen, Phosphorus Levels for Various Sources of Organic Carbon(2)**

Organic Carbon Source	Carbon, %	Nitrogen, mg/g	Phosphorus, µg/g
Peat	47	4	0.4
Maple leaves 1	42	6	1.3
Maple leaves 2	47	3	1.7
Cow manure	30	11	8.2
Rabbit chow	40	18	0.2
Humic acid	40	3	...
Cereal leaves <sup>10</sup>	47	4	0.4
Chlorella	40	41	5.7
Trout chow	43	36	11
Fish food flakes <sup>12</sup>	37	45	9.6
Fish food flakes <sup>11,36</sup>	29	8.6	

**TABLE 8 Sources of Various Components Used in Formulated Sediments**

Component	Sources
Sand	•White Quartz sand #1 dry, #2, #3—New England Silica, Inc., South Windsor, CT (Note: Mystic White sands are no longer available. Kemble et al. (61) found White Quartz sand to be an acceptable substitute. •Product No. 33094, BDH Chemical, Ltd., Poole, England
Kaolinite	•ASP 400, ASP 400P, ASP 600, ASP 900—Englehard Corporation, Edison, NJ •Product No. 33059, BDH Chemical, Ltd., Poole, England
Montmorillonite	•W.D. Johns, Source Clays, University of Missouri, Columbia, MO
Clay	•Lewiscraft Sculptor’s Clay, available in hobby and artist supply stores
Humus	•Sims Bark Co., Inc., Tuscumbia, AL
Alpha cellulose	•Sigma Co., St. Louis, MO
Peat	•D.L. Browning Co., Mather, WI •Joseph Bentley, Ltd., Barrow-on-Humber, South Humberside, England •Mellinger’s, North Lima, OH
Potting soil	•Zehr’s No Name Potting Soil, Mississauga, Ontario
Humic acid	•Aldrich Chemical Co., Milwaukee, WI
Cow manure	•A.H. Hoffman, Inc., Landisville, PA
Dolomite	•Ward’s Natural Science Establishment, Inc., Rochester, NY

(2) Harrahy and Clements (120): Rinse peat moss then soak for 5 days in deionized water renewing water daily. Acclimate for 5 days, remove all water and spread out to dry. Grind moss and sieve using the following sieve sizes: 1.18 mm (discard these particles); 1.00 mm (average size 1.09 mm); 0.85 mm (average size 0.925); 0.60 (average size 0.725); 0.425 mm (average size 0.5125 mm); retainer (average size 0.2125 mm). Use a mixture of sizes that provides an average particle size of 840  $\mu\text{m}$ . Wash medium quartz sand and dry. Clay and silt are obtained using ASP® 400 (Englehard Corp).<sup>7</sup> Dry mixed constituents in the following quantities: sand (850 g); silt and clay (150 g); dolomite (0.5 g); sphagnum moss (22 g); and humic acid (0.10 g). Mix sediment for an hour on a rolling mill and stored dry until ready for use.

(3) Hanes et al (121): Sieve sand and retain two particle sizes (90 to 180  $\mu\text{m}$  and 180 to 250  $\mu\text{m}$ ) which are mixed in a ratio of 2:1. Dry potting soil for 24 h at room temperature and sieved through a 1-mm screen. Obtain clay as a commercially available sculptors clay. Determine percent moisture of clay and soil after drying for 24 h at 60 to 100°C (correct for percent moisture when mixing materials). Mix constituents by weight in the following ratios: sand mixture (42 %); clay (42 %); and soil (16 %). Autoclave after mixing, autoclave in a foil-covered container for 20 min. Mixture can be stored indefinitely if kept covered after autoclaving.

(4) Naylor et al (122): Acid wash sand and sieve to obtain a 40 to 100-mm size. Obtain clay as kaolin light. Grind peat moss and sieve using a 2-mm screen (peat moss that is allowed to dry out will not rehydrate and will float on the water surface). Adjust for the use of moist peat moss by determining moisture content (dry 5 samples of peat at 60°C until constant weight is achieved). Mix constituents by weight in the following percentages: sand (69 %); kaolin (20 %); peat (10 %; adjust for moisture content); and  $\text{CaCO}_3$  (1 %). Mix for 2 h in a soil shaker and store in sealed containers.

(5) Suedel and Rodgers (60): Sieve sand to provide three different size fractions: coarse (2.0 to 0.5 mm), medium (0.5 to 0.25 mm), and fine (0.25 to 0.05 mm; Mystic White No. 18 and 90; Note: Mystic White sands are no longer available, Kemble et al. (61) found White Quartz sand to be an acceptable substitute; Table 8). Ash silt (ASP® 400),<sup>7</sup> clay (ASP® 600 and 900),<sup>7</sup> montmorillonite clay, and dolomite are ashed at 550°C for 1 h to remove organic matter. Dry humus (70°C) and milled to 2.0 mm. Add dolomite at 1 % of the silt requirement. Age materials for 7 days in flowing water before mixing. Mix constituents to mimic the desired characteristics of the sediment of concern.

(6) Kemble et al. (61) describe procedures for making a variety of formulated sediments ranging in grain size and organic carbon. A sediment with 19 % sand and 2 % organic carbon was produced by combining: (1) 219 grams of sand (White Quartz #1 dry), (2) 1242 grams of a silt-clay mixture (ASP 400), (3) 77.3 grams of alpha cellulose, (4) 0.15 grams of humic acid, and (5) 7.5 grams of dolomite (the dolomite is a source of bicarbonate buffering that occurs naturally in soils and sediments). Steps for processing the sand before use include: (1) rinsing sand with gentle mixing in well water (hardness 283 mg/L as  $\text{CaCO}_3$  alkalinity 255 mg/L as  $\text{CaCO}_3$ ,

pH 7.8) until the water runs clear, (2) rinsing the sand for 5 min with deionized water, and (3) air drying the sand. Constituents are mixed for 1 h on a rolling mill and stored dry until ready for use (i.e., no conditioning required). When formulated sediments are made with a high silt-clay content, the alkalinity and hardness of the pore water may drop due to cation exchange. Gentle mixing of the formulated sediment with overlying water before use in testing reduces this change in the water quality characteristics of the pore water.

7.3 *Reagents*—Data sheets should be followed for reagents and other chemicals purchased from supply houses. The test material(s) should be at least reagent grade, unless a test using a formulated commercial product, technical-grade, or use-grade material is specifically needed. Reagent containers should be dated when received from the supplier, and the shelf life of the reagent should not be exceeded. Working solutions should be dated when prepared and the recommended shelf life should not be exceeded.

7.4 *Standards*—Appropriate USEPA, APHA, or ASTM standards for chemical and physical analyses should be used when possible. For those measurements for which standards do not exist or are not sensitive enough, methods should be obtained from other reliable sources.

## 8. Hazards

### 8.1 General Precautions:

8.1.1 Development and maintenance of an effective health and safety program in the laboratory requires an ongoing commitment by laboratory management and includes: (1) the appointment of a laboratory health and safety officer with the responsibility and authority to develop and maintain a safety program, (2) the preparation of a formal, written health and safety plan, which is provided to each laboratory staff member, (3) an ongoing training program on laboratory safety, and (4) regular safety inspections.

8.1.2 Collection and use of sediments may involve substantial risks to personal safety and health. Chemicals in field-collected sediment may include carcinogens, mutagens, and other potentially toxic compounds. Inasmuch as sediment testing is often started before chemical analyses can be completed, worker contact with sediment needs to be minimized by: (1) using gloves, laboratory coats, safety glasses, face shields, and respirators as appropriate, (2) manipulating sediments under a ventilated hood or in an enclosed glove box, and (3) enclosing and ventilating the exposure system. Personnel collecting sediment samples and conducting tests should take all safety precautions necessary for the prevention of bodily injury and illness which might result from ingestion or invasion of infectious agents, inhalation or absorption of corrosive or toxic substances through skin contact, and asphyxiation because of lack of oxygen or presence of noxious gases.

8.1.3 Before beginning sample collection and laboratory work, personnel should determine that all required safety equipment and materials have been obtained and are in good condition.

### 8.2 Safety Equipment:



8.2.1 *Personal Safety Gear*—Personnel should use safety equipment, such as rubber aprons, laboratory coats, respirators, gloves, safety glasses, face shields, hard hats, and safety shoes.

8.2.2 *Laboratory Safety Equipment*—Each laboratory should be provided with safety equipment such as first-aid kits, fire extinguishers, fire blankets, emergency showers, and eye wash stations. Mobile laboratories should be equipped with a telephone to enable personnel to summon help in case of emergency.

### 8.3 *General Laboratory and Field Operations:*

8.3.1 Special handling and precautionary guidance in Material Safety Data Sheets (MSDS) should be followed for reagents and other chemicals purchased from supply houses.

8.3.2 Work with some sediments may require compliance with rules pertaining to the handling of hazardous materials. Personnel collecting samples and performing tests should not work alone.

8.3.3 It is advisable to wash exposed parts of the body with bactericidal soap and water immediately after collecting or manipulating sediment samples.

8.3.4 Strong acids and volatile organic solvents should be used in a fume hood or under an exhaust canopy over the work area.

8.3.5 An acidic solution should not be mixed with a hypochlorite solution because hazardous fumes might be produced.

8.3.6 To prepare dilute acid solutions, concentrated acid should be added to water, not vice versa. Opening a bottle of concentrated acid and adding concentrated acid to water should be performed only under a fume hood.

8.3.7 Use of ground-fault systems and leak detectors is strongly recommended to help prevent electrical shocks. Electrical equipment or extension cords not bearing the approval of Underwriter Laboratories should not be used. Ground-fault interrupters should be installed in all “wet” laboratories where electrical equipment is used.

8.3.8 All containers should be adequately labeled to indicate their contents.

8.3.9 A clean and well-organized work place contributes to safety and reliable results.

8.4 *Disease Prevention*—Personnel handling samples which are known or suspected to contain human wastes should be immunized against hepatitis B, tetanus, typhoid fever, and polio. Thorough washing of exposed skin with bactericidal soap should follow handling of samples collected from the field.

8.5 *Safety Manuals*—For further guidance on safe practices when handling sediment samples and conducting toxicity tests, check with the permittee and consult general industrial safety manuals including (123, 124).

8.6 *Pollution Prevention, Waste Management, and Sample Disposal*—Guidelines for the handling and disposal of hazardous materials should be strictly followed (Guide D4447). The Federal Government has published regulations for the management of hazardous waste and has given the States the option of either adopting those regulations or developing their own. If States develop their own regulations, they are required to be at

least as stringent as the Federal regulations. As a handler of hazardous materials, it is your responsibility to know and comply with the pertinent regulations applicable in the State in which you are operating. Refer to the Bureau of National Affairs Inc. (125) for the citations of the Federal requirements.

## 9. Facilities, Equipment, and Supplies

9.1 *General*—Before a sediment test is conducted in any new test facility, it is desirable to conduct a “non-toxicant” test, in which all test chambers contain a control sediment, and overlying water with no added test material (see 11.14). Survival, growth, or reproduction of the test organisms will demonstrate whether facilities, water, control sediment, and handling techniques are adequate to result in acceptable species-specific control numbers (for example, see 13.1.2). Evaluations may also be made on the magnitude of the within-chamber and between-chamber variance in a test. See 11.14.

### 9.2 *Facilities:*

9.2.1 The facility must include separate areas for culturing and testing to reduce the possibility of contamination by test materials and other substances, especially volatile compounds. Holding, acclimation, and culture chambers should not be in a room where sediment tests are conducted, where stock solutions or sediments are prepared, or where equipment is cleaned. Test chambers may be placed in a temperature-controlled recirculating water bath or a constant-temperature area. An enclosed test system is desirable to provide ventilation during tests to limit exposure of laboratory personnel to volatile substances.

9.2.2 Light of the quality and illuminance normally obtained in the laboratory is adequate (about 100 to 1000 lx using wide-spectrum fluorescent lights: for example, cool-white or day-light has been used successfully to culture and test organisms). Lux is the unit selected for reporting luminance in this standard. Multiply units of lux by 0.093 to convert to units of footcandles. Multiply units of lux by  $6.91 \times 10^{-3}$  to convert to units of  $\mu\text{mol}^{-2} \text{s}^{-1}$  (assuming an average wavelength of 550 nm ( $\mu\text{mol}^{-2} \text{s}^{-1} = \text{W m} \times \lambda(\text{nm}) \times 8.36 \times 10^{-3}$ )). Illuminance should be measured at the surface of the water. A uniform photoperiod of 16L:8D can be achieved in the laboratory or in an environmental chamber using automatic timers.

9.2.3 During rearing, holding, and testing, test organisms should be shielded from external disturbances such as rapidly changing light or pedestrian traffic.

9.2.4 Air used for aeration should be free of oil and fumes. Filters to remove oil, water, and bacteria are desirable. The test facility should be well ventilated and free of fumes. Oil-free air pumps should be used where possible. Particulates can be removed from the air using filters, and oil and other organic vapors can be removed using activated carbon filters (2). Laboratory ventilation systems should be checked to ensure that return air from chemistry laboratories or sample handling areas is not circulated to culture or testing areas, or that air from testing areas does not contaminate culture areas. Air pressure differentials between areas should not result in a net flow of potentially contaminated air to sensitive areas through open or loosely fitting doors.

### 9.3 *Equipment and Supplies:*

9.3.1 Equipment and supplies that contact stock solutions, sediments, or overlying water should not contain substances that can be leached or dissolved in amounts that adversely affect the test organisms. In addition, equipment and supplies that contact sediment or water should be chosen to minimize sorption of test materials from water. Glass, Type 316 stainless steel, nylon, high-density polyethylene, polypropylene, polycarbonate, and fluorocarbon plastics should be used whenever possible to minimize leaching, dissolution, and sorption. Concrete and high-density plastic containers may be used for holding, acclimation, and culture chambers, and in the water-supply system. These materials should be washed in detergent, acid-rinsed, and soaked in flowing water for a week or more before use. Cast-iron pipe should not be used in water-supply systems because colloidal iron will be added to the overlying water and strainers will be needed to remove rust particles. Copper, brass, lead, galvanized metal, and natural rubber must not contact overlying water or stock solutions before or during a test. Items made of neoprene rubber and other materials not mentioned above should not be used unless it has been shown that their use will not adversely affect survival, growth, or reproduction of the test organisms.

9.3.2 New lots of plastic products should be tested for toxicity before general use by exposing organisms to them under ordinary test conditions.

#### 9.3.3 *General Equipment:*

9.3.3.1 *Environmental Chamber or Equivalent Facility*, with photoperiod and temperature control (20 to 25°C).

9.3.3.2 *Water Purification System*, capable of producing at least 1 MΩ of water (3).

9.3.3.3 *Analytical Balance*, capable of accurately weighing to 0.01 mg.

9.3.3.4 *Reference Weights, Class S*, for documenting the performance of the analytical balance(s). The balance(s) should be checked with reference weights that are at the upper and lower ends of the range of the weighings made when the balance is used. A balance should be checked at the beginning of each series of weighings, periodically (such as every tenth weight) during a long series of weighings, and after taking the last weight of a series.

9.3.3.5 *Volumetric Flasks and Graduated Cylinders*—Class A, borosilicate glass or nontoxic plastic laboratory ware, 10 to 1000 mL for making test solutions.

9.3.3.6 *Volumetric Pipets*—Class A, 1 to 100 mL.

9.3.3.7 *Serological Pipets*—1 to 10 mL, graduated.

9.3.3.8 *Pipet Bulbs and Fillers*.

9.3.3.9 *Droppers, and Glass Tubing with Fire-Polished Edges, 4 to 6-mm inside diameter*, for transferring test organisms.

9.3.3.10 *Wash Bottles*, for rinsing small glassware, instrument electrodes and probes.

9.3.3.11 *Glass or Electronic Thermometers*, for measuring water temperature.

9.3.3.12 *National Bureau of Standards (NBS) Certified Thermometer* (see USEPA Method 170.1; (126)).

9.3.3.13 *Dissolved Oxygen (DO), pH/Selective Ion, and Specific Conductivity Meters and Probes*, for routine physical

and chemical measurements are needed. Unless a test is being conducted to specifically measure the effect of DO or conductivity, a portable field-grade instrument is acceptable.

9.3.3.14 See **Table 9** for a list of additional equipment and supplies. **Annex A7** outlines equipment needs for conducting long-term exposures with *Chironomus dilutus* (formerly known as *C. tentans*; Shobanov et al. 1999. (1).

#### 9.3.4 *Water-delivery System:*

9.3.4.1 The water-delivery system used in water-renewal testing can be one of several designs. The system should be capable of delivering water to each replicate test chamber. Mount and Brungs (129) diluters have been successfully modified for sediment testing. Other diluter systems have also been useful (2, 130, 131-132). The water-delivery system should be calibrated before the test by determining the flow rate of the overlying water. The general operation of the system should be visually checked daily throughout the length of the test. If necessary, the water-delivery system should be adjusted during the test. At any particular time during the test, flow rates through any two test chambers should not differ by more than 10 %.

9.3.4.2 The overlying water can be replaced manually (for example, siphoning); however, manual systems take more time to maintain during a test. In addition, automated systems generally result in less suspension of sediment compared to manual renewal.

#### 9.3.5 *Test Chambers:*

9.3.5.1 Test chambers may be constructed in several ways and of various materials, depending on the experimental design and the contaminants of interest. Clear silicone adhesives, suitable for aquaria, sorb some organic compounds which might be difficult to remove. Therefore, as little adhesive as possible should be in contact with the test material. Extra beads of adhesive should be on the outside of the test chambers rather than on the inside. To leach potentially toxic compounds from the adhesive, all new test chambers constructed using silicone adhesives should be held at least 48 h in overlying water before use in a test.

9.3.5.2 Test chambers for specific tests are described in Sections 13 and 14, and in **Annex A1** to **Annex A7**.

#### 9.3.6 *Cleaning:*

9.3.6.1 All non-disposable sample containers, test chambers, and other equipment that have come in contact with sediment should be washed after use in the manner described as follows to remove surface contaminants.

(1) Soak 15 min in tap water, and scrub with detergent, or clean in an automatic dishwasher.

(2) Rinse twice with tap water.

(3) Carefully rinse once with fresh, dilute (10 %, V:V) hydrochloric or nitric acid to remove scale, metals, and bases. To prepare a 10 % solution of acid, add 10 mL of concentrated acid to 90 mL of deionized water.

(4) Rinse twice with deionized water.

(5) Rinse once with full-strength, pesticide-grade acetone to remove organic compounds (use a fume hood or canopy). Hexane might also be used as a solvent for removing non-ionic organic compounds. However, acetone is preferable if only one organic solvent is used to clean equipment.

**TABLE 9 Equipment and Supplies for Culturing and Testing for Specific Test Organisms are Listed As: HA = *Hyalella azteca* and CT = *Chironomus dilutus*. See Annex A1 to Annex A5 for Supplies and Equipment for the Additional Test Organisms**

A. Biological Supplies	Brood stock of test organisms Active dry yeast (HA) Cereal leaves; HA Trout chow (HA) Fish food flakes <sup>11</sup> (CA) Algae (for example, <i>Selenastrum capricornutum</i> , <i>Chlorella</i> ; CT) Diatoms (for example, <i>Navicula sp.</i> (HA)
B. Glassware	Culture chambers Test chambers (300-mL high-form lipless beaker; HA and CT) Juvenile holding beakers (for example, 1 L; HA) Crystallizing dishes or beakers (200 to 300-mL; CT) Erlenmeyer flasks (250 and 500 mL; CT) Larval rearing chambers (for example, 19-L capacity; CT) ¼-in. glass tubing (for aspirating flask; CT) Wide-bore pipets (4 to 6-mm inside diameter) Glass disposable pipets Burettes (for hardness and alkalinity determinations) Graduated cylinders (assorted sizes, 10 mL to 2 L)
C. Instruments and Equipment	Dissecting microscope Stainless steel sieves (for example, U.S. Standard No. 25, 30, 35, 40, 50 mesh) Delivery system for overlying water Photoperiod timers Light meter Temperature controllers Thermometer Continuous recording thermometers Photoperiod timer Dissolved oxygen meter pH meter Ion-specific meter Ammonia electrode (or ammonia test kit) Specific-conductance meter Drying oven Desiccator Balance (0.01-mg sensitivity) Blender Refrigerator Freezer Light box Hemacytometer (HA) Paper shredder, cutter, or scissors (CT) Temperature controller Thermometer Continuous-recording thermometer Photoperiod timer Electric drill with stainless steel auger (diameter 7.6 cm, overall length 38 cm, auger bit length 25.4 cm (see 10.3) See (2, 127, 128) for a listing of equipment needed for water-delivery systems
D. Miscellaneous	Ventilation system for test chambers Air supply and airstones (oil free and regulated) Cotton surgical gauze or cheese cloth (HA) Stainless steel screen (No. 60 mesh, for test chambers) Glass hole-cutting bits Glass glue Plastic mesh (110-µm mesh opening; nylon screen <sup>13</sup> 110; HA) Aluminum weighing pans Fluorescent light bulbs Nalgene bottles (500 mL and 1000 mL for food preparation and storage) Deionized water Airline tubing White plastic dishpan Coiled-web material <sup>14</sup> Brown or white paper toweling (for substrate; CT) Screening material (for example, nylon screen <sup>13</sup> (110 mesh), window screen, or panty hose; CT) Water squirt bottle Shallow pans (plastic (light-colored), glass, stainless steel)
E. Chemicals	Detergent (nonphosphate) Acetone (reagent grade) Hexane (reagent grade) Hydrochloric acid (reagent grade) Copper Sulfate Potassium Chloride Reagents for reconstituting water Formalin (or other substitutes for formalin, see 13.3.7.1) Sucrose

(6) Rinse three times with deionized water.

9.3.6.2 All test chambers and equipment should be thoroughly rinsed with the dilution water immediately before use in a test.

9.3.6.3 Many organic solvents leave a film that is insoluble in water. A dichromate-sulfuric acid cleaning solution can be used in place of both the organic solvent and the acid (see Guide E729), but the solution might attack silicone adhesive and leave chromium residues on glass. An alternative to use of dichromate-sulfuric acid could be to heat glassware for 8 h at 450°C.

## 10. Sample Collection, Storage, Manipulation, and Characterization

### 10.1 Collection:

10.1.1 Before the preparation or collection of sediment, a procedure should be established for the handling of sediments which might contain unknown quantities of toxic chemicals (Section 8).

10.1.2 Sediments are spatially and temporally variable (64). Replicate samples should be collected to determine variance in sediment characteristics. Sediment should be collected with as little disruption as possible; however, subsampling, compositing, or homogenization of sediment samples may be necessary for some experimental designs. Sampling may cause loss of sediment integrity, change in chemical speciation, or disruption of chemical equilibrium (Guide E1391). A benthic grab or core should be used rather than a dredge to minimize disruption of the sediment sample. Sediment should be collected from a depth that will represent expected exposure. For example, oligochaetes may burrow 4 to 15 cm into sediment.

10.1.3 Exposure to direct sunlight during collection should be minimized, especially if the sediment contains photolytic compounds (99, 100). Sediment samples should be cooled to 4°C in the field before shipment (Test Method E1367). Dry ice can be used to cool samples in the field; however, sediments should never be frozen. Monitors can be used to measure temperature during shipping (2).

10.1.4 For additional information on sediment collection and shipment see Guide E1391, USEPA (62), and USEPA (133) for additional guidance.

### 10.2 Storage:

10.2.1 Since the chemicals of concern and influencing sediment characteristics are not always known, it is desirable to hold the sediments after collection in the dark at 4°C. Traditional convention has held that toxicity tests should be started as soon as possible following collection from the field, although actual recommended storage times range from two weeks (Guide E1391) to less than eight weeks (USEPA-USACE) (90). Discrepancies in recommended storage times reflected a lack of data concerning the effects of long-term storage on the physical, chemical, and toxicological characteristics of the sediment. However, numerous studies have recently been conducted to address issues related to sediment storage (Dillon et al. (134); Becker et al. (135), Carr and Chapman (136), Moore et al. (137), Sarda and Burton (138), Sijm et al. (139), DeFoe and Ankley (140)). The conclusions and recommendations offered by these studies vary substan-

tially and appear to depend primarily upon the type or class of chemical(s) present. Considered collectively, these studies suggest that the recommended guidance that sediments be tested sometime between the time of collection and 8 weeks storage is appropriate. Additional guidance is provided below.

10.2.2 Extended storage of sediments that contain high concentrations of labile chemicals (for example, ammonia, volatile organics) may lead to a loss of these chemicals and a corresponding reduction in toxicity. Under these circumstances, the sediment should be tested as soon as possible after collection, but not later than within two weeks (Sarda and Burton (138)). Sediments that exhibit low-level to moderate toxicity can exhibit considerable temporal variability in toxicity, although the direction of change is often unpredictable (Carr and Chapman (136); Moore et al. (137); DeFoe and Ankley (140)). For these types of sediments, the recommended storage time of <8 weeks may be most appropriate. In some situations, a minimum storage period for low-to-moderately contaminated sediments may help reduce variability. For example, DeFoe and Ankley (140) observed high variability in survival during early testing periods (e.g., <2 weeks) in sediments with low toxicity. De Foe and Ankley (140) hypothesized that this variability partially reflected the presence of indigenous predators that remained alive during this relatively short storage period. Thus, if predatory species are known to exist, and the sediment does not contain labile contaminants, it may be desirable to store the sediment for a short period before testing (e.g., 2 weeks) to reduce potential for interferences from indigenous organisms. Sediments that contain comparatively stable compounds (e.g., high molecular weight compounds such as PCBs) or which exhibit a moderate-to-high level of toxicity, typically do not vary appreciably in toxicity in relation to storage duration (Moore et al. (137), DeFoe and Ankley (140)). For these sediments, long-term storage (e.g., >8 weeks) can be undertaken.

10.2.3 Researchers may wish to conduct additional characterizations of sediment to evaluate possible effects of storage. Concentrations of chemicals of concern could be measured periodically in pore water during the storage period and at the start of the sediment test (18). Ingersoll et al. (15) recommend conducting a toxicity test with pore water within two weeks from sediment collection and at the start of the sediment test. Freezing might further change sediment properties such as grain size or chemical partitioning and should be avoided (Guide E1391; Schuytema et al. (141)). Sediment should be stored with no air over the sealed samples (no head space) at 4°C before the start of a test (Shuba et al. (142)). Sediment may be stored in containers constructed of suitable materials as outlined in Section 9.

### 10.3 Manipulation:

#### 10.3.1 Homogenization:

10.3.1.1 Samples tend to settle during shipment. As a result, water above the sediment should not be discarded, but should be mixed back into the sediment during homogenization. Sediment samples should not be sieved to remove indigenous organisms unless there is a good reason to believe they will influence the response of the test organisms. Large indigenous organisms and large debris can be removed using forceps.

Reynoldson et al (102) observed reduced growth of amphipods, midges, and mayflies in sediments with elevated numbers of oligochaetes and recommended sieving sediments suspected to have high numbers of indigenous oligochaetes. If sediments must be sieved, it may be desirable to analyze samples before and after sieving (for example, pore-water metals, dissolved organic carbon (DOC), acid volatile sulfide (AVS), total organic carbon (TOC)) to document the influence of sieving on sediment chemistry.

10.3.1.2 If sediment is collected from multiple field samples, the sediment can be pooled and mixed using stirring or a rolling mill, feed mixer, or other suitable apparatus (see Guide E1391). Homogenization of sediment can be accomplished using a hand-held drill outfitted with a stainless steel auger (diameter 7.6 cm, overall length 38 cm, auger bit length 25.4 cm (18)).

#### 10.3.2 Sediment Spiking:

10.3.2.1 Test sediment can be prepared by manipulating the properties of a control sediment. Mixing time (64) and aging (36, 75, 76) of spiked sediment can affect bioavailability of chemicals in sediment. Many studies with spiked sediment are often started only a few days after the chemical has been added to the sediment. This short time period may not be long enough for sediments to equilibrate with the spiked chemicals (Section 10.3.2.3). Consistent spiking procedures should be followed in order to make interlaboratory comparisons. Limited studies have been conducted comparing appropriate methods for spiking chemicals in sediment. Additional research is needed before more definitive recommendations for spiking of sediment can be outlined in this standard. The guidance provided in the following sections has been developed from a variety of sources. Spiking procedures that have been developed using one sediment or test organism may not be applicable to other sediments or test organisms. See USEPA (62) and Guide E1391 for additional detail regarding sediment spiking techniques.

(1) The cause of sediment toxicity and the interactive effects of chemicals can be determined by spiking a sediment with chemicals or complex waste mixtures (104). Sediments spiked with a range of concentrations can be used to generate either point estimates (for example, LC50) or a minimum concentration at which effects are observed (lowest-observable-effect concentration; LOEC). Results of tests may be reported in terms of a BSAF (Biota-sediment accumulation factor; (143)). The influence of sediment physico-chemical characteristics on chemical toxicity can also be determined with sediment-spiking studies (48).

10.3.2.2 The test material(s) should be at least reagent grade, unless a test using a formulated commercial product, technical-grade, or use-grade material is specifically needed. Before a test is started, the following should be known about the test material: (1) the identity and concentration of major ingredients and impurities, (2) water solubility in test water, (3) log Kow, BCF (from other test species), persistence, hydrolysis, and photolysis rates of the test substrate, (4) estimated toxicity to the test organism and to humans, (5) if the test concentration(s) are to be measured, the precision and bias of the analytical method at the planned concentration(s) of the test material, and (6) recommended handling and disposal

procedures. Addition of test material(s) to sediment may be accomplished using various methods, such as a: (1) rolling mill, (2) feed mixer, or (3) hand mixing (Guide E1391; USEPA(62)). Modifications of the mixing techniques might be necessary to allow time for a test material to equilibrate with the sediment. Mixing time of spiked sediment should be limited from minutes to a few hours and temperature should be kept low to minimize potential changes in the physico-chemical and microbial characteristics of the sediment (Guide E1391, (133)). Duration of contact between the chemical and sediment can affect partitioning and bioavailability (75). Care should be taken to ensure that the chemical is thoroughly and evenly distributed in the sediment. Analyses of sediment subsamples is advisable to determine the degree of mixing homogeneity (144). Moreover, results from sediment-spiking studies should be compared with the response of test organisms to chemical concentrations in natural sediments (145).

(1) Organic chemicals have been added: (1) directly in a dry (crystalline) form; (2) coated on the inside walls of the container (Ditsworth et al. (144)); or (3) coated onto silica sand (e.g., 5 % w/w of sediment) which is added to the sediment (D.R. Mount, USEPA, Duluth, MN, personal communication). In techniques 2 and 3, the chemical is dissolved in solvent, placed in a glass spiking container (with or without sand), then the solvent is slowly evaporated. The advantage of these three approaches is that no solvent is introduced to the sediment, only the chemical being spiked. When testing spiked sediments, procedural blanks (sediments that have been handled in the same way, including solvent addition and evaporation, but contain no added chemical) should be tested in addition to regular negative controls.

(2) Metals are generally added in an aqueous solution (Guide E1391; Di Toro et al. (39)). Ammonia has also been successfully spiked using aqueous solutions (Besser et al. (29)). Inclusion of spiking blanks is recommended.

(3) Sufficient time should be allowed after spiking for the spiked chemical to equilibrate with sediment components. For organic chemicals, it is recommended that the sediment be aged at least one month before starting a test. Two months or more may be necessary for chemicals with a high log Kow (e.g., >6; D.R. Mount, USEPA, Duluth, MN, personal communication). For metals, shorter aging times (1 to 2 weeks) may be sufficient. Periodic monitoring of chemical concentrations in pore water during sediment aging is highly recommended as a means to assess the equilibration of the spiked sediments. Monitoring of pore water during spiked sediment testing is also recommended.

10.3.2.3 Organic solvents such as triethylene glycol, methanol, ethanol, or acetone may be used, but they might affect TOC levels, introduce toxicity, alter the geochemical properties of the sediment, or stimulate undesirable growths of microorganisms (Guide E1391). Acetone is highly volatile and might leave the system more readily than triethylene glycol, methanol, or ethanol. A surfactant should not be used in the preparation of a stock solution because it might affect the bioavailability, form, or toxicity of the test material.

10.3.2.4 If the test contains both a negative control and a solvent control, the survival, growth, or reproduction of the organisms tested should be compared in the two controls. If a statistically significant difference is detected between the two controls, only the solvent control may be used for meeting the acceptability of the test and as the basis for calculation of results. The negative control might provide additional information on the general health of the organisms tested. If no statistically significant difference is detected, the data from both controls should be used for meeting the acceptability of the test and as the basis for calculation of results (Guide E1241). If performance in the solvent control is markedly different from that in the negative control, it is possible that the data are compromised by experimental artifacts and may not accurately reflect the toxicity of the chemical in natural sediments.

#### 10.3.3 Test Concentration(s) for Laboratory-spiked Sediments:

(1) If a test is intended to generate an LC50, a toxicant concentration series (0.5 or higher) should be selected that will provide partial mortality at two or more concentrations of the test chemical. The LC50 of a particular compound may vary depending on physical and chemical sediment characteristics. It may be desirable to conduct a range-finding test in which the organisms are exposed to a control and three or more concentrations of the test material that differ by a factor of ten. Results from water-only tests could be used to establish concentrations to be tested in a whole-sediment test based on predicted pore-water concentrations (40). See Section 15 for a description of procedures to analyze data generated from these studies.

(2) Bulk-sediment chemical concentrations might be normalized to factors other than dry weight. For example, concentrations of nonpolar organic compounds might be normalized to sediment organic-carbon content and simultaneously extracted metals might be normalized to acid-volatile sulfides (39, 40).

(3) In some situations it might be necessary to simply determine whether a specific concentration of test material is toxic to the test organism, or whether adverse effects occur above or below a specific concentration. When there is interest in a particular concentration, it might only be necessary to test that concentration and not to determine an LC50.

#### 10.4 Characterization:

10.4.1 All sediments should be characterized for at least: pH and ammonia of the pore water, organic carbon content (total organic carbon, TOC), particle size distribution (percent sand, silt, clay), and percent water content (Test Method E1367, (146)). See Section 10.4.4.7 for a description of procedures for isolating interstitial water.

10.4.2 Other analyses on sediments might include: biological oxygen demand, chemical oxygen demand, cation exchange capacity, Eh, total inorganic carbon, total volatile solids, acid volatile sulfides, metals, synthetic organic compounds, oil and grease, petroleum hydrocarbons, and interstitial water analyses.

10.4.3 Macrobenthos may be evaluated by subsampling the field-collected sediment. If direct comparisons are to be made, subsamples for toxicity testing should be collected from the

same sample for analysis of sediment physical and chemical characterizations. Qualitative descriptions of the sediment may include color, texture, and presence of macrophytes or animals. Monitoring the odor of sediment samples should be avoided because of potential hazardous volatile chemicals.

#### 10.4.4 Analytical Methodology:

10.4.4.1 Chemical and physical data should be obtained using appropriate standard methods whenever possible. For those measurements for which standard methods do not exist or are not sensitive enough, methods should be obtained from other reliable sources.

10.4.4.2 The precision, accuracy, and bias of each analytical method used should be determined in the appropriate matrix: that is, sediment, water, and tissue. Reagent blanks and analytical standards should be analyzed and recoveries should be calculated.

10.4.4.3 Concentration of spiked test material(s) in sediment, interstitial water, and overlying water should be measured as often as practical during a test. If possible, the concentration of the test material in overlying water, interstitial water, and sediments should be measured at the start and end of a test. Measurement of test material(s) degradation products might also be desirable.

10.4.4.4 Separate chambers should be set up at the start of a test and destructively sampled during and at the end of the test to monitor sediment chemistry. Test organisms and food should be added to these extra chambers.

10.4.4.5 Measurement of test material(s) concentration in water can be accomplished by pipeting water samples from about 1 to 2 cm above the sediment surface in the test chamber. Overlying water samples should not contain any surface debris, any material from the sides of the test chamber, or any sediment.

10.4.4.6 Measurement of test material(s) concentration in sediment at the end of a test can be taken by siphoning most of the overlying water without disturbing the surface of the sediment, then removing appropriate aliquots of the sediment for chemical analysis.

10.4.4.7 *Interstitial water*—Interstitial water (pore water), defined as the water occupying the spaces between sediment or soil particles, is often isolated to provide either a matrix for toxicity testing or to provide an indication of the concentration or partitioning of chemicals within the sediment matrix. Draft USEPA sediment equilibrium partitioning guidelines (ESGs) are based on the presumption that the concentration of chemicals in the interstitial water are correlated directly to their bioavailability and, therefore, their toxicity (Di Toro et al. (40)). Of additional importance is contaminants in interstitial waters can be transported into overlying waters through diffusion, bioturbation, and resuspension processes (Van Rees et al. (147)). The usefulness of interstitial water sampling for determining chemical contamination or toxicity will depend on the study objectives and nature of the sediments at the study site.

(1) Isolation of sediment interstitial water can be accomplished by a wide variety of methods, which are based on either physical separation or on diffusion/equilibrium. The common physical-isolation procedures can be categorized as: (1)

centrifugation, (2) compression/squeezing, or (3) suction/vacuum. Diffusion/equilibrium procedures rely on the movement (diffusion) of pore-water constituents across semipermeable membranes into a collecting chamber until an equilibrium is established. A description of the materials and procedures used in the isolation of pore water is included in the reviews by Bufflap and Allen (148), Guide E1391, and USEPA (62).

(2) When relatively large volumes are required (>20 mL) for toxicity testing or chemical analyses, appropriate quantities of sediment are generally collected with grabs or corers for subsequent isolation of the interstitial water. Several isolation procedures, such as centrifugation (Ankley and Scheubauer-Berigan, (28)), squeezing (Carr and Chapman, (136)) and suction (Winger and Lasier, (149); Winger et al., (149)), have been used successfully to obtain adequate volumes for testing purposes. Peepers (dialysis) generally do not produce sufficient volumes for most analyses; however, larger sized peepers (500 mL volume) have been used for collecting interstitial water *in situ* for chemical analyses and organism exposures (Burton, (150); Sarda and Burton, (138)).

(3) There is no one superior method for the isolation of interstitial water used for toxicity testing and associated chemical analyses. Factors considered in the selection of an isolation procedure may include: (1) volume of pore water needed, (2) ease of isolation (materials, preparation time, and time required for isolation), and (3) artifacts in the pore water caused by the isolation procedure. Each approach has unique strengths and limitations (Bufflap and Allen, (151), (148); Winger et al., (149)), which vary with sediment characteristics, chemicals of concern, toxicity test methods, and desired test resolution (i.e., data quality objectives). For suction or compression separation which use a filter or a similar surface, there may be changes to the characteristics of the interstitial water compared to separation using centrifugation (Ankley et al., (58); Horowitz et al. (152)). For most toxicity test procedures, relatively large volumes of interstitial water (e.g., liters) are frequently needed for static or renewal exposures with the associated water chemistry analyses. While centrifugation can be used to generate large volumes of interstitial water, it is difficult to use centrifugation to isolate water from coarser sediment. If smaller volumes of interstitial water are adequate and logistics allow, the use of peepers which establish an equilibrium with the pore water through a permeable membrane may be desirable. If logistics do not allow placement of peeper samplers, an alternative procedure could be to collect cores which are can be sampled using side port suctioning or centrifugation (G.A. Burton, Wright State University, personal communication). However, if larger samples of interstitial water are needed, it would be necessary to collect multiple cores as quickly as possible using an inert environment and centrifugation at ambient temperatures. See USEPA (140) and Guide E1391 for additional detail regarding isolation of interstitial water.

(4) There is no one superior method for the isolation of interstitial water for toxicity testing purposes. Each approach has unique strengths and limitations which vary with the characteristics of the sediment, the chemicals of concern, the toxicity test methods to be used, and the resolution necessary

(i.e., the data quality objectives). For suction or compression separation which use a filter or a similar surface, there may be changes to the characteristics of the interstitial water compared to separation using centrifugation (Ankley et al. (58)). For most toxicity test procedures, relatively large volumes of interstitial water (for example, liters) are frequently needed for static or renewal exposures with the associated water chemistry analyses. While centrifugation can be used to generate large volumes of interstitial water, it is difficult to use centrifugation to isolate water from coarser sediment. If smaller volumes of interstitial water are adequate and logistics allow, the use of peepers which establish an equilibrium with the pore water through a permeable membrane may be desirable. If logistics do not allow placement of peeper samplers, an alternative procedure could be to collect cores which are can be sampled using side port suctioning or centrifugation (G.A. Burton, Wright State University, personal communication). However, if larger samples of interstitial water are needed, it would be necessary to collect multiple cores as quickly as possible using an inert environment and centrifugation at ambient temperatures. See USEPA(62) and Guide E1391 for additional detail regarding isolation of interstitial water.

## 11. Quality Assurance and Quality Control

### 11.1 Introduction:

11.1.1 Developing and maintaining a laboratory Quality Assurance (QA) program requires an ongoing commitment by laboratory management and also includes the following: (1) appointment of a laboratory quality assurance officer with the responsibility and authority to develop and maintain a QA program, (2 ) preparation of a Quality Assurance Project Plan with Data Quality Objectives, (3) preparation of written descriptions of laboratory Standard Operating Procedures (SOPs) for test organism culturing, testing, instrument calibration, sample chain-of-custody, laboratory sample tracking system, and (4) provision of adequate, qualified technical staff and suitable space and equipment to ensure reliable data (USEPA (153)).

11.1.2 Quality Assurance (QA) practices within a testing laboratory should address all activities that affect the quality of the final data, such as: (1) sediment sampling and handling, (2) the source and condition of the test organisms, (3) condition and operation of equipment, (4) test conditions, (5) instrument calibration, (6) replication, (7) use of reference toxicants, (8) record keeping, and (9) data evaluation.

11.1.3 Quality Control (QC) practices, on the other hand, consist of the more focused, routine, day-to-day activities carried out within the scope of the overall QA program. For more detailed discussion of quality assurance, and general guidance on good laboratory practices related to testing, see (3, 115, 154, 155-162 ).

### 11.2 Performance-based Criteria:

11.2.1 The USEPA Environmental Monitoring Management Council (EMMC) recommended the use of performance-based methods in developing standards for chemical analytical methods (95). Performance-based methods were defined by EMMC as a monitoring approach which permits the use of appropriate methods that meet preestablished demonstrated performance

standards. Minimum required elements of performance, such as precision, reproducibility, bias, sensitivity, and detection limits should be specified and the method should be demonstrated to meet the performance standards.

11.2.2 In developing guidance for culturing test organisms to be included in this standard for sediment tests, it was generally agreed that no single method must be used to culture organisms. Success of a test relies on the health of the culture from which organisms are taken for testing. Having healthy organisms of known quality and age for testing is the key consideration relative to culture methods. Therefore, a performance-based criteria approach is the preferred method through which individual laboratories can evaluate culture health rather than requiring all laboratories to use the same culturing procedure. Performance-based criteria were chosen in USEPA (2) and in this standard to allow each laboratory to optimize culture methods while providing organisms that produce reliable and comparable test results. See 13.1.2, 14.1.2, and Annex A1 to Annex A7 for a listing of performance criteria for culturing and testing.

### 11.3 Facilities, Equipment, and Test Chambers:

11.3.1 Separate test organism culturing and testing areas must be provided to avoid loss of cultures because of cross-contamination. Ventilation systems should be designed and operated to prevent recirculation or leakage of air from chemical analysis laboratories or sample storage and preparation areas into test organism culturing or sediment testing areas, and from sediment testing laboratories and sample preparation areas into culture areas.

11.3.2 Equipment for temperature control should be adequate to maintain recommended test-water temperatures. Recommended materials should be used in the fabrication of the test equipment which comes in contact with the sediment or overlying water.

11.3.3 Before a sediment test is conducted in a new facility, a “non-contaminant” test should be conducted in which all test chambers contain a control sediment and overlying water. This information is used to demonstrate that the facility, control sediment, water, and handling procedures provide acceptable responses of test organisms (see 11.14).

11.4 *Test Organisms*— The organisms should appear healthy, behave normally, feed well, and have low mortality in cultures, during holding (for example, <20 % for 48 h before the start of a test), and in test controls. Test organisms should be positively identified to species. Obtaining wild populations of organisms for testing should be avoided unless the ability of the wild population to cross-breed with existing laboratory populations has been determined (see 12.2.2).

11.5 *Water*—The quality of water used for organism culturing and testing is extremely important. Overlying water used in testing and water used in culturing organisms should be uniform in quality. Acceptable water should allow satisfactory survival, growth, or reproduction of the test organisms. Test organisms should not show signs of disease or apparent stress (for example, discoloration, unusual behavior). See Section 7 for additional details.

11.6 *Sample Collection and Storage*—Sample holding times and temperatures should conform to conditions described in Section 10.

11.7 *Test Conditions*— It is desirable to measure temperature continuously in at least one chamber during each test. Temperatures should be maintained within the limits specified for each test. Dissolved oxygen, alkalinity, water hardness, conductivity, ammonia, and pH should be checked in accordance with 13.3, 14.3, or in Annex A1 to Annex A7.

### 11.8 *Quality of Test Organisms:*

11.8.1 It may be desirable for laboratories to periodically perform 96-h water-only reference-toxicity tests to assess the sensitivity of culture organisms ( See Table 10 and Table 11 and Section 11.16). Data from these reference-toxicity tests could be used to assess genetic strain or life-stage sensitivity to select chemicals. The previous requirement for laboratories to conduct monthly reference-toxicity tests in an earlier version of this standard (Test Method E1706-95b) has not been included as a requirement for testing sediments due to the inability of reference-toxicity tests to identify stressed populations of test organisms (McNulty et al. (105)). Physiological measurements such as lipid content might also provide useful information regarding the health of the cultures.

**TABLE 10 Recommended Test Conditions for Conducting Reference-Toxicity Tests With One Organism/Chamber**

Parameter	Conditions
1. Test Type:	Water-only test
2. Dilution series:	Control and at least 5 test concentrations (0.5 dilution factor)
3. Toxicant:	KCl, Cd, or Cu
4. Temperature:	23 ± 1°C
5. Light quality:	Wide-spectrum fluorescent lights
6. Illuminance:	About 100 to 1000 lux
7. Photoperiod:	16L:8D
8. Renewal of water:	None
9. Age of organisms:	<i>H. azteca</i> : 7- to 14-day old (within a 1- to 2-day range in age) <i>C. dilutus</i> : second-to third-instar larvae (about 10-day-old larvae)(Section 12.4.1) <i>L. variegatus</i> : adults
10. Test chamber:	30-mL plastic cups (covered with glass or plastic)
11. Volume of water:	20 mL
12. Number of organisms/chamber:	1
13. Number of replicate chambers/treatment:	10 minimum
14. Feeding:	<i>H. azteca</i> : 0.1 mL YCT (1800 mg/L stock) on Day 0 and 2 <i>C. dilutus</i> : 0.25 Tetrafin® (4 g/L stock) on Day 0 and 2 <i>L. variegatus</i> : not fed
15. Substrate:	<i>H. azteca</i> : Nitex® screen (110 mesh) <i>C. dilutus</i> : sand (monolayer) <i>L. variegatus</i> : no substrate
16. Aeration:	None
17. Dilution water:	Culture water, well water, surface water, site water, or reconstituted water
18. Test chamber cleaning:	None
19. Water quality:	Hardness, alkalinity, conductivity, dissolved oxygen, and pH at the beginning and end of a test. Temperature daily
20. Test duration:	96 h
21. Endpoint:	Survival (LC50)
22. Test acceptability:	90 % control survival



**TABLE 11 Recommended Test Conditions for Conducting Reference-Toxicity Tests With More Than One Organism/ Chamber**

Parameter	Conditions
1. Test Type:	Water-only test
2. Dilution series:	Control and at least 5 test concentrations (0.5 dilution factor)
3. Toxicant:	KCl, Cd, or Cu
4. Temperature:	23 ± 1°C
5. Light quality:	Wide-spectrum fluorescent lights
6. Illuminance:	About 100 to 1000 lux
7. Photoperiod:	16L:8D
8. Renewal of water:	None
9. Age of organisms:	<i>H. azteca</i> : 7- to 14-day old (within a 1- to 2-day range in age) <i>C. dilutus</i> : second- to third-instar (about 10-day old larvae)(Section 12.4.1) <i>L. variegatus</i> : adults
10. Test chamber:	250-mL glass beaker (covered with glass or plastic)
11. Volume of water:	100 mL (minimum)
12. Number of organisms/ chamber:	10 minimum
13. Number of replicate chambers/treatment:	3 minimum
14. Feeding:	<i>H. azteca</i> : 0.5 mL YCT (1800 mg/L stock) on Day 0 and 2 <i>C. dilutus</i> : 1.25 mL Tetrafin® (4 g/L stock) on Day 0 and 2 <i>L. variegatus</i> : not fed
15. Substrate:	<i>H. azteca</i> : Nitex® screen (110 mesh) <i>C. dilutus</i> : sand (monolayer) <i>L. variegatus</i> : no substrate
16. Aeration:	None
17. Dilution water:	Culture water, well water, surface water, site water, or reconstituted water
18. Test chamber cleaning:	None
19. Water quality:	Hardness, alkalinity, conductivity, dissolved oxygen, and pH at the beginning and end of a test. Temperature daily
20. Test duration:	96 h
21. Endpoint:	Survival (LC50)
22. Test acceptability:	90 % control survival

11.8.2 It is desirable to determine the sensitivity of test organisms obtained from an outside source. The supplier should provide data with the shipment describing the history of the sensitivity or organisms from the same source culture. The supplier should also certify the species identification of the test organisms, and provide the taxonomic references, or name(s) of the taxonomic expert(s) consulted.

11.8.3 All organisms in a test must be from the same source (Section 10.2.2). Organisms may be obtained from laboratory cultures or from commercial or government sources. The test organism used should be identified using an appropriate taxonomic key, and verification should be documented (e.g., (163), Merritt and Cummins (164)). Obtaining organisms from wild populations should be avoided unless organisms are cultured through several generations in the laboratory. In addition, the ability of the wild population of sexually reproducing organisms to cross-breed with the existing laboratory population should be determined (Duan et al., (165)). Sensitivity of the wild population to select chemicals (for example, Table 2) should also be documented.

11.9 *Quality of Food*—Problems with the nutritional suitability of the food will be reflected in the survival, growth, or reproduction of the test organisms in cultures or in sediment tests.

#### 11.10 *Test Acceptability:*

11.10.1 Section 13.2 and 14.2 and Annex A1 to Annex A7 outline requirements for acceptability of tests. An individual test may be conditionally acceptable if temperature, dissolved oxygen, and other specified conditions fall outside specifications, depending on the degree of the departure and the objectives of the tests (see test condition summaries). The acceptability of a test will depend on the experience and professional judgment of the laboratory analyst and the reviewing staff of the regulatory authority. Any deviation from test specifications should be noted when reporting data from a test.

#### 11.11 *Analytical Methods:*

11.11.1 All routine chemical and physical analyses for culture and testing water, food, and sediment should include established quality assurance practices (156-159).

11.11.2 Reagent containers should be dated when received from the supplier and the shelf life of the reagent should not be exceeded. Working solutions should be dated when prepared and the recommended shelf life should not be exceeded.

#### 11.12 *Calibration and Standardization:*

11.12.1 Instruments used for routine measurements of chemical and physical characteristics such as pH, dissolved oxygen, temperature, and conductivity should be calibrated before use each day according to the instrument manufacturer's procedures as indicated in the general section on quality assurance (see USEPA Methods 150.1, 360.1, 170.1, and 120.1, (126)). Calibration data should be recorded in a permanent log.

11.12.2 A known-quality water should be included in the analyses of each batch of water samples (for example, water hardness, alkalinity, conductivity). It is desirable to include certified standards in the analysis of water samples.

11.13 *Replication and Test Sensitivity*—The sensitivity of sediment tests will depend in part on the number of replicates/treatment, the significance level selected, and the type of statistical analysis. If the variability remains constant, the sensitivity of a test will increase as the number of replicates is increased. The minimum recommended number of replicates varies with the objectives of the test and the statistical method used for analysis of the data (see Section 15).

#### 11.14 *Demonstrating Acceptable Performance:*

11.14.1 Intralaboratory precision, expressed as a coefficient of variation, of the range for each type of test to be used in a laboratory can be determined by performing five or more tests with different batches of test organisms, using the same reference toxicant, at the same concentrations, with the same test conditions (for example, the same test duration, type of water, age of test organisms, feeding), and same data analysis methods. A reference-toxicant concentration series (0.5 or higher) should be selected that will provide partial mortalities at two or more concentrations of the test chemical (see Section 10.3.3). Information from previous tests can be used to improve the design of subsequent tests to optimize the dilution series selected for testing.

11.14.2 Before conducting tests with potentially contaminated sediment, it is strongly recommended that the laboratory conduct the tests with control sediment(s) alone. Results of

these preliminary studies should be used to determine if the use of the control sediment and other test conditions (i.e., water quality) result in acceptable performance in the tests as outlined in Sections 13 and 14 and in Annex A1 to Annex A7.

11.14.3 Laboratories should demonstrate that their personnel are able to recover an average of at least 90 % of the organisms from whole sediment. For example, test organisms could be added to control or test sediments, and recovery could be determined after 1 h (166).

#### 11.15 Documenting Ongoing Laboratory Performance:

11.15.1 Outliers, which are data falling outside the control limits and trends of increasing or decreasing sensitivity are readily identified. If the data from a given test falls outside the “expected” range (for example,  $\pm 2$  SD), the sensitivity of the organisms and the credibility of the test results may be suspect. In this case, the test procedure should be examined for defects and should be repeated with a different batch of test organisms.

11.15.2 A sediment test may be acceptable if specified conditions of a reference-toxicity test fall outside the expected ranges (see 11.10). Specifically, a sediment test should not be judged unacceptable if the LC50 for a given reference-toxicity test falls outside the expected range or if control survival in the reference-toxicity test is <90 %. All the performance criteria outlined in 13.1.2 and 14.1.2 or in Annex A1 to Annex A7 must be considered when determining the acceptability of a sediment test. The acceptability of the sediment test would depend on the experience and judgment of the investigator and the regulatory authority.

11.15.3 Performance should improve with experience, and the control limits should gradually narrow, as the statistics stabilize. However, control limits of  $\pm 2$  SD, by definition, will be exceeded 5 % of the time, regardless of how well a laboratory performs. For this reason, good laboratories that develop very narrow control limits may be penalized if a test result which falls just outside the control limits is rejected *de facto*. The width of the control limits should be considered in decisions regarding rejection of data (see Section 17).

#### 11.16 Reference-toxicity Testing:

11.16.1 Historically, reference-toxicant testing has been thought to provide three types of information relevant to the interpretation of toxicity test data: (1) an indication of the relative “health” of the organisms used in the test; (2) a demonstration that the laboratory can perform the test procedure in a consistent manner; and (3) information to indicate whether the sensitivity of the particular strain or population in use at a laboratory is comparable to those in use in other facilities. With regard to the first type of information, recent work by McNulty et al. (105) suggests that reference-toxicant tests may not be effective in identifying stressed populations of test organisms. In addition, reference-toxicant tests recommended for use with sediment toxicity tests are short-term, water column tests, owing in part to the lack of a standard sediment for reference-toxicity testing. Because the test procedures for reference-toxicant tests are not the same as for the sediment toxicity tests of interest, the applicability of reference-toxicity tests to demonstrate ability to reproducibly perform the sediment test procedures is greatly reduced. Particularly for the long-term sediment toxicity tests with *H.*

*azteca* and *C. dilutus* (formerly known as *C. tentans*; Shobanov et al. 1999. (1), performance of control organisms over time may be a better indicator of success in handling and testing these organisms (Annex A6 and Annex A7).

11.16.2 Although the requirement for monthly testing has been removed in this current version of this standard, periodic reference testing should still be conducted as an indication of overall comparability of results among laboratories (at a minimum, 6 tests over a 3 year period should be conducted to evaluate potential differences in life stage or genetic strain of test organisms). In particular, reference-toxicity tests should be performed more frequently when organisms are obtained from outside sources, when there are changes in culture practices, or when brood stock from an outside source is incorporated into a laboratory culture.

11.16.3 Reference toxicants such as potassium chloride (KCl), cadmium chloride (CdCl<sub>2</sub>), and copper sulfate (CuSO<sub>4</sub>) are suitable for use. (See Table 10 and Table 11.) No one reference toxicant can be used to measure the condition of test organisms in respect to another toxicant with a different mode of action (167). However, it may be unrealistic to test more than one or two reference toxicants routinely. Potassium chlorine has been used successfully in round-robin water-only exposures with *H. azteca* and *C. dilutus* (see Section 17).

11.16.4 Test conditions for conducting reference-toxicity tests with *H. azteca* and *C. dilutus* are outlined in Tables 10 and 11. The procedures outlined in Tables 10 and 11 can also be used for conducting reference-toxicity tests with the test organisms outlined in Annex A1 to Annex A7. Reference-toxicity tests can be conducted using one organism/chamber or multiple organisms in each chamber. Some laboratories have observed low control survival when more than one midge/chamber is tested in water-only exposures.

11.17 Record Keeping— Section 15.1 outlines recommendations for recorded keeping (i.e., data files, chain-of custody).

## 12. Collection, Culturing, and Maintaining Test Organisms

12.1 Life Histories— The following sections describe life histories and culturing procedures for *Hyalella azteca* and *Chironomus dilutus* (formerly known as *C. tentans*; Shobanov et al. 1999. (1). Annex A1 to Annex A7 describe life histories and culturing procedures for the additional test organisms.

### 12.1.1 *Hyalella azteca*:

12.1.1.1 *Hyalella azteca* inhabit permanent lakes, ponds, and streams throughout North and South America (168, 163). Occurrence of *H. azteca* is most common in warm (20 to 30°C for much of the summer) mesotrophic or eutrophic lakes which support aquatic plants. This amphipod is also found in ponds, sloughs, marshes, rivers, ditches, streams, and springs, but in lower numbers. *Hyalella azteca* have achieved densities of >10 000 m<sup>-2</sup> in preferred habitats (168).

12.1.1.2 *Hyalella azteca* is an epibenthic detritivore that burrows into the sediment surface. Hargrave (169) reported that *H. azteca* selectively ingests bacteria and algae. The behavior and feeding habits of *H. azteca* make them excellent test organism for sediment assessments.

12.1.1.3 Reproduction by *H. azteca* is sexual. The adult males are larger than females and males have larger second gnathopods (168). Males pair with females by grasping the females (amplexus) with their gnathopods while on the backs of the females. After feeding together for 1 to 7 days the female is ready to molt and the two organisms separate for a short time while the female sheds her old exoskeleton. Once the exoskeleton is shed, the two organisms reunite and copulation occurs. The male places sperm near the marsupium of the female and her pleopods sweep the sperm into the marsupium. The organisms again separate and the female releases eggs from her oviducts into the marsupium where the eggs are fertilized. *Hyaella azteca* average about 18 eggs/brood (163) with larger organisms having more eggs (170).

12.1.1.4 The developing embryos and newly hatched young are kept in the marsupium until the next molt. At 24 to 28°C, hatching ranges from 5 to 10 days after fertilization (170-172). The time between molts for females is 7 to 8 days at 26 to 28°C (172). Therefore, about the time embryos hatch, the female molts and releases the young. *Hyaella azteca* average 15 broods in 152 days (163). Pairing of the sexes is simultaneous with embryo incubation of the previous brood in the marsupium. *Hyaella azteca* have a minimum of nine instars (173). There are 5 to 8 pre-reproductive instars (170) and an indefinite number of post-reproductive instars. The first five instars form the juvenile stage of development, instar Stages 6 and 7 form the adolescent stage when sexes can be differentiated, instar Stage 8 is the nuptial stage and all later instars are the adult stages of development (163).

12.1.1.5 *Hyaella azteca* have been successfully cultured at illuminance of about 100 to 1000 lx (11, 130, 174). *Hyaella azteca* avoid bright light, preferring to hide under litter during the day and feed.

12.1.1.6 Temperatures tolerated by *H. azteca* range from 0 to 33°C (171, 172, 175). At temperatures <10°C the organisms rest and are immobile (176, 177). At temperatures of 10 to 18°C, reproduction can occur. Juveniles grow more slowly at colder temperatures and become larger adults. Smaller adults with higher reproduction are typical when organisms are grown at 18 to 28°C. The highest rates of reproduction occur at 26 to 28°C (177) while lethality occurs at 33 to 37°C (175, 178).

12.1.1.7 *Hyaella azteca* are found in waters of widely varying types. *Hyaella azteca* can inhabit saline waters up to 29 ppt; however, their distribution in these saline waters has been correlated to water hardness (116). *Hyaella azteca* inhabit water with high magnesium concentrations at conductivities up to 22 000 µS/cm, but only up to 12 000 µS/cm in sodium-dominated waters (116). de March (168) reported *H. azteca* were not collected from locations where calcium was <7 mg/L. *Hyaella azteca* have been cultured in water with a salinity up to 15 ppt in reconstituted salt water (116, 119). In laboratory studies, Sprague (175) reported a 24-h LC50 for dissolved oxygen at 20°C of 0.7 mg/L. Pennak and Rosine (179) reported similar findings. Nebeker et al (180) reported 48-h and 30-day LC50s for *H. azteca* of <0.3 mg/L dissolved oxygen. Weight and reproduction of *H. azteca* were reduced after 30-day exposure to 1.2 mg/L dissolved oxygen.

12.1.1.8 *Hyaella azteca* tolerate a wide range of substrates. Ingersoll and Nelson (130) and Ingersoll et al (85) reported that *H. azteca* tolerated sediments ranging from more than 90 % silt- and clay-sized particles to 100 % sand-sized particles without detrimental effects on either survival or growth. *Hyaella azteca* tolerated a wide range in grain size and organic matter in 10- to 42-day tests with formulated sediment (60; Ingersoll et al., (56)). Ankley et al (58) evaluated the effects of natural sediment physico-chemical characteristics on the results of 10-day laboratory toxicity tests with *H. azteca* and *C. dilutus*. Tests were conducted with and without the addition of exogenous food. Survival of organisms was decreased in tests without added food. Physico-chemical sediment characteristics including grain size and TOC were not significantly correlated to the response of *H. azteca* in either fed or unfed tests. See Section A6.4 for additional detail regarding studies of the influence grain size in long-term sediment toxicity tests with *H. azteca*.

#### 12.1.2 *Chironomus dilutus*:

12.1.2.1 *Chironomus dilutus* have a holarctic distribution (181) and are commonly found in eutrophic ponds and lakes (182, 183). Midge larvae are important in the diet of fish and waterfowl (184-187). Larvae of *C. dilutus* usually penetrate a few centimeters into sediment. In both lotic and lentic habitats with soft bottoms, about 95 % of the chironomid larvae occur in the upper 10 cm of substrate, very few larvae are found below 40 cm (181). Larvae were found under the following conditions in British Columbia lakes by Topping (188): particle size <0.15 mm to 2.0 mm, temperature 0 to 23.3°C, dissolved oxygen 0.22 to 8.23 mg/L, pH 8.0 to 9.2, conductivity 481 to 4136 µΩ/cm, and sediment organic carbon 1.9 to 15.5 %. Larvae were absent from lakes if hydrogen sulfide concentration in overlying water exceeded 0.3 mg/L. Abundance of larvae was positively correlated with conductivity, pH, amount of food, percentages of particles in the 0.59 to 1.98-mm size range, and concentrations of Na, K, Mg, Cl, SO<sub>4</sub>, and dissolved oxygen. Others (for example, (189, 190)) have reported a temperature range from 0 to 35°C and a pH range from 7 to 10.

12.1.2.2 *Chironomus dilutus* are aquatic during the larval and pupal stages. The life cycle of *C. dilutus* can be divided into four distinct stages: (1) an egg stage, (2) a larval stage, consisting of four instars, (3) a pupal stage, and (4) an adult stage. Mating behavior has been described by Sadler (184) others (2). Males are easily distinguished from females because males have large, plumose antennae and a much thinner abdomen with visible genitalia. The male has paired genital claspers on the posterior tip of the abdomen (181). The adult female weighs about twice as much as the male, with about 30 % of the female weight contributed by eggs. After mating, adult females oviposit a single transparent, gelatinous egg case directly into the water. An egg case contains about 2300 eggs (184). At USEPA Duluth, the females oviposit eggs within 24 h of emergence. Egg cases contain a variable number of eggs from about 500 to 2000 eggs/egg case (USEPA (2)) and will hatch in 2 to 4 days at 23°C. Under optimal conditions larvae will pupate and emerge as adults after about 21 days at 23°C. Larvae begin to construct tubes (or cases) on the second or third day after hatching. The cases lengthen and enlarge as the

larvae grow with the addition of small particles bound together with threads from the mouths of larvae (184). The larvae draw food particles inside the tubes and also feed in the immediate vicinity of either end of the open-ended tubes with their caudal extremities anchored within the tube. The four larval stages are followed by a black-colored pupal stage (lasting about 3 days) and emergence to a terrestrial adult (imago) stage. The adult stage lasts for 3 to 5 days, during which the adults mate during flight and the females oviposit their egg cases (2 to 3 days postemergence, (184)).

12.1.2.3 *Chironomus dilutus* tolerate a wide range of substrates. Grain size tolerance of *C. dilutus* in sediment exposures are described in Section 14.4 for 10-day tests and in A7.4 for long-term exposures.

## 12.2 General Culturing Procedures:

12.2.1 Acceptability of a culturing procedure is based in part on performance of organisms in culture and in the sediment test (see Section 5 and 11.2). No single technique for culturing test organisms is recommended. What may work well for one laboratory may not work as well for another laboratory. While a variety of culturing procedures are outlined in 12.3 for *H. azteca* and in 12.4 for *C. dilutus*, organisms must meet the test acceptability requirements listed in 13.1.2 or 14.1.2. Culturing procedures are outlined for the additional test organisms in Annex A1 to Annex A7.

12.2.2 All organisms in a test must be from the same source. Organisms may be obtained from laboratory cultures or from commercial or government sources. The test organism used should be identified using an appropriate taxonomic key and verification should be documented. Obtaining organisms from wild populations should be avoided unless organisms are cultured through several generations in the laboratory. In addition, the ability of the wild population to crossbreed with existing laboratory populations should be determined. The sensitivity of the wild population to select chemicals (for example, Table 2) should also be documented (Duan et al. (165)).

12.2.3 Test organisms obtained from commercial sources should be shipped in well-oxygenated water in insulated containers to maintain temperature during shipment. Temperature and dissolved oxygen of the water in the shipping containers should be measured on arrival to determine if the organisms might have been subjected to low dissolved oxygen or temperature fluctuations. The temperature of the shipped water should be gradually adjusted to the desired culture temperature at a rate not exceeding 2°C/24 h. Additional reference-toxicity testing is suggested if organisms are not cultured at the testing laboratory (see 11.16).

12.2.4 A group of organisms should not be used for a test if they appear to be unhealthy, discolored, or otherwise stressed (for example, >20 % mortality for 48 h before the start of a test). If the organisms fail to meet these criteria, the entire batch should be discarded and a new batch should be obtained. All organisms should be as uniform as possible in age and life stage. Test organisms should be handled as little as possible. When handling is necessary, it should be done as gently, carefully, and as quickly as possible.

12.2.5 *Hyalella azteca*, *C. dilutus*, and the test organisms described in Annex A1 to Annex A7 can be cultured in a variety of waters. Water of a quality sufficient to culture fathead minnows (*Pimephales promelas*) or cladocerans will generally be adequate.

12.2.5.1 Variable success has been reported using reconstituted waters to culture or test *H. azteca* (See 7.1.3).

12.2.5.2 Organisms can be cultured using either static or renewal procedures. Renewal of water is recommended to limit loss of the culture organisms from a drop in dissolved oxygen or a buildup of waste products. In renewal systems, there should be at least one volume addition/day of culture water to each chamber. In static systems, the overlying water volume should be changed at least weekly by siphoning down to a level just above the substrate and slowly adding fresh water. Extra care should be taken to ensure that proper water quality is maintained in static systems. For example, aeration is needed in static systems to maintain dissolved oxygen at >2.5 mg/L.

12.2.5.3 A recirculating system using an under-gravel filter has been used to culture amphipods and midges (2). The approach for using a recirculating system to culture organisms has been described by (191-193). Under-gravel filters can be purchased from aquarium suppliers and consist of an elevated plate with holes that fit on the bottom of an aquarium. The plate has a standpipe to which a pump can be attached. Gravel or an artificial substrate (for example, plastic balls or multi-plate substrates) are placed on the plate. The substrates provide surface area for microorganisms that use nitrogenous compounds. A simple example of a recirculating system is two aquaria positioned one above the other with a total volume of 120 L. The bottom aquarium contains the under-gravel filter system, gravel, or artificial substrate, and a submersible pump. The top aquarium is used for culture of animals and has a hole in the bottom with a standpipe for returning overflow water to the bottom aquarium. Water lost to evaporation is replaced weekly and water is replaced at one to two-month intervals. Cultures fed foods such as fish food flakes<sup>10</sup> should include limestone gravel to help avoid depression in pH. Recirculating systems require less maintenance than static systems.

12.2.6 Cultures should be maintained at 23°C with a 16L:8D photoperiod at a illuminance of about 100 to 1000 lx (2). Cultures should be observed daily. Water temperature should be measured daily or continuously and dissolved oxygen should be measured weekly. It may be desirable for laboratories to periodically perform 96-h water-only reference-toxicity tests to assess the sensitivity of culture organisms (see Section 11.16.2). Data from these reference-toxicity tests could be used to assess genetic strain or life-stage sensitivity to select chemicals. The previous requirement for laboratories to conduct monthly reference-toxicity tests in an earlier version of this standard (Test Method E1706-95b) has not been included as a requirement for testing sediments due to the inability of reference-toxicity tests to identify stressed populations of test organisms (105). Culture water hardness, alkalinity, ammonia, and pH should be measured at least quarterly and the day before the start of a sediment test. If reconstituted water is used to culture organisms, water quality should be measured on each

batch of reconstituted water. Culture procedures should be evaluated and adjusted as appropriate to restore or maintain the health of the culture.

### 12.3 *Culturing Procedures for Hyalella azteca*:

12.3.1 The culturing procedures described as follows are based on methods described in (2), (7), (56), (58), (130), (194), (195). If the objective of the study is to follow the test method for *H. azteca* outlined in 13.1.2, the culturing procedure must produce 7- to 14-day old amphipods to start the 10-day test (see 13.1.2). The 10-day test with *H. azteca* should start with a narrower range in size or age of *H. azteca* (i.e., 1- to 2-day range in age) to reduce potential variability in growth at the end of a 10-day test. This narrower range would be easiest to obtain using known-age organisms (i.e., section 12.3.2 or 12.3.4) instead of sieving the cultures (Section 12.3.5) to obtain similar-sized amphipods (i.e., amphipods within a range from 1 to 2-days old will be more uniform in size than organisms within a range of 7-days old). The culturing procedure must produce 7- to 8-day-old amphipods to start a long-term test with *H. azteca* (Annex A6).

12.3.2 The following procedure described by Brooke et al (7) and USEPA Duluth (194) can be used to obtaining known-age amphipods to start a test. Mature amphipods (50 organisms  $\geq$ 30-days old at 23°C) are held in 2-L glass beakers containing 1 L of aerated culture water. Amphipods are fed 10 mL of the yeast-cereal leaves<sup>8</sup>-trout chow (YCT) mixture (Annex A8) and 10 mL of the green algae *Selenastrum capricornutum* (about  $3.5 \times 10^7$  cells/mL) on Monday. Five milliliters of food are added to cultures on Wednesdays and Fridays.

12.3.2.1 Water in the culture chambers is changed weekly. Survival of adults and juveniles and production of young amphipods should be measured at this time. The contents of the culture chambers are poured into a translucent white plastic pan or white enamel pan. After the adults are removed, the remaining amphipods (about 200) will range in ages from <1 to 7-days old. Young amphipods are transferred with a pipet into a 1-L beaker containing culture water and are held for one week before starting a toxicity test. Cotton gauze should be soaked in water for 24 h before use and should be renewed weekly. Presoaked cotton gauze is placed in the beakers and organisms are fed 10 mL of YCT and 5 mL of each food each following day (Annex A8). Survival of young amphipods should be >80 % during this one-week holding period. Records should be kept on the number of surviving adults, number of breeding pairs, and young production and survival. This information can be used to develop control charts which are useful in determining if cultures are maintaining a vigorous reproductive rate indicative of culture health. Some of the adult amphipods can be expected to die in the culture chambers, but mortality greater than about 50 % should be cause for concern. Typical reproductive rates in culture chambers containing 60 adults can be as high as 900 young/week. A decrease in reproductive rate may be caused by a change in water quality, temperature, food quality, or brood stock health. Adult females will continue to reproduce for several months.

12.3.3 A second procedure for obtaining known-age amphipods is described by Borgmann et al (196). Known-age

amphipods are cultured in 2.5-L chambers containing about 1 L of culture water and between 5 and 25 adult *H. azteca*. Each chamber contains pieces of cotton gauze presoaked in culture water. Once a week the test organisms are isolated from the gauze and collected using a sieve. Amphipods are then rinsed into petri dishes where the young and adults are sorted. The adults are returned to the culture chambers containing fresh water and food.

12.3.4 A third procedure for obtaining known-age amphipods is described by Greer (195) and Tomasovic et al (166, 56). Mass cultures of mixed-age amphipods are maintained in 80-L glass aquaria containing about 50 L of water (130). A flaked food (e.g., fish food flakes<sup>10</sup>) are added to each culture chamber receiving daily water renewals to provide about 20 g dry solids/50 L of water twice weekly in a 80-L culture chamber. Additional flaked food is added when most of the flaked food has been consumed. Laboratories using static systems should develop lower feeding rates specific to their systems. Each culture chamber has a substrate of maple leaves and artificial substrates (six 20-cm diameter sections/80-L aquaria of “coiled-web material”<sup>11</sup>). Before use, leaves are soaked in 30 ppt salt water for about 30 days to reduce the occurrence of planaria, snails, or other organisms in the substrate. The leaves are then flushed with water for 1 h to remove the salt water and residuals of naturally occurring tannic acid before placement in the cultures.

12.3.4.1 To obtain known-age amphipods, a U.S. Standard Sieve No. 25 (710- $\mu$ m mesh) is placed under water in a chamber containing mixed-age amphipods. A No. 25 sieve will retain mature amphipods and immature amphipods will pass through the mesh. Two or three pieces of artificial substrate<sup>11</sup> or a mass of leaves with the associated mixed-age amphipods are quickly placed into the sieve. The sieve is brought to the top of the water in the culture chamber keeping all but about 1 cm of the sieve under water. The artificial substrates or leaves are then shaken under water several times to dislodge the attached amphipods. The artificial substrates or leaves are taken out of the sieve and placed back in the culture chamber. The sieve is agitated in the water to rinse the smaller amphipods back into the culture chamber. The larger amphipods remaining in the sieve are transferred with a pipet into a dish and then placed into a shallow glass pan (for example, a pie pan) where immature amphipods are removed. The remaining mature amphipods are transferred using a pipet into a second No. 25 sieve which is held in a glass pan containing culture water.

12.3.4.2 The mature amphipods are left in the sieve in the pan overnight to collect any newborn amphipods that are released. After 24 h, the sieve is moved up and down several times to rinse the newborn amphipods (<24-h old) into the surrounding water in the pan. The sieve is removed from the pan and the mature amphipods are placed back into their culture chamber or placed in a second glass pan containing culture water if additional organisms are needed for testing. The newborn amphipods are moved with a pipet and placed in a culture chamber with flowing water during a grow-out

<sup>11</sup> Nylon screen, such as Nitex, is available from a variety of commercial sources, has been found suitable for this purpose.

period. The newborn amphipods should be counted to determine if adequate numbers have been collected for the test. Methods have recently been developed to hold the newborn amphipods using flow-through conditions before the start of a test.

12.3.4.3 Isolation of about 1500 (750 pairs) of adults in amplexus provided about 800 newborn amphipods in 24 h and required about six man-hours of time. Isolation of about 4000 mixed-age adults (some in amplexus and others not in amplexus) provided about 800 newborn amphipods in 24 h and required less than one man-hour of time. The newborn amphipods can be held for 6 to 13 days to provide 7- to 14-day old organisms to start a 10-day test (see Section 13) or should be held for 7 days to provide 7- to 8-day-old organisms to start a long-term test (Annex A6). The neonates are held in a 2-L beaker for 6 to 13 days before the start of a test. On the first day of isolation, the neonates are fed 10 mL of YCT (1800 mg/L stock solution) and 10 mL of *Selenastrum capricornutum* (about  $3.5 \times 10^7$  cells/mL). On the third, fifth, seventh, ninth, eleventh, and thirteenth days after isolation, the amphipods are fed 5 mL of both YCT and *S. capricornutum*. Amphipods are initially fed a higher volume to establish a layer of food on the bottom of the culture chamber. If dissolved oxygen drops below 4 mg/L, about 50 % of the water should be replaced (Ingersoll et al., (56)).

12.3.5 Laboratories that use mixed-age amphipods for testing must demonstrate that the procedure used to isolate amphipods will produce test organisms that are 7 to 14-days old if procedures outlined in 13.1.4 are to be followed. For example, Winger and Lasier (119) reported amphipods passing

through a U.S. Standard No. 35 sieve (500  $\mu\text{m}$ ), but stopped by a No. 45 sieve (355  $\mu\text{m}$ ) averaged 1.54 mm (standard deviation (SD) 0.09) in length. The mean length of these sieved organisms corresponds to that of 6-day old amphipods (see Fig. 1). After holding for 3 days before testing to eliminate organisms injured during sieving, these amphipods were about 9-days old (length 1.84 mm, SD 0.11) at the start of a toxicity test.

12.3.5.1 Ingersoll and Nelson (130) describe the following procedure for obtaining mixed-age amphipods of a similar size to start a test. Smaller amphipods are isolated from larger amphipods using a stack of U.S. Standard sieves: No. 30 (600  $\mu\text{m}$ ), No. 40 (425  $\mu\text{m}$ ), and No. 60 (250  $\mu\text{m}$ ). Sieves should be held under water to isolate the amphipods. Amphipods may float on the surface of the water if they are exposed to air. Artificial substrate or leaves are placed in the No. 30 sieve. Culture water is rinsed through the sieves and small amphipods stopped by the No. 60 sieve are washed into a collecting pan. Larger amphipods in the No. 30 and No. 40 sieves are returned to the culture chamber. The smaller amphipods are then placed in 1-L beakers containing culture water and food (about 200 amphipods/beaker) with gentle aeration.

12.3.5.2 Amphipods should be held and fed at a similar rate to the mass cultures for at least 2 days before the start of a test to eliminate animals injured during handling.

12.3.6 See 12.2.6 for procedures used to evaluate the health of cultures.

12.4 *Culturing Procedures for Chironomus dilutus:*

12.4.1 The culturing methods described as follows are based on methods described in (2), (9), (58), (194), (195). If

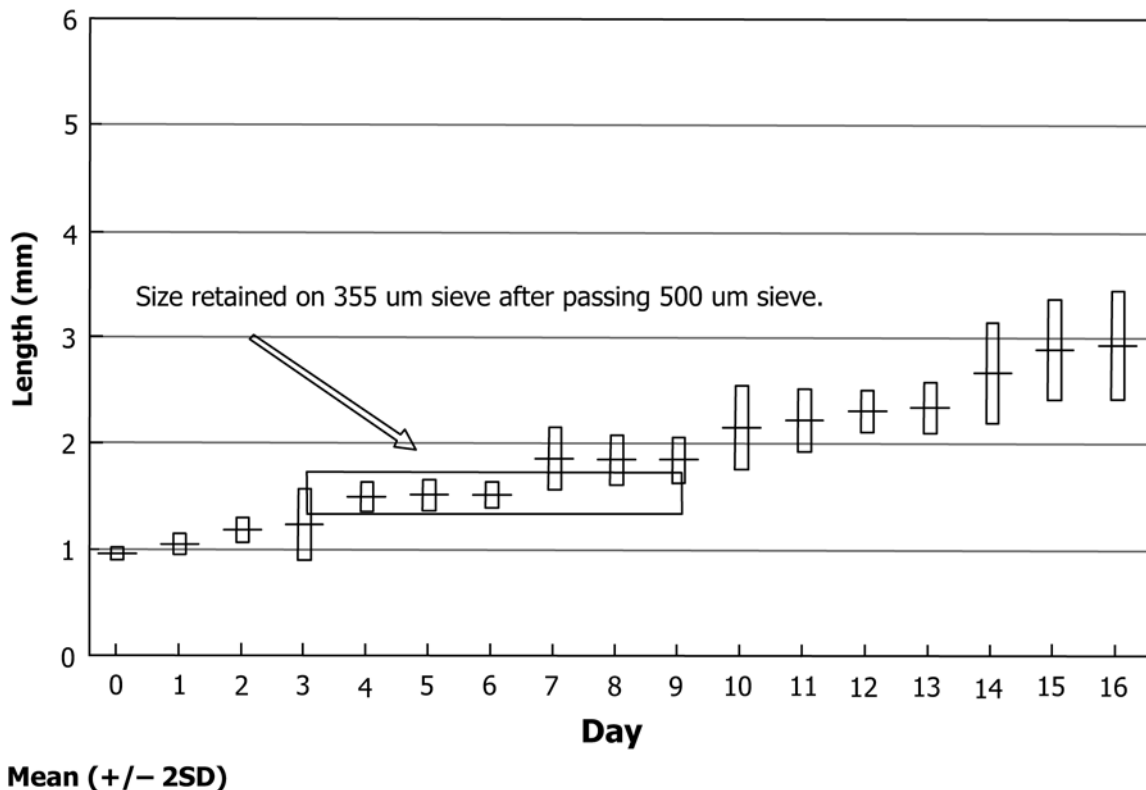

FIG. 1 Length and Relative Age of *Hyalella azteca* Collected by Sieving in Comparison with Length of Known-Age Organisms (119)

The objective of the study is to follow the test method for *C. dilutus* outlined in 14.1.2, a 10-day test must be started with second- to third-instar larvae (about 10-day larvae Fig. 2). At a temperature of 23°C, larvae should develop to the third instar by 9 to 11 days after hatching (about 11 to 23 days post-oviposition). The instar of midges at the start of a test can be determined using head capsule width (see 14.1.2 and Table 12), weight, or length (average length of midge larvae should be about 4 to 6 mm or average dry weight should be about 0.08 to 0.23 mg/individual at the start of the test (2)). Historically, third-instar larvae were frequently referred to as second instar in the published literature. When larvae were measured daily, the *C. dilutus* raised at 22 to 24°C were third instar, not second instar 9 to 11 days after hatching (2). A long-term test with *C. dilutus* must be started with larvae less than 24-h old (see Section A7.3 for a description of an approach for obtaining *C. dilutus* larvae less than 24-h old).

12.4.2 Both silica sand and shredded paper toweling have been used as substrates to culture *C. dilutus*. Either substrate may be used if a healthy culture can be maintained. Greer (195) used sand or paper toweling to culture midges; however, sand was preferred due to the ease in removing larvae for testing. Sources of sand are listed in Section 7.

12.4.2.1 Paper towels are prepared according to a procedure adapted from (198). Plain white kitchen paper towels or brown towels are cut into strips. Cut toweling is loosely packed into a blender with culture water and blended for a few seconds. Small pieces should be available to the organism; blending for too long will result in a fine pulp that will not settle in culture tank. Blended towels can then be added directly to culture tanks eliminating any conditioning period for the substrate. A mass of the toweling sufficient to fill a 150-mL beaker is placed into a blender containing 1 L of deionized water, and blended for 30 s or until the strips are broken apart in the form of a pulp. The pulp is then sieved using a 710-µm sieve and thoroughly rinsed with deionized water to remove the shortest fibers.

12.4.2.2 Dry shredded paper toweling loosely packed into a 2-L beaker will provide sufficient substrate for about ten 19-L chambers (194). The shredded toweling placed in a 150-mL beaker produces enough substrate for one 19-L chamber. Additional substrate can be frozen in deionized water for later use.

12.4.3 Five egg cases will provide a sufficient number of organisms to start a new culture chamber. Egg cases should be held at 23°C in a glass beaker or crystallizing dish containing about 100 to 150 mL of culture water (temperature change should not exceed 2°C/day). Food is not added until the embryos start to hatch (in about 2 to 4 days at 23°C) to reduce the risk of oxygen depletion. A small amount of green algae (for example, a thin green layer) is added to the water when

TABLE 12 *Chironomus dilutus* Instar and Head Capsule Widths (197)

Instar	Days After Hatching	Mean, mm	Range, mm
First	1 to 4.4	0.10	0.09 to 0.13
Second	4.4 to 8.5	0.20	0.18 to 0.23
Third	8.5 to 12.5	0.38	0.33 to 0.45
Fourth	12.5–	0.67	0.63 to 0.71

embryos start to hatch. When most of the larvae have left the egg case, 150 to 200 larvae should be placed into a culture chamber. Crowding of larvae will reduce growth. See 12.4.4.1 or 12.4.5.1 for a description of feeding rates. Larvae should reach the third instar by about 10 days after median hatch (about 12 to 14 days after the time the eggs were laid).

12.4.4 *Chironomus dilutus* are cultured in soft water at the USEPA in Duluth (USEPA, (115)) in glass aquaria (19.0-L capacity, 36- × 21- × 36-cm high). A water volume of about 6 to 8 L in these flow-through chambers can be maintained by drilling an overflow hole in one end 11 cm from the bottom. The top of the aquarium is covered with a mesh material to trap emergent adults. Pantyhose with the elasticized waist is positioned around the chamber top and the legs are cut off. Fiberglass-window screen glued to a glass-strip (about 2- to 3-cm wide) rectangle placed on top of each aquarium has also been used by Call et al. (8). About 200 to 300 mL of 40 mesh silica sand is placed in each chamber.

12.4.4.1 The stocking density of the number of *C. dilutus* eggs should be about 600 eggs per 6 to 8 L of water. Dawson et al. (199) found that the cultures in 15 L aquaria and 7 L of water were self-regulating in density regardless of the initial number of eggs stocked in each tank. However, tanks with a higher initial stocking density (i.e., 1400 eggs) exhibited increased the time of peak adult emergence to 30 to 33 days while tanks with lower densities of 600 or 1000 eggs had peak emergence at 22 to 25 days after hatching.

12.4.4.2 Fish food flakes (i.e., Tetrafin®) are added to each culture chamber to provide a final food concentration of about 0.04 mg dry solids/mL of culture water. A stock suspension of the solids is blended with distilled water to form an initial slurry. It is then filtered through a 200 micron Nixtex screen and diluted with distilled water to form a 56 g dry solids/L final slurry (Annex A8). The larvae in each tank are fed 2.5 mL of slurry (140 mg of Tetrafin per day) from Day 0 to Day 7 and 5 mL of slurry (280 mg Tetrafin per day) from Day 8 on. Feeding is done after the water renewal process is completed. The stock suspension should be well mixed immediately before removing an aliquot for feeding. Each batch of food should be refrigerated and can be used for up to two weeks (Annex A8). Laboratories using static systems should develop lower feeding rates specific to their systems

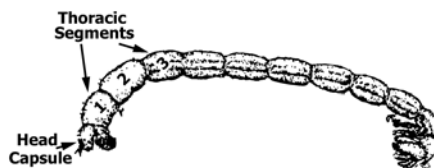

FIG. 2 *Chironomus dilutus* larvae. Note thoracic segments which are used to measure instars.

12.4.5 *Chironomus dilutus* are cultured by Greer (195) in 5.7-L polyethylene cylindrical containers. The containers are modified by cutting a semicircle into the lid 17.75 cm across by 12.5 cm. Stainless steel screen (20 mesh/0.4 cm) is cut to size and melted to the plastic lid. The screen provides air exchange, retains emerging adults, and is a convenient way to observe the culture. Two holes about 0.05 cm in diameter are drilled through the uncut portion of the lid to provide access for an air line and to introduce food. The food access hole is closed with a No. 00 stopper. Greer (195) cultures midges under static conditions with moderate aeration and about 90 % of the water is replaced weekly. Each 5.7-L culture chamber contains about 3 L of water and about 25 mL of fine sand. Eight to ten chambers are used to maintain the culture.

12.4.5.1 Midges in each chamber are fed 2 mL/day of a 100 g/L suspension of fish food flakes on Tuesday, Wednesday, Thursday, Friday, and Sunday. A 2-mL *Chlorella* suspension of deactivated *Chlorella* suspension is added to each chamber on Saturday and Monday. The *Chlorella* suspension is prepared by adding 5 g of dry *Chlorella* powder/L of water. The mixture should be refrigerated and can be used for up to two weeks.

12.4.5.2 The water should be replaced more often if animals appear stressed (for example, at surface or pale color at the second instar) or if the water is cloudy. Water is replaced by first removing emergent adults with an aspirator. Any growth on the sides of the chamber should be brushed off before water is removed. Care should be taken not to pour or siphon out the larvae when removing the water. Larvae will typically stay near the bottom; however, a small mesh sieve or nylon net can be used to catch any larvae that float out. After the chambers have been cleaned, temperature-adjusted culture water is poured back into each chamber. The water should be added quickly to stir up the larvae. Using this procedure, the approximate size, number, and the general health of the culture can be observed.

12.4.6 Adult emergence will begin about three weeks after hatching at 23°C. Once adults begin to emerge, they can be gently siphoned into a dry aspirator flask on a daily basis. An aspirator can be made using a 250 or 500-mL Erlenmeyer flask, a two-hole stopper, some short sections of 0.25-in. glass tubing, and plastic tubing for collecting and providing suction (see Fig. 3). Adults should be aspirated with short inhalations to avoid injuring organisms. The mouthpiece on the aspirator should be replaced or disinfected between use. The sex ratio of the adults should be checked to ensure that a sufficient number of males are available for mating and fertilization. One male may fertilize more than one female. However, a ratio of one male to three females improves fertilization.

12.4.6.1 A mating and oviposition chamber may be prepared in several different ways (see Figs. 3 and 4). About 50 to 75 mL of culture water can be added to the aspiration flask in which the adults were collected (see Fig. 3; (198)). USEPA Duluth (194) used a 500-mL collecting flask (see Fig. 4), which includes a length of nylon screen<sup>12</sup> positioned vertically and extending into the water when water is added. The nylon screen<sup>12</sup> is used by the females to position themselves just

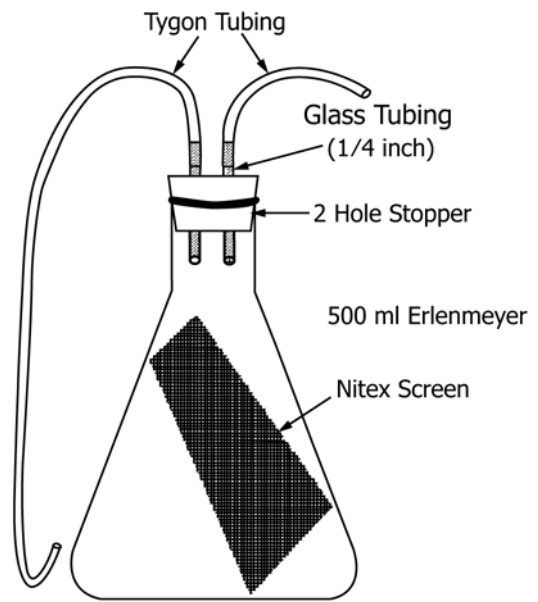

FIG. 3 Aspirators for Isolating Adult Midges

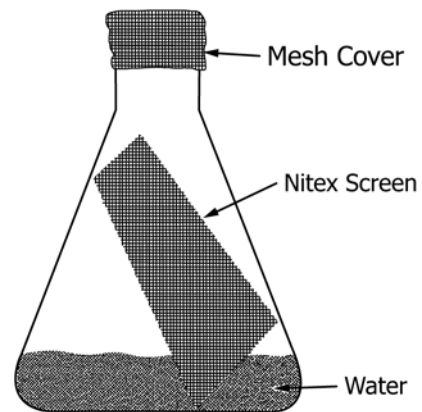

FIG. 4 Oviposition Chamber for Adult Midges

above the water during oviposition. The two-hole stopper and tubing of the aspirator should be replaced by screened material or a cotton plug for good air exchange in the oviposition chamber.

12.4.6.2 Greer (195) used an oviposition box to hold emergent adults which is constructed of a 5.7-L chamber with a 20-cm tall cylindrical chamber on top. The top chamber is constructed of stainless steel screen (35 mesh/2.54 cm) melted onto a plastic lid with a 17.75-cm hole. A 5-cm hole is cut into the side of the bottom chamber and a No. 11 stopper is used to close the hole. Egg cases are removed by first sliding a piece of plexiglass between the top and bottom chambers. Adult midges are then aspirated from the bottom chamber. The top chamber with plexiglass is removed from the bottom chamber and forceps are used to remove the egg cases. The top chamber is put back on top of the bottom chamber, the plexiglass is removed, and the aspirated adults are released from the aspirator into the chamber through the 5-cm hole.

12.4.7 About two to three weeks before the start of a test, 3 to 5 egg cases should be isolated for hatching using procedures outlined in 12.4.3.

<sup>12</sup> Coiled-wed material is available from 3-M, St. Paul, MN.



12.4.8 Records should be kept on the time to first emergence and the success of emergence for each culture chamber. It is also desirable to monitor growth and head capsule width periodically in the cultures. See 12.2.6 for additional detail on procedures for evaluating the health of the cultures.

### 13. Procedure 1: Conducting a 10-day Sediment Toxicity Test with *Hyalella azteca*

#### 13.1 Introduction:

13.1.1 *Hyalella azteca* (Saussure), Amphipoda, have many desirable characteristics of an ideal sediment toxicity testing organism including: relative sensitivity to contaminants associated with sediment, short generation time, contact with sediment, ease of culture in the laboratory, tolerance to varying physico-chemical characteristics of sediment, and their response has been evaluated in interlaboratory studies and has been confirmed with natural benthos populations (Table 1). Many investigators have successfully used *H. azteca* to evaluate the toxicity of freshwater sediments (for example, (11, 18, 130, 119, 174, 200-202)). *Hyalella azteca* can also be used to evaluate the toxicity of estuarine sediments (up to 15 ppt salinity; (48, 144, 145, 203)). Endpoints typically monitored in 10-day sediment toxicity tests with *H. azteca* include survival and growth.

13.1.2 General procedures for conducting sediment toxicity tests with *H. azteca* are outlined in Table 13, Annex A6 outlines additional procedures for evaluating sublethal effects of sediment-associated contaminants with *H. azteca* in long-term exposures. These general procedures can be used to

conduct sediment toxicity tests with *H. azteca*. Methods outlined in Table 13 and in USEPA (2) were used for developing the specific test method described in 13.2 and Table 14 for conducting a 10-day toxicity test with *H. azteca*. The activity schedule in Table 15 and the test acceptability requirements in Table 16 are applicable to the methods described in Table 13 and Table 14.

13.1.3 Results of tests using procedures different from the procedures described in 13.2 and Table 14 may not be comparable to tests conducted with the procedures outlined in Table 13. Comparison of results obtained using modified versions of these procedures might provide useful information concerning new concepts and procedures for conducting sediment tests with aquatic organisms. If tests are conducted with procedures different from the procedures described in these test methods, additional tests are required to determine comparability of results (see Section 1).

#### 13.2 Recommended Test Method for Conducting a 10-day Sediment Toxicity Test with *Hyalella azteca*:

13.2.1 Recommended conditions for conducting a 10-day sediment toxicity test with *H. azteca* are summarized in Table 14. A general activity schedule is outlined in Table 15. Decisions concerning the various aspects of experimental design, such as the number of treatments, number of test chambers/treatment, and water quality characteristics should be based on the purpose of the test and the methods of data analysis (see Section 15). The number of replicates and concentrations tested depends in part on the significance level

**TABLE 13 Summary of Testing Procedures Used to Evaluate the Toxicity of Whole Sediments with *Hyalella azteca***

Condition	Citation							
	[1]	[2]	[3]	[4]	[5]	[6]	[7]	[8]
Temperature, °C	20	20	22	20–25	20–23	20–22	20	23
Light intensity (footcandles)	NR	25–50	NR	50–100	25–50	NR	50–100	50–100
Photoperiod	NR	16–8	16–8	16–8	16–8	16–8	16–8	16–8
Test chamber, mL	1000	1000	300	300	30–300	2500	250	300
Sediment volume, mL	200	200	100	40–50	5–100	~150	40	100
Overlying water volume, mL	800	100	175	160–200	20–150	~1350	200	175
Renewal rate of overlying water, additions/day	0	1–4	1–4	variable	0–2	0	static	2
Age of organisms, days	juvenile	juvenile	7–14	juvenile	7–14	0–7	juvenile	7–14
Size of organisms, mm	NR	1–2	NR	NR	1–2	NR	NR	1
Number of organisms/chamber	15	20	10	10	3–10	20	10	10
Number of replicate chambers/ treatment	NR	4	3	4	5–10	2	3	8
Food	RC	RC	YCT	RC	YCT, ML	TM	RC	YCT
Aeration	Yes	None	None	DO < 3	None	Yes	None	None
Overlying water	Natural	Natural	Natural	Natural	Reconstituted	Natural	Natural	Natural/ Reconstituted
Test duration, days	10	10–28	10	7	10	28	10	10
Endpoints	S	S,G,M	S	S	S	S,G	S	S,G
Test acceptability, survival, %	NR	80	80	80	80	NR	80	80

<sup>A</sup> Citations:

- [1] Nebeker et al (200)
- [2] Ingersoll and Nelson (130)
- [3] Ankley et al (5)
- [4] Burton et al (197)
- [5] Winger and Lasier (119)
- [6] Borgmann and Munawar (198)
- [7] Suedel and Rodgers (19)
- [8] USEPA (2)

Conditions:

Food: YCT = yeast-cerophyll-trout chow, RC = Rabbit chow, TM = Fish food flakes,<sup>12</sup> ML = maple leaves.  
 Endpoints: S = survival, G = growth (length or weight), M = maturation. NR: = not reported.

**TABLE 14 Test Conditions for Conducting a 10-day Sediment Toxicity Test with *Hyalella azteca***

Parameter	Conditions
1. Test type:	Whole-sediment toxicity test with renewal of overlying water
2. Temperature:	23 ± 1°C
3. Light quality:	Wide-spectrum fluorescent lights
4. Illuminance:	About 100 to 1000 lux
5. Photoperiod:	16L:8D
6. Test chamber:	300-mL high-form lipless beaker
7. Sediment volume:	100 mL
8. Overlying water volume:	175 mL
9. Renewal of overlying water:	2 volume additions/day; continuous or intermittent (e.g., one volume addition every 12 h)
10. Age of organisms:	7- to 14-day old (within a 1- to 2-day range in age) at the start of the test
11. Number of organisms/chamber:	10
12. Number of replicate chambers/treatment:	Depends on the objective of the test. Eight replicates are recommended for routine testing (see Section 15)
13. Feeding:	YCT food, fed 1.0 mL daily (1800 mg/L stock) to each test chamber. An earlier version of this standard (E1706-95b) recommended a feeding level of 1.5 mL of YCT daily; however this feeding level was revised to 1.0 mL to be consistent with the feeding level in long-term tests with <i>H. azteca</i> (Annex A6).
14. Aeration:	None, unless dissolved oxygen in overlying water drops below 2.5 mg/L.
15. Overlying water:	Culture water, well water, surface water, site water, or reconstituted water
16. Test chamber cleaning:	If screens become clogged during a test, gently brush the <i>outside</i> of the screen
17. Overlying water quality:	Hardness, alkalinity, conductivity, pH, and ammonia at the beginning and end of a test. Temperature and dissolved oxygen daily
18. Test duration:	10 d
19. Endpoints:	Survival and growth
20. Test acceptability:	Minimum mean control survival of 80 % and measurable growth of test organisms in the control sediment. See Table 16 for additional performance-based criteria.

selected and the type of statistical analysis. When variability remains constant, the sensitivity of a test increases as the number of replicates increase.

13.2.2 The 10-day sediment toxicity test with *H. azteca* must be conducted at 23°C with a 16L:8D photoperiod at an illuminance of about 100 to 1000 lx (Table 14). Test chambers are 300-mL high-form lipless beakers containing 100 mL of sediment and 175 mL of overlying water. Ten 7- to 14-day old amphipods are used to start a test. The 10-day test should start with a narrow range in size or age of *H. azteca* (i.e., 1- to 2-day range in age) to reduce potential variability in growth at the end of a 10-day test (Section 12.3.1). The number of replicates/treatment depends on the objective of the test. Eight replicates are recommended for routine testing (see Section 15). Amphipods in each test chamber are fed 1.0 mL of YCT food daily (2). The previous version of this standard (Test Method E1706-95b) recommended a feeding level of 1.5 mL of YCT daily; however, this feeding level was revised to 1.0 mL to be consistent with the feeding level the in long-term test with *H. azteca* (Annex A6). Slight variation in feeding amount in the 10-day test with *C. dilutus* did not influence the results of this test (Annex A9). Each chamber receives 2 volume additions/day of overlying water. Benoit et al. (127) and Zumwalt et al. (128), Leppanen and Maier (204), and Wall et al. (205) describe water-renewal systems that can be used to deliver overlying water. Overlying water can be culture water, well water, surface water, site water, or reconstituted water. For site-specific evaluations, the characteristics of the overlying water should be as similar as possible to the site at which sediment is collected. Requirements for test acceptability are summarized in Table 16.

### 13.3 General Procedures:

13.3.1 *Sediment into Test Chambers*—The day before the sediment test is started (Day -1) each sediment should be thoroughly homogenized and added to the test chambers (see 10.3.1). Sediment should be visually inspected to judge the extent of homogeneity. Excess water on the surface of the sediment can indicate separation of solid and liquid components. If a quantitative measure of homogeneity is required, replicate subsamples should be taken from the sediment batch and analyze for TOC, chemical concentrations, and particle size.

(1) Each test chamber should contain the same amount of sediment, determined either by volume or by weight. Overlying water is added to the chambers on Day -1 in a manner that minimizes suspension of sediment. This can be accomplished by gently pouring water along the sides of the chambers or by pouring water on to a baffle (for example, a circular piece of TFE-fluorocarbon with a handle attached) placed above the sediment to dissipate the force of the water. A test begins when the organisms are added to the test chambers (Day 0).

13.3.2 *Renewal of overlying water*—Renewal of overlying water is recommended during a test. At any particular time during the test, flow rates through any two test chambers should not differ by more than 10 %. Hardness, alkalinity, and ammonia concentrations in the water above the sediment, within a treatment, typically should not vary by more than 50 % during the test. Mount and Brungs (129) diluters have

**TABLE 15 General Activity Schedule for Conducting a 10-day Sediment Toxicity Test with *Hyalella azteca* (modified from (7))**

Day	Activity
-7	Separate known-age amphipods from the mass cultures and place in holding chambers. Begin preparing food for the test. There should be only a 1- to 2-day range in age of amphipods used to start the test.
-6 to -2	Feed and observe isolated amphipods, monitor water quality (e.g., temperature and dissolved oxygen).
-1	Feed and observe isolated amphipods, monitor water quality. Add sediment into each test chamber, place chambers into exposure system, and start renewing overlying water.
0	Measure total water quality (pH, temperature, dissolved oxygen, hardness, alkalinity, conductivity, ammonia). Transfer 10 amphipods into each test chamber. Release organisms under the surface of the water. Add 1.0 mL of YCT into each test chamber. Archive 20 test organisms for length determination or 80 test organisms for dry weight determination. Observe behavior of test organisms.
1 to 8	Add 1.0 mL of YCT food to each test chamber. Measure temperature and dissolved oxygen. Observe behavior of test organisms.
9	Measure total water quality.
10	Measure temperature and dissolved oxygen. End the test by collecting the amphipods with a sieve. Count survivors and prepare organisms for dry weight or length measurements.

**TABLE 16 Test Acceptability Requirements for a 10-day Sediment Toxicity Test with *Hyalella azteca***

- 
- A. It is recommended for conducting a 10-day test with *Hyalella azteca* that the following performance criteria be met:
1. Age of *H. azteca* at the start of the test must be between 7- to 14-days old. The test should start with a narrow range in size or age of *H. azteca* (i.e., 1- to 2-day range in age) to reduce potential variability in growth at the end of a 10-day test (Section 12.3.1).
  2. Average survival of *H. azteca* in the control sediment must be greater than or equal to 80 % at the end of the test. Growth of test organisms should be measurable in the control sediment at the end of the 10-day test (i.e., relative to organisms at the start of the test).
  3. Hardness, alkalinity, and ammonia of overlying water typically should not vary by more than 50 % during the test, and dissolved oxygen should be maintained above 2.5 mg/L in the overlying water.
- B. Performance-based criteria for culturing *H. azteca* include the following:
1. It may be desirable for laboratories to periodically perform 96-h water-only reference-toxicity tests to assess the sensitivity of culture organisms (Section 11.16.2). Data from these reference toxicity tests could be used to assess genetic strain or life-stage sensitivity of test organisms to select chemicals.
  2. Laboratories should track parental survival in the cultures and record this information using control charts if known-age cultures are maintained. Records should also be kept on the frequency of restarting cultures and the age of brood organisms.
  3. Laboratories should record the following water-quality characteristics of the cultures at least quarterly pH, hardness, alkalinity, and ammonia. Dissolved oxygen in the cultures should be measured weekly. Temperature of the cultures should be recorded daily. If static cultures are used it may be desirable to measure water quality more frequently.
  4. Laboratories should characterize and monitor background contamination and nutrient quality of food if problems are observed in culturing or testing organisms.
  5. Physiological measurements such as lipid content might provide useful information regarding the health of the cultures.
- C. Additional requirements:
1. All organisms in a test must be from the same source.
  2. Storage of sediments collected from the field should follow guidance outlined in Section 10.2.
  3. All test chambers (and compartments) should be identical and should contain the same amount of sediment and overlying water.
  4. Negative-control sediment and appropriate solvent controls must be included in a test. The concentration of solvent used must not adversely affect test organisms.
  5. Test organisms must be cultured and tested at 23°C (±1°C).
  6. The daily mean test temperature must be within ±1°C of 23°C. The instantaneous temperature must always be within ±3°C of 23°C.
  7. Natural physico-chemical characteristics of test sediment collected from the field should be within the tolerance limits of the test organisms.
- 

been modified for sediment testing and other automated water delivery systems have also been used (130, 131-128, (132)). Each water-delivery system should be calibrated before a test is started to verify that the system is functioning properly. Renewal of overlying water is started on Day -1 before the addition of test organisms and food on Day 0.

13.3.2.1 In water-renewal tests with one to four volume additions of overlying water/day, water quality characteristics generally remain similar to the inflowing water (5, 130); however, in static tests, water quality may change profoundly during the exposure (142). For example, in static whole-sediment tests, the alkalinity, hardness, and conductivity of overlying water more than doubled in several treatments during a four-week exposure (130). Additionally, concentrations of metabolic products (for example, ammonia) may also increase during static exposures and these compounds can either be directly toxic to the test organisms or may contribute to the toxicity of the contaminants in the sediment. Furthermore, changes in water quality characteristics such as hardness may influence the toxicity of many inorganic (206) and organic (207) contaminants. Although contaminant concentrations are reduced in the overlying water in water-renewal tests, organisms in direct contact with sediment generally receive a substantial proportion of a contaminant dose directly from either the whole sediment or from the interstitial water.

13.3.3 *Acclimation*—Test organisms must be cultured and tested at the same temperature. Ideally, test organisms should be cultured in the same water that will be used in testing. However, acclimation of test organisms to the test water is not required. If test organisms are to be acclimated, they could be held for 2 h in a 50 to 50 mixture of culture water to overlying

water, then for 2 h in a 25 to 75 mixture of culture water to overlying water, followed by a transfer into 100 % overlying water for 2 h (130).

13.3.4 *Placing Test Organisms in Test Chambers*—Amphipods should be introduced into the overlying water below the air-water interface. Test organisms can be pipeted directly into overlying water (5). Length should be measured on a subset of at least 20 organisms or weight should be measured on a subset of at least 80 organisms used to start the test. Test organisms should be handled as little as possible.

13.3.5 *Monitoring a Test*—All chambers should be checked daily and observations made to assess test organism behavior such as sediment avoidance. However, monitoring effects on burrowing activity of test organisms may be difficult because the test organisms are often not visible during the exposure. The operation of the exposure system should be monitored daily.

13.3.5.1 *Measurement of Overlying Water Quality Characteristics*—Conductivity, hardness, pH, alkalinity, dissolved oxygen, and ammonia should be measured in all treatments at the beginning and end of a test. Overlying water should be sampled just before water renewal from about 1 to 2 cm above the sediment surface using a pipet. It may be necessary to composite water samples from individual replicates. The pipet should be checked to make sure no organisms are removed during sampling of overlying water. Water quality should be measured for each new batch of water prepared for the test.

(1) Dissolved oxygen should be measured daily and should be maintained at a minimum of 2.5 mg/L (Guide E729). If a probe is used to measure dissolved oxygen in overlying water,

it should be thoroughly inspected between samples to make sure that organisms are not attached and should be rinsed between samples to minimize cross contamination. Aeration can be used to maintain dissolved oxygen in the overlying water above 2.5 mg/L (i.e., about 1 bubble/second in the overlying water). Dissolved oxygen and pH can be measured directly in the overlying water with a probe.

(2) Temperature should be measured at least daily in at least one test chamber from each treatment. The temperature of the water bath or the exposure chamber should be continuously monitored. The daily mean test temperature must be within  $\pm 1^\circ\text{C}$  of  $23^\circ\text{C}$ . The instantaneous temperature must always be within  $\pm 3^\circ\text{C}$  of  $23^\circ\text{C}$ .

13.3.6 *Feeding*—For each beaker, 1.0 mL of YCT is added from Day 0 to Day 9. Without addition of food, the test organisms may starve during exposures. However, the addition of the food may alter the availability of the contaminants in the sediment (35, 106). Furthermore, if too much food is added to the test chamber or if the mortality of test organisms is high, fungal or bacterial growth may develop on the sediment surface. Therefore, the amount of food added to the test chambers is kept to a minimum.

13.3.6.1 Suspensions of food should be thoroughly mixed before aliquots are taken. If excess food collects on the sediment, a fungal or bacterial growth may develop on the sediment surface, in which case feeding should be suspended for one or more days. A drop in dissolved oxygen below 2.5 mg/L during a test may indicate that the food added is not being consumed. Feeding should be suspended for the amount of time necessary to increase the dissolved oxygen concentration (2). If feeding is suspended in one treatment, it should be suspended in all treatments. Detailed records of feeding rates and the appearance of the sediment surface should be made daily.

13.3.7 *Ending a Test*—A consistent amount of time should be taken to examine sieved material for recovery of test organisms (for example, 5 min/replicate). Laboratories should demonstrate their personnel are able to recover an average of at least 90 % of the organisms from whole sediment. For example, test organisms could be added to control or test sediments and recovery could be determined after 1 h (166).

13.3.7.1 Any of the surviving amphipods in the water column or on the surface of the sediment can be pipeted from the beaker before sieving the sediment. Immobile organisms

isolated from the sediment surface or from sieved material should be considered dead. A #40 sieve (425  $\mu\text{m}$  mesh) can be used to remove amphipods from sediment. Alternatively, Kemble et al. (18) suggests sieving of sediment using the following procedure: (1) pour about half of the overlying water through a No. 50 (300- $\mu\text{m}$ ) U.S. Standard mesh sieve, (2) swirl the remaining water to suspend the upper 1 cm of sediment, (3) pour this slurry through the No. 50 mesh sieve and wash the contents of the sieve into an examination pan, (4) rinse the coarser sediment remaining in the test chamber through a No. 40 (425- $\mu\text{m}$ ) mesh sieve and wash the contents of this second sieve into an examination pan. Surviving test organisms can be removed from the two pans and counted. If length is to be measured (130), then the organisms can be preserved in 8 % sugar formalin solution or other substitutes for formalin (208). The sugar formalin solution is prepared adding 120 g of sucrose to 80 mL of formalin which is then brought to a volume of 1 L using deionized water. This stock solution is mixed with an equal volume of deionized water when used to preserve organisms.

13.3.8 *Test Data*—Survival and growth are measured at the end of the 10-day sediment toxicity test with *H. azteca*. Measuring growth may be a more sensitive toxicity endpoint compared to survival (15, 18, 56, 209). The duration of the 10-day test started with 7- to 14-day old amphipods is not long enough to determine sexual maturation or reproductive effects. The 42-day test (Annex A6) is designed to evaluate sublethal endpoints in sediment toxicity tests with *H. azteca*. See Section A6.4.5.2 for a discussion of measurement of length vs. dry weight in tests with *H. azteca*.

13.3.8.1 Amphipod body length ( $\pm 0.1$  mm) can be measured from the base of the first antenna to the tip of the third uropod along the curve of the dorsal surface (Fig. 5). Ingersoll and Nelson (130) describe the use of a digitizing system and microscope to measure lengths of *H. azteca*. Kemble et al. (18) photographed invertebrates (at magnification of 3.5x) and measured length using a computer-interfaced digitizing tablet. Antennal segment number can also be used to estimate length or weight of amphipods (2). Wet or dry weight measurements have also been used to estimate growth of *H. azteca* (2). If test organisms are to be used for an evaluation of bioaccumulation, it is not advisable to dry the sample before conducting the residue analysis. If conversion from wet weight to dry weight is necessary, aliquots of organisms can be weighed to establish

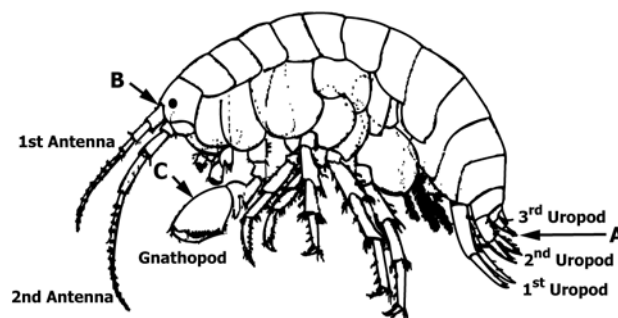

FIG. 5 *Hyalella azteca*. A: denotes the uropods, B: denotes the base of the first antennae. C: denotes the gnathopod used for grazing females. Measurement of length is made from base of the 3<sup>rd</sup> uropod (A) to (B). Females are recognized by the presence of egg cases or the absence of an enlarged gnathopod.

wet to dry weight conversion factors. A consistent procedure should be used to remove the excess water from the organisms before measuring wet weight.

13.3.8.2 Dry weight of amphipods should be determined by pooling all living organisms from a replicate and drying the sample at about 60 to 90°C to a constant weight. The sample is brought to room temperature in a desiccator and weighed to the nearest 0.01 mg to obtain mean weight per surviving organism per replicate (See Section A6.3.7.6). The previous version of the standard recommended dry weight as a measure of growth for both *H. azteca* and *C. dilutus* (formerly known as *C. tentans*; Shobanov et al. 1999. (1). For *C. dilutus*, this recommendation was changed in the current version to ash-free dry weight (AFDW) instead of dry weight, with the intent of reducing bias introduced by gut contents (Sibley et al.) (55). However, this recommendation was not extended to include *H. azteca*. Studies by Dawson et al. (personal communication, T.D. Dawson, Integrated Laboratory Systems, Duluth, MN) have indicated that the ash content of *H. azteca* is not greatly decreased by purging organisms in clean water before weighing, suggesting that sediment does not comprise a large portion of the overall dry weight. In addition, using AFDW further decreases an already small mass, potentially increasing measurement error. For this reason, dry weight continues to be the recommended endpoint for estimating growth of *H. azteca* via weight (growth can also be determined via length).

#### 13.4 Interpretation of Results:

13.4.1 Section 15 describes general information for interpretation of test results. The following sections describe species-specific information that is useful in helping to interpret the results of sediment toxicity tests with *H. azteca*.

13.4.2 Age Sensitivity—The sensitivity of *H. azteca* appears to be relatively similar up to at least 24 to 26-day old organisms (210). For example, the toxicity of diazinon, copper, cadmium, and zinc was similar in 96-h water-only exposures starting with 0 to 2-day old organisms through 24 to 26-day old organisms (see Fig. 6). The toxicity of alkylphenol ethoxylate (a surfactant) tended to increase with age. In general, this suggests that tests started with 7 to 14-day old amphipods would be representative of the sensitivity of *H. azteca* up to at least the adult life stage.

13.4.3 Grain Size—*Hyalella azteca* are tolerant of a wide range of substrates. Physico-chemical characteristics (for example, grain size or TOC) of sediment were not significantly correlated to the response of *H. azteca* in toxicity tests in which organisms were fed (see 12.1.1.8; (58)).

13.4.4 Isolating Organisms at the End of a Test—Quantitative recovery of young amphipods (for example, 0 to 7-day old) is difficult given their small size (see Fig. 7 (166)). Recovery of older and larger amphipods (for example, 21-days old) is much easier. This was a primary reason for deciding to start 10-day tests with 7 to 14-day old amphipods in Table 16 (organisms are 17 to 24-days old at the end of the 10-day test).

13.4.5 Influence of Indigenous Organisms—Survival of *H. azteca* in 28-day tests was not reduced in the presence of oligochaetes in sediment samples (102). However, growth of amphipods was reduced when high numbers of oligochaetes were placed in a sample. Therefore, it is important to determine

the number and biomass of indigenous organisms in field-collected sediment in order to better interpret growth data. (DeFoe and Ankley (140)). Furthermore, presence of predators may also influence the response of test organisms in sediment (130).

13.4.6 Ammonia toxicity—Section 1.6.3.5 addresses interpretative guidance for evaluating toxicity associated with ammonia in sediment.

## 14. Procedure 2: Conducting a 10-day Sediment Toxicity Test with *Chironomus dilutus*

### 14.1 Introduction:

14.1.1 *Chironomus dilutus* (formerly known as *C. tentans*; Shobanov et al. 1999. (1) Fabricius (Diptera: Chironomidae) have many desirable characteristics of an ideal sediment toxicity testing organism including: relative sensitivity to contaminants associated with sediment, contact with sediment, ease of culture in the laboratory, tolerance to varying physico-chemical characteristics of sediment, short generation time, and their response has been evaluated in interlaboratory studies and has been confirmed with natural benthos populations (Table 1). Many investigators have successfully used *C. dilutus* to evaluate the toxicity of freshwater sediments (for example, (5, 12, 41-44, 58, 200, 211-213). Endpoints typically monitored in 10-day sediment toxicity tests with *C. dilutus* include survival and growth (2).

14.1.2 General procedures for conducting sediment toxicity test with *C. dilutus* are outlined in Table 17. Annex A7 outlines additional procedures for evaluating sublethal effects of sediment-associated contaminants with *C. dilutus* in long-term exposures. These general procedures can be used to conduct sediment toxicity tests with *C. dilutus*. Methods outlined in Table 17 and in USEPA (2) were used for developing the specific test method described in 14.2 and Table 18 for conducting a 10-day toxicity test with *C. dilutus*. The activity schedule in Table 19 and the test acceptability requirements in Table 20 are applicable to the methods described in Table 17 and Table 18.

14.1.3 Results of tests using procedures different from the procedures described in 14.2 and Table 18 may not be comparable to tests conducted with the procedures outlined in Table 17. Comparison of results obtained using modified versions of these procedures might provide useful information concerning new concepts and procedures for conducting sediment tests with aquatic organisms. If tests are conducted with procedures different from the procedures described in these test methods, additional tests are required to determine comparability of results (see Section 1).

### 14.2 Recommended Test Method for Conducting a 10-day Sediment Toxicity Test with *Chironomus dilutus*:

14.2.1 Recommended conditions for conducting a 10-day sediment toxicity test with *C. dilutus* are summarized in Table 18. A general activity schedule is outlined in Table 19. Decisions concerning the various aspects of experimental design, such as the number of treatments, number of test chambers/treatment, and water quality characteristics should be based on the purpose of the test and the methods of data analysis (see Section 15). The number of replicates and

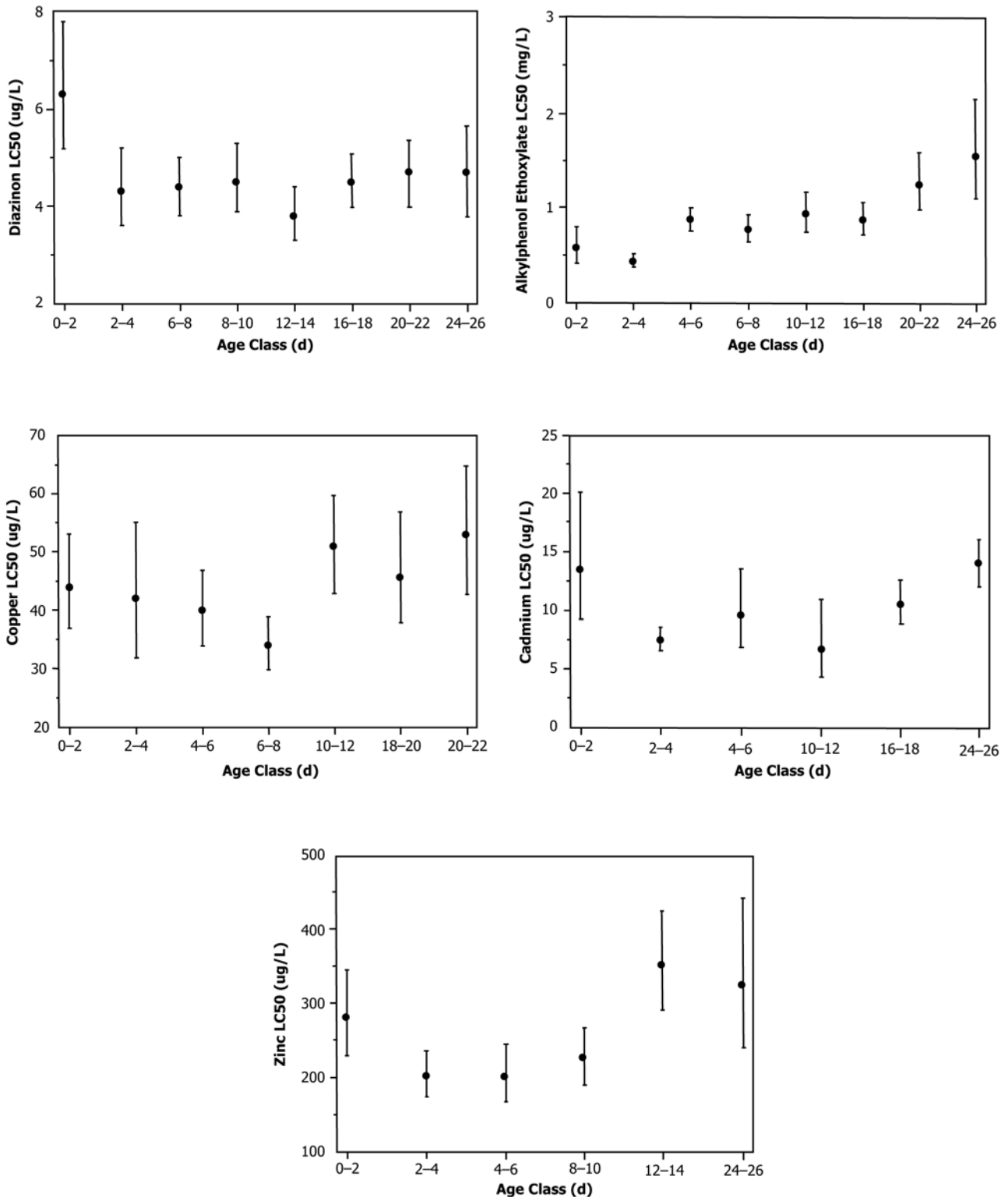

FIG. 6 Lifestage Sensitivity of *Hyalella azteca* in 96-h Water-Only Exposures (210)

concentrations tested depends in part on the significance level selected and the type of statistical analysis. When variability remains constant, the sensitivity of a test increases as the number of replicates increase.

14.2.2 The 10-day sediment toxicity test with *C. dilutus* must be conducted at 23°C with a 16L:8D photoperiod at an illuminance of about 100 to 1000 lx (Table 18). Test chambers are 300-mL high-form lipless beakers containing 100 mL of

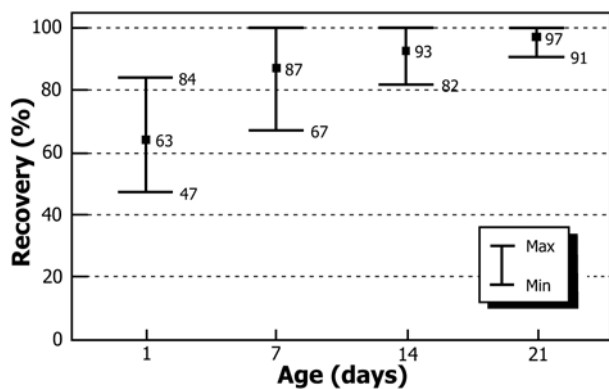

FIG. 7 Average Recovery of Different Age *Hyalella azteca* from Sediment by 7 Individuals (166)

sediment and 175 mL of overlying water. Ten second- to third-instar midges (about 10-day-old larvae) are used to start a test (12.4.1). The number of replicates/treatment depends on the objective of the test. Eight replicates are recommended for routine testing (see Section 15). Midges in each test chamber are fed 1.5 mL of a 4 g/L fish food flakes<sup>9</sup> suspension daily. The original feeding rate was 1.0 mL/day; however, subsequent feeding studies indicated a higher feeding rate is required when emergence tests are conducted with *C. dilutus* (2 and Annex A7 and Annex A8). Each chamber receives 2 volume additions/day of overlying water. Benoit et al. (127) and Zumwalt et al. (128), Leppanen and Maier (204), and Wall et al. (205) describe water-renewal systems that can be used to deliver overlying water. Overlying water can be culture water, well water, surface water, site water, or reconstituted water. For site-specific evaluations, the characteristics of the overlying water should be as similar as possible to the site at which sediment is collected. Requirements for test acceptability are summarized in Table 20.

### 14.3 General Procedures:

14.3.1 *Sediment into Test Chambers*—The day before the sediment test is started (Day -1) each sediment should be thoroughly homogenized and added to the test chambers (see 10.3.1). Sediment should be visually inspected to judge the extent of homogeneity. Excess water on the surface of the sediment can indicate separation of solid and liquid components. If a quantitative measure of homogeneity is required, replicate subsamples should be taken from the sediment batch and analyzed for TOC, chemical concentrations, and particle size.

14.3.1.1 Each test chamber should contain the same amount of sediment, determined either by volume or by weight. Overlying water is added to the chambers on Day -1 in a manner that minimizes suspension of sediment. This can be accomplished by gently pouring water along the sides of the chambers or by pouring water on to a baffle (for example, a circular piece of TFE-fluorocarbon with a handle attached) placed above the sediment to dissipate the force of the water. A test begins when the organisms are added to the test chambers (Day 0).

14.3.2 *Renewal of Overlying Water*—Renewal of overlying water is recommended during a test. At any particular time

during the test, flow rates through any two test chambers should not differ by more than 10%. Hardness, alkalinity, and ammonia concentrations in the water above the sediment, within a treatment, typically should not vary by more than 50% during the test. Mount and Brungs (129) diluters have been modified for sediment testing and other automated water-delivery systems have also been used (130, 131-128, 132). Each water-delivery system should be calibrated before a test is started to verify that the system is functioning properly. Renewal of overlying water is started on Day -1 before the addition of test organisms and food on Day 0.

14.3.2.1 In water-renewal tests with one to four volume additions of overlying water/day, water quality characteristics generally remain similar to the inflowing water (5,130); however, in static tests, water quality may change profoundly during the exposure (142). For example, in static whole-sediment tests, the alkalinity, hardness, and conductivity of overlying water more than doubled in several treatments during a four-week exposure (130). Additionally, concentrations of metabolic products (for example, ammonia) may also increase during static exposures and these compounds can either be directly toxic to the test organisms or may contribute to the toxicity of the contaminants in the sediment. Furthermore, changes in water quality characteristics such as hardness may influence the toxicity of many inorganic (206) and organic (207) contaminants. Although contaminant concentrations are reduced in the overlying water in water-renewal tests, organisms in direct contact with sediment generally receive a substantial proportion of a contaminant dose directly from either the whole sediment or from the interstitial water.

14.3.3 *Acclimation*—Test organisms must be cultured and tested at the same temperature. Ideally, test organisms should be cultured in the same water that will be used in testing. However, acclimation of test organisms to the test water is not required. If test organisms are to be acclimated, they could be held for 2 h in a 50 to 50 mixture of culture water to overlying water, then for 2 h in a 25 to 75 mixture of culture water to overlying water, followed by a transfer into 100% overlying water for 2 h (130).

14.3.4 *Placing Test Organisms in Test Chambers*—Test organisms should be handled as little as possible. Midges should be introduced into the overlying water below the air-water interface. Developmental stage of midges at the start of the exposure should be documented on a subset of at least 20 organisms (Section 12.4.1).

14.3.5 *Monitoring a Test*—All chambers should be checked daily and observations made to assess test organism behavior such as sediment avoidance. However, monitoring effects on burrowing activity of test organisms may be difficult because the test organisms are often not visible during the exposure. The operation of the exposure system should be monitored daily.

14.3.5.1 *Measurement of Overlying Water Quality Characteristics*—Conductivity, hardness, pH, alkalinity, dissolved oxygen, and ammonia should be measured in all treatments at the beginning and end of a test. Overlying water should be sampled just before water renewal from about 1 to 2 cm above the sediment surface using a pipet. It may be

**TABLE 17 Summary of Testing Procedures Used to Evaluate the Toxicity of Whole Sediments with *Chironomus dilutus***

Condition	Citation					
	[1]	[2]	[3]	[4]	[5]	[6]
Temperature, °C	20	22	22	23	22	23
Light intensity (footcandles)	NR	~100	NR	NR	NR	50–100
Photoperiod	NR	16–8	16–8	NR	NR	16–8
Test chamber, mL	1000	3000	300	50	2000	300
Sediment volume, mL	200	~250	100	~7.5	1500	100
Overlying water volume, mL	800	2000	175	47	~200	175
Renewal rate of overlying water, additions/day	0	0–5	1–4	0	0	2
Age of organisms, instar	Second	Second	Second	Second	Second	Second
Size of organisms	NR	0.15 mg	NR	0.5 g	6–8 mm	4–6 mm
Number of organisms/chamber	15	25	10	1	20	10
Number of replicate chambers/treatment	NR	2	NR	15	NR	8
Food	TM,CP	TM	TF	TF	None	TF
Aeration	Yes	None	None	Yes	Yes	None
Overlying water	Natural	Natural	Natural	Natural	Natural	Natural/ Reconstituted
Test duration, days	10	14	10	10	17	10
Endpoints	S,G	S,G	S,G	G	S,G	S,G
Test acceptability, survival %	NR	NR	70	NR	NR	80

<sup>4</sup> Citations:

- [1] Nebeker et al (200)
- [2] Adams et al (207)
- [3] Ankley et al (5)
- [4] Giesy et al (41)
- [5] Wentzel et al (42, 43, 44)
- [6] USEPA (2)

## Conditions:

Food: CP = cerophyll, RC = Rabbit chow, TM = Fish food flakes,<sup>12</sup> TF = Fish food flakes.<sup>11</sup>  
Endpoints: S = survival, G = growth (length or weight), M = maturation. NR: = not reported.

necessary to composite water samples from individual replicates. The pipet should be checked to make sure no organisms are removed during sampling of overlying water. Water quality should be measured on each new batch of water prepared for the test.

(1) Water-only exposures evaluating the tolerance of *C. dilutus* larva to depressed dissolved oxygen (DO) have indicated that significant reductions in weight occurred after 10-day exposure to 1.1 mg/L DO, but not at 1.5 mg/L (V. Mattson, USEPA, Duluth, MN, personal communication). This finding concurs with the observations during method development at USEPA Duluth that excursions of DO as low as 1.5 mg/L did not seem to have an effect on midge survival and development (P.K. Sibley, University of Guelph, Guelph, Ontario, personal communication). Based on these findings, periodic depressions of DO below 2.5 mg/L (but, not below 1.5 mg/L) are not likely to adversely affect test results, and thus should not be a reason to discard test data. Nonetheless, tests should be managed toward a goal of DO > 2.5 mg/L to insure satisfactory performance. If the DO level of the water falls below 2.5 mg/L for any one treatment, aeration is encouraged and should be done in all replicates for the duration of the test (i.e., about 1 bubble/second in the overlying water). Occasional brushing of screens on outside of beakers will help maintain the exchange of water during renewals using the water-renewal system described by Benoit et al. (127). If a probe is used to measure DO in overlying water, it should be thoroughly inspected between samples to make sure that organisms are not attached and should be rinsed between samples to minimize cross contamination.

(2) Temperature should be measured at least daily in at least one test chamber from each treatment. The temperature of the water bath or the exposure chamber should be continuously monitored. The daily mean test temperature must be within  $\pm 1^\circ\text{C}$  of  $23^\circ\text{C}$ . The instantaneous temperature must always be within  $\pm 3^\circ\text{C}$  of  $23^\circ\text{C}$ .

14.3.6 *Feeding*—For each beaker, 1.5 mL of Tetrafin® is added from Day 0 to Day 9. Without addition of food, the test organisms may starve during exposures. However, the addition of the food may alter the availability of the contaminants in the sediment (35, 106). Furthermore, if too much food is added to the test chamber or if the mortality of test organisms is high, fungal or bacterial growth may develop on the sediment surface. Therefore, the amount of food added to the test chambers is kept to a minimum.

14.3.6.1 Suspensions of food should be thoroughly mixed before aliquots are taken. If excess food collects on the sediment, a fungal or bacterial growth may develop on the sediment surface, in which case feeding should be suspended for one or more days. A drop in dissolved oxygen below 2.5 mg/L during a test may indicate that the food added is not being consumed. Feeding should be suspended for the amount of time necessary to increase the dissolved oxygen concentration (2). If feeding is suspended in one treatment, it should be suspended in all treatments. Detailed records of feeding rates and the appearance of the sediment surface should be made daily.

14.3.7 *Ending a Test*—A consistent amount of time should be taken to examine sieved material for recovery of test organisms (for example, 5 min/replicate). Laboratories should



**TABLE 18 Recommended Test Conditions for Conducting a 10-day Sediment Toxicity Test with *Chironomus dilutus***

Parameter	Conditions
1. Test type:	Whole-sediment toxicity test with renewal of overlying water
2. Temperature:	23 ± 1°C
3. Light quality:	Wide-spectrum fluorescent lights
4. Illuminance:	About 100 to 1000 lux
5. Photoperiod:	16L:8D
6. Test chamber:	300-mL high-form lipless beaker
7. Sediment volume:	100 mL
8. Overlying water volume:	175 mL
9. Renewal of overlying water:	2 volume additions/d; continuous or intermittent (e.g., one volume addition every 12 h)
10. Age of organisms:	Second- to third-instar larvae (12.4.1)
11. Number of organisms/chamber:	10
12. Number of replicate chambers/treatment:	Depends on the objective of the test. Eight replicates are recommended for routine testing (see Section 15)
13. Feeding:	Tetrafin® goldfish food, fed 1.5 mL daily to each test chamber (1.5 mL contains 6.0 mg of dry solids)
14. Aeration:	None, unless dissolved oxygen in overlying water drops below 2.5 mg/L.
15. Overlying water:	Culture water, well water, surface water, site water, or reconstituted water
16. Test chamber cleaning:	If screens become clogged during a test; gently brush the <i>outside</i> of the screen
17. Overlying water quality:	Hardness, alkalinity, conductivity, pH, and ammonia at the beginning and end of a test and on day 20. Temperature and dissolved oxygen daily
18. Test duration:	10 d
19. Endpoints:	Survival, growth (ash-free dry weight; AFDW)
20. Test acceptability:	Minimum mean control survival of 70 % with minimum mean weight per surviving control organism of 0.48 mg AFDW. Performance-based criteria specifications are outlined in Table 20.

**TABLE 19 General Activity Schedule for Conducting a 10-Day Sediment Toxicity Test With *Chironomus dilutus* (Modified from (8))**

Day	Activity
-14	Isolate adults for production of egg cases.
-13	Place newly deposited egg cases into hatching dishes.
-12	A larval rearing chamber is prepared with new substrate.
-11	Examine egg cases for hatching success. If egg cases have hatched, transfer first instar larvae and any remaining unhatched embryos from the crystallizing dishes into the larval rearing chamber. Feed organisms.
-10	Same as Day -11
-9 to -2	Feed and observe midges. Measure water quality (for example, temperature and dissolved oxygen).
-1	Add food to each larval rearing chamber and measure temperature and dissolved oxygen. Add sediment into each test chamber, place chamber into exposure system, and start renewing overlying water.
0	Measure total water quality (temperature, pH, hardness, alkalinity, dissolved oxygen conductivity, ammonia). Remove third-instar larvae from the culture chamber substrate. Add 1.5 mL of fish food flakes <sup>11</sup> (4.0 g/L) into each test chamber (see 14.2.2). Transfer 10 larvae into each test chamber. Release organisms under the surface of the water. Archive 20 test organisms for instar determination using head capsule width and determination of weight or length. Observe behavior of test organisms.
1 to 8	Add 1.5 mL of food to each test chamber. Measure temperature and dissolved oxygen. Observe behavior of test organisms.
9	Same as Day 1. Measure total water quality.
10	Measure temperature and dissolved oxygen. End the test by collecting the midges with a sieve. Measure weight or length of surviving larvae. Measure head capsule width.

*C. dilutus* in the previous version of this standard (Test Method E1706-95b), as well as most previous research, has used dry weight as a measure of growth. However, Sibley et al. (71) found that the grain size of sediments influences the amount of sediment that *C. dilutus* larvae ingest and retain in their gut. As a result, in finer-grain sediments, a substantial portion of the measured dry weight may be comprised of sediment in the gut rather than tissue. While this may not represent a strong bias in tests with identical grain size distributions in all treatments, most field assessments are likely to have varying grain size among sites. This will likely create differences in dry weight among treatments that are not reflective of true somatic growth. For this reason, weight of midges should be measured as ash-free dry weight (AFDW) instead of dry weight. AFDW will more directly reflect actual differences in tissue weight by reducing the influence of sediment in the gut. The duration of the 10-day test starting with third-instar larvae is not long enough to determine emergence of adults. Average size of *C. dilutus* in the control sediment must be at least 0.48 mg as AFDW at the end of the test (5, 214); Section 17). If test organisms are to be used for an evaluation of bioaccumulation, it is not advisable to dry the sample before conducting the residue analysis. If conversion from wet weight to dry weight is necessary, aliquots of organisms can be weighed to establish wet to dry weight conversion factors. A consistent procedure should be used to remove the excess water from the organisms before measuring wet weight.

14.3.8.1 For determination of AFDW, first pool all living larvae in each replicate and dry the sample to a constant weight (e.g., 60°C for 24 h). Note that the weigh boats should be ashed before use to eliminate weighing errors due to the pan oxidizing during ashing. The sample is brought to room

demonstrate their personnel are able to recover an average of at least 90 % of the organisms from whole sediment. For example, test organisms could be added to control or test sediments and recovery could be determined after 1 h (166).

14.3.7.1 Immobile organisms isolated from the sediment surface or from sieved material should be considered dead. A #40 sieve (425 µm mesh) can be used to remove midges from sediment. Alternatively Kemble et al. (18) suggests sieving of sediment using the following procedure: (1) pour about half of the overlying water through a No. 50 (300-µm) U.S. Standard mesh sieve, (2) pour about half of the sediment through the No. 50 mesh sieve and wash the contents of the sieve into an examination pan, (3) rinse the coarser sediment remaining in the test chamber through a No. 40 (425-µm) mesh sieve and wash the contents of this second sieve into an examination pan. Surviving midges can then be isolated from these pans. See 14.3.8.1 and 14.3.8.2 for the procedures for measuring weight or length of midges.

14.3.8 Test Data—Ash-free dry weight (AFDW) and survival are the endpoints measured at the end of the 10-day sediment toxicity test with *C. dilutus*. The 10-day method for

**TABLE 20 Test Acceptability Requirements for a 10-day Sediment Toxicity Test with *Chironomus dilutus***

- 
- A. It is recommended for conducting a 10-day test with *C. dilutus* that the following performance criteria are met:
1. Tests must be started with second- to third-instar larvae (about 10-day-old larvae. Section 12.4.1)
  2. Average survival of *C. dilutus* in the control sediment must be greater than or equal to 70 % at the end of the test.
  3. Average size of *C. dilutus* in the control sediment must be at least 0.48 mg AFDW at the end of the test.
  4. Hardness, alkalinity, and ammonia in the overlying water typically should not vary by more than 50 % during the test, and dissolved oxygen should be maintained above 2.5 mg/L in the overlying water.
- B. Performance-based criteria for culturing *C. dilutus* include the following:
1. It may be desirable for laboratories to periodically perform 96-h water-only reference-toxicity tests to assess the sensitivity of culture organisms (Section 11.16.2). Data from these reference toxicity tests could be used to assess genetic strain or life-stage sensitivity of test organisms to select chemicals.
  2. Laboratories should keep a record of time to first emergence for each culture and record this information using control charts. Records should also be kept on the frequency of restarting cultures.
  3. Laboratories should record the following water-quality characteristics of the cultures at least quarterly: pH, hardness, alkalinity, and ammonia. Dissolved oxygen in the cultures should be measured weekly. Temperature of the cultures should be recorded daily. If static cultures are used, it may be desirable to measure water quality more frequently.
  4. Laboratories should characterize and monitor background contamination and nutrient quality of food if problems are observed in culturing or testing organisms.
  5. Physiological measurements such as lipid content might provide useful information regarding the health of the cultures.
- C. Additional requirements:
1. All organisms in a test must be from the same source.
  2. Storage of sediments collected from the field should follow guidance outlined in Section 10.2.
  3. All test chambers (and compartments) should be identical and should contain the same amount of sediment and overlying water.
  4. Negative-control sediment and appropriate solvent controls must be included in a test. The concentration of solvent used must not adversely affect test organisms.
  5. Test organisms must be cultured and tested at 23°C (±1°C).
  6. The daily mean test temperature must be within ±1°C of 23°C. The instantaneous temperature must always be within ±3°C of 23°C.
  7. Natural physico-chemical characteristics of test sediment collected from the field should be within the tolerance limits of the test organisms.
- 

temperature in a dissicator and weighed to the nearest 0.01 mg to obtain mean weights per surviving organism per replicate. The dried larvae in the pan are then ashed at 550°C for 2 h. The pan with the ashed larvae is then re-weighed and the tissue mass of the larvae is determined as the difference between the weight of the dried larvae plus pan and the weight of the ashed larvae plus pan. In rare instances, where preservation is required, an 8 % sugar formalin solution can be used to preserve samples, but the effects of preservation on the weights and lengths of the midges have not been sufficiently studied. Pupae or adult organisms must not be included in the sample to estimate ash-free dry weight. If head capsule width is to be measured, it should be measured on surviving midges at the end of the test before ash-free dry weight is determined.

14.3.8.2 Measurement of length is optional. Separate replicate beakers should be set up to sample lengths of midges at the end of an exposure. An 8 % sugar formalin solution can be used to preserve samples for length measurements (130) or other substitutes for formalin can be used as a substitute for formalin (208). The sugar formalin solution is prepared by adding 120 g of sucrose to 80 mL of formalin which is then brought to a volume of 1 L using deionized water. This stock solution is mixed with an equal volume of deionized water when used to preserve organisms. Midge body length (±0.1 mm) can be measured from the anterior of the labrum to the posterior of the last abdominal segment (215). Kemble et al (18) photographed midges at magnification of 3.5× and measured the images using a computer-interfaced digitizing tablet. A digitizing system and microscope can also be used to measure length (130).

#### 14.4 Interpretation of Results:

14.4.1 Section 15 describes general information for interpretation of test results. The following sections describe species-specific information that is useful in helping to interpret the results of sediment toxicity tests with *C. dilutus*.

14.4.2 *Age Sensitivity*—Midges are perceived to be relatively insensitive organisms in toxicity assessments (216). This conclusion is based on the practice of measuring survival of fourth-instar larvae in short-term water-only exposures, a procedure that may underestimate the sensitivity of midges to toxicants. The first and second instars of chironomids are more sensitive to contaminants than the third or fourth instars. For example, first-instar *C. dilutus* larvae were 6 to 27 times more sensitive than fourth-instar larvae to acute copper exposure ((206, 217); Fig. 8) and first-instar *C. riparius* larvae were 127 times more sensitive than second-instar larvae to acute cadmium exposure ((218); Fig. 8). In chronic tests with first-instar larvae, midges were often as sensitive as daphnids to inorganic and organic compounds (33). Sediment tests should be started with uniform age and size midges because of the dramatic differences in sensitivity of midges by age. While, third-instar midges are not as sensitive as younger organisms, the larger larvae are easier to handle and isolate from sediment at the end of a test. DeFoe and Ankley (140) studied a variety of contaminated sediments and showed that the sensitivity of *C. dilutus* 10-day tests is greatly increased by measurement of growth in addition to survival. Growth of midges in 10-day sediment tests was found to be a more sensitive endpoint than survival of *Hyaella azteca* (DeFoe and Ankley) (140). In cases where sensitivity of organisms before the third instar is of interest, the long-term sediment exposures can be used, since these exposures begin with newly hatched larvae (A7.4).

#### 14.4.3 Physical Characteristics of Sediments

14.4.3.1 *Grain Size*: Larvae of *C. dilutus* appear to be tolerant of a wide range of particle size conditions in substrates. Several studies have shown that survival is not affected by particle size in natural sediments, sand substrates, or formulated sediments in both 10-day and long-term exposures (Ankley et al. (101); Suedel and Rodgers (60); Sibley et al. (71), (219)). Ankley et al. (58) found that growth of *C. dilutus*

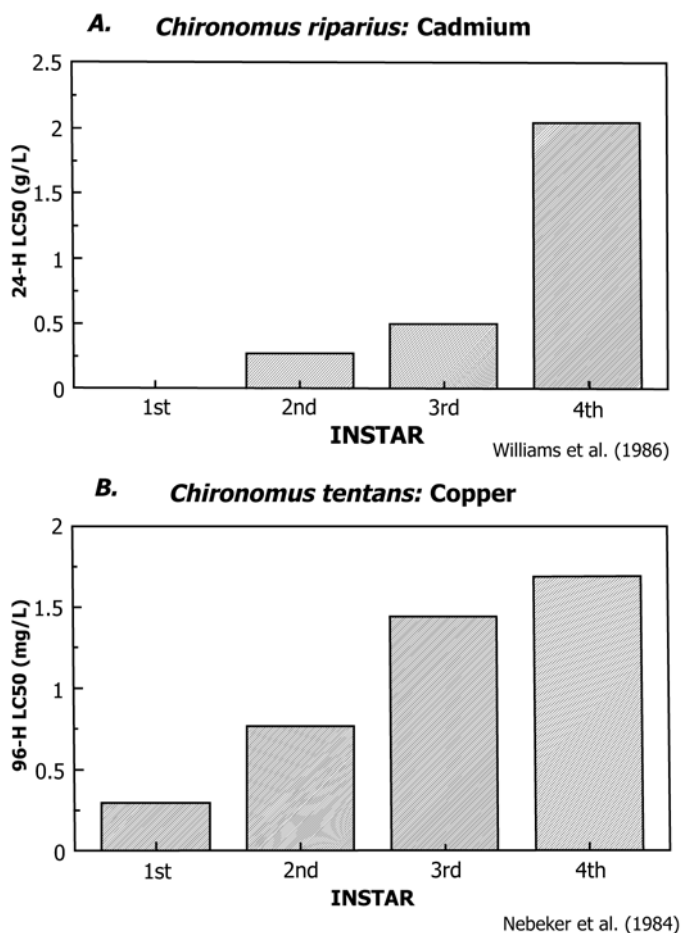

FIG. 8 Life-Stage Sensitivity of *Chironomids*: (A) Williams et al (218) and (B) Nebeker et al (217)

larvae was weakly correlated with sediment grain size composition, but not organic carbon, in 10-day tests using 50 natural sediments from the Great Lakes. However, Sibley et al. (71) found that the correlation between grain size and larval growth disappeared after accounting for inorganic material contained within larval guts and concluded that growth of *C. dilutus* was not related to grain size composition in either natural sediments or sand substrates. Avoiding confounding influences of gut contents on weight is the impetus for recommending ash-free dry weight (instead of dry weight) as the index of growth in the 10-day and long-term *C. dilutus* tests. Failing to do so could lead to erroneous conclusions regarding the toxicity of the test sediment (Sibley et al. (71)). Procedures for correcting for gut contents are described in Section 14.3.8. Emergence, reproduction (mean eggs/female), and hatch success were also not affected by the particle size composition of substrates in long-term tests with *C. dilutus* (Sibley et al. (219); Annex A7).

14.4.3.2 *Organic Matter*: Based on 10-day tests, the content of organic matter in sediments does not appear to affect survival of *C. dilutus* larvae in natural and formulated sediments, but may be important with respect to larval growth. Ankley et al. (58) found no relationship between sediment organic content and survival or growth in 10-day bioassays with *C. dilutus* in natural sediments. Suedel and Rodgers (60)

observed reduced survival in 10-day tests with a formulated sediment when organic matter was <0.91 %; however, supplemental food was not supplied in this study, which may influence these results relative to the 10-day test procedures described in this standard. Lacey et al (220) found that survival of *C. dilutus* larvae was generally not affected in 10-day tests by either the quality or quantity of synthetic (alpha-cellulose) or naturally derived (peat, maple leaves) organic material spiked into a formulated sediment, although a slight reduction in survival below the acceptability criterion (70%) was observed in a natural sediment diluted with formulated sediment at an organic matter content of 6 %. In terms of larval growth, Lacey et al. (220) did not observe any systematic relationship between the level of organic material (e.g. food quantity) and larval growth for each carbon source. Although a significant reduction in growth was observed at the highest concentration (10 %) of the leaf treatment in the food quantity study, significantly higher larval growth was observed in this treatment when the different carbon sources were compared at about equal concentrations (effect of food quality). In the latter study, the following gradient of larval growth was established in relation to the source of organic carbon: peat < natural sediment < alpha-cellulose < leaves. Since all of the treatments received a supplemental source of food, these data suggest that both the quality and quantity of organic carbon in natural and formulated sediments may represent an important confounding factor for the growth endpoint in tests with *C. dilutus* (Lacey et al.) (220). However, it is important to note, that these data are based on 10-day tests; the applicability of these data to long-term testing has not been evaluated (Annex A7).

14.4.4 *Isolating Organisms at the End of a Test*— Quantitative recovery of larvae at the end of a 10-day sediment test should not be a problem.

14.4.5 *Influence of Indigenous Organisms*— The influence of indigenous organisms on the response of *C. dilutus* in sediment tests has not been reported. Survival of a closely related species, *C. riparius* was not reduced in the presence of oligochaetes in sediment samples (102). However, growth of *C. riparius* was reduced when high numbers of oligochaetes were placed in a sample. Therefore, it is important to determine the number and biomass of indigenous organisms in field-collected sediment in order to better interpret growth data. (DeFoe and Ankley) (140). Furthermore, presence of predators may also influence the response of test organisms in sediment (130).

14.4.6 *Sexual dimorphism*— Differences in size between males and females of a closely related midge species (*Chironomus riparius*) had little effect on interpretation of growth-related effects in sediment tests (<3 % probability of making a Type I error [non-toxic sample classified as toxic] due to sexual dimorphism: Day et al. (221)). Therefore, sexual dimorphism will probably not be a confounding factor when interpreting growth results measured in sediment tests with *C. dilutus*.

14.4.7 *Ammonia toxicity*— Section 1.6.3.5 addresses interpretative guidance for evaluating toxicity associated with ammonia in sediment.

## 15. Calculation

### 15.1 Data Recording:

15.1.1 Quality assurance project plans with data quality objectives and standard operating procedures should be developed before starting a test. Procedures should be developed by each laboratory to verify and archive data (153).

15.1.2 A file should be maintained for each sediment test or group of tests on closely related samples (see Section 11). This file should contain a record of the sample chain-of-custody; a copy of the sample log sheet; the original bench sheets for the test organism responses during the sediment test(s); chemical analysis data on the sample(s); control data sheets for reference toxicants; detailed records of the test organisms used in the test(s), such as species, source, age, date of receipt, and other pertinent information relating to their history and health; information on the calibration of equipment and instruments; test conditions used; and results of reference-toxicant tests. Original data sheets should be signed and dated by the laboratory personnel performing the tests. A record of the electronic files of data should also be included in the file.

## 15.2 Data Analysis:

15.2.1 Statistical methods are used to make inferences about populations, based on samples from those populations. In most sediment tests, test organisms are exposed to chemicals in sediment to estimate the response of the population of laboratory organisms. The organism response to these sediments is usually compared with the response to a control or reference sediment. In any sediment test, summary statistics such as means and standard errors for response variables (for example, survival, chemical concentrations in tissue) should be provided for each treatment (for example, pore-water concentration, sediment concentration).

15.2.1.1 *Types of Data*—Two types of data can be obtained from sediment tests. The most common endpoint in toxicity testing is mortality, which is a dichotomous or categorical type of data. Other endpoints might include growth and reproduction. These types of endpoints are representative of continuous data.

15.2.1.2 *Sediment Testing Scenarios*—Sediment tests are conducted to determine whether contaminants in sediment are harmful to benthic organisms. Sediment tests are commonly used in studies designed to: (1) evaluate hazards of dredged material, (2) assess site contamination in the environment (for example, to rank areas for cleanup), and (3) determine effects of specific contaminants, or combinations of contaminants, through the use of sediment spiking techniques. Each of these broad study designs has specific statistical design and analytical considerations, which are described as follows.

(1) *Dredged Material Hazard Evaluation*—In these studies,  $n$  (number) sites are compared individually to a reference sediment. The statistical procedures appropriate for these studies are generally pairwise comparisons. Additional information on toxicity testing of dredged material and analysis of data from dredged material hazard evaluations is available in (93, 108, 109)

(2) *Site Assessment of Field Contamination*—Surveys of sediment toxicity are often included in more comprehensive analyses of biological, chemical, geological, and hydrographic data. Statistical correlation can be improved and costs may be reduced if subsamples are taken simultaneously for sediment

tests, chemical analyses, and benthic community structure determinations. There are several statistical approaches to field assessments, each with a specific purpose. If the objective is to compare the response or residue level at all sites individually to a control sediment, then the pairwise comparison approach described as follows is appropriate. If the objective is to compare among all sites in the study area, then a multiple comparison procedure that employs an experiment-wise error rate is appropriate. If the objective is to compare among groups of sites, then orthogonal contrasts are a useful data analysis technique.

(3) *Sediment Spiking Experiments*—Sediments spiked with known concentrations of chemicals can be used to establish cause and effect relationships between chemicals and biological responses. Results of toxicity tests with test materials spiked into sediments at different concentrations may be reported in terms of an LC50, EC50, IC50, NOEC, or LOEC. The statistical approach for spiked sediment toxicity tests also applies to the analysis of data from water-only reference-toxicity tests.

15.2.2 *Experimental Design*—The guidance outlined below on the analysis of data is adapted from a variety of sources including Guide E1688, Guide E1847, USEPA (3, 115, 159), USEPA-USACE (93, 108, 109) Practices E29, E105, E122, E178, E141, and Terminologies E456, E1325, and E1402. The objectives of a sediment test are to quantify contaminant effects on or accumulation in test organisms exposed to natural or spiked sediments or dredged materials and to determine whether these effects are statistically different from those occurring in a control or reference sediment. Each experiment consists of at least two treatments: the control and one or more test treatment(s). The test treatment(s) consist(s) of the contaminated or potentially contaminated sediment(s). A control sediment is always required to ensure that no contamination is introduced during the experimental setup and that test organisms are healthy. A control sediment is used to judge the acceptability of the test. Some designs will also require a reference sediment that represents an environmental condition or potential treatment effect of interest. Controls are used to evaluate the acceptability of the test (see 13.3, 14.3, Annex A1 to Annex A7) and might include a control sediment, a formulated sediment (Section 7.2), a sand substrate (for *C. dilutus* (formerly known as *C. tentans*; Shobanov et al. 1999. (1); see 13.2, A7.2), or water-only exposures (for *H. azteca*; Section A6.3.7.8). Testing a reference sediment provides a site-specific basis for evaluating toxicity of the test sediments. Comparisons of test sediments to multiple reference or control sediments representative of the physical characteristics of the test sediment (i.e., grain size, organic carbon) may be useful in these evaluations (Section 4.2.1).

15.2.2.1 *Experimental Unit*—During toxicity testing, each test chamber to which a single application of treatment is applied is an experimental unit. The important concept is that the treatment (sediment) is applied to each experimental unit as a discrete unit. Experimental units should be independent and should not differ systematically.

15.2.2.2 *Replication*—Replication is the assignment of a treatment to more than one experimental unit. The variation among replicates is a measure of the within-treatment variation and provides an estimate of within-treatment error for assessing the significance of observed differences between treatments.

15.2.2.3 *Minimum Detectable Difference (MDD)*—When using hypothesis testing for statistical analyses, the minimum significant difference is inversely proportional to the number of replicates. Because no consensus currently exists on what constitutes a biologically acceptable MDD, the appropriate statistical minimum significant difference should be a data quality objective (DQO) established by the individual user (for example, program considerations) based on their data requirements, the logistics and economics of test design, and the ultimate use of the test results.

15.2.2.4 *Minimum Number of Replicates*—Eight replicates are recommended for 10-day freshwater sediment toxicity testing with *Hyalella azteca* (Table 14) and *Chironomus dilutus* (Table 18) and five replicates are recommended for 10-day marine sediment testing (USEPA (3)) for each treatment. However, four replicates per treatment are the absolute minimum number of replicates recommended for a 10-day sediment toxicity test. It is always prudent to include as many replicates in the test design as economically and logistically possible. USEPA 10-day sediment toxicity testing methods recommend the use of 10 organisms per replicates for freshwater testing or 20 organisms per replicate for marine testing (4). An increase in the number of organisms per replicate in all treatments, is allowable only if: (1) test performance criteria for the recommended number of replicates are achieved and (2) it can be demonstrated that no change occurs in contaminant availability due to the increased organism loading. See Annex A6 and Annex A7 for a description of the number of replicates and test organisms/replicate recommended for long-term testing of *Hyalella azteca* or *Chironomus dilutus*.

15.2.2.5 *Randomization*—Randomization is the unbiased assignment of treatments within a test system and to the exposure chambers ensuring that no treatment is favored and that observations are independent. It is also important to: (1) randomly select the organisms (but not the number of organisms) for assignment to the control and test treatments (for example, a bias in the results may occur if all the largest animals are placed in the same treatment), (2) randomize the allocation of sediment (for example, not take all the sediment in the top of a jar for the control and the bottom for spiking), and (3) randomize the location of exposure units.

15.2.2.6 *Pseudoreplication*—The appropriate assignment of treatments to the replicate exposure chambers is critical to the avoidance of a common error in design and analysis termed “pseudoreplication” (222). Pseudoreplication occurs when inferential statistics are used to test for treatment effects even though the treatments are not replicated or the replicates are not statistically independent (222). The simplest form of pseudoreplication is the treatment of subsamples of the experimental unit as true replicates. For example, two aquaria are prepared, one with control sediment, the other with test sediment, and ten organisms are placed in each aquarium. Even

if each organism is analyzed individually, the ten organisms only replicate the biological response and do not replicate the treatment (that is, sediment type). In this case, the experimental unit is the ten organisms and each organism is a subsample. A less obvious form of pseudoreplication is the potential systematic error due to the physical segregation of exposure chambers by treatment. For example, if all the control exposure chambers are placed in one area of a room and all the test exposure chambers are in another, spatial effects (for example, different lighting, temperature) could bias the results for one set of treatments. Random physical intermixing of the exposure chambers or randomization of treatment location may be necessary to avoid this type of pseudoreplication. Pseudoreplication can be avoided or reduced by properly identifying the experimental unit, providing replicate experimental units for each treatment, and applying the treatments to each experimental unit in a manner that includes random physical intermixing (interspersion) and independence. However, avoiding pseudoreplication completely may be difficult or impossible given resource constraints.

15.2.2.7 *Compositing Samples*—Decisions regarding compositing of samples depends on the objective of the test. Compositing consists of combining samples (for example, organisms, sediment) and chemically analyzing the mixture rather than the individual samples. The chemical analysis of the mixture provides an estimate of the average concentration of the individual samples making up the composite. Compositing also may be used when the cost of analysis is high. Each organism or sediment sample added to the composite should be of equal size (that is, wet weight) and the composite should be completely homogenized before taking a sample for chemical analysis. If compositing is performed in this manner, the value obtained from the analysis of the composite is the same as the average obtained from analyzing each individual sample (within any sampling and analytical errors). If true replicate composites (not subsample composites) are made, the variance of the replicates will be less than the variance of the individual samples, providing a more precise estimate of the mean value. This increases the power of a test between means of composites over a test between means of individuals or samples for a given number of samples analyzed. If compositing reduces the actual number of replicates, however, the power of the test will also be reduced. If composites are made of individuals or samples varying in size, the value of the composite and the mean of the individual organisms or sediment samples are no longer equivalent. The variance of the replicate composites will increase, decreasing the power of any test between means. In extreme cases, the variance of the composites can exceed the population variance (223). Therefore, it is important to keep the individuals or sediment samples comprising the composite equivalent in size. If sample sizes vary, consult the tables in (224) to determine if replicate composite variances will be higher than individual sample variances, which would make compositing inappropriate.

15.2.2.8 *Optimum Design of Experiments*—An optimum design is one which obtains the most precise answer for the least effort. It maximizes or minimizes one of many optimality criteria, which are formal, mathematical expressions of certain

properties of the model that are fit to the data. The choice of optimality criterion depends on the objective of test, and composite criteria can be used when a test has more than one goal. A design is optimum only for a specific model, so it is necessary to know beforehand which models might be used (Atkinson and Doney) (225). Optimum design of experiments using specific approaches as described in Atkinson and Doney (225) has not been formally applied to sediment testing; however it might be desirable to use these approaches in designing experiments.

15.2.3 *Statistical Analysis of Data*—The purpose of a toxicity test is to determine if the biological response to a treatment sample differs from the response to a control sample. Table 21 presents the possible outcomes and decisions that can be reached in a statistical test of such a hypothesis. The null hypothesis is that no difference exists among the mean control and treatment responses. The alternative hypothesis of greatest interest in sediment tests is that the treatments are toxic relative to the control or reference sediment.

15.2.3.1 Statistical tests of hypotheses can be designed to control for the chances of making incorrect decisions. In Table 21, alpha ( $\alpha$ ) represents the probability of making a Type I statistical error. A Type I statistical error in this testing situation results from the false conclusion that the treated sample is toxic or contains chemical residues not found in the control or reference sample. Beta ( $\beta$ ) represents the probability of making a Type II statistical error, or the likelihood that one erroneously concludes there are no differences among the mean responses in the treatment, control or reference samples. Traditionally, acceptable values for  $\alpha$  have ranged from 0.1 to 0.01 with 0.05 or 5 % used most commonly. This choice should depend upon the consequences of making a Type I error. Historically, having chosen  $\alpha$ , environmental researchers have ignored  $\beta$  and the associated power of the test ( $1-\beta$ ).

15.2.3.2 Fairweather (226) presents a review of the need for, and the practical implications of, conducting power analysis in environmental monitoring studies. This review also includes a comprehensive bibliography of recent publications on the need for, and use of, power analyses in environmental study design and data analysis. The consequences of a Type II statistical error in environmental studies should never be ignored and may in fact be the most important criteria to consider in experimental designs and data analyses which include statistical hypothesis testing. To paraphrase Fairweather (226) “The commitment of time, energy, and people to a false positive (a Type I error) will only continue until the mistake is discovered. In contrast, the cost of a false negative (a Type II error) will

have both short- and long-term costs (for example, ensuing environmental degradation and the eventual cost of its rectification).”

15.2.3.3 The critical components of the experimental design associated with the test of hypothesis outlined above are: (1) the required MDD between the treatment and control or reference responses, (2) the variance among treatment and control replicate experimental units, (3) the number of replicate units for the treatment and control samples, (4) the number of animals exposed within a replicate exposure chamber, and (5) the selected probabilities of Type I ( $\alpha$ ) and Type II ( $\beta$ ) errors.

15.2.3.4 Sample size or number of replicates may be fixed due to cost or space considerations, or may be varied to achieve *a priori* probabilities of  $\alpha$  and  $\beta$ . The MDD should be established ahead of time based upon biological and program considerations. The investigator has little control of the variance among replicate exposure chambers. However, this variance component can be minimized by selecting test organisms that are as biologically similar as possible and maintaining test conditions within prescribed quality control (QC) limits.

15.2.3.5 The MDD is expressed as a percentage change from the mean control response. To test the equality of the control and treatment responses, a two-sample *t*-test with its associated assumptions is the appropriate parametric analysis. If the desired MDD, the number of replicates per treatment, the number of organisms per replicate, and an estimate of typical among replicate variability, such as the coefficient of variation (CV) from a control sample, are available, it is possible to use a graphical approach as in Fig. 9 to determine how likely it is

**TABLE 21 Treatment Response (TR), Alpha ( $\alpha$ ) Represents the Probability of Making a Type I Statistical Error (False Positive), Beta ( $\beta$ ) Represents the Probability of Making a Type II Statistical Error (False Negative)**

Decision	TR = Control	TR > Control
TR = Control	Correct $1 - \alpha$	Type II Error $\beta$
TR > Control	Type I Error $\alpha$	Correct $1 - \beta$ (Power)

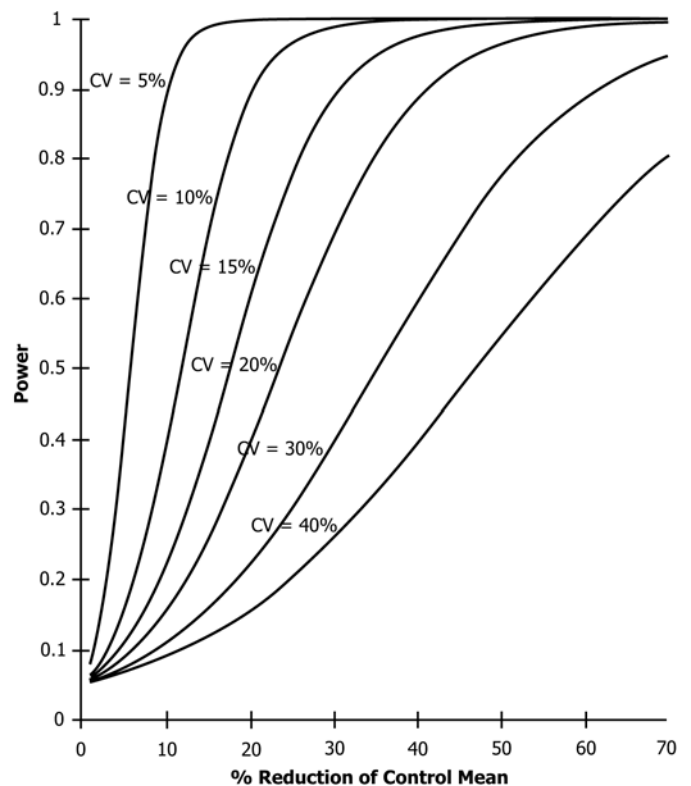

**FIG. 9 Power of the Test versus Percent Reduction of the Control Mean at Various CVs (8 Replicates,  $\alpha = 0.05$  (One-Tailed))**

that a 20 % reduction will be detected in the treatment response relative to the control response. The CV is defined as 100 % by (standard deviation divided by the mean). In a test design with 8 replicates per treatment and with an  $\alpha$  level of 0.05, high power (that is,  $>0.8$ ) to detect a 20 % reduction from the control mean occurs only if the CV is 15 % or less (Fig. 9). The choice of these variables also affects the power of the test. If 5 replicates are used per treatment (Fig. 10), the CV needs to be 10 % or lower to detect a 20 % reduction in response relative to the control mean with a power of 90 %.

15.2.3.6 Relaxing the  $\alpha$  level of a statistical test increases the power of the test. Fig. 11 duplicates Fig. 9 except that  $\alpha$  is 0.10 instead of 0.05. Selection of the appropriate  $\alpha$  level of a test is a function of the costs associated with making Type I and II statistical errors. Evaluation of Fig. 9 illustrates that with a CV of 15 % and an  $\alpha$  level of 0.05, there is an 80 % probability (power) of detecting a 20 % reduction in the mean treatment response relative to the control mean. However, if  $\alpha$  is set at 0.10 (see Fig. 11) and the CV remains at 15 %, then there is a 90 % probability (power) of detecting a 20 % reduction relative to the control mean. The latter example would be preferable if an environmentally conservative analysis and interpretation of the data is desirable.

15.2.3.7 Increasing the number of replicates per treatment will increase the power to detect a 20 % reduction in treatment response relative to the control mean (see Fig. 12). Note; however, that for less than eight replicates per treatment it is difficult to have high power (that is,  $>0.80$ ) unless the CV is  $<15\%$ . If space or cost limit the number of replicates to fewer than eight per treatment, then it may be necessary to find ways

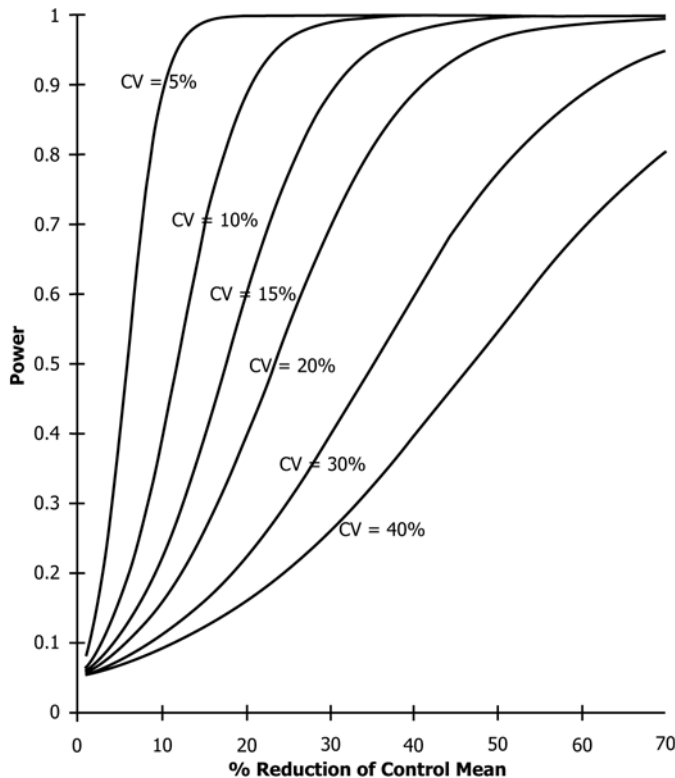

FIG. 10 Power of the Test versus Percent Reduction of the Control Mean at Various CVs (5 replicates,  $\alpha = 0.05$  (One-Tailed))

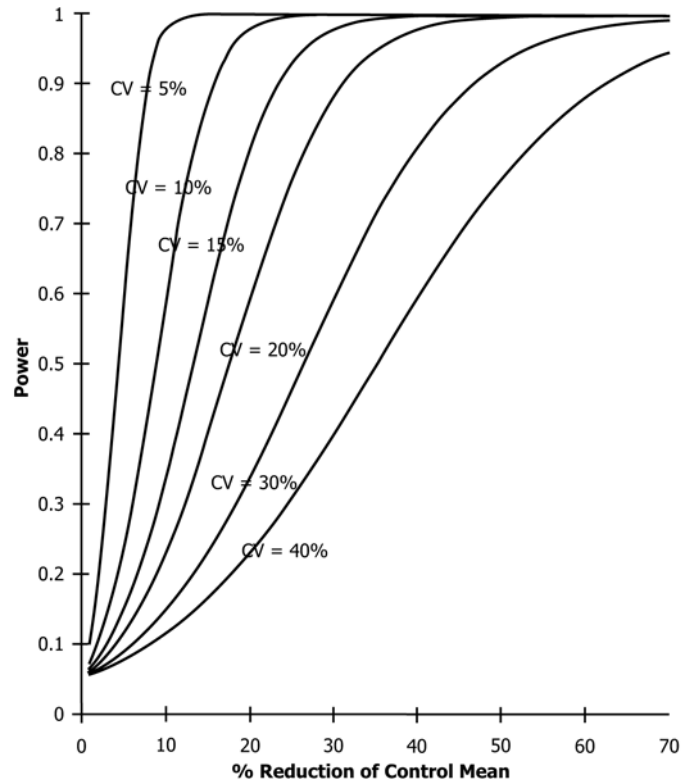

FIG. 11 Power of the Test versus Percent Reduction of the Control Mean at Various CVs (8 Replicates,  $\alpha = 0.10$  (One-Tailed))

to reduce the among replicate variability and consequently the CV. Options that are available include selecting more uniform organisms to reduce biological variability or increasing the  $\alpha$  level of the test. For CVs in the range from 30 to 40 %, even eight replicates per treatment is inadequate to detect small reductions ( $\leq 20\%$ ) in response relative to the control mean.

15.2.3.8 The effect of the choice of  $\alpha$  and  $\beta$  on number of replicates for various CVs is illustrated in Fig. 13 in which the combined total probability of Type I and Type II statistical errors is fixed and assumed to be 0.25. An  $\alpha$  of 0.10 therefore establishes a  $\beta$  of 0.15. In Fig. 13, if  $\alpha = \beta = 0.125$ , the number of replicates required to detect a difference of 20 % relative to the control is at a minimum. As  $\alpha$  or  $\beta$  decrease, the number of replicates required to detect the same 20 % difference relative to the control increases. However, the curves are relatively flat over the range from 0.05 to 0.20 and that the curves are very dependent upon the choice of the combined total of  $\alpha + \beta$ . Limiting the total of  $\alpha + \beta$  to 0.10 greatly increases the number of replicates necessary to detect a preselected percentage reduction in mean treatment response relative to the control mean.

15.2.4 Fig. 14 outlines a decision tree for analysis of survival and growth data. In the tests described herein, samples or observations refer to replicates of treatments. Sample size  $n$  is the number of replicates (that is, exposure chambers) in an individual treatment, not the number of organisms in an exposure chamber. Overall sample size  $N$  is the combined total number of replicates in all treatments. The statistical methods discussed in this section are described in general statistics texts such as Steel and Torrie (227), Sokal and Rohlf (228), Dixon

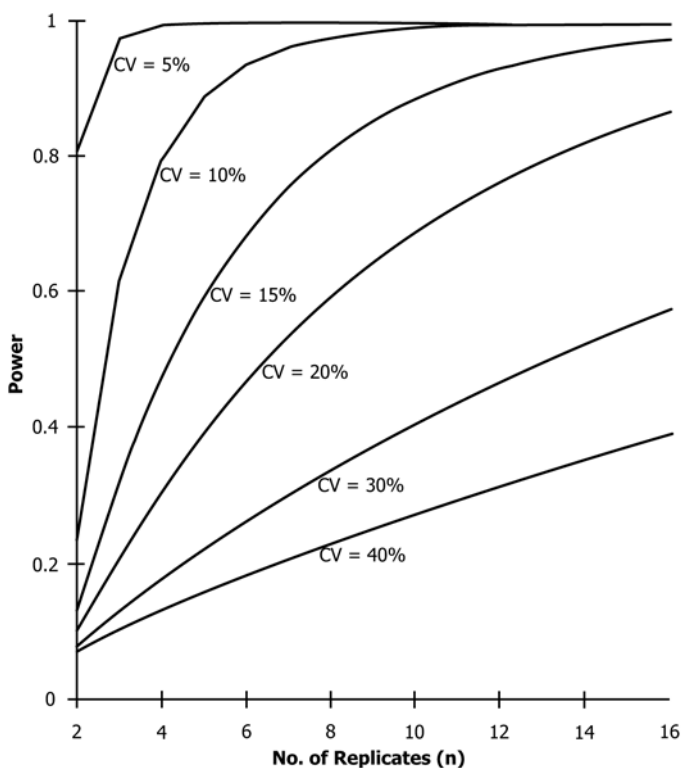

FIG. 12 Effect of CV and Number of Replicates on the Power to Detect a 20 % Decrease Relative to the Control Mean ( $\alpha = 0.05$  (One-Tailed))

F = 20%

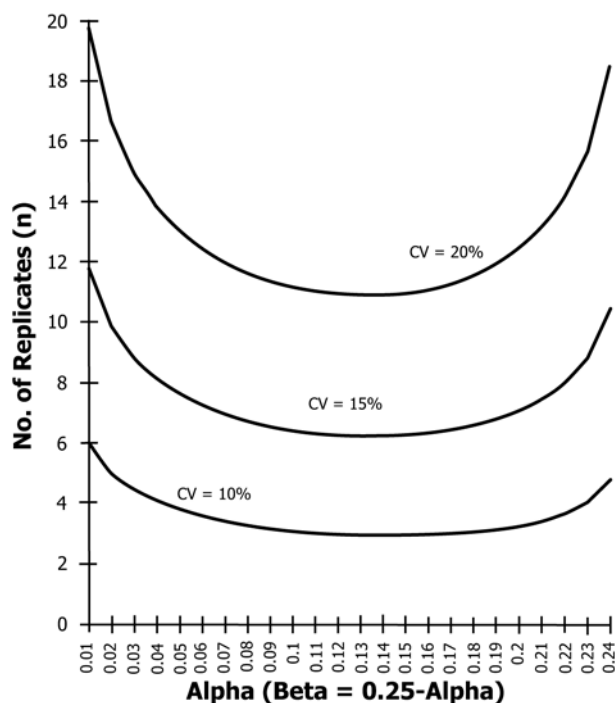

FIG. 13 Effect of Alpha and Beta on the Number of Replicates at Various CVs (Assuming Combined  $\alpha + \beta = 0.25$ )

It is recommended that users of this standard have at least one of these texts and associated statistical tables on hand. A nonparametric statistics text such as Conover (232) may also be helpful.

15.2.4.1 Mean—The sample mean ( $\bar{x}$ ) is the average value, or  $\sum x_i/n$ ,

where:

$n$  = number of observations (replicates),

$x_i$  =  $i$ th observation, and

$\sum x_i$  = every  $x$  summed =  $x_1 + x_2 + \dots + x_n$ .

15.2.4.2 Standard Deviation—The sample standard deviation(s) is a measure of the variation of the data around the mean and is equivalent to  $s^2$ . The sample variance,  $s^2$ , is given by the following “machine” or “calculation” formula:

$$s^2 = \frac{\sum x^2 - (\sum x)^2/n}{n - 1} \quad (1)$$

15.2.4.3 Standard Error of the Mean—The standard error of the mean (SE, or  $s/n$ ) estimates variation among sample means rather than among individual values. The SE is an estimate of the standard deviation among means that would be obtained from several samples of  $n$  observations each. Most of the statistical tests in this standard compare means with other means (for example, dredged sediment mean with reference mean) or with a fixed standard (for example, FDA action level (9)). Therefore, the “natural” or “random” variation of sample means (estimated by SE), rather than the variation among individual observations (estimated by  $s$ ), is required for the tests.

15.2.4.4 Tests of Assumptions—In general, parametric statistical analyses such as  $t$ -tests and analysis of variance are appropriate only if: (1) there are independent, replicate experimental units for each treatment, (2) the observations within each treatment follow a normal distribution, and (3) variances for both treatments are equal or similar. The first assumption is an essential component of experimental design. The second and third assumptions can be tested using the data obtained from the experiment. Therefore, before conducting statistical analyses, tests for normality and equality of variances should be performed.

(1) Outliers (extreme values) and systematic departures from a normal distribution (for example, a log-normal distribution) are the most common causes of departures from normality or equality of variances. An outlier is an inconsistent or questionable data point that appears unrepresentative of the general trend exhibited by the majority of the data. Outliers may be detected by tabulation of the data, plotting, or by analysis of residuals. An explanation should be sought for any questionable data points. Without an explanation, data points should only be discarded with extreme caution. If there is no explanation, the analysis should be performed both with and without the outlier, and the results of both analyses should be reported. An appropriate transformation, such as the arcsine square root transformation, will normalize many distributions (233). Problems with outliers can usually be solved only by using nonparametric tests, but careful laboratory practices can reduce the frequency of outliers.

and Massey (229), Zar (230), and Snedecor and Cochran (231).



DATA - SURVIVAL, GROWTH, ETC

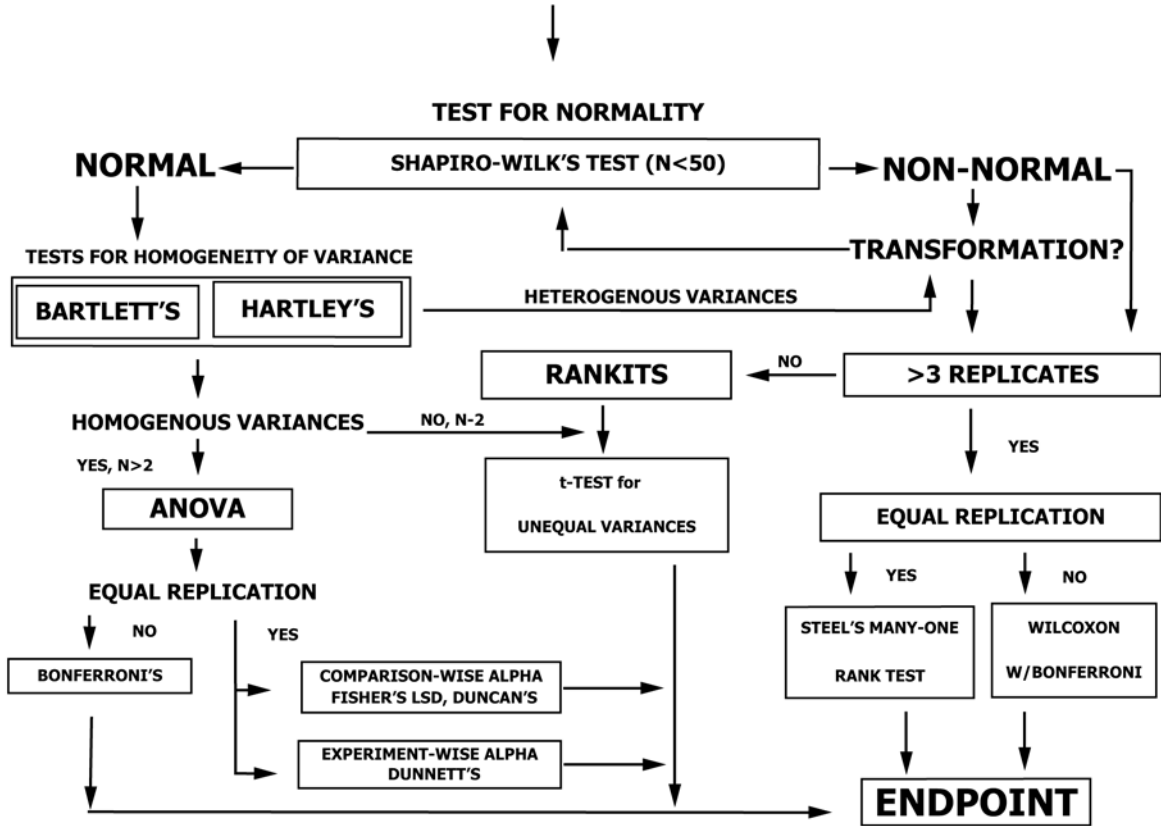

FIG. 14 Decision Tree for Analysis Survival and Growth Data

(2) *Tests for Normality*—The most commonly used test for normality for small sample sizes ( $N < 50$ ) is the Shapiro-Wilk’s Test. This test determines if residuals are normally distributed. Residuals are the differences between individual observations and the treatment mean. Residuals, rather than raw observations, are tested because subtracting the treatment mean removes any differences among treatments. This scales the observations so that the mean of residuals for each treatment and overall treatments is zero. The Shapiro-Wilk’s Test provides a test statistic  $W$ , which is compared to values of  $W$  expected from a normal distribution.  $W$  will generally vary between 0.3 and 1.0, with lower values indicating greater departure from normality. Because normality is desired, one looks for a high value of  $W$  with an associated probability greater than the prespecified  $\alpha$  level.

(3) Table 22 provides  $\alpha$  levels to determine whether departures from normality are significant.

Normality should be rejected when the probability associated with  $W$  (or other normality test statistic) is less than  $\alpha$  for the appropriate total number of replicates ( $N$ ) and design. A balanced design means that all treatments have an equal number ( $n$ ) of replicate exposure chambers. A design is considered unbalanced when the treatment with the largest number of replicates ( $n_{max}$ ) has at least twice as many replicates as the treatment with the fewest replicates ( $n_{min}$ ). Note that higher  $\alpha$  levels are used when the number of replicates is small, or when the design is unbalanced, because these are the cases in which departures from normality have the greatest effects on  $t$ -tests and other parametric comparisons. If data fail the test for normality, even after transformation, nonparametric tests should be used for additional analyses (See 15.2.4.8 and Fig. 23).

(4) Tables of quantiles of  $W$  can be found in Shapiro and Wilk (234), Gill (235), Conover (232), USEPA (236) and other statistical texts. These references also provide methods of calculating  $W$ , although the calculations can be tedious. For that reason, commonly available computer programs or statistical packages are preferred for the calculation of  $W$ .

(5) *Tests for Homogeneity of Variances*—There are a number of tests for equality of variances. Some of these tests are sensitive to departures from normality, which is why a test for normality should be performed first. Bartlett’s Test or other tests such as Levene’s Test or Cochran’s Test (231, 237) all have similar power for small, equal sample sizes ( $n = 5$ ) (232),

TABLE 22 Suggested  $\alpha$  Levels to Use for Tests of Assumptions

Test	Number of Observations <sup>A</sup>	$\alpha$ When Design Is	
		Balanced	Unbalanced <sup>B</sup>
Normality	$N = 2$ to 9	0.10	0.25
	$N = 10$ to 19	0.05	0.10
	$N = 20$ or more	0.01	0.05
Equality of Variances	$n = 2$ to 9	0.10	0.25
	$n = 10$ or more	0.05	0.10

<sup>A</sup>  $N$  = total number of observations (replicates) in all treatments combined;  $n$  = number of observations (replicates) in an individual treatment.

<sup>B</sup>  $n_{max} \geq 2 n_{min}$ .

and any one of these tests is adequate for the analyses in this section. Many software packages for *t*-tests and analysis of variance (ANOVA) provide at least one of the tests.

(6) If no tests for equality of variances are included in the available statistical software, Hartley's  $F_{\max}$  can easily be calculated:

$$F_{\max} = (\text{larger of } s_1^2, s_2^2) / (\text{smaller of } s_1^2, s_2^2) \quad (2)$$

When  $F_{\max}$  is large, the hypothesis of equal variances is more likely to be rejected.  $F_{\max}$  is a two-tailed test because it does not matter which variance is expected to be larger. Some statistical texts provide critical values of  $F_{\max}$  (235, 237, 238).

(7) Levels of  $\alpha$  for tests of equality of variances are provided in Table 22. These levels depend upon number of replicates in a treatment ( $n$ ) and allotment of replicates among treatments. Relatively high  $\alpha$ 's (that is,  $\geq 0.10$ ) are recommended because the power of the above tests for equality of variances is rather low (about 0.3) when  $n$  is small. Equality of variances is rejected if the probability associated with the test statistic is less than the appropriate  $\alpha$ .

15.2.4.5 *Transformations of the Data*—When the assumptions of normality or homogeneity of variance are not met, transformations of the data may remedy the problem, so that the data can be analyzed by parametric procedures, rather than a nonparametric technique. The first step in these analyses is to transform the responses, expressed as the proportion surviving, by the arcsine-square root transformation. The arcsine-square root transformation is commonly used on proportionality data to stabilize the variance and satisfy the normality requirement. If the data do not meet the assumption of normality and there are four or more replicates per group, then the nonparametric test, Wilcoxon Rank Sum Test, can be used to analyze the data. If the data meet the assumption of normality, Bartlett's Test or Hartley's *F* test for equality of variances is used to test the homogeneity of variance assumption. Failure of the homogeneity of variance assumption leads to the use of a modified *t* test and the degrees of freedom for the test are adjusted. The arcsine-square root transformation consists of determining the angle (in radians) represented by a sine value. In this transformation, the proportion surviving is taken as the sine value, the square root of the sine value is calculated, and the angle (in radians) for the square root of the sine value is determined. When the proportion surviving is 0 or 1, a special modification of the transformation should be used (239). An example of the arcsine-square root transformation and modification are provided as follows.

(1) Calculate the response proportion (RP) for each replicate within a group, where:

$$RP = (\text{number of surviving organisms}) / (\text{number exposed}) \quad (3)$$

(2) Transform each RP to arcsine, as follows:

a. For RPs greater than zero or less than one:

$$\text{Angle (in radians)} = \text{arc sine} \sqrt{RP} \quad (4)$$

b. Modification of the arcsine when  $RP = 0$ .

$$\text{Angle (in radians)} = \text{arc sine} \sqrt{\frac{1}{4n}} \quad (5)$$

where  $n$  = number animals/treatment replicate.

c. Modification of the arcsine when  $RP = 1.0$

$$\text{Angle} = 1.5708 \text{ radians} - (\text{radians for } RP = 0) \quad (6)$$

15.2.4.6 *Two Sample Comparisons ( $N = 2$ )*—The true population mean ( $\mu$ ) and standard deviation ( $\sigma$ ) are only known after sampling the entire population. In most cases samples are taken randomly from the population, and the  $s$  calculated from those samples is only an estimate of  $\sigma$ . Student's *t*-values account for this uncertainty. The degrees of freedom for the test, which are defined as the sample size minus one ( $n - 1$ ), should be used to obtain the correct *t*-value. Student's *t*-values decrease with increasing sample size because larger samples provide a more precise estimate of  $\mu$  and  $\sigma$ .

(1) When using a *t* table, it is crucial to determine whether the table is based on one-tailed probabilities or two-tailed probabilities. In formulating a statistical hypothesis, the alternative hypothesis can be one-sided (one-tailed test) or two-sided (two-tailed test). The null hypothesis ( $H_0$ ) is always that the two values being analyzed are equal. A one-sided alternative hypothesis ( $H_a$ ) is that there is a specified relationship between the two values (for example, one value is greater than the other) versus a two-sided alternative hypothesis ( $H_a$ ) which is that the two values are simply different (that is, either larger or smaller). A one-tailed test is used when there is an *a priori* reason to test for a specific relationship between two means such as the alternative hypothesis that the treatment mortality or tissue residue is greater than the control mortality or tissue residue. In contrast, the two-tailed test is used when the direction of the difference is not important or cannot be assumed before testing.

(2) Since control organism mortality or tissue residues and sediment contaminant concentrations are presumed lower than reference or treatment sediment values, conducting one-tailed tests is recommended in most cases. For the same number of replicates, one-tailed tests are more likely to detect statistically significant differences between treatments (for example, have a greater power). This is a critical consideration when dealing with a small number of replicates (such as 8/treatment). The other alternative for increasing statistical power is to increase the number of replicates, which increases the cost of the test.

(3) There are cases when a one-tailed test is inappropriate. When no *a priori* assumption can be made as to how the values vary in relationship to one another, a two-tailed test should be used. An example of an alternative two-sided hypothesis is that the reference sediment total organic carbon (TOC) content is different (greater or lesser) from the control sediment TOC.

(4) The *t*-value for a one-tailed probability may be found in a two-tailed table by looking up *t* under the column for twice the desired one-tailed probability. For example, the one-tailed *t*-value for  $\alpha = 0.05$  and  $df = 20$  is 1.725, and is found in a two-tailed table using the column for  $\alpha = 0.10$ .

15.2.4.7 The usual statistical test for comparing two independent samples is the two-sample *t* test (231). The *t*-statistic for testing the equality of means  $\bar{x}_1$  and  $\bar{x}_2$  from two independent samples with  $n_1$  and  $n_2$  replicates and unequal variances is:

$$t = (\bar{x}_1 - \bar{x}_2) / \sqrt{s_1^2/n_1 + s_2^2/n_2} \quad (7)$$

where:  $s_1^2$  and  $s_2^2$  are the sample variances of the two groups. Although the equation assumes that the variances of the two

groups are unequal, it is equally useful for situations in which the variances of the two groups are equal. This statistic is compared with the Student's  $t$  distribution with degrees of freedom (df) given by Satterthwaite's (240) approximation:

$$df = \frac{(s_1^2/n_1 + s_2^2/n_2)^2}{(s_1^2/n_1)^2/(n_1 - 1) + (s_2^2/n_2)^2/(n_2 - 1)} \quad (8)$$

This formula can result in fractional degrees of freedom (df), in which case one should round df down to the nearest integer in order to use a  $t$  table. Using this approach, the degrees of freedom for this test will be less than the degrees of freedom for a  $t$  test assuming equal variances. If there are unequal numbers of replicates in the treatments, the  $t$  test with Bonferroni's adjustment can be used for data analysis (116, 159). When variances are equal, an  $F$  test for equality is not necessary.

15.2.4.8 *Nonparametric Tests*—Test such as the  $t$  test, which analyze the original or transformed data, and which rely on the properties of the normal distribution, are referred to as parametric tests. Nonparametric tests, which do not require normally distributed data, analyze the ranks of data and generally compare medians rather than means. The median of a sample is the middle or 50th percentile observation when the data are ranked from smallest to largest. In many cases, nonparametric tests can be performed simply by converting the data to ranks or normalized ranks (rankits) and conducting the usual parametric test procedures on the ranks or rankits.

(1) Nonparametric tests are useful because of their generality, but have less statistical power than corresponding parametric tests when the parametric test assumptions are met. If parametric tests are not appropriate for comparisons because the normality assumption is not met, data should be converted to normalized ranks (rankits). Rankits are simply the  $z$ -scores expected for the rank in a normal distribution. Thus, using rankits imposes a normal distribution over all the data, although not necessarily within each treatment. Rankits can be obtained by ranking the data, then converting the ranks by rankits using the following formula:

$$rankit = z_{[(rank - 0.375)/(N + 0.25)]} \quad (9)$$

where:

$z$  = the normal deviate, and

$N$  = the total number of observations.

Alternatively, rankits may be obtained from standard statistical tables such as Rohlf and Sokal (238).

(2) If normalized ranks are calculated, the ranks should be converted to rankits using the preceding formula. In comparisons involving only two treatments ( $N = 2$ ), there is no need to test assumptions on the rankits or ranks; simply proceed with a one-tailed  $t$  test for unequal variances using the rankits or ranks.

15.2.4.9 *Analysis of Variance ( $N > 2$ )*—Some experiments are set up to compare more than one treatment with a control while others may also be interested in comparing the treatments with one another. The basic design of these experiments is the same as for experiments evaluating pairwise comparisons. After the applicable comparisons are determined, the data need to be tested for normality to determine if parametric

statistics are appropriate and whether the variances of the treatments are equal. If normality of the data and equal variances are established, then an analysis of variance (ANOVA) may be performed to address the hypothesis that all the treatments including the control are equal. If normality or equality of variance are not established then transformations of the data may be appropriate or nonparametric statistics can be used to test for equal means. Tests for normality of the data should be performed on the treatment residuals. A residual is defined as the observed value minus the treatment mean, that is,  $r_{ik} = o_{ik} - (k^{\text{th}} \text{ treatment mean})$ . Pooling residuals provides an adequate sample size to test the data for normality.

(1) The variances of the treatments should also be tested for equality. Currently there is no easy way to test for equality of the treatment means using analysis of variance if the variances are not equal. In a toxicity test with several treatments, one treatment may have 100 % mortality in all of its replicates, or the control treatment may have 100 % survival in all of its replicates. These responses result in 0 variance for a treatment which results in a rejection of equality of variance in these cases. No transformation will change this outcome. In this case, the replicate responses for the treatment with 0 variance should be removed before testing for equality of variances. Only those treatments that do not have 0 replicate variance should be used in the ANOVA to get an estimate of the within treatment variance. After a variance estimate is obtained, the means of the treatments with 0 variance may be tested against the other treatment means using the appropriate mean comparison. Equality of variances among the treatments can be evaluated with the Hartley  $F_{\text{max}}$  test or Bartlett's test.

(2) If the data are not normally distributed or the variances among treatments are not homogeneous, even after data transformation, nonparametric analyses are appropriate. If there are four or more replicates per treatment and the number of replicates per treatment is equal, the data can be analyzed with Steel's Many-One Rank Test. Unequal replication among treatments requires data analysis with the Wilcoxon Rank Sum Test with Bonferroni's adjustment. Steel's Many-One Rank Test is a nonparametric test for comparing treatments with a control. This test is an alternative to the Dunnett's Procedure, and may be applied to data when the normality assumption has not been met. Steel's Test requires equal variances across treatments and the control, but is thought to be fairly insensitive to deviations from this condition (3). Wilcoxon's Rank Sum Test is a nonparametric test to be used as an alternative to the Steel's Test when the number of replicates are not the same within each treatment. A Bonferroni's adjustment of the pairwise error rate for comparison of each treatment versus the control is used to set an upper bound of alpha on the overall error rate. This is in contrast to the Steel's Test with a fixed overall error rate for alpha. Thus, Steel's Test is a more powerful test (3).

(3) Different mean comparison tests are used depending on whether an  $\alpha$  percent comparison-wise error rate or an  $\alpha$  percent experiment-wise error rate is desired. The choice of a comparison-wise or experiment-wise error rate depends on whether a decision is based on a pairwise comparison

(comparison-wise) or from a set of comparisons (experiment-wise). For example, a comparison-wise error rate would be used for deciding which stations along a gradient were acceptable or not acceptable, relative to a control or reference sediment. Each individual comparison is performed independently at a smaller  $\alpha$  (than used in an experiment-wise comparison) such that the probability of making a Type I error in the entire series of comparisons is not greater than the chosen experiment-wise  $\alpha$  level of the test. This results in a more conservative test when comparing any particular sample to the control or reference. However, if several samples were taken from the same area and the decision to accept or reject the area was based upon all comparisons with a reference, then an experiment-wise error rate should be used. When an experiment-wise error rate is used, the power to detect real differences between any two means decreases as a function of the number of treatment means being compared to the control treatment.

(4) The recommended procedure for pairwise comparisons that have a comparison-wise  $\alpha$  error rate and equal replication is to do an ANOVA followed by a one-sided Fisher's Least Significance Difference (LSD) Test (227). A Duncan's mean comparison test should give results similar to the LSD. If the treatments do not contain equal numbers of replicates, the appropriate analysis is the  $t$  test with Bonferroni's adjustment. For comparisons that maintain an experiment-wise  $\alpha$  error rate, Dunnett's Test is recommended for comparisons with the control.

(5) Dunnett's test has an overall error rate of  $\alpha$ , which accounts for the multiple comparisons with the control. Dunnett's procedure uses a pooled estimate of the variance, which is equal to the error value calculated in an ANOVA.

(6) To perform the individual comparisons, calculate the  $t$  statistic for each treatment and control combination, as follows:

$$t_i = \frac{(\bar{Y}_i - \bar{Y}_1)}{S_w \sqrt{(1/n_1) + (1/n_i)}} \quad (10)$$

where:

- $\bar{Y}_i$  = mean for each treatment,
- $\bar{Y}_1$  = mean for the control,
- $S_w$  = square root of the within mean square,
- $n_1$  = number of replicates in the control, and
- $n_i$  = number of replicates for treatment "i".

To quantify the sensitivity of the Dunnett's test, the minimum significant difference (MSD = MDD) may be calculated with the following formula:

$$MSD = d S_w \sqrt{(1/n_1) + (1/n)} \quad (11)$$

where:

- $d$  = critical value for the Dunnett's Procedure,
- $S_w$  = square root of the within mean square,
- $n$  = number of replicates per treatment, assuming an equal number of replicates at all treatment concentrations, and
- $n_1$  = number of replicates in the control.

### 15.2.5 Methods for Calculating LC50, EC50, and ICp:

15.2.5.1 Fig. 15 outlines a decision tree for analysis of point estimate data. USEPA (115, 159, 233, 236) discuss in detail the mechanics of calculating LC50 (or EC50) or ICp values using the most current methods. The most commonly used methods are the Graphical, Probit, trimmed Spearman-Kärber, and the Linear Interpolation Methods. Methods for evaluating point estimate data using logistic regression are outlined in Snedecor and Cochran(231). In general, results from these methods should yield similar estimates. Each method is outlined as follows and recommendations presented for the use of each method.

15.2.5.2 Data for at least five test concentrations and the control should be available to calculate an LC50 although each method can be used with fewer concentrations. Survival in the lowest concentration must be at least 50 % and an LC50 should not be calculated unless at least 50 % of the organisms die in at least one of the serial dilutions. When <50 % mortality occurs in the highest test concentration, the LC50 is expressed as greater than the highest test concentration.

15.2.5.3 Due to the intensive nature of the calculations for the estimated LC50 and associated 95 % confidence interval using most of the following methods, it is recommended that the data be analyzed with the aid of computer software. Computer programs to estimate the LC50 or ICp values and associated 95 % confidence intervals with the methods discussed as follows (except for the Graphical Method) were developed by USEPA (2).

15.2.5.4 *Graphical Method*—This procedure estimates an LC50 (or EC50) by linearly interpolating between points of a plot of observed percentage mortality versus the base 10 logarithm ( $\log_{10}$ ) of treatment concentration. The only requirement for its use is that treatment mortalities bracket 50 %.

(J) For an analysis using the Graphical Method the data should first be smoothed and adjusted for mortality in the control replicates. The procedure for smoothing and adjusting the data is described in the following steps: Let  $p_0, p_1, \dots, p_k$  denote the observed proportion mortalities for the control and the  $k$  treatments. The first step is to smooth the  $p_i$  if they do not satisfy  $p_0 \leq p_1 \leq \dots \leq p_k$ . The smoothing process replaces any adjacent  $p_i$ 's that do not conform to  $p_0 \leq p_1 \leq \dots \leq p_k$  with their average. For example, if  $p_i$  is less than  $p_{i-1}$  then:

$$p_{i-1}^s = p_i^s = (p_i + p_{i-1})/2 \quad (12)$$

where:

$p_i^s$  = smoothed observed proportion mortality for concentration  $i$ .

Adjust the smoothed observed proportion mortality in each treatment for mortality in the control group using Abbott's formula (241). The adjustment takes the form:

$$p_i^a = (p_i^s - p_0^s)/(1 - p_0^s) \quad (13)$$

where:

$p_0^s$  = smooth observed proportion mortality for the control, and  
 $p_i^s$  = smoothed observed proportion mortality for concentration  $i$ .

**SURVIVAL POINT ESTIMATES**

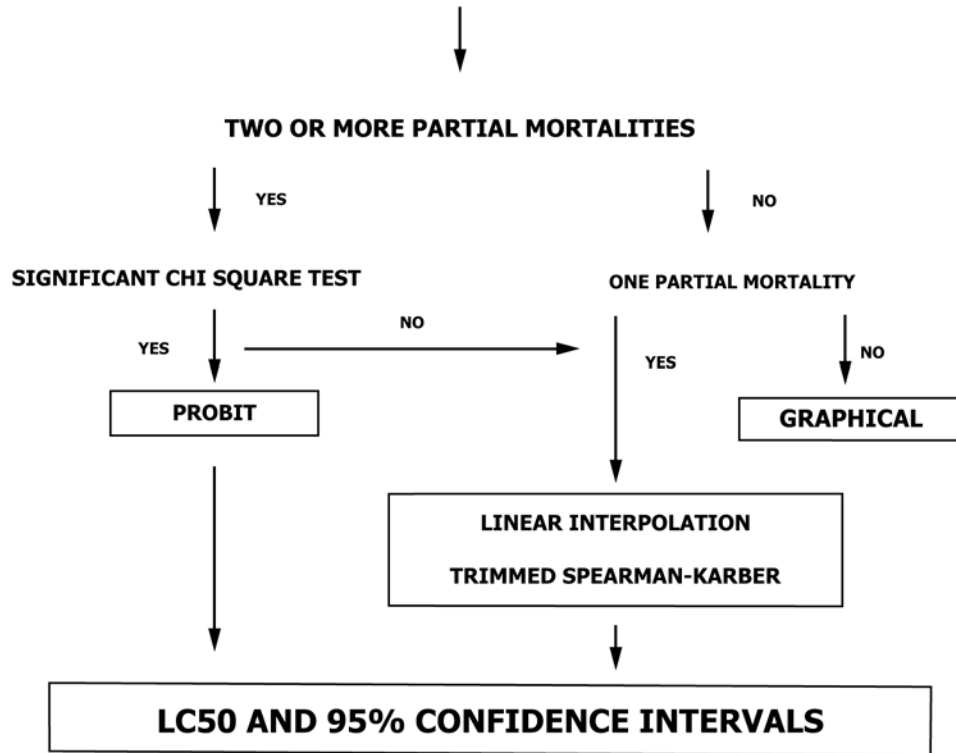

FIG. 15 Decision Tree for Analysis of Point Estimate Data

15.2.5.5 *The Probit Method*—This method is a parametric statistical procedure for estimating the LC50 (or EC50) and the associated 95 % confidence interval (241). The analysis consists of transforming the observed proportion mortalities with a Probit transformation, and transforming the treatment concentrations to  $\log_{10}$ . Given the assumption of normality for the  $\log_{10}$  of the exposures, the relationship between the preceding transformed variables is about linear. This relationship allows estimation of linear regression parameters, using an iterative approach. A Probit is the same as a z-score: for example, the Probit corresponding to 70 % mortality is  $z_{0.70}$  or = 0.52. The LC50 is calculated from the regression and is the concentration associated with 50 % mortality or  $z = 0$ . To obtain a reasonably precise estimate of the LC50 with the Probit Method, the observed proportion mortalities must bracket 0.5 and the  $\log_{10}$  of the exposure should be normally distributed. To calculate the LC50 estimate and associated 95 % confidence interval, two or more of the observed proportion mortalities must be between zero and one. The original proportion mortalities should be corrected for control mortality using Abbott’s formula before the Probit transformation is applied to the data.

(1) A goodness-of-fit procedure with the *chi*-square statistic is used to determine if the data fit the Probit model. If many data sets are to be compared to one another, the Probit Method is not recommended because it may not be appropriate for many of the data sets. This method also is only appropriate for percent mortality data sets and should not be used for estimating endpoints that are a function of the control response, such as inhibition of growth. Most computer programs that generate

Probit estimates also generate confidence interval estimates for the LC50. These confidence interval estimates on the LC50 may not be correct if replicate mortalities are pooled to obtain a mean treatment response. This can be avoided by entering the Probit-transformed replicate responses and doing a least-squares regression on the transformed data.

15.2.5.6 *Trimmed Spearman-Karber*—The trimmed Spearman-Karber Method is a modification of the Spearman-Karber, nonparametric statistical procedure for estimating the LC50 and the associated 95 % confidence interval (242). This procedure estimates the trimmed mean of the distribution of the  $\log_{10}$  of the exposure. If the log exposure distribution is symmetric, this estimate of the trimmed mean is equivalent to an estimate of the median of the log exposure distribution. Use of the trimmed Spearman-Karber Method is only appropriate when the requirements for the Probit Method are not met (115, 159). This method is only appropriate for lethality data sets.

(1) To calculate the LC50 estimate with the trimmed Spearman-Karber Method, the smoothed, adjusted, observed proportion mortalities must bracket 0.5. To calculate a confidence interval for the LC50 estimate, one or more of the smoothed, adjusted, observed proportion mortalities must be between zero and one.

(2) Smooth the observed proportion mortalities as described for the Probit Method. Adjust the smoothed observed proportion mortality in each concentration for mortality in the control group using Abbott’s formula (see Probit Method). Calculate the amount of trim to use in the estimation of the LC50 as follows:

$$\text{Trim} = \max(p_1^a, 1 - p_k^a)$$

where:

$p_1^a$  = smoothed, adjusted proportion mortality for the lowest treatment concentration, exclusive of the control.

$p_k^a$  = smoothed, adjusted proportion mortality for the highest treatment concentration.

$k$  = number of treatment concentrations, exclusive of the control.

**15.2.5.7 Linear Interpolation Method**—This method calculates a toxicant concentration that causes a given percent reduction (for example, 25 %, 50 %) in the endpoint of interest and is reported as an IC<sub>p</sub> value (IC = Inhibition Concentration; where  $p$  = percent effect). The procedure was designed for general applicability in the analysis of data from chronic toxicity tests, and the generation of an endpoint from a continuous model that allows a traditional quantitative assessment of the precision of the endpoint, such as confidence limits for the endpoint of a single test, and a mean and coefficient of variation for the endpoints of multiple tests.

(1) As described in (115, 159), the Linear Interpolation Method of calculating an IC<sub>p</sub> assumes that the responses: (1) are monotonically nonincreasing, where the mean response for each higher concentration is less than or equal to the mean response for the previous concentration, (2) follow a piecewise linear response function, and (3) are from a random, independent, and representative sample of test data. If the data are not monotonically nonincreasing, they are adjusted by smoothing (averaging). In cases where the responses at the low toxicant concentrations are much higher than in the controls, the smoothing process may result in a large upward adjustment in the control mean. In the Linear Interpolation Method, the smoothed response means are used to obtain the IC<sub>p</sub> estimate reported for the test. No assumption is made about the distribution of the data except that the data within a group being resampled are independent and identically distributed.

(2) The Linear Interpolation Method assumes a linear response from one concentration to the next. Thus, the IC is estimated by linear interpolation between two concentrations whose responses bracket the response of interest, the ( $p$ ) percent reduction from the control.

(3) If the assumption of monotonicity of test results is met, the observed response means ( $\bar{Y}_i$ ) should stay the same or decrease as the toxicant concentration increases. If the means do not decrease monotonically, the responses are “smoothed” by averaging (pooling) adjacent means. Observed means at each concentration are considered in order of increasing concentration, starting with the control mean ( $\bar{Y}_1$ ). If the mean observed response at the lowest toxicant concentration ( $\bar{Y}_2$ ) is equal to or smaller than the control mean ( $\bar{Y}_1$ ), it is used as the response. If it is larger than the control mean, it is averaged with the control, and this average is used for both the control response ( $M_1$ ) and the lowest toxicant concentration response ( $M_2$ ). This mean is then compared to the mean observed response for the next higher toxicant concentration ( $\bar{Y}_3$ ). Again, if the mean observed response for the next higher toxicant concentration is smaller than the mean of the control and the lowest toxicant concentration, it is used as the response. If it is

higher than the mean of the first two, it is averaged with the mean of the first two, and the resulting mean is used as the response for the control and two lowest concentrations of toxicant. This process is continued for data from the remaining toxicant concentrations. Unusual patterns in the deviations from monotonicity may require an additional step of smoothing. Where  $\bar{Y}_i$  decreases monotonically, the  $\bar{Y}_i$  become  $M_i$  without smoothing.

(4) To obtain the IC<sub>p</sub> estimate, determine the concentrations  $C_J$  and  $C_{J+1}$  which bracket the response  $M_1(1 - p/100)$ , where  $M_1$  is the smoothed control mean response and  $p$  is the percent reduction in response relative to the control response. These calculations can easily be done by hand or with a computer program as described as follows. The linear interpolation estimate is calculated as follows:

$$ICp = C_J + [M_1(1 - p/100) - M_J] \frac{(C_{J+1} - C_J)}{(M_{J+1} - M_J)} \quad (14)$$

where:

$C_J$  = tested concentration whose observed mean response is greater than  $M_1(1 - p/100)$ .

$C_{J+1}$  = tested concentration whose observed mean response is less than  $M_1(1 - p/100)$ .

$M_1$  = smoothed mean response for the control.

$M_J$  = smoothed mean response for concentration  $J$ .

$M_{J+1}$  = smoothed mean response for concentration  $J + 1$ .

$p$  = percent reduction in response relative to the control response.

$ICp$  = estimated concentration at which there is a percent reduction from the smoothed mean control response.

(5) Standard statistical methods for calculating confidence intervals are not applicable for the IC<sub>p</sub>. The bootstrap method, as proposed by Efron (243), is used to obtain the 95 % confidence interval for the true mean. In the bootstrap method, the test data  $Y_{ji}$  is randomly resampled with replacement to produce a new set of data  $Y_{ji}^*$ , that is statistically equivalent to the original data, but which produces a new and slightly different estimate of the IC<sub>p</sub> (IC<sub>p</sub>\*). This process is repeated at least 80 times (244) resulting in multiple “data” sets, each with an associated IC<sub>p</sub>\* estimate. The distribution of the IC<sub>p</sub>\* estimates derived from the sets of resampled data approximates the sampling distribution of the IC<sub>p</sub> estimate. The standard error of the IC<sub>p</sub> is estimated by the standard deviation of the individual IC<sub>p</sub>\* estimates. Empirical confidence intervals are derived from the quantiles of the IC<sub>p</sub>\* empirical distribution. For example, if the test data are resampled a minimum of 80 times, the empirical 2.5 % and the 97.5 % confidence limits are about the second smallest and second largest IC<sub>p</sub>\* estimates (244). The width of the confidence intervals calculated by the bootstrap method is related to the variability of the data. When confidence intervals are wide, the reliability of the IC estimate is in question. However, narrow intervals do not necessarily indicate that the estimate is highly reliable, because of undetected violations of assumptions and the fact that the confidence limits based on the empirical quantiles of a bootstrap distribution of 80 samples may be unstable.

### 15.3 Data Calculations:

15.3.1 Sediments spiked with known concentrations of chemicals can be used to establish cause and effect relationships between chemicals and biological responses. Results of toxicity tests with test materials spiked into sediments at different concentrations may be reported in terms of an LC50 (median lethal concentration), an EC50 (median effect concentration), an IC50 (inhibition concentration), or as an NOEC (no observed effect concentration) or LOEC (lowest observed effect concentration). Most studies with spiked sediment are often started only a few days after the chemical has been added to the sediment. Consistent spiking procedures should be followed in order to make interlaboratory comparisons (see 10.3).

15.3.2 Evaluating effect concentrations for chemicals in sediment requires knowledge of factors controlling the bioavailability. Similar concentrations of a chemical in units of mass of chemical per mass of sediment dry weight often exhibit a range in toxicity in different sediments (40, 82). Effect concentrations of chemicals in sediment have been correlated to interstitial water concentrations, and effect concentrations in interstitial water are often similar to effect concentrations in water-only exposures. The bioavailability of nonionic organic compounds are often inversely correlated with the organic carbon concentration of the sediment. Whatever the route of exposure, the correlations of effect concentrations to interstitial water concentrations indicate predicted or measured concentrations in interstitial water can be useful for quantifying the exposure concentration to an organism. Therefore, information on partitioning of chemicals between solid and liquid phases of sediment may be useful for establishing effect concentrations.

15.3.3 Toxic units can be used to help interpret the response of organisms to multiple chemicals in sediment. A toxic unit is the concentration of a chemical divided by an effect concentration. For example, a toxic unit of exposure can be calculated by dividing the measured concentration of a chemical in pore water by the water-only LC50 for the same chemical (174). Toxic units could also be calculated by dividing the concentration in a whole sediment sample by a threshold concentration in whole sediment (18, 83). Toxicity expressed as toxic units may be summed and this may provide information on the toxicity of chemical mixtures (174).

15.3.4 Field surveys can be designed to provide either a qualitative reconnaissance of the distribution of sediment contamination or a quantitative statistical comparison of contamination among sites (14). Surveys of sediment toxicity are usually part of more comprehensive analyses of biological, chemical, geological, and hydrographic data. Statistical correlation can be improved and costs reduced if subsamples are taken simultaneously for sediment tests, chemical analyses, and benthic community structure.

15.3.5 Descriptive methods such as toxicity tests with field-collected sediment should not be used alone to evaluate sediment contamination. An integration of several methods using the weight of evidence is needed to assess the effects of contaminants associated with sediment (Long et al.; Ingersoll et al.; MacDonald et al. (32, 85, 86, 84)). Hazard evaluations integrating data from laboratory exposures, chemical analyses, and benthic community assessments (the Sediment Quality

Triad) provide strong complementary evidence of the degree of pollution-induced degradation in aquatic communities (67, 87; Chapman et al. (88); Canfield et al. (45, 46, 47).

15.3.6 Toxicity Identification Evaluation (TIE) procedures can be used to help provide insights as to specific contaminants responsible for toxicity in sediment (10, 174). For example, the toxicity of contaminants such as metals, ammonia, hydrogen sulfide, and nonionic organic compounds can be identified using TIE procedures.

## 16. Report

16.1 The record of the results of an acceptable sediment test should include the following information either directly or by referencing available documents:

16.1.1 Name of test and investigator(s), name and location of laboratory, and dates of start and end of test.

16.1.2 Source of control or test sediment, method for collection, handling, shipping, storage, and disposal of sediment.

16.1.3 Source of test material, lot number if applicable, composition (identities and concentrations of major ingredients and impurities if known), known chemical and physical properties, and the identity and concentration(s) of any solvent used.

16.1.4 Source and characteristics of overlying water, description of any pretreatment, and results of any demonstration of the ability of an organism to survive or grow in the water.

16.1.5 Source, history, and age of test organisms; source, history, and age of brood stock, culture procedures; and source and date of collection of the test organisms, scientific name, name of person who identified the organisms and the taxonomic key used, age or life stage, means and ranges of weight or length, observed diseases or unusual appearance, treatments, holding, and acclimation procedures.

16.1.6 Source and composition of food, concentrations of test material and other contaminants, procedure used to prepare food, feeding methods, frequency, and ration.

16.1.7 Description of the experimental design and test chambers, the depth and volume of sediment and overlying water in the chambers, lighting, number of test chambers and number of test organisms/treatment, date and time test starts and ends, temperature measurements, dissolved oxygen concentration (as percent saturation), and any aeration used before starting a test and during the conduct of a test.

16.1.8 Methods used for physical and chemical characterization of sediment.

16.1.9 Definition(s) of the effects used to calculate LC50 or EC50s, biological endpoints for tests, and a summary of general observations of other effects.

16.1.10 Methods used for statistical analyses of data: (1) summary statistics of the transformed or raw data as applicable (for example, mean, standard deviation, coefficient of variation, precision and bias); (2) hypothesis testing (raw data, transformed data, null hypothesis, alternate hypothesis, target Type I and II error rates, statistics used (including calculation of test statistic)), decision rule used (for example, *W* statistic >0.65 results in the rejection of the null hypothesis), calculated test statistic and decision rule result, achieved Type I and II

error rates (for some discrete tests, achieved error rates only approximate the target rates); (3) results of regression analyses (parameters of regression fit, uncertainty limits on the regression parameters, correlation coefficient).

16.1.11 Summary of general observations on other effects or symptoms.

16.1.12 Anything unusual about the test, any deviation from these procedures, and any other relevant information.

16.2 Published reports should contain enough information to clearly identify the methodology used and the quality of the results.

## 17. Precision and Bias

### 17.1 Determining Precision and Bias:

17.1.1 Precision is a term that describes the degree to which data generated from replicate measurements differ and reflects the closeness of agreement between randomly selected test results. Bias is the difference between the value of the measured data and the true value and is the closeness of agreement between an observed value and an accepted reference value (Practices E177 and E691). Quantitative determination of precision and bias in sediment testing of aquatic organisms is difficult or may be impossible in some cases, as compared to analytical (chemical) determinations. This is due, in part, to the many unknown variables which affect organism response. Determining the bias of a sediment test using field samples is not possible since the true values are not known. Since there is no acceptable reference material suitable for determining the bias of sediment tests, bias of the procedures described in this standard has not been determined (see 17.2).

17.1.2 Sediment tests exhibit variability due to several factors (see Section 11). Test variability can be described in terms of two types of precision, either single laboratory (intralaboratory or repeatability; see 17.5.1) precision or multilaboratory (interlaboratory or reproducibility; see 17.5.2 and 17.6) precision (also referred to as round-robin or ring tests). Intralaboratory precision reflects the ability of trained laboratory personnel to obtain consistent results repeatedly when performing the same test on the same organism using the same toxicant. Interlaboratory precision is a measure of how reproducible a method is when conducted by a large number of laboratories using the same method, organism, and toxic sample. Generally, intralaboratory results are less variable than interlaboratory results (3, 97, 159, 244-246).

17.1.3 A measure of precision can be calculated using the mean and relative standard deviation (percent coefficient of variation, or  $CV\% = \text{standard deviation}/\text{mean} \times 100$ ) of the calculated endpoints from the replicated endpoints of a test. However, precision reported as the CV should not be the only approach used for evaluating precision of tests and should not be used for the NOEC effect levels derived from statistical analyses of hypothesis testing. The CVs may be very high when testing extremely toxic or nontoxic samples. For example, if there are multiple replicates with no survival and one with low survival the CV may exceed 100 %, yet the range of response is actually quite consistent. Therefore, additional estimates of precision should be used, such as range of responses and minimum detectable differences (MDD) com-

pared to control survival or growth. Several factors can affect the precision of the test, including test organism age, condition, sensitivity, handling, and feeding of the test organisms, overlying water quality, and the experience in conducting tests. For these reasons, it is recommended that trained laboratory personnel conduct the tests in accordance with the procedures outlined in Section 11. Quality assurance practices should include: (1) single laboratory precision determinations that are used to evaluate the ability of the laboratory personnel to obtain precise results using reference toxicants for each of the test organisms and (2) preparation of control charts (Section 17.4) for each reference toxicant and test organism. The single laboratory precision determinations should be made before conducting a sediment test and should be periodically performed as long as whole-sediment tests are being conducted at the laboratory.

17.1.4 Intralaboratory precision data are routinely calculated for test organisms using water-only 96-h exposures to a reference toxicant, such as KCl. Intralaboratory precision data should be tracked using a control chart. Each laboratory's reference-toxicant data will reflect conditions unique to that facility, including dilution water, culturing, and other variables (see Section 11). However, each laboratory's reference toxicant CVs should reflect good repeatability.

17.1.5 Interlaboratory precision (round-robin) tests have been completed with both *Hyaella azteca* and *Chironomus dilutus* (formerly known as *C. tentans*; Shobanov et al. 1999. (1), using 4-day water-only test and 10-day whole-sediment tests for the Test Method described in Sections 13.2 and 14.2 Section 17.5). USEPA(2) and 17.6 describe results of round-robin evaluations with long-term sediment toxicity tests described in A6.2 and A7.2 for *H. azteca* and *C. dilutus*.

17.2 Bias—The bias of toxicity tests cannot be determined since there is no acceptable reference material. The bias of the reference-toxicity tests can only be evaluated by comparing test responses to control charts.

17.3 Replication and Test Sensitivity— The sensitivity of sediment tests will depend in part on the number of replicates per concentration, the probability levels (alpha and beta), and the type of statistical analysis. For a specific level of variability, the sensitivity of the test will increase as the number of replicates is increased. The minimum recommended number of replicates varies with the objectives of the test and the statistical method used for analysis of the data (see Section 15).

### 17.4 Demonstrating Acceptable Laboratory Performance:

17.4.1 Intralaboratory precision, expressed as a coefficient of variation (CV), of the range for each type of test to be used in a laboratory can be determined by performing five or more tests with different batches of test organisms, using the same reference toxicant, at the same concentrations, with the same test conditions (for example, the same test duration, type of water, age of test organisms, feeding), and same data analysis methods. A reference-toxicant concentration series (0.5 or higher) should be selected that will consistently provide partial mortalities at two or more concentrations of the test chemical (see 11.14, Table 10 and Table 11). See Section 11.16 for additional detail regarding reference-toxicity testing.



17.4.2 It is desirable to determine the sensitivity of test organisms obtained from an outside source. The supplier should provide data with the shipment describing the history of the sensitivity of organisms from the same source culture.

17.4.3 Before conducting tests with potentially contaminated sediment, it is strongly recommended that the laboratory conduct the tests with control sediment(s) alone. Results of these preliminary studies should be used to determine if the use of the control sediment and other test conditions (i.e., water quality) result in acceptable performance in the tests as outlined in Sections 13 and 14 and in Annex A1 to Annex A7.

17.4.4 A control chart can be prepared for each combination of reference toxicant and test organism. Each control chart should include the most current data. Endpoints from five tests are adequate for establishing the control charts. In this technique, a running plot is maintained for the values ( $X_i$ ) from successive tests with a given reference toxicant (see Fig. 16), and the endpoint (LC50, NOEC, ICp) are examined to determine if they are within prescribed limits. Control charts as described in (3, 159) are used to evaluate the cumulative trend of results from a series of samples. The mean and upper and lower control limits ( $\pm 2$  SD) are recalculated with each successive test result.

17.4.5 The outliers, which are values falling outside the upper and lower control limits, and trends of increasing or decreasing sensitivity, are readily identified using control charts. With an alpha of 0.05, one in 20 tests would be expected to fall outside of the control limits by chance alone. During a 30-day period, if 2 of 20 reference-toxicity tests fall outside the control limits, the sediment toxicity tests conducted during the time in which the second reference-toxicity test failed are suspect, and should be considered as provisional and subject to careful review.

17.4.6 A sediment test may be acceptable if specified conditions of a reference-toxicity test fall outside the expected ranges (see 11.10). Specifically, a sediment test should not be judged unacceptable if the LC50 for a given reference-toxicity test falls outside the expected range or if control survival in the reference-toxicity test is <90 %. All the performance criteria outlined in Table 16 and Table 20 or in Annex A1 to Annex A7 should be considered when determining the acceptability of a sediment test. The acceptability of the sediment test would depend on the experience and judgment of the investigator and the regulatory authority.

17.4.7 If the value from a given test with the reference toxicant falls more than two standard deviation (SD) outside the expected range, the sensitivity of the organisms and the overall credibility of the test system may be suspect (3). In this case, the test procedure should be examined for defects and should be repeated with a different batch of test organisms.

17.4.8 Performance should improve with experience, and the control limits for point estimates should gradually narrow. However, control limits of  $\pm 2$  SD, by definition, will be exceeded 5 % of the time, regardless of how well a laboratory performs. Highly proficient laboratories which develop a very narrow control limit may be unfairly penalized if a test which falls just outside the control limits is rejected *de facto*. For this reason, the width of the control limits should be considered in

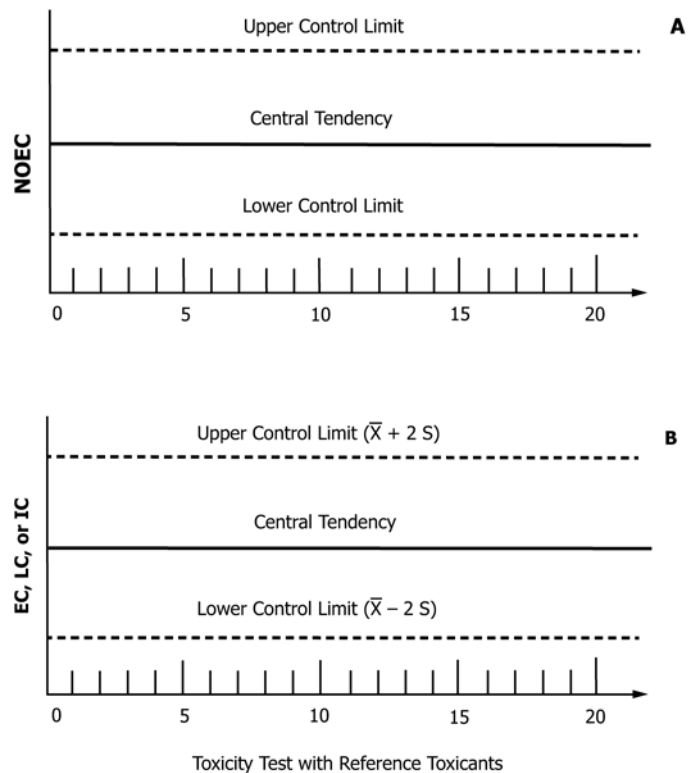

$$\bar{x} = \frac{\sum_{i=1}^n x_i}{n}$$

$$s = \sqrt{\frac{\sum_{i=1}^n x_i^2 - \frac{(\sum_{i=1}^n x_i)^2}{n}}{n-1}}$$

- where  $x_1$  = Successive toxicity values of toxicity tests.
- $n$  = Number of tests.
- $\bar{x}$  = Mean toxicity value.
- $S$  = Standard deviation.

FIG. 16 Control (Cusum) Charts, (a) Hypothesis Testing, (b) Point Estimates (LC, EC, or IC)

determining whether or not an outlier is to be rejected. This determination may be made by the regulatory authority evaluating the data.

17.4.9 The recommended reference-toxicity test consists of a control and five or more concentrations in which the endpoint is an estimate of the toxicant concentration which is lethal to 50 % of the test organisms in the time period prescribed by the test. The LC50 is determined by an appropriate procedure, such as the trimmed Spearman-Kärber Method, Probit Method, Graphical Method, or the Linear Interpolation Method (see Section 15).

17.4.10 The point estimation analysis methods recommended in this test method have been chosen primarily because they are well-tested, well-documented, and are applicable to most types of test data. Many other methods were considered

in the selection process, and it is recognized that the methods selected are not the only possible methods of analysis for toxicity data.

17.5 Precision of Sediment Toxicity Test Methods:

17.5.1 *Intralaboratory Precision*—Intralaboratory precision of the *Hyalella azteca* and *Chironomus dilutus* 10-day tests (as described in Table 14 and Table 18) was evaluated at USEPA Duluth using one control sediment sample in June 1993. In this study, five individuals simultaneously conducted the 10-day whole-sediment toxicity tests. The results of the study are presented in Table 23. The mean survival for *H. azteca* was 90.4 % with a CV of 7.2 % and the mean survival for *C. dilutus* was 93.0 % with a CV of 5.7 %. All of the individuals met the survival performance criteria of 80 % for *H. azteca* (Table 16) or 70 % for *C. dilutus* (Table 20).

17.5.2 *Interlaboratory Precision*:

17.5.2.1 *Interlaboratory precision using reference-toxicity tests and 10-day whole-sediment toxicity tests using the methods in accordance with these test methods (Table 14, Table 18, Table 10, and Table 11) were conducted by federal government laboratories, contract laboratories, and academic laboratories which had demonstrated experience in sediment toxicity testing (Table 24; Burton et al. (247)). USEPA (2) also describes results of additional interlaboratory comparisons of these 10-day whole sediment toxicity tests. The only exception to the methods outlined in Table 10 and Table 11 was 80% rather than the current recommendation of 90% survival was used to judge the acceptability of the reference-toxicity tests. the only exception to the methods outlined in Table 18, was 1.0 mL rather than the current recommendation of 1.5 mL of fish food flakes<sup>9</sup> was added daily to each beaker containing *C. dilutus* (see 14.2.2). The round-robin study was conducted in two phases for each organism. The experimental design for the round-robin study required each laboratory to conduct 96-h water-only reference-toxicity test in Phase 1 and 10-day whole-sediments in Phase 2 with *Hyalella azteca* or *Chironomus tentas* for a period of six months. Criteria for selection of participants in the round-robin study were that the laboratories: (1) had existing cultures of the test organisms, (2) had*

**TABLE 23 Intralaboratory Precision for Survival of *Hyalella azteca* and *Chironomus dilutus* in 10-Day Whole-Sediment Toxicity Tests with a Control Sediment (June 1993). The Study Was Conducted at the Same Time by 5 Individuals Testing 4 Replicate Samples<sup>A</sup> (2). Overlying Water was Lake Superior Water (Mean Response is Listed with the Coefficient of Variation (CV) in Parentheses)**

Individual	Survival (%)	
	<i>Hyalella azteca</i>	<i>Chironomus dilutus</i>
A	85 (6.82)	85 (20.4)
B	93 (10.3)	93 (5.40)
C	90 (9.10)	93 (10.3)
D	84 (42.6)	94 (14.3)
E	100 (0)	100 (0)
N (by individual)	5	5
Mean	90.4	93.0
CV	7.2 %	5.7 %
N (by replicate)	21	21
Mean	90.0	92.9
CV	19.9 %	11.8 %

<sup>A</sup> Individual D tested 5 replicate samples.

**TABLE 24 Participants in Round-Robin Studies**

Laboratory	<i>Chironomus dilutus</i>			<i>Hyalella azteca</i>	
	96-h KCl Test	96-h KCl Test	10-day Sediment Test	96-h KCl Test	10-day Sediment Test
	December 92	May 93	May 93	October 92	March 93
A	Y	N	N	Y	N
B	Y	Y	Y	Y	Y
C	Y	N	Y	Y	Y
D	Y	Y	Y	N	N
E	Y	Y	Y	Y	Y
F	Y	Y	Y	Y	Y
G	Y	Y	Y	Y	Y
H	Y	N	N	Y	N
I	Y	Y	Y	... <sup>A</sup>	Y
J	Y	Y	Y	Y	Y
K	... <sup>B</sup>	... <sup>B</sup>	... <sup>B</sup>	Y	Y
L	... <sup>C</sup>	... <sup>C</sup>	... <sup>C</sup>	Y	Y
N	9	7	8	10	9

<sup>A</sup> Test in January 1993.

<sup>B</sup> Participated using *C. riparius* only.

<sup>C</sup> Did not intend to participate with *C. dilutus*.

experience with conducting test with the organisms, and (3) would participate voluntarily. The test methods for the reference-toxicity tests and whole-sediment toxicity tests were similar among laboratories. Standard operating procedures detailing the test methods were provided to all participants. Culture methods were not specified and were not identical across laboratories.

17.5.2.2 In Phase 1, water-only reference-toxicity (KCl) tests were conducted with *H. azteca* for 96-h and LC50s were calculated. In these tests, *H. azteca* were placed in reconstituted hard water in 250-mL beakers containing a small piece of plastic mesh substrate. Ten organisms were randomly added to each of four replicates at five concentrations of KCl and a control. The organisms were fed 0.5 mL of a 1800-mg/L stock solution of YCT on Day 0 and Day 2. Mortality was monitored at 24-h intervals and the test was ended at 96-h (Table 11). In Phase 2, the variability of the 10-day whole-sediment test procedure for *H. azteca* was evaluated using an automated water renewal exposure system (Table 14). This system consisted of eight replicate 300-mL beakers containing ten organisms each. Each beaker contained a 100-mL aliquot of sediment and the overlying water was replaced twice a day (Table 14). The test sediments which were previously tested at USEPA Duluth to ascertain their toxicity included a control sediment (RR 3), a moderately contaminated test sediment (RR 2), and a heavily contaminated test sediment (RR 1). Sediments RR 1 and RR 2 were contaminated primarily with copper. An additional test sediment heavily contaminated with polycyclic aromatic hydrocarbons (RR 4) was tested by five laboratories. At the end of a test, the sediment from each replicate was sieved and surviving organisms were counted. (Burton et al. (247)).

17.5.2.3 Ten laboratories participated in the *H. azteca* reference-toxicity test (Table 24). The results from the tests with KCl are summarized in Table 25. The test performance criteria of ≥80 % control survival was met by 90 % of the laboratories resulting in a mean control survival of 98.8 % (CV

**TABLE 25 Interlaboratory Precision for *Hyaella azteca* 96-h LC50s from Water-Only Static Acute Toxicity Tests Using a Reference Toxicant (KCl) (October 1992)**

Laboratory	KCl LC50, mg/L	Confidence Intervals		Control Survival (%)
		Lower	Upper	
A	372	352	395	100
B	321	294	350	98
C	232	205	262	100
D	... <sup>A</sup>	... <sup>A</sup>	... <sup>A</sup>	... <sup>A</sup>
E	325	282	374	100
F	276	240	316	98
G	297	267	331	73 <sup>B</sup>
H	336	317	356	100
I	142 <sup>C</sup>	101	200	93
J	337	286	398	100
L	250	222	282	100
N	10			10
Mean	289.0 <sup>B</sup>			96.2
CV	23.0 % <sup>B</sup>			8.3 %
N	9			9
Mean	305.0 <sup>D</sup>			98.8
CV	14.2 % <sup>D</sup>			2.1 %

<sup>A</sup> Laboratory did not participate in *H. azteca* test in October.  
<sup>B</sup> Mean 1 and CV 1 include all data points.  
<sup>C</sup> Results are from a retest in January using three concentrations only; results excluded from analysis.  
<sup>D</sup> Mean 2 and CV 2 exclude data points for all sediment samples from laboratories which did not meet minimum control survival of  $\geq 80\%$ .

= 2.1 %). The mean LC50 was 305 mg/L (CV = 14.2 %) and the LC50s ranged from 232 to 372 mg/L KCl.

17.5.2.4 In the 10-day whole-sediment tests with *H. azteca*, nine laboratories tested the three sediments described above and five laboratories tested a fourth sediment from a heavily contaminated site (Table 26). All laboratories completed the tests; however, Laboratory C had 75 % survival which was below the acceptable test criteria for survival (Table 16). For these tests, the CV was calculated using the mean percent survival for the eight laboratories that met the performance

**TABLE 26 Interlaboratory Precision for Survival of *Hyaella azteca* in 10-Day Whole-Sediment Toxicity Tests Using Four Sediments (March 1993)**

Laboratory	Percent Survival (SD) in Sediment Samples			
	RR 1	RR 2	RR 3	RR 4
A	... <sup>A</sup>	... <sup>A</sup>	... <sup>A</sup>	... <sup>A</sup>
B	76.2 (20.7)	2.5 (7.1)	97.5 (4.6)	11.2 (13.6)
C	57.5 <sup>B</sup> (14.9)	1.2 <sup>B</sup> (0.0)	75.0 <sup>B</sup> (17.7)	1.2 <sup>B</sup> (0)
D	... <sup>A</sup>	... <sup>A</sup>	... <sup>A</sup>	... <sup>A</sup>
E	46.2 (17.7)	0 (0)	97.5 (7.1)	...
F	72.5 (12.8)	23.7 (18.5)	98.7 (3.5)	0 (0)
G	50.0 (28.3)	0 (0)	100 (0)	3.3 (5.2)
H	... <sup>A</sup>	... <sup>A</sup>	... <sup>A</sup>	... <sup>A</sup>
I	73.7 (32.0)	0 (0)	86.2 (10.6)	...
J	65.0 (9.3)	0 (0)	96.2 (5.2)	2.5 (7.1)
K	22.5 (18.3)	0 (0)	95.0 (5.3)	...
L	27.5 (16.7)	0 (0)	86.2 (18.5)	...
N	9	9	9	5
Mean 1 <sup>C</sup>	54.6	3.0	93.0	3.6
CV 1	36.2 %	256 %	9.0 %	121 %
N	8	8	8	4
Mean 2 <sup>D</sup>	54.2	3.3	94.5	4.3
CV 2	38.9 %	253 %	5.8 %	114 %

<sup>A</sup> Laboratory did not participate in *H. azteca* test in March.  
<sup>B</sup> Survival in control sediment (RR 3) below minimum acceptable level.  
<sup>C</sup> Mean 1 and CV 1 include all data points.  
<sup>D</sup> Mean 2 and CV 2 exclude data points for all sediment samples from laboratories which did not meet minimum control survival of  $\geq 80\%$ .

criteria for the test. The CV for the control sediment (RR 3) was 5.8 % with a mean survival of 94.5 % with survival ranging from 86 to 100 %. Mean survival was 3.3 % for sediment RR 2 and 4.3 % for sediment RR 4 (Table 26). For RR 2, survival ranged from 0 to 24 % (CV = 253 %) and for RR 4 the survival ranged from 0 to 11 % (CV = 114 %). Survival in the moderately contaminated sediment (RR 1) was 54.2 % with survival ranging from 23 to 76 % (CV = 38.9 %). When the RR 1 data for each laboratory were compared to the control for that laboratory, the range for the minimum detectable difference between the test sediments and the control sediment ranged from 5 to 24 % with a mean of 11 % (SD = 6).

17.5.2.5 The Phase 1 *C. dilutus* reference-toxicity test was conducted with KCl (see Table 27). Tests were conducted in 20 mL of test solution in 30-mL beakers using 10 replicates with 1 organism per beaker. Animals were fed 0.25 mL of a 4-g/L solution of fish food flakes<sup>9</sup> on Day 0 and Day 2 (see Table 10). Six out of the seven laboratories met the  $\geq 80\%$  control survival criterion with a mean LC50 of 5.37 % (CV = 19.6 %). The LC50s ranged from 3.61 to 6.65 g/L.

17.5.2.6 Eight laboratories participated in the 10-day whole-sediment testing with *C. dilutus*. The same three sediments used in the *H. azteca* whole-sediment test were used for this exposure (see Table 28). Three laboratories did not meet the control criteria for acceptable tests of  $\geq 70\%$  survival in the control (RR 3) sediment (Table 20). For the five laboratories that successfully completed the tests, the mean survival in the control sediment (RR 3) was 92.0 % (CV of 8.3 %) and survival ranged from 81.2 to 98.8 %. For the RR 2 sediment sample, the mean survival of the five values was 3.0 % (CV = 181 %) and for the RR 1 sediment sample, the mean survival was 86.8 % (CV = 13.5 %). A general effect on survival was not evident for the RR 1 sample, but growth was affected (see Table 29). When the RR 1 data for each laboratory were

**TABLE 27 Interlaboratory Precision for *Chironomus dilutus* 96-h LC50s from Water-Only Static Acute Toxicity Tests Using a Reference Toxicant (KCl) (May 1993)**

Laboratory	KCl LC50, g/L	Confidence Interval		Control Survival, %	Age at Start of Test, day
		Lower	Upper		
A	... <sup>A</sup>	...	...	...	...
B	6.65	... <sup>B</sup>	...	90	12
C	... <sup>A</sup>	...	...	...	...
D	5.30	4.33	6.50	55 <sup>C</sup>	10
E	5.11	4.18	6.24	100	11
F	3.61	2.95	4.42	90	10
G	5.36	4.43	6.49	93	12
H	... <sup>A</sup>	...	...	...	...
I	5.30	4.33	6.52	95	10–11
J	6.20	4.80	7.89	100	13
n	7			7	7
Mean 1 <sup>D</sup>	5.36			89	11.1
CV 1	17.9 %			17.5 %	9.46 %
n	6			6	6
Mean 2 <sup>E</sup>	5.37			94.7	11.2
CV 2	19.6 %			4.8 %	9.13 %

<sup>A</sup> Did not participate in reference toxicity test in May.  
<sup>B</sup> Confidence intervals cannot be calculated as no partial mortalities occurred.  
<sup>C</sup> Control survival below minimum acceptable level.  
<sup>D</sup> Mean 1 and CV 1 include all data points.  
<sup>E</sup> Mean 2 and CV 2 exclude data points for all sediment samples from laboratories which did not meet minimum control survival of  $\geq 70\%$ .

**TABLE 28 Interlaboratory Precision for Survival of *Chironomus dilutus* in 10-Day Whole-Sediment Toxicity Tests Using Three Sediments (May 1993)**

Laboratory	Percent Survival (SD) in Sediment Samples		
	RR 1	RR 2	RR 3
A	... <sup>A</sup>	...	...
B	67.5 (14.9)	2.5 (7.1)	98.8 (3.5)
C	15.0 <sup>B</sup> (12.0)	0 <sup>B</sup> (0)	62.5 <sup>B</sup> (26.0)
D	60.0 <sup>B</sup> (20.0)	0 <sup>B</sup> (0)	66.3 <sup>B</sup> (27.7)
E	85.0 (11.9)	0 (0)	93.8 (9.2)
F	87.5 <sup>B</sup> (12.5)	0 <sup>B</sup> (0)	43.8 <sup>B</sup> (30.2)
G	90.0 (13.1)	12.5 (3.5)	87.5 (10.3)
H	... <sup>A</sup>	...	...
I	97.5 (4.6)	0 (0)	98.8 (3.5)
J	93.8 (11.8)	0 (0)	81.2 (8.3)
<i>n</i>	8	8	8
Mean 1 <sup>C</sup>	74.5	1.88	79.1
CV 1	36.7 %	233 %	25.1 %
<i>n</i>	5	5	5
Mean 2 <sup>D</sup>	86.8	3.0	92.0
CV 2	13.5 %	181 %	8.3 %

<sup>A</sup> Did not participate in *C. dilutus* test in May.

<sup>B</sup> Survival in control sediment (RR 3) below minimum acceptable level.

<sup>C</sup> Mean 1 and CV 1 include all data points.

<sup>D</sup> Mean 2 and CV 2 exclude data points for all sediment samples from laboratories which did not meet minimum control survival of  $\geq 70\%$ .

**TABLE 29 Interlaboratory Precision for Growth of *Chironomus dilutus* in 10-Day Whole-Sediment Toxicity Tests Using Three Sediments (May 1993)**

Laboratory	Growth—Dry Weight in mg (SD) in Sediment Samples		
	RR 1	RR 2	RR 3
A	... <sup>A</sup>	... <sup>A</sup>	... <sup>A</sup>
B	0.370 (0.090)	0 (0)	1.300 (0.060)
C	0.883 <sup>B</sup> (0.890)	0 (0)	0.504 (0.212)
D	0.215 <sup>B</sup> (0.052)	0 (0)	1.070 (0.107)
E	0.657 (0.198)	0 (0)	0.778 (0.169)
F	0.210 <sup>B</sup> (0.120)	0 (0)	0.610 (0.390)
G	0.718 (0.114)	0 (0)	1.710 (0.250)
H	... <sup>A</sup>	... <sup>A</sup>	... <sup>A</sup>
I	0.639 (0.149)	0 (0)	1.300 (0.006)
J	0.347 (0.050)	0 (0)	1.180 (0.123)
<i>n</i>	8	8	8
Mean 1 <sup>C</sup>	0.505	...	1.056
CV 1	49.9 %	...	38.3 %
<i>n</i>	5	5	5
Mean 2 <sup>D</sup>	0.546	...	1.254
CV 2	31.9 %	...	26.6 %

<sup>A</sup> Did not participate in testing in May.

<sup>B</sup> Survival in control sediment (RR 3) below minimum acceptable level.

<sup>C</sup> Mean 1 and CV 1 include all data points.

<sup>D</sup> Mean 2 and CV 2 exclude data points for all sediment samples from laboratories which did not meet minimum control survival of  $\geq 70\%$ .

compared to the control for that laboratory, the minimum detectable difference for survival among laboratories ranged from 2.3 to 12.1 % with a mean of 8 % (SD = 4).

17.5.2.7 For *C. dilutus*, growth in 10-day tests is a sensitive indicator of sediment toxicity (5) and growth was also measured in the round-robin comparison (see Table 29). Using the data from five laboratories with acceptable control survival in the control sediment (RR 3), the mean weight of *C. dilutus* for the control sediment (RR 3) was 1.254 mg (CV = 26.6 %). The moderately contaminated sediment (RR 1) had a mean weight of 0.546 mg (CV = 31.9 %). No growth measurements were obtained for *C. dilutus* in Sediment RR 2 because of the high mortality. The mean minimum detectable difference for growth

among laboratories meeting the survival performance criteria was 11 % (SD = 5) and the MDD ranged from 4.8 to 23.6 % when the RR 1 data were compared to the RR 3 data.

17.5.2.8 These tests exhibited similar or better precision than many chemical analyses and effluent toxicity test methods (248). The success rate for test initiation and completion of the USEPA's round-robin evaluations are a good indication that a well-equipped and trained staff will be able to successfully conduct these tests. This is an important consideration for any test performed routinely in any regulatory program.

#### 17.6 Precision of Long-term Sediment Toxicity Procedures

17.6.1 Interlaboratory precision evaluations of the long-term *H. azteca* and *C. dilutus* tests, using the methods described in Sections 14 and 15, were conducted by federal government, contract, and academic laboratories that had demonstrated experience in sediment toxicity testing. The following sections briefly summarize the results of these interlaboratory evaluations. See USEPA (2) a more complete description of these interlaboratory evaluations. These round robin studies were conducted in two phases: a preliminary round-robin test and a definitive round-robin test. The objective of the preliminary round-robin testing was to provide participating laboratories with an opportunity to become acquainted with the techniques necessary to conduct the two tests and to solicit commentary and recommendations regarding potential improvements for the definitive evaluation. Criteria for selection of participants in both phases were that the laboratories had: (1) existing cultures of the test organisms, (2) experience conducting 10-day tests with the organisms, and (3) would participate voluntarily. Methods for conducting toxicity tests were similar among laboratories, and each laboratory was supplied with detailed operating procedures outlining these methods. Methods for culturing were not specified and were not identical across laboratories (as long as each laboratory started with the appropriate age test organisms). The preliminary round-robin testing (phase 1) included a control sediment (West Bearskin, MN; WB) and a formulated sediment (FS) in which alpha-cellulose represented the primary carbon source (Kemble et al. (61)). The definitive round-robin testing (phase 2) included a copper-contaminated sediment from Cole Creek, MI (CC), a PAH-contaminated sediment from the Little Scioto River, OH (LS) in addition to the West Bearskin and two formulated sediments (USEPA (2)).

17.6.2 Twelve laboratories participated in the preliminary round-robin testing with *H. azteca*. After the 28-day sediment exposures in a control sediment (West Bearskin), survival was >80 % for 100 % of the laboratories; length was >3.2 mm/individual for 92 % of the laboratories; dry weight was >0.15 mg/individual for 66 % of the laboratories; and reproduction was >2 young/female for 78 % of the laboratories (USEPA (2)). Eight laboratories participated in the definitive round-robin testing with *H. azteca*. After the 28-day sediment exposures in a control sediment (West Bearskin), survival was >80 % for 88 % of the laboratories; length was >3.2 mm/individual for 71 % of the laboratories; dry weight was >0.15 mg/individual for 88 % of the laboratories; and reproduction was >2 young/female for 71 % of the laboratories (USEPA

(2). Ten laboratories participated in the preliminary round-robin testing with *C. dilutus*. In these tests, 20-day survival was >70 % for 90 % of the laboratories; 20-day dry weight was >0.6 mg/individual for 100 % of the laboratories; ash-free dry weight was >0.48 mg/individual for 100 % of the laboratories; emergence was >50 % for 70 % of the laboratories; number of eggs/egg case was >800 for 90 % of the laboratories; and percentage hatch was >80 % for 88 % of the laboratories (USEPA (2)). Eight laboratories participated in the definitive round-robin testing with *C. dilutus*. In these tests, 20-day survival was >70 % for 63 % of the laboratories; 20-day dry weight was >0.6 mg/individual for 63 % of the laboratories; ash-free dry weight was >0.48 mg/individual for 67 % of the laboratories; emergence was >50 % for 50 % of the laboratories; number of eggs/egg case was >800 for 63 % of the laboratories; and percentage hatch was >80 % for 57 % of the laboratories (USEPA(2)).

17.6.3 In both the *H. azteca* and *C. dilutus* tests, the results of the preliminary round-robin tests demonstrated that the majority of laboratories met the acceptability criteria for those endpoints for which criteria had been established (e.g., survival and growth). In the preliminary round-robin tests, some laboratories observed low oxygen levels during evaluation of the *C. dilutus* test which was attributed to high feeding rates. To address this issue, the feeding rate for the definitive round-robin testing for *C. dilutus* was reduced from 1.5 to 1.0 ml/beaker/d (USEPA (2)). The proportion of laboratories that met the various endpoint criteria in control sediment in the definitive round-robin testing was higher for *H. azteca* than it was for *C. dilutus*. The most likely reason for the lower success with *C. dilutus* in the definitive round-robin testing was the reduction in feeding rate relative to the preliminary round-robin testing. In the preliminary round-robin testing with *C. dilutus*, the proportion of laboratories meeting the various endpoint criteria was generally higher, particularly for post-pupation endpoints (emergence, reproduction, and percent hatch). Therefore, this standard recommends that the higher feeding rate of 1.5 ml/beaker/d be used in long-term tests with *C. dilutus* (Annex A7).

17.6.4 Minimal detectable differences (MDD) for endpoints measured in the definitive round-robin tests were also reported by USEPA (2). These MDDs were calculated between the control sediment (West Bearskin) and two contaminated sediments (Cole Creek (CC) contaminated primarily with metals or Little Scioto (LS) contaminated primarily polycyclic aromatic hydrocarbons). For the *H. azteca* test, the mean MDD relative to the control sediment and CC sediment was 7.7 % (range 2.4 to 19.5%) for 28-day survival. The mean MDD for 28-day

survival in LS sediment was 10.8 % (range 3.3 to 26 %). The mean MDDs relative to control sediment and CC sediment were 0.26 mm (about 6 % of the mean control response; range 0.18 to 0.33 mm) for 28-day length of amphipods and 0.06 mg (about 24 % of the mean control response; range 0.04 to 0.14 mg) for 28-day dry weight of amphipods. The mean MDDs relative to control sediment and LS sediment were 0.33 mm (about 8 % of the mean control response; range 0.14 to 0.44 mm) for 28-day length of amphipods and 0.10 mg (about 40 % of the mean control response; range 0.05 to 0.16 mg) for 28-day dry weight of amphipods. Mean MDD for the number of young/female was 1.92 young/female (about 61 % of the mean control response; range 0.09 to 2.4 young/female) in CC sediment and 2.06 young/female (about 66 % of the mean control response; range 0.57 to 3.1 young/female) in LS sediment. For the *C. dilutus* test, the mean MDD relative to the control sediment and CC sediment was 14.4 % (range 5.9 to 19.1 %) for 20-day survival. The MDD for 20-day survival of *C. dilutus* in LS sediment was 15.6 % (range 5.8 to 25.3 %). The mean MDDs relative to control sediment and CC sediment were 24.9 % (range 15.6 to 30.4 %) for dry weight and 29.9 % (range 22.9 to 44.6 %) for ash-free dry weight. The mean MDDs relative to control sediment and LS sediment were 64.2 % (range 25.1 to 126.9 %) for dry weight and 68.7 % (range 22.9 to 125 %) for ash-free dry weight. For emergence of *C. dilutus*, mean MDDs were 19.4 % (range 10.5 to 25 %) for CC sediment and 17.9 % (range 8.2 to 23 %) for LS sediment. For the number of eggs produced, mean MDDs were 19.4 % (range 11 to 29.3 %) for CC sediment and 24.4 % (range 11.9 to 37.4%) for LS sediment. For percent hatch, mean MDDs were 42.2 % (range 7.4 to 77.3 %) for CC sediment and 30.5 % (range 9.3 to 53.7 %) for LS sediment.

17.6.5 In summary, the results of these round-robin tests of the long-term sediment toxicity testing methods exhibited similar or better precisions than many chemical analyses and effluent toxicity test methods (248). The success rate for test initiation and completion of these round-robin evaluations are a good indication that a well-equipped and trained staff will be able to successfully conduct these tests. This is an important consideration for any test performed routinely in any regulatory program.

## 18. Keywords

18.1 bioavailability; *Ceriodaphnia dubia*; *Chironomus riparius*; *Chironomus dilutus*; contamination; *Daphnia magna*; *Diporeia spp.*; *Hexagenia spp.*; *Hyalella azteca*; invertebrates; sediment; toxicity; *Tubifex tubifex*; cladoceran, midge, amphipod, mayfly, oligochaete

ANNEXES

(Mandatory Information)

A1. GUIDANCE FOR CONDUCTING SEDIMENT TOXICITY TESTS WITH *CHIRONOMUS RIPARIUS*

A1.1 Significance:

A1.1.1 General culturing procedures are outlined in 12.2. General testing procedures are outlined in 13.3.

A1.1.2 Guidance for conducting sediment toxicity tests with *Chironomus riparius* is summarized in A1.5 and Table A1.1. Paragraph 1.6 outlines the data that will be needed before a test method with *C. riparius* can be developed from this general guidance (see Table 1).

A1.1.3 *Chironomus riparius* has been used in sediment toxicity tests because it is a fairly large midge, has a short generation time, is easily cultured in the laboratory, and the larvae have direct contact with the sediment by burrowing into the sediment to build a case (see Table 1). *Chironomus riparius* has been successfully used in sediment toxicity testing and is sensitive to many contaminants associated with sediments (18, 130, 214, 246-249). The members of the genus are important in the diet of young and adult fish and surface-feeding ducks (250).

A1.2 Life History:

A1.2.1 The classification of holometabolous insects, such as *C. riparius*, presents special difficulties because each life-stage often has different ecological requirements. Further detailed studies at the species level are needed to better understand the various physical, chemical, and biological factors that interact to produce a suitable habitat for larval development (250). The distribution of the family is world wide. Most of the species in the family are thermophilous and adapt to living in standing water, although species do occur in cold habitats and in running water (250). *Chironomus riparius* is a nonbiting midge. The tubiculous larvae frequently inhabit eutrophic lakes, ponds, and

streams and reportedly live in mud-bottom littoral habitats to depths up to 1 m (251). Larvae inhabit gravel, limestone, marl, plants, and silt (252). Ingersoll and Nelson (130) report *C. riparius* to have a wide tolerance of sediment grain size. Sediment ranging from >90 % silt and clay-size particles to 100 % sand-size particles did not reduce larval survival or growth in the laboratory. Larvae of *C. riparius* larvae reportedly occur in the field at a temperature range from 0 and 33°C, pH range from 5 to 9, and at dissolved oxygen concentrations as low as 1 mg/L (252). *Chironomus riparius* tubes are of the type characteristic of bottom-feeding chironomid larvae (251). Larvae frequently extend their anterior ends outside of their tubes feeding on the sediment surface (251). Credland (253) reported *C. riparius* will eat a variety of materials of the appropriate size.

A1.2.2 The biology of *C. riparius* facilitates laboratory culture since larvae are tolerant of a wide range of conditions and adults mate even when confined (249, 253, 254). The life cycle of *C. riparius* can be divided into four distinct stages: (1) an egg stage, (2) a larval stage, consisting of the four instars; (3) a pupal stage; and (4) an adult stage. Midge egg cases hatch in 2 or 3 days after deposition in water at between 19 and 22°C. Larval growth occurs in four instars of about 4 to 7 days each. Under optimal conditions larvae will pupate and emerge as adults after 15 to 21 days at 20°C. Adults emerge from pupal cases over a period lasting several days. Males are easily distinguished from females because males have large, plumose antennae and a much thinner abdomen with visible genitalia. Mating behavior has been described by Credland (254).

A1.3 Obtaining Test Organisms:

TABLE A1.1 Test Conditions for Conducting Sediment Toxicity Tests with *Chironomus riparius*

Parameter	Conditions
1. Test Type:	Whole-sediment toxicity test with or without renewal of overlying water.
2. Temperature:	20 to 23°C
3. Light quality:	Wide-spectrum fluorescent lights
4. Illuminance:	About 100 to 1000 lux
5. Photoperiod:	16L:8D
6. Test chamber:	300 mL (214), 1 L (130), 13 L (248)
7. Sediment volume:	100 mL (214), 200 mL (130), 2 L (248)
8. Overlying water volume:	175 mL (214), 800 mL (130), 11 L (248)
9. Renewal of overlying water:	Static or water renewal.
10. Age of organisms:	First (<3-day old (130,246,248) or second (214) instar at the start of the test.
11. Number of organisms/chamber:	10 (212), 20 (246), 50 (130), 130 (248)
12. Number of replicate chambers/treatment:	Depends on the objective of the test. Eight replicates are recommended for routine testing (see Section 15).
13. Feeding:	Fish food flakes, <sup>11</sup> trout chow, cereal leaves, <sup>10</sup> algae, dog treats.
14. Aeration:	None, unless dissolved oxygen in overlying water drops below 2.5 mg/L.
15. Overlying water:	Culture water, well water, surface water, site water, or reconstituted water.
16. Test chamber cleaning:	If screens become clogged during a test, gently brush the <i>outside</i> of the screen.
17. Overlying water quality:	Hardness, alkalinity, conductivity, pH, and ammonia at the beginning and end of a test. Temperature and dissolved oxygen daily.
18. Test duration:	Up to 10 to 14 days if larval survival or growth are monitored. Up to 30 days if emergence of adults is monitored.
19. End points:	Larval survival, growth, and head capsule width, emergence of adults
20. Test acceptability:	Minimum mean control survival of 70 % and performance-based criteria specifications outlined in Table A1.2.

A1.3.1 General culturing procedures are outlined as follows. The following information is specific to *C. riparius*. Acceptability of a culturing procedure is based in part on performance of organisms in culture and in the sediment test (Section 5 and 11.2). No single technique for culturing test organisms is recommended. What may work well for one laboratory may not work as well for another laboratory. While a variety of culturing procedures are outlined as follows, organisms must meet the test acceptability requirements listed in Table A1.2.

A1.3.2 The following description of culturing procedures was adapted from (130, 184, 195, 249, 251). Both silica sand and shredded paper toweling have been used as substrates to culture *C. riparius*. Either substrate may be used if a healthy culture can be maintained. Greer (195) used sand or paper toweling to culture midges; however, sand was preferred due to the ease in removing larvae for testing. Sources of clean sand are listed in Table 8. See 12.4.2.1 for description of procedures for preparing paper towels.

A1.3.3 Five egg cases will provide a sufficient number of organisms to start a new culture chamber. Egg cases can be held at about 23°C in a glass beaker or crystallizing dish containing about 100 to 150 mL of culture water (temperature change should not exceed 2°C/day). Food should not be added until the embryos are hatching (in about 2 to 4 days at 23°C) to reduce the risk of oxygen depletion. A small amount of green algae (for example, a thin green layer) is added to the water when embryos start to hatch. When most of the larvae have left the egg case, 150 to 200 larvae should be placed into a culture chamber and held until testing. Crowding of larvae will reduce growth. See 12.4.4.1 or 12.4.5.1 for a description of feeding rates.

A1.3.4 *Chironomus riparius* can be reared in aquaria in either static or flowing water with a 16L:8D photoperiod at 20 to 23°C, at about 500 lx). For static cultures the water should be gently aerated and about 25 to 30 % of the water volume should be replaced weekly. Ingersoll and Nelson (130) reared *C. riparius* in 30 by 30 by 30-cm polyethylene containers covered with nylon screen<sup>12</sup>. Each culture chamber contains 3 L of culture water. To start a culture, 200 to 300 mg of cereal leaves<sup>8</sup> is added to the culture chamber; additionally, green algae (*Selenastrum capricornutum* is added *ad libitum* to maintain a growth of algae in the water column and on the bottom of the culture chamber. Cultures are fed about 3 mL of a suspension of commercial dog treats (255) daily. This suspension can be prepared by heating and melting 15 g of dog treats in 150 mL of culture water. After refrigeration, the oily layer which forms on the surface is removed. The remaining material is used to feed the cultures. This suspension contains about 100 mg dry solid/mL. Overfeeding will lead to the growth of fungus in the aquaria and will necessitate more frequent water changes.

A1.3.5 Procedures outlined in 12.4.5 by Greer (195) for culturing *Chironomus dilutus* (formerly known as *C. tentans*; Shobanov et al. 1999. (1), have also been used to culture *C. riparius*. Midges are cultured in 5.7-L polyethylene cylindrical containers. The containers are modified by cutting a semicircle into the lid 16.75 cm across by 12.5 cm. Stainless steel screen (20 mesh/0.4 cm) is cut to size and melted to the plastic lid. The screen provides air exchange, retains emerging adults, and is a convenient way to observe the culture. Two holes about 0.05 cm in diameter are drilled through the uncut portion of the lid to provide access for an airline and to introduce food. The food access hole is closed with a No. 00 stopper. Greer (195)

**TABLE A1.2 Test Acceptability Requirements for a Sediment Toxicity Test with *Chironomus riparius***

- 
- A. It is recommended for conducting a test with *Chironomus riparius* that the following performance criteria are met:
1. Age of *C. riparius* at the start of the test must be within the required range.
  2. Average survival of *C. riparius* in the control sediment must be  $\geq 70\%$  at the end of the test.
  3. Hardness, alkalinity, and ammonia of overlying water typically should not vary by more than 50 % during the test, and dissolved oxygen should be maintained above 2.5 mg/L in the overlying water.
- B. Performance-based criteria for culturing *C. riparius* include the following:
1. It may be desirable for laboratories to periodically perform 96-h water-only reference-toxicity tests to assess the sensitivity of culture organisms (Section 11.16.2). Data from these reference toxicity tests could be used to assess genetic strain or life-stage sensitivity of test organisms to select chemicals.
  2. Laboratories should keep a record of time to first emergence for each culture and record this information using control charts. Records should also be kept on the frequency of restarting cultures.
  3. Laboratories should record the following water-quality characteristics of the cultures at least quarterly: pH, hardness, alkalinity, and ammonia. Dissolved oxygen in the cultures should be measured weekly. Temperature of the cultures should be recorded daily. If static cultures are used, it may be desirable to measure water quality more frequently.
  4. Laboratories should characterize and monitor background contamination and nutrient quality of food if problems are observed in culturing or testing organisms.
  5. Physiological measurements such as lipid content might provide useful information regarding the health of the cultures.
- C. Additional requirements:
1. All organisms in a test must be from the same source.
  2. Storage of sediments collected from the field should follow guidance outlined in Section 10.2.
  3. All test chambers (and compartments) should be identical and should contain the same amount of sediment and overlying water.
  4. Negative-control sediment and appropriate solvent controls must be included in a test. The concentration of solvent used must not adversely affect test organisms.
  5. Culture and test temperatures should be the same. Acclimation of test organisms to the test water is not required. Test organisms must be cultured and tested at the same temperature.
  6. The daily mean test temperature must be within  $\pm 1^\circ\text{C}$  of the desired temperature. The instantaneous temperature must always be within  $\pm 3^\circ\text{C}$  of the desired temperature.
  7. Natural physicochemical characteristics of test sediment collected from the field should be within the tolerance limits of the test organisms.
-

cultures midges under static conditions with moderate aeration and about 90 % of the water is replaced weekly. Each 5.7-L culture chamber contains about 3 L of water and about 25 mL of fine sand. Eight to 10 chambers are used to maintain the culture.

A1.3.5.1 Midges in each chamber are fed 2 mL/day of a 100-g/L suspension of fish food flakes (i.e., fish food flakes<sup>9</sup>) on Tuesday, Wednesday, Thursday, Friday, and Sunday. Two millilitres of a deactivated *Chlorella* suspension is added to each chamber on Saturday and on Monday. The *Chlorella* suspension is prepared by adding 5 g of dry *Chlorella* powder/L of water. The mixture should be refrigerated and can be used for up to two weeks.

A1.3.5.2 The water should be replaced more often if organisms appear stressed (for example, at surface or pale color at the second instar) or if the water is cloudy. Water is replaced by first removing emergent adults with an aspirator. Any growth on the sides of the chamber should be brushed off before water is removed. Care should be taken not to pour or siphon out the larvae when removing the water. Larvae will typically stay near the bottom; however, a small mesh sieve or nylon net can be used to catch any larvae that float out. After the chambers have been cleaned, temperature-adjusted culture water is poured back into each chamber. The water should be added quickly to stir up the larvae. Using this procedure, the approximate size, number, and the general health of the culture can be observed.

A1.3.6 Adult emergence will begin about two to three weeks after hatching at 23°C. Once adults begin to emerge, they can be gently siphoned into a dry aspirator flask on a daily basis. An aspirator can be made using a 250 or 500-mL Erlenmeyer flask, a two-hole stopper, some short sections of 0.25-in. glass tubing, and plastic tubing for collecting and providing suction (Fig. 3). Adults should be aspirated with short inhalations to avoid injuring the organisms. The mouth piece on the aspirator should be replaced or disinfected between use. Sex ratio of the adults should be checked to ensure that a sufficient number of males are available for mating and fertilization. One male may fertilize more than one female. However, a ratio of one male to three females improves fertilization.

A1.3.6.1 A mating and oviposition chamber may be prepared in several different ways (Figs. 3 and 4). About 50 to 75 mL of culture water can be added to the aspiration flask in which the adults were collected (Fig. 3). USEPA Duluth (194) used a 500-mL collecting flask (Fig. 4), which includes a length of nylon screen<sup>12</sup> positioned vertically and extending into the water when water is added. The nylon screen<sup>12</sup> is used by the females to position themselves just above the water during oviposition. The two-hole stopper and tubing of the aspirator should be replaced by screened material or a cotton plug for good air exchange in the oviposition chamber.

A1.3.6.2 Greer (195) used an oviposition box to hold emergent adults which is constructed of a 5.7-L chamber with a 20-cm tall cylindrical chamber on top. The top chamber is constructed of stainless steel screen (35 mesh/2.54 cm) melted onto a plastic lid with a 16.75-cm hole. A 5-cm hole is cut into the side of the bottom chamber and a No. 11 stopper is used to

close the hole. Egg cases are removed by first sliding a piece of plexiglass between the top and bottom chambers. Adult midges are then aspirated from the bottom chamber. The top chamber with plexiglass is removed from the bottom chamber and a forceps is used to remove the egg cases. The top chamber is put back on top of the bottom chamber, the plexiglass is removed, and the aspirated adults are released from the aspirator into the chamber through the 5-cm hole.

A1.3.7 About two to three weeks before the start of a test, 3 to 5 egg cases should be isolated for hatching using procedures outlined in A1.3.3.

A1.3.8 Records should be kept on the time to first emergence and the success of emergence for each culture chamber. See 12.2.6 for additional detail on procedures for evaluating the health of the cultures.

A1.4 Age—Tests with *C. riparius* have been started with larvae: (1) <24-h old (130), 3-day old (246, 248), or 5 to 7-day old (214).

#### A1.5 Toxicity Test Specifications:

A1.5.1 See 13.3 for general testing procedures including Sections: (1) 13.3.1 (Sediment into Test Chambers), (2) 13.3.2 (Renewal of Overlying Water), (3) 13.3.3 (Acclimation), (4) 13.3.4 (Placing Test Organisms in Test Chambers), (5) 13.3.5 (Monitoring a Test and Measurement of Overlying Water Quality Characteristics), (6) 13.3.6 (Feeding), and (7) 13.3.7 (Ending a Test).

A1.5.2 Experimental Design—Decisions concerning the various aspects of experimental design, such as the number of treatments, number of test chambers and midges per treatment, and water quality characteristics, should be based on the purpose of the test and the type of procedure that is to be used to calculate results (Table A1.1, Section 15). Requirements for test acceptability are summarized in Table A1.2. The tests with *C. riparius* are typically conducted at 20 to 23°C with a 16L:8D photoperiod at an illuminance of about 100 to 1000 lx. Zumwalt et al (128), Benoit et al (127), Leppanen and Maier (204), and Wall et al. (205) describe water-renewal systems that can be used to deliver overlying water. Overlying water can be culture water, well water, surface water, site water, or reconstituted water. For site-specific evaluations, the characteristics of the overlying water should be as similar as possible to the site which sediment is collected.

A1.5.2.1 Ingersoll and Nelson (130) describe a 30-day emergence test with *C. riparius*. Test chambers are 1-L beakers containing 200 mL of sediment and 800 mL of overlying water. Fifty first-instar midges (<3-days old) are used to start a test. Midges in each test chamber are fed a combination of cereal leaves<sup>8</sup> (suspended in water), a green algae (*Selenastrum capricornutum*), and commercial dog treats. On Day 0, 75 mg of cereal leaves,<sup>8</sup> 30 mg of dog treats, and  $6 \times 10^7$  *S. capricornutum* algal cells are added to each test chamber. On Day 1 to Day 6 of the test, 15 mg of cereal leaves<sup>8</sup> are added to each test chamber. On Day 1 to Day 12, 30 mg of dog treats are added to each test chamber. On Day 13 to the end of the test, 15 mg



of dog treats are added to each test chamber. Algal cells ( $6 \times 10^7$  *S. capricornutum*) are added to each test chamber daily.

A1.5.2.2 Lee (248) describes an emergence test with *C. riparius*. Test chambers are 13-L glass aquaria containing 2 L of sediment and 11 L of overlying water. One hundred and thirty first-instar midges (3-days old) are used to start a test. Midges in each test chamber are fed 200 mg fish food flakes<sup>10</sup> every other day under static conditions.

A1.5.2.3 Pittinger et al (246) describes an emergence test with *C. riparius*. Test chambers are 120 to 140-cm<sup>2</sup> bottom-surface glass aquaria. Twenty first-instar midges (3-days old) are used to start a test. Midges in each test chamber are fed trout chow and cereal leaves<sup>8</sup> (5 to 1 w/w) and commercial dog treats daily with daily renewal of overlying water. For 24 h after hatching, first-instar midge larvae are often planktonic (246). Pittinger et al (246) suggest not running water through the test chambers for at least 24 h after larvae are added to the test chambers. This will allow time for larvae to settle onto the sediment surface.

A1.5.2.4 Burton et al (214) used the *C. dilutus* test method outlined in 14.2 and Table 18 for conducting sediment toxicity tests with *C. riparius*. The only modification to this procedure was tests were started with second-instar (5- to 7-days old) organisms instead of third instar.

A1.6 *Test Data*—Duration of tests with *C. riparius* range from a <10 days to tests continuing up to 30 days (130, 246, 248). Larval survival, growth, or adult emergence can be monitored as biological endpoints.

A1.6.1 Larval survival and growth can be assessed by ending the tests on Day 10 to Day 14 when larvae have reached the third or fourth instar (41, 130, 211, 214). A consistent amount of time should be taken to examine sieved material for recovery of test organisms (for example, 5 min/replicate). Laboratories should demonstrate their personnel are able to recover an average of at least 90 % of the organisms from whole sediment. For example, test organisms could be added to control or test sediments and recovery could be determined after 1 h (166).

A1.6.1.1 Immobile organisms isolated from the sediment surface or from sieved material should be considered dead. A # 40 sieve (425  $\mu$ m mesh) can be used to remove midge from sediment. Alternatively, Kemble et al. (18) suggests sieving of sediment using the following procedure: (1) pour about half of the overlying water through a No. 50 (300- $\mu$ m) U.S. Standard mesh sieve, (2) pour about half of the sediment through the No. 50 mesh sieve and wash the contents of the sieve into an examination pan, (3) rinse the courser sediment remaining in the test chamber through a No. 40 (425- $\mu$ m) mesh sieve and wash the contents of this second sieve into a second examination pan. Surviving midges can then be isolated from these pans.

A1.6.1.2 Head capsule width can be measured before dry weights are determined. Dry weight of midges should be determined by pooling all living larvae from a replicate and drying the sample at about 60 to 90°C to a constant weight.

Pupae or adult organisms must not be included in the sample to estimate dry weight. The sample is brought to room temperature in a desiccator and weighed to the nearest 0.01 mg. It may be desirable to determine ash-free dry weight (AFDW) of *C. riparius* instead of dry weight. Measurement of AFDW is recommended over dry weight for *C. dilutus* due to the contribution of sediment in the gut to the weight of midge (Section 12.3.8; Sibley et al. (55)). Additional data are needed to determine the contribution of sediment in the gut of *C. riparius* to body weight before a definitive recommendation is made to measure AFDW routinely with *C. riparius*. If test organisms are to be used for an evaluation of bioaccumulation, it is not advisable to dry the sample before conducting the residue analysis. If conversion from wet weight to dry weight is necessary, aliquots of organisms can be weighed to establish wet to dry weight conversion factors. A consistent procedure should be used to remove the excess water from the organisms before measuring wet weight.

A1.6.1.3 Measurement of length is optional. Separate replicate beakers should be set up to sample lengths of midges at the end of an exposure. An 8 % sugar formalin solution can be used to preserve samples for length measurements (130) or other substitutes for formalin can be used as a substitute for formalin (208). The sugar formalin solution is prepared by adding 120 g of sucrose to 80 mL of formalin which is then brought to a volume of 1 L using deionized water. This stock solution is mixed with an equal volume of deionized water when used to preserve organisms. Midge body length ( $\pm 0.1$  mm) can be measured from the anterior of the labrum to the posterior of the last abdominal segment (215). Kemble et al (18) photographed midges at magnification of 3.5 $\times$  and measured the images using a computer-interfaced digitizing tablet. A digitizing system and microscope can also be used to measure length (130).

A1.6.2 Ingersoll and Nelson (130), Pittinger et al (246) and Lee (248) describe procedures for conducting *C. riparius* sediment toxicity tests until the larvae pupate and emerge as adults. Cast pupal skins left by emerging adult *C. riparius* should be removed and recorded daily. These pupal skins remain on the water surface for over 24 h after the emergence of the adult. The test should be ended after the test organisms have been exposed for up to 30 days, when about 70 to 95 % of the control larvae should have completed metamorphosis into the adult life stage. Endpoints calculated in these adult emergence tests include: (1) percent emergence, (2) mean emergence time, or (3) day to first emergence. Egg hatching studies may also be conducted by covering the test chambers and confining the adults. Adults will emerge and lay eggs in these chambers. These egg cases can then be used to estimate effects of exposure on either the number of eggs produced or hatched.

A1.6.3 Average survival of *C. riparius* in the control sediment must be  $\geq 70$  % at the end of the test. See Table A1.2 for additional test acceptability requirements. A low percent adult emergence might not be the result of low survival; larvae or pupae might not have completed development.

## A2. GUIDANCE FOR CONDUCTING SEDIMENT TOXICITY TESTS WITH *DAPHNIA MAGNA* (*D. magna*) AND *CERIODAPHNIA DUBIA* (*C. dubia*)

### A2.1 Significance:

A2.1.1 General culturing procedures are outlined in 12.2. General testing procedures are outlined in 13.3.

A2.1.2 Guidance for conducting 2-day acute sediment toxicity tests with *D. magna* or *C. dubia* is summarized in A2.5.2.1. Guidance for conducting a 7-day chronic sediment toxicity tests with *D. magna* or *C. dubia* is summarized in A2.5.2.2 and Table A2.1. Paragraph 1.6 outlines the data that will be needed before a test method with *D. magna* or *C. dubia* can be developed from this general guidance (see Table 1).

A2.1.3 *Daphnia magna* and *C. dubia* are easily cultured in the laboratory, have a short generation time, survival and reproduction data can be obtained in toxicity tests, and a large data base has developed regarding their sensitivity to toxicants. Nebeker et al (200), Prater and Anderson (256), Malueg et al (257), Burton et al (202), and others (41, 64, 74, 258-265) have successfully used cladocerans in sediment testing and have shown them to be sensitive indicators of the presence of sediment associated contaminants.

A2.1.4 In whole-sediment toxicity tests, cladocera behave as nonselective epifaunal zooplankton. The organisms are frequently observed on the sediment surface and are likely exposed to both water-soluble and particulate-bound contaminants (through ingestion) in overlying water and surface sediments. These routes of exposure do not; however, mimic those of infaunal benthic invertebrates, which are exposed directly to sediment and interstitial water. One of the most important reasons for using cladocerans as toxicity test organisms is their importance in the food web of some systems (163, 266, 267). These assays have been useful at discriminating

sediment contamination and allowing comparisons of relative sediment toxicity. Because they are not benthic organisms, their responses may not be indicative of *in situ* benthic community effects.

### A2.2 Life History:

A2.2.1 Pennak (163) recognizes four distinct periods in the life history of a cladoceran: egg, juvenile, adolescent, and adult. Unstressed populations consist almost exclusively of females producing diploid parthenogenetic eggs which develop into female young. Adult *C. dubia* can produce from 4 to 15 parthenogenetic eggs in each brood whereas *D. magna* can produce 5 to 25 or more eggs (268). When a clutch of eggs is released into the brood chamber, segmentation begins promptly; the first juvenile instar is released into the surrounding water in about 2 days (267). There are only a few juvenile instars and the greatest growth occurs during these stages. The adolescent period is a single instar between the last juvenile instar and the first adult instar during which the first clutch of eggs reaches full development in the ovary. At the close of the adolescent instar, the organism molts and the first clutch of eggs is released into the brood chamber, while a second clutch is developing in the ovary. At the close of each adult instar, four successive events occur: the young are released from the brood chamber to the outside environment, molting occurs, with an increase in size, and there is release of a new clutch of eggs into the brood chamber.

A2.2.2 When populations are stressed (for example, low oxygen, crowding, starvation), males are produced from diploid parthenogenetic eggs. With the appearance of males, females produce haploid eggs which require fertilization.

**TABLE A2.1 Test Conditions for Conducting 7-Day Sediment Toxicity Tests with *Daphnia magna* or *Ceriodaphnia dubia***

Parameter	Conditions
1. Test Type:	Whole-sediment toxicity test with renewal of overlying water.
2. Temperature:	25°C
3. Light quality:	Wide-spectrum fluorescent lights
4. Illuminance:	About 100 to 1000 lux
5. Photoperiod:	16L:8D
6. Test chamber:	30-mL beaker
7. Sediment volume:	5 mL
8. Overlying water volume:	20 mL
9. Renewal of overlying water:	15 mL daily
10. Age of organisms:	<i>D. magna</i> 5-day old at start of test <i>C. dubia</i> <24-h old at the start of the test
11. Number of organisms/chamber:	1
12. Number of replicate chambers/treatment:	Depends on the objective of the test. Ten replicates are recommended for routine testing.
13. Feeding:	Culture food.
14. Aeration:	None, unless dissolved oxygen in overlying water drops below 2.5 mg/L.
15. Overlying water:	Culture water, well water, surface water, site water, or reconstituted water.
16. Test chamber cleaning:	None during a test.
17. Overlying water quality:	Hardness, alkalinity, conductivity, temperature, dissolved oxygen, pH, and ammonia with each water renewal.
18. Test duration:	7 day or when at least 60 % of the controls have produced their third brood.
19. End points:	Survival, growth, reproduction
20. Test acceptability:	Minimum mean control survival of $\geq 80\%$ , average brood size per surviving females in control must be $\geq 15$ for tests with <i>C. dubia</i> or $\geq 20$ for tests with <i>D. magna</i> , and performance-based criteria specifications outlined in Table A2.2.

Following fertilization, the eggs are enclosed by the ephippium and shed at the next molt. The embryos lie dormant until suitable conditions arise upon which they become females producing diploid parthenogenetic eggs (269).

### A2.3 Obtaining Test Organisms:

A2.3.1 General culturing procedures are outlined in 12.2. The following information outline is specific for *D. magna* or *C. dubia*. Acceptability of a culturing procedure is based in part on performance of organisms in culture and in the sediment test (see Section 5 and 11.2). No single technique for culturing test organisms is recommended. What may work well for one laboratory may not work as well for another laboratory. While a variety of culturing procedures are outlined as follows, organisms must meet the test acceptability requirements listed in A2.6 or Table A2.2.

A2.3.2 The following culture procedures are adapted from Knight and Waller (270), while other appropriate methods include the USEPA (3, 159) and Guides E729 and E1295. Following Knight and Waller's (270) methodology, *D. magna* and *C. dubia* can be cultured in reconstituted hard water (160 to 180 mg/L of CaCO<sub>3</sub>) and fed a daily diet of a vitamin-enriched *Selenastrum capricornutum* suspension. Cultures are maintained at 25°C with a 16L:8D photoperiod provided by overhead fluorescent lighting covered with opaque plastic to reduce light intensity to <20 lx. This reduces the photosynthetic activity of the algal food, which could alter water quality. *Daphnia magna* mass cultures are started by placing 10 neonates (<24-h old) into 1-L beakers containing 500 mL reconstituted hard water and a feeding suspension of *S. capricornutum* of about 240 000 algal cells/mL culture water. Cultures are fed 12 mL initially and on Day 1, 25 mL (500 000 cells/mL culture water) on Day 2 through 4, and 25 to 50 mL (100 000 cells/mL culture water) on Day 5 and thereafter. Using this culture method, *D. magna* typically will have first

broods between Day 6 and 8 with successive broods hatching every 36 to 48 h thereafter. On days when hatches occur and young are not needed, adults are transferred to clean 1-L beakers containing 300 mL hard water, 200 mL of culture water, and 50 mL of food. When neonates are needed for testing, adults are isolated the night before by placing each adult into a separate 100-mL beaker containing 100 mL reconstituted hard water and 3 mL feeding suspension. See also Guide E1193 for culture requirements. Neither first brood young nor young from females older than two weeks are used in toxicity testing or starting new cultures. The *S. capricornutum* feeding suspension may also be supplemented with about 6 % by volume addition of ground cereal leaves<sup>8</sup> preparation to the algal feeding suspension. *Ceriodaphnia dubia* mass cultures can be started by placing 20 neonates (<12-h old) into a 600-mL beaker containing 360 mL of reconstituted hard water and 12 mL of the *S. capricornutum* feeding suspension. Cultures are fed 12 mL initially and on Day 1 and 2, and then 18 mL thereafter. When three distinct sizes are noted (generally Day 6), the largest organisms are isolated in 100-mL beakers containing 60 mL of hard water and 2 mL of the feeding suspension. Third brood neonates, <24-h old are used in toxicity testing and starting new mass cultures (Table A2.2). Generally, the first brood is produced on Day 4, the second brood on Day 5, and the third brood on Day 7. See also Guide E1295 for culture requirements.

A2.3.3 USEPA (3) cultured *D. magna* in reconstituted hard water at 25°C with ambient light intensity of 500 to 1000 lx, and 16L:8D photoperiod. Culture vessels can be 3-L glass beakers containing 2.75 L reconstituted hard water and 30 *D. magna*. The *D. magna* can be fed on a daily diet of *S. capricornutum* (100 000 algal cells/mL culture water) or fed three times a week a feeding suspension consisting of YCT (1.5 mL YCT/1000 mL culture water). This should supply about 300 young per week.

**TABLE A2.2 Test Acceptability Requirements for a 7-Day Sediment Toxicity Test with *Daphnia magna* and *Ceriodaphnia dubia***

A.	It is recommended for conducting a 7-day test with <i>D. magna</i> or <i>C. dubia</i> that the following performance criteria are met:
	1. Age of test organisms at the start of the test must be within the required range.
	2. Average survival of test organisms in the control sediment must be ≥80 % at the end of the test.
	3. Average brood size per surviving females in the control sediment must be ≥15 for tests with <i>C. dubia</i> or 20 for tests with <i>D. magna</i> .
	4. Hardness, alkalinity, and ammonia of overlying water typically should not vary by more than 50 % during the test, and dissolved oxygen should be maintained above 2.5 mg/L in the overlying water.
B.	Performance-based criteria for culturing <i>D. magna</i> or <i>C. dubia</i> include the following:
	1. It may be desirable for laboratories to periodically perform 96-h water-only reference-toxicity tests to assess the sensitivity of culture organisms (Section 11.16.2). Data from these reference toxicity tests could be used to assess genetic strain or life-state sensitivity of test organisms to select chemicals.
	2. Laboratories should keep a record of survival of brood organisms and average brood size for each culture and record this information using control charts. Records should also be kept on the frequency of restarting cultures.
	3. Laboratories should record the following water quality characteristics of the cultures at least quarterly: pH, hardness, alkalinity, and ammonia. Dissolved oxygen in the cultures should be measured weekly. Temperature of the cultures should be recorded daily. If static cultures are used, it may be desirable to measure water quality more frequently.
	4. Laboratories should characterize and monitor background contamination and nutrient quality of food if problems are observed in culturing or testing organisms.
	5. Physiological measurements such as lipid content might provide useful information regarding the health of the cultures.
C.	Additional requirements:
	1. All organisms in a test must be from the same source.
	2. Storage of sediments collected from the field should follow guidance outlined in Section 10.2.
	3. All test chambers (and compartments) should be identical and should contain the same amount of sediment and overlying water.
	4. Negative-control sediment and appropriate solvent controls must be included in a test. The concentration of solvent used must not adversely affect test organisms.
	5. Culture and test temperatures should be the same. Acclimation of test organisms to the test water is not required. Test organisms must be cultured and tested at 25°C (±1°C).
	6. The daily mean test temperature must be within ±1°C of 25°C. The instantaneous temperature must always be within ±3°C of 25°C.
	7. Natural physicochemical characteristics of test sediment collected from the field should be within the tolerance limits of the test organisms.

A2.3.4 USEPA (159) procedures for *C. dubia* cultures are as follows. The *C. dubia* are cultured in moderately hard water (80 to 90 mg/L CaCO<sub>3</sub>) at 25°C and a 16L:8D photoperiod. Mass cultures are maintained as backup organism reservoirs and individual organisms are cultured as the source of neonates for toxicity tests. Mass cultures can be started in two 3-L beakers filled to three-fourths capacity with moderately hard water and 40 to 50 neonates/L of medium. The stocked organisms should be transferred to fresh culture media twice weekly for two weeks. At each renewal, the adults are counted and the offspring and old medium discarded. The adults are discarded after two weeks and new mass cultures are started with neonates. Mass cultures are fed daily at the rate of 7 mL of a yeast, cereal leaves,<sup>8</sup> trout chow food preparation (YCT), and 7 mL of *S. capricornutum* concentrate (3.0 to 3.5 × 10<sup>7</sup> cells/mL). Individual *C. dubia* cultures are maintained in 30-mL plastic cups or beakers containing 15 mL of culture media. Cultures are fed daily at the rate of 0.1 mL YCT and 0.1 mL algal concentrate per 15 mL media and are transferred to fresh media at least three times a week. Adults are used as sources of neonates until 14 days of age. Cultures properly maintained should produce at least 15 young per adult in three broods (7 days or less). Goulden and Henry (268) list two other freshwater algal species which can be used for cladoceran food: *Ankistrodesmus falcatus* and *Chlamydomonas reinhardtii*. Winner (271) discusses the effects of four diets (*C. reinhardtii*, *S. capricornutum*, yeast, YCT, and YCT plus *S. capricornutum*) and two reconstituted waters on the vitality of five to six generations of *C. dubia*. His results indicate that healthy populations can be maintained in reconstituted hard water containing only four salts as long as the food is nutritionally adequate and the water is reconstituted from an ultrapure base water. Norberg-King and Schmidt (272) reported the toxicity of effluents was not affected by the diet. *C. dubia* were cultured on.

A2.4 Age—Two-day acute toxicity tests with *D. magna* or *C. dubia* are started with organisms <24-h old. Seven-day chronic toxicity tests are started with *D. magna* 5-day old or *C. dubia* <24-h old.

#### A2.5 Toxicity Test Specifications:

A2.5.1 See 13.3 for general testing procedures including paragraphs: (1) 13.3.1 (Sediment into Test Chambers), (2) 13.3.2 (Renewal of Overlying Water), (3) 13.3.3 (Acclimation), (4) 13.3.4 (Placing Test Organisms in Test Chambers), (5) 13.3.5 (Monitoring a Test and Measurement of Overlying Water Quality Characteristics), (6) 13.3.6 (Feeding), and (7) 13.3.7 (Ending a Test).

A2.5.2 Experimental Design—Decisions concerning the various aspects of experimental design, such as, the number of treatments, number of test chambers and daphnids per treatment, and water quality characteristics, should be based on the purpose of the test and the type of procedure that is to be used to calculate results (Table A2.1 and Section 15). Requirements for test acceptability are summarized in Table A2.2. Overlying water can be culture water, well water, surface water, site water, or reconstituted water. For site-specific

evaluations, the characteristics of the overlying water should be as similar as possible to the site which sediment is collected. See Guides E729 and E1295 for additional details. Nebeker et al (273) conducted 48-h sediment static tests in duplicate using 1-L beakers containing 200 mL of sediment and 800 mL of water (1:4). The sediment is allowed to settle overnight, followed by gentle aeration of overlying water for 30 min before introducing 15 *D. magna* per replicate. Malueg et al. (257) conducted recirculating sediment toxicity tests in a modified recycling device described by Prater and Anderson (256). The test chamber (23 cm long × 6.4 cm wide × 16 cm high) was positioned on a plexiglass plate over two 4-L jars. Twenty *D. magna* were placed in a vessel in the water column and five *Hexagenia* added to chamber sediment. Three to six replicates were used for each control and test sediment. Seven-day (three brood) toxicity tests for aqueous media using cladocerans have been conducted (200, 274, 275) and variations of these methods used to assess sediment toxicity (200, 276).

A2.5.2.1 Experimental Design for 2-day Acute Toxicity Tests—Whole-sediment assays use a 1:4 of sediment to water. Test beakers are maintained at 25°C and a 16L:8D photoperiod (20 lx). Tests are conducted in triplicate using 250 or 100-mL beakers to which 30 mL of sediment (by weight) and 120 mL of overlying water are added (for 250-mL beakers). The weight of 30 mL of sediment is determined by calculating the average wet weight (grams) of five, 5-mL aliquots of sediment obtained using a 10-mL syringe. The average weight of 5-mL is divided by 5 to obtain the weight of 1 mL of sediment. The weight of 1 mL is multiplied by 30 mL to obtain the number of grams to be weighed into each test beaker. When a syringe cannot be used to add sediment, weight of sediment can be used rather than volume (weigh 30 g (wet weight) into each test beaker). In addition, sediment dry weights are determined by weighing triplicate three 5-mL aliquots of wet sediment, drying at 100 to 105°C for 24 h and then reweighing the sediment. Percent dry weight is calculated by dividing the dry sediment weight (grams) by the wet weight and multiplying by 100. Grams of dry weight per millilitre of wet sediment is determined by dividing the dry weight by the millilitre of wet sediment. Overlying water is gently added to each beaker, minimizing sediment resuspension. After a 1 to 2-h settling period, ten test organisms are randomly added to each beaker. Test chambers should be inspected <2 h after the addition of test organisms to check for any floaters. Floaters may not survive and are subjected to a different exposure, thus can be removed and replaced within the first 2 h. Floating may be caused by the sediment sample and may be considered a treatment effect in some cases. However, responses tend to be variable and are seldom dose proportional. Surface films which entrap *D. magna* can be reduced by wiping the surface with cellulose filter paper before adding the test organisms.

A2.5.2.2 Experimental Design for Short-term Chronic Toxicity Tests—See A2.5.2.1 for a description of the procedure for adding sediment to test chambers. Test beakers are maintained at 25°C and a 16L:8D photoperiod (20 lx). Tests are conducted in 30-mL beakers using 5 mL (or 5 g) of sediment and 20 mL of overlying water with 10 replicates/treatment. One organism

is randomly added to each beaker, after the settling period. At each 24-h test interval, the test organism is removed and placed in a beaker containing the control water, young are counted and discarded, and water quality characteristics are measured. About 15 mL of overlying water is siphoned off and gently renewed. The culturing food (for example, 0.1 mL of algae-cereal leaves<sup>8</sup> mixture) is then added to each beaker. After feeding, the test organism is returned to the test beaker. The test is ended at 7 days or when at least 60 % of the controls have produced their third brood.

**A2.6 Test Data**—Survival is recorded every 24 h. Death of a test organism is judged as a result of observing no movement upon gentle prodding. Average brood size is calculated for each replicate beaker.

**A2.6.1** In a 48-h acute toxicity test, average survival of test organisms in the control sediment must be  $\geq 90$  % (**3**).

**A2.6.2** In a 7-day chronic test, (1) average survival of test organisms in the control sediment must be  $\geq 80$  % and (2) average brood size per surviving females in the control sediment must be  $\geq 15$  for tests with *C. dubia* or 20 for tests with *D. magna* (**159, 274, 277**).

**A2.6.3** See **Table A2.2** for additional test acceptability requirements.

### A3. GUIDANCE FOR CONDUCTING SEDIMENT TOXICITY TESTS WITH *HEXAGENIA SPP.*

#### A3.1 Significance:

**A3.1.1** General culturing procedures are outlined in **12.2**. General testing procedures are outlined in **13.3**.

**A3.1.2** Guidance for conducting sediment toxicity tests with *Hexagenia spp.* is summarized in **A3.5** and **Table A3.1**. Paragraph **1.6** outlines the data that will be needed before a test method with *Hexagenia spp.* can be developed from this general guidance (see **Table 1**).

**A3.1.3** *Hexagenia* (Walsh) belong to the order Ephemeroptera: Ephemeridae consisting of large-bodied, burrowing mayflies (**278**). Mayfly nymphs live in U-shaped tubes that are formed in freshwater aquatic sediments and are continuously exposed to sediment, pore water, and overlying water (**279, 280**). Mayfly nymphs have been used in whole-sediment toxicity tests (**200, 256, 258, 281-283**), pore-water exposures (**283**), water exposures (**279, 284**), and for examining the

bioaccumulation dynamics of sediment-associated contaminants (**285**). Mayfly eggs can be stored for up to one year, thereby enabling the production of offspring on a year-round basis (**286**). This ensures the availability of nymphs for testing. *Hexagenia spp.* have been recommended as a mesotrophic benthic indicator organism of freshwater sediments in intermediate waters, due primarily to the nymph's sensitivity to areas of oxygen depletion as a result of organic enrichment (**287, 288**).

#### A3.2 Life History:

**A3.2.1** The most common test species include *H. limbata* (Serville), *H. rigida* (McDunnough), *H. bilineata* (Say), and *H. munda* (Eaton) (**278**) and are common to the United States and Canada (**278**). McCafferty (**278**), Fremling and Mauck (**279**), Edmunds et al (**289**), and Needham et al (**290**) provide excellent reviews on general mayfly biology, ecology, anatomy,

**TABLE A3.1 Test Conditions for Conducting a Long-Term (21-Day) Sediment Toxicity Tests with *Hexagenia spp.***

Parameter	Conditions
1. Test Type:	Whole-sediment toxicity test without renewal of overlying water.
2. Temperature:	20 to 22°C
3. Light quality:	Wide-spectrum fluorescent lights
4. Illuminance:	About 100 to 1000 lux
5. Photoperiod:	16L:8D
6. Test chamber:	1.8-L (11.5 by 11.5 by 14.5-cm) wide-mouthed glass jar
7. Sediment volume:	325 mL
8. Overlying water volume:	1300 mL
9. Renewal of overlying water:	Static without renewal of overlying water.
10. Age of organisms:	Early instar nymphs (3 to 4-month-old nymphs; about 5-mg wet weight)
11. Number of organisms/chamber:	10
12. Number of replicate chambers/treatment:	Depends on the objective of the test. Minimum of three replicates (eight replicates are recommended for routine testing with other test organisms in Section 15).
13. Feeding:	Not necessary
14. Aeration:	None, unless dissolved oxygen in overlying water drops below 2.5 mg/L.
15. Overlying water:	Culture water, well water, surface water, site water, or reconstituted water.
16. Test chamber cleaning:	Not necessary
17. Overlying water quality:	Hardness, alkalinity, conductivity, pH, and ammonia at the beginning and end of a test. Temperature and dissolved oxygen daily.
18. Test duration:	21 days
19. End points:	Nymphal survival and growth (weight or length), molting frequency and behavior (optional)
20. Test acceptability:	Minimum mean control survival of 80 % and performance-based criteria specifications outlined in <b>Table A3.2</b> .

and taxonomy. Natural populations inhabit soft, fine-textured, and organically enriched substrates, but younger instars have been associated with coarser sediments (291). Burrowing mayfly nymphs are deposit-feeders, ingesting mud, detritus, and organic matter (292). Mayflies also filter-feed seston as the nymph passes overlying water through their burrows and ingest smaller amounts of algae, diatoms, bacteria, and plant debris (291).

A3.2.2 *Hexagenia spp.* undergo four stages of development: (1) egg, (2) nymphal stage consisting of several instars, (3) subimago, and (4) imago or adult. Several reports have noted the complex life history of *Hexagenia spp.*, which usually includes a number of co-occurring cohorts where the life-cycle duration varies from 1 to 2 years, depending on geographic location (293). Growth is dependent on temperature and contributes to intra-specific variability (293-295). The emergence of adults occurs over a short period of time, culminating in massive swarms during the summer months. Each female adult can produce an average of 4000 eggs (289). Sexual dimorphism occurs in *Hexagenia spp.*; female nymphs in the later stages of development are larger than males (291). Edmunds et al (289) reports body length of the nymph between 12 and 32 mm and adult wing length between 10 and 25 mm.

### A3.3 Obtaining Test Organisms:

A3.3.1 General culturing procedures are outlined in 12.2. The following information is specific to *Hexagenia spp.* Acceptability of a culturing procedure is based in part on performance of organisms in culture and in the sediment test (Section 5 and 11.2). No single technique for culturing test organisms is recommended. What may work well for one laboratory may not work as well for another laboratory. While a variety of culturing procedures are outlined as follows, organisms must meet the test acceptability requirements listed in Table A3.2.

A3.3.2 *Collection of Nymphs and Eggs for Holding or Rearing*—Organisms can be obtained from the wild, another laboratory, or a commercial source either in the form of nymphs (258) or eggs (286). All individuals in a test should be obtained from the same sources and collected from a clean site. Species can be identified using appropriate taxonomic keys on mature nymphs. Mayfly nymphs used for testing are reared in the laboratory and not continuously cultured due to the length of the mayfly's life cycle and the conditions necessary for mayflies to mature successfully. Therefore, nymphs or eggs are collected as needed.

A3.3.2.1 *Collection of Nymphs*—Mayfly nymphs are found in lakes, rivers, and ponds with soft mud and fine silt/clay bottoms and are found infrequently in areas containing gravel, sand, or peat (296). Overlapping cohorts provide nymphs in a range of developmental stages. The method of collection will vary depending on water depth, current, and substrate characteristics. Dredges and grab samplers (for example, Ponar, Ekman, Peterson, and Shipek) are effective in deeper waters (289 and Guide D4387). A dip net or similar sampler could be used in ponds and along lake margins (289) and Guide D4387). The bottom sediment is washed through an appropriate size stainless steel mesh sieve (0.3 to 3 mm), and the organisms are retrieved and placed into containers of source water (256, 286, 289). Alternatively, the sediment can be placed directly into polyethylene bags (45 by 90 cm) (286). The nymphs should be kept cool during transport and preferably aerated during long trips that last several hours (256, 286, 289). *Hexagenia spp.* nymphs brought into the laboratory should be acclimated to the culture water by gradually changing the water in the holding chamber from the water in which they were transported to 100 % culture water. *Hexagenia spp.* should be acclimated to the culture temperature by changing the water temperature at a rate not to exceed 2°C within 24 h, until the desired temperature is reached. Nymphs should be held so they are not

**TABLE A3.2 Test Acceptability Requirements for a Sediment Toxicity Test with *Hexagenia spp.***

A.	It is recommended for conducting a test with <i>Hexagenia spp.</i> that the following performance criteria are met: <ol style="list-style-type: none"> <li>1. Tests must be started with young, early-instar nymphs of about 3 to 4 months of age (5 mg wet weight, &lt;1 cm in length).</li> <li>2. Average survival of <i>Hexagenia spp.</i> in the control sediment must be <math>\geq 80\%</math> at the end of the test.</li> <li>3. Hardness, alkalinity, and ammonia in the overlying water typically should not vary by more than 50 % during the test, and dissolved oxygen should be maintained above 2.5 mg/L in the overlying water.</li> </ol>
B.	Performance-based criteria for culturing <i>Hexagenia spp.</i> include the following <ol style="list-style-type: none"> <li>1. It may be desirable for laboratories to periodically perform 96-h water-only reference-toxicity tests to assess the sensitivity of culture organisms (Section 11.16.2). Data from these reference toxicity tests could be used to assess genetic strain or life-stage sensitivity of test organisms to select chemicals.</li> <li>2. Laboratories should keep a record of time to hatching and hatching success of eggs. Survival of nymphs during holding should be monitored and record this information using control charts. Records should also be kept on the frequency of restarting cultures.</li> <li>3. Laboratories should record the following water quality characteristics of the cultures at least quarterly: pH, hardness, alkalinity, and ammonia. Dissolved oxygen in the cultures should be measured weekly. Temperature of the cultures should be recorded daily. If static cultures are used, it may be desirable to measure water quality more frequently.</li> <li>4. Laboratories should characterize and monitor background contamination and nutrient quality of food if problems are observed in culturing or testing organisms.</li> <li>5. Physiological measurements such as lipid content might provide useful information regarding the health of the cultures.</li> </ol>
C.	Additional requirements: <ol style="list-style-type: none"> <li>1. All organisms in a test must be from the same source.</li> <li>2. Storage of sediments collected from the field should follow guidance outlined in Section 10.2.</li> <li>3. All test chambers (and compartments) should be identical and should contain the same amount of sediment and overlying water.</li> <li>4. Negative-control sediment and appropriate solvent controls must be included in a test. The concentration of solvent used must not adversely affect test organisms.</li> <li>5. Culture and test temperatures should be the same. Acclimation of test organisms to the test water is not required. Test organisms must be cultured and tested at the same temperature.</li> <li>6. The daily mean test temperature must be within <math>\pm 1^\circ\text{C}</math> of the desired temperature. The instantaneous temperature must always be within <math>\pm 3^\circ\text{C}</math> of the desired temperature.</li> <li>7. Natural physicochemical characteristics of test sediment collected from the field should be within the tolerance limits of the test organisms.</li> </ol>

unnecessarily stressed. To maintain *Hexagenia spp.* in good condition and avoid unnecessary stress, crowding and rapid changes in temperature and water quality characteristics should be avoided.

**A3.3.2.2 Collection of Eggs**—Adults or imagoes are obtained during emergence periods during the summer months. Mature adults are attracted by light traps, such as black and mercury vapor lamps, at dusk (289, 297). Females are attracted in greater numbers than males because of their more photophilic behavior (286). Eggs can be obtained in the field by placing female imagoes on the water surface where the eggs are readily extruded into water-filled containers (279). Alternatively, the female imagoes can be transported to the laboratory within inflated polyethylene bags (45 by 90 cm) for later egg collection (286). The eggs are stored at 8°C within polyethylene bags or petri dishes holding clean water containing an air space (286). Friesen (286) described two methods for preparing the eggs for cold storage. The direct transfer procedure involves keeping the eggs at 20°C for 8.5 days, and then the eggs are transferred to 8°C. Alternatively, the eggs can be held at 20°C for 6.5 days and gradually cooled to 8°C in 4°C increments every 4 days. Fresh eggs are collected routinely during peak emergence periods.

**A3.3.3 Handling**—*Hexagenia spp.* should be handled as little as possible. When handling is necessary, it should be done as gently, carefully, and quickly as possible, so that the mayflies are not stressed unnecessarily. Newly hatched mayfly nymphs are transferred with the narrow end of a Pasteur pipet, and the wide end (5-mm opening) can be used to transfer early instar nymphs (<10 mm long) (282, 286). A spoon-shaped piece of screen (200) or a pair of feather-tipped forceps (282) are useful for handling older nymphs. Mayflies should be introduced into solutions beneath the air-water interface. Any *Hexagenia spp.* that touch dry surfaces, are dropped, or injured during handling should be discarded.

**A3.3.4 Hexagenia Holding and Rearing**—Mayfly nymphs can be obtained directly from the field (230, 256, 257, 286) or reared from eggs that were field collected (200, 282, 284, 286).

**A3.3.4.1 Egg Hatching**—Detailed procedures for starting a culture of *Hexagenia spp.* from eggs are discussed in Friesen (286). The eggs may be transferred from 8°C directly to 20°C (room temperature) or warmed in 4°C increments every 7 days (12°C for 7 days, 16°C for 7 days). Hatching begins in 6 to 8 days at 20°C using either procedure. Eggs can be stored up to 41 weeks using either method and result in comparable hatching success; however, the stepwise procedure appears to yield better hatching success when eggs are stored for longer than 41 weeks (286). Eggs (300 to 500) are placed into 10-cm petri dishes containing 15 mL of clean water. Hatching success is usually between 70 to 90 % and is inversely related to the storage time and extent of clumping of the eggs (286). To reduce clumping, eggs are separated under a dissecting scope (40×) using fine-tipped forceps, and store-bought clay can be added before storage. Enough clay is dissolved in water to form a slurry and is then added to the eggs to provide a thin coating of clay around the eggs. The addition of the clay reduces clumping and allows for improved oxygenation of the eggs during the hatching process. Soon after hatching, the

nymphs are transferred with a Pasteur pipet and gently released below the water surface of the rearing aquaria. The nymphs are counted under a dissecting scope (40×). The eggs will continue to hatch for a period of 3 to 10 days.

**A3.3.4.2 Nymphal Holding and Rearing**—*Hexagenia spp.* require a suitable substrate for burrowing. For rearing and testing purposes, mayfly nymphs have been found to be limited by substrates with a combination of a high sand (>42-μm) content (>80 %) and low TOC (<2.0 mg·g<sup>-1</sup>, dry weight). Therefore, this species may not be suitable for testing inert sediment (for example, beach sand (298)). Fine silt/clay sediment can be obtained from a native area known to support mayfly populations (200, 282, 286) or can be made by mixing reconstituted potting soil and clay (283) with the addition of silica sand (299). Ciborowski et al (300) describes the use of an artificial sediment that contained a 42:42:16 dry weight ratio of sand:clay:potting soil with an organic content of 8 to 10 % loss on ignition. This substrate should be air-dried and autoclaved before use. The field-collected sediment is prepared by initially autoclaving the sediment (200, 286), which may be followed by an exposure to air for 48 h (282). The sediment is placed into aquaria to a uniform depth (1 to 2 cm (282, 286)), overlain with water, and allowed to settle (286). Bedard et al (282) suggest aerating the system for 6 to 7 days before adding the organisms.

**A3.3.4.3** Newly hatched nymphs are interstitial sediment dwellers and do not require feeding for the first 7 days since the sediment can provide sufficient nourishment for establishment. Young organisms may be fed an algal suspension for the first month of development (that is, 10 % *Selenastrum capricornutum* and 10 % *Chlorella fusca* (282)). Nymphs have been fed a diet of cereal leaves<sup>8</sup> and fish food flakes<sup>9,10</sup> (200, 282, 286) on a weekly basis. Malueg et al (258) fed field-collected nymphs either trout chow or a combination of trout chow and cereal leaves.<sup>8</sup> The feeding solutions are prepared by blending the appropriate amount of material in water until a fine slurry is achieved. Bedard et al (282) provided nymphs with an algal suspension (100 to 150 mL) on a weekly basis until the third to fourth week of development, at which time the organisms received a 5-mL aliquot of a vegetable diet twice per week. The vegetable diet consisted of 3 g of cereal leaves,<sup>8</sup> 2 g of fish food flakes,<sup>9,10</sup> and 80 mL of water, and the mixture was blended into a slurry.

**A3.3.4.4** Newly hatched nymphs have been held in static, aerated aquaria ranging from 1 to 40 L in size. The photoperiod can be maintained on a 16L:8D or the natural photoperiod of the region (200, 282, 286). Dechlorinated municipal water has been used for rearing *Hexagenia spp.*, with a pH of 7.1 to 8.2, conductivity of 150 to 350 μS/cm, and total hardness of 100 to 144 mg/L as CaCO<sub>3</sub> (282). Nymph density will vary with organism size. Newly hatched nymphs to 6 months of age (<15 mm) can be maintained at a density of 500/40-L aquarium (200), 2 nymphs/cm<sup>2</sup> (200), or 1 to 4 nymphs/cm<sup>2</sup> (286). Bedard et al (282) transferred 600 newly hatched nymphs to a 6.5-L aquarium containing 900 mL of air-dried, autoclaved sediment and 5.6 L of water. Older, larger nymphs (>15 mm) were held at a density of 100 organisms/40-L aquarium (200) or 1 nymph/5 cm<sup>2</sup> (286) with at least a 5-cm substrate depth

(**200, 286**). Culture water consisted of dechlorinated water or well water at a depth of 15 cm (**282, 286**), and 20 to 25 % of this water was changed once per week (**200, 282**) or 30 to 50 % replaced every 2 to 3 months (**286**). A mesh screen (1-mm openings) was placed over the aquaria to provide a resting place for emerging sub-imagoes. Field-collected mayflies have been kept at 10°C (**258**), 20 to 25°C (**286**), and 22°C (**256**). Nymphal growth is negligible <14°C and optimal growth occurs at 27°C (**279**).

A3.3.5 Records should be kept on the (1) time to and percentage of egg hatching and (2) survival of nymphs before starting a test.

A3.4 *Age*—The following procedures are reported in Nebeker et al (**200**) and Bedard et al (**282**). Laboratory-reared organisms are retrieved from the rearing aquaria or field-collected nymphs from the holding aquaria. Small portions of sediment are washed with test water, and the test organisms are isolated. Larger nymphs (>10 mm) may be retained by using a No. 10 (2-mm) U.S. Standard size sieve and younger nymphs (<10 mm) by using a No. 35 (500- $\mu$ m) U.S. Standard size sieve. The nymphs are washed into enamel trays containing aerating test water. The placement of a fine-mesh sieve (for example, a No. 60 (250- $\mu$ m) U.S. Standard size sieve) into the enamel tray provides a resting place, thus minimizing movement. Test organisms are counted and placed into 50 or 100-mL glass beakers of test water using the wide end of a Pasteur pipet (5-mm opening). The organisms are observed and recounted, and then the contents are gently poured directly into the test chambers. Alternatively, the nymphs are transferred directly from the tray into the test chamber using a spoon-shaped piece of screen. All *Hexagenia spp.* should be transferred within 1 to 2 h to help minimize stress. During sorting, a random subsample of organisms is isolated and weighed individually (wet or dry weight), to determine starting weight and then discarded. Alternatively, length measurements can be obtained on individual organisms (see **A3.6.2**).

A3.4.1 Early-instar nymphs (3 to 4-months old, <8 mm long, about 5 mg wet weight) (**282**), 150-day post-hatch (**283**), and half-grown nymphs (10 to 15 mm long) of an unspecified age (**200**) have been used to start sediment toxicity tests.

### A3.5 *Toxicity Test Specifications:*

A3.5.1 See **13.3** for general testing procedures including: (1) **13.3.1** (Sediment into Test Chambers), (2) **13.3.2** (Renewal of Overlying Water), (3) **13.3.3** (Acclimation), (4) **13.3.4** (Placing Test Organisms in Test Chambers), (5) **13.3.5** (Monitoring a Test and Measurement of Overlying Water Quality Characteristics), (6) **13.3.6** (Feeding), and (7) **13.3.7** (Ending a Test).

A3.5.2 *Experimental Design*—Decisions concerning the various aspects of experimental design, such as the number of treatments, number of test chambers and mayflies per treatment, and water quality characteristics, should be based on the purpose of the test and the type of procedure that is to be used to calculate results (see **Table A3.1** and **Section 15**). Requirements for test acceptability are summarized in **Table A3.2**. The tests with *Hexagenia spp.* are conducted at 20 to

22°C (**256, 258, 282**) or 17°C (**283**) using either the natural photoperiod of the region or a controlled photoperiod of 16L:8D (**256, 282**). Illuminance is typically not specified; however, about 100 to 1000 lx should be acceptable. Renewal of overlying water has not been described in sediment testing with mayflies. Overlying water can be culture water, well water, surface water, site water, or reconstituted water. For site-specific evaluations, the characteristics of the overlying water should be as similar as possible to the site which sediment is collected.

A3.5.2.1 Sediments can be homogenized and placed in the test chambers on the day before the addition of the test organisms (Day -1). The beakers are left unaerated and the sediment allowed to settle overnight. The following morning, the chambers can be aerated for 30 to 60 min using glass-tipped plastic air lines before the introduction of test organisms. During testing, the overlying water is gently aerated with the glass tips positioned 3 cm below the water surface. The test begins when the mayflies are introduced into the test chambers (Day 0).

A3.5.2.2 It may be desirable for laboratories to periodically perform 96-h water-only reference-toxicity tests to assess the sensitivity of culture organisms. Data from these reference-toxicity tests could be used to assess genetic strain or life-stage sensitivity to select chemicals. The previous requirement for laboratories to conduct monthly reference-toxicity tests in an earlier version of this standard (Test Method E1706-95b) has not been included as a requirement for testing sediments due to the inability of reference-toxicity tests to identify stressed populations of test organisms (McNulty et al. (**105**); **Section 11.16**).

A3.5.2.3 Water-only reference-toxicity tests could be conducted using glass tubes as artificial substrates (**279, 284**).

A3.5.3 *Short-Term Sediment Toxicity Tests*—Nebeker et al (**200**) described 10-day, static, whole-sediment toxicity tests using 10 young mayfly nymphs (<10 mm long) placed into 1-L beakers or 10 older nymphs (>10 mm long) placed into 4-L glass beakers. The 1-L jars contained 200 mL of sediment and 800 mL of overlying water, and the 4-L jars contained 800 mL of sediment and 3200 mL of overlying water, both achieving a 4:1 (v:v) water:sediment ratio. Organisms are not fed in either the static or recirculating short-term tests (**200, 283, 301**).

A3.5.3.1 Individual laboratory-reared mayfly nymphs (150-days post-hatch) were exposed to whole sediment for a period of 7 days (**283**). Ten replicates were tested for each treatment. The test chamber was a 250-mL glass jar and overlying water was aerated.

A3.5.3.2 *Recirculating Short-Term Sediment Toxicity Tests*—Mayflies have been exposed in a Prater/Anderson recirculating apparatus (**279**) for a duration of 96 h (**256**), 120 h (**258**), and 10 days ((**200**) and **Guide D4387**) using 10 organisms per chamber. The Prater/Anderson test design permits simultaneous testing of amphipods and daphnids (**256**). Nebeker et al (**200**), Prater and Anderson (**256**), and Malueg et al (**256, 258**) suggest using a modified Prater/Anderson recirculating system that utilizes a test chamber, 23-cm length by 6.4-cm width  $\times$  16-cm height, constructed from 0.55-cm glass. The chamber rests on a plate of plexiglass positioned above



two 4-L jars. The water is circulated from a 4-L glass jar by means of a 4 to 6-mm inside diameter glass tubing into the test chamber and drains into the other 4-L glass jar through an intermittent siphon which is covered by a No. 60 (250- $\mu$ m) stainless steel mesh screen. Water is exchanged between the two 4-L glass jars by means of 100-mm inside diameter glass tubing. Five centimetres of sediment is added to the test chamber through a 5.7-cm outside diameter glass tube and overlaid with 1000 mL of water (water:sediment 9.5:1) without aeration. The apparatus can accommodate 5 to 10 mayflies (256). Multi-species testing has been described using 20 *Daphnia magna* (200) and 20 *Asellus communis* (246). The Prater/Anderson recirculating apparatus must be primed before sediment is added to the system. This is accomplished by circulating 8 L of overlying water at a flow rate of 60 L/min for 24 to 48 h (256 and Guide D4387). The apparatus is then drained, and sediment and fresh water are added. After an equilibration period of 12 h, the water flow is restarted and the test organisms are introduced. Organisms are not fed in either the static or recirculating short-term tests (200, 283, 301).

**A3.5.4 Long-Term Sediment Toxicity Tests**—Bedard et al (282) described 21-day, static, whole-sediment toxicity tests using 10 early instar mayfly nymphs (<8 mm long, about 5-mg wet weight) placed into 1.8-L (11.5  $\times$  11.5  $\times$  14.5-cm) wide-mouthed glass jars with a minimum of three replicates. The 1.8-L jars held 325 mL of sediment and 1300 mL of water, providing a 4:1 (v:v) water:sediment ratio. Air was bubbled through Pasteur pipets positioned just below the water surface to maintain a dissolved oxygen concentration of 7 to 10 mg/L in the overlying water. A flowmeter was used to regulate the air supply to every six test chambers. The test chambers were covered with loosely fitting plastic lids.

**A3.5.4.1** Organisms might not need to be fed during the 21-day tests, depending on the natural food content of the sediment. Previous studies indicated that diet did not influence early instar nymph growth or survival over a 21-day test exposure for a number of sediment types (298).

**A3.6 Test Data**—The endpoint for short-term tests is mortality (200, 258, 283). The endpoints for long-term tests are survival and growth. Burrowing behavior (283) and molting frequency (283, 301) can also be monitored throughout the test, depending on the turbidity of the overlying water.

**A3.6.1** A consistent amount of time should be taken to examine sieved material for recovery of test organisms (for example, 5 min/replicate). Laboratories should demonstrate their personnel are able to recover an average of at least 90 % of the organisms from whole sediment. For example, test organisms could be added to control or test sediments and recovery could be determined after 1 h (166).

**A3.6.2** Mayflies can be isolated from the test chambers by rinsing the test sediments through a 0.5 to 2-mm stainless-steel sieve, depending on test organism size. Material retained upon the screen may be washed into pans, sorted with feather-tipped forceps, and the organisms removed with a Pasteur pipet. Survivorship is recorded for each test chamber. The nymphs can be isolated from each test chamber and transferred to 150-mL beakers holding 100 mL of carbonated water. The nymphs are blotted dry on absorbent towels, and individual wet weights are measured to the nearest 0.01 mg. Alternatively, dry weight measurements may be obtained by drying the nymphs at 60 to 90°C to a constant weight. Organisms pooled for each treatment may be preserved in 70 % ethanol for further length measurements. Hanes and Ciborowski (299) measured head width (across the eyes) as an indicator of nymphal growth.

**A3.6.2.1** It may be desirable to determine ash-free dry weight (AFDW) of mayflies instead of dry weight. Measurement of AFDW is recommended over dry weight for *C. dilutus* due to the contribution of sediment in the gut to the weight of midge (Section 12.3.8; Sibley et al., (55) ). Additional data are needed to determine the contribution of sediment in the gut of mayflies to body weight before a definitive recommendation is made to measure AFDW routinely with mayflies.

**A3.6.3** Average survival of *Hexagenia spp.* in the control sediment must be  $\geq$ 80 % at the end of the test. See Table A3.2 for additional test acceptability requirements.

#### **A4. GUIDANCE FOR CONDUCTING SEDIMENT TOXICITY TESTS WITH *TUBIFEX TUBIFEX***

##### **A4.1 Significance:**

**A4.1.1** General culturing procedures are outlined in 12.2. General testing procedures are outlined in 13.3.

**A4.1.2** Guidance for conducting sediment toxicity tests with *Tubifex tubifex* is summarized in A4.5 and Table A4.1. Paragraph 1.6 outlines the data that will be needed before a test method with *T. tubifex* can be developed from this general guidance (Table 1).

**A4.1.3** The aquatic oligochaete worm *T. tubifex* (Müller 1774) belongs to the family Tubificidae, that is, the sludge worms (302). Although tubificids are best known for their ability to form dense colonies in organically enriched

sediments, they are frequently a major component of benthic invertebrate communities in freshwater and estuarine sediments throughout the world and are an extremely important link in aquatic food webs. Oligochaetes live in and feed by ingesting sediment particles and are thus directly and indirectly exposed to contaminants both through feeding and bodily contact (303). They are also known to transport sediment-bound organics to the surfaces of sediments in a conveyor-belt-type fashion and are thus actively involved in bioturbation (304). The aquatic Oligochaeta, and in particular the Tubificidae, are good indicators of environmental conditions with species assemblages that are characteristic of conditions ranging from oligotrophic to eutrophic (305-311). They have

**TABLE A4.1 Test Conditions for Conducting Sediment Toxicity Tests with *Tubifex tubifex***

Parameter	Conditions
1. Test Type:	Whole-sediment toxicity test without renewal of overlying water.
2. Temperature:	23°C
3. Light quality:	Wide-spectrum fluorescent lights
4. Illuminance:	About 100 to 1000 lux
5. Photoperiod:	16L:8D
6. Test chamber:	250 mL
7. Sediment volume:	100 mL
8. Overlying water volume:	100 mL
9. Renewal of overlying water:	Static without renewal of overlying water.
10. Age of organisms:	Adults
11. Number of organisms/chamber:	4
12. Number of replicate chambers/treatment:	Minimum of five replicates (eight are recommended for routine testing with other test organisms in Section 15).
13. Feeding:	Trout flakes
14. Aeration:	None, unless dissolved oxygen in overlying water drops below 2.5 mg/L.
15. Overlying water:	Culture water, well water, surface water, site water, or reconstituted water.
16. Test chamber cleaning:	Not necessary
17. Overlying water quality:	Hardness, alkalinity, conductivity, pH, and ammonia at the beginning and end of a test. Temperature and dissolved oxygen daily.
18. Test duration:	28 days
19. End points:	Survival and reproduction
20. Test acceptability:	Minimum mean control survival of 90 % and performance-based criteria specifications outlined in Table A4.2.

also been shown in whole-sediment toxicity tests to be fairly sensitive to specific chemical contaminants, particularly metals, and some organics (312-314).

A4.1.4 Tubificids are easily cultured in the laboratory (315-320) and have recognizable life history stages, that is, cocoons, newly hatched worms, immature worms, and mature worms. Breeding individuals can be readily identified by the presence of mature ovaries, testes, or spermatophores (316, 319, 320). One of the most appropriate endpoints for interpreting the results of toxicity tests, in a field context, is reproduction and this parameter is readily measured using tubificids. These organisms are considered ideal for determining the toxicity of contaminants in sediments to benthic biota. Table A4.1 describes procedures for a 28-day survival and reproductive test using the freshwater oligochaete tubificid worm, *T. tubifex*, in order to obtain laboratory data concerning the adverse effects of potentially contaminated sediments or data from experiments where a contaminant is added to sediment (spiked-sediment toxicity tests).

A4.1.5 The species of tubificid worm to be used in the sediment toxicity test is *Tubifex tubifex*. In comparison with other tubificid worms used in sediment experiments, *T. tubifex* was found to be suitable for large-scale testing, as it had a short generation time and was thus capable of producing more breeding individuals for use in toxicity tests than other species of tubificids (315, 320). *Tubifex tubifex* is found over a wide range of habitats, especially those that are enriched with organic material, and tolerates natural differences in the characteristics of sediments, that is, percent organic matter and particle size (302).

A4.1.6 Alternate species that may be used include *Limnodrilus hoffmeisteri* Claparède, 1862, *Stylodrilus heringianus* Claparède, 1862 and *Quistadrilus multisetosus* (Smith 1990), but test procedures have not been standardized for these species. If another tubificid oligochaete species is chosen for use, size of the test chamber, number of organisms in test containers, duration of the test, temperature, organic content of

culture, and control sediment and feeding regime, and so forth, might have to be modified to accommodate the requirements of the test species. The sensitivity of a prospective new test species of tubificid should be compared with a reference species before the new species is used in routine toxicity testing. For example, *L. hoffmeisteri* has a tendency to collect foreign particles, mostly of clay, that together with mucous secretions, form tubes in which the organisms dwell and that are difficult to separate from the worms (321). Furthermore, the cocoons of this species are covered with an adhesive coating to which detrital material adheres. This adhesion makes counting the number of cocoons difficult and increases the time required to take down the test and results in enumeration of cocoons and juveniles being less accurate. Chapman et al (313) also found that oligotrophic species such as *S. heringianus* were more tolerant to specific chemical pollutants and environmental factors. An alternative species of oligochaete, *Lumbriculus variegatus*, has been used for assessing the toxicity and bioaccumulation of sediment-associated contaminants (Section 14, (2, 6, 9)).

A4.2 *Life History*—Under field conditions, the abundance of *T. tubifex* varies seasonally and is somewhat dependent on the amount of eutrophication or organic enrichment at a geographic location. The Tubificidae are hermaphroditic and reproduction is sexual with the main recruitment in temperate regions occurring from mid-winter (February) to late summer (August, 322). Mature adults may reproduce twice a year. Newly hatched worms require a number of weeks to mature depending on temperature and food supplies, and some of the young, which hatch early in the reproductive season, may breed during the summer following hatching (302). Stages of development that have been identified from field samples (315, 316) include cocoons, immatures (characterized by the absence of penis sheaths or oocytes), matures (presence of a penis sheath or oocytes), and breeding (presence of spermatophores, ovaries, or testes).

### A4.3 Obtaining Test Organisms:

A4.3.1 General culturing procedures are outlined in 12.2. The following information is specific to *T. tubifex*. Acceptability of a culturing procedure is based in part on performance of organisms in culture and in the sediment test (Section 5 and 11.2). No single technique for culturing test organisms is recommended. What may work well for one laboratory may not work as well for another laboratory. While a variety of culturing procedures are outlined as follows, organisms must meet the test acceptability requirements listed in Table A4.2.

A4.3.2 Laboratory culture of *T. tubifex* is relatively easy (316, 318), but it should be noted that there is evidence of genetic strains of tubificids that may vary in their reproductive capacity in the laboratory. This variation could be based on the temperature of the environment in which the organisms were living when collected (318). For example, specimens of *T. tubifex* collected from the English Lake District in the United Kingdom only grew within a narrow temperature range from 10 to 13°C, which was consistent with temperatures at the bottom of the lakes where the organisms were living when removed (323). In contrast, *T. tubifex* obtained from Hamilton Harbor in Lake Ontario require temperatures of 20 to 30°C for good reproduction and growth (320). No cocoons were produced in the Hamilton Harbor population at temperatures between 5 and 15°C. Individuals of this genetic strain of *T. tubifex*, when maintained in dark, aerated 20 by 20 by 20-cm aquaria at a temperature of 23°C, emerged from cocoons 7 to 8 days after the cocoons were laid. Organisms became sexually mature about 6 to 12 weeks after cocoons hatched, depending on the densities of organisms in the culture chamber and the availability of food. Kaster (324) reported that cultures of *T. tubifex* (source unknown) reached sexual maturity in 67 days at 15°C and matured faster at higher temperatures in substrates

with increased organic content (range from 0.1 to 7 %). Mean number of embryos per cocoon ranged from 4 to 11 in this study and mean number of cocoons per worm ranged from 5 to 18 at 15°C; 50 % of embryos hatched in 20 days at this temperature. When *T. tubifex* populations become too large in aquaria, their reproductive ability is inhibited due to density-dependent affects (316, 320, 325). Numbers in excess of densities equivalent to 2000 m<sup>2</sup> (320) and 3500 m<sup>2</sup> (325) have been shown to inhibit growth of newly hatched young worms and reproduction respectively.

A4.3.3 *Source and Culture of Test Species*—Laboratory cultures of single species of *T. tubifex* can be started by the collection of specimens from the benthos of suitable “clean” lakes, ponds, or streams where fine organic material is present using appropriate sampling apparatus (for example, Ponar or Ekman dredge). Organisms are isolated from the benthos by sieving sediment through 500 or 250- $\mu$ m mesh sieves and the contents of the sieve are then placed in enamel trays with water. Individual organisms are then gently and quickly transferred with fine forceps or smooth wide-mouthed glass pipets into isolation chambers with sediment to be used for culturing (for example, 250-mL beakers with sediment:water ratio of 1:1). It is important that organisms are not unnecessarily stressed during transfer and are maintained in isolation in culture sediment. Organisms that touch dry absorbent surfaces or are injured during handling should be discarded. Once isolated individuals have reproduced, the cocoons are transferred to fresh sediment (see A4.3.4) and allowed to reach maturity and to reproduce. Sexually mature individuals from the *F1* generation are then sacrificed to confirm the identity of the species being cultured using appropriate taxonomic keys (326, 327) and by confirmation with an acknowledged taxonomic expert (302). Sexually mature individuals can be readily

**TABLE A4.2 Test Acceptability Requirements for a Sediment Toxicity Test with *Tubifex tubifex***

A.	It is recommended for conducting a test with <i>T. tubifex</i> that the following performance criteria are met: <ol style="list-style-type: none"> <li>Age of <i>T. tubifex</i> at the start of the test must be within the required range.</li> <li>Average survival of <i>T. tubifex</i> in the control sediment must be <math>\geq 90\%</math> at the end of the test. The coefficient of variation (CV) for production of total young and total cocoons in control sediment should be <math>&lt; 25\%</math> and the mean value for any one control sediment should not vary by <math>&gt; 15\%</math> of the long-term average for the laboratory conducting the tests.</li> <li>Hardness, alkalinity, and ammonia of overlying water typically should not vary by more than 50 % during the test, and dissolved oxygen should be maintained above 2.5 mg/L in the overlying water.</li> </ol>
B.	Performance-based criteria for culturing <i>T. tubifex</i> include the following <ol style="list-style-type: none"> <li>It may be desirable for laboratories to periodically perform 96-h water-only reference-toxicity tests to assess the sensitivity of culture organisms (Section 11.16.2). Data from these reference toxicity tests could be used to assess genetic strain or life-stage sensitivity of test organisms to select chemicals.</li> <li>Laboratories should monitor the frequency with which the population is doubling in the culture (number of organisms) and record this information using control charts (doubling rate would need to be estimated on a subset of organisms from a mass culture). Records should also be kept on the frequency of restarting cultures.</li> <li>Laboratories should record the following water quality characteristics of the cultures at least quarterly: pH, hardness, alkalinity, and ammonia. Dissolved oxygen in the cultures should be measured weekly. Temperature of the cultures should be recorded daily. If static cultures are used, it may be desirable to measure water quality more frequently.</li> <li>Laboratories should characterize and monitor background contamination and nutrient quality of food if problems are observed in culturing or testing organisms.</li> <li>Physiological measurements such as lipid content might provide useful information regarding the health of the cultures.</li> </ol>
C.	Additional requirements: <ol style="list-style-type: none"> <li>All organisms in a test must be from the same source.</li> <li>Storage of sediments collected from the field should follow guidance outlined in Section 10.2.</li> <li>All test chambers (and compartments) should be identical and should contain the same amount of sediment and overlying water.</li> <li>Negative-control sediment and appropriate solvent controls must be included in a test. The concentration of solvent used must not adversely affect test organisms.</li> <li>Culture and test temperatures should be the same. Acclimation of test organisms to the test water is not required. Test organisms must be cultured and tested at 23°C (<math>\pm 1^\circ\text{C}</math>).</li> <li>The daily mean test temperature must be within <math>\pm 1^\circ\text{C}</math> of 23°C. The instantaneous temperature must always be within <math>\pm 3^\circ\text{C}</math> of 23°C.</li> <li>Natural physicochemical characteristics of test sediment collected from the field should be within the tolerance limits of the test organisms.</li> </ol>

identified by eye or under a low-power microscope. Immature worms are a uniform pink color. The presence of developed testes or ovaries are identified by the presence of large creamy white structures occupying several anterior segments and covering the entire width of the organism. Cocoons (about 200) from mature and taxonomically verified specimens are then placed in larger aquaria (about 10 L) with sediment (see [A4.3.4](#)) and water (that is, a consistent and reliable source of uncontaminated groundwater, surface water, dechlorinated municipal water, reconstituted water, or “upstream” receiving water) in a 1:4 ratio of sediment to water, and organisms are allowed to grow under static culture conditions for about 8 weeks or until sexually mature adults are observed. Dissolved oxygen of  $\geq 5$  mg/L is also required for healthy cultures, and this concentration can be maintained by gentle aeration ([320](#)). Culture sediment should be changed (replenished with fresh sediment) when large percentage ( $>80\%$ ) of adult worms are observed to be not in a reproductive state and few cocoons or young are present.

**A4.3.3.1** *Tubifex tubifex* may also be obtained from laboratories where known species are in continuous culture ([315-320](#)).

**A4.3.4** *Culture/Control Sediment*—Sediment in which worms are cultured should be collected from an area low in contaminants, preferably with a high organic content (6 to 12 %) and with appropriate particle size distribution for oligochaetes (for example, 1 to 2 % sand, 60 to 70 % silt, 30 to 40 % clay), which preferentially select particles of  $<62\ \mu\text{m}$ . There is circumstantial evidence that tubificids use microflora growing on sediment particles as a food source rather than detrital organic material ([323](#)). Additional feeding is not required but it should be noted that culture vigor can decline over a number of months and therefore the culture sediment should be changed on a regular basis (about every 2 to 6 months). Any sediment used to culture tubificids should be sieved through 250- $\mu\text{m}$  mesh to remove large, indigenous macrofauna or cocoons and juveniles of other species of tubificids. Autoclaving, freezing, and gamma-irradiation (10 to 30 KGy) of sediment can be used as an alternative technique to remove indigenous species, but growth and reproduction of *T. tubifex* can be altered in sediments that are manipulated ([323](#)). An alternative culture technique is the use of silica sand as a substrate with blended lettuce added as a food supplement ([318](#)). If this latter method is used, the lettuce should be washed and rinsed with culture water and blended into a puree; this puree can be frozen and small amounts (10 g) are added to the culture on a biweekly basis.

**A4.3.5** Laboratories should monitor the frequency with which the population is doubling in the culture (number of organisms) and record this information using control charts (doubling rate would need to be estimated on a subset of organisms from a mass culture). Records should also be kept on the frequency of restarting cultures.

**A4.4** *Age*—Tests with *T. tubifex* have been started with sexually mature organisms.

#### **A4.5** *Toxicity Test Specifications:*

**A4.5.1** See [13.3](#) for general testing procedures including paragraphs: (1) [13.3.1](#) (Sediment into Test Chambers), (2) [13.3.2](#) (Renewal of Overlying Water), (3) [13.3.3](#) (Acclimation), (4) [13.3.4](#) (Placing Test Organisms in Test Chambers), (5) [13.3.5](#) (Monitoring a Test and Measurement of Overlying Water Quality Characteristics), (6) [13.3.6](#) (Feeding), and (7) [13.3.7](#) (Ending a Test).

**A4.5.2** *Experimental Design*—Decisions concerning the various aspects of experimental design, such as the number of treatments, number of test chambers and test organisms per treatment, and water quality characteristics, should be based on the purpose of the test and the type of procedure that is to be used to calculate results ([Table A4.1](#) and [Section 15](#)). Requirements for test acceptability are summarized in [Table A4.2](#). The tests with *T. tubifex* can be conducted at 23°C using either the natural photoperiod of the region or a controlled photoperiod of 16L:8D. Illuminance is typically not specified; however, about 100 to 1000 lx should be acceptable. Renewal of overlying water has not been described in sediment testing with *T. tubifex*. Overlying water can be culture water, well water, surface water, site water, or reconstituted water. For site-specific evaluations, the characteristics of the overlying water should be as similar as possible to the site at which sediment is collected.

**A4.5.3** Four sexually mature specimens of *T. tubifex* are added to each replicate toxicity test chamber (for example, 250-mL beakers). In general, five replicates per treatment achieve an acceptable level of standard error (20 %) as well as discriminatory power ([320](#)). The test is conducted for 28 days and adult survival and reproduction are monitored.

**A4.5.3.1** The toxicity test chambers consist of 250-mL glass beakers. At least 24 h before the toxicity test begins, 500 mL of each treatment sediment should be sieved through 250- $\mu\text{m}$  mesh to remove large, indigenous macrofauna. Each 250-mL beaker receives 100 mL of sieved sediment and 100 mL of water. Moistened food (80 mg of commercial trout flakes with enough distilled water to wet the food (about 5 mL)) is added to each beaker and the beaker is placed in the dark in the test incubator at 23°C for 24 h before adding worms. After addition of the adult worms, the beakers are covered with disposable loose-fitting lids from plastic petri dishes to keep out dust and reduce evaporative loss. Each beaker is aerated using disposable pipets and air lines.

**A4.5.3.2** Sexually mature species of *T. tubifex* (as indicated by the presence of testes or ovaries, see [A4.3.3](#)) are removed from the culture sediment using a 500- $\mu\text{m}$  mesh sieve. These organisms are transferred into a disposable petri dish containing water, four per dish. When sufficient organisms have been collected for each test beaker, they are added to the toxicity test beakers and the beakers are returned to the incubation chamber. The beakers should be examined every 2 to 3 days for loss of water due to evaporation. Any loss of water should be replaced with deionized water. The overlying water is monitored for water quality characteristics as outlined in [Table A4.1](#).

**A4.5.3.3** After 28 days, beakers are removed from the test incubator and the contents are individually sieved through 500- $\mu\text{m}$  and 250- $\mu\text{m}$  mesh sieves. The material in the two sieves are washed separately into two small plastic petri dishes

for enumeration with a dissecting microscope. If there is insufficient time for complete counting, the contents of the two sieves can be preserved in 4 % formalin for future enumeration.

#### A4.6 Test Data:

**A4.6.1 Endpoints**—Organisms collected from the 500- $\mu$ m mesh at the end of a test include adults and large young, as well as empty and full cocoons. Contents from the 250- $\mu$ m mesh sieve allow an enumeration of small young. Direct endpoints measured are survival of original adults, number of cocoons (both empty and containing embryos), number of small young (retained by 250- $\mu$ m mesh), and number of large young (retained by 500- $\mu$ m mesh). The separation of the young individuals into two size classes provides an estimate of growth in the offspring. In addition, a number of derived endpoints can be calculated such as survivorship, percent hatch of cocoons (by tabulating empty cocoons/total cocoons), total young produced, cocoons/adult, young/cocoon, and young/adult. Data are recorded and stored in an appropriate medium for later analysis. Guidance on statistical analyses of the data is found in Section 15.

**A4.6.2** A consistent amount of time should be taken to examine sieved material for recovery of test organisms (for example, 5 min/replicate). Laboratories should demonstrate their personnel are able to recover an average of at least 90 %

of the organisms from whole sediment. For example, test organisms could be added to control or test sediments and recovery could be determined after 1 h (166).

**A4.6.3 Other Measurements**—There are a number of other biological measurements that may be considered as toxicity test endpoints. The morphological effects of chemicals on tubificids were examined by Chapman and Brinkhurst (328). They were able to induce chaetal changes in *T. tubifex* and *Ilyodrilus frantzi* by manipulation of the chemical environment. Effects of contaminants on burrowing behavior have been examined in *L. hoffmeisteri* and *S. heringianus*, using both field sediments and sediments spiked with endrin, but the test is very labor-intensive (304, 329, 330). McMurtry (314) also showed avoidance behavior in *T. tubifex* and *L. hoffmeisteri* to copper and zinc by using a method that requires considerably less time. However, a considerable amount of work is required to develop this approach as a toxicity endpoint.

**A4.6.4** Average survival of *T. tubifex* in the control sediment must be  $\geq 90$  % at the end of the test. The coefficient of variation (CV) for production of total young and total cocoons in control sediment should be  $< 25$  % and the mean value for any one control sediment should not vary by  $> 15$  % of the long-term average for the laboratory conducting the tests. See Table A4.2 for additional test acceptability requirements.

## A5. GUIDANCE FOR CONDUCTING SEDIMENT TOXICITY TESTS WITH *DIPOREIA SPP.*

### A5.1 Significance:

**A5.1.1** General culturing procedures are outlined in 12.2. General testing procedures are outlined in 13.3.

**A5.1.2** Guidance for conducting sediment toxicity tests with *Diporeia spp.* is summarized in A5.5 and Table A5.1. Para-

**TABLE A5.1 Test Conditions for Conducting Sediment Toxicity Tests with *Diporeia spp.***

Parameter	Conditions
1. Test Type:	Whole-sediment toxicity test without renewal of overlying water.
2. Temperature:	4 to 10°C
3. Light quality:	Illuminated with a 15-W red darkroom light to encourage burrowing
4. Illuminance:	About 100 to 1000 lux
5. Photoperiod:	Continuous
6. Test chamber:	250 mL to 1 L
7. Sediment volume:	2 cm on bottom of beaker (about 200 mL in 1-L beaker)
8. Overlying water volume:	600 mL in 1-L beaker
9. Renewal of overlying water:	Static without renewal of overlying water.
10. Age of organisms:	Juveniles
11. Number of organisms/chamber:	20
12. Number of replicate chambers/treatment:	Depends on the objective of the test. Eight replicates are recommended for routine testing (see Section 15).
13. Feeding:	None
14. Aeration:	None, unless dissolved oxygen in overlying water drops below 2.5 mg/L.
15. Overlying water:	Culture water, well water, surface water, site water, or reconstituted water.
16. Test chamber cleaning:	Not necessary
17. Overlying water quality:	Hardness, alkalinity, conductivity, pH, and ammonia at the beginning and end of a test. Temperature and dissolved oxygen daily.
18. Test duration:	28 days
19. End points:	Survival and behavior
20. Test acceptability:	Minimum mean control survival of 90 % and performance-based criteria specifications outlined in Table A5.2.

graph 1.6 outlines the data that will be needed before a test method with *Diporeia spp.* can be developed from this general guidance (Table 1).

A5.1.3 *Diporeia spp.*, Amphipoda, are prominent benthic invertebrate in the Great Lakes and represents the majority of the benthic biomass at depths >30 m (331). They are found in all of the Great Lakes except Lake St. Clair and the Western Basin of Lake Erie. Formerly named *Pontoporeia hoyi* (332) and earlier *Pontoporeia affinis* (333), *Diporeia spp.* are considered a sensitive benthic species based on its disappearance from polluted sites in the Great Lakes (334). They are easily collected in large numbers and can be readily held in the laboratory. These organisms have been used extensively for studying the bioaccumulation of sediment-associated organic contaminants (36, 335, 336) and have also been used in toxicity tests with both laboratory-dosed (336, 337) and field-collected sediments (338-342). Their sensitivity to specific contaminants, carbaryl, pentachlorophenol, and cadmium has been examined through water-only exposures (343, 344). These amphipods are considered to be relatively insensitive to grain size based on preference studies (345) and its field distribution in sediments ranging from coarse sands to silty muck (346). The amphipods are also tolerant to a wide range of temperature and salinity (344) and to low oxygen regimes based on field sampling (347).

#### A5.2 Life History:

A5.2.1 The life cycle of *Diporeia spp.* is not completely defined but the life expectancy ranges from one to three years with the shorter life cycle found in organisms inhabiting the shallower areas (348, 349). Reproduction occurs in both the winter and summer. In the shallower regions, the reproductive peak is in the spring. Juveniles grow rapidly through the spring and summer and reach maximum size in the fall (349). *Diporeia spp.* make excellent use of the spring diatom bloom and accumulate large lipid stores (350, 351). During the

summer months the lipid content of *Diporeia spp.* can be as great as 50 % of the dry weight (351). There is some discussion that there may well be four *Diporeia spp.* in the Great Lakes but they have not been completely described and can only be differentiated when sexually mature (332).

A5.2.2 *Diporeia spp.* are burrowing amphipods that ingest small organic rich particles with their associated bacteria and ingest a wide size range of particles (345). Generally, *Diporeia spp.* can ingest particles less than 40 µm in diameter. Recent studies suggest that these organisms are extremely selective feeders preferentially choosing particle sizes in the range from 20 to 40 µm (35).

A5.2.3 Sexual dimorphism occurs with *Diporeia spp.* late in their life cycle. Once sexually mature the males live only for about 10 days while the females live a few months.

#### A5.3 Obtaining Test Organisms:

A5.3.1 General culturing procedures are outlined in 12.2. The following information is specific to *Diporeia spp.* Acceptability of a culturing procedure is based in part on performance of organisms in culture and in the sediment test (Section 5 and 11.2). No single technique for culturing test organisms is recommended. What may work well for one laboratory may not work as well for another laboratory. While a variety of culturing procedures are outlined as follows, organisms must meet the test acceptability requirements listed in Table A5.2.

A5.3.2 Because of their long life span, *Diporeia spp.* are not readily cultured in the laboratory. However, they are readily collected from the field using any of several types of bottom samplers. The densities of *Diporeia spp.* in the Great Lakes are large in some cases >10 000-m<sup>2</sup> individuals (346). While *Diporeia spp.* are very abundant, they should be collected from areas that are known to have low (near background) sediment contaminant concentrations. Such areas can be located by consulting with local contaminants experts. Typically, the

**TABLE A5.2 Test Acceptability Requirements for a Sediment Toxicity Test with *Diporeia spp.***

A.	It is recommended for conducting a test with <i>Diporeia spp.</i> that the following performance criteria are met: <ol style="list-style-type: none"> <li>1. Age of <i>Diporeia spp.</i> at the start of the test must be within the required range.</li> <li>2. Average survival of <i>Diporeia spp.</i> in the control sediment must be ≥90 % at the end of the test. Survival in individual replicates in the control sediment must be ≥80 %.</li> <li>3. Hardness, alkalinity, and ammonia of overlying water typically should not vary by more than 50 % during the test, and dissolved oxygen should be maintained above 2.5 mg/L in the overlying water.</li> </ol>
B.	Performance-based criteria for culturing <i>Diporeia spp.</i> include the following <ol style="list-style-type: none"> <li>1. Laboratories should perform monthly 96-h water-only reference-toxicity tests to assess the sensitivity of test organisms. If reference-toxicity tests are not conducted monthly, the lot of organisms used to start a sediment test must be evaluated using a reference toxicant (see 11.16).</li> <li>2. Laboratories should keep a record of the survival of field-collected amphipods during holding before testing.</li> <li>3. Laboratories should record the following water quality characteristics of the cultures at least quarterly: pH, hardness, alkalinity, and ammonia. Dissolved oxygen in the cultures should be measured weekly. Temperature of the cultures should be recorded daily. If static cultures are used, it may be desirable to measure water quality more frequently.</li> <li>4. Physiological measurements such as lipid content might provide useful information regarding the health of the cultures.</li> </ol>
C.	Additional requirements: <ol style="list-style-type: none"> <li>1. All organisms in a test must be from the same source.</li> <li>2. Storage of sediments collected from the field should follow guidance outlined in Section 10.2.</li> <li>3. All test chambers (and compartments) should be identical and should contain the same amount of sediment and overlying water.</li> <li>4. Negative-control sediment and appropriate solvent controls must be included in a test. The concentration of solvent used must not adversely affect test organisms.</li> <li>5. Culture and test temperatures should be the same. Acclimation of test organisms to the test water is not required. Test organisms must be cultured and tested at the same temperature.</li> <li>6. The daily mean test temperature must be within ±1°C of the desired temperature. The instantaneous temperature must always be within ±3°C of the desired temperature.</li> <li>7. Natural physicochemical characteristics of test sediment collected from the field should be within the tolerance limits of the test organisms.</li> </ol>

organisms are gently screened from the sediment and placed in large polyethylene bags containing cool lake water. It is easiest to collect *Diporeia spp.* at the transition between the sandy shallow sediments and finer deep sediments. This minimizes the amount of extraneous material carried from the field. The polyethylene bags of lake water and *Diporeia spp.* are placed in a cooler with ice and transported to the laboratory (352). Aeration is to be avoided with these organisms since they easily become trapped at the air-water interface in the surface tension. Lake sediment for holding the organisms should be transported separately to minimize the amount of sediment that must be transported and to ensure that the organisms are not injured during the transport or in setting up culture aquaria.

A5.3.3 *Diporeia spp.* can be held in the laboratory either under static or water-renewal conditions. If held under static conditions, the aquaria should not be aerated in order to prevent entrapment in the surface tension at the air-water interface. If water-renewal conditions are used, water may be aerated before introduction into aquaria. Amphipods are typically held in aquaria containing 4 cm of lake sediment and 10 cm of lake water or other culture water at 4°C. Lake water, collected from Lakes Michigan, St. Clair, and Huron, has been the primary fresh water used for holding organisms in culture and as the overlying water for testing. Other water sources such as well water and dechlorinated tap water may be used if it is demonstrated that the water will not result in deleterious effects on the organism, that is, organism health such as maintenance of organism lipid content and absence of mortality is maintained over a period equivalent to the maximum holding time plus the duration of the test (that is, two months). Mean lipid content ranges from 21 to 54 % of dry weight (351). Sediment for culture and control has been lake sediment from or near the site of collection. Other culture sediment could be used if both survival and organism health (that is, lipid content) can be maintained using the sediment. The light regime is constant light from a 15-W red darkroom light. The organisms are typically held at 4°C regardless of the temperature of collection. An acclimation period of at least 3 to 4 days should be allowed after collection before starting a test. While the amphipods will readily survive for several months in the laboratory, organisms that have been held for more than one month should not be used for toxicity tests. Organisms are not held more than one month before testing because under our static culture conditions, the cultures have been known to deteriorate after two months. Thus, to ensure that the test organisms are as healthy as possible, they are used well before two months of the collection date. With water-renewal conditions, it may well be possible to hold *Diporeia spp.* for longer periods. The amphipods can be tested at temperatures as high as 15°C and 20 g sea salt/L with acclimation (see A5.3.5). The water level in the aquaria should be monitored for evaporation. Half the water is removed weekly and a green algae, for example, *Chlamydomonas* or diatom culture is used as supplementary food about 0.1 g algae/14-L aquarium/week. The added food is meant to supplement material in the sediment, not provide a sole source of food. All organisms and sediment should be disposed of at the end of each month, the aquaria cleaned, and fresh organisms added.

A5.3.4 *Diporeia spp.* are hardy organisms but should be handled gently. When transfers must be made, the organisms can be removed on a small piece of 1-mm mesh screen and transferred rapidly to a second container. Transfers have also been made with a 4 to 5-mm diameter fire-polished tube. The organisms must be placed below the surface of the water or they will become trapped in the surface tension. Removing organisms using sieves may form air bubbles on the body surfaces causing the organisms to float on the water surface. Any “floaters” should be gently submerged using a probe. At the time of the transfer process, if organisms continue to float, they should be removed and immediately replaced.

A5.3.5 Because *Diporeia spp.* are tolerant of both a wide range of temperature and salinity, it is possible to perform toxicity tests at other than standard conditions of freshwater and 4°C. Acclimation of *Diporeia spp.* should be at 5 lSp sea salt/day and 2°C/day. The maximum salinity should be 20 lSp seasalt and the maximum temperature 15°C for toxicity testing (344). The organisms should be acclimated first to salinity and then temperature. The organisms should be held 24 h at the test conditions before starting the exposure.

A5.3.6 Records should be kept on the survival of amphipods during holding before starting a test.

A5.3.7 It may be desirable for laboratories to periodically perform 96-h water-only reference-toxicity tests to assess the sensitivity of culture organisms. Data from these reference-toxicity tests could be used to assess genetic strain or life-stage sensitivity to select chemicals. The previous requirement for laboratories to conduct monthly reference-toxicity tests in an earlier version of this standard (Test Method E1706-95b) has not been included as a requirement for testing sediments due to the inability of reference-toxicity tests to identify stressed populations of test organisms (McNulty et al. (105); Section 11.16).

A5.4 *Age*—Tests with *Diporeia spp.* have been started with juvenile organisms. The organisms should be about 10 to 20 mm in length (about 1 to 2-mg dry weight; dry weight(mg)/length =  $0.10 \pm 0.01$  (353), 4 to 8-mg wet weight, dry weight/wet weight =  $0.269 \pm 0.052$  (354). *Diporeia spp.* remain juveniles for most of the year at 30 to 45-m depth and mature late in their life cycle. The females either have a dark spot in the center of their bodies or are carrying eggs, are grayish in color, and their bodies have an extended conformation. The males are very short-lived (about 10 days) after maturation and reside mostly in the water column so are rarely collected with the sediment. Males have extraordinarily long antennae about 1.5 × the body length. All obvious fertile or egg-carrying females and males should not be used for tests. To obtain organisms for testing, the sediment in which they are held can be gently stirred and the organisms collected with a 1-mm mesh screen from the suspended sediment. These organisms are placed in cool (at the test temperature) clean test water and individual organisms can be removed with a small piece of screen to the test chamber (beaker).

A5.5 *Toxicity Test Specifications:*

A5.5.1 See 13.3 for general testing procedures including paragraphs: (1) 13.3.1 (Sediment into Test Chambers), (2) 13.3.2 (Renewal of Overlying Water), (3) 13.3.3 (Acclimation), (4) 13.3.4 (Placing Test Organisms in Test Chambers), (5) 13.3.5 (Monitoring a Test and Measurement of Overlying Water Quality Characteristics), (6) 13.3.6 (Feeding), and (7) 13.3.7 (Ending a Test).

A5.5.2 *Experimental Design*—Decisions concerning the various aspects of experimental design, such as the number of treatments, number of test chambers and test organisms per treatment, and water quality characteristics, should be based on the purpose of the test and the type of procedure that is to be used to calculate results (see Table A5.1 and Section 15). Requirements for test acceptability are summarized in Table A5.2. The tests with *Diporeia spp.* have been conducted at 4 and 10°C (336-338), although temperatures as high as 15°C have been used in water-only studies (344). Performance of the test at 10°C may increase the sensitivity of the organisms based on the greater sensitivity to cadmium in water-only studies at higher temperatures (344). Most of the data for this species has been gathered at 4°C. The beakers are illuminated with a 15-W red darkroom light to encourage burrowing, since these organisms are very light sensitive. Overlying water is not typically renewed during testing. Overlying water can be culture water, well water, surface water, site water, or reconstituted water. For site-specific evaluations, the characteristics of the overlying water should be as similar as possible to the site which sediment is collected.

A5.5.2.1 Gossiaux et al (342) tested three or more replicate 1-L beakers per treatment with 20 *Diporeia spp.* per beaker. Smaller beakers have been used for bioaccumulation studies with no apparent affect on the exposure (see A5.5.2.2). The duration of the test is 28 days with survival as the only end point. Because of their long life span, slow growth, and because their age is not known, growth rate is not an appropriate end point for this species. However, avoidance of the sediment through failure to bury may be a sensitive behavioral end point.

A5.5.2.2 Most of the tests with *Diporeia spp.* have been performed under static conditions. Test sediment (2 cm (about 200 mL)) is placed in the bottom of the beaker and 600 mL of overlying water added. Water-renewal studies have been run for accumulation studies (36) with 250-mL chambers containing 2 to 3 cm of sediment and a flow rate of 100 mL/h. Under the water-renewal conditions the outlet was covered with a fine (1-mm mesh) stainless steel screen to prevent the loss of organisms through the outlet. Only lake water ( $139.3 \pm 1.6$  mg/L hardness as CaCO<sub>3</sub>,  $2.15 \pm 0.1$  meq/L as CaCO<sub>3</sub> alkalinity, and pH 8) and artificial sea water, made with distilled-deionized water, have been used for testing. The ability of *Diporeia spp.* to tolerate softer water is not known at this time. The test chambers used have generally been borosilicate glass beakers or borosilicate glass chambers except for the work with cadmium which used high-density polyethylene beakers. Polyethylene beakers are suggested for use when

metal contamination is considered to be the dominant issue and borosilicate glass containers for all other conditions.

A5.5.2.3 The sediment can be mixed to apparent homogeneity and press sieved through a 1-mm screen to remove large pieces of debris and any macrobenthos. After adding the sediment and water to the test beaker, the beakers are placed in a water bath under temperature control, usually 4°C. The sediment is allowed to settle for 24 h before adding the organisms and the overlying water is gently aerated. If the water can be added without disturbing the fine sediments, the settling time can be avoided. The aeration is about 1 bubble/minute from a disposable pipet placed 2 to 3 cm below the surface of the water. All work including adding the organisms to beakers is generally performed under a light regime with  $\lambda > 500$ -nm wavelength to minimize potential photodegradation, photoactivation, and organism stress. The beakers are continuously illuminated with a 15-W red darkroom light to encourage burrowing, since these organisms are very light sensitive. The water level is maintained by adding distilled-deionized water as needed. The beakers are observed after a few hours and subsequently every 24 h, and the organisms that get stuck in the surface tension at the air-water interface are submerged. The occasional dead *Diporeia spp.* may be replaced within the first 48 h.

A5.5.2.4 *Diporeia spp.* are not fed during testing. These organisms will readily survive without added food in water for more than 60 days (355) and in pure sand for 28 days, the survival is the same as for lake sediment (356).

#### A5.6 Test Data:

A5.6.1 During the conduct of the test the number of organisms swimming above the sediment should be noted daily. This sediment avoidance, if extreme, can easily alter the exposure and response of the organisms and may prove to be a useful behavioral end point. At the end of the test, the sediments are sieved using a 1-mm mesh screen to recover the live organisms. This screening should be performed gently using cool test water to wash the sediment through the screen and the number of live organisms recorded. Organisms that are not recovered are presumed to be dead.

A5.6.2 A consistent amount of time should be taken to examine sieved material for recovery of test organisms (for example, 5 min/replicate). Laboratories should demonstrate their personnel are able to recover an average of at least 90 % of the organisms from whole sediment. For example, test organisms could be added to control or test sediments and recovery could be determined after 1 h (166).

A5.6.3 Average survival of *Diporeia spp.* in the control sediment must be  $\geq 90$  % at the end of the test. Survival in individual replicates in the control sediment must be  $\geq 80$  %. Materials that have been used as control sediments and the respective survival are  $94 \pm 6.7$  % for florissant soil or  $97 \pm 5.1$  % for 45-m Lake Michigan sediment (342, 344) or  $94 \pm 3$  % for combusted quartz sand (356). See Table A5.2 for additional test acceptability requirements.



## **A6. GUIDANCE FOR CONDUCTING A *HYALELLA AZTECA* 42-DAY TEST FOR MEASURING EFFECTS OF SEDIMENT-ASSOCIATED CONTAMINANTS ON SURVIVAL, GROWTH, AND REPRODUCTION**

### *A6.1 Significance*

A6.1.1 *Hyalella azteca* are routinely used to assess the toxicity of chemicals in sediments (Section 13; Nebeker et al., (200), Dillon and Gibson, (357); Burton et al., (202); Burton et al., (150); Ingersoll and Nelson (130); Borgmann and Munawar, (201); Ankley et al., (58); Winger and Lazier, (149); Suedel and Rodgers, (60); Day et al., (358) Kubitz et al., (359)). Test duration and endpoints recommended in previously developed standard methods for sediment testing with *H. azteca* include 10-day survival (Section 13; USEPA, (2)) and 10- to 28-day survival and growth (Section 13; Environment Canada, (69) ), Short-term exposures which only measure effects on survival can be used to identify high levels of contamination, but may not be able to identify moderately contaminated sediments. The method described in this annex can be used to evaluate potential effects of contaminated sediment on survival, growth, and reproduction of *H. azteca* in a 42-day test.

A6.1.2 Section A6.2 describes general guidance for conducting a 42-day test with *H. azteca* that can be used to evaluate effects of contaminants associated with sediments on survival, growth, or reproduction. Refinement of these methods may be described in future versions of this standard after additional laboratories have successfully used the method (Section 17.6 USEPA (2)). The methods for conducting long-term tests with sediments are more specialized and labor-intensive compared to the short-term tests. The 42-day test with *H. azteca* has not been adequately evaluated in water with elevated salinity (Section 1.1.1).

A6.1.3 The procedure outlined in Section A6.2 is based on procedures described in Ingersoll et al. (85). The sediment exposure starts with 7- to 8-day-old amphipods. On Day 28, amphipods are isolated from the sediment and placed in water-only chambers where reproduction is measured on Day 35 and 42. Typically, amphipods are first in amplexus at about Day 21 to 28 with release of the first brood between Day 28 to 42. Endpoints measured include survival (Day 28, 35 and 42), growth (as length or dry weight measured on Day 28 and 42), and reproduction (number of young/female produced from Day 28 to 42). The procedures described in Section A6.2 include measurement of a variety of lethal and sublethal endpoints; minor modifications of the basic methods can be used in cases where only a subset of these endpoints is of interest.

A6.1.3.1 Several designs were considered for measuring reproduction in sediment exposures based on the reproductive biology of *H. azteca* (Ingersoll et al., (56)). The first design considered was a continuation of the 28-day sediment exposures described in Ingersoll et al. (85), for an additional two weeks to determine the number of young produced in the first brood. The limitation of this design is the difficulty in quantitatively isolating young amphipods from sediment. (Tomasovic et al. (360)). A second design considered was extension of the 28-day sediment exposure for an additional month or longer until several broods are released. These multiple broods could

then be isolated from the sediment. The limitation of this second design is that specific effects on reproduction could not be differentiated from reduced survival of offspring and it would still be difficult to isolate young amphipods from sediment. A third design considered, and the one described in this annex, was to expose amphipods in sediment until a few days before the release of the first brood. The amphipods could then be sieved from the sediment and held in water to determine the number of young produced (Ingersoll et al. (56)). This test design allows a quantitative measure of reproduction. One limitation to this design is that amphipods might recover from effects of sediment exposure during this holding period in clean water (Landrum and Scavia, (361); Kane Driscoll et al., (362)); however, amphipods are exposed to sediment during critical developmental stages before release of the first brood in clean water.

A6.1.4 The method has been used to evaluate a formulated sediment and field-collected sediments with low to moderate concentrations of contaminants (Ingersoll et al. (56)). Survival of amphipods in these sediments was typically >85 % after the 28-day sediment exposures and the 14-day holding period in water to measure reproduction (Ingersoll et al. (56)). The method outlined in A6.2 has also been evaluated in round-robin testing (USEPA (2), Section 17.6). After the 28-day sediment exposures in a control sediment (West Bearskin), survival was >80 % for >88 % of the laboratories; length was >3.2 mm/individual for >71 % of the laboratories; and dry weight was >0.15 mg/individual for 66 % of the laboratories. Reproduction from Day 28 to Day 42 was >2 young/female for >71 % of the laboratories participating in the round-robin testing. Reproduction was more variable within and among laboratories; hence, more replicates might be needed to establish statistical differences among treatments with this endpoint (USEPA (2)).

A6.1.5 Growth of *H. azteca* in sediment tests often provides unique information that can be used to discriminate toxic effects of exposure to contaminants (Brasher and Ogle, (363); Borgmann, (364); Kemble et al., (18); Ingersoll et al., (85); Kubitz et al., (365) Milani et al., (366); Steevens and Benson) (367)). Either length or weight can be measured in sediment tests with *H. azteca*. However, additional statistical options are available if length is measured on individual amphipods, such as nested analysis of variance which can account for variance in length between replicates (Steevens and Benson, (367)). Ongoing water-only studies testing select contaminants will provide additional data on the relative sensitivity and variability of sublethal endpoints in toxicity tests with *H. azteca* (Ingersoll et al. (56)).

A6.1.6 Results of tests using procedures different from the procedures described in Section A6.2 may not be comparable, and these different procedures may alter contaminant bioavailability. Comparisons of results obtained using modified versions of these procedures might provide useful information

concerning new concepts and procedures for conducting sediment tests with aquatic organisms. If tests are conducted with procedures different from the procedures described in this standard, additional tests are required to determine comparability of results (Section 1.5).

*A6.2 Procedure for Conducting a Hyalella azteca 42-day Test for Measuring Effects of Sediment-associated Contaminants on Survival, Growth, and Reproduction*

A6.2.1 Conditions for evaluating sublethal endpoints in a sediment toxicity test with *H. azteca* are summarized in Table A6.1. A general activity schedule is outlined in Table A6.2. Decisions concerning the various aspects of experimental design, such as the number of treatments, number of test chambers/treatment, and water-quality characteristics should be based on the purpose of the test and the methods of data

**TABLE A6.1 Test Conditions for Conducting a 42-day Sediment Toxicity Test with *Hyalella azteca***

Parameter	Conditions
1. Test type	Whole-sediment toxicity test with renewal of overlying water
2. Temperature	23 ± 1°C
3. Light quality	Wide-spectrum fluorescent lights
4. Illuminance	About 100 to 1000 lux
5. Photoperiod	16L:8D
6. Test chamber	300-mL high-form lipless beaker
7. Sediment volume	100 mL
8. Overlying water volume	175 mL in the sediment exposure from Day 0 to Day 28 (175 to 275 mL in the water-only exposure from Day 28 to Day 42)
9. Renewal of overlying water	2 volume additions/d; continuous or intermittent (e.g., one volume addition every 12 h)
10. Age of organisms	7- to 8-d old at the start of the test
11. Number of organisms/chamber	10
12. Number of replicate chambers/treatment	12 (4 for 28-day survival and growth and 8 for 35- and 42-day survival, growth, and reproduction). Reproduction is more variable than growth or survival; hence, more replicates might be needed to establish statistical differences among treatments (See Section A6.2.3).
13. Feeding	YCT food, fed 1.0 mL (1800 mg/L stock) daily to each test chamber
14. Aeration	None, unless dissolved oxygen in overlying water drops below 2.5 mg/L.
15. Overlying water	Culture water, well water, surface water or site water. Use of reconstituted water is not recommended.
16. Test chamber cleaning	If screens become clogged during a test; gently brush the outside of the screen
17. Overlying water quality	Hardness, alkalinity, conductivity, and ammonia at the beginning and end of a sediment exposure (Day 0 and 28). Temperature daily. Conductivity weekly. Dissolved oxygen (DO) and pH three times/week. Concentrations of DO should be measured more often if DO drops more than 1 mg/L since the previous measurement.
18. Test duration	42 days
19. Endpoints	28-day survival and growth; 35- and 42-day survival, growth, reproduction, and number of adult males and females on Day 42.
20. Test acceptability	Minimum mean control survival of 80% on Day 28. Additional performance-based criteria specifications are outlined in Table A6.3 and in round-robin testing (Sections A6.1.4 and 17.6).

**TABLE A6.2 General Activity Schedule for Conducting a 42-day Sediment Toxicity Test with *Hyalella azteca***

Day	Activity
Pre-Test	
-8	Separate known-age amphipods from the cultures and place in holding chambers. Begin preparing food for the test. The <24-h amphipods are fed 10 mL of YCT (1800 mg/L stock solution) and 10 mL of <i>Selenastrum capricornutum</i> (about 3.0 x 10 <sup>7</sup> cells/mL) on the first day of isolation and 5 mL of both YCT and <i>S. capricornutum</i> on the 3rd and 5th d after isolation.
-7	Remove adults and isolate <24-h old amphipods (if procedures outlined in section 12.3.4 are followed).
-6 to -2	Feed and observe isolated amphipods, monitor water quality (e.g., temperature and dissolved oxygen).
-1	Feed and observe isolated amphipods, monitor water quality. Add sediment into each test chamber, place chambers into exposure system, and start renewing overlying water.
Sediment Test	
0	Measure total water quality (pH, temperature, dissolved oxygen, hardness, alkalinity, conductivity, ammonia). Transfer ten 7- to 8-day old amphipods into each test chamber. Release organisms under the surface of the water. Add 1.0 mL of YCT (1800 mg/L stock) into each test chamber. Archive 20 test organisms for length determination or archive 80 amphipods for dry weight determination. Observe behavior of test organisms.
1 to 27	Add 1.0 mL of YCT to each test beaker. Measure temperature daily, conductivity weekly, and dissolved oxygen (DO) and pH three times/week. Observe behavior of test organisms.
28	Measure temperature, dissolved oxygen, pH, hardness, alkalinity, conductivity and ammonia. End the sediment-exposure portion of the test by collecting the amphipods with a #40 mesh sieve (425-µm mesh; U.S. standard size sieve). Use four replicates for growth measurements: count survivors and preserve organisms in sugar formalin for growth measurements. Eight replicates for reproduction measurements: Place survivors in individual replicate water-only beakers and add 1.0 mL of YCT to each test beaker/d and 2 volume additions/d of overlying water.
Reproduction Phase	
29 to 35	Feed daily. Measure temperature daily, conductivity weekly, DO and pH three times a week. Measure hardness and alkalinity weekly. Observe behavior of test organisms.
35	Record the number of surviving adults and remove offspring. Return adults to their original individual beakers and add food.
36 to 41	Feed daily. Measure temperature daily, conductivity weekly, DO and pH three times a week. Measure hardness and alkalinity weekly. Observe behavior of test organisms.
41	Measure total water quality (pH, temperature, dissolved oxygen, hardness, alkalinity, conductivity, ammonia).
42	Record the number of surviving adults and offspring. Surviving adult amphipods on Day 42 are preserved in sugar formalin solution. The number of adult males in each beaker is determined from this archived sample. This information is used to calculate the number of young produced per female per replicate from Day 28 to Day 42.

analysis (Section 15). When variability remains constant, the sensitivity of a test increases as the number of replicates increase.

A6.2.2 The 42-day sediment toxicity test with *H. azteca* is conducted at 23°C with a 16L:8D photoperiod at an illuminance of about 100 to 1000 lux (Table A6.1). Test chambers are 300-mL high-form lipless beakers containing 100 mL of sediment and 175 mL of overlying water. Amphipods in each test chamber are fed 1.0 mL of YCT daily (Annex A8). Each

test chamber receives 2 volume additions/day of overlying water. Water renewals may be manual or automated. Zumwalt et al. (128), Benoit et al., (127) and USEPA (2) describe water-renewal systems that can be used to deliver overlying water. Overlying water should be a source of water that has been demonstrated to support survival, growth, and reproduction of *H. azteca* in culture. McNulty et al. (368) and Kemble et al. (61) observed poor survival of *H. azteca* in tests conducted 14 to 28 day using a variety of reconstituted waters including reconstituted water (reformulated moderately hard reconstituted water) described in Smith et al. (112) and described in an earlier version of this test method (Test Method E1706-95b). Borgmann (369) described a reconstituted water that was used successfully to maintain *H. azteca* in culture; however, some laboratories have not had success when using this reconstituted water in the 42-day test (T.J. Norberg-King, USEPA, Duluth, MN, personal communication). For site-specific evaluations, the characteristics of the overlying water should be as similar as possible to the site where sediment is collected. Requirements for test acceptability are summarized in Table A6.3.

A6.2.3 The number of replicates and concentrations tested depends in part on the significance level selected and the type of statistical analysis. A total of 12 replicates, each containing ten 7- to 8-day-old amphipods are tested for each treatment. Starting the test with substantially younger or older organisms may compromise the reproductive endpoint. For the total of 12 replicates the assignment of beakers is as follows: 12 replicates are set up on Day -1 of which 4 replicates are used for 28-day growth and survival endpoints and the other 8 replicates are used for measurement of survival and reproduction on Day 35, and measurement of survival, reproduction, or growth on Day 42.

### A6.3 General Procedures

A6.3.1 Placement of Sediment into Test Chambers: The day before the sediment test is started (Day -1) each sediment should be thoroughly homogenized and added to the test chambers (Section 10.3.1). Sediment should be visually inspected to judge the degree of homogeneity. Excess water on the surface of the sediment can indicate separation of solid and liquid components. If a quantitative measure of homogeneity is required, replicate subsamples should be taken from the sediment batch and analyzed for TOC, chemical concentrations, and particle size.

A6.3.1.1 Each test chamber should contain the same amount of sediment, determined either by volume or by weight. Overlying water is added to the chambers on Day -1 in a manner that minimizes suspension of sediment. This can be accomplished by gently pouring water along the sides of the chambers or by pouring water onto a baffle (e.g., a circular piece of Teflon with a handle attached) placed above the sediment to dissipate the force of the water. Renewal of overlying water is started on Day -1. A test begins when the organisms are added to the test chambers (Day 0).

A6.3.2 Renewal of Overlying Water: Renewal of overlying water is required during a test. At any particular time during a test, flow rates through any two test chambers should not differ

**TABLE A6.3 Test Acceptability Requirements for a 42-day Sediment Toxicity Test with *Hyalella azteca***

- 
- A. It is recommended for conducting the 42-day test with *H. azteca* that the following performance criteria be met:
1. Age of *H. azteca* at the start of the test should be 7- to 8-day old. Starting a test with substantially younger or older organisms may compromise the reproductive endpoint.
  2. Average survival of *H. azteca* in the control sediment on Day 28 should be greater than or equal to 80%.
  3. Laboratories participating in round-robin testing (section 17.6) reported after 28-day sediment exposures in a control sediment (West Bearskin), survival >80% for >88% of the laboratories; length >3.2 mm/individual for >71% of the laboratories; and dry weight >0.15 mg/individual for 66% of the laboratories. Reproduction from Day 28 to Day 42 was >2 young/female for 71% of the laboratories participating in the round-robin testing. Reproduction was more variable within and among laboratories; hence, more replicates might be needed to establish statistical differences among treatments with this endpoint.
  4. Hardness, alkalinity, and ammonia in the overlying water typically should not vary by more than 50% during the sediment exposure, and dissolved oxygen should be maintained above 2.5 mg/L in the overlying water.
- B. Performance-based criteria for culturing *H. azteca* include the following:
1. It may be desirable for laboratories to periodically perform 96-h water-only reference-toxicity tests to assess the sensitivity of culture organisms (section 11.16.2). Data from these reference toxicity tests could be used to assess genetic strain or life-stage sensitivity of test organisms to select chemicals.
  2. Laboratories should track parental survival in the cultures and record this information using control charts if known-age cultures are maintained. Records should also be kept on the frequency of restarting cultures and the age of brood organisms.
  3. Laboratories should record the following water-quality characteristics of the cultures at least quarterly: pH, hardness, alkalinity, and ammonia. Dissolved oxygen in the cultures should be measured weekly. Temperature in the cultures should be recorded daily. If static cultures are used, it may be desirable to measure water quality more frequently.
  4. Laboratories should characterize and monitor background contamination and nutrient quality of food if problems are observed in culturing or testing organisms.
  5. Physiological measurements such as lipid content might provide useful information regarding the health of the cultures.
- C. Additional requirements:
1. All organisms in a test must be from the same source.
  2. Storage of sediments collected from the field should follow guidance outlined in 10.2.
  3. All test chambers (and compartments) should be identical and should contain the same amount of sediment and overlying water.
  4. Negative-control sediment and appropriate solvent controls must be included in a test. The concentration of solvent used must not adversely affect test organisms.
  5. Test organisms must be cultured and tested at 23°C ( $\pm 1$  °C).
  6. The mean of the daily test temperature must be within  $\pm 1$ °C of 23°C. The instantaneous temperature must always be within  $\pm 3$ °C of 23°C.
  7. Natural physico-chemical characteristics of test sediment collected from the field should be within the tolerance limits of the test organisms.
- 

by more than 10 %. Hardness, alkalinity and ammonia concentrations in the water above the sediment, within a treatment, typically should not vary by more than 50 % during the test. Mount and Brungs (129) diluters have been modified for sediment testing, and other automated water delivery systems have also been used (Maki, (131); Ingersoll and Nelson, (130) ; Benoit et al.,(127) Zumwalt et al., (128) ; Brunson et al., (370); Leppanen and Maier (204) ; Wall et al.) (371). The water-delivery system should be calibrated before a test is started to verify that the system is functioning properly. Renewal of overlying water is started on Day -1 before the addition of test organisms or food on Day 0. Zumwalt et al. (128), Benoit et al., (127) and USEPA (2) describe water-renewal systems that can be used for conducting sediment tests.

A6.3.2.1 In water-renewal tests with one to four volume additions of overlying water/day, water-quality characteristics generally remain similar to the inflowing water (Ingersoll and Nelson (130); Ankley et al. (5)); however, in static tests, water quality may change profoundly during the exposure (Shuba et al. (142)). For example, in static whole-sediment tests, the alkalinity, hardness, and conductivity of overlying water more than doubled in several treatments during a four-week exposure (Ingersoll and Nelson, (130)). Additionally, concentrations of metabolic products (e.g., ammonia) may also increase during static exposures, and these compounds can either be directly toxic to the test organisms or may contribute to the toxicity of the contaminants in the sediment. Furthermore, changes in water-quality characteristics such as hardness may influence the toxicity of many inorganic (Gauss et al. (206)) and organic (Mayer and Ellersieck (207)) contaminants. Although contaminant concentrations are reduced in the overlying water in water-renewal tests, organisms in direct contact with sediment generally receive a substantial proportion of a contaminant dose directly from either the whole sediment or from the pore water.

A6.3.3 Acclimation: Test organisms must be cultured and tested at the same temperature. Ideally, test organisms should be cultured in the same water that will be used in testing. However, acclimation of test organisms to the test water is not required. If test organisms are to be acclimated, they could be held for 2 h in a 50 to 50 mixture of culture water to overlying water, then for 2 h in a 25 to 75 mixture of culture water to overlying water, followed by a transfer into 100 % overlying water for 2 h (130).

A6.3.4 Placing Test Organisms in Test Chambers: Test organisms should be handled as little as possible. Amphipods should be introduced into the overlying water below the air-water interface. Test organisms can be pipetted directly into overlying water. Length should be measured on a subset of at least 20 organisms or weight should be measured on a subset of at least 80 organisms used to start the test. This information can be used to determine consistency in the size of the organisms used to start a test.

A6.3.5 Feeding: For each beaker, 1.0 mL of YCT is added from Day 0 to Day 42. Without addition of food, the test organisms may starve during exposures. However, the addition of the food may alter the availability of the contaminants in the sediment (Wiederholm et al. (106) Harkey et al.(35)). Furthermore, if too much food is added to the test chamber, or if the mortality of test organisms is high, fungal or bacterial growth may develop on the sediment surface. Therefore, the amount of food added to the test chambers is kept to a minimum.

A6.3.5.1 Suspensions of food should be thoroughly mixed before aliquots are taken. If excess food collects on the sediment, a fungal or bacterial growth may develop on the sediment surface, in which case feeding should be suspended for one or more days. A drop in dissolved oxygen below 2.5 mg/L during a test may indicate that the food added is not being consumed. Feeding should be suspended for the amount of time necessary to increase the dissolved oxygen concentration. If feeding is suspended in one treatment, it should be

suspended in all treatments. Detailed records of feeding rates and the appearance of the sediment surface should be made daily.

A6.3.6 Monitoring a Test: All chambers should be checked daily and observations made to assess test organism behavior such as sediment avoidance. However, monitoring effects on burrowing activity of test organisms may be difficult because the test organisms are often not visible during the exposure. The operation of the exposure system should be monitored daily.

A6.3.6.1 Measurement of Overlying Water-quality characteristics—Conductivity, hardness, pH, alkalinity, dissolved oxygen, and ammonia should be measured in all treatments at the beginning and at the end of the sediment exposure portion of the test. Water quality characteristics should also be measured at the beginning and end of the reproductive phase (Day 29 to Day 42). Conductivity should be measured weekly and DO and pH three times/week. Overlying water should be sampled just before water renewal from about 1 to 2 cm above the sediment surface using a pipet. It may be necessary to composite water samples from individual replicates. The pipet should be checked to make sure no organisms are removed during sampling of overlying water. Water quality should be measured for each new batch of water prepared for the test.

A6.3.6.1.1 Dissolved oxygen should be measured three times/week and should be maintained at a minimum of 2.5 mg/L. If a probe is used to measure dissolved oxygen in overlying water, it should be thoroughly inspected between samples to make sure that organisms are not attached and should be rinsed between samples to minimize cross contamination. Aeration can be used to maintain dissolved oxygen in the overlying water above 2.5 mg/L (i.e., about 1 bubble/second in the overlying water). Dissolved oxygen and pH can be measured directly in the overlying water with a probe.

A6.3.6.1.2 Temperature should be measured at least daily in at least one test chamber from each treatment. The temperature of the water bath or the exposure chamber should be continuously monitored. The daily mean test temperature must be within  $\pm 1^{\circ}\text{C}$  of  $23^{\circ}\text{C}$ . The instantaneous temperature must always be within  $\pm 3^{\circ}\text{C}$  of  $23^{\circ}\text{C}$ .

A6.3.7 Ending a Test: Endpoints monitored include 28-day survival and growth of amphipods and 35-day and 42-day survival, growth, and reproduction (number of young/female) of amphipods. Growth or reproduction of amphipods may be a more sensitive toxicity endpoint compared to survival (Burton and Ingersoll, (14); Kemble et al. (18); Ingersoll et al. (56)).

A6.3.7.1 On Day 28, 4 of the replicate beakers/sediment are sieved with a #40 mesh sieve (425- $\mu\text{m}$  mesh; U.S. standard size sieve) to remove surviving amphipods for growth determinations. Any of the surviving amphipods in the water column or on the surface of the sediment can be pipetted from the beaker before sieving the sediment. The sediment in each beaker should be sieved in two separate aliquots (i.e., most of the amphipods will probably be found in the surface aliquot). Immobile organisms isolated from the sediment surface or from sieved material should be considered dead. Surviving amphipods from these 4 replicates can be preserved in separate

vials containing 8 % sugar formalin solution if length is to be measured (Ingersoll and Nelson, (130)). The sugar formalin solution is prepared by adding 120 g of sucrose to 80 mL of formalin which is then brought to a volume of 1 L using deionized water. This stock solution is mixed with an equal volume of deionized water when used to preserve organisms. NoTox (Earth Safe Industries, Belle Mead, NJ) can be used as a substitute for formalin (Unger et al. (208)).

A6.3.7.2 A consistent amount of time should be taken to examine sieved material for recovery of test organisms (e.g., 5 min/replicate). Laboratories should demonstrate that their personnel are able to recover an average of at least 90 % of the organisms from whole sediment. For example, test organisms could be added to control or test sediments, and recovery could be determined after 1 h (Tomasovic et al. (372)).

A6.3.7.3 Growth of amphipods can be reported as either length or weight; however, additional statistical options are available if length is measured on individual organisms (Section A6.4.5.6).

A6.3.7.4 Amphipod body length ( $\pm 0.1$  mm) can be measured from the base of the first antenna to the tip of the third uropod along the curve of the dorsal face (Fig. 7). Kemble et al. (18) describe the use of a digitizing system and microscope to measure lengths of *H. azteca*. Kemble et al. (18) also photographed invertebrates (at magnification of 3.5 $\times$ ) and measured length using a computer-interfaced digitizing tablet.

A6.3.7.5 Dry weight of amphipods in each replicate can be determined on Day 28 and 42. If both weight and length are to be determined, weight should be measured after length on the preserved samples. Gaston et al. (373) and Duke et al. (374) have shown that biomass or length of several aquatic invertebrates did not significantly change after two to four weeks of storage in 10 % formalin. If test organisms are to be used for an evaluation of bioaccumulation, it is not advisable to dry the sample before conducting the residue analysis. If conversion from wet weight to dry weight is necessary, aliquots of organisms can be weighed to establish wet to dry weight conversion factors. A consistent procedure should be used to remove the excess water from the organisms before measuring wet weight.

A6.3.7.6 Dry weight of amphipods can be determined by: (1) transferring the archived amphipods from a replicate out of the sugar formalin solution into a crystallizing dish; (2) rinsing amphipods with deionized water; (3) transferring these rinsed amphipods to a pre-weighed aluminum pan; (4) drying these samples for 24 h at 60°C; and (5) weighing the pan and dried amphipods on a balance to the nearest 0.01 mg. Average dry weight of individual amphipods in each replicate is calculated from these data. Due to the small size of the amphipods, caution should be taken during weighing (10 dried amphipods after a 28-day sediment exposure may weigh less than 2.5 to 2.5 mg). Weigh pans need to be carefully handled using powder-less gloves and the balance should be calibrated with standard weights with each use. Use of small aluminum pans (e.g., 7  $\times$  22  $\times$  7 mm. Sigma Chemical Company, St. Louis, MO) will help reduce variability in measurements of dry weight. Weigh boats can also be constructed from sheets of aluminum foil.

A6.3.7.7 The previous version of the standard recommended dry weight as a measure of growth for both *H. azteca* and *C. dilutus*. For *C. dilutus*, this recommendation was changed in the current version to ash-free dry weight (AFDW) instead of dry weight, with the intent of reducing bias introduced by gut contents (Sibley et al. (55)). However, this recommendation was not extended to include *H. azteca*. Studies by Dawson et al. (personal communication, T.D. Dawson, Integrated Laboratory Systems, Duluth, MN) have indicated that the ash content of *H. azteca* is not greatly decreased by purging organisms in clean water before weighing, suggesting that sediment does not comprise a large portion of the overall dry weight. In addition, using AFDW further decreases an already small mass, potentially increasing measurement error. For this reason, dry weight continues to be the recommended endpoint for estimating growth of *H. azteca* via weight (growth can also be determined via length).

A6.3.7.8 On Day 28, the remaining 8 beakers/sediment are also sieved and the surviving amphipods in each sediment beaker are placed in 300-mL water-only beakers containing 150 to 275 mL of overlying water and a 5 cm  $\times$  5 cm piece of Nitex screen (Nylon Bolting cloth; 44 % open area and 280- $\mu$ m aperture, Wildlife Supply Company, Saginaw, MI; Ingersoll et al. (56)). In a subsequent study, improved reproduction of *H. azteca* was observed when the Nitex screen was replaced with a 3 cm  $\times$  3 cm piece of the nylon “Coiled-web material” described in Section 12.3.4 for use in culturing amphipods (T.J. Norberg-King, USEPA, personal communication). Each water-only beaker receives 1.0 mL of YCT stock solution and about two volume additions of water daily.

A6.3.7.9 Reproduction of amphipods is measured on Day 35 and Day 42 in the water-only beakers by removing and counting the adults and young in each beaker. On Day 35, the adults are then returned to the same water-only beakers. Adult amphipods surviving on Day 42 are preserved in sugar formalin. The number of adult females is determined by simply counting the adult males (mature male amphipods will have an enlarged second gnathopod) and assuming all other adults are females. The number of females is used to determine number of young/female/beaker from Day 28 to Day 42. Growth can also be measured for these adult amphipods.

#### A6.4 Interpretation of Results

A6.4.1 *Data Analysis*: Endpoints measured in the 42-day *H. azteca* test include survival (Day 28, 35, and 42), growth (as length or dry weight on Day 28 and 42), and reproduction (number of young/female produced from Day 28 to 42). Section 15 describes general information regarding statistical analysis of these data including both point estimates (i.e., LC50s) and hypothesis testing (i.e. ANOVA). The following sections describe species-specific information that is useful in helping to interpret the results of 42-day sediment toxicity tests with *H. azteca*.

A6.4.2 *Age Sensitivity*: The sensitivity of *H. azteca* appears to be relatively similar up to at least 24- to 26-day old organisms (Collyard et al. (210)). For example, the toxicity of diazinon, Cu, Cd, and Zn was similar in 96-h water-only

exposures starting with 0- to 2-day old organisms through 24- to 26-day old organisms (Fig. 6). The toxicity of alkylphenol ethoxylate (a surfactant) tended to increase with age. In general, this suggests that tests started with 7-day to 8-day old amphipods would be representative of the sensitivity of *H. azteca* up to at least the adult life stage.

**A6.4.3 Grain Size:** *Hyalella azteca* tolerate a wide range in sediment grain size and organic matter in 10- to 28-day tests measuring effects on survival or growth (Ankley et al., (58); Suedel and Rodgers, (60); Ingersoll et al., (85); Kemble et al. (61)). Using the method outlined in Section A6.2, no significant correlations were observed between the survival, growth, or reproduction of *H. azteca* and the physical characteristics of the sediment (grain size ranging from predominantly silt to predominantly sand), TOC (ranging from 0.3 to 9.6 %), water content (ranging from 19 to 81 %; Ingersoll et al.) (56). Additionally, no significant correlations were observed between these biological endpoints and the water quality characteristics (i.e., hardness, alkalinity, ammonia) of pore water or overlying water in the sediments evaluated by Ingersoll et al. (56). Weak trends were observed between reproduction of amphipods and percent clay, percent silt, and percent sand. Additional study is needed to better evaluate potential relationships between reproduction of *H. azteca* and these physical characteristics of the sediment. The weak relationship between the sediment grain size and reproduction may have been due to the fact that samples with higher amounts of sand also had higher concentrations of organic contaminants compared to other samples described in Ingersoll et al. (56).

**A6.4.3.1** Until additional studies have been conducted which substantiate this lack of a correlation between physical characteristics of sediment and the reproductive endpoints measured in the long-term sediment test with *H. azteca*, it would be desirable to test control or reference sediments which are representative of the physical characteristics of field-collected sediments. Formulated sediments could be used to bracket the ranges in physical characteristics expected in the field-collected sediments being evaluated (Section 7.2). Addition of YCT should provide a minimum amount of food needed to support adequate survival, growth, and reproduction of *H. azteca* in sediments low in organic matter. Without addition of food, *H. azteca* can starve during exposures (McNulty et al. (105)) making it impossible to differentiate effects of contaminants from other sediment characteristics.

**A6.4.4 Influence of Indigenous Organisms:** Survival of *H. azteca* in 28-day tests was not reduced in the presence of oligochaetes in sediment samples (Reynoldson et al. (102)). However, growth of amphipods was reduced when high numbers of oligochaetes were placed in a sample. Therefore, it is important to determine the number and biomass of indigenous organisms in field-collected sediments in order to better interpret growth data (Reynoldson et al.(102), DeFoe and Ankley (140)). Furthermore, presence of predators may also influence response of test organisms in sediment (Ingersoll and Nelson (130)).

**A6.4.5 Relationships between Growth and Reproductive Endpoints:** Natural or anthropogenic stressors that affect growth of invertebrates may also affect reproduction, because

of a minimum size needed for reproduction (Rees and Crawley, (49); Ernsting et al., (375); Moore and Dillon, (376); Enserink et al. (377); Moore and Farrar, (137); Sibley et al. (54), (55) ). Ingersoll et al. (56) reported a significant correlation between reproduction from Day 28 to 42 and length of *H. azteca* on Day 28 when data are plotted by the mean of each treatment (Fig. A6.1a; Spearman rank correlation of 0.59,  $p=0.0001$ ). Based on 28-day lengths, smaller amphipods (<3.5 mm) tended to have lower reproduction and larger amphipods (>4.3 mm) tended to have higher reproduction; however, the range in reproduction was wide for amphipods 3.5 to 4.3 mm in length. Based on 42-day lengths, there was a weaker correlation between length and reproduction (i.e., reproduction and length measured in paired replicates; Fig. A6.1b, Spearman rank correlation of 0.49,  $p=0.0001$ ). Similarly, plotting data by individual replicates (data, not shown) did not improve the relationship between 42-day length and reproduction compared to the plots by the mean of each treatment (Fig. A6.1b; Ingersoll et al., (56)).

**A6.4.5.1** Weaker relationships were observed between reproduction and dry weight measured on Day 28 (Fig. A6.2a, Spearman rank correlation of 0.44,  $p = 0.0037$ ,  $n = 42$ ) or dry weight measured on Day 42 (Fig. A6.2b, Spearman rank correlation 0.34,  $p = 0.0262$ ,  $n = 42$ ). Round-robin studies (Section 17.6 and USEPA (2)) have generated additional data that will be used to further evaluate relationships between growth and reproduction of *H. azteca* in sediment tests using the procedures outlined in Section A6.2.

**A6.4.5.2** A significant correlation was evident between length and dry weight of amphipods (Fig. A6.3, Spearman rank of 0.80,  $p=0.0001$ ) indicating that either length or weight could be measured in sediment tests with *H. azteca*. However, additional statistical options are available if length is measured on individual amphipods, such as nested ANOVA which can account for variance in length within replicates (Steevens and Benson, (209)). Analyses are ongoing to evaluate the ability of length vs. weight to discriminate between contaminated and uncontaminated samples in a database described in Ingersoll et al. (85).

**A6.4.5.3** The relatively variable relationship between growth and reproduction probably reflects the fact that most of these comparisons were made within a fairly narrow range in length (3.5 to 5.0 mm; Fig. A6.1) or dry weight (0.25 to 0.50 mg; Fig. A6.2). Other investigators have reported a similar degree of variation in reproduction of *H. azteca* within a narrow range of length or weight, with stronger correlations observed over wider ranges (Hargrave, (378); Strong, (379); Wen (380) ; Moore and Farrar, (137)). The degree of correlation between growth and reproduction may also be dependent on the genetic strain of *H. azteca* evaluated (Strong, (379), France, (381)).

**A6.4.5.4** The proportion of males to females within a treatment or by replicate was not correlated to young production, but may have contributed to a variation in reproduction (Ingersoll et al. (56)), Wen (380) reported that when two or three males were placed in a beaker with one female *H. azteca*, the frequency of successful amplexus was reduced, possibly from aggression between the males. Future study is

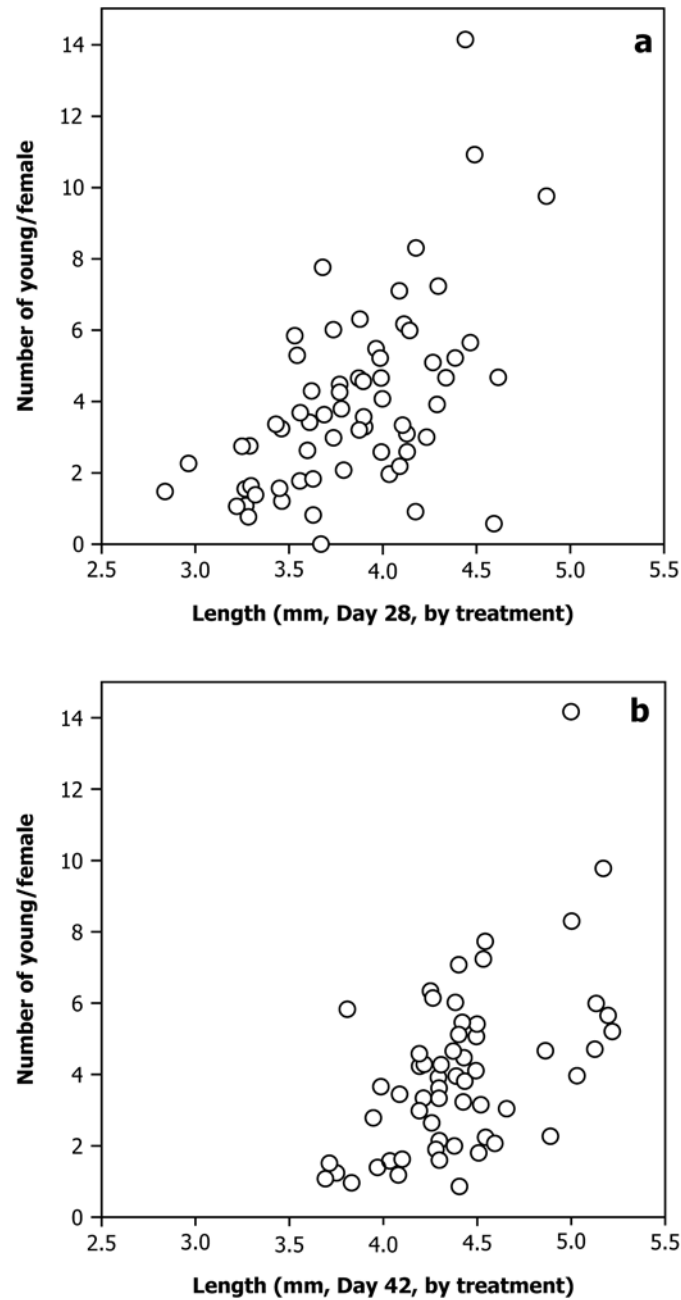

FIG. A6.1 Relationships between *Hyalella azteca* length and reproduction by (a) treatment means for 28 day length or (b) treatment means for 42-day length.

needed to determine if increasing the number of amphipods/beaker would result in a more consistent proportion of males to females within a beaker and would reduce variability in reproduction.

A6.4.5.5 Reproduction was often more variable than growth (Ingersoll et al., (56)). The coefficient of variation (CV) was typically <10 % for growth and >20 % for reproduction. This difference in variation affects the statistical power of the comparisons and the number of replicates required a test. For example, detection of a 20 % difference between treatment means at a statistical power of 0.8 would require about 4 replicates at a CV of 10 % and 14 replicates at a CV of 20 %

(Fig. 12). Fewer replicates would be required if detection of larger differences among treatment means were of interest. Ongoing water-only studies testing select contaminants will hopefully provide additional data on the relative sensitivity and variability of sublethal endpoints in toxicity tests with *H. azteca* (Ingersoll et al. (56)).

A6.4.5.6 The 8-replicate design recommended in this standard (Table A6.1) is a compromise between logistical constraints and statistical considerations. Laboratories experienced with this method have shown CVs of 25 to 50 % (Ingersoll et al. (56)), though some higher values were observed during the round robin testing (Section 17.6 and USEPA (2)), in which

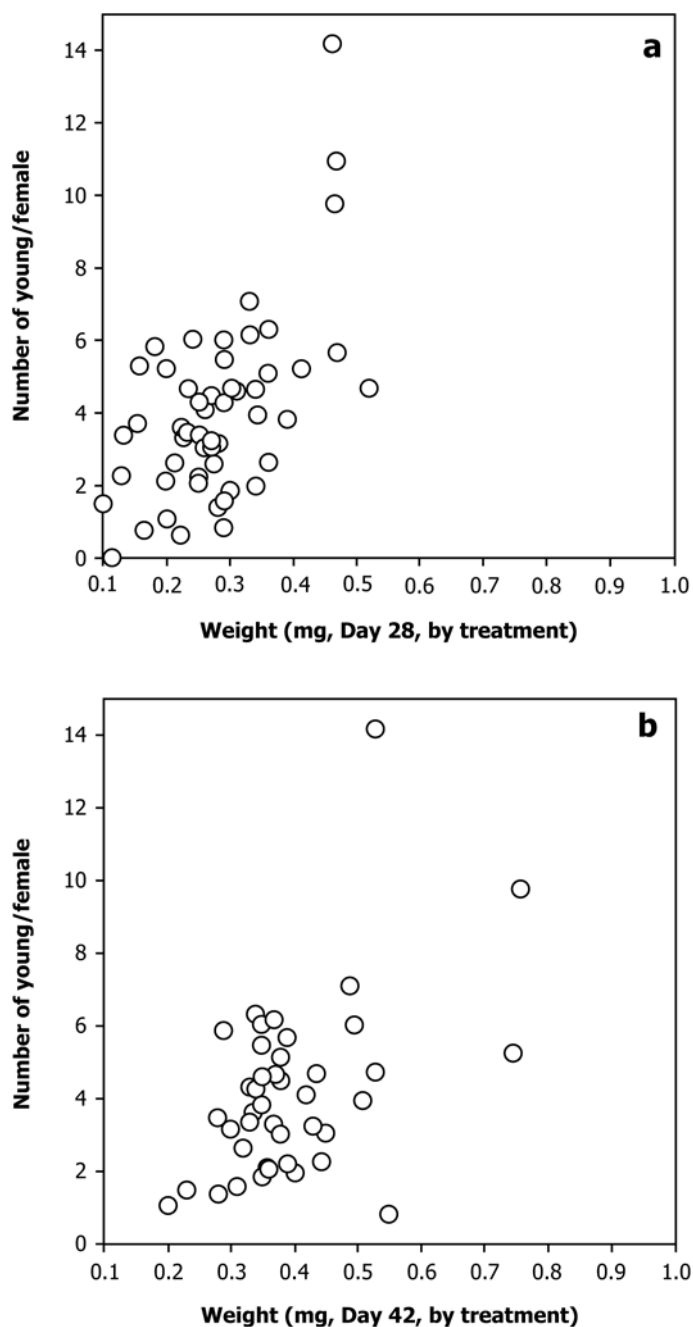

FIG. A6.2 Relationships between *Hyalella azteca* dry weight and reproduction by (a) treatment means for 28-day dry weight or (b) treatment means for 42-day dry weight.

most labs had not previously performed the test. As discussed above, the number of replicates can be adjusted according to the needs of a particular study.

A6.4.5.7 For example, Kubitz et al. (359) recommended a two step process for assessing growth in sediment tests with *H. azteca*. Using this process, a limited number of replicates would be tested in a screening step. Samples identified as possibly affecting reproduction could then be tested in a confirmatory step with additional replicates. This two-step analysis conserves laboratory resources and increases statistical power when needed to discriminate sublethal effects. A similar approach could be applied to evaluate reproductive

effects of contaminants in sediment where a limited number of replicates could be initially tested to evaluate potential effects. Samples identified as possibly toxic based on reproduction could then be re-evaluated using an increased number of replicates. However, the use of sediments stored for extended periods of time may introduce variability in results between the two studies (Section 10.2).

A6.4.6 Relative Endpoint Sensitivity: Measurement of sublethal endpoints in sediment tests with *H. azteca* can provide unique information that has been used to discriminate toxic effects of exposure to contaminants. Table A6.4 compares the



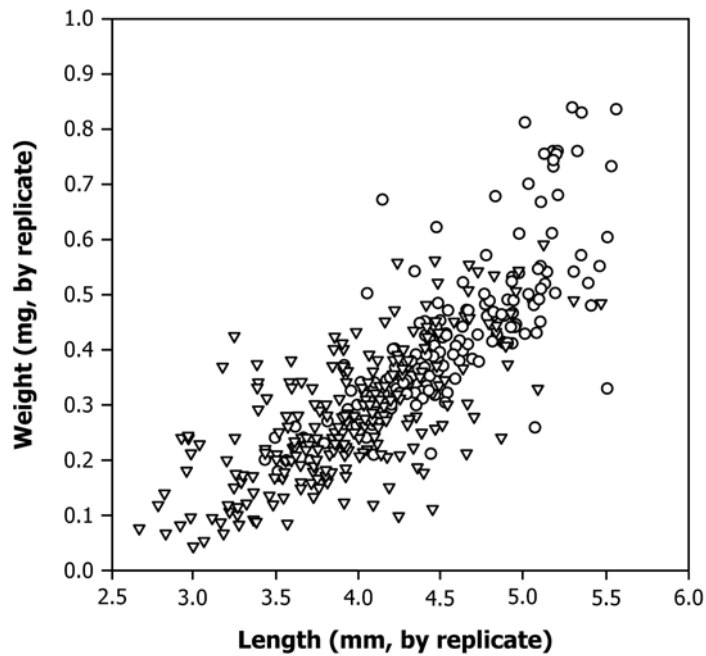

FIG. A6.3 Relationship between *Hyalella azteca* length and dry weight. Triangles are data for Day 28 and circles are data for Day 42 (56)

TABLE A6.4 Percentage of Paired Tests or Paired Endpoints Identifying Samples as Toxic in *Hyalella azteca* 14-day or 28-day Tests. See USEPA (382) and Ingersoll et al. (85) for a description of this database.

Comparison	Tox/tox <sup>A</sup> (%)	Not/not <sup>B</sup> (%)	Tox/not <sup>C</sup> (%)	Not/tox <sup>D</sup> (%)	N <sup>E</sup>
Survival or growth: 14 day/28 day	34	53	6	6	32
Survival: 14 day/28 day	25	66	0	10	32
Growth: 14 day/28 day	8	64	12	16	25
14 day: survival/growth	4	60	20	16	25
28 day: survival/growth	16	52	14	18	44

<sup>A</sup>Tox/tox: samples toxic (significant reduction relative to the control  $p < 0.05$ ) with both tests (or both endpoints).

<sup>B</sup>Not/not: samples not toxic with both tests (or both endpoints).

<sup>C</sup>Tox/not: samples toxic to the first but not the second test (or endpoint).

<sup>D</sup>Not/tox: samples not toxic to the first but toxic to the second test (or endpoint).

<sup>E</sup>N: number of samples

relative sensitivity of survival and growth endpoints in 14- and 28-day tests with *H. azteca* (Ingersoll et al. (85), (56)). When 14-day and 28-day tests were conducted concurrently measuring both survival and growth, both tests identified 34 % of the samples as toxic and 53 % of the samples as not toxic (N=32). Both tests identified an additional 6 % of the samples as toxic. Survival or growth endpoints identified a similar percentage of samples as toxic in both the 14- and 28-day tests. However, the majority of the samples used to make these comparisons were highly contaminated. Additional exposures conducted with moderately contaminated sediment might exhibit a higher percentage of sublethal effects in the 28-day test compared to the 14-day test.

A6.4.6.1 When both survival and growth were measured in 14-day tests (N=25), only 4 % of the samples reduced both survival and growth; however, 20 % reduced survival only and 16 % reduced growth only (60 % did not reduce survival or growth). Hence, if survival was the only endpoint measured in

14-day tests, 16 % of the toxic samples would be incorrectly classified. Similar percentages are also observed for the 28-day tests. When both survival and growth were measured in the 28-day test (N=44), 16 % of the samples reduced both survival and growth, 14 % reduced survival only, 18 % reduced growth only, and 52 % did not reduce survival or growth.

A6.4.6.2 The endpoint comparisons in Table A6.4 represent only samples where both survival and growth could be measured. If a sample was extremely toxic, it would not be included in this comparison since growth could not be measured. Moderately contaminated sediments that did not severely reduce survival could have a reduced growth. For example, in 28-day tests with sediments from the Clark Fork River, growth was a more sensitive endpoint compared to a survival or maturation. Only 13 % of the samples reduced survival and 20 % of the samples reduced maturation; however, growth was reduced in 53 % of the samples (Kemble et al. (18)).

A6.4.6.3 Other investigators have reported measurement of growth in tests with *H. azteca* often provides unique information that can help discriminate toxic effects of exposure to contaminants in sediment (Kubitz et al. (359), Milani et al. (383); Steevens and Benson(209)) or water (Brasher and Ogle (384); Borgmann (114)). Similarly, in sediment tests with the midge *C. dilutus*, sublethal endpoints are often more sensitive than survival as indicators of contaminant stress (Section 14 and Annex A7). In contrast, Borgmann et al (364) reported that growth or reproduction did not add additional information beyond measurement of survival of *H. azteca* in water-only exposures with cadmium or pentachlorophenol. Similarly, Day et al. (103) reported that weight did not add additional information beyond measurement of survival in 28-day tests with *H. azteca*, Ramirez-Romero (385) reported that reproduction of *H. azteca* was not affected by exposure to sublethal concentrations of fluoranthene in sediment when exposures

were started with juvenile amphipods. Brasher and Ogle (384) started exposures with adult amphipods and observed the sensitivity of reproduction compared to survival of *H. azteca* was dependent on the chemical tested (reproduction more sensitive to selenite and survival more sensitive to selenate in water-only exposures). Long-term exposures starting with juvenile amphipods would likely be more appropriate to assess effects of contaminants on reproduction (i.e., Carr and Chapman (136); Nebeker et al. (180)).

**A6.4.7 Future Research:** Additional studies are needed to further evaluate the use of reconstituted water and ammonia on long-term exposures with *H. azteca*. Ongoing water-only

toxicity tests with select chemicals (i.e., cadmium, DDD, and fluoranthene), should generate data that can be used to better determine the relative sensitivity of survival, reproduction and growth endpoints in tests with *H. azteca*. Section 1.6.3.5 addresses interpretive guidance for evaluating toxicity associated with ammonia in sediment. These water only studies will be used to evaluate potential recovery of amphipods after transfer into clean water to measure reproduction. In addition to evaluating the relative sensitivity of endpoints, research is also needed to evaluate that ability of these laboratory endpoints to estimate responses of benthic organisms exposed in the field to chemicals in sediments (Canfield et al. (46)).

## **A7. GUIDANCE FOR A LIFE-CYCLE TEST FOR MEASURING EFFECTS OF SEDIMENT-ASSOCIATED CONTAMINANTS ON *Chironomus dilutus***

### **A7.1 Introduction**

**A7.1.1** The midge *Chironomus dilutus* (formerly known as *C. tentans*; Shobanov et al. 1999. (1), has been used extensively in the short-term assessment of chemicals in sediments (Wentsel et al.(42) ; Nebeker et al. (200); Giesy et al. (41); West et al. (12)), and standard methods have been developed for testing with this midge using 10-day exposures (Ingersoll et al., (386); USEPA, (2)). *Chironomus dilutus* is a good candidate for long-term toxicity testing because it normally completes its life-cycle in a relatively short period of time (25 to 30 days at 23°C), and a variety of developmental (growth, survivorship) and reproductive (fecundity) endpoints can be monitored. In addition, emergent adults can be readily collected so it is possible to transfer organisms from the sediment test system to clean, overlying, water for direct quantification of reproductive success.

**A7.1.2** Section A7.2 describes general guidance for conducting a long-term sediment tests with *C. dilutus* that can be used to evaluate sublethal effects of contaminants associated with sediments. More definitive methods may be described in future versions of this standard after additional laboratories have successfully used the method (Section 17.6 and USEPA (2000) (2) ). The methods for conducting long-term tests with sediments are more specialized and labor-intensive compared to the short-term tests.

**A7.1.3** The long-term sediment toxicity test with the midge, *Chironomus dilutus*, is a life-cycle test in which the effects of sediment exposure on survival, growth, emergence, and reproduction are assessed (Benoit et al. (72)). Procedures for conducting the long-term test with *C. dilutus* are described in Section A7.2. The test is started with newly hatched larvae (<24-h old) and continue through emergence, reproduction, and hatching of the F<sub>1</sub> generation. Survival is determined at 20 days and at the end of the test (about 50 to 65 days). Growth is determined at 20 day, which corresponds to the 10-day endpoint in the 10-day *C. dilutus* growth test started with 10-day old larvae (Section 14). From Day 23 to the end of the test, emergence and reproduction are monitored daily. The

number of eggs is determined for each egg case, which is incubated for 6 days to determine hatching success. Each treatment of the life-cycle test is ended separately when no additional emergence has been recorded for 7 consecutive days (the 7-day criterion). When no emergence is recorded from a treatment, ending of that treatment should be based on the control sediment using this 7-day criterion. Table 6.1 and Section A7.5 outline equipment and supplies needed to conduct this test. The procedures described in Section A7.2 include measurement of a variety of lethal and sublethal endpoints; minor modifications of the basic methods can be used in cases where only a subset of these endpoints is of interest.

**A7.1.4** The method outlined in Section A7.2 has been evaluated in round-robin testing (USEPA (2), Section 17.6). After the long-term exposures in a control sediment (West Bearskin) with midges fed 1.5 ml/beaker/day of Tetrafin, 90 % of labs met the survival criterion (≥70 %), 100 % of labs met the growth criterion (≥0.48 mg AFDW), 70 % of labs met the emergence criterion (≥50 %), 90 % of labs met the reproduction criterion (≥800 eggs/female), and 88 % of labs met the percent hatch criterion (≥ 80 %). Reproduction was generally more variable than growth or survival within and among laboratories; hence, more replicates might be needed to establish statistical significance of small decreases in reproduction.

**A7.1.5** Interlaboratory precision (round-robin) tests have been completed with both *Hyalella azteca* and *Chironomus dilutus* using 4-day water-only test and 10-day whole-sediment tests for the Test Methods described in Sections 13.2 and 14.2 (Section 17.5). USEPA (2) and Section 17.6 describes results of round-robin evaluations with long-term sediment toxicity tests described in Section A6.2 for *H. azteca* and A7.2 for *C. dilutus*.

**A7.1.6** Results of tests using procedures different from the procedures described in Section A7.2 may not be comparable and these different procedures may alter contaminant bioavailability. Comparison of results obtained using modified versions of these procedures might provide useful information concerning new concepts and procedures for conducting sediment tests

with aquatic organisms. If tests are conducted with procedures different from the procedures described in this standard, additional tests are required to determine comparability of results (Section 1.5).

### A7.2 Procedure for Conducting a life-cycle test for measuring effects of sediment associated contaminants— on *Chironomus dilutus*

A7.2.1 Conditions for conducting a long-term sediment toxicity test with *C. dilutus* are summarized in Table A7.1. A general activity schedule is outlined in Table A7.2. Decisions concerning the various aspects of experimental design, such as the number of treatments, number of test chambers/treatment, and water-quality characteristics should be based on the purpose of the test and the methods of data analysis (Section 15). When variability remains constant, the sensitivity of a test increases as the number of replicates increases.

A7.2.2 The long-term sediment toxicity test with *C. dilutus* is conducted at 23°C with a 16L:8D photoperiod at an illuminance of about 100 to 1000 lux (Table A7.1). Test chambers are 300-mL high-form lipless beakers containing 100 mL of sediment and 175 mL of overlying water. Each test chamber receives 2 volume additions/day of overlying water. Water renewals may be manual or automated. Zumwalt et al. (128). Benoit et al. (127) and USEPA (2) describe water-renewal systems that can be used to deliver overlying water. Overlying water should be a source of water that has been demonstrated to support survival, growth, and reproduction of *C. dilutus* in culture. For site-specific evaluations, the characteristics of the overlying water should be as similar as possible to the site where sediment is collected. Requirements for test acceptability are summarized in Table A7.3.

A7.2.3 The number of replicates and concentrations tested depends in part on the significance level selected and the type of statistical analysis. For routine testing, a total of 16 replicates, each containing 12, <24-h-old larvae are tested for each treatment. For the total of 16 replicates the assignment of beakers is as follows: initially, 12 replicates are set up on Day-1 of which 4 replicates are used for 20-day growth and survival endpoints and 8 replicates for determination of emergence and reproduction. It is typical for males to begin emerging 4 to 7 days before females. Therefore, additional males, referred to as auxiliary males, need to be available during the prime female emergence period for each respective chamber/sediment. To provide these males, 4 additional replicates are stocked with 12, <24-h-old larvae 10 day following initiation of the test. Midges in each test chamber are fed 1.5 mL of a 4-g/L Tetrafin® suspension daily. Endpoints monitored include 20-day survival and ash-free dry weight, emergence, time to death (adults), reproduction, and egg hatchability.

### A7.3 General Procedures

A7.3.1 Collection of Egg Cases: Egg cases are obtained from adult midges held in a sex ratio of 1:3 male:female. Ten males and 30 females will produce between 15 to 25 egg cases. Adults should be collected four days before starting a test (Section A7.5, Fig. A7.1). The day after collection of adults, 6 to 8 of the larger “C” shaped egg cases are transferred to a petri

**TABLE A7.1 Test Conditions for Conducting a Long-term Sediment Toxicity Test with *Chironomus dilutus***

Parameter	Conditions
1. Test type	Whole-sediment toxicity test with renewal of overlying water
2. Temperature	23 ± 1°C
3. Light quality	Wide-spectrum fluorescent lights
4. Illuminance	About 100 to 1000 lux
5. Photoperiod	16L:8D
6. Test chamber	300-mL high-form lipless beaker
7. Sediment volume	100 mL
8. Overlying water volume	175 mL
9. Renewal of overlying water	2 volume additions/d; continuous or intermittent (e.g., one volume addition every 12 h)
10. Age of organisms	< 24 h old larvae
11. Number of organisms/chamber	12
12. Number of replicate chambers/treatment	16 (12 at Day -1 and 4 for auxiliary males on Day 10)
13. Feeding	Tetrafin® goldfish food, fed 1.5 mL daily to each test chamber (1.5 mL contains 6.0 mg of dry solids); starting Day -1
14. Aeration	None, unless dissolved oxygen in overlying water drops below 2.5 mg/L
15. Overlying water	Culture water, well water, surface water, site water, or reconstituted water
16. Test chamber cleaning	If screens become clogged during a test; gently brush the outside of the screen
17. Overlying water quality	Hardness, alkalinity, conductivity, and ammonia at the beginning and end of a test and on day 20. Temperature daily (ideally continuously). Dissolved oxygen (DO and pH three times/week. Concentrations of DO should be measured more often if DO has declined by more than 1 mg/L since previous measurement.
18. Test duration	About 40 to 50 d; each treatment is ended separately when no additional emergence has been recorded for seven consecutive days. When no emergence is recorded from a treatment, termination of that treatment should be based on the control sediment using this 7-day criterion.
19. Endpoints	20-day survival and AFDW; female and male emergence, adult mortality, the number of egg cases oviposited, the number of eggs produced, and the number of hatched eggs. Potential sublethal endpoints are listed in Table A7.4.
20. Test acceptability	Minimum average size of <i>C. dilutus</i> in the control sediment at 20 d must be at least 0.6 mg/surviving organism as dry weights or 0.48 mg/surviving organism as AFDW. Emergence should be greater than or equal to 50%. Experience has shown that pupae survival is typically >83% and adult survival is >96%. Time to death after emergence is <6.5 d for males and <5.1 d for females, The mean number of eggs/egg case should be greater than or equal to 800 and the percent hatch should be greater than or equal to 80%. See sections A7.1.3 and 17.6 for a summary of performance in round robin testing.

dish with culture water and incubated (at 23°C; Section A7.5, Fig. A7.2). Hatching typically begins around 48 h and larvae typically leave the egg case 24 h after the first hatch. The number of eggs in each egg case will vary, but typically ranges from 600 to 1500 eggs. It should be noted that mating may have occurred in culture tanks before males and females are collected into flasks for collecting eggs.

**TABLE A7.2 General Activity Schedule for Conducting a Long-term Sediment Toxicity Test with *Chironomus dilutus***

Day	Activity
-4	Start reproduction flask with cultured adults (1:3 male:female ratio). For example for 15 to 25 egg cases, 10 males and 30 females are typically collected. Egg cases typically range from 600 to 1500 egg/case.
-3	Collect egg cases (a minimum of 6 to 8) and incubate at 23°C.
-2	Check egg cases for viability and development.
-1	1. Check egg cases for hatch and development. 2. Add 100 mL of homogenized test sediment to each replicate beaker and place in corresponding treatment holding tank. After sediment has settled for at least 1 h, add 1.5 mL Tetrafin slurry (4g/L solution) to each beaker. Overlying water renewal begins at this time.
0	1. Transfer all egg cases to a crystallizing dish containing control water. Discard larvae that have already left the egg cases in the incubation dishes. Add 1.5 mL food to each test beaker with sediment before the larvae are added. Add 12 larvae to each replicate beaker (beakers are chosen by random block assignment). Let beakers sit (outside the test system) for 1 h following addition of the larvae. After this period, gently immerse all beakers into their respective treatment holding tanks. 2. Measure temperature, pH, hardness, alkalinity, dissolved oxygen, conductivity and ammonia at start of test, and on day 20.
1-End	On a daily basis, add 1.5 mL food to each beaker. Measure temperature daily. Measure the pH and dissolved oxygen three times a week during the test. If the DO has declined more than 1 mg/L since previous reading, increase frequency of DO measurements and aerate if DO continues to be less than 2.5 mg/L.
6	For auxiliary male production, start reproduction flask with culture adults (e.g., 10 males and 30 females; 1:3 male to female ratio).
7-10	Set up schedule for auxiliary male beakers (4 replicates/treatment) same as that described above for Day -3 to Day 0.
19	In preparation for weight determinations, ash weigh-pans at 550 °C for 2 h. Note that the weigh boats should be ashed before use to eliminate weighing errors due to the pan oxidizing during ashing of samples.
20	Randomly select four replicates from each treatment and sieve the sediment to recover larvae for growth and survival determinations. Pool all living larvae per replicate and dry the sample to a constant weight (e.g., 60°C for 24 h). Install emergence traps on each reproductive replicate beakers. Measure hardness, alkalinity, and conductivity.
21	The sample with dried larvae is brought to room temperature in a dessicator and weighed to the nearest 0.01 mg. The dried larvae in the pan are then ashed at 550°C for 2 h. The pan with the ashed larvae is then re-weighed and the tissue mass of the larvae determined as the difference between the weight of the dried larvae plus pan and the weight of the ashed larvae plus pan.
23-End	On a daily basis, record emergence of males and females, pupal, and adult mortality, and time to death for previously collected adults. Each day, transfer adults from each replicate to a corresponding reproduction/oviposition (R/O) chamber. Transfer each primary egg case from the R/O chamber to a corresponding petri dish to monitor incubation and hatch. Record each egg case oviposited, number of eggs produced (using either the ring or direct count methods), and number or hatched eggs. If it is difficult to estimate the number of eggs in an egg case, use a direct count to determine the number of eggs; however the hatchability data will not be obtained for this egg case.
30	Place emergence traps on auxiliary male replicate beakers.
33-End	Transfer males emerging from the auxiliary male replicates to individual inverted petri dishes. The auxiliary males are used for mating with females from corresponding treatments from which most of the males had already emerged or in which no males emerged.
40-End	After 7 d of no recorded emergence in a given treatment, end the treatment by sieving the sediment to recover larvae, pupae, or pupal exuviae. When no emergence occurs in a test treatment, that treatment can be ended once emergence in the control sediment has ended using the 7-day criterion.

**TABLE A7.3 Test Acceptability Requirements for a Long-term Sediment Toxicity Test with *Chironomus dilutus***

- A. It is recommended for conducting a long-term test with *C. dilutus* that the following performance criteria be met:
1. Tests must be started with less than 1-day (<24 h) old larvae. Starting a test with substantially older organisms may compromise the emergence and reproductive endpoint.
  2. Average survival of *C. dilutus* in the control sediment should be greater than or equal to 70% at Day 20 and greater than or equal to 65% at the end of the test.
  3. Average size of *C. dilutus* in the control sediment at 20 d must be at least 0.6 mg/surviving organism as dry weights or 0.48 mg/surviving organism as AFDW. Emergence should be greater than or equal to 50%. Experience has shown that pupae survival is typically >83% and adult survival is >96%. Time to death after emergence is <6.5 d for males and <5.1 d for females. The mean number of eggs/egg case should be greater than or equal to 800 and the percent hatch should be greater than or equal to 80%. See sections A7.1.3 and 17.6 for a summary of performance in round robin testing.
  4. Hardness, alkalinity and ammonia in the overlying water within a treatment typically should not vary by more than 50% during the test and dissolved oxygen should be maintained above 2.5 mg/L in the overlying water.
- B. Performance-based criteria for culturing *C. dilutus* include the following:
1. It may be desirable for laboratories to periodically perform 96-h water-only reference-toxicity tests to assess the sensitivity of culture organisms (section 11.16.2). Data from these reference toxicity tests could be used to assess genetic strain or life-stage sensitivity of test organisms to select chemicals.
  2. Laboratories should keep a record of time to first emergence for each culture and record this information using control charts. Records should also be kept on the frequency of restarting cultures.
  3. Laboratories should record the following water-quality characteristics of the cultures at least quarterly: pH, hardness, alkalinity, and ammonia. Dissolved oxygen in the cultures should be measured weekly. Temperature in the cultures should be recorded daily. If static cultures are used, it may be desirable to measure water quality more frequently.
  4. Laboratories should characterize and monitor background contamination and nutrient quality of food if problems are observed in culturing or testing organisms.
  5. Physiological measurements such as lipid content might provide useful information regarding the health of the cultures.
- C. Additional requirements:
1. All organisms in a test must be from the same source.
  2. Storage of sediments collected from the field should follow guidance outlined in Section 10.2
  3. All test chambers (and compartments) should be identical and should contain the same amount of sediment and overlying water.
  4. Negative-control sediment and appropriate solvent controls must be included in a test. The concentration of solvent used must not adversely affect test organisms.
  5. Test organisms must be cultured and tested at 23°C (+1 °C).
  6. The mean of the daily test temperature must be within ± 1°C of 23°C. The instantaneous temperature must always be within ±3°C of 23°C.
  7. Natural physico-chemical characteristics of test sediment collected from the field should be within the tolerance limits of the test organisms.

**A7.3.2 Hatching of Eggs:** Hatching of eggs should be complete by about 72 h. Hatched larvae remain with the egg case for about 24 h and appear to use the gelatinous component of the egg case as an initial source of food (Sadler, (184) ; Ball and Baker (387)). After the first 24-h period with larvae hatched, transfer the egg cases from the incubation petri dish to another dish with clean test water. Larvae having already left the egg case in the incubation petri dish are discarded since their precise age and time away from the gelatinous food source is unknown. The action of transferring the egg case stimulates the remaining larvae to leave the egg case within a few hours. These are larvae that are used to start the test.

**A7.3.3 Sediment into Test Chambers:** The day before the sediment test is started (Day-1) each sediment should be thoroughly homogenized and added to the test chambers

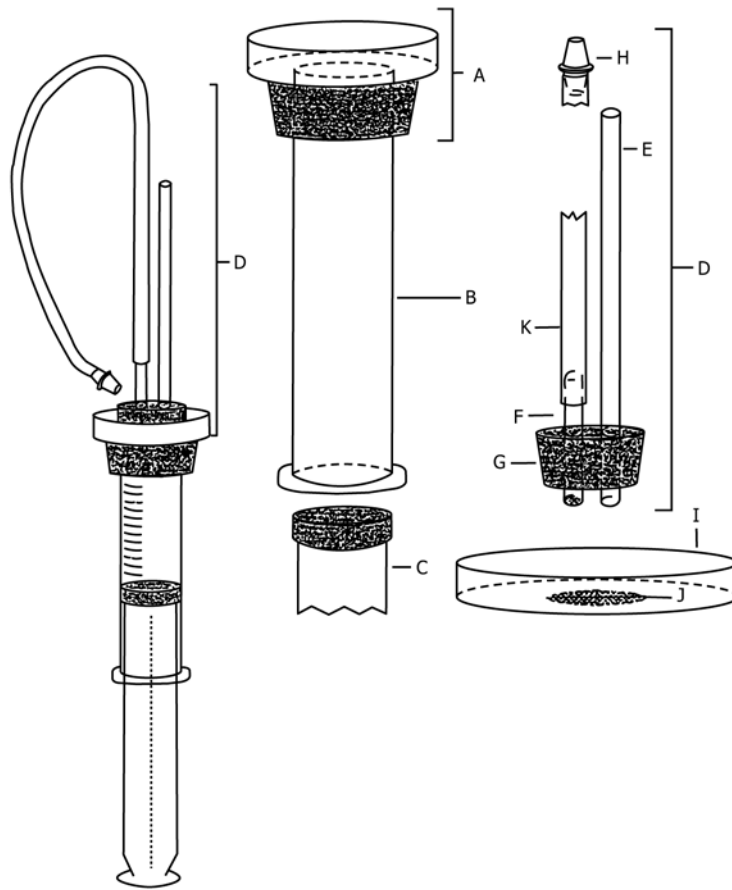

FIG. A7.1 Adult collection/transfer equipment. A: transfer retainer unit showing inverted plastic cover and rubber stopper glued inside of it; B: 60-cc syringe; C: plunger; D: detachable aspirator unit; E: long glass collector tube; F: short glass tube to serve as connector for inhaler tube; note stainless steel screen attached to end through stopper; G: 2-hole rubber stopper; H: nalgene plastic connector attached to tygon tubing and used as a mouthpiece to provide slight suction; I: collector dish, one-half of glass or plastic petri dish; J: petri dish with hole access that is screen covered and slotted; K: tygon tubing attached to glass tube (F).

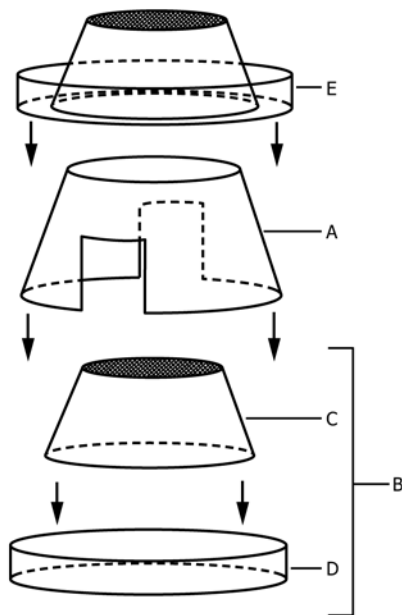

FIG. A7.2 The reproduction/oviposit chamber with the double stack support stand. A: the notched, inverted 270 ml (9-oz) plastic cup used to allow double stacking; B: the reproduction/oviposit (R/O) unit (C and D); C: inverted, 120-ml (4-oz) plastic cup with nylon screen; D: of petri dish (100x20 mm) with 50mL of overlying water; E: the reproduction/oviposit (R/O) chamber.

(Section 10.3.1). Sediment should be visually inspected to judge the extent of homogeneity. Excess water on the surface of the sediment can indicate separation of solid and liquid components. If a quantitative measure of homogeneity is required, replicate subsamples should be taken from the sediment batch and analyzed for TOC, chemical concentrations, and particle size.

A7.3.3.1 Each test chamber should contain the same amount of sediment, determined either by volume or by weight. Overlying water is added to the chambers in a manner that minimizes suspension of sediment. This can be accomplished by gently pouring water along the sides of the chambers or by pouring water onto a baffle (e.g., a circular piece of Teflon with a handle attached) placed above the sediment to dissipate the force of the water. Renewal of overlying water is started on Day-1. A test begins when the organisms are added to the test chambers (Day 0).

A7.3.4 Renewal of Overlying Water: Renewal of overlying water is required during a test. Two volume additions of overlying water (continuous or intermittent) should be delivered to each test chamber daily. At any particular time during the test, flow rates through any two test chambers should not differ by more than 10 %. Hardness, alkalinity and ammonia concentrations in the water above the sediment, within a treatment, typically should not vary by more than 50 % during the test. Mount and Brungs (129) diluters have been modified for sediment testing, and other automated water delivery systems have also been used (Maki (131); Ingersoll and Nelson (130); Benoit et al. (127); Zumwalt et al. (128); Brunson et al. (132); Leppanen and Maier (204); Wall et al. (205)). Each water-delivery system should be calibrated before a test is started to verify that the system is functioning properly. Renewal of overlying water is started on Day-1 before the addition of test organisms on Day 0. Zumwalt et al. (128), Benoit et al. (127) and USEPA (2) describe water-renewal systems that can be used for conducting sediment tests.

A7.3.4.1 In water-renewal tests with one to four volume additions of overlying water/day, water-quality characteristics generally remain similar to the inflowing water (Ingersoll and Nelson (130); Ankley et al. (5)); however, in static tests, water quality may change profoundly during the exposure (Shuba et al. (134)). For example, in static whole-sediment tests, the alkalinity, hardness, and conductivity of overlying water more than doubled in several treatments during a four-week exposure (Ingersoll and Nelson, (130)). Additionally, concentrations of metabolic products (e.g., ammonia) may also increase during static exposures, and these compounds can either be directly toxic to the test organisms or may contribute to the toxicity of the contaminants in the sediment. Furthermore, changes in water-quality characteristics such as hardness may influence the toxicity of many inorganic (Gauss et al. (206)) and organic (Mayer and Ellersieck (207)) contaminants. Although contaminant concentrations are reduced in the overlying water in water-renewal tests, organisms in direct contact with sediment generally receive a substantial proportion of a contaminant dose directly from either the whole sediment or from the interstitial water.

A7.3.5 Acclimation: Test organisms must be cultured and tested at the same temperature. Ideally, test organisms should be cultured in the same water that will be used in testing. However, acclimation of test organisms to the test water is not required. If test organisms are to be acclimated, they could be held for 2 h in a 50 to 50 mixture of culture water to overlying water, then for 2 h in a 25 to 75 mixture of culture water to overlying water, followed by a transfer into 100 % overlying water for 2 h (130).

A7.3.6 Placing Organisms in Test Chambers: Test organisms should be handled as little as possible. To start the test, larvae are collected with a Pasteur pipet from the bottom of the incubation dish with the aid of a dissecting microscope. Test organisms are pipeted directly into overlying water and care should be exercised to release them under the surface of the water. Transferring the larvae to exposure chambers within 4 h of emerging from the egg case reportedly improves (Benoit et al.) (72). Laboratory personnel should practice transferring first-instar midge larvae before tests with the sediment are conducted.

A7.3.7 Feeding: Each beaker received a daily addition of 1.5 mL of Tetrafin® (4 mg/mL dry solids). Without addition of food, the test organisms may starve during exposures. However, the addition of the food may alter the availability of the contaminants in the sediment (Wiederholm et al. (106); Harkey et al. (35)). Furthermore, if too much food is added to the test chamber, or if the mortality of test organisms is high, fungal or bacterial growth may develop on the sediment surface. Therefore, the amount of food added to the test chambers is kept to a minimum.

A7.3.7.1 Suspensions of food should be thoroughly mixed before aliquots are taken. If excess food collects on the sediment, a fungal or bacterial growth may develop on the sediment surface, in which case feeding should be suspended for one or more days. A drop in dissolved oxygen below 2.5 mg/L during a test may indicate that the food added is not being consumed. Feeding should be suspended for the amount of time necessary to increase the dissolved oxygen concentration. If feeding is suspended in one treatment, it should be suspended in all treatments. Detailed records of feeding rates and the appearance of the sediment surface should be made daily.

A7.3.8 Monitoring a Test: All chambers should be checked daily and observations made to assess test organism behavior such as sediment avoidance. However, monitoring effects on burrowing activity of test organisms may be difficult because the test organisms are often not visible during the exposure. The operation of the exposure system should be monitored daily.

A7.3.8.1 Measurement of Overlying Water-quality Characteristics: Conductivity, hardness, pH, alkalinity, dissolved oxygen, and ammonia should be measured in all treatments at the beginning of the test, on Day 20, and at the end of the test. Dissolved oxygen (DO) and pH measurements should be taken at the beginning of a test and at least three times a week until the end of the test. Conductivity of the overlying water should be measured weekly in each treatment. Overlying water should

be sampled just before water renewal from about 1 to 2 cm above the sediment surface using a pipet. It may be necessary to pool water samples from individual replicates. The pipet should be checked to make sure no organisms are removed during sampling of overlying water. Water quality should be measured for each new batch of water prepared for the test.

**A7.3.8.1.1** Routine chemistries on Day 0 should be taken before organisms are placed in the test beakers. Dissolved oxygen and pH can be measured directly in the overlying water with a probe. However, for DO it is important to allow the probe time to equilibrate in the overlying water in an effort to accurately measure concentrations of DO. If a probe is used for measurements in overlying water, it should be inspected between samples to make sure that organisms are not attached and should be rinsed between samples to minimize cross contamination.

**A7.3.8.1.2** Water-only exposures evaluating the tolerance of *C. dilutus* larva to depressed DO have indicated that significant reductions in weight occurred after 10-day exposure to 1.1 mg/L DO, but not at 1.5 mg/L (V. Mattson, USEPA, Duluth, MN, personal communication). This finding concurs with the observations during method development at the USEPA laboratory in Duluth that excursions of DO as low as 1.5 mg/L did not seem to have an effect on midge survival and development (P.K. Sibley, University of Guelph, Guelph, Ontario, personal communication). Based on these findings, periodic depressions of DO below 2.5 mg/L (but, not below 1.5 mg/L) are not likely to adversely affect test results, and thus should not be a reason to discard test data. Nonetheless, tests should be managed toward a goal of DO > 2.5 mg/L to insure satisfactory performance. If the DO level of the water falls below 2.5 mg/L for any one treatment, aeration is encouraged and should be done in all replicates for the duration of the test. Occasional brushing of screens on outside of beakers will help maintain the exchange of water during renewals. If a probe is used to measure DO in overlying water, it should be thoroughly inspected between samples to make sure that organisms are not attached and should be rinsed between samples to minimize cross contamination. Aeration can be used to maintain dissolved oxygen in the overlying water above 2.5 mg/L (i.e., about 1 bubble/second in the overlying water).

**A7.3.8.1.3** Temperature should be measured at least daily in at least one test chamber from each treatment. The temperature of the water bath or the exposure chamber should be continuously monitored. The daily mean test temperature must be within  $\pm 1^\circ\text{C}$  of  $23^\circ\text{C}$ . The instantaneous temperature must always be within  $\pm 3^\circ\text{C}$  of  $23^\circ\text{C}$ .

**A7.3.8.2** Monitoring Survival and Growth: At 20 day, 4 of the initial 12 replicates are selected for use in growth and survival measurements. Using a #40 sieve (425  $\mu\text{m}$  mesh) to remove larvae from sediment, collect the *C. dilutus*. Any immobile organisms isolated from the sediment surface or from sieved material should be considered dead. Often *C. dilutus* larvae tend to lose their coloration within 15 to 20 min of death and may become rigidly elongate. Surviving larvae are kept separated by replicate for weight measurements; if pupae are recovered (<1 % occurrence at recommended test conditions), these organisms are included in survival data but

not included in the growth data. A consistent amount of time should be taken to examine sieved material for recovery of test organisms (e.g., 5 min/replicate).

**A7.3.8.3** The 10-day method for *C. dilutus* in the previous version of this standard (Test Method E1706-95b), as well as most previous research, has used dry weight as a measure of growth. However, Sibley et al. (71) found that the grain size of sediments influences the amount of sediment that *C. dilutus* larvae ingest and retain in their gut. As a result, in finer-grain sediments, a substantial portion of the measured dry weight may be comprised of sediment rather than tissue. While this may not represent a strong bias in tests with identical grain size distributions in all treatments, most field assessments are likely to have varying grain size among sites. This will likely create differences in dry weight among treatments that are not reflective of true somatic growth. For this reason, weight of midges should be measured as ash-free dry weight (AFDW) instead of dry weight. AFDW will more directly reflect actual differences in tissue weight by reducing the influence of sediment in the gut. If test organisms are to be used for an evaluation of bioaccumulation, it is not advisable to dry the sample before conducting the residue analysis. If conversion from wet weight to dry weight is necessary, aliquots of organisms can be weighed to establish wet to dry weight conversion factors. A consistent procedure should be used to remove the excess water from the organisms before measuring wet weight.

**A7.3.8.3.1** The AFDW of midges should be determined for the growth endpoint. All living larvae per replicate are combined and dried to a constant weight (e.g.,  $60^\circ\text{C}$  for 24 h). Note that the weigh boats should be ashed before use to eliminate weighing errors due to the pan oxidizing during ashing. The sample is brought to room temperature in a desiccator and weighed to the nearest 0.01 mg to obtain mean weights per surviving organism per replicate. The dried larvae in the pan are then ashed at  $550^\circ\text{C}$  for 2 h. The pan with the ashed larvae is then re-weighed and the tissue mass of the larvae is determined as the difference between the weight of the dried larvae plus pan and the weight of the ashed larvae plus pan. In rare instances, where preservation is required, an 8 % sugar formalin solution can be used to preserve samples (USEPA (2) ) but the effects of preservation on the weight and lengths of the midges have not been sufficiently studied. The sugar formalin solution is prepared by adding 120 g of sucrose to 80 mL of formalin which is then brought to a volume of 1 L using deionized water. This stock solution is mixed with an equal volume of deionized water when used to preserve organisms. NoTox® (Earth Safe Industries, Belle Mead, NJ) can be used as a substitute for formalin (Unger et al.(208)).

**A7.3.8.4** Monitoring Emergence: Emergence traps are placed on the reproductive replicates on Day 20 (emergence traps for the auxiliary beakers are added at the corresponding 20-day time interval for those replicates; Section A7.5, Fig. A7.3 and Fig. A7.4). At  $23^\circ\text{C}$ , emergence in control sediments typically begins on or about Day 23 and continues for about 2 weeks. However, in contaminated sediments, the emergence period may be extended by several weeks.

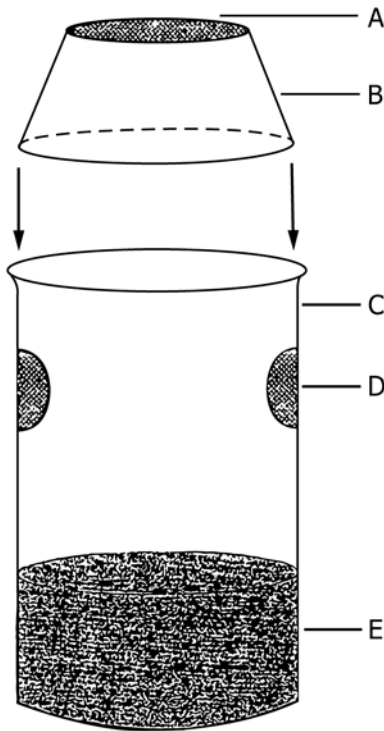

FIG. A7.3 Emergence trap used in the chronic *Chironomus dilutus* sediment test. A: the nylon screen; B: the inverted plastic cups; C: the 300-ml lipless exposure beaker; D: the water exchange screen ports; E: test sediment.

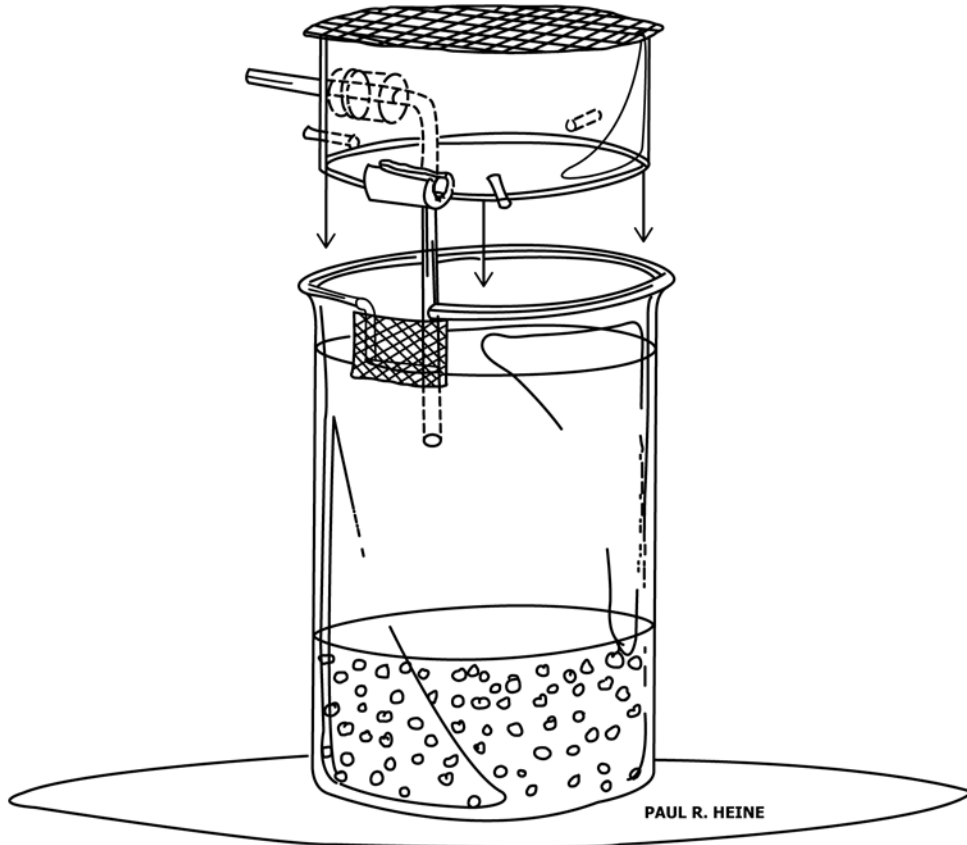

FIG. A7.4 Emergence traps that can be used with the Zumwalt water-delivery system described in Section A.4.



A7.3.8.4.1 Two categories are recorded for emergence: complete emergence and partial emergence. Complete emergence occurs when an organism has shed the pupal exuvia completely and escapes the surface tension of the water. If complete emergence has occurred but the adult has not escaped the surface tension of the water, the adult will die within 24 h. Therefore, 24 h should elapse before this death is recorded. Partial emergence occurs when an adult has only partially shed the pupal exuvia. These adults will also die, an event which can be recorded after 24 h. Pupae at the sediment surface or the air-water interface may emerge successfully during the 24-h period. However, cannibalism of sediment bound pupae by larvae may also occur.

A7.3.8.4.2 Between Day 23 and the end of the test, emergence of males and females, pupal and adult mortality, and time to death for adults is recorded daily for the reproductive replicates. On Day 30 (20-day old organisms), emergence traps are placed on the auxiliary beakers to collect the additional males for use with females emerging from the reproduction replicates (Table A6.4; Section A7.5, Fig. A7.3 and Fig. A7.4).

A7.3.8.5 Collecting Adults for Reproduction: Adults are collected daily from individual traps using the aspirator and collector dish (Section A7.5, Fig. A7.2). With the collector dish nearby, the emergence trap is quickly moved from the beaker onto the dish. With the syringe plunger fully drawn, the glass collector tube is inserted through the screened access hole of the collector dish and the adults gently aspirated into the syringe barrel. Aspirated adults can easily be seen through the translucent plastic of the syringe. The detachable portion of the aspirator unit is then replaced with a reproduction/oviposit (R/O) chamber. This exchange can be facilitated by placing the thumb of the hand holding the syringe over the barrel entry port until the R/O chamber is in place. With the R/O chamber in place, and the plunger on a solid surface, the barrel of the syringe is pushed gently downward which forces the adults to move up into the R/O unit. Adults remaining on the transfer apparatus may be prodded into the R/O chamber by gently tapping the syringe. The transfer process is completed by quickly moving the R/O chamber to a petri dish containing clean water. At all times during the transfer process, it is important to ensure that the adults are stationary to minimize the possibility of escape.

A7.3.8.5.1 At about Day 33 to the end of the test, the auxiliary males may be needed to support reproduction in females. Males that emerge from the auxiliary male replicates are transferred to individual inverted petri dishes (60 × 15 mm dishes without water and with air holes drilled in top of the dish (Section A7.5 for a listing of equipment)). Each male may be used for mating with females from corresponding treatments for up to 5 day. Males may be used for breeding with more than one new emergent females. Males from a different replicate within the same sediment treatment may be paired with females of replicates where no males have emerged.

A7.3.8.6 Monitoring Reproduction: Each R/O unit is checked daily for dead adults and egg cases. Dead organisms are removed. In situations where many adults are contained within an R/O chamber, it may be necessary to assume that a dead adult is the oldest male or female in that replicate for the

purpose of recording time to death. To remove dead adults and egg cases from the R/O chamber, one side of the chamber is carefully lifted just enough to permit the insertion of a transfer pipet or tweezers.

A7.3.8.6.1 For each emerged female, at least one male, obtained from the corresponding reproductive replicate, from another replicate of that treatment, or from the auxiliary male beakers, is transferred into the R/O unit using an aspirator. Females generally remain sexually receptive up to 3 days if they have not already mated. Benoit et al. (72) have shown that over 90 % of females will oviposit within 1 day of fertilization; however, a few will require as long as 72 h to oviposit. A female will lay a single primary egg case, usually in the early morning (Sadler, (184)). A second, generally smaller egg case may be laid; however these second egg cases are prone to fungus and the viability of embryos is typically poor. These second egg cases do not need to be counted, or recorded, and the numbers of eggs are not included in the egg counts.

A7.3.8.7 Counting Eggs, Egg Case Incubation, and Hatch Determination: Primary egg cases from the R/O chamber are transferred to a separate and corresponding petri dish (60 × 15 mm with about 15 mL of water) to monitor incubation and hatch. The number of eggs should be estimated in each egg case by using a “ring method” as follows: (1) for each egg case, the mean number of eggs in five rings is determined; (2) these rings should be selected at about equal distances along the length of the egg case; (3) the number of eggs/ring multiplied by the number of number of rings in the egg case will provide an estimate of the total number of eggs. This can be done in about 5 min or less for each egg case. Accuracy of estimating versus a direct count method is very close, roughly 95 % (Benoit et al. (72) ). The ring method is best suited to the “C” shaped egg cases.

A7.3.8.7.1 When the integrity of an egg case precludes estimation by the ring method (egg case is convoluted or distorted), the eggs should be counted directly. Each egg case is placed into a 5-cm glass culture tube containing about 2 mL of 2 N sulfuric acid (H<sub>2</sub>SO<sub>4</sub>) and left overnight. The acid dissolves the gelatinous matrix surrounding the eggs but does not affect the structural integrity of the eggs themselves. After digestion, the eggs are collected with a Pasteur pipet and spread across a microscope slide for counting under a dissecting microscope. Counting can be simplified by drawing a grid on the underside of the slide. The direct count method requires a minimum of 10 min to complete and does not permit determination of hatching success.

A7.3.8.7.2 Following estimated egg counts, each egg case is transferred to a 60 × 15 mm plastic petri dish containing 15 mL overlying water and incubated at 23°C until hatching is complete. Although the time required to initiate hatching at this temperature is about 2 day, the period of time required to bring about complete hatch may be as long as 6 day. Therefore, hatching success is determined after 6 days of incubation. Hatching success is determined by subtracting the number of unhatched eggs remaining after the 6 day period from the number of eggs originally estimated for that egg case. Unhatched eggs either remain in the gelatinous egg case or are distributed on the bottom of the petri dish.

A7.3.8.7.3 Depending on the objectives of the study, reproductive output in *C. dilutus* may be expressed as: (1) number of eggs/female or (2) number of offspring/female. The former approach estimates reproductive output (fecundity) in terms of the number of eggs deposited by a female (secondary egg cases are not included) and does not take into account survival of hatched eggs. This approach has been shown to adequately discriminate contaminant (Sibley et al. (54)) and non-contaminant (Sibley et al.(55) ) stressors. Since this approach does not require monitoring egg cases for hatchability, the time and labor involved in conducting the life-cycle test is reduced. However, studies that require estimates of demographic parameters, or include population modeling, will need to determine the number of viable offspring per female (Sibley et al. (55)). This will require determination of larval hatch (see section A7.3.8.7.2). Although larval hatch is listed as a potential endpoint by itself in this standard (Table A7.4), the sensitivity of this endpoint has not been fully assessed.

A7.3.9 Ending a Test: The point at which the life-cycle test is ended depends upon the sediments being evaluated. In clean sediments, the test typically requires 40 to 50 days from initial set up to completion. However, test duration will increase in the presence of environmental stressors which act to reduce growth and delay emergence (Sibley et al.(55) ). Where a strong gradient of sediment contamination exists, emergence patterns between treatments will likely become asynchronous, in which case each treatment needs to be ended separately. For this reason, emergence is used as a guide to decide when to end a test.

A7.3.9.1 For treatments in which emergence has occurred, the treatment (not the entire test) is ended when no further emergence is recorded over a period of 7 days (the 7-day criterion). At this time, all beakers of the treatment are sieved through a #40 mesh screen (425 µm) to recover remaining larvae, pupae, or pupal castes. When no emergence is recorded in a treatment at any time during the test, that treatment can be ended once emergence in the control sediment has ended using the 7-day criterion.

A7.4 Interpretation of Results

A7.4.1 Data Analysis— Endpoints measured in the *C. dilutus* test include survival, growth, emergence and reproduction. Section 15 describes general information regarding statistical analysis of these data including both point estimates (i.e., LC50s) and hypothesis testing (i.e., ANOVA). The following sections describe species-specific information that is

useful in helping to interpret the results of long-term sediment toxicity tests with *C. dilutus*.

A7.4.2 Age Sensitivity— Midges are perceived to be relatively insensitive organisms in toxicity assessments (Ingersoll, (386)). This conclusion is based on measuring survival of fourth-instar larvae in short-term water-only exposures, a procedure that may underestimate the sensitivity of midges to toxicants. The first and second instars of chironomids are more sensitive to contaminants than the third or fourth instars. For example, first-instar *C. dilutus* larvae were 6 to 27 times more sensitive than fourth-instar larvae to acute copper exposure (Nebeker et al.(217); Gauss et al. (206); Fig. 8) and first-instar *C. riparius* larvae were 127 times more sensitive than second-instar larvae to acute cadmium exposure (Williams et al. (218); Fig. 8). In chronic tests with first-instar larvae, midges were often as sensitive as daphnids to inorganic and organic compounds (Ingersoll et al. (33) ). Sediment tests should be started with uniform age and size midges because of the dramatic differences in sensitivity of midges by age.

A7.4.3 Physical characteristics of sediment

A7.4.3.1 Grain Size— Larvae of *C. dilutus* appear to be tolerant of a wide range of particle size conditions in substrates. Several studies have shown that survival is not affected by particle size in natural sediments, sand substrates, or formulated sediments in both 10-day and long-term exposures (Ankley et al. (58); Suedel and Rodgers (60); Sibley et al. (71)(219)). Ankley et al.(380) found that growth of *C. dilutus* larvae was weakly correlated with sediment grain size composition, but not organic carbon, in 10-day tests using 50 natural sediments from the Great Lakes. However, Sibley et al. (71) found that the correlation between grain size and larval growth disappeared after accounting for inorganic material contained within larval guts and concluded that growth of *C. dilutus* was not related to grain size composition in either natural sediments or sand substrates. Avoiding confounding influences of gut contents on weight is the impetus for recommending ash-free dry weight (instead of dry weight) as the index of growth in the 10-day and long-term *C. dilutus* tests. Failing to do so could lead to erroneous conclusions regarding the toxicity of the test sediment (Sibley et al. ) (71). Procedures for correcting for gut contents are described in Section A7.3.8.3. Emergence, reproduction (mean eggs/female), and hatch success were also not affected by the particle size composition of substrates in long-term tests with *C. dilutus* (Sibley et al. ) (219).

A7.4.3.2 Organic Matter—Based on 10-day tests, the content of organic matter in sediments does not appear to affect survival of *C. dilutus* larvae in natural and formulated sediments, but may be important with respect to larval growth. Ankley et al. (58) found no relationship between sediment organic content and survival or growth in 10-day bioassays with *C. dilutus* in natural sediments. Suedel and Rodgers (60) observed reduced survival in 10-day tests with a formulated sediment when organic matter was <0.91 %; however, supplemental food was not supplied in this study, which may influence these results relative to the 10-day test procedures described in this standard. Lacey et al. (388) found that survival of *C. dilutus* larvae was generally not affected in

TABLE A7.4 Acute and Sublethal Endpoints for a Long-term Sediment Toxicity Test with *Chironomus dilutus*

Acute	Sublethal		
Survival	Growth	Emergence	Reproduction
Larvae (20 d)	Larvae	Total/Percent	Sex Ratio
Larvae (end)	Adults	Cumulative (rate)	Time to oviposition
Pupae		Time to First	Mean eggs/female
Adults		Time to Death	Egg case/treatment
			Egg hatchability

10-day tests by either the quality or quantity of synthetic (alpha-cellulose) or naturally derived (peat, maple leaves) organic material spiked into a formulated sediment, although a slight reduction in survival below the acceptability criterion (70 %) was observed in a natural sediment diluted with formulated sediment at an organic matter content of 6 %. In terms of larval growth, Lacey et al. (388) did not observe any systematic relationship between the level of organic material (e.g., food quantity) and larval growth for each carbon source. Although a significant reduction in growth was observed at the highest concentration (10 %) of the leaf treatment in the food quantity study, significantly higher larval growth was observed in this treatment when the different carbon sources were compared at about equal concentrations (effect of food quality). In the latter study, the following gradient of larval growth was established in relation to the source of organic carbon: peat < natural sediment < alpha-cellulose < leaves. Since all of the treatments received a supplemental source of food, these data suggest that both the quality and quantity of organic carbon in natural and formulated sediments may represent an important confounding factor for the growth endpoint in tests with *C. dilutus* (Lacey et al. (388)). However, it is important to note that these data are based on 10-day tests; the applicability of these data to long-term testing has not been evaluated.

A7.4.4 Isolating Organisms at the End of a Test: Quantitative recovery of larvae at the end of a sediment test should not be a problem. The larvae are red and typically greater than 5-mm long and are readily retained on the #40 mesh sieve.

A7.4.5 Influence of Indigenous Organisms: The influence of indigenous organisms on the response of *C. dilutus* in sediment tests has not been reported. Survival of a closely related species, *C. riparius* was not reduced in the presence of oligochaetes in sediment samples (Reynoldson et al. (102) ). However, growth of *C. riparius* was reduced when high numbers of oligochaetes were placed in a sample. Therefore, it

is important to determine the number and biomass of indigenous organisms in field-collected sediment in order to better interpret growth data (Reynoldson et al. (102), DeFoe and Ankley (140)). Furthermore, the presence of predators may also influence the response of test organisms in sediment (Ingersoll and Nelson (130)).

A7.4.6 Relationship between Endpoints

A7.4.6.1 Relationship Between Growth and Emergence Endpoints. An important stage in the life cycle of *C. dilutus* is the emergence of adults from pupal forms. Emergence has been used in many studies as an indicator of contaminant stress (Wentzel et al. (44); Pascoe et al. (389); Sibley et al. (54)). The use of emergence as an endpoint in this context is based upon the understanding that larval growth and emergence are intimately related such that environmental factors that affect larval development may also affect emergence success. Implicit in the relationship between growth and emergence is the notion of a weight threshold that needs to be attained by larvae in order for emergence to take place (Hilsenhoff (390); Liber et al. (391); Sibley et al. (55)). For example, based on evaluations conducted in clean control sediment, Liber et al. (391) and Sibley et al. (55) showed that a minimum tissue mass threshold of about 0.6 mg dry weight or 0.48 mg ash-free dry weight was required before pupation and emergence could take place (Fig. A7.5). Further, Sibley et al. (55) found that maximum emergence (e.g., >60 %) in this sediment occurred only after larvae had attained a tissue mass of about 0.8 mg dry weight. This value corresponds closely to that suggested by Ankley et al. (58) as an acceptability criterion for growth in control sediments in 10-day tests with *C. dilutus*.

A7.4.6.2 Relationship Between Growth and Reproduction Endpoints: Natural or anthropogenic stressors that affect growth of invertebrates may also affect reproduction, because of a minimum threshold body mass needed for reproduction (Rees and Crawley (49); Ernsting et al. (375); Moore and

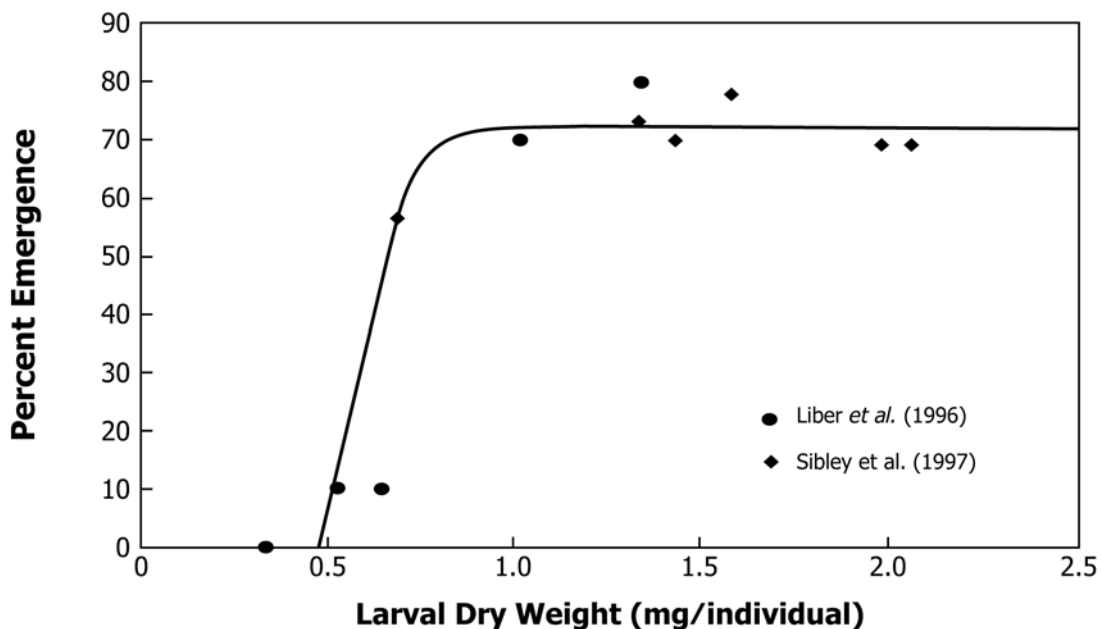

FIG. A7.5 Relationship between weight and emergence of *Chironomus dilutus*.

Dillon (162); Sibley et al. (54), (55)), reported a significant relationship between growth (dry weight) of larval *C. dilutus* and reproductive output (mean number of eggs) of adults in relation to both food and contaminant (zinc) stressors (Fig. A7.6). The form that this relationship may take depends upon the range of stress to which the larvae are exposed and may be linear or sigmoidal. The latter relationship is typically characterized by an upper maximum determined by competitive factors (i.e., food and space availability) and a lower minimum determined primarily by emergence thresholds (See Section A7.4.6.1; Sibley et al., (55)).

A7.4.6.2.1 Embryo viability (percent hatch of eggs) has been shown to evaluate the toxicity for water-borne chemicals (Williams et al., (218); Pascoe et al.(389)). However, percent hatch has not been used extensively as an endpoint to assess toxicity in contaminated sediments. Sibley et al. (54) found that the viability of embryos was not affected at any of the zinc treatments for which egg cases were produced; >87 % of all eggs eventually hatched. Additional information regarding the measurement of embryo viability in round-robin testing is presented in Section 17.6 and USEPA (2000) (2).

A7.4.6.2.2 In contrast to *H. azteca* (Section A6.4), length is not commonly utilized as a growth endpoint in *C. dilutus*. However, length may represent a useful alternative to weight. For example, recent studies (P.K. Sibley, University of Guelph, Guelph, Ontario, unpublished data) found a significant relationship ( $r^2=0.99$ ;  $p < 0.001$ ) between weight and length in larvae of *C. dilutus* reared in clean control sediment (Fig. A7.7). This suggests that either weight or length could be used to assess growth in *C. dilutus*. However, the relationship between length and emergence or reproductive endpoints has not been evaluated.

A7.4.6.3 Relationship between Growth and Population Endpoints: Few studies have attempted to quantitatively define the relationship between larval growth and population-level processes. However, an accurate understanding of the ecological relevance of growth as an endpoint in sediment toxicity tests can only be achieved in terms of its effect, if any, on population-level processes. Sibley et al. (55) found a significant relationship between larval growth and the intrinsic rate of population increase in *C. dilutus* in relation to a food stressor (Fig. A7.8). When applied in a theoretical population model, it was further demonstrated that changes in larval growth resulting from the stressor gradient were significantly correlated to the predicted number of offspring recruited to subsequent generations.

A7.4.6.4 Relative Endpoint Variability: Based on coefficient of variation (CV) determined from a control sediment (West Bearskin), the following variability has been documented for the various endpoints in the *C. dilutus* life-cycle test (Sibley et al. (54); Benoit et al. (72)): Survival (<20 %), growth as dry weight (<15 %), emergence (<30 %), reproduction as mean eggs/female (<20 %), percent hatch (<10 %). Additional information regarding variability in these endpoints in round-robin testing is presented in Section 17.6 and USEPA (2).

A7.4.6.5 Relative Endpoint Sensitivity: Measurement of sublethal endpoints (e.g., growth) can often provide unique information in addition to measuring survival. A comparison of lethal and sublethal endpoints relative to toxicity identification is presented in Table A6.4 for *H. azteca*. However, a few studies have compared the relative sensitivity of the various endpoints in the *C. dilutus* life cycle or in 10-day tests. Sibley et al. (55) found that larval *C. dilutus* exposed to a gradient of food stress did not experience significant effects on survival,

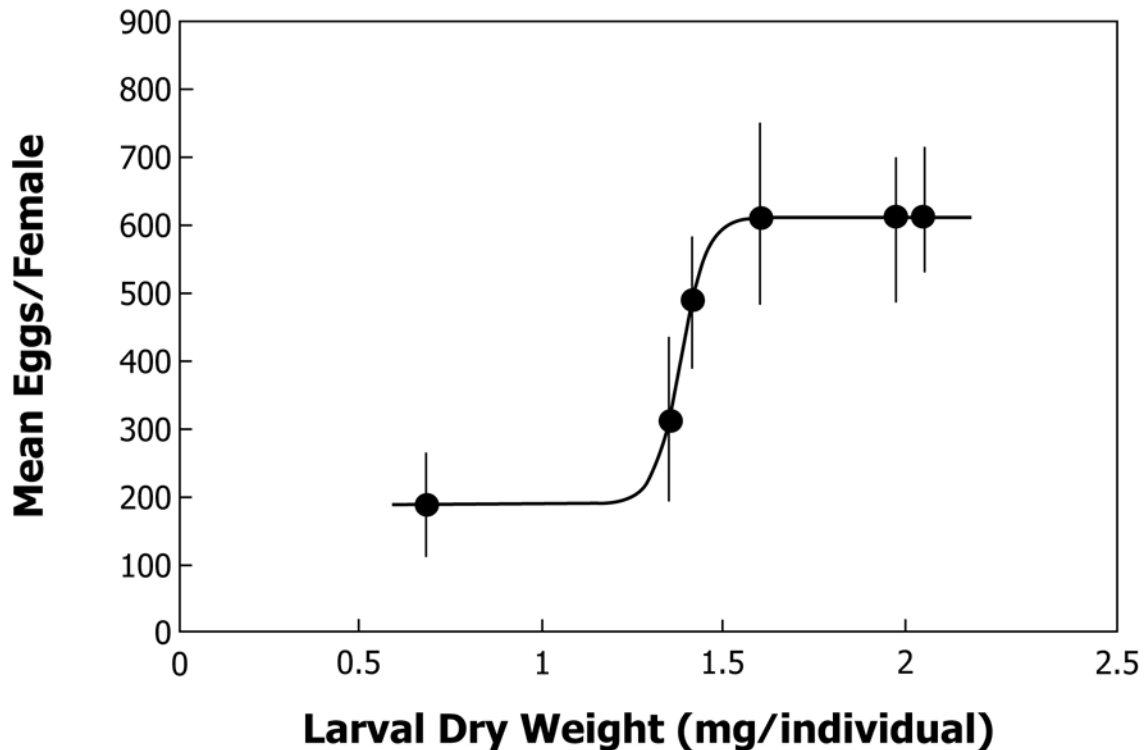

FIG. A7.6 Relationship between weight and reproduction of *Chironomus dilutus*.

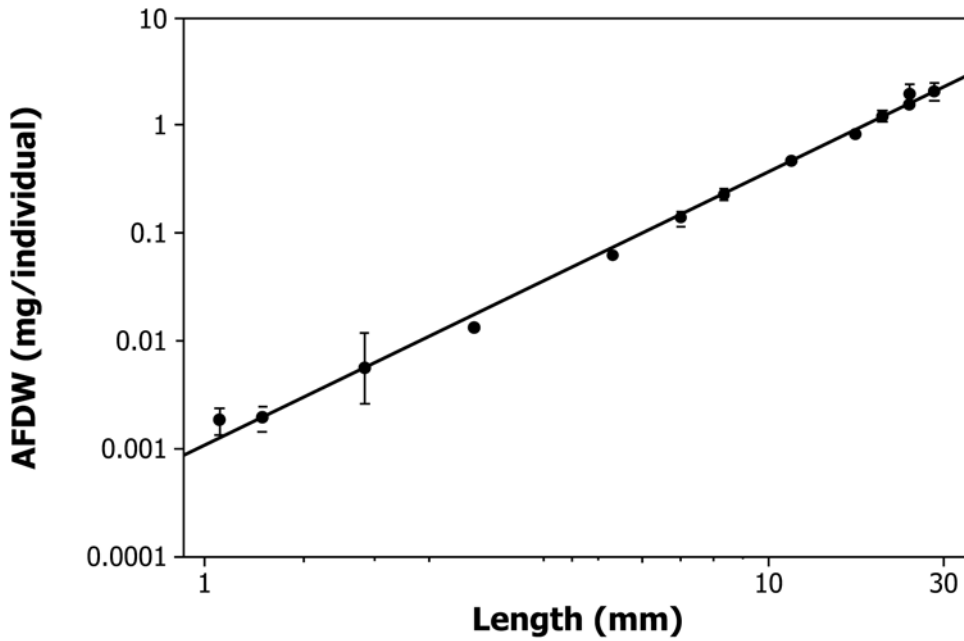

FIG. A7.7 Relationship between ash-free dry weight (AFDW) and length of *Chironomus dilutus*.

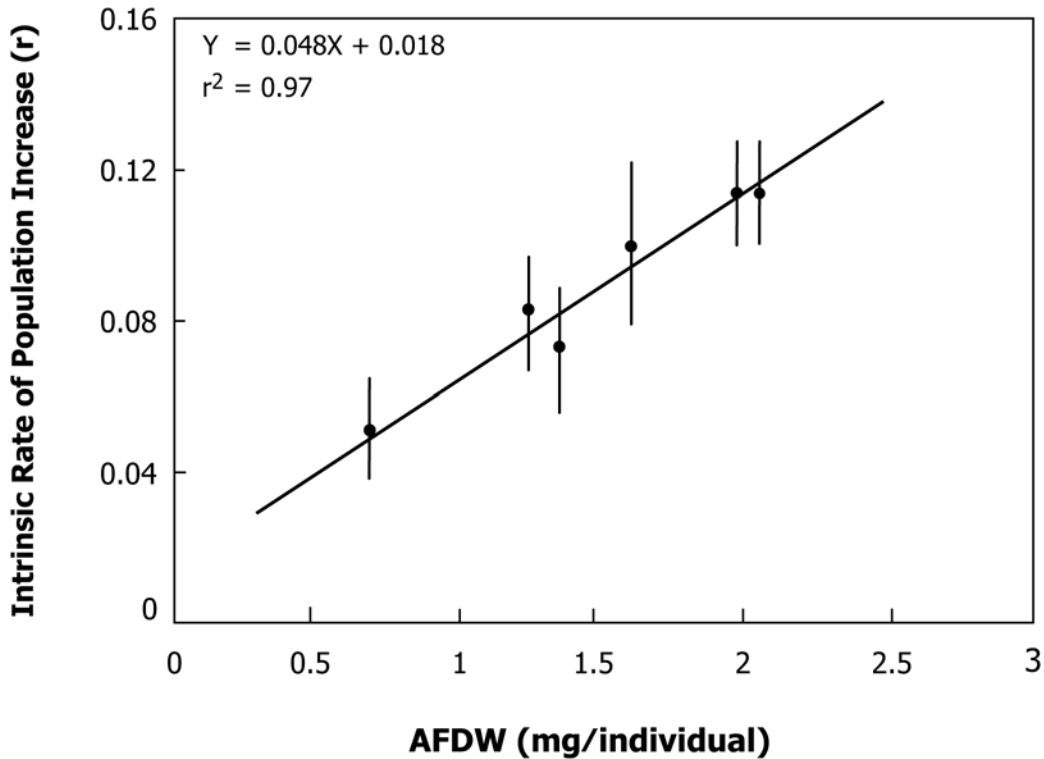

FIG. A7.8 Relationship between ash-free dry weight (AFDW) and intrinsic rate of natural increase of *Chironomus dilutus*.

yet did experience a significant reduction in growth and reproduction. Further, the proportion of larvae hatching in this study was high (>80%) and not systematically related to treatment, suggesting that percent hatch may be a relatively insensitive endpoint to sediment-associated contaminants. This is consistent with the findings of another study using zinc-spiked sediments; no effect on embryo viability was observed

for those treatments in which egg cases were produced (Sibley et al. (54)). Although the responses observed in the feeding study were not due to a contaminant stressor per se, the sublethal endpoints were clearly better able to discriminate the presence of the stressor than was lethality. DeFoe and Ankley (140) studied a variety of contaminated sediments and found that the sensitivity of *C. dilutus* 10-day tests is greatly

increased by measurement of growth in addition to survival. Growth of midge in these 10-day sediment tests was found to be a more sensitive endpoint than survival of *Hyalella azteca*.

**A7.4.7 Future Research**—Additional studies using known concentration gradients in sediment, should be conducted to better differentiate the relative sensitivity between lethal and sublethal endpoints and between sublethal endpoints in the long-term *C. dilutus* test. Additional studies also are needed to further evaluate the influence of ammonia on long-term exposures with *C. dilutus*. Section 1.6.3.5 addresses interpretative guidance for evaluating toxicity associated with ammonia in sediment. Planned water-only toxicity tests with select chemicals (i.e., cadmium, DDE, fluoranthene) should generate data that can be used to better determine the relative sensitivity of survival, reproduction, and growth endpoints in tests with *C. dilutus*. In addition to evaluating the relative sensitivity of endpoints, research is also needed evaluating the ability of these laboratory endpoints to estimate responses of benthic organisms exposed in the field to chemicals in sediments.

#### A7.5 Equipment for Conducting Long-term Sediment Tests with *Chironomus dilutus*

**A7.5.1** Section describes the equipment needed to conduct the long-term sediment test with *Chironomus dilutus*. See **Table 9** for a listing of additional equipment. Suppliers and sources of equipment are listed in USEPA (2).

**A7.5.2 Emergence Traps (Fig. A7.1):** These traps are needed from Day 20 to the end of the test. These traps fit on the top of the lipless glass beakers with the narrow end up. These are 5 ounce plastic cups with 14 mesh nylon screen glued to the cup in place of the plastic bottom.

**A7.5.3 Reproduction/Oviposit Chambers (R/O; Fig. A7.2):** These R/O chambers use emergence traps and are needed once adults begin to emerge. Emergence traps are used to store adults collected daily, and are placed in a 100 × 20 mm petri dish that contains about 50 mL of overlying water. When emergence occurs, the emergence traps containing adults are removed and placed onto a petri dish. At least one male for each emergent female is added, and the R/O chamber (Fig. A7.2) is placed back into the test system or into environmental chambers maintained at the appropriate temperature and lighting. A new emergence trap is then placed on top of the lipless beaker. The R/O chambers are kept in this manner to collect the egg cases and track mortality of adults. If space is not a limiting factor, maintaining one R/O chamber per pair of organisms is encouraged. Where space is limited, many adults may be kept in a single R/O chamber, and the chambers may be double stacked (Double Stack Support Stand described in Section A7.5.8) using a larger plastic (9 ounce) cup that serves as a stand for the second level of the emergence trap. The egg cases are removed by lifting the edge of the cup enough to permit transfer with a pipet.

**A7.5.4 Adult Collector Dish (Fig. A7.1):** This is used as a tray which is placed under the emergence trap or reproduction/oviposit (R/O) chambers to provide access to adults and to facilitate transfer of the males and females as needed. This dish is constructed of large petri dishes, i.e., 100 × 20 mm glass

dishes or 100 × 20 mm plastic dishes. A 2.54 cm hole is cut in the middle and covered with 58 mesh opening nylon screen. Two slits are cut within the screen at 90 degree angles to each other. This facilitates insertion of the aspirator tube without risk of the adults flying away.

**A7.5.5 Aspirator (Fig. A7.1):** This is used to collect and transfer adults from the reproduction/oviposit (R/O) chambers. A60 cc syringe is modified by cutting the end with the tip off and adding a retainer to hold the emergence traps and reproductive/oviposit chambers. The retainer is a 7 cm in diameter plastic lid (from 270 mL wide mouth glass jar) and a large stopper is used to hold the syringe. The stopper and the lid is drilled with a hole saw of about 1 in.. The large stopper is glued to the lid. This retainer is then attached to the syringe. To facilitate transferring the animals, prepare two tubes, one about 16 cm in length and one about 4 cm (6 mm ID) and place these in a stopper (i.e., No. 5, 5.5 or 6) that has been drilled with two holes. Fasten a section (about 70 cm) of tygon tubing onto the short piece of glass and cover the tube with a piece of thin stainless steel screen (250 μm mesh) before inserting the tube into the rubber stopper. Adults should be stationary in trap to minimize the possibility of escape.

**A7.5.6 Auxiliary Male Holding Dish:** When emergence begins in the auxiliary beakers, the males are transferred individually to inverted 60 × 15 mm plastic petri dishes with several small holes (3 mm in diameter) drilled in the top. A thin layer of overlying water (about 5 mL) is added and renewed until the males are needed for the reproduction chambers. These males are held in the test system for temperature control, and can be used for up to 5 days after collection.

**A7.5.7 Egg Hatching Chamber:** Petri dishes, 60 × 15 mm plastic, are used to incubate (23°C) egg cases in about 15 mL of water. Hatch is monitored for 6-days. Hatch success is determined by subtracting the number of unhatched eggs at the end of 6 days from the initial estimate of the egg case.

#### A7.5.8 Construction of an Adult Midge Emergence Trap for Use in a “Zumwalt et al. (128)” Exposure System—

**A7.5.8.1** The construction of the emergence trap described in Fig. A7.4 is an alternate design to the trap illustrated in Fig. A7.2 and Fig. A7.3 The emergence trap described and illustrated in Fig. A7.3 is designed to fit under the exposure system described by Zumwalt et al. (128). The level of the syringes will need to be raised about 1½ in. using the threaded steel rods supporting the upper chamber of the system described by Zumwalt et al. (128).

**A7.5.8.2** Cut a 2 ½ in. plexiglass tube into 1 ¼ in. long pieces using a bandsaw or miter box and a handsaw.

**A7.5.8.3** Drill ½ in. hole in the side (middle) of the 1¼ in. ring of plexiglass. Cut a small board to fit inside of the 1¼ in. ring to help support the plexiglass when drilling. The ½ in. drill bit should be dulled to help prevent the bit from digging in too fast.

**A7.5.8.4** Drill three ¼ in. holes in the plexiglass ring spaced evenly around the ring and ¼ in. off the bottom of the ring.

A7.5.8.5 Trace around the stainless-steel screen. Cut out screen and place on top of the plexiglass ring. Use a propane-soldering torch or glass-blowing torch to heat up one end of a ¼ in. or ⅜ in. treaded steel rod (about 12 to 15 in. long so that one end remains cool). Press the hot end of the steel rod against the screen and plexiglass until the screen melts into the plexiglass (usually a few seconds). Repeat the process until the screen is completely melted to the top of the plexiglass ring.

A7.5.8.6 Bend 4-mm glass tubing (outer diameter) over a propane-soldering torch or glass-blowing torch and cut the tubing with a glass wheel or etch the tubing with a file to break. This glass tube is only to be used if beakers need to be aerated during the midge exposure. An air line is connected to each tube and a gang valve is used to regulate air flow (about 1 bubble/second). The glass tube extends below the bottom of the plexiglass tube into the surface of the overlying water. A

4-mm slot will need to be cut in the petri dish in order to slide the petri dish under the emergence trap to remove adult midges from the test beakers (Fig. A7.6). The emergence trap capped with this petri dish can then be set on a 300-mL beaker to remove the adults with an aspirator as illustrated in Fig. A7.1.

A7.5.8.7 Press ⅜ in. long pins into the three ¼ in. holes drilled in the side of the plexiglass tube. These pins make the plexiglass tube stable on the top of the beaker.

A7.5.8.8 If the plexiglass tubes are used in beakers with a notch at the top (i.e., the beakers described in Zumwalt et al. (128), a 2 cm length of ⅛ in. inner diameter latex tubing will need to be slit lengthwise and then slipped onto the bottom of the plexiglass tube. This tubing is then lined up with the notch in the beakers to prevent emerging midges from escaping. This piece of tubing is not needed if Benoit et al. (127) beakers are used (i.e., beakers with holes drilled in the side).

## A8. FOOD PREPARATION

A8.1 *Yeast, Cereal Leaves*,<sup>8</sup> and Trout Chow (YCT) for Feeding the Cultures and *Hyalella azteca*-Food should be stored at 4°C and used within two weeks of preparation; however, once prepared, YCT can be frozen until use.

### A8.1.1 *Preparation of Digested Trout Chow:*

A8.1.1.1 Preparation of trout chow or substitute flake food requires one week. Use of ⅛ in. pellets prepared in accordance with current U.S. Fish and Wildlife Service specifications.<sup>13</sup>

A8.1.1.2 Add 5.0 g of trout chow pellets to 1 L of deionized water. Mix well in a blender and pour into a 2-L separatory funnel or similar container. Digest before use by aerating continuously from the bottom of the vessel for one week at ambient laboratory temperature. Water lost due to evaporation is replaced during digestion. Because of the offensive odor usually produced during digestion, the vessel should be placed in a ventilated area.

A8.1.1.3 At the end of digestion period allow material to settle for a minimum of 1 h. Filter the supernatant through a fine-mesh screen (for example, nylon screen<sup>12</sup>, 110 mesh). Combine with equal volumes of the supernatant from ground cereal leaves<sup>8</sup> and yeast preparation (below). The supernatant can be used fresh, or frozen until used. Discard the remaining particulate material.

### A8.1.2 *Preparation of Yeast:*

A8.1.2.1 Add 5.0 g of dry yeast to 1 L of deionized water.

A8.1.2.2 Stir with a magnetic stirrer, shake vigorously by hand, or mix with a blender at low speed, until the yeast is well dispersed.

A8.1.2.3 Combine the yeast suspension immediately (do not allow to settle) with equal volumes of supernatant from the trout chow (A8.1.1) and ground cereal leaves<sup>8</sup> preparations (A8.1.3). Discard excess material.

### A8.1.3 *Preparation of Cereal Leaves:*<sup>8</sup>

A8.1.3.1 Place 5.0 g of dried, powdered, cereal<sup>8</sup> or alfalfa leaves, or rabbit pellets, in a blender. Dried, powdered, alfalfa leaves may be obtained from health food stores, and rabbit pellets are available at pet shops.

A8.1.3.2 Add 1 L of deionized water.

A8.1.3.3 Mix in a blender at high speed for 5 min, or stir overnight at medium speed on a magnetic stir plate.

A8.1.3.4 If a blender is used to suspend the material, place in a refrigerator overnight to settle. If a magnetic stirrer is used, allow to settle for 1 h. Decant the supernatant and combine with equal volumes of supernatant from trout chow and yeast preparations. Discard excess material.

### A8.1.4 *Preparation of Combined Yeast-Cerophyll-Trout Chow (YCT):*

A8.1.4.1 Thoroughly mix equal (for example, 300 mL) volumes of the three foods as previously described.

A8.1.4.2 Place aliquots of the mixture in small (50 mL to 100 mL) screw-cap plastic bottles.

A8.1.4.3 Freshly prepared food can be used immediately, or it can be frozen until needed. Thawed food is stored in the refrigerator between feedings, and is used for a maximum of two weeks. Do not store YCT frozen over three months.

A8.1.4.4 It is advisable to measure the dry weight of solids in each batch of YCT before use. The food should contain 1.7 to 1.9 g solids/L.

A8.2 *Algal Food*—Starter cultures of the green algae, *Selenastrum capricornutum* are available from American Type Culture Collection (Culture No. ATCC 22662),<sup>14</sup> or Culture Collection of Algae.<sup>15</sup>

<sup>13</sup> Suppliers of trout chow include Zeigler Bros., Inc., P.O. Box 95, Gardners, PA 17324; Glencoe Mills, 1011 Elliott, Glencoe, MN 55336, and Murray Elevators, 118 West 4800 South, Murray, UT 84107.

<sup>14</sup> American Type Culture Collection (ATCC), 12301 Parklawn Dr., Rockville MD 10852.

<sup>15</sup> Culture Collection of Algae, Botany Dept., University of Texas, Austin, TX 78712.

A8.2.1 Preparation of Algal Culture Medium for the Green Algae (194):

A8.2.1.1 Prepare stock nutrient solutions using reagent-grade chemicals as described in Table A8.1.

A8.2.1.2 Add 1 mL of each stock solution, in the order listed in Table A8.1, to about 900 mL of deionized water. Mix well after the addition of each solution. Dilute to 1 L, mix well. The final concentration of macronutrients and micronutrients in the culture medium is listed in Table A8.2.

A8.2.1.3 Immediately filter the medium through a 0.45-µm pore diameter membrane at a vacuum of not more than 380 mm (15 in.) of mercury, or at a pressure of not more than one-half atmosphere (8 psi). Wash the filter with 500 mL of deionized water before use.

A8.2.1.4 If the filtration is carried out with sterile apparatus, filtered medium can be used immediately, and no further sterilization steps are required before the inoculation of the medium. The medium can also be sterilized by autoclaving after it is placed in the culture vessels. Unused sterile medium should not be stored more than one week before use, because there may be substantial loss of water by evaporation.

A8.2.2 Algal Cultures— Two types of algal cultures are maintained: (1) stock cultures, and (2) “food” cultures.

A8.2.2.1 Establishing and Maintaining Stock Cultures of Algae:

(1) Upon receipt of the “starter” culture of *S. capricornutum* (usually about 10 mL), a stock culture is started by aseptically transferring 1 mL to each of several 250-mL culture flasks containing 100 mL algal culture medium (prepared as

TABLE A8.2 Final Concentration of Macronutrients and Micronutrients in the Algal Culture Medium

Macronutrient	Concentration, mg/L	Element	Concentration, mg/L
NaNO <sub>3</sub>	25.5	N	4.20
MgCl <sub>2</sub> ·6H <sub>2</sub> O	12.2	Mg	2.90
CaCl <sub>2</sub> ·2H <sub>2</sub> O	4.41	Ca	1.20
MgSO <sub>4</sub> ·7H <sub>2</sub> O	14.7	S	1.91
K <sub>2</sub> HPO <sub>4</sub>	1.04	P	0.186
NaHCO <sub>3</sub>	15.0	Na	11.0
		K	0.469
		C	2.14

Micronutrient	Concentration, µg/L	Element	Concentration, µg/L
H <sub>3</sub> BO <sub>3</sub>	185	B	32.5
MnCl <sub>2</sub> ·4H <sub>2</sub> O	416	Mn	115
ZnCl <sub>2</sub>	3.27	Zn	1.57
CoCl <sub>2</sub> ·6H <sub>2</sub> O	1.43	Co	0.354
CuCl <sub>2</sub> ·2H <sub>2</sub> O	0.012	Cu	0.004
Na <sub>2</sub> MoO <sub>4</sub> ·2H <sub>2</sub> O	7.26	Mo	2.88
FeCl <sub>3</sub> ·6H <sub>2</sub> O	160	Fe	33.1
Na <sub>2</sub> EDTA·2H <sub>2</sub> O	300	...	...
Na <sub>2</sub> SeO <sub>4</sub>	2.39	Se	0.91

previously described). The remainder of the starter culture can be held in reserve for up to six months in a refrigerator (in the dark) at 4°C.

(2) The stock cultures are used as a source of algae to initiate “food” cultures. The volume of stock culture maintained at any one time will depend on the amount of algal food required for culture. Stock culture volume may be rapidly “scaled up” to several litres using 4-L serum bottles or similar vessels containing 3 L of growth medium.

(3) Culture temperature is not critical. Stock cultures may be maintained at 25°C in environmental chambers with cultures of other organisms if the illumination is adequate (continuous “cool-white” fluorescent lighting of about 4300 lx).

(4) The cultures are mixed twice daily by hand.

(5) Stock cultures can be held in the refrigerator until used to start “food” cultures, or can be transferred to a new medium weekly. One to three millilitres of 7-day old algal stock culture, containing about 1.5 × 10<sup>6</sup> cells/mL are transferred to each 100 mL of fresh culture medium. The inoculum should provide an initial cell density of about 10 000 to 30 000 cells/mL in the new stock cultures. Aseptic techniques should be used in maintaining the stock algal cultures, and care should be exercised to avoid contamination by other microorganisms.

(6) Stock cultures should be examined microscopically weekly at transfer for microbial contamination. Reserve quantities of culture organisms can be maintained for 6 to 12 months if stored in the dark at 4°C. It is advisable to prepare new stock cultures from “starter” cultures obtained from established outside sources of organisms every four to six months.

A8.2.2.2 Establishing and Maintaining “*S. capricornutum* food” Cultures:

(1) “*S. capricornutum* food” cultures are started 7 days before use. About 20 mL of 7-day-old algal stock culture (described in the previous paragraph), containing 1.5 × 10<sup>6</sup> cells/mL are added to each litre of fresh algal culture medium (for example, 3 L of medium in a 4-L bottle or 18 L in a 20-L bottle). The inoculum should provide an initial cell density of

TABLE A8.1 Nutrient Stock Solutions for Maintaining Algal Stock Cultures

Stock Solution	Compound	Amount Dissolved in 500 mL of Deionized Water
1.	Macronutrients	
A.	MgCl <sub>2</sub> ·6H <sub>2</sub> O	6.08 g
	CaCl <sub>2</sub> ·2H <sub>2</sub> O	2.20 g
	NaNO <sub>3</sub>	12.75 g
B.	MgSO <sub>4</sub> ·7H <sub>2</sub> O	7.35 g
C.	K <sub>2</sub> HPO <sub>4</sub>	0.522 g
D.	NaHCO <sub>3</sub>	7.50 g
2.	Micronutrients	
	H <sub>3</sub> BO <sub>3</sub>	92.8 mg
	MnCl <sub>2</sub> ·4H <sub>2</sub> O	208.0 mg
	ZnCl <sub>2</sub>	1.64 mg <sup>A</sup>
	FeCl <sub>3</sub> ·6H <sub>2</sub> O	79.9 mg
	CoCl <sub>2</sub> ·6H <sub>2</sub> O	0.714 mg <sup>B</sup>
	Na <sub>2</sub> MoO <sub>4</sub> ·2H <sub>2</sub> O	3.63 mg <sup>C</sup>
	CuCl <sub>2</sub> ·2H <sub>2</sub> O	0.006 mg <sup>D</sup>
	Na <sub>2</sub> EDTA·2H <sub>2</sub> O	150.0 mg
	Na <sub>2</sub> SeO <sub>4</sub>	1.196 mg <sup>E</sup>

<sup>A</sup> ZnCl<sub>2</sub>—Weigh 164 mg and dilute to 100 mL. Add 1 mL of this solution to micronutrient stock.

<sup>B</sup> CoCl<sub>2</sub>·6H<sub>2</sub>O—Weigh 71.4 mg and dilute to 100 mL. Add 1 mL of this solution to micronutrient stock.

<sup>C</sup> Na<sub>2</sub>MoO<sub>4</sub>·2H<sub>2</sub>O—Weigh 36.6 mg and dilute to 10 mL. Add 1 mL of this solution to micronutrient stock.

<sup>D</sup> CuCl<sub>2</sub>·2H<sub>2</sub>O—Weigh 60.0 mg and dilute to 1000 mL. Take 1 mL of this solution and dilute to 10 mL. Take 1 mL of the second dilution and add to micronutrient stock.

<sup>E</sup> Na<sub>2</sub>SeO<sub>4</sub>—Weigh 119.6 mg and dilute to 100 mL. Add 1 mL of this solution to micronutrient stock.



about 30 000 cells/mL. Aseptic techniques should be used in preparing and maintaining the cultures and care should be exercised to avoid contamination by other microorganisms. However, sterility of food cultures is not as critical as in stock cultures because the food cultures are used in 7 to 10 days. A one-month supply of algal food can be grown at one time and stored in the refrigerator.

(2) Food cultures may be maintained at 25°C in environmental chambers with the algal stock cultures or cultures of other organisms if the illumination is adequate (continuous “cool-white” fluorescent lighting of about 4300 lx).

(3) Cultures are mixed continuously on a magnetic stir plate (with a medium size stir bar), in a moderately aerated separatory funnel, or are manually mixed twice daily. If the cultures are placed on a magnetic stir plate, heat generated by the stirrer might elevate the culture temperature several degrees. Caution should be taken to prevent the culture temperature from rising more than 2 to 3°C.

#### A8.2.2.3 *Preparing Algal Concentrate of S. capricornutum for Use as Food:*

(1) An algal concentrate of *S. capricornutum* containing  $3.0$  to  $3.5 \times 10^7$  cells/mL is prepared from food cultures by centrifuging the algae with a plankton or bucket-type centrifuge, or by allowing the cultures to settle in a refrigerator for at least three weeks and siphoning off the supernatant.

(2) The cell density (cells/millilitre) in the concentrate is measured with an electronic particle counter, microscope and hemocytometer, fluorometer, or spectrophotometer and used to determine the dilution (or further concentration) required to achieve a final cell count of  $3.0$  to  $3.5 \times 10^7$  cells/mL.

(3) Assuming a cell density of about  $1.5 \times 10^6$  cells/mL in the algal food cultures at 7 days and 100 % recovery in the concentration process, a 3-L culture at 7 to 10 days will provide  $4.5 \times 10^9$  algal cells.

(4) Algal concentrate can be stored in the refrigerator for one month.

#### A8.2.2.4 *Cell Counts:*

(1) Several types of automatic electronic and optical particle counters are available to rapidly count cell number (cells/millilitre) and mean cell volume (MCV;  $\mu\text{m}^3/\text{cell}$ ). The Coulter Counter is widely used and is discussed in detail in (392). When the Coulter Counter is used, an aliquot (usually 1 mL) of the test culture is diluted 10 times to 20 times with a 1 % sodium chloride electrolyte solution to facilitate counting. The resulting dilution is counted using an aperture tube with a 100- $\mu\text{m}$  diameter aperture. Each cell (particle) passing through the aperture causes a voltage drop proportional to its volume.

Depending on the model, the instrument stores the information on the number of particles and the volume of each, and calculates the mean cell volume. The following procedure is used:

(a) Mix the algal culture in the flask thoroughly by swirling the contents of the flask about six times in a clockwise direction, and then six times in the reverse direction; repeat the two-step process at least once.

(b) At the end of the mixing process, stop the motion of the liquid in the flask with a strong brief reverse mixing action, and quickly remove 1 mL of cell culture from the flask with a sterile pipet.

(c) Place the aliquot in a counting beaker, and add 9 mL (or 19 mL) of electrolyte solution.

(d) Determine the cell density (and MCV, if desired).

(2) Manual microscope counting methods for cell counts are determined using a Sedgwick-Rafter, Palmer-Maloney, hemocytometer, inverted microscope, or similar methods. For details on microscope counting methods see Ref 393. Whenever feasible, 400 cells/replicate are counted to obtain  $\pm 10$  % precision at the 95 % confidence level. This method has the advantage of allowing for the direct examination of the condition of the cells.

A8.3 *Fish Food Flakes*<sup>9</sup> (or other fish flake food) for Culturing and Testing *C. dilutus*-Food should be stored at 4°C and used within two weeks of preparation or can be frozen until use. If it is frozen, it should be reblended, once thawed, to break up any clumps.

A8.3.1 Blend the fish food flakes<sup>9</sup> in deionized water for 1 to 3 min or until very finely ground.

A8.3.2 Filter slurry through a No. 110 nylon screen<sup>12</sup> to remove large particles. Place aliquot of food in 100 to 500-mL screw-top plastic bottles. It is desirable to determine dry weight of solids in each batch of food before use. Food should be held for no longer than two weeks at 4°C. Food can be frozen before use, but it is desirable to use fresh food.

A8.3.3 Fish food flakes<sup>9</sup> is added to each culture chamber to provide about 0.04 mg of dry solids/mL of culture water. A stock suspension of the solids is prepared in culture water such that a total volume of 5.0 mL of food suspension is added daily to each culture chamber. For example, if a culture chamber volume is 8 L, 300 mg of food would be added daily by adding 5 mL of a 56-g/L stock suspension (194).

A8.3.4 In a sediment test, fish food flakes<sup>9</sup> (4 g/L) is added at 1.5 mL daily to each test chamber.

**A9. FEEDING RATE FOR THE 10-DAY SEDIMENT TOXICITY TEST METHOD WITH  
*Chironomus dilutus***

A9.1 A study was performed in response to questions raised during the ASTM balloting process for the *Chironomus dilutus* (formerly known as *C. tentans*; Shobanov et al. 1999. (1) test method for assaying sediment toxicity described in Table 18. The 10-day test as originally described by Ankley et al (5), suggested that each treatment of ten organisms be fed 1.0 mL/day of a fish food flake<sup>9</sup> solution (total of 4 mg dry weight fish food flakes<sup>9</sup>/beaker/day). This feeding rate typically results in acceptable survival ( $\geq 70\%$ ) and final dry weight ( $>0.6$  mg/organism) in clean control sediments. However, subsequent longer term tests with the midge indicated that the 1.0 mL/day feeding rate, when extended over the life cycle of the organism (about 28 days), resulted in suboptimal emergence and, hence, decreased reproduction. However, a slightly increased feeding rate of 1.5 mL fish food flakes<sup>9</sup>/day (6 mg dry weight fish food flakes<sup>9</sup>/beaker/day) resulted in excellent survival and emergence. Thus, feeding rate used during the 10-day test was increased from 1.0 to 1.5 mL fish food flakes<sup>9</sup>/day. This results in consistent methods between the short-term (10-day) and long-term (35-day) tests with *C. dilutus*, and also would help ensure that organisms in the 10-day test would be in good condition at test completion. This latter outcome would result in a lower percentage of “failed” tests in terms of reduced control survival or growth.

A9.2 The specific objectives of this study were to evaluate whether the two different feeding rates would: (1) result in any differences in interpretation of test results between control versus contaminated (toxic) sediments, and (2) whether the two feeding rates might cause differential bioavailability of contaminants in test sediments, as determined by pore-water chemical concentrations. The study used the methods described in Table 18. Ten-day toxicity tests were conducted with *C. dilutus* using sediments from West Bearskin Lake (control), the Keweenaw Waterway (a moderately toxic sediment contaminated by copper), and the Little Scioto River (a moderately toxic sediment contaminated by creosote, with elevated ammonia concentrations). Tests with each sediment were conducted at both feeding rates, with four replicates for biology and four replicates for chemistry at each sediment/feeding

treatment combination. At the end of 10 days, *C. dilutus* survival and growth (dry weight), and pore-water concentrations of copper (Keweenaw) or ammonia (Little Scioto) were determined. Pore-water concentrations were also measured at the start of the tests. Differences in survival and growth among the various treatment combinations were evaluated using *t* tests.

A9.3 Neither temperature nor pH of the three test sediments was differentially affected by feeding rate (Table A9.1). Dissolved oxygen concentrations were slightly lower at the higher feeding rate; however, all levels remained acceptable, even in the Little Scioto sediment, which has a relatively large biological oxygen demand. The feeding rate did not differentially affect pore-water concentrations of copper (Keweenaw) or ammonia (Little Scioto; Table A9.2). Regardless of the feeding rate, pore-water copper concentrations increased by about three-fold and ammonia concentrations decreased by about 50%. Trends in concentrations of both contaminants over the 10-day test were similar to those described by Ankley et al. (5).

A9.4 For any given sediment, the feeding rate did not significantly affect survival (Table A9.3). In the case of growth, organisms receiving the 1.5 mL of fish food flakes<sup>9</sup>/day tended to be larger than those at the lower feeding rate; this was significant both for the West Bearskin and Keweenaw sediments. An important point to note is that the mean dry weight of 0.54 mg/organisms at the lower feeding rate in the control sediment was slightly below the 0.6 mg/organism criterion for defining an acceptable test with *C. dilutus*. The 1.5 mL/day feeding rate resulted in an acceptable weight gain which indicates the higher feeding rate would reduce the frequency of failed tests due to low control weight.

A9.5 Feeding rate had no influence with respect to classifying the Keweenaw Waterway or Little Scioto sediments as toxic relative to controls (Table A9.3). Regardless of the feeding rate, *C. dilutus* growth in the Keweenaw sample, and survival and growth in the Little Scioto sediment were significantly decreased to a relatively similar degree.

**TABLE A9.1 Summary of Overlying Water Chemistry from *Chironomus dilutus* Toxicity Tests Conducted at Two Different Feeding Rates**

NOTE 1—Data indicated are the mean (range) based on determinations made on test days 7, 8, and 9.

Sediment	Feeding Rate <sup>A</sup>	Measurement		
		Temperature (°C)	Dissolved oxygen (mg/L)	pH
West Bearskin	1.0	22.8 (22.7 to 22.8)	5.36 (5.23 to 5.60)	7.11 (7.07 to 7.15)
West Bearskin	1.5	22.7 (NR) <sup>B</sup>	4.71 (4.31 to 5.20)	7.10 (7.07 to 7.13)
Keweenaw	1.0	22.7 (NR)	5.37 (5.27 to 5.47)	7.38 (7.32 to 7.43)
Keweenaw	1.5	22.7 (22.7 to 22.8)	4.65 (4.48 to 4.78)	7.30 (7.26 to 7.39)
Little Scioto	1.0	22.6 (22.6 to 22.7)	4.64 (4.40 to 4.93)	7.34 (7.26 to 7.43)
Little Scioto	1.5	22.7 (22.7 to 22.8)	4.25 (4.21 to 4.32)	7.28 (7.22 to 7.35)

<sup>A</sup> Millilitres fish food flakes<sup>11</sup>/day.

<sup>B</sup> NR = no variation noted.

**TABLE A9.2 Summary of Pore-Water Chemistry from *C. dilutus* Tests Conducted at Two Different Feeding Rates**

NOTE 1—Data are presented as mean (standard deviation),  $N = 4$ .

Sediment	Feeding Rate <sup>A</sup>	T <sub>0</sub>	Copper T <sub>10</sub>	T <sub>0</sub>	Ammonia T <sub>10</sub>
Keweenaw	1.0	74.1 (4.62)	233 (10.7)	...	...
Keweenaw	1.5		267 (13.8)	...	...
Little Scioto	1.0	...	...	10.9	5.8 (0.4)
Little Scioto	1.5	...	...	(0.3)	6.1 (0.3)

<sup>A</sup> Millilitres fish food flakes<sup>11</sup>/day.

A9.6 In summary, this study supports the concept of increasing the feeding rate for the *C. dilutus* 10-day sediment test from 1.0 to 1.5 mL fish food flakes<sup>9</sup>/day. With the exception of a biologically insignificant decrease in dissolved oxygen, the change in feeding rate did not differentially affect overlying or pore-water chemistry, and also did not affect interpretation of

**TABLE A9.3 Survival and Growth (Dry Weight) of *C. dilutus* from Toxicity Tests Conducted at Two Different Feeding Rates<sup>A</sup>**

Sediment	Feeding Rate <sup>B</sup>	Survival (%)	Growth (mg/organisms)
West Bearskin	1.0	97.5 (5.0)	0.54 (0.021)
West Bearskin	1.5	97.5 (5.0)	0.78 (0.048)#
Keweenaw	1.0	75.0 (12.9)	0.08 (0.015)*
Keweenaw	1.5	90.0 (14.1)	0.13 (0.022)*#
Little Scioto	1.0	42.5 (12.6)*	0.22 (0.043)*
Little Scioto	1.5	47.5 (18.9)*	0.26 (0.031)*

<sup>A</sup> Data are presented as mean (standard deviation),  $N = 4$ . An asterisk (\*) indicates a significant ( $p < 0.05$ ) difference in response between the contaminated sediment and its corresponding control (that is, at the same feeding rate). A pound sign (#) indicates a significant difference between the two feeding rates for a given sediment.

<sup>B</sup> Millilitres fish food flakes<sup>11</sup> /day.

toxicity of the test sediments.

## REFERENCES

- (1) Shobanov NA, Kiknadze II, Bulter MG, "Palaearctic and Nearctic Chironomus (*Camptochironomus*) *tentans* (Fabricus) are different species (Diptera, Chironomidae)." *Ent Scand*, 1999 30: 311-322.
- (2) *Methods for Measuring the Toxicity and Bioaccumulation of Sediment-Associated Contaminants With Freshwater Invertebrates, Second Edition* EPA 600/R-99/064, U.S. Environmental Protection Agency, Duluth, MN, 2000.
- (3) *Methods for Measuring the Acute Toxicity of Effluents and Receiving Waters to Freshwater and Marine Organisms*, Fourth edition, EPA 600/4-90/027F, U.S. Environmental Protection Agency, Cincinnati, OH, 1993a.
- (4) *Procedures for Assessing the Toxicity and Bioaccumulation of Sediment-Associated Contaminants With Marine Invertebrates*, EPA 600/R-94/025, U.S. Environmental Protection Agency, Duluth, MN, 1994b.
- (5) Ankley, G. T., Benoit, D. A., Hoke, R. A., Leonard, E. N., West, C. W., Phipps, G. L., Mattson, V. R., and Anderson, L. A., "Development and Evaluation of Test Methods for Benthic Invertebrates and Sediments: Effects of Flow Rate and Feeding on Water Quality and Exposure Conditions," *Archives of Environmental Contamination and Toxicology*, Vol 25, 1993, pp. 12-19.
- (6) Phipps, G. L., Ankley, G. T., Benoit, D. A., and Mattson, V. R., "Use of the Aquatic Oligochaete *Lumbriculus variegatus* for Assessing the Toxicity and Bioaccumulation of Sediment-Associated Contaminants," *Environmental Toxicology and Chemistry*, Vol 12, 1993, pp. 269-274.
- (7) Brooke, L. T., Call, D. J., Ankley, G. T., Benoit, D. A., West, C. W., and Hoke, R. A., "A Short-Term Method for Estimating the Toxicity of Solid Phase Sediment to the Amphipod *Hyaella azteca*," EPA Region 5, Chicago, IL, 1993.
- (8) Call, D. J., Brooke, L. T., Ankley, G. T., Benoit, D. A., West, C. W., and Hoke, R. A., "A Short-Term Method for Estimating the Toxicity of Solid Phase Sediment to *Chironomus tentans*," EPA Region 5, Chicago, IL, 1993a.
- (9) Call, D. J., Brooke, L. T., Ankley, G. T., Benoit, D. A., Phipps, G. L., West, C. W., and Hoke, R. A., "A Method for Determining Bioaccumulation of Sediment-Associated Contaminants Using the Oligochaete, *Lumbriculus variegatus*," EPA Region 5, Chicago, IL, 1993b.
- (10) Ankley, G., and Thomas, N., Interstitial Water Toxicity Identification Evaluation Approach, *Sediment classification methods compendium*, EPA 823-R-92-006, Washington, DC, 1992, pp. 5-1 to 5-14.
- (11) Ankley, G. T., Schubauer-Berigan, M. K., and Dierkes, J. R., "Predicting the Toxicity of Bulk Sediments to Aquatic Organisms Using Aqueous Test Fractions: Pore Water Versus Elutriate," *Environmental Toxicology and Chemistry*, Vol 10, 1991b, pp. 1359-1366.
- (12) West, C. W., Mattson, V. R., Leonard, E. N., Phipps, G. L., and Ankley, G. T., "Comparison of the Relative Sensitivity of Three Benthic Invertebrates to Copper Contaminated Sediments from the Keweenaw Waterway," *Hydrobiologia*, Vol 262, 1993, pp. 57-63.
- (13) Schubauer-Berigan, M. K., Dierkes, J. R., Monson, P. D., and Ankley, G. T., "The pH-dependent toxicity of Cd, Cu, Ni, Pb and Zn to *Ceriodaphnia dubia*, *Pimephales promelas*, *Hyaella azteca*, and *Lumbriculus variegatus*," *Environmental Toxicology and Chemistry*, Vol 12, 1993, pp. 1261-1266.
- (14) Burton, G. A., Jr., and Ingersoll, C. G., "Evaluating the Toxicity of Sediments," *The Assessment of Contaminated Great Lakes Sediment*, EPA 905-B94-002, Chicago, IL, 1994.
- (15) Ingersoll, C. G., Buckler, D. R., Crecelius, E. A., and La Point, T. W., *U.S. Fish and Wildlife Service and Battelle final report for the USEPA GLNPO Assessment and Remediation of Contaminated Sediment (ARCS) Project: Biological Assessment of Contaminated Great Lakes Sediment*, EPA 905-R93-006, Chicago, IL, 1993.
- (16) Ingersoll, C. G., Brunson, E. L., Canfield, T. J., Dwyer, F. J., Haverland, P. S., Henke, C. E., Kemble, N. E., and Mount, D. R., "Calculation of Sediment Effect Concentrations for *Hyaella azteca* and *Chironomus riparius*," *National Biological Service Final Report for the U.S. Environmental Protection Agency GLNPO Assessment and Remediation of Contaminated Sediment (ARCS) Project*, Chicago, IL, 1994.
- (17) Burton G.A., Ingersoll, C.G., Burnett, L.C., Henry, M., Hinman, M.L., Klaine, S.J., Landrum, P.F., Ross, P., and Tuchman, M. A comparison of sediment toxicity test methods at three Great Lakes Areas of Concern. *J. Great Lakes Res.* 22:495-511, 1996a.
- (18) Kemble, N. E., Brumbaugh, W. G., Brunson, E. L., Dwyer, F. J., Ingersoll, C. G., Monda, D. P., and Woodward, D. F., "Toxicity of Metal-contaminated Sediments from the Upper Clark Fork River, MT to Aquatic Invertebrates in Laboratory Exposures," *Environmental Toxicology and Chemistry*, Vol 13, pp. 1895-1997, 1994
- (19) Phipps, G. L., Mattson, V. R., and Ankley, G. T., "The Relative

- Sensitivity of Three Benthic Test Species to 10 Chemicals,” *Archives of Environmental Contamination and Toxicology* 28: 281-286, 1995.
- Suedel, B. C., Rodgers, J. H., and Clifford, P. A., “Bioavailability of Fluoranthene in Freshwater Sediment Toxicity Tests,” *Environmental Toxicology and Chemistry*, Vol 28, 1995, pp. 281-286.
- (20) Aquire. *Aquatic Toxicity Information Retrieval Database and Technical Support Document*, USEPA Environmental Research Laboratory, Duluth, MN, 1992.
- (21) Jones, R.A. and G.F. Lee, Toxicity of U.S. waterway sediments with particular reference to the New York Harbor area. In: *Chemical and biological Characterization of sludges, sediments, dredge spoils, and drilling muds* (ed. J.J. Lichtenburg, F.A. Winter, C.I. Weber, and L. Fradkin). STP 976. American Society for Testing and Materials: West Conshohocken, P.A. pp. 403-417, 1998.
- (22) Ankley, G.T., Katko, A., and Arthur, J.W. Identification of ammonia as an important sediment-associated toxicant in the lower Fox River and Green Bay Wisconsin, *Environ. Toxicol. Chem.* 9:313-322, 1990.
- (23) Schubauer-Berigan, M.K., and Ankley, G.T., The contribution of ammonia, metals and nonpolar organic compounds to the toxicity of sediment interstitial water from an Illinois River tributary, *Environ. Toxicol. Chem.* 10: 925-939, 1991.
- (24) Schubauer-Berigan, M.K., Monson, P.D., West, C.W., and Ankley, G.T., Influence of pH on the toxicity of ammonia to *Chironomus tentans* and *Lumbriculus variegatus*. *Environ. Toxicol. Chem.* 14:713-717, 1995.
- (25) Ankley, G.T., Schubauer-Berigan, M.K. and Monson P.D. Influence of pH and hardness on the toxicity of ammonia to the amphipod *Hyalella azteca*. *Can. J. Fish Aquat. Sci.* 52:2078-2083, 1995.
- (26) Borgmann, U. and Borgmann, A.I. The control of ammonia toxicity to *Hyalella azteca* by sodium potassium, and pH. *Environ. Pollut.* 95:325-331, 1997.
- (27) Whiteman, F.W., Ankley, G.T., Dahl, M.D., Rau, D.M. and Balcer, M.D. Evaluation of interstitial water as a route of exposure to ammonia in sediment tests with macroinvertebrates. *Environ. Toxicol. Chem.* 15:794-801, 1996.
- (28) Ankley, G.T. and Schubauer-Berigan, M.K. Background and overview of current sediment toxicity identification procedures. *J. Aquat. Ecosystem Health.* 4:133-149, 1995.
- (29) Besser, J.M., Ingersoll, C.G., Leonard, E., and Mount, D.R. Effect of zeolite on toxicity of ammonia freshwater sediments: Implications for sediment toxicity identification evaluation procedures. *Environ. Toxicol. Chem.* 17:2310-2317, 1998.
- (30) Craig, G. R., “Bioassessment of Sediments: Review of Previous Methods and Recommendations for Future Test Protocols,” IEC Beak Consultants, Ltd., Mississauga, Ontario, 1984.
- (31) Williams, L. G., Chapman, P. M., and Ginn, T. C., “A Comparative Evaluation of Marine Sediment Toxicity Using Bacterial Luminescence, Oyster Embryo and Amphipod Sediment Bioassays,” *Marine Environmental Research*, Vol 19, 1986a, pp. 225-249.
- (32) Long, E. R., Buchman, M. F., Bay, S. M., Breteler, R. J., Carr, R. S., Chapman, P. M., Hose, J. E., Lissner, A. L., Scott, J., and Wolfe, D. A., “Comparative Evaluation of Five Toxicity Tests With Sediments from San Francisco Bay and Tomales Bay, California,” *Environmental Toxicology and Chemistry*, Vol 9, 1990, pp. 1193-1214.
- (33) Ingersoll, C. G., Dwyer, F. J., and May, T. W., “Toxicity of Inorganic and Organic Selenium to *Daphnia magna* (Cladocera) and *Chironomus riparius* (Diptera),” *Environmental Toxicology and Chemistry*, Vol 9, 1990, pp. 1171-1181.
- (34) Reish, D. J., “The Use of Toxicity Testing in Marine Environmental Research,” Chapter 10, Soule, D. F., and Kleppel, G. S. (eds.), *Marine organisms as indicators*. Springer-Verlag, New York. pp. 213-245, 1988.
- (35) Harkey, G. A., Lydy, M. J., Kukkonen, J., and Landrum, P. F., “Feeding Selectivity and Assimilation of PAH and PCB in *Diporeia* spp.” *Environmental Toxicology and Chemistry*, Vol 13, 1995, pp. 1445-1455. Harkey, G. A., Landrum, P. F., and Klaine, S. J., “Preliminary Studies on the Effect of Feeding During Whole-sediment Bioassays Using *Chironomus riparius* Larvae,” *Chemosphere*, Vol 28, 1994, pp. 597-606.
- (36) Landrum, P. F., “Bioavailability and Toxicokinetics of Polycyclic Aromatic Hydrocarbons Sorbed to Sediments for the Amphipod *Pontoporeia hoyi*,” *Environmental Science and Technology*, Vol 23, 1989, pp. 588-595.
- (37) Boese, B. L., Lee II, H., Specht, D. T., Randall, R. C., and Winsor, M. H., “Comparison of Aqueous and Solid-Phase Uptake for Hexachlorobenzene in the Tellinid Clam *Macoma nasuta* (Conrad): A Mass Balance Approach,” *Environmental Toxicology and Chemistry*, Vol 9, 1990, pp. 221-231.
- (38) Knezovich, J. P., Harrison, F. L., and Wilhelm, R. G., “The Bioavailability of Sediment-sorbed Organic Chemicals: A Review,” *Water, Air, and Soil Pollution*, Vol 32, 1987, pp. 233-245.
- (39) Di Toro, D. M., Mahony, J. H., Hansen, D. J., Scott, K. J., Hicks, M. B., Mayr, S. M., and Redmond, M., “Toxicity of Cadmium in Sediments: The Role of Acid Volatile Sulfides,” *Environmental Toxicology and Chemistry*, Vol 9, 1990, pp. 1487-1502.
- (40) Di Toro, D. M., Zarba, C. S., Hansen, D. J., Berry, W. J., Swartz, R. C., Cowan, C. E., Pavlou, S. P., Allen, H. E., Thomas, N. A., and Paquin, P. R., “Technical Basis for Establishing Sediment Quality Criteria for Nonionic Organic Chemicals Using Equilibrium Partitioning,” *Environmental Toxicology and Chemistry*, Vol 10, 1991, pp. 1541-1583.
- (41) Giesy, J. P., Graney, R. L., Newsted, J. L., Rosiu, C. J., Benda, A., Kreis Jr., R. G., and Horvath, F. J., “Comparison of Three Sediment Bioassay Methods Using Detroit River Sediments,” *Environmental Toxicology and Chemistry*, Vol 7, 1988, pp. 483-498.
- (42) Wentsel, R., McIntosh, A., and Atchison, G., “Sublethal Effects of Heavy Metal Contaminated Sediment on Midge Larvae (*Chironomus tentans*),” *Hydrobiologia*, Vol 56, 1977a, pp. 153-156.
- (43) Wentsel, R., McIntosh, A., and Anderson, V., “Sediment Contamination and Benthic Invertebrate Distribution in a Metal-impacted Lake,” *Environmental Pollution*, Vol 14, 1977b, pp. 187-193.
- (44) Wentsel, R., McIntosh, A., and McCafferty, P. C., “Emergence of the Midge *Chironomus tentans* When Exposed to Heavy Metal Contaminated Sediments,” *Hydrobiologia*, Vol 57, 1978, pp. 195-196.
- (45) Canfield, T. J., Kemble, N. E., Brumbaugh, W. G., Dwyer, F. J., Ingersoll, C. G., and Fairchild, J. F., “Use of Benthic Invertebrate Community Structure and the Sediment Quality Triad to Evaluate Metal-contaminated Sediment in the Upper Clark Fork River, Montana,” *Environmental Toxicology and Chemistry*, Vol 13, 1994, pp. 1999-2012.
- (46) Canfield T.J., Dwyer, F.J., Fairchild, J.F., Haverland P.S., Ingersoll, C.G., Kemble N.E., Mount D.R., La Point T.W., Burton, G.A., Swift, M.C. Assessing contamination in Great Lakes sediments using benthic invertebrate communities and the sediment quality triad approach, *J. Great Lakes Res.* 22:565-583, 1996.
- (47) Canfield T.J., Brunson, E.L., Dwyer, F.J., Ingersoll, C.G., Kemble N.E. Assessing sediments from the upper Mississippi river navigational pools using a benthic invertebrate community evaluation and the sediment quality triad approach. *Arch. Environ. Contam. Toxicol.* 35: 202-212, 1998.
- (48) Swartz, R. C., Cole, F. A., Lamberson, J. O., Ferraro, S. P., Schults, D. W., DeBen, W. A., Lee II, H., and Ozretich, R. J., “Sediment Toxicity, Contamination and Amphipod Abundance at a DDT and Dieldrin-contaminated Site in San Francisco Bay,” *Environmental Toxicology and Chemistry*, Vol 13, 1994, pp. 949-962. Schlekot, C. E., McGee, B. L., Boward, D. M., Reinharz, E., Velinsky, D. J., and Wade, T. L. 1994. Tidal River Sediments in the Washington, D.C. Area. III. Biological Effects Associated With Sediment Contamination. *Estuaries* Vol 17, 1994, pp 334-344: McGee, B. L., Schlekot, C. E., Boward, D. M., and Wade, T. L. 1994. Sediment Contamination an Biological Effects in A Chesapeake Bay Marina. *Ecotoxicology* 3: McGee, B. L., Schlekot, C. E., and Reinharz, E. 1993. Assessing Sublethal Levels of Sediment Contamination Using the Estuarine

- Amphipod *Leptocheirus plumulosus*. *Environmental Toxicology and Chemistry*, Vol 12, pp. 577-587.
- (49) Rees, M. and Crawley, M.J. Growth, reproduction and population dynamics. *Functional Ecology*, 3:645-653, 1989.
- (50) Derr, S.K. and M.J. Zabik, Biologically active compounds in the aquatic environment; the effect of DDT on the egg viability of *C. tentans*. *Bull Environ. Contam. Toxicol.* 6: 366-369, 1972.
- (51) Wentzel, R., McIntosh, A. and McCafferty, P.C. Emergence of the midge *Chironomus tentans* when exposed to heavy metal contaminated sediments. *Hydrobiologia* 57: 195-196, 1978.
- (52) Williams, K.A., Green, D.J., Pascoe, D., and D.E. Gower. Effect of cadmium on oviposition and egg viability in *Chironomus riparius* (Diptera: Chironomidae). *Bull. Environ. Contam. Toxicol.* 38: 86-90, 1987.
- (53) Postma, J.F., van Kleunen, A., and W. Admiraal, Alterations in life-history traits of *Chironomus riparius* (Diptera) obtained from metal contaminated rivers, *Arch. Environ. Contam. Toxicol.* 29: 469-475, 1995.
- (54) Sibley, P.K., Ankley, G.T., Cotter, A.M., and Leonard, E.N., Predicting chronic toxicity of sediments spiked with zinc: An evaluation of the acid volatile sulfide (AVS) model using a life-cycle test with the midge *Chironomus tentans*. *Environ. Toxicol. Chem.* 15:2102-2112, 1996.
- (55) Sibley, P.K., Benoit, D.A., and Ankley, G.T., the significance of growth in *Chironomus tentans* sediment toxicity tests: Relationship to reproduction and demographic endpoints. *Environ. Toxicol. Chem.* 16: 336-345, 1997a
- (56) Ingersoll, C.G., Brunson, E.L., F.J., Hardesty, D.K., and Kemble, N.E. Use of sublethal endpoints in sediment toxicity test with the amphipod *Hyaella azteca* *Environ. Toxicol. Chem.* 17: 1508-1523, 1998.
- (57) DeWitt, T. H., Ditsworth, G. R., and Swartz, R. C., "Effects of Natural Sediment Features on the Phoxocephalid Amphipod, *Rhepoxynius abronius*: Implications for Sediment Toxicity Bioassays. *Marine Environmental Research*, Vol 25, 1988, pp. 99-124.
- (58) Ankley, G. T., Benoit, D. A., Balough, J. C., Reynoldson, T. B., Day, K. E., and Hoke, R. A., "Evaluation of Potential Confounding Factors in Sediment Toxicity Tests with Three Freshwater Benthic Invertebrates," *Environmental Toxicology and Chemistry*, Vol 13, 1994, pp. 627-635.
- (59) Walsh, G. E., Weber, D. E., Simon, T. L., and Brashers, L. K., "Toxicity Tests of Effluents With Marsh Plants in Water and Sediment," *Environmental Toxicology and Chemistry*, Vol 10, 1991, pp. 517-525.
- (60) Suedel, B. C., and Rodgers Jr., J. H., "Development of Formulated Reference Sediments for Freshwater and Estuarine Sediment Toxicity Testing," *Environmental Toxicology and Chemistry*, Vol 13, pp. 1163-1176; Suedel, B. C., and Rodgers, J. H. Responses of *Hyaella azteca* and *Chironomus tentans* to particle size distribution and organic matter content of formulated and natural sediment. *Environmental Toxicology and Chemistry*, Vol 13, 1994, pp. 1639-1648.
- (61) Kemble, N.E., Dwyer, F.J., Ingersoll, C.G., C. Dawson, T.D., and Norberg-King, T.J., Tolerance of freshwater test organisms to formulated sediments for use in whole-sediment toxicity tests. *Environ. Toxicol. Chem.* 18: 222-230.
- (62) USEPA. Procedures for collection, handling, and manipulation of aquatic sediments for toxicological testing and chemical analysis October 2000.
- (63) Green, R. H., "Sampling Design and Statistical Methods for Environmental Biologists," Wiley-Interscience, New York. 257 p., 1979.
- (64) Stemmer, B. L., Burton Jr., G. A., and Sasson-Brickson, G., "Effect of Sediment Spatial Variance and Collection Method on Cladoceran Toxicity and Indigenous Microbial Activity Determinations," *Environmental Toxicology and Chemistry*, Vol 9, 1990a, pp. 1035-1044.
- (65) Stephan, C. E., Mount, D. I., Hansen, D. J., Gentile, J. H., Chapman, G. A., and Brungs, W. A., "Guidelines for Deriving Numerical National Water Quality Criteria for the Protection of Aquatic Organisms and Their Uses," PB85-227049, National Technical Information Service, Springfield, VA, 1985.
- (66) Chapman, P. M., "Current Approaches to Developing Sediment Quality Criteria," *Environmental Toxicology and Chemistry*, Vol 8, 1989, pp. 589-599.
- (67) Burton, G. A., "Assessment of Freshwater Sediment Toxicity," *Environmental Toxicology and Chemistry*, Vol 10, 1991, pp. 1585-1627.
- (68) Kemp, P. F., and Swartz, R. C., "Acute Toxicity of Interstitial and Particle-Bound Cadmium to A Marine Infaunal Amphipod," *Marine Environmental Research*, Vol 26, 1988, pp. 135-153.
- (69) Environment Canada, Biological Test Method: Test for growth and survival in sediment using the freshwater amphipod *Hyaella azteca* Environment Canada Ottawa, Ontario, EPSRN33, 1997a.
- (70) Environment Canada, Biological Test Method: Test for Growth and survival in sediment using larvae of freshwater midges (*Chironomus tentans* or *Chironomus riparius*). Environment Canada, Ottawa, Ontario, EPSRN32, 1997b.
- (71) Sibley, P.K., Monson, P.D., and Ankley, G.T., The effect of gut contents on dry weight estimates of *Chironomus tentans* larvae: Implications for interpreting toxicity on freshwater sediment toxicity tests. *Environ. Toxicol. Chem.* 16: 1721-1726, 1997b.
- (72) Benoit, D.A., Sibley, P.K., Juenemann, J.L., and Ankley, G.T. *Chironomus tentans* life-cycle test: Design and evaluation for use in assessing toxicity of contaminated sediments. *Environ. Toxicol. Chem.* 16:1165-1176, 1997.
- (73) Pittinger, C.A., Adams W.J. Assessing ecological risks to benthic species in product and technology development. In *Ecological Risk Assessment of Contaminated Sediment*. Ingersoll C.G., Dillon T., Biddinger G.R. (eds.) SETAC Press, Pensacola, FL, pp 11-21, 1997.
- (74) Stemmer, B. L., Burton Jr., G. A., and Leibfritz-Frederick, S., "Effect of Sediment Test Variables on Selenium Toxicity to *Daphnia magna*," *Environmental Toxicology and Chemistry*, Vol 9, 1990b, pp. 381-389.
- (75) Word, J. Q., Ward, J. A., Franklin, L. M., Cullinan, V. I., and Kiesser, S. L., "Evaluation of Equilibrium Partitioning Theory for Estimating the Toxicity of the Nonpolar Organic Compound DDT to the Sediment Dwelling Amphipod *Rhepoxynius abronius*," USEPA Criteria and Standards Division. SCD No. 11, Washington, DC, 1987.
- (76) Landrum, P. F., and Faust, W. R., "Variation in the Bioavailability of Polycyclic Aromatic Hydrocarbons Sorbed to Sediments for the Amphipod *Pontoporeia hoyi*," *Environmental Toxicology and Chemistry*, Vol 11, 1992, pp. 1197-1208.
- (77) USEPA. Proceedings From Workshop on Tiered Testing Issues for Freshwater and Marine Sediments. Washington, DC, September 16-18, 1992a.
- (78) USEPA. Evaluation of the Apparent Effects Threshold (AET) Approach For Assessing Sediment Quality. Report of the Sediment Criteria Subcommittee, SAB-EETFC-89-027, Washington, DC, 1989a.
- (79) USEPA. Evaluation of the Equilibrium Partitioning (EqP) Approach For Assessing Sediment Quality, Report of the Sediment Criteria Subcommittee of the Ecological Processes and Effects Committee. EPA-SAB-EPEC-90-006, Washington, DC, 1990a.
- (80) USEPA. Evaluation of the Sediment Classification Methods Compendium. Report of the Sediment Criteria Subcommittee of the Ecological Processes and Effects Committee, EPA-SAB-EPEC-90-018, Washington, DC, 1990b.
- (81) USEPA. An SAB report: Review of Sediment Criteria Development Methodology for Non-Ionic Organic Contaminants. Report of the Sediment Criteria Subcommittee of the Ecological Processes and Effects Committee. EPA-SAB-EPEC-93-002, Washington, DC, 1992b.
- (82) USEPA. Sediment Classification Methods Compendium. EPA 823-R-92-006, Washington, DC, 1992c.

- (83) Long, E. R., and Morgan, L. G., The Potential for Biological Effects of Sediment-Sorbed Contaminants Tested In the National Status and Trends Program. NOAA Technical Memorandum NOS OMA 52, Seattle, WA, 1991.
- (84) MacDonald, D.D., Carr, R.S., Calder, F.D., Long E.R., and Ingersoll, C.G. Development and evaluation of sediment quality guidelines for Florida coastal waters, *Ecotoxicology* 5: 253–278, 1996.
- (85) Ingersoll, C.G., Haverland, P.S., Brunson, E.L., Canfield, T.J., Dwyer, F.J., Henke, C.E., and Kemble, N.E., Calculation and evaluation of sediment effect concentrations for the amphipod *Hyalella azteca* and the midge *Chironomus riparius*, *J. Great Lakes Res.* 22:602–623, 1996.
- (86) Ingersoll, C.G., Dillon, T., Biddinger, R.G. (eds.). Methodological uncertainty in sediment ecological risk assessment. in *Ecological Risk Assessments of Contaminated Sediment*, SETAC press, Pensacola, FL, 389p. 1997.
- (87) Chapman, P. M., Power, E. A., and Burton, G. A., Jr., Integrated Assessments in Aquatic Ecosystems. In: G. A. Burton (ed.), *Sediment Toxicity Assessment*. Lewis Publishers, Boca Raton, FL, 1992.
- (88) Chapman, P.M., Anderson, B., Carr, S., Engle, V., Green, R., Hameedi, J., Harmon, M., Haverland, P., Hyland, J., Ingersoll, C.G., Long, E., Rodgers, J., Salzar, M., Sibley, P.J., Smith, P.J., Swartz, R.C., Thompson, B., and Windom, H. General guidelines for using the sediment quality triad. *Mar. Pollut. Bull.* 34:368–372, 1997.
- (89) Southerland, E., Kravitz, M., and Wall, T. Management Framework for Contaminated Sediments (the U.S. EPA Sediment Management Strategy). In: G. A. Burton, Jr. (ed.), *Sediment Toxicity Assessment*, Lewis Publishers, Chelsea, MI, 1992, pp. 341–370.
- (90) USEPA. Contaminated sediment management strategy, EPA 823–R-98–001. Office of Water, Washington, DC, 1998.
- (91) Dickson, K. L., Maki, A. W., and Brungs, W. A., *Fate and Effects of Sediment-Bound Chemicals in Aquatic Systems*, Pergamon Press, New York.
- (92) USEPA. The incidence and severity of sediment contamination in surface waters of the United States, Volume 1: National Sediment Quality Survey, EPA 823–R-006, 1997a.
- (93) USEPA-USACE (U.S. Army Corps of Engineers). Evaluation of Dredged Material Proposed for Discharge in Waters of the U.S. - testing material. EPA 823-B-98-004, Washington, DC, 1998 .
- (94) Smrchek J.C., Zeeman, M., Assessing risks to ecological systems from chemicals, Chapter 3 in: *Handbook of Environmental risk assessment and management*. P. Calow, editor, London: Blackwell Science Ltd. pp. 24–90, 1998.
- (95) Williams, L. R., “Methods for the EPA’s Regulatory Program,” *Environmental Testing and Analysis*, Vol 2, 1993, p. 36.
- (96) USEPA, EPA requirements for quality assurance project plans for environmental data operations, Draft interim final, EPA QA/R-5, Office of Research and Development, Washington, DC, 1994a.
- (97) Swartz, R. C., Marine Sediment Toxicity Tests, In: *Contaminated Marine Sediments-Assessment and Remediation*. National Research Council, National Academy Press, Washington, DC. 1989, pp. 115-129.
- (98) Karickhoff, S. W., and Morris, K. R., “Sorption Dynamics of Hydrophobic Pollutants in Sediment Suspensions,” *Environmental Toxicology and Chemistry*, Vol 4, 1985, pp. 469-479.
- (99) Davenport, R., and Spacie, A., “Acute Phototoxicity of Harbor and Tributary Sediments From Lower Lake Michigan,” *Journal of Great Lakes Research*, Vol 17, 1991, pp. 51-56.
- (100) Oris, J. T., and Giesy, J. P., “The Photoenhanced Toxicity of Anthracene to Juvenile Sunfish (*Lepomis spp.*),” *Aquatic Toxicology*, Vol 6, 1985, pp. 133-146.
- (101) Ankley, G.T., Collyard, S.A., Monson, P.D. and Kosian P.A. Influence of ultraviolet light on the toxicity of sediments contaminated with polycyclic aromatic hydrocarbons. *Environ. Toxicol. Chem.* 11: 1791–1796, 1994b.
- (102) Reynoldson, T. B., Day, K. E., Clarke, C., and Milani, D., “Effect of Indigenous Animals on Chronic Endpoints in Freshwater Sediment Toxicity Tests,” *Environmental Toxicology and Chemistry*, Vol 13, 1994, pp. 973-977.
- (103) Day, K. E., Kirby, R. S., and Reynoldson, T. B., The Effects of Sediment Manipulations on Chronic Sediment Bioassays With Three Species of Benthic Invertebrates, 1995.
- (104) Lamberson, J. O., and Swartz, R. C., Use of Bioassays in Determining the Toxicity of Sediment to Benthic Organisms. In: M. S. Evans (ed.), *Toxic Contaminants and Ecosystem Health: A Great Lakes Focus*, John Wiley and Sons, New York, 1988, pp. 257-279.
- (105) McNulty, E.W., Dwyer, F.J., Ellersieck, M.R., Greer, I.E., Ingersoll, C.G., and Rabeni, C.F., Evaluation of the ability of reference-toxicity tests to identify stress in laboratory populations of the amphipod *Hyalella azteca*. *Environ. Toxicol. Chem.* 18: 544–548, 1999.
- (106) Wiederholm, T., Wiederholm, A. M., and Goran, M., “Freshwater Oligochaetes,” *Water, Air, and Soil Pollution*, Vol 36, 1987, pp. 131-154.
- (107) Swartz, R. C., Kemp, P. F., Schultz, D. W., and Lamberson, J. O., “Effects of Mixtures of Sediment Contaminants on the Marine Infaunal Amphipod, *Rhepoxynius abronius*,” *Environmental Toxicology and Chemistry*, Vol 7, 1988, pp. 1013-1020.
- (108) USEPA-USACE (U.S. Army Corps of Engineers). Ecological Evaluation of Proposed Discharge of Dredged Material Into Ocean Waters, Technical Committee on Criteria for Dredged and Fill Material, *Environmental Effects Laboratory*, U.S. Army Engineer Waterways Experiment Station. Vicksburg, MS, 1977.
- (109) USEPA-USACE (U.S. Army Corps of Engineers). Evaluation of Dredged Material Proposed for Ocean Disposal. EPA-503/8-91/001, Washington, DC, 1991.
- (110) Scott, K. J., Effects of Contaminated Sediments on Marine Benthic Biota and Communities, In: *Contaminated Marine Sediments-Assessment and Remediation*, National Research Council, National Academy Press, Washington, DC. 1989, pp. 132-154.
- (111) USEPA. Techniques for Study of Effects and Uptake of Sediment Associated Chemicals, Office of Toxic Substances. USEPA, Gulf Breeze, FL, 1986a.
- (112) Smith, M.E., Lazorchak, J.M., Herrin, L.E., Brewer-Swartz, S., Thoney, W.T., A reformulated, reconstituted water for testing the freshwater amphipod, *Hyalella azteca*. *Environ. Toxicol. Chem.* 16:1229–1233, 1997.
- (113) Kemble, N.E., Brunson, E.L. Canfield, T.J., Dwyer, F.J., and Ingersoll, C.G., Assessing sediment toxicity from navigational pools of the upper Mississippi River using a 28–day *Hyalella azteca* test. *Arch. Environ. Contam. Toxicol.* 35: 181–190, 1998.
- (114) Borgmann, U. Systematic analysis of aqueous ion requirements of *Hyalella azteca*: A standard artificial medium including the essential bromide ion. *Arch. Environ. Contam. Toxicol.* 30: 356–363, 1996.
- (115) USEPA. Short-Term Methods for Estimating the Chronic Toxicity of Effluents and Receiving Waters to Marine and Estuarine Organisms, Second edition, EPA 600/4-91/003, Cincinnati, OH, 1993c.
- (116) Ingersoll, C. G., Dwyer, F. J., Burch, S. A., Nelson, M. K., Buckler, D. R., and Hunn, J. B., “The Use of Freshwater and Saltwater Animals to Distinguish Between the Toxic Effects of Salinity and Contaminants in Irrigation Drainwater,” *Environmental Toxicology and Chemistry*, Vol 11, 1992, pp. 503-511.
- (117) Nebeker, A. V., and Miller, C. E., “Use of the Amphipod Crustacean *Hyalella azteca* in Freshwater and Estuarine Sediment Toxicity Tests,” *Environmental Toxicology and Chemistry*, Vol 7, 1988, pp. 1027-1033.
- (118) Roach, R. W., Carr, R. S., Howard, C. L., and Cain, D. W. Assessment of Produced Water Impacts in Galveston Bay System. U.S. Fish and Wildlife Report, Clear Lake Ecological Services Office, Houston, TX, 1992.
- (119) Winger, P. V., and Lasier, P. J., Sediment Toxicity Testing: Comparison of Methods and Evaluation of Influencing Factors. In J. W.

- Gorsuch, F. J. Dwyer, C. G. Ingersoll, T. W. La Point, eds., *Environmental Toxicology and Risk Assessment: Second Volume*. ASTM STP 1216. American Society for Testing and Materials, Philadelphia, PA, 1994, pp. 640-662; Winger, P. V. and Lasier, P. J. Method for Estimating the Age of *Hyalella azteca* from Mixed-age Laboratory Cultures, 1994.
- (120) Harrahy, E.A. and W.H. Clements. Toxicity and bioaccumulation of a mixture of heavy metals in *Chironomus tentans* (Diptera: Chironomidae) in synthetic sediment. *Environ. Toxicol. Chem.* 16: 317-327, 1997.
- (121) Hanes, E. C., Ciborowski, J. J. H., and Corkum, L. D., Standardized Rearing Materials and Procedures for *Hexagenia*, A Benthic Aquatic Bioassay Organism, Annual Report Submitted to the Research Advisory Committee, Ontario Ministry of the Environment, Toronto Ontario, September 1991.
- (122) Naylor, C., Rodrigues, C. M., and Calow, "The Use of Artificial Sediments in Tests With *Chironomus riparius*," *Archives of Environmental Contamination and Toxicology*, 1993.
- (123) USEPA. Quality Criteria for Water, EPA-440/5-86-001, Washington, DC, 1986b.
- (124) Walters, D. B., and Jameson, C. W., Health and Safety for Toxicity Testing, Butterworth Publications, Woburn, MA, 1984.
- (125) Bureau of National Affairs, Inc. U.S. Environmental Protection Agency General Regulation for Hazardous Waste Management, Washington, D.C., 1986.
- (126) USEPA. Methods for Chemical Analysis of Water and Wastes, EPA-600/4-79-020, Cincinnati, OH, 1979b.
- (127) Benoit, D. A., Phipps, G. A., and Ankley, G. T., "A Sediment Testing Intermittent Renewal System for the Automated Renewal of Overlying Water in Toxicity Tests With Contaminated Sediment," *Water Research*, Vol 27, 1993, pp. 1403-1412.
- (128) Zumwalt, D. C., Dwyer, F. J., Greer, I. E., and Ingersoll, C. G., "A Water-Renewal System that Accurately Delivers Small Volumes of Water to Exposure Chambers," *Environmental Toxicology and Chemistry*, Vol 13, 1994, pp. 1311-1314.
- (129) Mount, D. I., and Brungs, W. A., "A Simplified Dosing Apparatus for Fish Toxicology Studies," *Water Research*, Vol 1, 1967, pp. 21-30.
- (130) Ingersoll, C. G., and Nelson, M. K., Testing Sediment Toxicity With *Hyalella azteca* (Amphipoda) and *Chironomus riparius* (Diptera). In: W. G. Landis and W. H. van der Schalie (eds.), *Aquatic Toxicology and Risk Assessment*, 13th V, ASTM STP 1096, Philadelphia, PA, 1990, pp. 93-109.
- (131) Maki, A. W., "Modifications of Continuous Flow Test Methods for Small Aquatic Organisms," *Progressive Fish Culturist*, Vol 39, 1977, pp. 172-174.
- (132) Brunson, E.L., Canfield, T.J., Dwyer, F.J., Kemble, N.E., Ingersoll, C.G, Assessing bioaccumulation of contaminated sediments from the upper Mississippi River using field-collected oligochaetes and laboratory- exposed *Lumbriculus variegatus*. *Arch. Environ. Contam. Toxicol.* 35: 191-201, 1998.
- (133) USEPA. Standard Guide for Collection, Storage, Characterization, and Manipulation of Sediments for Toxicological Testing, USEPA Series Number Pending, Washington, DC, October 2000.
- (134) Dillon, T. M., Moore, D. W., and Jarvis, A. S., "The Effects of Storage Temperature and Time on Sediment Toxicity," *Archives of Environmental Contamination Toxicology*, Vol 27, 1994, pp. 51-53.
- (135) Becker, D.S., Rose, C.D., and Bigham, G.N. Comparison of the 10-day freshwater sediment toxicity tests using *Hyalella azteca* and *Chironomus tentans* *Environ. Toxicol. Chem.* 14:2089-2094, 1995.
- (136) Carr, R.S. and Chapman, D.C. Comparison of methods for conducting marine and estuarine sediment porewater toxicity tests, extraction, storage, and handling techniques. *Arch. Environ. Contam. Toxicol.* 28: 69-77, 1995.
- (137) Moore, D.W. and Farrar, J.D. Effect of growth on reproduction in the freshwater amphipod, *Hyalella azteca*. *Hydrobiologia* 328: 127-134, 1996.
- (138) Sarda, N. and G.A. Burton, Jr. Ammonia variation in sediments: spatial, temporal and method-related effects, *Environ. Toxicol. Chem.* 14: 1499-1506, 1995.
- (139) Sijm, R.T.H., Haller, M. and Schrap, S.M. Influence of storage on sediment characteristics and of drying sediment on sorption coefficients of organic contaminants. *Bull. Environ. Contam. Toxicol.* 58: 961-968, 1997.
- (140) DeFoe, D.L. and Ankley, G.T. Influence of storage time on toxicity of freshwater sediments to benthic macroinvertebrates, *Environ. Pollut.* 99: 121-131, 1998.
- (141) Schuytema, G. S., Nebeker, A. V., Griffis, W. L., and Miller, C. E., "Effects of Freezing on Toxicity of Sediments Contaminated With DDT and Endrin," *Environmental Toxicology and Chemistry*, Vol 8, 1989, pp. 883-891.
- (142) Shuba, P. J., Tatem, H. E., and Carroll, J. H., Biological Assessment Methods to Predict the Impact of Open-Water Disposal of Dredged Material, U.S. Army Corps of Engineers Technical Report D-78-5Q, Washington, DC, 1978.
- (143) Ankley, G. T., Cook, P. M., Carlson, A. R., Call, D. J., Swenson, J. A., Corcoran, H. F., and Hoke, R. A., "Bioaccumulation of PCBs from Sediments by Oligochaetes and Fishes: Comparison of Laboratory and Field Studies," *Canadian Journal of Fisheries and Aquatic Sciences*, Vol 49, 1992b, pp. 2080-2085.
- (144) Ditsworth, G. R., Schults, D. W., and Jones, J. K. P., "Preparation of Benthic Substrates for Sediment Toxicity Testing," *Environmental Toxicology and Chemistry*, Vol 9, 1990, pp. 1523-1529.
- (145) Lamberson, J. O., and Swartz, R. C., Spiked-Sediment Toxicity Test Approach. In: *Sediment Classification Methods Compendium*, pp. 4-1 to 4-10. EPA 823-R-92-006, Washington, DC, 1992.
- (146) Plumb, Jr., R. H., Procedures for handling and Chemical Analysis of Sediment and Water Samples, Technical Committee on Criteria for Dredged and Fill Material, USEPA/USACE. EPA-4805572010. USEPA Great Lakes Laboratory. Grosse Ile, MI, 1981.
- (147) Van Rees, K.C.J., E.A. Sudlicky, P. Suresh, C. Rao and K.R. Reddy. Evaluation of laboratory techniques for measuring diffusion coefficients in sediments. *Environ. Sci. Technol.* 25:1605-1611, 1991.
- (148) Bufflap, S.T. and H.E. Allen, Comparison of pore water sampling techniques for trace metals. *Wat. Res.* 29:2051-2054, 1995.
- (149) Winger, P.V., P.J., Lasier and B.P. Jackson. The influence of extraction procedure on ion concentrations in sediment pore water. *Arch. Environ. Contam. Toxicol.* 35:8-13, 1998.
- (150) Burton, G.A., Jr. Sediment collection and processing factors affecting realism, In: G.A. Burton, Jr. (ed.) *Sediment Toxicity Assessment*. Lewis Publ. Boca Raton, FL, pp. 37-66, 1992 .
- (151) Bufflap, S.T. and H.E. Allen. Sediment pore water collection methods for trace metal analysis: a review, *Wat. Res.* 29: 165-177, 1995.
- (152) Horowitz, A.J., K.A. Elrick and M.R. Colberg, The effect of membrane filtration artifacts on dissolved trace element concentrations, *Wat. Res.* 26: 753-763, 1992.
- (153) USEPA EPA requirements for quality assurance project plans for environmental data operations. Draft interim final. EPA QA/R-5. Office of Research and Development, Washington, D.C. 1994e.
- (154) USEPA. QA/QC guidance for sampling and analysis of sediments, water, and tissues for dredged material evaluations-chemical evaluations, EPA 823-B-95-001, Office of Water, Washington, DC, 1995.
- (155) Food and Drug Administration, Good Laboratory Practices for Non-Clinical Laboratory Studies, Part 58. *Federal Register* 43(247): 60013-60020 (December 22, 1978), 1978.
- (156) USEPA. Handbook for Analytical Quality Assurance in Water and Wastewater Laboratories, EPA-600/4-79-019, Cincinnati, OH, 1979a.
- (157) USEPA. Proposed Good Laboratory Practice Guidelines for Toxicity Testing, Paragraph 163.60-6. *Federal Register* 45:26377-26382 (April 18, 1980), 1980a.

- (158) USEPA. Physical, Chemical, Persistence, and Ecological Effects Testing; Good Laboratory Practice Standards (Proposed Rule). 40 CFR 772, Federal Register 45:77353-77365 (November 21, 1980), 1980b.
- (159) USEPA. Short-Term Methods for Estimating the Chronic Toxicity of Effluents and Receiving Waters to Freshwater Organisms, Third edition. EPA 600/4-91/002, Cincinnati, OH, 1993b.
- (160) DeWoskin, R. S., Good Laboratory Practice Regulations: A Comparison, Research Triangle Institute, Research Triangle Park, NC, 1984, p. 63.
- (161) Taylor, J. K., Quality Assurance of Chemical Measurements. Lewis Publication, Inc., Chelsea, MI, 1987.
- (162) Moore, D. W., Dillon, T. M., Word, J. Q., Ward, J. A., "Quality Assurance/Quality Control (QA/QC) Guidance for Laboratory Dredged Material Bioassays," Miscellaneous Paper D-94-3, U.S. Army Corps of Engineers Waterways Experiment Station, Vicksburg, MS, Results of QA/QC Workshop held May 26-27, 1993, in Seattle, WA.
- (163) Pennak, R. W., Freshwater Invertebrates of the United States, John Wiley and Sons, Inc., New York. 1989, 628 p.
- (164) Merritt, R.W. and Cummins, K.W. An introduction to the aquatic insects of North America, 3<sup>rd</sup> edition, Kent Hunt Publishing Co., Dubuque, Iowa, 862p., 1996.
- (165) Duan, Y., Guttman, S.I., and Oris, J.T., Genetic differentiation among laboratory populations of *Hyaella azteca*: Implications for toxicity. Environ. Toxicol. Chem. 16: 691-695, 1997.
- (166) Tomasovic, M., Dwyer, F. J., Ingersoll, C. G., and Greer, I. E., "Recovery of *Hyaella azteca* From Sediment," *Environmental Toxicology and Chemistry*, Vol 14, No. 7, 1995, pp. 1177-1180.
- (167) Lee, D. R., Reference Toxicants in Quality Control of Aquatic Bioassays, In: A. L. Buikema and J. Cairns Jr. (eds.), Aquatic Invertebrate Bioassays, ASTM STP 715, Philadelphia, PA, 1980, pp. 188-199. National Research Council (NRC). Contaminated Marine Sediments-Assessment and Remediation, NRC, National Academy Press, Washington, DC, 1989.
- (168) de March, B. G. E., *Hyaella azteca*(Saussure). In: S. G. Lawrence (ed.), Manual for the Culture of Selected Freshwater Invertebrates, *Canadian Special Publication of Fisheries and Aquatic Sciences*, No. 54, Department of Fisheries and Oceans, 1981.
- (169) Hargrave, B. T., "The Utilization of Benthic Microflora by *Hyaella azteca*," *Journal of Animal Ecology*, Vol 39, 1970, pp. 427-437.
- (170) Cooper, W. E., "Dynamics and Production of a Natural Population of A Fresh-Water Amphipod, *Hyaella azteca*," *Ecological Monographs*, Vol 35, 1965, pp. 377-394.
- (171) Embody, G. C., "A Preliminary Study of the Distribution, Food and Reproductive Capacity of Some Freshwater Amphipods," *Internationale Revue der Gesamten Hydrobiologie Biol. Supply.*, Vol 3, 1911, pp. 1-33.
- (172) Bovee, E. C., "Some Effects of Temperature on the Rates of Embryonic, Postembryonic, and Adult Growth in *Hyaella azteca*," *Proceedings of the Iowa Academy of Science*, Vol 57, 1950, pp. 439-444.
- (173) Geisler, F. S., "Studies on the Post-Embryonic Development of *Hyaella azteca* (Saussure)," *Biological Bulletin*, Vol 86, 1944, pp. 6-22.
- (174) Ankley, G. T., Phipps, G. L., Leonard, E. N., Benoit, D. A., Mattson, V. R., Kosian, P. A., Cotter, A. M., Dierkes, J. R., Hansen, D. J., and Mahony, J. D., "Acid-Volatile Sulfide as a Factor Mediating Cadmium and Nickel Bioavailability in Contaminated Sediment," *Environmental Toxicology and Chemistry*, Vol 10, 1991a, pp. 1299-1307.
- (175) Sprague, J. B., "Resistance of Four Freshwater Crustaceans to Lethal High Temperature and Low Oxygen," *Journal of Fisheries Research Board Canada*, Vol 20, 1963, pp. 387-415.
- (176) de March, B. G. E., "The Effects of Photoperiod and Temperature on the Induction and Termination of Reproductive Resting Stage in the Freshwater Amphipod *Hyaella azteca* (Saussure)," *Canadian Journal of Zoology*, Vol 55, 1977, pp. 1595-1600.
- (177) de March, B. G. E., "The Effects of Constant and Variable Temperatures on the Size, Growth, and Reproduction of *Hyaella azteca* (Saussure)," *Canadian Journal of Zoology*, Vol 56, 1978, pp. 1801-1806.
- (178) Bovee, E. C., "Studies on the Thermal Death of *Hyaella azteca* (Saussure)," *Biological Bulletin*, (Woods Hole) Vol 96, 1949, pp. 123-128.
- (179) Pennak, R. W., and Rosine, W. A., "Distribution and Ecology of Amphipoda (Crustacea) in Colorado," *American Midland Naturalist*, Vol 96, 1976, pp. 325-331.
- (180) Nebeker, A. V., Onjukka, S. T., Stevens, D. G., Chapman, G. A., and Dominguez, S. E., "Effects of Low Dissolved Oxygen on Survival, Growth and Reproduction of *Daphnia*, *Hyaella* and *Gammarus*," *Environmental Toxicology and Chemistry*, Vol 11, 1992, pp. 373-379.
- (181) Townsend, B. E., Lawrence, S. G., and Flannagan, J. F., *Chironomus tentans* Fabricius, In: S. G. Lawrence (ed.), Manual for the Culture of Selected Freshwater Invertebrates. *Canadian Special Publication of Fisheries and Aquatic Sciences*, No. 54. Dept. of Fisheries and Oceans, Winnipeg, Canada, 1981, pp. 109-126.
- (182) Flannagan, J. F., "Toxicity Evaluation of Trisodium Nitrotriacetate to Selected Invertebrates and Amphibians," *Journal of Fisheries Research Board Canada*, Vol 258, 1971, 21 p.
- (183) Driver, E. A., "Chironomid Communities in Small Prairie Ponds: Some Characteristics and Controls," *Freshwater Biology*, Vol 7, 1977, pp. 121-123.
- (184) Sadler, W. O., "Biology of the Midge *Chironomus tentans* Fabricius, and Methods for its Propagation," *Cornell University Agricultural Experimental Station Memorandum*, Vol 173, 1935, 25 p.
- (185) Siegfried, W. R., "Summer Food and Feeding of the Ruddy Duck in Manitoba," *Canadian Journal of Zoology*, Vol 51, 1973, pp. 1293-1297.
- (186) Driver, E. A., Sugden, L. G., and Kovach, R. J., "Calorific, Chemical and Physical Values of Potential Duck Foods," *Freshwater Biology*, Vol 4, 1974, pp. 281-292.
- (187) McLarney, W. O., Henderson, S., and Sherman, M. S., "A New Method for Culturing *Chironomus tentans* Fabricius Larvae Using Burlap Substrate in Fertilized Pools," *Aquaculture*, Vol 4, 1974, pp. 267-276.
- (188) Topping, M. S., "Ecology of Larvae of *Chironomus tentans* (Diptera: Chironomidae) in Saline Lakes in Central British Columbia," *Canadian Entomologist*, Vol 193, 1971, pp. 328-338.
- (189) Curry, L. L., A Survey of Environmental Requirements for the Midge (Diptera: Tendipedidae), In: C. M. Tarzwell (ed.), Biological Problems in Water Pollution, 3rd Seminar, *U.S. Public Health Service Publication*, 999-WP-25, 1962, pp. 127 -141.
- (190) Oliver, D. R., "Life History of the Chironomidae," *Annual Review of Entomology*, Vol 16, 1971, pp. 211-230.
- (191) New, M. B., Scholl, J. P., McCarty, J. C., and Bennett, J. P., "A Recirculating System for Experimental Aquaria," *Aquaculture*, Vol 3, 1974, pp. 95-103.
- (192) Crandall, T., Busack, C. A., and Gall, G. A. E., "An Easily Constructed Recirculating Aquarium System for Research Requiring Many Small Groups of Animals," *Aquaculture*, Vol 22, 1981, pp. 193-199.
- (193) Rottmann, R. W., and Campton, D. E., "Multiple-Tank Aquarium System With Recirculating Water for Laboratory Studies of Freshwater Fishes," *Progressive Fish Culturist*, Vol 51, 1989, pp. 238-243.
- (194) USEPA Duluth, Standard Operating Procedures for Culturing *Hyaella azteca* (ERL-D-SOP-CTI-016), *Chironomus tentans* (ERL-D-SOP-CTI-015), and *Lumbriculus variegatus* (ERL-D-SOP-CTI-017). USEPA, Duluth, MN, 1993.



- (195) Greer, I. E., Standard Operating Procedures for Culture of Chironomids (SOP B5.25 dated 02/18/93) and *Hyalella azteca* (SOP B5.38 dated 09/17/93). National Biological Survey (formerly U.S. Fish and Wildlife Service), Columbia, MO, 1993.
- (196) Borgmann, U., Ralph, K. M., and Norwood, W. P., "Toxicity Test Procedures for *Hyalella azteca*, and Chronic Toxicity of Cadmium and Pentachlorophenol to *H. azteca*, *Gammarus fasciatus*, and *Daphnia magna*," *Archives of Environmental Contamination and Toxicology*, Vol 18, 1989, pp. 756-764.
- (197) Norberg-King, T. J., Juenemann, P. S., and Leonard, E., Relative Sensitivity of *Chironomus tentans* Instars to Various Toxicants, 1994.
- (198) Batac-Catalan, Z., and White, D. S., "Creating and Maintaining Cultures of *Chironomus tentans* (Diptera: Chironomidae)," *Entomology News*, Vol 93, 1982, pp. 54-58.
- (199) Dawson, T.D., Jenson, J.J., Norberg-King, T.J. Laboratory Culture of *Chironomus tentans* for Use in Toxicity Testing: Optimum Initial Egg Stocking Densities, *Hydrobiologia*: In review, 1999
- (200) Nebeker, A. V., Cairns, M. A., Gakstatter, J. H., Malueg, K. W., Schuytema, G. S., and Krawczyk, D. F., "Biological Methods for Determining Toxicity of Contaminated Freshwater Sediments to Invertebrates," *Environmental Toxicology and Chemistry*, Vol 3, 1984a, pp. 617-630.
- (201) Borgmann, U., and Munawar, M., A New Standardized Bioassay Protocol Using the Amphipod *Hyalella azteca*, *Hydrobiologia* 188/189 :425-531, 1989 .
- (202) Burton, G. A., Stemmer, B. L., Winks, K. L., Ross, P. E., and Burnett, L. C., "A Multitrophic Level Evaluation of Sediment Toxicity in Waukegan and Indiana Harbors," *Environmental Toxicology and Chemistry*, Vol 8, 1989, pp. 1057-1066.
- (203) Winger, P. V., Lasier, P. J., and Geitner, H., "Toxicity of Sediments and Pore Water from Brunswick Estuary, Georgia," *Archives of Environmental Contamination and Toxicology*, 1994.
- (204) Leppanen, C.J. and Maier, K.J., An inexpensive and efficient modular water-renewal system for bulk sediment toxicity testing. *Environ. Toxicol. Chem.* 17:969-971, 1998.
- (205) Wall, D.V., London, J., Warren, J.E., Gossett, R., Wenholtz, M.D., and Klaine, S.J., Development of a continuous-flow renewal system for sediment toxicity testing. *Environ. Toxicol. Chem.* 17: 1159-1164, 1998.
- (206) Gauss, J. D., Woods, P. E., Winner, R. W., and Skillings, J. H., "Acute Toxicity of Copper to Three Life Stages of *Chironomus tentans* as Affected By Water Hardness-Alkalinity," *Environmental Pollution* (Ser. A), Vol 37, 1985, pp. 149-157.
- (207) Mayer Jr., F. L., and Eilersieck, M. R., Manual of Acute Toxicity: Interpretation and Data Base for 410 Chemicals and 66 Species of Freshwater Animals, U.S. Fish and Wildlife Service Resource Publication 160, Washington, DC, 1986.
- (208) Unger, P. D., Hague, K., and Schwartz, A. L., "Clinical Comparison of a Formaldehyde Free Histological Fixative (NoTox) to Neutral Buffered Formalin, International Academy of Pathologists, March 1993, New Orleans, LA, 1993.
- (209) Stevens, J.A. and Benson, W.H., *Hyalella azteca* 10-day sediment toxicity test: Comparison of growth measurement endpoints. *Environ. Toxicol. Water Qual.* 13: 243-248, 1998.
- (210) Collyard, S. A., Ankley, G. T., Hoke, R. A., and Goldenstein, T., "Influence of Age on the Relative Sensitivity of *Hyalella azteca* to Diazinon, Alkylphenol Ethoxylate, Copper, Cadmium, and Zinc," *Archives of Environmental Contamination and Toxicology*, Vol 26, 1994, pp. 110-113.
- (211) Adams, W. J., Kimerle, R. A., and Mosher, R. G., An Approach for Assessing the Environmental Safety of Chemicals Sorbed to Sediments. In: R. D. Cardwell, R. Purdy, and R. C. Bahner (eds.), *Aquatic Toxicology and Hazard Evaluation: 7th Symposium*. ASTM STP 854. Philadelphia, PA, pp. 429-453, 1985.
- (212) Nebeker, A. V., Onjukka, S. T., and Cairns, M. A., "Chronic Effects of Contaminated Sediment on *Daphnia magna* and *Chironomus tentans*," *Bulletin of Environmental Contamination and Toxicology*, Vol 41, 1988, pp. 574-581.
- (213) Hoke, R. A., Giesy, J. P., Ankley, G. T., Newsted, J. L., and Adams, R. J., Toxicity of Sediments from Western Lake Erie and the Maumee River at Toledo, Ohio, 1987: Implications for Current Dredged Material Disposal Practices. *Journal of Great Lakes Research*, Vol 16, 1990, pp. 457-470.
- (214) Burton, G. A., Ankley, G. T., Ingersoll, C. G., Norberg-King, T. J., and Winger, P. V., Evaluation of Sediment Toxicity Test Methods: Round-robin Testing Design, 1995.
- (215) Smock, L. A., "Relationships Between Body Size and Biomass of Aquatic Insects," *Freshwater Biology*, Vol 10, 1980, pp. 375-383.
- (216) Ingersoll, C. G., Sediment Toxicity Tests. In: G. Rand (ed.), *Fundamentals of Aquatic Toxicology* (2nd edition), 1995.
- (217) Nebeker, A. V., Cairns, M. A., and Wise, C. M., "Relative Sensitivity of *Chironomus tentans* Life Stages to Copper," *Environmental Toxicology and Chemistry*, Vol 3, 1984b, pp. 151-158.
- (218) Williams, K. A., Green, D. W. J., Pascoe, D., and Gower, D. E., "The Acute Toxicity of Cadmium to Different Larval Stages of *Chironomus riparius* (Diptera:Chironomidae) and Its Ecological Significance for Pollution Regulation," *Oecologia* Vol 1986b, pp. 362-366.
- (219) Sibley, P.K., Benoit, D.A., and G.T. Ankley. Life cycle and behavioral assessments of the influence of substrate particle size on *Chironomus tentans* (Diptera: Chironomidae) in laboratory assays. *Hydrobiologia* 361:1-9, 1998.
- (220) Lacy, R., Watzin, M.C. and McIntosh, A.W. Sediment organic matter content as confounding factor in toxicity test with *Chironomus tentans*. *Environ. Toxicol. Chem.* 18:231-236, 1999.
- (221) Day, K.E., Kirby, R.S., and Reynoldson, T.B., Sexual dimorphism in *Chironomus riparius* (Meigen): Impact on Interpretation of growth in the whole-sediment toxicity tests. *Environ. Toxicol. Chem.* 13 :35-39, 1994.
- (222) Hurlbert, S. H., "Pseudoreplication and the Design of Ecological Field Experiments," *Ecological Monographs*, Vol 54, 1984, pp. 187-211.
- (223) Tetra Tech, Inc. ODES Statistical Power Analysis. Draft Report, Prepared for Office of Marine and Estuarine Protection, USEPA Contract NO. 68-01-6938, TC-3953-03. Bellevue, WA, 1986.
- (224) Schaeffer, D. J., and Janardan, K. G., "Theoretical Comparison of Grab and Composite Sampling Programs," *Biometrical Journal*, Vol 20, 1978, pp. 215-227.
- (225) Atkinson AC, Doney AN. Optimum Experimental Designs, Oxford: Clarendon Press. 328p., 1992.
- (226) Fairweather, P. G., "Statistical Power and Design Requirements for Environmental Monitoring," *Australian Journal of Marine Freshwater Research*, Vol 42, 1991, pp. 555-567.
- (227) Steel, R. G. D., and Torrie, J. A., Principles and Procedures of Statistics. McGraw-Hill Book Co., New York, 1980.
- (228) Sokal, R. R., and Rohlf, F. J., Biometry, 2nd edition. W.H. Freeman and Company. New York. 1981.
- (229) Dixon, W. J., and Massey, F. J., Jr., Introduction to Statistical Analysis. 4th Ed. McGraw-Hill Book Company, New York, NY. 678 p., 1983.
- (230) Zar, J. H., Biostatistical Analysis. 2nd Ed. Prentice-Hall, Inc., Englewood Cliffs, NJ. 717 p., 1984
- (231) Snedecor, G. W., and Cochran, G. C., Statistical Methods. 8th Ed. The Iowa State University Press, Ames, IA. 507 p., 1989.
- (232) Conover, W. J., Practical Nonparametric Statistics. 2nd Ed. John Wiley and Sons, New York, NY, 493 p., 1980. Conover, W.J., Johnson, M. E. and Johnson, M. M. A Comparative Study of Tests for Homogeneity of Variances, With Applications to the Outer Continental Shelf Bidding Data. *Technometrics* 23:351-361, 1981 .
- (233) U.S. Environmental Protection Agency. Methods for Measuring the Acute Toxicity of Effluents to Freshwater and Marine Organisms. 3rd Ed. EPA-600/4-85/013, Cincinnati, OH, 1985 .

- (234) Shapiro, S. S., and Wilk, M. B., An Analysis of Variance Test for Normality (Complete Samples). *Biometrika* 52:591-611, 1965.
- (235) Gill, J. L., Design and Analysis of Experiments in the Animal and Medical Sciences. Vol. 3. Appendices. The Iowa State University Press, Ames, IA, 173 p., 1978.
- (236) USEPA. Short-term Methods for Estimating the Chronic Toxicity of Effluents and Receiving Waters to Freshwater Organisms. EPA/600/4-89/001, Cincinnati, OH, 1989b.
- (237) Winer, B. J., Statistical Principles in Experimental Design. 2nd Ed. McGraw-Hill Book Company, New York, NY. 907 p., 1971.
- (238) Rohlf, F. J., and Sokal, R. R., Statistical Tables. W.H. Freeman and Company, New York, NY, 1981.
- (239) Bartlett, M. S., "Some Examples of Statistical Methods of Research in Agriculture and Applied Biology," *Journal of the Royal Statistical Society Suppl.*, Vol 4, 1937, pp. 137-183.
- (240) Satterthwaite, F. W., "An Approximate Distribution of Estimates of Variance Components," *Biological Bulletin*, Vol 2, 1946, pp. 110-114.
- (241) Finney, D. J., Probit analysis. Third edition, Cambridge, University Press, London, 333 p., 1971.
- (242) Hamilton, M. A., Russo, R. C., and Thurston, R. V., "Trimmed Spearman-Kärber Method for Estimating Median Lethal Concentrations in Toxicity Bioassays," *Environmental Science and Technology*, Vol 12, 1978, p. 417.
- (243) Efron, B., The Jackknife, the Bootstrap, and Other Resampling Plans. CBMS 38, Soc. Industr. Appl. Math., Philadelphia, PA, 1982.
- (244) Marcus, A. H., and Holtzman, A. P., A Robust Statistical Method for Estimating Effects Concentrations in Short-Term Fathead Minnow Toxicity Tests. Manuscript submitted to the Criteria and Standards Division, U.S. Environmental Protection Agency, by Battelle Washington Environmental Program Office, Washington, DC, June 1988, under EPA Contract No. 69-03-3534. 39 p., 1988; Hall, W. S., Patoczka, J. B., Miranda, R. J., Porter, B. A., and Miller, E. Acute toxicity of industrial surfactants to *Mysidopsis bahia*. *Archives of Environmental Contamination and Toxicology*, Vol 18, pp. 765-772.
- (245) Grothe, D. R., and Kimerle, R. A., "Interand Intra-Laboratory Variability in *Daphnia magna* Effluent Toxicity Test Results," *Environmental Toxicology and Chemistry*, Vol 4, 1985, pp. 189-192.
- (246) Pittinger, C. A., Woltering, D. M., and Masters, J. A., "Bioavailability of Sediment-Sorbed and Soluble Surfactants to *Chironomus riparius* (Midge)," *Environmental Toxicology and Chemistry*, Vol 8, 1989, p. 11.
- (247) Burton G.A., Norberg-King, T.J., Ingersoll, C.G., Ankley, G.T., Winger, P.V., Kubitz, J., Lazorchak, J.M., Smith, M.E., Greer, I.E., Dwyer, F.J., Call, D.J., Day, K.E., Kennedy, P., Stinson, M. Interlaboratory study of precision: *Hyaella azteca* and *Chironomus tentans* Freshwater sediment toxicity assay. *Environ. Toxicol. Chem.* 15: 1335-1343, 1996b.
- (248) Lee, C. M., "Toxicity of Dihad-Tallow Dimethyl Ammonia Chloride," *Tenside Detergents*, Vol 23, 1986, pp. 196-199; U.S. Environmental Protection Agency. Technical support document for water quality-based toxic controls. EPA 505/2-90/001, Washington, DC, 1991d.
- (249) Powlesland, C., and George, J., "Acute and Chronic Toxicity of Nickel to Larvae of *Chironomus riparius* (Meigen)," *Environmental Pollution*, Vol 42, pp. 47-64; Wegner, G. S., and Hamilton, R. W., "Effect of Calcium Sulfide on *Chironomus riparius* (Diptera: Chironomidae) Egg Hatchability," *Environmental Entomologist*, Vol 5, pp. 256-258; Williams, K. A., Green, D. W. J., Pascoe, D., and Gower, D. E., "The Acute Toxicity of Cadmium to Different Larval Stages of *Chironomus riparius* (Diptera: Chironomidae) and Its Ecological Significance for Pollution Regulation," *Oecologia*, Vol 70, pp. 362-366.
- (250) Oliver, D. R., "Life History of the Chironomidae" *Annual Review of Entomology*. Vol 16, 1971, pp. 211-230.
- (251) Rasmussen, J. B., "The Life-history, Distribution, and Production of *Chironomus riparius* and *Glyptotendipes paripes* in a Prairie Pond," *Hydrobiologia*, Vol 119, 1984, pp. 65-72.
- (252) Curry, L. L., "A Survey of Environmental Requirements for the Midge (Diptera: Tendipedidae)," *Biological Problems in Water Pollution*, pp. 127 -141, U.S. Public Health Services Publication 999-WP-25, Cincinnati, OH, p. 376.
- (253) Credland, P. F., "A New Method for Establishing a Permanent Laboratory Culture of *Chironomus riparius* Meigen (Diptera: Chironomidae)," *Freshwater Biology*, Vol 3, 1973, pp. 45-51.
- (254) Davies, B. R., "The Dispersal of Chironomidae Larvae: A Review," *Journal for the Entomological Society of South Africa*, Vol 39, 1976, pp. 39-59.
- (255) Biever, K. D., "A Rearing Technique for the Colonization of Chironomid Midges," *Annals of the Entomological Society of America*, Vol 58, 1965, pp. 135-136.
- (256) Prater, B. L., and Anderson, M. A., "A 96-Hour Sediment Bioassay of Duluth and Superior Harbor Basins (Minnesota) Using *Hexagenia limbata*, *Asellus communis*, *Daphnia magna*, and *Pimephales promelas* as Test Organisms," *Bulletin Environmental Contamination Toxicology*, Vol 18, 1977, pp. 159-169.
- (257) Malueg, K. W., Schuytema, G. S., Gakstatter, J. H., and Krawczyk, D. F., "Effect of *Hexagenia* on *Daphnia* Response in Sediment Toxicity Tests." *Environmental Toxicology and Chemistry*, Vol 2, 1983, pp. 73-82.
- (258) Giesy, J. P., Rosiu, C. R., and Graney, R. L., "Benthic Invertebrate Bioassays with Toxic Sediment and Pore Water," *Environmental Toxicology and Chemistry*, Vol 9, 1990, pp. 233-248.
- (259) U.S. Environmental Protection Agency, *Development of Bioassay Procedures for Defining Pollution of Harbor Sediments*, Environmental Research Laboratory, Duluth, MN, 1981.
- (260) Cairns, M. A., Nebeker, A. V., Gakstatter, J. N., and Griffis, W. L., "Toxicity of Copper-Spiked Sediments to Freshwater Invertebrates," *Environmental Toxicology and Chemistry*, Vol 3, 1984, pp. 435-445.
- (261) Schuytema, G. S., Nelson, P. O., Malueg, K. W., Nebeker, A. G., Krawczyk, D. F., Ratcliff, A. K., and Gakstatter, J. H., "Toxicity of Cadmium in Water and Sediment Slurries to *Daphnia magna*," *Environmental Toxicology and Chemistry*, Vol 3, 1984, pp. 293-308.
- (262) LeBlanc, G. A., and Surprenant, D. C., "A Method of Assessment of the Toxicity of Contaminated Freshwater Sediments," in Cardwell, R. D., Purdy, R., and Bahner, R. C., Eds., *Aquatic Toxicology and Hazard Assessment*, Seventh Symposium, *ASTM STP 854*, ASTM, 1985, pp. 269-283.
- (263) Miller, W. E., Peterson, S. A., Greene, J. C., and Callahan, C. A., "Comparative Toxicology of Laboratory Organisms for Assessment Hazardous Waste Sites," *Journal of Environmental Quality*, Vol 14, 1985, pp. 569-574.
- (264) Hall, W. S., Dickson, K. L., Saleh, F. Y., and Rogers, J. H., Jr., "Effects of Suspended Solids on the Bioavailability of Chlordane to *Daphnia magna*," *Archives Environmental Contamination Toxicology*, Vol 15, 1986, pp. 509-534.
- (265) Burton, G. A., Jr., Lazorchak, J. M., Waller, W. T., and Lanza, G. R., "Arsenic Toxicity Changes in the Presence of Sediment," *Bulletin Environmental Contamination Toxicology*, Vol 38, 1987, pp. 491-499.
- (266) Mount, D. I., and Norberg, T. J., "A Seven Day Life-Cycle Cladoceran Toxicity Test," *Environmental Toxicology and Chemistry*, Vol 3, 1984, pp. 425-434.
- (267) Leewangh, P., "Toxicity Test with Daphnids. Its Application in the Management of Water Quality," *Hydrobiologia*, Vol 59, 1978, pp. 145-148.
- (268) Goulden, C. E., and Henry, L. L., "*Ceriodaphnia* and *Daphnia* Bioassay Workshop Manual," The Academy of Natural Sciences, Philadelphia, PA.

- (269) Lawrence, S. G., Ed., "Manual for the Culture of Selected Freshwater Invertebrates," *Canadian Special Publication of Fisheries and Aquatic Sciences*, Vol 54, 1981, p. 160.
- (270) Knight, J. T., and Waller, W. T., "Incorporating *Daphnia magna* into the Seven-Day *Ceriodaphnia* Effluent Toxicity Test Method," *Environmental Toxicology and Chemistry*, Vol 6, 1987, pp. 635-645.
- (271) Winner, R. W., "Multigeneration Life-Span Tests of the Nutritional Adequacy of Several Diets and Culture Waters for *Ceriodaphnia dubia*," *Environmental Toxicology and Chemistry*, Vol 8, 1989, pp. 513-520.
- (272) Norberg-King, T. J., and Schmidt, S., "Comparison of Effluent Toxicity Results Using *Ceriodaphnia dubia* Cultured on Several Diets," *Environmental Toxicology and Chemistry*, Vol 12, 1993, pp. 1945-1955.
- (273) Nebeker, A. V., Onjukka, S. T., Cairns, M. A., and Krawczyk, D. F., "Survival of *Daphnia magna* and *Hyalella azteca* in Cadmium Spiked Water and Sediment," *Environmental Toxicology and Chemistry*, Vol 5, 1986, pp. 933-938.
- (274) Winner, R. W., "Evaluation of the Relative Sensitivities of 7-d *Daphnia magna* and *Ceriodaphnia dubia* Toxicity Tests for Cadmium and Sodium Pentachlorophenate," *Environmental Toxicology and Chemistry*, Vol 7, 1988, pp. 153-156.
- (275) Mount, D. I., and Norberg-King, T. J., "A Seven-Day Life Cycle Cladoceran Toxicity Test," *Environmental Toxicology and Chemistry*, Vol 3, 1984, pp. 425-434.
- (276) Burton, G. A., Jr., Burnett, L., Henry, M., Klaine, S., Landrum, P., and Swift, M., "A Multi-Assay Comparison of Sediment Toxicity at Three 'Areas of Concern,'" *Abstracts Annual Meeting Society Environmental Toxicology Chemistry*, Arlington, VA, No. 213, p. 53.
- (277) Lewis, P. A., and Horning, W. B., "A Short-Term Chronic Toxicity Test Using *Daphnia magna*, in Adams, W. J., Chapman, G. A., and Landis, W. G., Eds., *Aquatic Toxicology and Hazard Assessment*, 10th Volume, *ASTM STP 971*, ASTM, 1988, pp. 548-555.
- (278) McCafferty, W. P., "The Burrowing Mayflies (Ephemeroptera: Ephemeridae) of the United States," *Transactions of the American Entomological Society*, Vol 101, 1975, pp. 447-504.
- (279) Fremling, C. R., and Mauck, W. L., "Methods for Using Nymphs of Burrowing Mayflies (Ephemeroptera, *Hexagenia*) as Toxicity Test Organisms," *Aquatic Invertebrate Bioassays*, *ASTM STP 715*, Buikema, A. L., Jr., and Cairns, J., Jr., Eds., ASTM, Philadelphia, PA, 1980, pp. 81-97.
- (280) Giesy, J. P., and Hoke, R. A., "Freshwater Sediment Toxicity Bioassessment: Rationale for Species Selection and Test Design," *Journal of Great Lakes Research*, Vol 15, 1989, pp. 539-569.
- (281) Friesen, M. K., Galloway, T. D., and Flannagan, J. F., "Toxicity of the Insecticide Permethrin in Water and Sediment to Nymphs of the burrowing Mayfly *Hexagenia rigida* (Ephemeroptera: Ephemeridae)," *Canadian Entomologist*, Vol 115, 1983, pp. 1007-1014.
- (282) Bedard, D., Hayton, A., and Persaud, D., "Ontario Ministry of the Environment Laboratory Sediment Biological Testing Protocol," Ontario Ministry of the Environment, Toronto, Ontario, 1992, 26 pp.
- (283) Giesy, J. P., Rosiu, C. J., Graney, R. L., and Henry, M. G., "Benthic Invertebrate Bioassays with Toxic Sediment and Pore Water," *Environmental Toxicology Chemistry*, Vol 9, 1990, pp. 233-248.
- (284) Henry, M. G., Chester, D. N., and Mauck, W. L., "Role of Artificial Burrows in *Hexagenia* Toxicity Tests: Recommendations for Protocol Development," *Environmental Toxicology Chemistry*, Vol 5, 1986, pp. 553-559.
- (285) Landrum, P. F., and Poore, R., "Toxicokinetics of Selected Xenobiotics in *Hexagenia limbata*," *Journal of Great Lakes Research*, Vol 14, 1988, pp. 427-437.
- (286) Friesen, M. K., "*Hexagenia rigida* (McDunnough)," *Manual for the Culture of Selected Freshwater Invertebrates*, Lawrence, S.G., Ed., *Canadian Special Publication of Fisheries Aquatic Science*, Vol 54, 1981, pp. 127-142.
- (287) Reynoldson, T. B., Schloesser, D. W., and Manny, B. A., "Development of a Benthic Invertebrate Objective for Mesotrophic Great Lakes Waters," *Journal of Great Lakes Research*, Vol 15, 1989, pp. 669-686.
- (288) IJC, "Report of the Great Lakes Science Advisory Board-1989 Report," Great Lakes Science Advisory Board, Windsor, Ontario, Canada, 1989.
- (289) Edmunds, G. F., Jr., Jensen, S. L., and Berner, L., *The Mayflies of North and Central America*, University of Minnesota Press, 1976.
- (290) Needham, J. G., Traver, J. R., and Hsu, Y.-C., *The Biology of Mayflies*, E. W. Classey Ltd., 1972.
- (291) Hunt, B. P., "The Life History and Economic Importance of a Burrowing Mayfly, *Hexagenia limbata* in Southern Michigan Lakes," Michigan Department of Conservation, *Bulletin of the Institute of Fishery Research No. 4*, Lansing, MI, 1953.
- (292) Zimmerman, M. C., and Wissing, T. E., "Effects of Temperature on Gut-Loading and Gut-Cleaning Times of the Burrowing Mayfly, *Hexagenia limbata*," *Freshwater Biology*, Vol 8, 1978, pp. 269-277.
- (293) Hiese, B. A., and Flannagan, J. F., "Life Histories of *Hexagenia limbata* and *Ephemera simulans* (Ephemeroptera) in Dauphin Lake, Manitoba," *Journal of the North American Benthological Society*, Vol 6, 1987, pp. 230-240.
- (294) McCafferty, W. P., and Pereira, C., "Effects of Developmental Thermal Regimes on Two Mayfly Species and Their Taxonomic Interpretation," *Annals of the Entomological Society of America*, Vol 77, 1984, pp. 69-87.
- (295) Welch, C. L., and Vodopich, D. S., "Production by *Hexagenia limbata* in a Warmwater Reservoir and its Association with Chlorophyll Content of the Water Column," *Hydrobiologia*, Vol 185, 1989, pp. 183-193.
- (296) Wright, L. L., and Mattice, J. J., "Substrate Selection as a Factor in *Hexagenia* Distribution," *Aquatic Insects*, Vol 3, 1981, pp. 13-24.
- (297) Kovats, Z. E., and Ciborowski, J. J. H., "Aquatic Insect Adults as Indicators of Organochlorine Contamination," *Journal of Great Lakes Research*, Vol 15, 1989, pp. 623-634.
- (298) Bedard, D., "Sediment Bioassay Development: Addressing the Pros and Cons," *Proceedings of Technology Transfer Conference*, Vol 1, No. 10, 1989, pp. 471-474.
- (299) Hanes, E. C., and Ciborowski, J. J. H., "The Effects of Larval Density and Food Limitation on Growth of *Hexagenia* (Ephemeroptera: Ephemeridae) under Laboratory Conditions," *Proceedings of the Bulletin of North American Benthology Society*, Vol 6, 1989, pp. 183.
- (300) Ciborowski, J. J. H., Hanes, E. C., and Corkum, L. D., Standardized Rearing Materials and Procedures for *Hexagenia*, A Benthic Aquatic Bioassay Organism, Semiannual Report, June 1992. Prepared for the Research Advisory Committee, Ontario Ministry of the Environment, 69 p.
- (301) Malueg, K. W., Schuytema, G. S., Krawczyk, D. F., and Gakstatter, J. H., "Laboratory Sediment Toxicity Tests, Sediment Chemistry and Distribution of Benthic Macroinvertebrates in Sediment from the Keweenaw Waterway, Michigan," *Environmental Toxicology Chemistry*, Vol 3, 1984, pp. 233-242.
- (302) Brinkhurst, R. O., and Gelder, S. R., "Annelida, Oligochaeta and Branchiobdellida," In *Ecology and Classification of North American Freshwater Invertebrates*, Thorp, J. H., and Covich, A. P. (eds.), Academic Press, Inc., San Diego, CA, 1991, pp. 401-435.
- (303) Wiederholm, T., Wiederholm, A. M., and Milbrink, G., "Bulk Sediment Bioassays with Five Species of Fresh-Water Oligochaetes," *Water, Air and Soil Pollution*, Vol 36, 1987, pp. 131-154.

- (304) Keilty, T. J., White, D. S., and Landrum, P. F., "Short-Term Lethality and Sediment Avoidance Assays with Endrin-Contaminated Sediment and Two Oligochaetes from Lake Michigan," *Archives of Environmental Contamination and Toxicology*, Vol 17, 1988a, pp. 95-101.
- (305) Howmiller, R. P., and Scott, M. A., "An Environmental Index Based on Relative Abundance of Oligochaete Species," *Journal of Water Pollution Control Federation*, Vol 49 (5), 1977, pp. 809-815.
- (306) Lafont, M., "Oligochaete Communities as Biological Descriptors of Pollution in the Fine Sediments of Rivers," *Hydrobiologia*, Vol 115, 1984, pp. 127-129.
- (307) Lang, C., "Factorial Correspondence Analysis of Oligochaete Communities According to Eutrophication Level," *Hydrobiologia*, Vol 57(3), 1978, pp. 241-247.
- (308) Lang, C., "Quantitative Relationships Between Oligochaete Communities and Phosphorus Concentrations in Lakes," *Freshwater Biology*, Vol 24, 1990, pp. 327-334.
- (309) Lauritsen, D. D., Mozley, S. C., and White, D. S., "Distribution of Oligochaetes in Lake Michigan and Comments of Their Use as Indices of Pollution," *Journal of Great Lakes Research*, Vol 11(1), 1985, pp. 67-76.
- (310) Milbrink, G., "On the Use Indicator Communities of Tubificidae and Some Lumbriculidae in the Assessment of Water Pollution in Swedish Lakes," *Zoon*, Vol 1, 1973, pp. 125-139.
- (311) Milbrink, G., "An Improved Environmental Index Based on the Relative Abundance of Oligochaete Species," *Hydrobiologia*, Vol 102, 1983, pp. 89-97.
- (312) Bailey, H. C., and Lui, D. H. W., "*Lumbriculus variegatus*, A Benthic Oligochaete, as a Bioassay Organism," In *Aquatic Toxicology, Third Symposium*, Eaton, J. C., Parrish, P. R., and Hendricks, A. C. (eds.), American Society for Testing and Materials, Philadelphia, PA, 1980, pp. 205-215.
- (313) Chapman, P. M., Farrell, M. O., and Brinkhurst, R. O., "Relative Tolerances of Selected Aquatic Oligochaetes to Combinations of Pollutants and Environmental Factors," *Aquatic Toxicology*, Vol 2, 1982, pp. 69-78.
- (314) McMurtry, M. J., "Avoidance of Sublethal Doses of Copper and Zinc by Tubificid Oligochaetes," *Journal of Great Lakes Research*, Vol 10, 1984, pp. 267-272.
- (315) Adreani, L., Bonacina, C., Bonomi, G., and Monti, C., "Cohort Cultures of *Psammoryctides barbatus* (Grube) and *Spirosperma ferox* Eisen, A Tool for a Better Understanding of Demographic Strategies in Tubificidae," *Hydrobiologia*, Vol 115, 1984, pp. 113-119.
- (316) Bonacina, C., Bonomi, G., and Monti, C., "Population Analysis in Mass Cultures of *Tubifex tubifex*," *Hydrobiologia*, Vol 180, 1989, pp. 127-134.
- (317) Inase, M., "The Culture Solution of the Eggs of *Tubifex*," *Science Rep. Tohoku University (4) Biology*, Vol 36, 1960, pp. 65-67.
- (318) Kosiorek, D., "Development Cycle of *Tubifex tubifex* (Müller) in Experimental Culture," *Polish Archives of Hydrobiologia*, Vol 21, 1974, pp. 411-422.
- (319) Paoletti, A., "Cohort Cultures of *Tubifex tubifex* Forms," *Hydrobiologia*, Vol 180, 1989, pp. 143-150.
- (320) Reynoldson, T. B., Thompson, S. P., and Bamsey, J. L., "A Sediment Bioassay Using the Tubificid Oligochaete Worm *Tubifex tubifex*," *Environmental Toxicology and Chemistry*, Vol 10, 1991, 1061-1072.
- (321) Milbrink, G., "Biological Characterization of Sediments by Standardized Tubificid Bioassays," *Hydrobiologia*, Vol 155, 1987, pp. 267-275.
- (322) Ladle, M., "The Biology of Oligochaeta From Dorset Chalk Streams," *Freshwater Biology*, Vol 1, 1971, pp. 83-97.
- (323) Reynoldson, T. B., "The Role of Environmental Factors in the Ecology of Tubificid Oligochaetes-An Experimental Study," *Holarctic Ecology*, Vol 10, 1987, pp. 241-248.
- (324) Kaster, J. L., "The Reproductive Biology of *Tubifex tubifex* Müller (Annelida: Tubificidae)," *American Midland Naturalist*, Vol 104, 1980, pp. 364-367.
- (325) Bonacina, C., Bonomi, G., and Monti, C., "Density-Dependent Processes in Cohorts of *Tubifex tubifex*, With Special Emphasis on the Control of Fecundity," *Hydrobiologia*, Vol 180, 1989, pp. 135-141.
- (326) Brinkhurst, R. O., "Guide to the Freshwater Aquatic Microdrile Oligochaetes of North America," *Canadian Special Publication Fisheries Aquatic Science*, Vol 84, 1986.
- (327) Klemm, D. (ed.), "A Guide to the Freshwater Annelida (Polychaeta, Naidid and Tubificid Oligochaeta, and Hirudinea) of North America," Kendall/Hunt Publishing Co., Dubuque, IA, 1985, p. 198.
- (328) Chapman, P. M., and Brinkhurst, R. O., "Hair Today, Gone Tomorrow: Induced Chaetal Changes in Tubificid Oligochaetes," *Hydrobiologia*, Vol 155, 1987, pp. 45-55.
- (329) Keilty, T. J., White, D. S., and Landrum, P. F., "Sublethal Responses to Endrin in Sediment by *Limnodrilus hoffmeisteri* (Tubificidae) and in Mixed-Culture With *Stygodrilus heringianus* (Lumbriculidae)," *Aquatic Toxicology*, Vol 13, 1988, pp. 227-250.
- (330) White, D. S., and Keilty, T. J., "Burrowing Avoidance Assays of Contaminated Detroit River Sediments, Using the Freshwater Oligochaete *Stygodrilus heringianus* (Lumbriculidae)," *Archives of Environmental Contamination and Toxicology*, Vol 17, 1988, pp. 673-681.
- (331) Nalepa, T. F., "Estimates of Macroinvertebrate Biomass in Lake Michigan," *Journal of Great Lakes Research*, Vol 15, pp. 437-443.
- (332) Bousfield, E. L., "Revised Morphological Relationships Within the Amphipod Genera *Pontoporeia* and *Gammaracanthus* and the "Glacial Relict" Significance of Their Postglacial Distributions," *Canadian Journal of Fisheries and Aquatic Sciences*, Vol 46, pp. 1714-1725.
- (333) Segerstrale, S. G., "The Taxonomic Status and Pre-history of the Glacial Relict *Pontoporeia* (Crustacea, Amphipoda) Living in North American Lakes," *Comment. Biol. Soc. Finn.*, Vol 89, pp. 1-18.
- (334) Nalepa, T. F., and Landrum, P. F., Benthic Invertebrates and Contaminant Levels in the Great Lakes: Effects, Fates, and Role in Cycling. In: *Toxic Contaminants and Ecosystem Health: A Great Lakes Focus*, ed. M. S. Evans, John Wiley & Sons, New York, 1988, pp. 77-102.
- (335) Landrum, P. F., and Faust, W. R., Effect of Variation in Sediment Composition on the Uptake Rate Coefficient for Selected PCB and PAH Congeners by the Amphipod, *Diporeia* spp. In: *Aquatic Toxicology and Risk Assessment: Fourteenth Volume*, ASTM STP 1124, eds. M. A. Mayes and M. G. Barron, American Society for Testing and Materials, Philadelphia, 1991a, pp. 263-279.
- (336) Landrum, P. F., Eadie, B. J., and Faust, W. R., "Variation in the Bioavailability of Polycyclic Aromatic Hydrocarbons to the Amphipod *Diporeia* (spp.) With Sediment Aging," *Environmental Toxicology and Chemistry*, Vol 11, pp. 1197-1208; Landrum, P. F., Faust, W. R., and Eadie, B. J. 1989. Bioavailability and Toxicity of a Mixture of Sediment-Associated Chlorinated Hydrocarbons to the Amphipod *Pontoporeia hoyi*. In: *Aquatic Toxicology and Hazard Assessment: 12th Volume*, ASTM STP 1027, eds. U. M. Cowgill and L. R. Williams. American Society for Testing and Materials, Philadelphia, 1992, pp. 315-329.
- (337) Landrum, P. F., Eadie, B. J., and Faust, W. R., "Toxicokinetics and Toxicity of a Mixture of Sediment-Associated Polycyclic Aromatic Hydrocarbons to the Amphipod *Diporeia* spp.," *Environmental Toxicology and Chemistry*, Vol 10, 1991b, pp. 35-46.
- (338) Dermott, R., and Munawar, M., "A Simple and Sensitive Assay for Evaluation of Sediment Toxicity Using *Lumbriculus variegatus* (Muller)," *Hydrobiologia*, 1992, pp. 235/236:407-414.
- (339) Bahnick, D. A., Swenson, W. A., Markee, T. P., Call, D. J., Anderson, C. A., and Arris, R. T., Development of Bioassay Procedures for Defining Pollution of Harbor Sediments, Final

Report U.S. EPA Project No. R804918-01, Central Lake Superior Environmental Study, University of Wisconsin, Superior, 1980.

- (340) Gannon, J. E., and Beeton, A. M., "Procedures for Determining the Effects of Dredged Sediments on Biotabenthos Viability and Sediment Selectivity Tests," *Journal of the Water Pollution Control Federation*, Vol 43, 1971, pp. 392-398.
- (341) Landrum, P. F., and Dupuis, W. S., Toxicity and Toxicokinetics of Pentachlorophenol and Carbaryl to *Pontoporeia hoyi* and *Mysis relicta*. In: *Aquatic Toxicology and Risk Assessment: Thirteenth Volume*, ASTM STP 1096, eds. W. G. Landis and W. H. van der Schalie, American Society for Testing and Materials, Philadelphia, 1990, pp. 278-289.
- (342) Gossiaux, D. C., Landrum, P. F., and Tsymbal, V. N., "A Survey of Saginaw River and Saginaw Bay, Lake Huron, Sediments Using Two Bioassays With the Amphipod *Diporeia* spp.," *Journal of Great Lakes Research*, Vol 19, 1993, pp. 322-332.
- (343) Gannon, J. E., and Beeton, A. M., Studies on the Effects of Dredged Materials From Selected Great Lakes Harbors on Plankton and Benthos. Special Report No. 8, Center for Great Lakes, University of Wisconsin, Milwaukee, 1969.
- (344) Gossiaux, D. C., Landrum, P. F., and Tsymbal, V. N., "Response of the Amphipod, *Diporeia* spp., to Various Stressors: Cadmium, Salinity, and Temperature," *Journal of Great Lakes Research*, Vol 18, 1992, pp. 364-371.
- (345) Marsolf, G. R., "Substrate Relations of the Burrowing Amphipod *Pontoporeia affinis* in Lake Michigan," *Ecology*, Vol 46, 1965, pp. 579-592.
- (346) Nalepa, T. F., Quigley, M. A., Childs, K. F., Gauvin, J. M., Heatlie, T. S., Parker, M. P., and Vanover, L., *Macrobenthos of Southern Lake Michigan, 1980-81*. NOAA Data Report ERL GLERL-28, National Oceanic and Atmospheric Administration, Ann Arbor, MI, 1985.
- (347) Juday, C. and Birge, E. A., "Pontoporeia and Mysis in Wisconsin Lakes," *Ecology*, Vol 8, 1927, pp. 445-452.
- (348) Lubner, J. F., Population Dynamics and Production of the Relict Amphipod, *Pontoporeia hoyi*, at Several Lake Michigan Stations. Ph.D. Thesis. University of Wisconsin, Milwaukee, 1979, 96 p.
- (349) Winnell, M. H., and White, D. S., "Ecology of Shallow and Deep Water Populations of *Pontoporeia hoyi* (Smith) (Amphipoda) in Lake Michigan," *Freshwater Invertebrate Biology*, Vol 3, 1984, pp. 118-138.
- (350) Gardner, W. S., Quigley, M. A., Fahnensteil, G. L., Scavia, D., and Frez, W. A., *Pontoporeia hoyi*-A Direct Trophic Link Between Spring Diatoms and Fish in Lake Michigan. In: *Large Lakes: Ecological Structure and Function*, eds. M. M. Tilzer and C. Serruya, Springer-Verlag, New York, 1990, pp. 632-644.
- (351) Gardner, W. S., Nalepa, T. F., Frez, W. A., Cichocki, E. A., and Landrum, P. F., "Seasonal Patterns in Lipid Content of Lake Michigan Macroinvertebrates," *Canadian Journal of Fisheries and Aquatic Sciences*, Vol 42, 1985, pp. 1827-1832.
- (352) Landrum, P. F., "Uptake, Depuration and Biotransformation of Anthracene By the Scud *Pontoporeia hoyi*," *Chemosphere*, Vol 11, 1982, pp. 1049-1057.
- (353) Quigley, M. A., Cavaletto, J. F., Gardner, W. S., "Lipid Composition Related to Size and Maturity of the Amphipod *Pontoporeia hoyi*," *Journal of Great Lakes Research*, Vol 15, 1989, pp. 601-610.
- (354) Landrum, P. F., "Toxicokinetics of Organic Xenobiotics in the Amphipod, *Pontoporeia hoyi*: Role of Physiological and Environmental Variables," *Aquatic Toxicology*, Vol 12, 1988, pp. 245-271.
- (355) Gauvin, J. M., Gardner, W. S., and Quigley, M. A., "Effects of Food Removal on Nutrient Release Rates and Lipid Content of Lake Michigan *Pontoporeia hoyi*," *Canadian Journal of Fisheries and Aquatic Sciences*, Vol 46, 1989, pp. 1125-1130.
- (356) Nelson, M. K., Landrum, P. F., Burton, G. A., Klaine, S. J., Crecelius, E. A., Byl, T. D., Gossiaux, D. C., Tsymbal, V. N., Cleveland, L., Ingersoll, C. G., and Sasson-Brickson, G., "Toxicity of Contaminated Sediments in Dilution Series With Control Sediments," *Chemosphere*, Vol 27, pp. 1789-1812.
- (357) Dillon, T. M., and Gibson, A. B., Bioassessment Methodologies for the Regulatory Testing of Freshwater Dredged Material, Miscellaneous Paper EL-86-6, U.S. Army Engineer Waterways Experiment Station, Vicksburg, MS, 1986.
- (358) Day, K.E., Dutka, B.J., Kwan, K.K., Batista, N., Reynoldson, T.B., and Metcalfe-Smith, J.L. Correlations between solid-phase microbial screening assays, whole-sediment toxicity test with macroinvertebrates and in situ benthic community structure. *J. Great Lakes Res.* 21: 192–206, 1995.
- (359) Kubitz, J.A., Besser, J.M., and Giesy, J.P. A two-step experimental design for a sediment bioassay using growth of amphipod *Hyaella azteca* for the test endpoint. *Environ. Toxicol. Chem* 15: 1783–1792, 1996.
- (360) Tomasovic, M.J., Dwyer, F.J., Greer, I.E., and Ingersoll, C.G. Recovery of known-age *Hyaella azteca* (Amphipoda) from sediment toxicity tests. *Environ. Toxicol. Chem.* 14:1177-1180, 1995.
- (361) Landrum, P.F., and Scavia, D., Influence of sediment on anthracene uptake, depuration, and biotransformation by the amphipod, *Hyaella azteca*. *Can. J. Fish. Aquat. Sci.* 40: 298–305, 1983.
- (362) Kane Driscoll S., Landrum, P.F., and Tigue, E. Accumulation and toxicokinetics of fluoranthene in water-only exposures with freshwater amphipods, *Environ. Toxicol. Chem.* 17: 754-761, 1997.
- (363) Brasher, A.M. and Ogle, R.S. Comparative toxicity of selenite and selenate to the amphipod *Hyaella azteca*. *Arch. Environ. Contam. Toxicol.* 24: 182-186, 1993.
- (364) Borgmann, U. Chronic toxicity of ammonia to the amphipod *Hyaella azteca*; Importance of ammonium ion and water hardness. *Environ. Pollut.* 86: 329-335, 1994.
- (365) Kubitz, J.A., Besser, J.M., and Giesy, J.P. A two-step experimental design for a sediment bioassay using growth of amphipod *Hyaella azteca* for the test endpoint. *Environ. Toxicol. Chem.* 15:1783-1792, 1996.
- (366) Milani, D., Day, K.E., McLeay, D.J., and Kirby, R.S. Recent intra- and interlaboratory studies related to the development and standardization of Environment Canada's biological test methods for measuring sediment toxicity using freshwater amphipods (*Hyaella azteca*) or midge larvae (*Chironomus riparius*), Environment Canada, Burlington, ONT. 1996.
- (367) Steevens, J.A. and Benson, W.H. *Hyaella azteca* 10-day sediment toxicity test: Comparison of growth measurement endpoints. *Environ. Toxicol. Water Qual.* 13: 243-248, 1998.
- (368) McNulty, E.W., Dwyer, F.J., Ellersieck, M.R., Greer, I.E., Ingersoll, C.G., and Rabeni, C.F. Evaluation of the ability of reference-toxicity tests to identify stress in laboratory populations of the amphipod *Hyaella azteca*. *Environ. Toxicol. Chem.* 18:544-548, 1999.
- (369) Borgmann, U. Systematic analysis of aqueous ion requirements of *Hyaella azteca*; A standard artificial medium including the essential bromide ion. *Arch. Environ. Contam. Toxicol.* 30:356-363, 1996.
- (370) Brunson, E.L., Canfield, T.J., Dwyer, F.J., Kemble, N.E., and Ingersoll, C.G. Assessing bioaccumulation of contaminated sediments from the upper Mississippi River using field-collected oligochaetes and laboratory-exposed *Lumbriculus variegatus*. *Arch. Environ. Contam. Toxicol.* 35:191-201, 1998.
- (371) Wall, D.V., London, J., Warren, J.E., Gossett, R., Wenholtz, M.D., and Klaine, S.J. 1998. Development of a continuous-flow renewal system for sediment toxicity testing. *Environ. Toxicol. Chem.* 17:1159 -1164.
- (372) Tomasovic, M.J., Dwyer, F.J., Greer, I.E., and Ingersoll, C.G., Recovery of known-age *Hyaella azteca* (Amphipoda) from sediment toxicity tests. *Environ. Toxicol. Chem.* 14: 1177–1180, 1995.
- (373) Gaston, G.R., Bartlett, J.H. McAllister, A.P., and Heard, R.W. Biomass variations of estuarine macrobenthos preserved in ethanol and formalin. *Estuaries* 19:674–679. 1996.

- (374) Duke, B.M., Moore, D.W., and Farrar, J.D. Effects of preservation on dry weight and length measurements using *Leptocheirus plumulosus*. Abstract presented at the 17th SETAC annual meeting in Washington, DC, November 17-21, 1996.
- (375) Ernsting, G., Zonneveld, C., Issaks, J.A., and Kroon, A. Size at maturity and patterns of Growth and reproduction in an insect with indeterminate growth. *Oikos* 66:17–26, 1993.
- (376) Moore, D.W., and Dillon, T.M., the relationship between growth and reproduction in the marine polychaete *Nereis (Neanthes) arenaceodentata* (Moore): Implications for chronic sublethal sediment bioassays, *J. Exp. Mar. Biol. Ecol.* 173: 231–246, 1993.
- (377) Enserink, E.L., Kerhofs, M.J.J., Baltus, C.A.M., and Koeman, J.H. Influence of food quantity and lead exposer on maturation on *Daphia magna*; evidence for a trade-off mechanism. *Functional Ecology* 9: 175–185, 1995.
- (378) Hargrave, B.T. Distribution, growth, and seasonal abundance of *Hyaella azteca* (amphipod) in relation to sediment microflora, *J. Fish. Res. Bd. Can.* 27:685–699, 1970b.
- (379) Strong, D.R. Life history variation among populations of an amphipod (*Hyaella azteca*), *Ecology* 53: 1103–1111, 1972.
- (380) Wen, Y.H. Sexual dimorphism and male choice in *Hyaella azteca*. *AM. Midl. Nat.* 129:153–160, 1993.
- (381) France, R.L. Biogeographical variation in size-specific fecundity of the amphipod *Hyaella azteca* *Crustaceana* 62: 240–248, 1992.
- (382) USEPA. Calculation and evaluation of sediment effect concentrations for the amphipod *Hyaella azteca* and the midge *Chironomus riparius*, EPA 905–R96–008, Chicago, IL, 1996.
- (383) Milani, D., Day, K.E., McLeay, D.J. and Kirby, R.S., Recent intra- and interlaboratory studies related to the development and standardization of Environment Canada’s biological test methods for measuring sediment toxicity using freshwater amphipods (*Hyaella azteca*) or midge larvae (*Chironomus riparius*), Environment Canada, Burlington, ONT, 1996.
- (384) Brasher, A.M. and Ogle, R.S. Comparative toxicity of selenite and selenate to the amphipod *Hyaella azteca*. *Arch. Environ. Contam. Toxicol.* 24:182–186, 1993.
- (385) Ramirez-Romero, P. Evaluation of the acute and Chronic toxicity of Fluoranthene-spiked sediments in the presence of UV light using the amphipod, *Hyaella azteca*. Ph.D Dissertation, Miami University, Oxford, OH, 130 pages, 1997.
- (386) Ingersoll, C.G., Ankley, G.T., Benoit, D.A., Burton, G.A., Dwyer, F. J., Greer, I.E., Norberg-King, T.J., and Winger, P.V. Toxicity and bioaccumulation of sediment-associated Contaminants with freshwater invertebrates: A review of methods and applications. *Environ. Toxicol. Chem.* 14:1885–1894, 1995.
- (387) Ball, S.L. and Baker, R.L. The non-lethal effects of predators and the influence of food availability on the life history of adult *Chironomus tentans*. (Diptera: Chironomidae). *Freshwater Biology* 34:1–12, 1995.
- (388) Lacey, R., Watzin, M.C., and McIntosh, A.W. Sediment organic matter content as a confounding factor in toxicity tests with *Chironomus tentans*. *Environ. Toxicol. Chem.* 18:231–236, 1999
- (389) Pascoe, D., Williams, K.A., and Green, D.W.J. Chronic toxicity of cadmium to *Chironomus riparius* Meighen-effects upon larval development and adult emergence. *Hydrobiologia.* 175: 109–115, 1989.
- (390) Hilsenhoff, W.L. The biology of *Chironomus plumulosus* (Diptera: Chironomidae) in lake Winnebago, Wisconsin, *Ann. Entomol. Soc. Am.* 59: 365–473, 1966.
- (391) Liber, K., Call, D.J., Dawson, T.D., Whiteman, F.W., and Dillon, T.M., Effects of *Chironomus tentans* larval growth retardation on adult emergence and ovipositing success: Implications for interpreting freshwater sediment bioassays. *Hydrobiologia*, 323: 155–167, 1996.
- (392) USEPA. The *Selenastrum capricornutum* Printz Algal Assay Bottle Test. EPA-600/9-78-018, Corvallis, OR, 1978.
- (393) APHA. Part 8010E.4.b. In: Standard Methods for the Examination of Water and Wastewater. 18th edition. American Public Health Association, Washington, DC. pp. 8-10, 1992.
- (394) Ingersoll, C. G., “Sediment Toxicity and Bioaccumulation Testing,” *Standardization News*, Vol 19, 1991, pp. 28-33.
- (395) Burton, G. A., Nelson, M. K., and Ingersoll, C. G., Freshwater Benthic Toxicity Tests, In: G. A. Burton (ed.), *Sediment Toxicity Assessment*, Lewis Publishers, Chelsea, MI, 1992, pp. 213 -240.
- (396) Tatem, H. E., Brandon, D. L., Lee, C. R., Jarvis, A. S., and Rhett, R. G., “Effects of Storage on Sediment Toxicity, Bioaccumulation Potential and Chemistry,” *U.S. Army Corps of Engineers, Waterways Experiment Station*, Miscellaneous Paper EL-91-2, 1991, p. 62.
- (397) Moore, D. W., and Dillon, T. W., “Effect of Storage Time on Sediment Toxicity,” *Environmental Pollution*, Vol 89( 2), 1995, pp. 147-154.
- (398) Schults, D. W., Ferraro, S. P., Smith, L. M., Roberts, F. A., and Poindexter, C. K., “A Comparison of Methods for Collecting Interstitial Water for Trace Organic Compounds and Metal Analyses,” *Water Research*, Vol 26, 1992, pp. 989-995.
- (399) Suedel, B.C., Rodgers, J. Jr., and Clifford, P.A., Bioavailability of fluoranthene in freshwater sediment toxicity tests. *Environ. Toxicol. Chem.* 12: 155–165, 1993.
- (400) APHA. Standard methods for the examination of water and wastewater. American Public Health Association, Washington, DC, 1989.
- (401) Borgmann, U. Chronic Toxicity of ammonia to the amphipod *Hyaella azteca*; Importance of ammonium ion and water hardness. *Environ. Pollut.* 86:329–335, 1994.
- (402) Brunson, E.L., Ankley, G.T., Burton, G.A., Dwyer, F.J., Ingersoll, C.G. Landrum, P.F., Lee, H. and Phipps, G.L. Bioaccumulation kinetics and field validation of whole-sediment exposer with the oligochaete, *Lumbriculus variegatus*. Abstract presented at the 14th annual meeting of SETAC, Houston, TX, November 14–18, 1993.
- (403) Carr, R.S. and Chapman, D.C. Comparison of solid-phase and pore-water approaches for assessing the quality of estuarine sediments. *Chemistry and Ecology* 7: 19–30, 1992.
- (404) Davis R.B., A.J. Bailer, and J.T. Oris, Effects of organism allocation on toxicity test results. *Environ. Toxicol. Chem.* 17: 928–931, 1998.
- (405) de Boer, J. Chlorobiphenyls in bound and non-bound lipids of fishes: Comparison of different extraction methods, *Chemosphere* 17: 1803–1810, 1988.
- (406) Duke, B.M., Moore, D.W., and Farrar, J.D., Effects of preservation on dry weight and length measurements using *Leptocheirus plumulosus*. Abstract presented at the 17th SETAC annual meeting in Washington, DC, November 17–21, 1996.
- (407) Harkley, G.A., Kane Driscoll, S., and Landrum P. Effect of feeding in 30-day bioaccumulation assays using *Hyaella azteca* in fluoranthene-dosed sediment. *Environ. Toxicol. Chem.* 16: 762–769, 1997.
- (408) Kane Driscoll S., Landrum, P.F., and Tigue, E., Accumulation and toxicokinetics of fluoranthene in water only exposures with freshwater amphipods. *Environ. Toxicol. Chem.* 16:754–761, 1997.
- (409) Lacy, R., Watzin, M.C., McIntosh, A.W. Sediment organic matter content as confounding factor in toxicity tests with *Chironomus tentans* *Environ. Toxicol. Chem.*: In Press, 1998.
- (410) Moore, D.W., Dillon, T.M., and Gamble, E.W., Long-term storage of sediments: Implications for sediment toxicity testing. *Environ. Pollut.* 89: 341–342, 1996.
- (411) Obana, H., Hori, S., and Kushimoto, T., Determination of polycyclic aromatic hydrocarbons, i.e., marine samples, by high performance liquid- chromatography. *Bull. Environ. Contam. Toxicol.* 26: 613–620, 1981.

**SUMMARY OF CHANGES**

Committee E47 has identified the location of selected changes to this standard since the last issue E1706–04, that may impact the use of this standard. (Approved Mar. 1, 2005)

(1) Note 1 was added to section 1.1.1.

Committee E47 has identified the location of selected changes to this standard since the last issue E1706–00e2, that may impact the use of this standard. (Approved Dec. 1, 2004)

(1) Reference to *Chironomus tentans* was changed to *Chironomus dilutus* throughout the standard.

(2) New footnote 1 was added.

(3) In section 1.8 and Annex 2 *Daphnia* was changed to *Daphnia*.

*ASTM International takes no position respecting the validity of any patent rights asserted in connection with any item mentioned in this standard. Users of this standard are expressly advised that determination of the validity of any such patent rights, and the risk of infringement of such rights, are entirely their own responsibility.*

*This standard is subject to revision at any time by the responsible technical committee and must be reviewed every five years and if not revised, either reapproved or withdrawn. Your comments are invited either for revision of this standard or for additional standards and should be addressed to ASTM International Headquarters. Your comments will receive careful consideration at a meeting of the responsible technical committee, which you may attend. If you feel that your comments have not received a fair hearing you should make your views known to the ASTM Committee on Standards, at the address shown below.*

*This standard is copyrighted by ASTM International, 100 Barr Harbor Drive, PO Box C700, West Conshohocken, PA 19428-2959, United States. Individual reprints (single or multiple copies) of this standard may be obtained by contacting ASTM at the above address or at 610-832-9585 (phone), 610-832-9555 (fax), or service@astm.org (e-mail); or through the ASTM website (www.astm.org). Permission rights to photocopy the standard may also be secured from the Copyright Clearance Center, 222 Rosewood Drive, Danvers, MA 01923, Tel: (978) 646-2600; <http://www.copyright.com/>*