



Standard Test Method for Boiling Point Distribution of Samples with Residues Such as Crude Oils and Atmospheric and Vacuum Residues by High Temperature Gas Chromatography¹

This standard is issued under the fixed designation D7169; the number immediately following the designation indicates the year of original adoption or, in the case of revision, the year of last revision. A number in parentheses indicates the year of last reapproval. A superscript epsilon (ϵ) indicates an editorial change since the last revision or reapproval.

1. Scope*

1.1 This test method covers the determination of the boiling point distribution and cut point intervals of crude oils and residues by using high temperature gas chromatography. The amount of residue (or sample recovery) is determined using an external standard.

1.2 This test method extends the applicability of simulated distillation to samples that do not elute completely from the chromatographic system. This test method is used to determine the boiling point distribution through a temperature of 720 °C. This temperature corresponds to the elution of n -C₁₀₀.

1.3 This test method is used for the determination of boiling point distribution of crude oils. This test method uses capillary columns with thin films, which results in the incomplete separation of C₄-C₈ in the presence of large amounts of carbon disulfide, and thus yields an unreliable boiling point distribution corresponding to this elution interval. In addition, quenching of the response of the detector employed to hydrocarbons eluting during carbon disulfide elution, results in unreliable quantitative analysis of the boiling distribution in the C₄-C₈ region. Since the detector does not quantitatively measure the carbon disulfide, its subtraction from the sample using a solvent-only injection and corrections to this region via quenching factors, results in an approximate determination of the net chromatographic area. A separate, higher resolution gas chromatograph (GC) analysis of the light end portion of the sample may be necessary in order to obtain a more accurate description of the boiling point curve in the interval in question as described in Test Method D7900 (see Appendix X1).

1.4 This test method is also designed to obtain the boiling point distribution of other incompletely eluting samples such as atmospheric residues, vacuum residues, etc., that are characterized by the fact that the sample components are resolved from the solvent.

1.5 This test method is not applicable for the analysis of materials containing a heterogeneous component such as polyesters and polyolefins.

1.6 The values stated in inch-pound units are to be regarded as standard. The values given in parentheses are mathematical conversions to SI units that are provided for information only and are not considered standard.

1.7 *This standard does not purport to address all of the safety concerns, if any, associated with its use. It is the responsibility of the user of this standard to establish appropriate safety and health practices and determine the applicability of regulatory limitations prior to use.* Specific warning statements are given in Section 8.

2. Referenced Documents

2.1 ASTM Standards:²

- D2887 Test Method for Boiling Range Distribution of Petroleum Fractions by Gas Chromatography
- D2892 Test Method for Distillation of Crude Petroleum (15-Theoretical Plate Column)
- D4057 Practice for Manual Sampling of Petroleum and Petroleum Products
- D6352 Test Method for Boiling Range Distribution of Petroleum Distillates in Boiling Range from 174 °C to 700 °C by Gas Chromatography
- D7500 Test Method for Determination of Boiling Range Distribution of Distillates and Lubricating Base Oils—in Boiling Range from 100 °C to 735 °C by Gas Chromatography
- D7900 Test Method for Determination of Light Hydrocarbons in Stabilized Crude Oils by Gas Chromatography
- E594 Practice for Testing Flame Ionization Detectors Used in Gas or Supercritical Fluid Chromatography
- E1510 Practice for Installing Fused Silica Open Tubular Capillary Columns in Gas Chromatographs

¹ This test method is under the jurisdiction of ASTM Committee D02 on Petroleum Products, Liquid Fuels, and Lubricants and is the direct responsibility of Subcommittee D02.04.0H on Chromatographic Distribution Methods.

Current edition approved Oct. 15, 2016. Published November 2016. Originally approved in 2005. Last previous editing approved in 2011 as D7169 – 11. DOI: 10.1520/D7169-16.

² For referenced ASTM standards, visit the ASTM website, www.astm.org, or contact ASTM Customer Service at service@astm.org. For *Annual Book of ASTM Standards* volume information, refer to the standard's Document Summary page on the ASTM website.

*A Summary of Changes section appears at the end of this standard

3. Terminology

3.1 Definitions of Terms Specific to This Standard:

3.1.1 *cut point interval, n*—the mass % obtained between two selected temperatures of the interval.

3.1.2 *data acquisition rate, n*—the speed of conversion of the analog signal to a digital signal, expressed in Hz (cycles/second).

3.1.3 *final boiling point (FBP), n*—the temperature, for fully eluting samples (recovery = 100 %), at which 99.5 % of the sample is eluted.

3.1.4 *final elution time (FEt), n*—the retention time of the component of the reference time standard sample that elutes at the end of the temperature ramp of the oven.

3.1.5 *final elution temperature (FET), n*—the boiling point of the normal paraffin that elutes at the time when the oven reaches its final temperature.

3.1.6 *initial boiling point (IBP), n*—the temperature corresponding to an accumulated 0.5 % of the total area of the eluted sample after correcting for the percent of sample recovery.

3.1.7 *quenching factor (QF), n*—a number that corrects for the diminished response due to the solvent profile co-eluting with sample components.

3.1.7.1 *Discussion*—Data acquired during the quenching interval (QI) shall be corrected by applying the quenching factor.

3.1.8 *quenching interval (QI), n*—the time interval of the start and end of elution of the CS₂ used as a solvent.

3.1.8.1 *Discussion*—Sample components that elute during this time interval shall be corrected by a factor due to their diminished response resulting from the co-elution of the relatively large amount of solvent present in the sample with the light sample components.

3.1.9 *residue (R), n*—the mass % of the sample that has not eluted at the temperature of calculation.

3.1.9.1 *Discussion*—Residue is calculated from the %recovery.

3.1.10 *response factor (RF), n*—the factor used in order to calculate the %recovery of the sample.

3.1.10.1 *Discussion*—The response factor is determined from the net area of the standard (A_{STD}), mass of standard (M_{STD}), and mass of solvent (M_{SLSTD}) used in the solution of the standard. A fully eluting sample, such as Reference Oil 5010, is used in obtaining the response factor.

3.1.11 *sample area obtained (A_{SMP}), n*—the net chromatographic area (after baseline subtraction) obtained for the sample at the final elution time or temperature.

3.1.12 *slice, n*—the reciprocal of the data acquisition rate; the time interval used to accumulate data, expressed in seconds.

3.1.12.1 *Discussion*—Normally 0.1 s is used. In cases where sample elutes immediately after injection, 0.05 s is used.

3.1.13 *start elution temperature (SET), n*—the temperature at which the first amount of hydrocarbon is detected by the flame ionization detector above a predetermined threshold.

3.1.14 *%recovery (RC), n*—percentage of the sample eluted.

3.1.14.1 *Discussion*—%Recovery is calculated from the sample area (A_{SMP}), the response factor (RF), the sample mass, (M_{SMP}), and the solvent mass (M_{SLSMP}) used in sample dissolution.

3.1.15 *%recovery threshold (R_t), n*—if the %recovery falls above a preset limit, the sample is considered fully eluted and its recovery is assumed to be 100 %.

3.1.15.1 *Discussion*—If the %recovery values found for duplicate analyses of a nearly completely eluting sample are 99.6 % and 101.2 %, the %recovery threshold (R_t) may be set to 99.6 % and thus either of these results may be considered as fully eluted and set to 100 %.

3.2 Symbols:

3.2.1 A_{SMP} —net area of the sample

3.2.2 A_{STD} —net area of the response factor standard

3.2.3 M_{SL} —mass of solvent used in preparing sample solution

3.2.4 M_{SLSTD} —mass of solvent used in preparing the response factor standard solution

3.2.5 M_{SMP} —sample mass used in sample preparation

3.2.6 M_{STD} —mass of the standard used in preparing the response factor solution

4. Summary of Test Method

4.1 This is a gas chromatographic method utilizing an inlet and a capillary column, both of which are subject to a temperature program. A flame ionization detector is used as a transducer that converts mass to an electrical signal. A data acquisition system operating in the slice mode and chromatography software is used to accumulate the electronic signal. A retention time calibration mixture is used to develop a retention time versus boiling point curve. A solution of the Reference Oil 5010 or a gravimetric blend, which fully elutes from the column under the conditions of the test method and whose boiling point distribution have been characterized in Test Method **D6352** or **D7500**, is used to determine the detector response factor. Solvent injections are made, and the resulting signal is subtracted from both the response factor standard and the sample chromatogram. Finally, the sample solution is injected and with the use of the response factor, the amount of sample recovered is calculated. After converting the retention times of the sample slices to temperature, the boiling point distribution can be calculated up to the recovered amount.

5. Significance and Use

5.1 The determination of the boiling point distribution of crude oils and vacuum residues, as well as other petroleum fractions, yields important information for refinery operation. These boiling point distributions provide information as to the potential mass percent yield of products. This test method may provide useful information that can aid in establishing operational conditions in the refinery. Knowledge of the amount of residue produced is important in determining the economics of the refining process.

6. Apparatus

6.1 *Gas Chromatograph*—A gas chromatograph provided with a cryogenic valve for cooling the oven to sub ambient temperatures is required. Typical conditions of operating the Gas Chromatograph are given in [Table 1](#). It shall also have the following components:

6.1.1 *Flame Ionization Detector (FID)*—A flame ionization detector capable of maintaining a temperature 5 °C to 10 °C higher than the highest column temperature. The flame ionization detector should possess a jet orifice of about 0.018 in. (0.45 mm) in order to delay the plugging of the orifice due to column bleed. The FID should possess a sensitivity of 0.005 coulombs/g (see Practice [E594](#)) and should have a linear range of 10⁶.

6.1.2 *Inlet*—Either a temperature programmable inlet with a glass liner or a cool-on-column inlet can be used. The inlet shall be capable of operating in a temperature-programmed mode from 50 °C to the final temperature of the oven. It is important that the temperature of the inlet, at any time during the analysis, be either equal to or greater than the oven temperature. With the use of either inlet, frequent replacement of the liner or removal of a section of the column may be required due to accumulation of non-volatile sample components. It is important that a leak free seal be reestablished after replacement of the liner or the removal of a small section of the column.

6.2 *Carrier Gas Purification System*—Gas purifiers are used in order to remove traces of oxygen as well as moisture and other impurities present in the carrier gas. The purification system should contain a hydrocarbon trap and an oxygen trap.

TABLE 1 Typical Gas Chromatographic Conditions^A

Initial Oven Temperature	–20 °C
Initial Oven Time	0 min
Oven Temperature Program	15 °C/min
Final Oven Temperature	425 °C to 435 °C ^B
Final Hold Time	10 min
Inlet Initial Temperature ^C	50 °C
Inlet Temperature Program	15 °C/min
Inlet Final Temperature	425 °C
Column	5 m × 0.53 mm × 0.09 ^B –0.15 µm PDMS
Column Flow	20 mL/min
Carrier Control	Constant Flow
Detector ^D	FID
Detector Temperature	435 °C
Detector Gases:	
Hydrogen	40 mL/min
Air	450 mL/min
Make-Up (N ₂ , He)	15 mL/min
Volume Injected	0.2 µL–0.5 µL–1.0 µL ^B
Sample Concentration	2.0 % (m/m)
Data Acquisition Rate	10 Hz
Total Acquisition Time	40 min to 50 min

^A Conditions used for the interlaboratory study.

^B Several participants used these conditions. Higher temperatures yield higher recoveries.

^C Use lowest temperature recommended by manufacturer.

^D Use GC manufacturer's recommendations.

The latter should preferably have a visible indicator in order to assess the remaining capacity of the oxygen trap.

6.3 *Data System*—A data system composed of a computer and software for data acquisition, which digitizes the detector signal, is recommended. Some instrumentation digitizes the signal at the electrometer board in order to reduce noise. The data system is used at acquisition rates of about 10 Hz, which correspond to slices of 0.1 s. This rate of data acquisition is necessary to obtain a minimum number of slices void of sample or solvent elution immediately after injection. Data acquisition systems facilitate the inspection of the baseline under high magnification and allow the inspection of the retention time calibration mixture chromatogram. Retention time shifts can be measured. Overlaying chromatograms is also possible to ascertain similar signal amplitude.

6.4 *Automatic Sample Injector*—It is mandatory to use an auto sampler since the external standard technique used in this analysis requires identical volumes for all injections. Additionally, small volumes (0.1 µL to 0.2 µL) shall be injected in a reproducible manner. Syringes of 5 µL to 10 µL having needle gauges of size 23 to 26 are to be used.

6.5 *Carrier Gas Control*—The gas chromatograph shall be operated under constant flow conditions. The flow rate at the beginning of the oven temperature program shall not differ by more than 1 % from the flow measured at the final oven temperature. Electronic pneumatic control is highly recommended.

7. Column and Column Performance Criteria

7.1 A 100 % bonded polydimethylsiloxane column having a nominal inside diameter of 0.5 mm and a film thickness of 0.09 µm to 0.17 µm is used.

7.2 The column used should be capable of sustaining temperatures of 435 °C under temperature programming. Aluminum covered fused silica and metal columns have been successfully used.

7.3 The column should be capable of eluting carbon number 100 at its highest temperature. It is important that C₁₀₀ be eluted during the temperature program cycle of the oven.

7.4 Column resolution is determined from the separation of carbons 50 and 52 in the retention time calibration mixture chromatogram. The resolution should be between 1.8 to 4.0. See [Eq 1](#) in [13.1](#).

7.5 The column shall be capable of allowing the start of the elution of *n*-C₅ prior to the solvent elution, which is CS₂, at –20 °C. The descending edge of the *n*-C₅ peak co-elutes with the solvent. It is to be noted that at these low temperatures liquid phases may turn solid, and retention shifts may be observed during the elution of compounds at these low oven temperatures.

7.6 *Column Overloading*—The prevention of column overloading is carried out by determining the skewness of a selected peak among the components of the retention time calibration mixture chromatogram. Any paraffin with a carbon number between C₁₂ and C₂₄ may be chosen. The skewness should be between 0.8 and 2.0. See [Eq 2](#) in [13.2](#).

7.7 *Column Flow*—Helium is used as carrier. Column flow rate is set to 20 mL/min.

8. Reagents and Materials

8.1 *Carbon Disulfide* (CS_2), 99+ % pure. (**Warning**—Extremely flammable and toxic liquid.) Used as a solvent to dilute the sample and standards as well. Use gloves and safety glasses when handling the CS_2 in a well-ventilated area or fume hood. It is recommended to use adjustable-volume bottle dispensers and/or pipettors to minimize direct handling and avoid cross-contamination of CS_2 . Wash vials containing CS_2 should be capped with a solvent resistant septa.

8.2 *Polywax 655 or Polywax 1000*—Used as a component of the retention time calibration mixture. Since these Polywaxes have carbon 22 as the first component, it shall be complemented with the mixture of paraffins described in 8.4.1 and 8.4.3 so that the entire range of carbon numbers (C_5 - C_{100}) is present in the sample.

8.3 *Paraffins*—The following normal paraffins are used in the preparation of the retention time calibration mixture:

pentane	undecane	heptadecane
hexane	dodecane	octadecane
heptane	tridecane	nonadecane
octane	tetradecane	eicosane
nonane	pentadecane	tetracontane
decane	hexadecane	

8.3.1 The purities of these compounds should be 99 % or greater.

8.4 *Retention Time Calibration Standard*—This standard can be obtained from chromatography supply companies. This standard is composed of a mixture of Polywax (either P655 or P1000) as well as a mixture of paraffins. The addition of the paraffin mixture is necessary to cover the range of C_5 - C_{20} since these paraffins are absent in the Polywax. Furthermore the amounts of the paraffins are chosen so as to facilitate identifying the carbons in the retention time calibration mixture chromatogram. Alternatively, a successful mixture that has been used may be prepared by the procedure described in 8.4.1 – 8.4.3 which requires the preparation first of the n -paraffin mixture (see 8.3) and then spiking an aliquot of this mix to a weighed amount of Polywax 655 or 1000.

8.4.1 Place approximately 20 mL of CS_2 into a round bottom 50 mL flask. Transfer with care.

8.4.2 Prepare a mixture of the paraffins listed in 8.3 as follows. Weigh 500 mg of each component into a 20 mL vial. Add an additional 500 mg for dodecane and about 20 mg of tetracontane. Store this mixture at 4 °C and use it as a spiking mixture in the preparation of the Polywax 655 retention time calibration mixture. These additional quantities are spiked to ease the identification of the n -paraffins; other n -paraffins may be chosen as peak markers.

8.4.3 Weigh about 25 mg of the Polywax 655 and add it to the vessel prepared in 8.4.1. Add approximately 10 mg of the paraffin spiking mixture prepared in 8.4.2. Stir the solution under a fume hood and heat with an infrared lamp (about 200 W) placed at a safe distance (about 15 cm to 20 cm) from the mixture for a period of 20 min or until the solution is clear.

Other precautionary methods of dissolution are acceptable. Careful attention should be given to avoid the ignition of the CS_2 (see 8.1).

8.4.4 Transfer a 2 mL aliquot of the final mixture obtained in 8.4.3 into a 2 mL auto sampler vial and seal it firmly. This solution can be used for about one week if stored at 4 °C. The contents of this vial are injected in order to obtain the retention time-boiling point curve.

NOTE 1—Polywax is a trademark of the Baker Petrolite Corporation (Barnsdall, OK). This retention time calibration mixture is commercially available from chromatographic supply houses as well as from companies that build simulated distillation analyzers. The retention time calibration mixture may differ among supply houses in that docosane, tetracosane and hexacosane are also added to the Polywax 655 or Polywax 1000 in order to enhance the concentration of these hydrocarbons in the polywaxes.

8.5 *Detector Relative Response Test Mixture*—It is necessary to initially validate the response of the entire gas chromatographic system. Since this test method assumes that all hydrocarbons have the same relative response regardless of their retention time, a solution shall be prepared in order to determine the relative response factors. An alternative procedure is to use a gravimetric blend as specified in Test Method D7500.

8.5.1 Prepare a solution containing the following normal paraffins:

decane	octacosane
tetradecane	dotriacontane
octadecane	tetracontane
eicosane	pentacontane

8.5.2 Weigh about 100 mg of each paraffin to the nearest 0.1 mg into a 50 mL volumetric flask. Mix well and add CS_2 to the mark. Ensure that the paraffins are completely dissolved. Record the masses of the paraffins, which will be used in Eq 3 in order to calculate the relative response factor of each of the paraffins.

8.5.3 Record the assayed purity of each paraffin for use in Eq 3.

8.5.4 Transfer an aliquot of the mixture prepared in 8.5.2 to a 2 mL injection vial. Ensure that the components are in solution prior to the transfer. Warm the vial if necessary. Inject 0.1 μ L to 0.2 μ L.

8.6 *Reference Oil 5010*—In order to determine the sample recovery, the detector response factor has to be determined. For this purpose, utilize Reference Oil 5010 as an external standard. This material is obtainable from various chromatography suppliers. A gravimetric blend, as described in Test Method D7500, can also be used

8.7 *Gases*—The following compressed gases are utilized for the operation of the gas chromatograph:

8.7.1 *Nitrogen*, 99.999 %. (**Warning**—Compressed gas under high pressure.) Total impurities should not exceed 10 mL/m³. This gas is used as detector makeup. Helium has also been used as makeup gas.

8.7.2 *Hydrogen*, 99.999 %. (**Warning**—Extremely flammable gas under high pressure.) Total impurities should not exceed 10 mL/m³. This gas is used as fuel for the operation of the detector.

8.7.3 *Air*, 99.999 %. (**Warning**—Compressed gas under high pressure and supports combustion.) Total impurities should not exceed 10 mL/m³. This gas is used to sustain combustion in the FID detector.

8.7.4 *Helium*, 99.999 %. (**Warning**—Compressed gas under high pressure.) This gas is used as carrier gas and should not contain more than 5 mL/m³ of O₂. The total amount of impurities should not exceed 10 mL/m³.

9. Preparation of the Gas Chromatograph

9.1 A summary of the conditions used for developing the precision statement is given in **Table 1**.

9.2 *Column Installation*—The column is installed using graphite ferrules and an electronic leak detector is used to ascertain the absence of leaks. Follow the instructions given in Test Method **D2887** and Practice **E1510** for the installation of silica or aluminum clad silica columns. Metal columns require slightly different techniques in cutting and installation. Follow the recommendations of the column supplier.

9.3 *Detector Temperature*—Select a detector temperature that is at least 5 °C to 10 °C higher than the highest oven temperature.

9.4 *Initial Oven Temperature*—The initial temperature of the oven is chosen according to the sample type to be analyzed as follows:

9.4.1 *Crude Oil Samples*—Crude oil samples may contain hydrocarbons starting from methane, C₂, C₃, and C₄ which probably co-elute with C₅. Therefore, even at an initial temperature of –20 °C, C₅ and C₆ are partially resolved from the CS₂. Further decreases in oven temperature do not increase the separation of C₅ from C₁–C₄ hydrocarbons which co-elute with *n*-C₅.

9.4.2 *Residues and Samples Having Higher IBP*—For samples that have an initial boiling point of 100 °C or greater, such as vacuum residues or atmospheric residues, the initial oven temperature can be set to between 35 °C and 40 °C. Ensure that the sample is resolved from the solvent peak at the initial oven temperature selected. If the light ends cannot be separated from the solvent, then proceed as in **9.4.1**. If the user does not know the type of sample to be analyzed, all samples can be analyzed with an initial temperature of –20 °C.

10. Sample Preparation

10.1 Ensure that the sample is a representative sample. Follow the guidelines established in Practice **D4057**. Samples should be handled according to their content of volatile components. If the sample is submitted for other analyses, remove a small aliquot (~10 mL) early in the testing sequence in order to avoid loss of volatile components. Allow sample to warm to room temperature prior to weighing.

10.2 Samples that are solid or semi-solid at room temperature may require heating up to as high as 60 °C in order to pour them into a weighed container. Only samples that are soluble in carbon disulfide (CS₂) can be analyzed by this test method.

10.3 Weigh 0.2 g to 0.25 g of the sample to the nearest 0.1 mg. Add 10 mL of CS₂. Record this weight also to the

nearest 0.1 mg. Enter these values in the data acquisition system if appropriate.

10.4 Store all prepared solutions at a temperature of 4 °C. Care should be taken that the solution is prepared a short time prior to running the analysis. Samples can be stored in the auto sampler vials.

10.5 Prepare as many vials of a sample as are necessary to carry out multiple analyses of that sample. Do not use the same vial to run duplicates; use separate vials containing the same solution.

11. Preparation of the Response Factor Standard

11.1 Weigh 0.2 g to 0.25 g of Reference Oil 5010 to the nearest 0.1 mg. Add 10 mL of CS₂ and record the weight of the solvent to the nearest 0.1 mg. Store this solution at 4 °C, if not used immediately.

12. Preparation of the Apparatus and Data System

12.1 After the column is installed and checked for leaks, prepare the gas chromatograph to analyze the sample according to the typical conditions given in **Table 1**.

12.2 Set the acquisition system to digitize the data at 10 Hz. This will result in a slice width of 0.1 s. This data acquisition rate is kept constant for all samples, standards, and the solvent blank in order to acquire the same number of slices. The baseline chromatogram may contain the same or larger number of slices than the sample chromatograms, depending on when the data acquisition stops. Thus, various chromatograms taken in a sequence may differ by 5 to 10 slices. This fact is of no consequence with regard to the calculations.

12.3 Arrange to save the acquired data files. Build the sequence of samples to be injected by the gas chromatograph.

13. Verification of System Performance

13.1 *Column Resolution*—Prepare the gas chromatograph for injection of the retention time calibration mixture prepared in **8.4**. Inject 0.1 μL to 0.2 μL of this sample. Determine the column resolution as follows:

$$R = 2(t_2 - t_1)/(1.699)(W_2 + W_1) \quad (1)$$

where:

R = resolution,
*t*₂ = retention time (s) for the *n*-C₅₀ paraffin,
*t*₁ = retention time (s) for the *n*-C₅₂ paraffin,
*W*₁ = peak width (s) at half height of the *n*-C₅₀ peak, and
*W*₂ = peak width (s) at half height for the *n*-C₅₂.

13.1.1 Ensure that the resolution, *R*, is between 1.8 to 4.0.

13.2 *Skewness Test for Column Overloading*—Select a component between C₁₂–C₂₄ of the previous chromatogram or of the chromatogram of the retention time calibration mixture prepared in **8.4**. For the component selected, determine the skewness as follows. The skewness, *s*, is calculated by **Eq 2**: ILS participants reported skewness of 0.8 to 2.0 for peaks C₇ to C₁₀₀.

$$s = (a + b)/2a \quad (2)$$

where:

- s = skewness of the peak,
- a = left time segment measured at 10 % of the peak height and that intersects the perpendicular from the apex of the peak to the retention time axis, and
- b = right time segment measured at 10 % of the peak height and that intersects the perpendicular from the peak apex to the retention time axis. Ensure that the skewness is between 0.8 and 2.0. Data acquisition systems can calculate this parameter.

13.3 Determination of Detector Relative Response Factors—Prepare the gas chromatograph for the injection of the detector test mixture prepared in 8.5. Inject 0.1 to 0.2 μL of this sample. Calculate the relative response factor, F_i , of each paraffin relative to eicosane as follows:

$$F_i = \frac{M_i \times P_i \times A_{C_{20}}}{A_i \times M_{C_{20}} \times P_{C_{20}}} \quad (3)$$

where:

- M_i = mass of the paraffin in mg,
- $M_{C_{20}}$ = mass of the eicosane in mg,
- A_i = peak area of the paraffin,
- $A_{C_{20}}$ = peak area of the eicosane,
- P_i = % purity of the paraffin as recorded in 8.5.3, and
- $P_{C_{20}}$ = % purity of eicosane.

13.3.1 The relative response factor, F_i , should have a value of between 0.9 and 1.10. Failure to achieve this range may be due to inlet problems, lack of constant flow, or partial blockage of the flame tip orifice, or a combination thereof.

14. Analytical Sequence

14.1 Set up a sequence of the samples to be analyzed. The sequence will contain the order of the samples to be injected into the column. This schedule should be designed to achieve maximum reproducibility. A suggested order of the samples to be analyzed is described in 14.2 – 14.6. If time constraints require a shorter sequence, the user shall ensure that there is no carryover between samples and sample types.

14.2 *Blank Run*—At the beginning of each sequence, after any column maintenance is performed, make a blank run. It may take more than 2 blanks to show a stable plateau with no indication of residual elution. A blank run constitutes an identical solvent injection having the same volume as the sample injection. An acceptable blank run should show a stable plateau at the highest temperature of the oven (see 15.3). Furthermore, it should not show any indication of carryover or residual sample elution. It should also not contain any ghost peaks. A typical blank sample run is shown in Fig. A1.1. Several blanks may be necessary after column installation or after an idle period of the gas chromatograph. Verification of acceptable blanks is obtained by analyzing the Reference Oil 5010 or a gravimetric blend and a QC material.

14.3 *Retention Time Calibration Mixture*—Insert the retention time calibration mixture vial prepared in 8.4 into the auto sampler for injection. A typical chromatogram of the retention time calibration mixture is shown in Fig. A1.2. The insert in the Fig. A1.2 shows the best separation possible for the C_5 , CS_2 ,

C_6 , and C_7 and shows good peak shape for the C_6 and C_7 hydrocarbons. Identify all carbons up to C_{100} .

14.4 *Response Factor Standard*—Insert the vial containing Reference Oil 5010 prepared in 8.5, which is used as a response factor standard. Inject this standard in duplicate. A typical chromatogram of the reference oil analyzed at an initial oven temperature of -20°C is shown in Fig. A1.3. Verify that the response factor calculated by Eq 4 does not vary by more than 2 %.

14.5 *Sample Analysis*—Insert the sample vials prepared in 10.3. Inject samples. Analyzing a QC material with acceptable results before the analysis of unknown samples is strongly recommended.

14.6 *Additional Blank Runs*—Insert a vial containing CS_2 in order to obtain a second blank run. Carry out a blank run after each sample injection, and verify the absence of carryover from the previous samples. An ambient temperature version of the method with faster oven ramping can be employed for these clean-out runs in between samples to reduce run time and use of cryogenic fluids.

15. Verification of Acquired Data

15.1 Inspect all chromatograms by loading the data files in the data acquisition system. Observe that the signal magnitude for each sample injected is approximately the same as that for the retention time calibration mixture and the Reference Oil 5010 chromatograms.

15.2 *Verification of the Retention Time Calibration Mixture Chromatogram*—Inspect the chromatograms acquired during a sequence run. Do not use a chromatogram where the peaks do not meet the criteria of skewness as defined in 13.2. Inspect the chromatogram for the components C_5 - C_7 and the solvent peak as shown in the insert of Fig. A1.2. The peaks should not present peak splitting nor peak tailing.

15.3 *Sample Chromatograms*—Inspect the sample chromatograms and verify that the chromatograms can be overlaid to a duplicate chromatogram and show that the profile is reproducible. Fig. A1.4 shows a chromatogram of a 30°API crude oil where the solvent peak is not resolved from the sample components. Fig. A1.5 shows a typical chromatogram of an atmospheric residue where the solvent peak is resolved from the sample components.

15.3.1 It is recommended that a QC material be analyzed at the beginning and end of every sequence. The QC sample should have the same matrix as the samples analyzed.

15.4 *Baseline or Blank Runs*—Inspect, in the data system, the chromatograms of the blank solvent injections to verify that the blank signal obtained does not differ substantially from that obtained during the sample analysis. Check that the baseline exhibits a gradual rise up to the isothermal section of the chromatogram and ensure that there is a gradual transition back to the plateau of the baseline. Disregard any baseline that shows material eluting near the highest temperature of the column. Also disregard any baseline that shows ghost peaks. Overlay the baseline signal with the sample signal as shown in Fig. A1.6. Use only those sample signals that asymptotically

approach the baseline signals. Reject any sample run where the baseline signal at the end of the run exceeds in value the sample run. Reject any sample run at which at the end of the run the signal exceeds the baseline signal by 10 %. It is recommended that a new full blank analysis be performed at regular intervals (for example, after every 4 to 5 samples) in a sequence of samples to ensure good baseline data for subsequent samples.

15.4.1 *Determine the Quenching Interval*—Select the time that the solvent peak starts to elute. Determine when the solvent peak has eluted. Note the times of this interval in minutes. An expanded time scale chromatogram of the solvent peak is shown in Fig. A1.7.

15.4.2 *Determine the Magnitude of Solvent Response*—Using the data system, overlay the solvent chromatograms and verify that the profiles are similar. Verify that the total areas do not differ by more than 3 % from each other.

15.5 *External Standard Response Factor Chromatogram*—Inspect the external standard chromatogram obtained from the injection of Reference Oil 5010. Verify that the boiling point distribution is within the consensus values as indicated in Test Method D6352. Typical boiling point distribution values for Reference Oil 5010, obtained with this test method, are shown in Table 2. Correct any chromatography errors if the consensus values are not obtained (see 16.1.7).

16. Calculations

NOTE 2—The calculations are listed in this section. The chromatogram for the reference oil, the sample, and the baseline shall be zeroed as given in 16.1.2.

NOTE 3—The baseline chromatogram is subtracted from the Reference Oil 5010 and from the sample chromatogram in order to obtain the net area as shown in 16.1.4.

16.1 Zeroing of the Reference Oil Chromatogram:

16.1.1 Examine the chromatogram obtained for Reference Oil 5010 (external standard), and ensure, by visual inspection

of the chromatogram in the data system, that the first 5 slices contain neither sample nor solvent elution.

16.1.2 Set up an array that contains slices obtained from the Reference Oil 5010 chromatogram. Calculate the average of the first five area slices. Subtract the average slice area from each slice in the Reference Oil 5010 chromatogram. Set negative numbers to zero.

16.1.3 Zero the blank baseline chromatogram by carrying out an analogous calculation as in 16.1.2.

16.1.4 *Blank Baseline Subtraction from the Reference Oil 5010 Chromatogram*—Subtract each zeroed blank baseline slice from the corresponding zeroed Reference Oil 5010 slice. If there are negative slices, set the slice values to zero.

16.1.5 *Determination of the End of Elution Time of Reference Oil 5010*—Since it is a requirement that the sample chosen to obtain a response factor shall fully elute prior to the F_{Et} time, the end of sample elution for this chromatogram is to be determined as described in Test Method D6352, using the algorithm to determine the time the signal of the completely eluted sample returns to baseline.

16.1.6 *Determination of the Area of the Chromatogram for Reference Oil 5010*—Determine the end time of solvent elution. Sum all of the slices from the end of solvent elution to the end of sample elution. This is the area of the standard, A_{STD} .

16.1.7 *Calculation of the Boiling Point Distribution of Reference Oil 5010*—The resulting corrected slices obtained for Reference Oil 5010 are submitted to a Test Method D6352 calculation for boiling point distribution. A comparison of the values obtained with the consensus values listed in Table 2 shall be made and all the boiling point values shall fall within the specified windows. If this requirement is not met, correct any chromatographic problems prior to proceeding with sample analysis. Typical problems found in this step are: contaminated solvent; problems in sample preparation; sample residue in the inlet or column, or both; quality of the baseline used, a partially blocked detector jet, or a combination thereof.

16.2 Zeroing of Sample Chromatograms:

16.2.1 In the case of crude oil analysis or samples in which the solvent peak is not resolved from the sample components, ensure, by visual inspection of the chromatogram in the data system, that the first 5 slices contain neither sample nor solvent elution. If there is sample elution, decrease the number of slices for the averaging to 3 or increase the digitization rate given in 12.2.

16.2.2 *Zeroing the Sample Chromatogram*—Proceed in a manner analogous to that described in 16.1.2.

16.2.3 *Zeroing the Blank Baseline Chromatogram*—Carry out an analogous calculation as in 16.1.3.

16.3 *Blank Baseline Subtraction from the Sample Chromatogram*—Carry out an analogous calculation as in 16.1.4.

16.4 *Quenching Correction*—For crude oil samples, a quenching factor is used to correct for the diminished FID response when the CS_2 co-elutes with sample components. This factor is applied to the time segment corresponding to the elution of CS_2 . In the interlaboratory study, the factor of 1.930 was applied. This value is determined from experiments made

TABLE 2 Consensus Values Obtained for the Boiling Point Distribution of Reference Oil 5010 Used as External Standard^A

%BP	avg °C	95.5 %CI, °C	avg °F	95.5 %CI, °F
IBP	428	9	801	16
5	477	3	891	5
10	493	3	918	5
15	502	3	936	5
20	510	3	950	6
25	518	4	963	6
30	524	4	975	7
35	531	4	987	7
40	537	4	998	8
45	543	4	1008	8
50	548	4	1019	8
55	554	4	1030	8
60	560	4	1040	8
65	566	4	1051	8
70	572	4	1062	8
75	578	5	1073	9
80	585	4	1086	8
85	593	4	1099	7
90	602	4	1116	8
95	616	4	1140	7
FBP	655	18	1213	32

^A As reported in Test Method D6352.

by dissolving butane, pentane, and hexane in toluene. The solution is analyzed by injecting it under conditions identical to sample analysis. The areas for the components are compared to the areas obtained by gradually adding weighed aliquots of CS₂ to the original solution. Alternatively the quenching value can be checked by performing a glass distillation by Test Method **D2892**. Samples that do not have components that co-elute with solvent, for example, residues or the Reference Oil 5010, do not require the quenching correction.

16.4.1 Determine the Quenching Interval—Select the time that the solvent peak starts to elute. Determine when the solvent peak has eluted. Note the times of this interval in minutes. An expanded time scale chromatogram of the solvent peak is shown in **Fig. A1.7**.

16.4.2 Locate the slices of the quenching interval. For samples in which the solvent component co-elutes with the sample chromatogram (that is, crude oils), determine the quenching interval, Q.I., as described in **16.4.1**. Find the closest slice corresponding to the beginning of elution of the solvent peak as well as the final slice corresponding to the end of elution of the solvent peak.

16.4.3 Correct the diminished response of the interval by multiplying each slice of this interval by the quenching factor, Q.F. Use the value as discussed in **16.4**.

16.5 Determination of the Sample Final Elution Time—Determine the time at which the oven reaches the isothermal portion of the temperature program. This is usually recognized as an inflection point in the baseline. This point is called the final elution time (*FET*). The conversion of this slice to temperature will yield the final elution temperature, *FET*. This conversion is carried out in **16.9.4**.

16.6 Determination of the Sample Area—The net sample area is obtained by adding all slices from time $t = 0$ to the final elution time, *FET*. This net area is the A_{SMP} .

16.7 Calculate the Response Factor, RF, as follows:

$$RF = \frac{(M_{STD})}{(M_{STD} + M_{SLSTD})} \times \frac{1}{A_{STD}} \quad (4)$$

where:

- RF = response factor,
- A_{STD} = net area obtained for the Reference Oil 5010 chromatogram after baseline subtraction and after excluding the solvent peak (this area was determined in **16.1.6**),
- M_{SLSTD} = solvent mass, in grams, used for Reference Oil dissolution, and
- M_{STD} = mass, in grams, of Reference Oil 5010 used in preparing the response factor solution.

16.7.1 The mass term in **Eq 4** has been expressed as a fraction of the mass of solute and solvent.

16.8 Calculation of the %Recovery—The %recovery is defined as:

$$\%RC = \frac{(ME)}{\left(\frac{M_{SMP}}{(M_{SMP} + M_{SLSMP})}\right)} \times 100 = \frac{ME \times (M_{SMP} + M_{SLSMP})}{M_{SMP}} \times 100 \quad (5)$$

where:

- ME = mass, in grams, of the sample eluted,
- M_{SMP} = sample mass, in grams, and
- M_{SLSMP} = mass of solvent, in grams, used in the sample solution.

Since:

$$ME = (A_{SMP}) \times (RF) \quad (6)$$

where:

- A_{SMP} = net sample area, and
- RF = response factor of the Reference Oil 5010.

Substituting **Eq 6** for the value of ME in **Eq 5** yields:

$$\%RC = \frac{A_{SMP} \times RF \times (M_{SMP} + M_{SLSMP})}{(M_{SMP})} \times 100 \quad (7)$$

Substituting **Eq 4** in **Eq 7** for the value of RF yields:

$$\%RC = \frac{(M_{STD})}{(M_{STD} + M_{SLSTD})} \times \frac{(M_{SMP} + M_{SLSMP})}{M_{SMP}} \times \frac{A_{SMP}}{A_{STD}} \times 100 \quad (8)$$

16.8.1 Determine whether the %recovery, (%*RC*) falls below the recovery threshold (R_t) limits set. If it is less than or equal to the recovery threshold (R_t), use the %recovery (%*RC*) determined in **16.8**. If the %recovery is greater than the recovery threshold (R_t), then the recovery is set to 100 %. If the %recovery is larger than 102 % (1 standard deviation of the residue), repeat the analysis or determine the chromatographic problem.

16.9 Determination of the Boiling Point Distribution:

16.9.1 Multiply each slice of the sample chromatogram by the %recovery as established in **16.8.1**. Divide each slice by the total area of the sample obtained in **16.6**. This will express the slices in a percent scale.

16.9.2 Add the slices that will yield 0.5 %, 1 %, 2 %, . . . %recovery. Determine, at 1 % intervals, the time of the slice yielding exactly 0.5, 1 %, 2 %, . . .%recovery. Use an interpolation procedure to find the fractional slices required to yield exactly 0.5, 1 %, . . .%recovery.

16.9.3 Stop the calculation carried out in **16.9.2** when obtaining a slice summation equal to the nearest whole integer of the %recovery.

16.9.4 Convert the retention times to boiling points as outlined in the Test Method **D6352** algorithm. Use the boiling point temperatures listed in **Table 3**. For each retention time obtained in **16.9.2**, find the corresponding temperature from the Boiling Point vs. Retention Time function as shown in **Fig. A1.8**. Calculate the corresponding boiling points as determined in the Test Method **D2887** algorithm.

16.10 Calculation of Cut Point Intervals:

16.10.1 For the two temperatures that define the cut point interval, find the two corresponding slices.

16.10.2 Using the calibration curve, convert this temperature range to a time range.

16.10.3 Convert the time range to a slice number range by multiplying by 60 and dividing by the slice width in seconds.

16.10.4 Sum the normalized slices, starting with the initial slice of the cut and terminating with the last slice after the cut. This sum will be equal to the %mass of the cut.

TABLE 3 Boiling Points Of Paraffins^A

Carbon Number	Boiling Point °C	Boiling Point °F	Carbon Number	Boiling Point °C	Boiling Point °F
1	-162	-259	51	579	1074
2	-89	-129	52	584	1083
3	-42	-44	53	588	1090
4	0	31	54	592	1098
5	36	97	55	596	1105
6	69	156	56	600	1112
7	98	209	57	604	1119
8	126	258	58	608	1126
9	151	303	59	612	1134
10	174	345	60	615	1139
11	196	385	61	619	1146
12	216	421	62	622	1152
13	235	456	63	625	1157
14	254	488	64	629	1164
15	271	519	65	632	1170
16	287	548	66	635	1175
17	302	576	67	638	1180
18	316	601	68	641	1186
19	330	626	69	644	1191
20	344	651	70	647	1197
21	356	674	71	650	1202
22	369	695	72	653	1207
23	380	716	73	655	1211
24	391	736	74	658	1216
25	402	755	75	661	1222
26	412	774	76	664	1227
27	422	791	77	667	1233
28	431	808	78	670	1238
29	440	825	79	673	1243
30	449	840	80	675	1247
31	458	856	81	678	1252
32	466	870	82	681	1258
33	474	885	83	683	1261
34	481	898	84	686	1267
35	489	912	85	688	1270
36	496	925	86	691	1276
37	503	937	87	693	1279
38	509	948	88	695	1283
39	516	961	89	697	1287
40	522	972	90	700	1292
41	528	982	91	702	1296
42	534	993	92	704	1299
43	540	1004	93	706	1303
44	545	1013	94	708	1306
45	550	1022	95	710	1310
46	556	1033	96	712	1314
47	561	1042	97	714	1317
48	566	1051	98	716	1321
49	570	1058	99	718	1324
50	575	1067	100	720	1328

^A Boiling Points from C₁-C₉₂ are taken from Test Method **D6352**. For carbons C₉₂-C₁₀₀ taken from reference in Annex 1 of Test Method **D6352**.

NOTE 1—API Project 44, October 31, 1972 is believed to have provided the original normal paraffin boiling point data that are listed in **Table 3**. However, over the years some of the data contained in both API Project 44 (Thermodynamics Research Center Hydrocarbon Project) and Test Method **D6352** have changed and they are no longer equivalent. **Table 3** represents the current normal paraffin boiling point values accepted by Subcommittee D02.04 and found in all test methods under the jurisdiction of Section D02.04.0H.

NOTE 2—Test Method **D6352** has traditionally used *n*-paraffin boiling points rounded to the nearest whole degree for calibration. The boiling points listed in **Table 3** are correct to the nearest whole number in both degrees Celsius and degrees Fahrenheit. However, if a conversion is made from one unit to the other and then rounded to a whole number, the results will not agree with the table values for a few carbon numbers. For example, the boiling point of *n*-heptane is 98.425 °C, which is correctly rounded to 98 °C in the table. However, converting 98.425 °C gives 209.165 °F, which rounds to 209 °F, while converting 98 °C gives 208.4 °F, which rounds to 208 °F. Carbon numbers 2, 4, 7, 8, 9, 13, 14, 15, 16, 25, 27, and 32 are affected by rounding.

16.10.5 The %recovery, *RC*, determined at a temperature *T_{RC}* that is equal to or less than *FET*, can be determined at a new temperature *T_N* by using the following equation:

$$E_{RC} = \frac{(RC - R_{C-1\%})}{(T_{RC} - T_{RC-1\%})} \times (T - T_{RC-1\%}) + R_{C-1\%} \quad (9)$$

where:

E_{RC} = estimated recovery at temperature *T*,
%RC = %recovery determined at temperature *T_{RC}* in **16.8.1**,

$\%R_{C-1\%}$ = %recovery determined at 1 % below the %RC,
and

$T_{RC-1\%}$ = temperature corresponding to $R_{C-1\%}$.

16.10.5.1 The use of this equation for values $T_N > FET$ is not recommended.

17. Report

17.1 Report the temperatures to the nearest 0.5 °C (1 °F) at 1 % intervals between 1 % and up to the nearest integer of the lower boundary of the %RC. Report also the initial boiling point (IBP). Report the selected cut point intervals.

18. Precision and Bias³

18.1 *Precision*—The precision of this test method was determined by the statistical examination of the interlaboratory test results for five crude oils and five residues. It is important to note that the Results for the precision statement as shown in Tables 4-6 are to be used only within the ranges shown in the tables. Additional studies are required to expand the precision to the ranges not listed in Tables 4-6, respectively.

³ Supporting data have been filed at ASTM International Headquarters and may be obtained by requesting Research Report RR:D02-1724.

18.1.1 *Repeatability*—The difference between successive test results obtained by the same operator with the same apparatus under constant operating conditions on identical test Material would, in the long run, in the normal and correct Operation of the test method, exceed the values in only one case in twenty as shown in Table 4 (Residues), Table 5 (Crude Oil), and Table 6 for Cuts (as used in the ASTM Crosscheck for Crude Oils).

18.1.2 *Reproducibility*—The difference between two single and independent test results obtained by different operators working in different laboratories on identical test material would, in the long run, in the normal and correct operation of the test method, exceed the values shown in Table 4 (Residues), Table 5 (Crude Oil), and Table 6 for Cuts (as used in the ASTM Crosscheck for Crude Oils).

18.2 *Bias*—The bias in results of this test method cannot be determined because the boiling range distribution is defined by the test method.

19. Keywords

19.1 boiling point distribution; crude oils; cut point intervals; distillation residues; lubricants; residues; simulated distillation

TABLE 4 Repeatability and Reproducibility for Residues^A

% (mass/mass) recovered	Repeatability, r		Reproducibility, R		Range Covered	
	°C	°F	°C	°F	°C	°F
IBP	5.72	10.3	13.7	24.7	246 to 504	474 to 939
5	3.39	6.1	5.75	10.4	315 to 547	599 to 1017
10	3.19	5.7	5.39	9.7	346 to 563	654 to 1045
15	2.88	5.2	5.2	9.4	368 to 575	694 to 1067
20	3.42	6.2	6.5	11.7	388 to 585	730 to 1085
25	3.55	6.4	6.71	12.1	405 to 595	761 to 1103
30	3.93	7.1	7.6	13.7	420 to 604	788 to 1119
35	4.38	7.9	8.9	16.0	434 to 614	813 to 1137
40	5.22	9.4	11	19.8	447 to 624	836 to 1155
45	6.27	11.3	13.5	24.3	462 to 634	863 to 1173
50	7.18	12.9	16.4	29.5	477 to 645	890 to 1193
55	8.64	15.6	19.9	35.8	493 to 656	919 to 1213
60	10.1	18.2	22.6	40.7	509 to 670	948 to 1238
65	11.7	21.1	24.7	44.5	529 to 684	984 to 1263
70	15.2	27.4	27.4	49.3	550 to 699	1022 to 1290
75	16.6	29.9	30.9	55.6	574 to 716	1065 to 1321

^A Do not extrapolate outside of the above reported data.

TABLE 5 Repeatability and Reproducibility for Crude Oil^A

% (mass/mass) recovered	Repeatability, r		Reproducibility, R		Range Covered	
	°C	°F	°C	°F	°C	°F
IBP	1.35	2.4	2.49	4.5	30 to 31	86 to 88
5	8.94	16.1	19.6	35.3	76 to 97	169 to 207
10	11.4	20.5	19.5	35.1	109 to 154	228 to 309
15	8.23	14.8	15.1	27.2	134 to 217	273 to 423
20	7.51	13.5	13.1	23.6	160 to 259	320 to 498
25	8.7	15.7	13.6	24.5	184 to 295	363 to 563
30	8.22	14.8	13.1	23.6	210 to 327	410 to 621
35	8.52	15.3	14	25.2	231 to 358	448 to 676
40	8.83	15.9	14.9	26.8	249 to 398	480 to 748
45	8.99	16.2	15.1	27.2	265 to 436	509 to 817
50	9.88	17.8	16.4	29.5	285 to 325	545 to 887
55	10.8	19.4	18.6	33.5	304 to 517	579 to 963
60	12.4	22.3	21.5	38.7	326 to 563	619 to 1045
65	13.8	24.8	24.3	43.7	351 to 608	664 to 1126
70	14.3	25.7	21.2	38.2	379 to 608	714 to 1126
75	15.1	27.2	28.24	50.8	410 to 700	770 to 1292

^A Do not extrapolate outside of the above reported data.

TABLE 6 Repeatability and Reproducibility for Cut Points^A

Cut from Set to Temperature	Cut Temperature, °C	Cut Temperature, °F	Repeatability, r	Reproducibility, R
			Mass %	Mass %
Crude Cut 1	82.2	180	1.24	1.74
Crude Cut 2	193.3	380	1.42	1.92
Crude Cut 3	248.9	480	1.48	2.05
Crude Cut 4	343.3	650	1.63	2.28
Crude Cut 5	426.7	800	1.78	2.58
Crude Cut 6	565.6	1050	2.1	3.03
Crude Cut 7	596.1	1105	2.03	3.12
Crude Cut 8	720	1328	2.52	3.17
Residue Cut 1	330	626	0.0748 X	0.126 X
Residue Cut 2	450	842	0.0767 X	0.109 X
Residue Cut 3	600	1112	0.0338 (X + 30)	0.0726 (X + 30)
Residue Cut 4	720	1328	5.36	7.16

^A X= % mass recovered at the cut. Do not extrapolate outside of the above reported data.

ANNEX

(Mandatory Information)

A1. CHROMATOGRAMS AND FIGURES

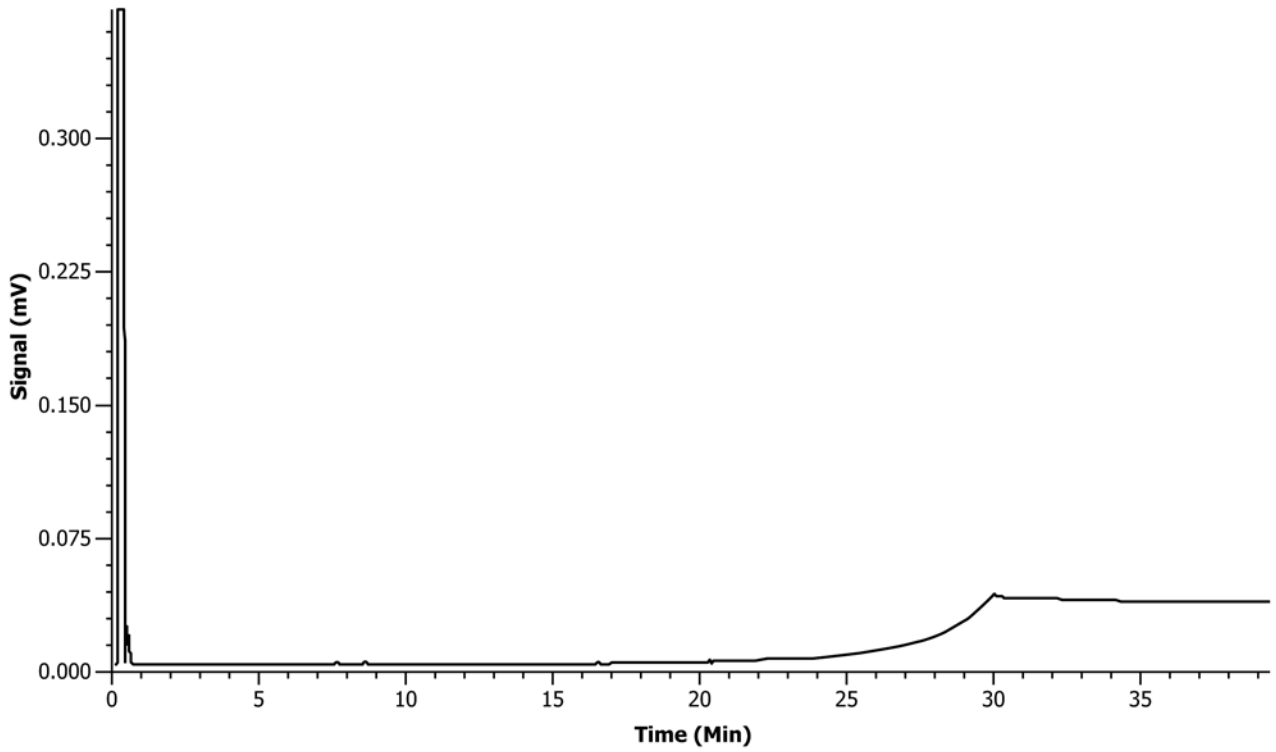

FIG. A1.1 Typical Blank Run (Initial Temperature -20 °C)

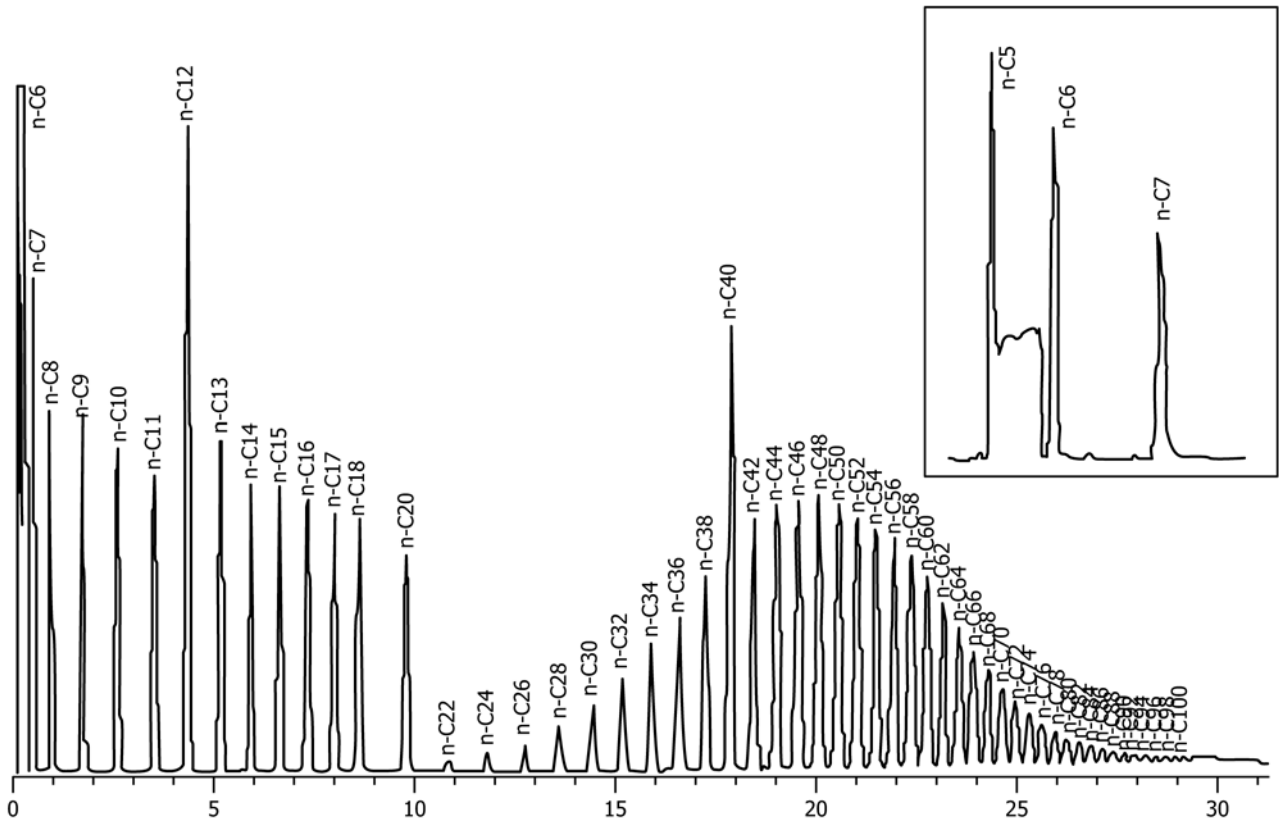

FIG. A1.2 Chromatogram of the Retention Time Calibration Mixture C₅-C₁₀₀ Injected at -20 °C, Insert Expands View of C₅-C₇ Region

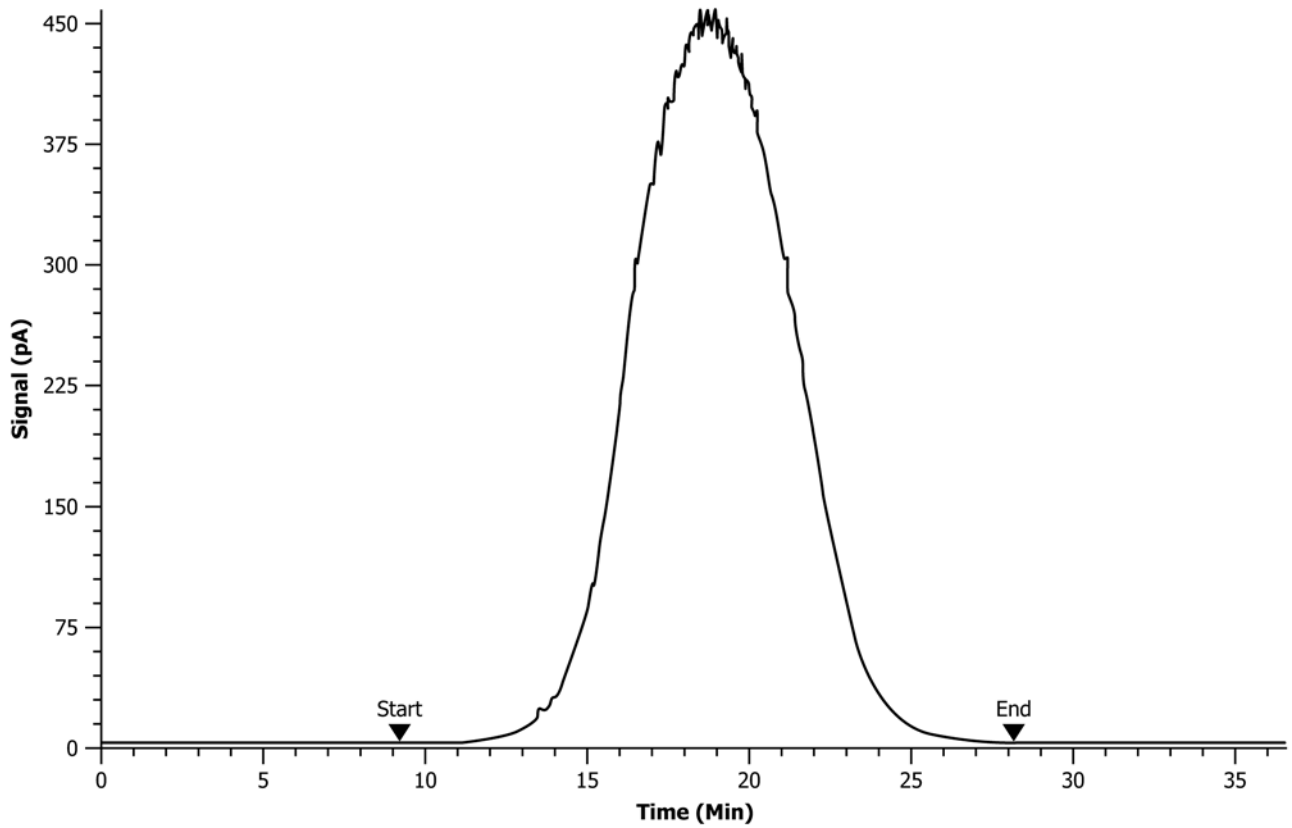

FIG. A1.3 Chromatogram (Baseline Corrected) of Reference Oil 5010 Injected at -20 °C

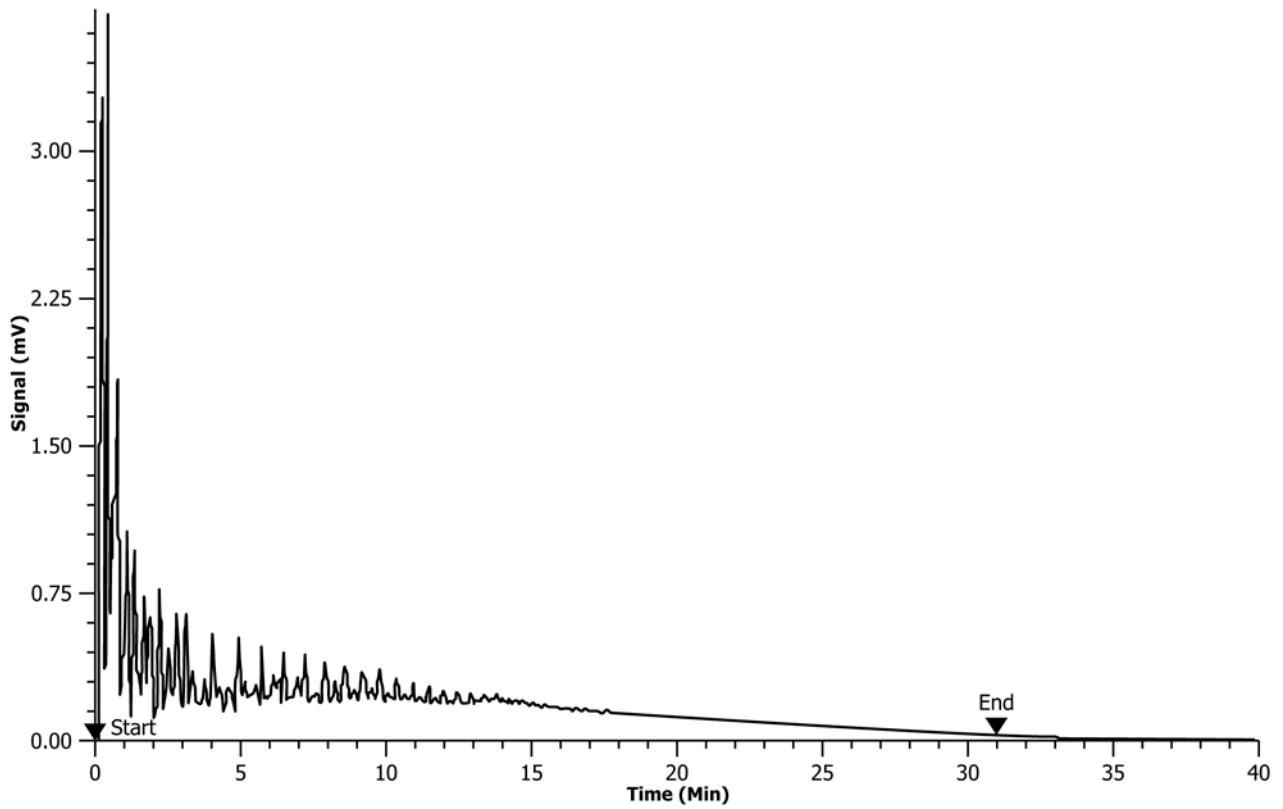

FIG. A1.4 Chromatogram (Baseline Corrected) of a Crude Oil (Injected at -20 °C)

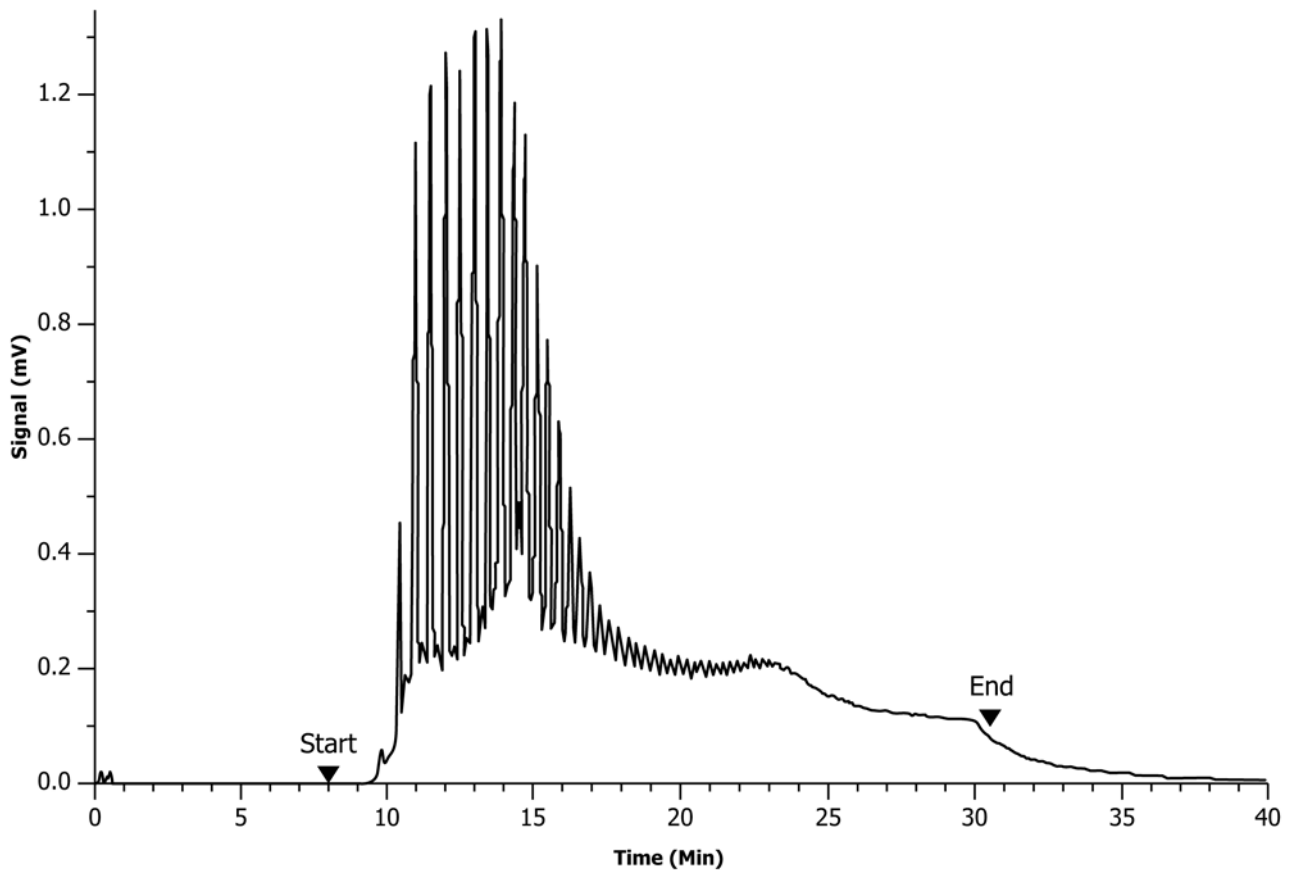

FIG. A1.5 Chromatogram (Baseline Corrected) of an Atmospheric Residue

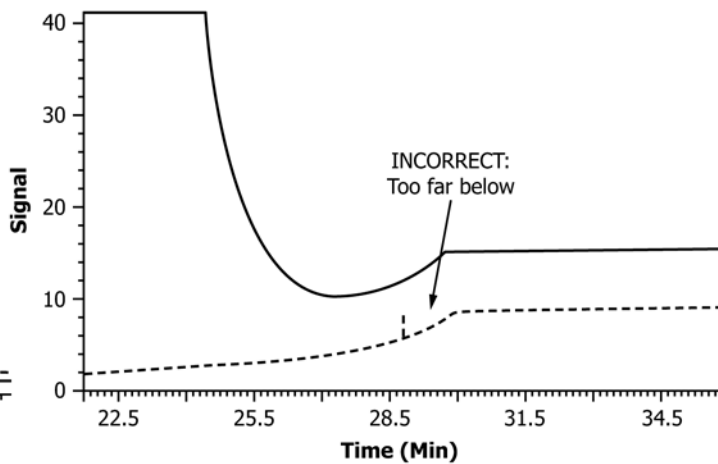
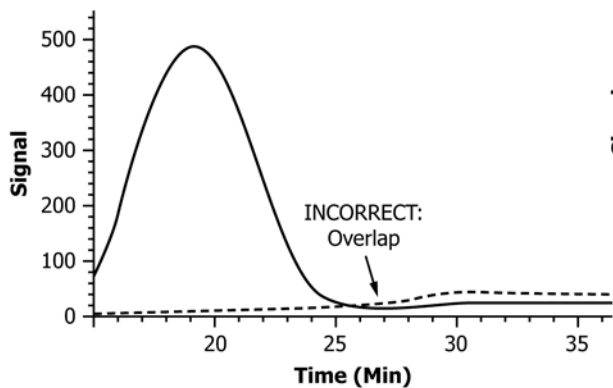
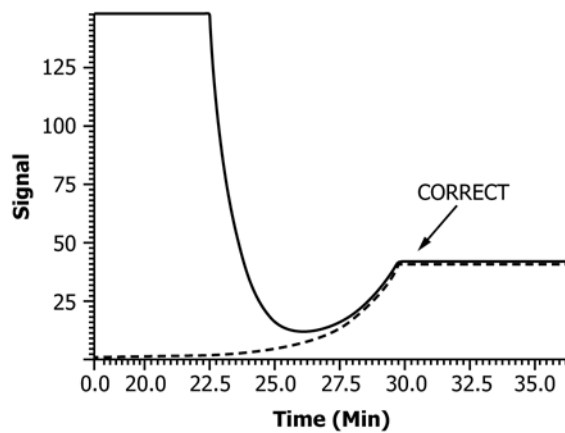

FIG. A1.6 Correct and Incorrect Relative Position of Baseline and Sample Signal

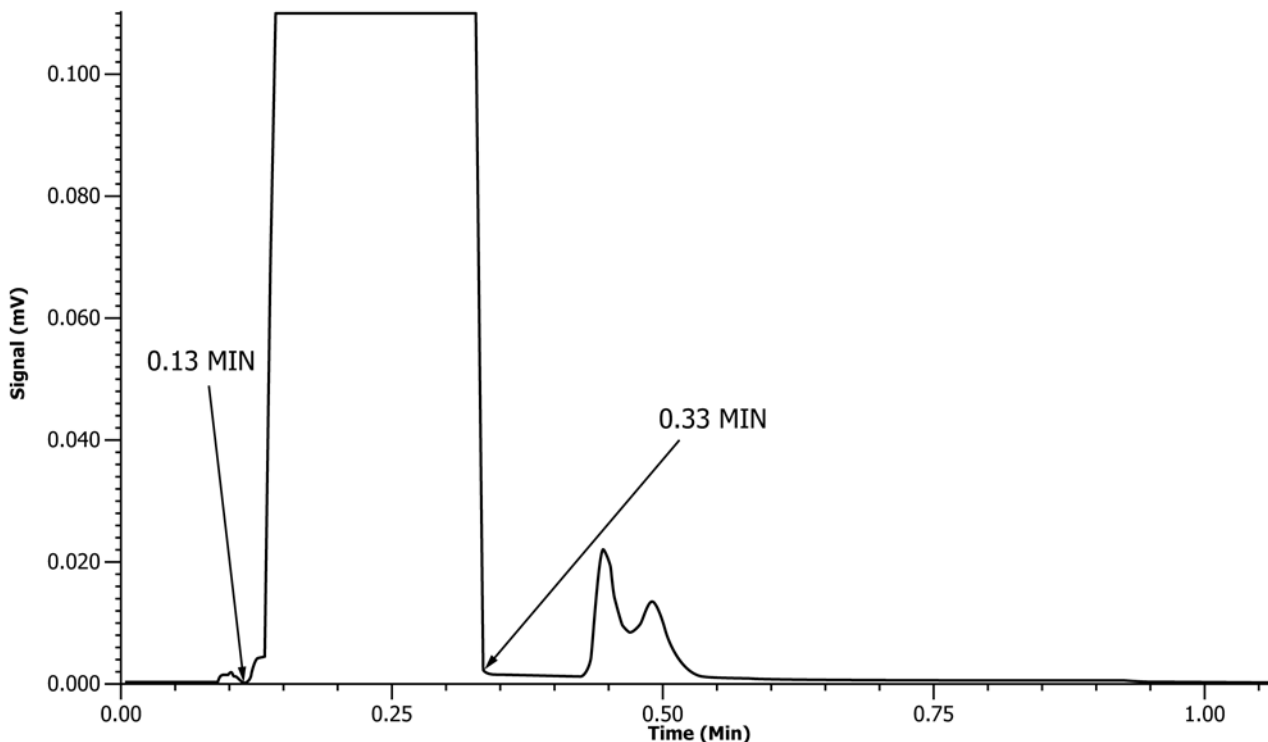

FIG. A1.7 Expanded Chromatogram of a CS₂ Injection for Selecting the Quenching Interval

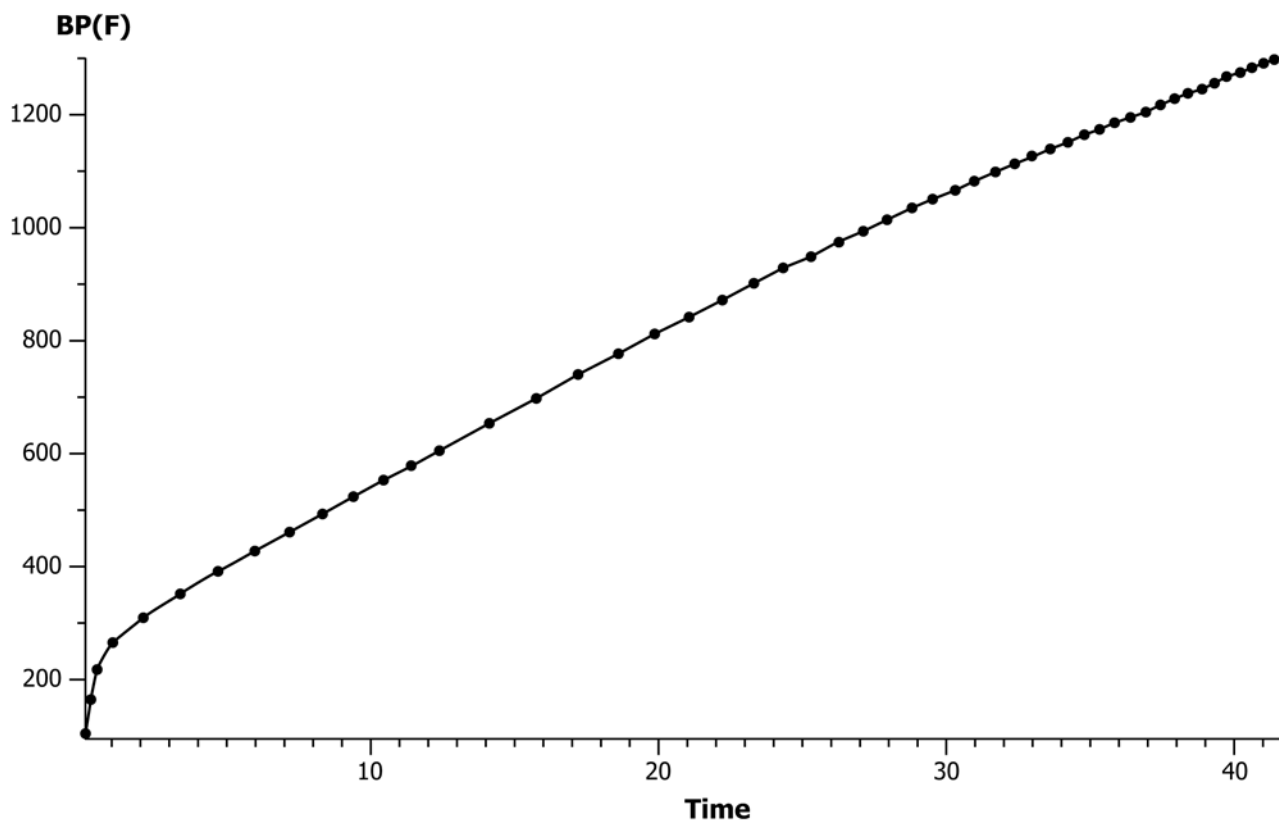

FIG. A1.8 Boiling Point versus Retention Time Plot

APPENDIX

(Nonmandatory Information)

X1. LIGHT END ANALYSIS FOR CRUDE OILS BY DETAILED HYDROCARBON ANALYSIS

X1.1 Summary

X1.1.1 For samples that contain large amounts of light components in the range of C_1 - C_9 , and for samples that require a more accurate description of the boiling curve in the region C_1 - C_9 , it may be necessary to carry out a light end analysis. The analysis is carried out in two steps.

X1.1.1.1 The first step is to analyze the sample in a separate gas chromatograph which contains an inlet, a pre-fractionator, a column such as is used in Test Method D7900, and a flame ionization detector.

X1.1.1.2 The second step is to analyze the sample by a High Temperature Gas Chromatograph as described in Sections 1 – 16 of this test method.

X1.1.2 From the first step a detailed composition is obtained for the fraction C_1 - C_9 in the crude oil sample. Since the composition is known and the boiling points of the components are also known, a distillation curve can be obtained.

X1.1.3 From the second step a distillation curve is determined as described in Sections 1 – 16 of this test method.

X1.1.4 The distillation curve from the first step can then be combined with the distillation curve in the second step using a specific software.

X1.2 Apparatus and Procedure

X1.2.1 A typical schematic of the instrument using a valve (8 port staggered or 10 port axial) is shown in the Fig. X1.1. Alternatively, the same procedure can be achieved using Deans switch. Additional configurations can be found in Test Method D7900. All of the configurations described in Test Method D7900 have the purpose of allowing the C_1 - C_9 components to elute into the capillary column and backflush the remaining matrix.

X1.2.2 Details of the sample preparation as well as the use of an internal standard are detailed in Test Method D7900.

X1.3 Combined Distillation Curve

X1.3.1 Fig. X1.2 shows the combination of the two curves obtained from the two separate instrument analyses. The curve obtained from the pre-fractionator detailed hydrocarbon analysis is joined with the high temperature simulated distillation curve at the point of intersection as shown in Fig. X1.2.

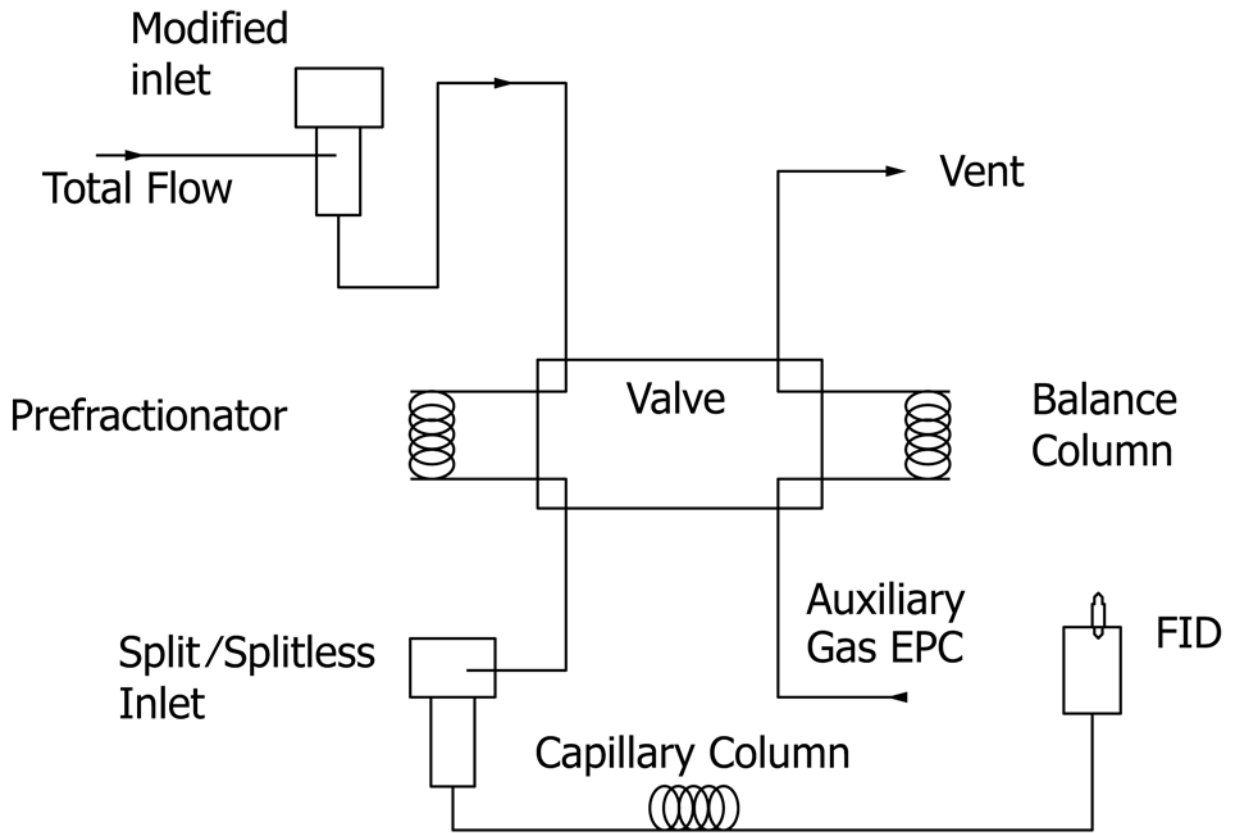

FIG. X1.1 Schematic Diagram of the Prefractionating System

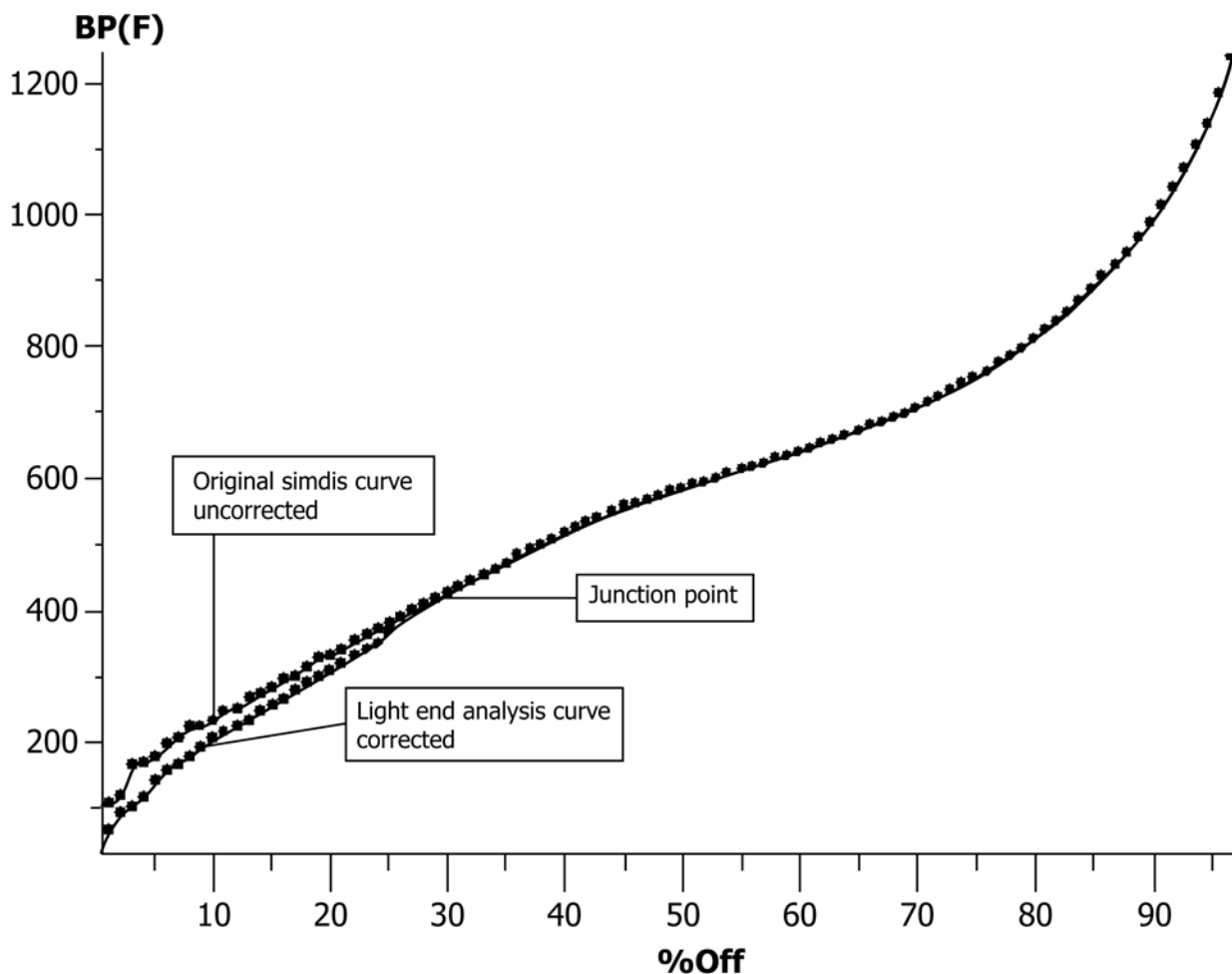

FIG. X1.2 Corrected and Uncorrected Distillation Curves

SUMMARY OF CHANGES

Subcommittee D02.04 has identified the location of selected changes to this standard since the last issue (D7169 – 11) that may impact the use of this standard. (Approved Oct. 15, 2016.)

- (1) Added Test Methods **D7500** and **D7900** to Referenced Documents; added citations throughout.
- (2) Eliminated the references to Test Methods D6729 and D6730.
- (3) Added in Section 4 the use of a gravimetric blend as an alternative to measure detector response.
- (4) Expanded GC variables to be typical.
- (5) Increased skewness range to 2.

- (6) Added cautionary statements to the use of carbon disulfide.
- (7) Added verification of blank acceptance.
- (8) Added a recommendation to analyze a QC when analyzing samples.
- (9) Removed requirements to store samples at sub ambient temperatures.
- (10) Added the frequency of baselines and cleaning runs.
- (11) Corrected two typographical boiling point errors.

ASTM International takes no position respecting the validity of any patent rights asserted in connection with any item mentioned in this standard. Users of this standard are expressly advised that determination of the validity of any such patent rights, and the risk of infringement of such rights, are entirely their own responsibility.

This standard is subject to revision at any time by the responsible technical committee and must be reviewed every five years and if not revised, either reapproved or withdrawn. Your comments are invited either for revision of this standard or for additional standards and should be addressed to ASTM International Headquarters. Your comments will receive careful consideration at a meeting of the responsible technical committee, which you may attend. If you feel that your comments have not received a fair hearing you should make your views known to the ASTM Committee on Standards, at the address shown below.

This standard is copyrighted by ASTM International, 100 Barr Harbor Drive, PO Box C700, West Conshohocken, PA 19428-2959, United States. Individual reprints (single or multiple copies) of this standard may be obtained by contacting ASTM at the above address or at 610-832-9585 (phone), 610-832-9555 (fax), or service@astm.org (e-mail); or through the ASTM website (www.astm.org). Permission rights to photocopy the standard may also be secured from the Copyright Clearance Center, 222 Rosewood Drive, Danvers, MA 01923, Tel: (978) 646-2600; <http://www.copyright.com/>