



# Standard Test Method for Measuring Friction and Wear Properties of Extreme Pressure (EP) Lubricating Oils Using SRV Test Machine<sup>1</sup>

This standard is issued under the fixed designation D6425; the number immediately following the designation indicates the year of original adoption or, in the case of revision, the year of last revision. A number in parentheses indicates the year of last reapproval. A superscript epsilon ( $\epsilon$ ) indicates an editorial change since the last revision or reapproval.

## INTRODUCTION

This test method represents the transformation of DIN 51834-2:1997. The DIN working group implemented changes at its annual meeting in Munich in September 2000. ASTM Committee D02 adopted these modifications as closely as possible. The DIN working group widens the scope of the standard to accommodate different test conditions and refines repeatability and reproducibility on the base of four international RR tests. It also introduces the wear volume as a tribological quantity.

### 1. Scope\*

1.1 This test method covers an extreme pressure (EP) lubricating oil's coefficient of friction and its ability to protect against wear when subjected to high-frequency, linear oscillation motion. The procedure is identical to that described in DIN 51834.

1.2 This test method can also be used to determine the ability of a non-EP lubricating oil to protect against wear and its coefficient of friction under similar test conditions.

1.3 The values stated in SI units are to be regarded as standard. No other units of measurement are included in this standard.

1.4 *This standard does not purport to address all of the safety concerns, if any, associated with its use. It is the responsibility of the user of this standard to establish appropriate safety and health practices and determine the applicability of regulatory limitations prior to use.*

### 2. Referenced Documents

#### 2.1 ASTM Standards:<sup>2</sup>

- A295 Specification for High-Carbon Anti-Friction Bearing Steel
- D4175 Terminology Relating to Petroleum, Petroleum

#### Products, and Lubricants

- D5706 Test Method for Determining Extreme Pressure Properties of Lubricating Greases Using a High-Frequency, Linear-Oscillation (SRV) Test Machine
- D7421 Test Method for Determining Extreme Pressure Properties of Lubricating Oils Using High-Frequency, Linear-Oscillation (SRV) Test Machine
- E45 Test Methods for Determining the Inclusion Content of Steel
- G40 Terminology Relating to Wear and Erosion

#### 2.2 DIN Standards:<sup>3</sup>

- DIN EN ISO 683-17 Heat-treated Steels, alloy steels and free-cutting steels – Part 17 : Ball and roller bearing steels
- DIN 51631:1999 Mineral spirits; special boiling point spirits; requirements
- DIN 51834 Tribological Test in the Translatory Oscillation Apparatus (Part 2: Determination of Friction and Wear Data for Lubricating Oils)
- DIN EN ISO 13565-2:1998 Geometrical Product Specifications (GPS)—Surface Texture: Profile Method; Surfaces having Stratified Functional Properties—Part 2: Height Characterization using Linear Material Ratio Curve (replacement of DIN 4776:1990)

### 3. Terminology

#### 3.1 Definitions:

3.1.1 *break-in, n—in tribology*, an initial transition process occurring in newly established wearing contacts, often accompanied by transients in coefficient of friction or wear rate, or both, that are uncharacteristic of the given tribological system's long term behavior. (*Synonym: run-in, wear-in*) **G40**

<sup>1</sup> This test method is under the jurisdiction of ASTM Committee D02 on Petroleum Products, Liquid Fuels, and Lubricants and is the direct responsibility of Subcommittee D02.L0.11 on Tribological Properties of Industrial Fluids and Lubricates.

Current edition approved Dec. 1, 2011. Published March 2012. Originally approved in 1999. Last previous edition approved in 2010 as D6425–05(2010) <sup>ε1</sup>. DOI: 10.1520/D6425-11.

<sup>2</sup> For referenced ASTM standards, visit the ASTM website, www.astm.org, or contact ASTM Customer Service at service@astm.org. For *Annual Book of ASTM Standards* volume information, refer to the standard's Document Summary page on the ASTM website.

<sup>3</sup> Available from Deutsches Institut für Normung, Beuth Verlag GmbH, Burggrafenstrasse 6, D-10787 Berlin, Germany.

\*A Summary of Changes section appears at the end of this standard

3.1.2 *C.L.A.*, *n*—in measuring surface finish, the arithmetic average of the absolute distances of all profile points from the mean line for a given distance.<sup>4</sup>

3.1.3 *coefficient of friction μ or f*, *n*—in tribology, the dimensionless ratio of the friction force ( $F_f$ ) between two bodies to the normal force ( $F_n$ ) pressing these bodies together.

**G40**

$$\mu = (F_f / F_n) \quad (1)$$

3.1.4 *EP lubricating oil*, *n*—a liquid lubricant containing an extreme pressure (EP) additive

3.1.5 *extreme pressure (EP) additive*, *n*—in a lubricant, a substance that minimizes damage to metal surfaces in contact under high stress rubbing conditions.

**D4175**

3.1.6 *Hertzian contact area*, *n*—the apparent area of contact between two nonconforming solid bodies pressed against each other, as calculated from Hertz' equations of elastic deformation.

**G40**

3.1.7 *Hertzian contact pressure*, *n*—magnitude of the pressure at any specified location in a Hertzian contact area, as calculated from Hertz's equations of elastic deformation. The Hertzian contact pressure can also be calculated and reported as maximum value  $P_{max}$  in the centre of the contact or as  $P_{average}$  as average over the total contact area.

**D7421**

3.1.8 *lubricant*, *n*—any substance interposed between two surfaces for the purpose of reducing the friction or wear between them.

**G40**

3.1.9  $P_{geom.}$ , *n*—geometric contact pressure describes the load carrying capacity at test end.

3.1.10 *RpK*, *n*—Reduced peak height according to DIN EN ISO 13565-2:1998. RpK is the mean height of the peak sticking out above the core profile section.

3.1.11 *RvK*, *n*—Reduced valley height according to DIN EN ISO 13565-2:1998. RvK is the mean depth of the valley reaching into the material below the core profile section.

3.1.12 *Rz (DIN)*, *n*—in measuring surface finish, the average of all  $R_y$  values (peak to valley heights) in the assessment length.<sup>4</sup>

3.1.13 *wear*, *n*—damage to a solid surface, generally involving progressive loss of material, due to relative motion between that surface and a contacting substance or substances.

**G40**

3.1.14  $W_v$ , *n*—Wear volume is the loss of volume to the ball after a test.

### 3.2 Definitions of Terms Specific to This Standard:

3.2.1 *seizure*, *n*—localized fusion of metal between the rubbing surfaces of the test pieces.

**D5706**

3.2.1.1 *Discussion*—In this test method, seizure is indicated by a sharp rise in the coefficient of friction, over steady state, of greater than 0.2 for over 20 s. In severe cases, a stoppage in the motor will occur.

### 3.3 Abbreviations:

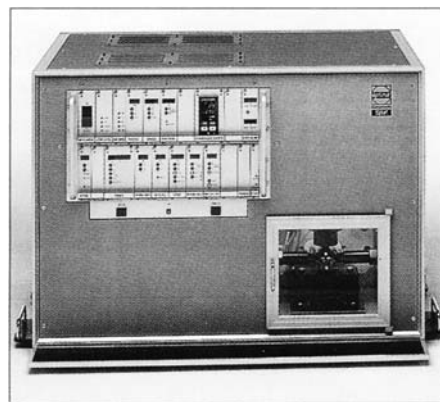

FIG. 1 SRV Test Machine

3.3.1 *SRV*, *n*—Schwingung, Reibung, Verschleiss, (German); oscillating, friction, wear, (English translation).

**D5706**

## 4. Summary of Test Method

4.1 This test method is performed on an SRV test machine using a test ball oscillated at constant frequency and stroke amplitude and under constant load ( $F_n$ ), against a test disk that has been moistened with the lubricant specimen. The platform to which the test disk is attached is held at a constant temperature.

NOTE 1—The frequency of oscillation, stroke length, test temperature, test load, test duration, and test ball and disk material can be varied from those specified in this test method. The test ball yields Hertzian point contact geometry. To obtain line or area contact, test pieces of differing configurations can be substituted for the test ball.

4.2 The friction force,  $F_f$ , is measured by a piezo-electric device in the test disk assembly. Peak values of coefficient of friction,  $f$ , are determined and recorded as a function of time.

4.3 After a preset test period, the test machine and chart recorder are stopped and the wear scar on the ball is measured. If a profilometer is available, a trace of the wear scar on the test disk can also be used to obtain additional wear information.

## 5. Significance and Use

5.1 This test method can be used to determine anti-wear properties and coefficient of friction of EP lubricating oils at selected temperatures and loads specified for use in applications in which high-speed vibrational or start-stop motions are present for extended periods of time under initial high Hertzian point contact pressures. It has found application as a screening test for lubricants used in gear or cam/follower systems. Users of this test method should determine whether results correlate with field performance or other applications.

## 6. Apparatus

6.1 *SRV Test Machine*<sup>5</sup>(see Fig. 1), consists of an oscillation

<sup>4</sup> Amstutz, Hu, "Surface Texture: The Parameters," Bulletin MI-TP-003-0785, Sheffield Measurement Division, Warner and Swazey, 1985, p. 21.

<sup>5</sup> The sole source of supply known to the committee at this time is Optimol Instruments Prüftechnik GmbH, Friedenstrasse 10, D81671 Munich, Germany. If you are aware of alternative suppliers, please provide this information to ASTM Headquarters. Your comments will receive careful consideration at a meeting of the responsible technical committee,<sup>1</sup> which you may attend.

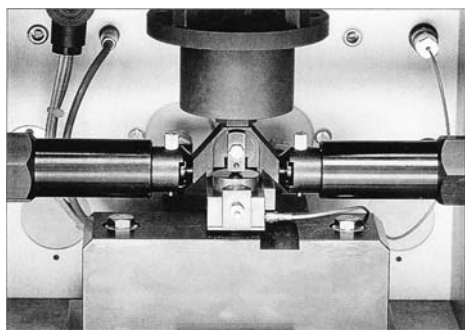

**FIG. 2 Test Chamber**

drive, a test chamber (see Fig. 2), and a loading device<sup>6</sup> with a servomotor and a load cell. The machine is operated by a control device for the oscillating drive, a timer, a load control, a frequency control, a stroke control, a data amplifier to determine the friction coefficient, and a switch and a controller for the heating. An oscilloscope may be used for monitoring. Friction coefficients are recorded in relation to time by a chart recorder, or by data acquisition in a computer.

6.1.1 On the firmly mounted receiving block (1) in the test chamber (see Fig. 3), there is a piezoelectric device (2) to measure the friction force,  $F_f$ , and the friction coefficient,  $f$ ; the holder for the test disk (3) with a thermostat-controlled electrical resistance heating element (4); a resistance thermometer (5); the oscillation drive rods (6); an exchangeable holder for the test ball (7); and the load rods of the loading device (8).

6.1.2 The design of the receiving block for the test disk should be such that it has integrated cooling coils, or that cooling coils are wound round it, so that the receiving block must be capable of maintaining test temperatures down to +233K. The test disk (9) and the test ball (10) are inserted into their respective holders (3, 4) (see Fig. 3).

6.1.3 Disks are generally used as the lower test piece. Balls, cylinders, rings, or specialized shapes may be used, with appropriate holders, as the upper test piece (see Fig. 4).

6.2 *Microscope*, equipped with a filar eyepiece graduated in 0.005-mm divisions or equipped with a micrometre stage readable to 0.005 mm. Magnification should be sufficient to allow for ease of measurement.

6.3 *Syringe*, suitable for applying 0.3 mL of the lubricating oil under test.

6.4 *Tweezers*, straight, round, about 200-mm long, with non-marring tips.

6.5 *Torque Wrench*, initial torque 0.5 to 5 Nm.

6.6 *Ultrasonic Cleaner*.

## 7. Reagents and Materials

7.1 *Test Balls*,<sup>7</sup> AISI 52100 Steel,  $60 \pm 2$  HRC hardness,  $0.025 \pm 0.005$ - $\mu\text{m}$  C.L.A. surface finish, 10-mm diameter.

<sup>6</sup> Optimol Instruments supplies an upgrade kit to allow older machines to operate with 1600 N, if needed.

<sup>7</sup> ASM Handbook, "Friction, Lubrication, and Wear Technology," Vol 18, October 1992.

7.2 *Test Disk*,<sup>7</sup> vacuum arc remelted (VAR) AISI 52100 steel with an inclusion rating using method D, Type A, as severity level number of 0,5 according to Test Methods E45 and Specification A295 or a inclusion sum value  $K1 \leq 10$  according to DIN EN ISO 683-17 and spheroidized annealed to obtain globular carbide,  $62 \pm 1$  HRC hardness, the surfaces of the disk being lapped and free of lapping raw materials. The topography of the disk will be determined by four values:  $0.5 \mu\text{m} < Rz < 0.650 \mu\text{m}$ ;  $0.035 \mu\text{m} < C.L.A. < 0.050 \mu\text{m}$ ,  $0.020 \mu\text{m} < Rpk < 0.035 \mu\text{m}$  and  $0.050 \mu\text{m} < Rvk < 0.075 \mu\text{m}$ ,  $24 \pm 0.5$ -mm diameter by  $7.8 \pm 0.1$ -mm thick.

NOTE 2—DIN 17230-1980 was replaced by DIN EN ISO 683-17.

7.3 *Cleaning Solvent*, single boiling point spirit type 2-A according to DIN 51631. (**Warning**—Flammable. Health hazard.)

## 8. Preparation of Apparatus

8.1 Turn on the test machine and chart recorder and allow to warm up for 15 min prior to running tests.

8.2 Select the friction data to be presented in the crest peak value position in accordance with the manufacturer's directions.

NOTE 3—In most cases, this is accomplished by positioning the sliding switch on electronic card No. 291.35.20E (front side of electronics behind front panel) and the sliding switch located on the back panel of the control unit.

8.3 Turn the amplitude knob to ZERO.

8.4 Switch the stroke adjustment to AUTO position.

8.5 Set the frequency to 50 Hz and duration to 2 h, 00 min, 30 s in accordance with the manufacturer's instructions.

8.6 Set the load charge amplifier to the setting that corresponds to the load foreseen for the test in accordance with the manufacturer's instructions. The test can be run at constant normal forces selected in +100 N increments starting at +100 N.

NOTE 4—In later SRV models, the load charge amplifier is set automatically.

8.7 Set the desired span, and calibrate the chart recorder in accordance with the manufacturer's instructions. Select the desired chart speed.

## 9. Procedure

9.1 *Installation of the Test Pieces and Lubricating Oil Specimen in the Test Chamber:*

9.1.1 Using solvent resistant gloves, clean the test ball, ball holder, and disk by wiping the surfaces with laboratory tissue soaked with cleaning solvent (single boiling point spirit type 2-A according to DIN 51631). (**Warning**—This mixture is flammable and a health hazard.) Repeat wiping until no dark residue appears on the tissue. Immerse the ball and disk in a beaker of the cleaning solvent under ultrasonic vibration (if available) for 10 min. Dry the ball holder. Dry the test ball and disk with a clean tissue, ensuring that no streaking occurs on the surface.

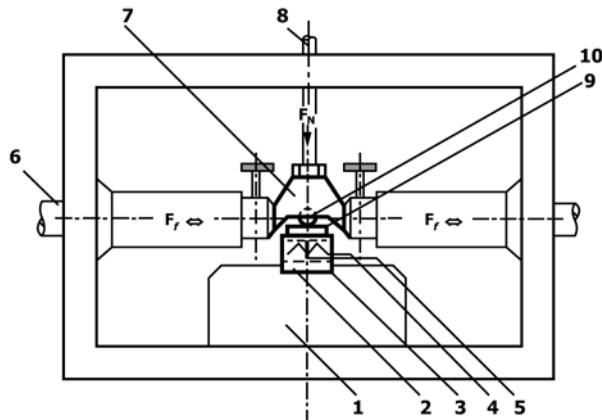

- |                                   |                          |
|-----------------------------------|--------------------------|
| 1. Receiving Block                | 6. Oscillation Drive Rod |
| 2. Piezoelectric Measuring Device | 7. Test Ball Holder      |
| 3. Test Disk Holder               | 8. Load Rod              |
| 4. Electrical Resistance Heater   | 9. Test Disk             |
| 5. Resistance Thermometer         | 10. Test Ball            |

FIG. 3 Test Chamber Elements

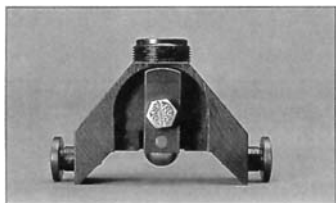

Point

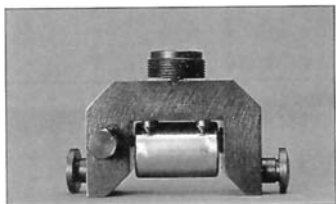

Line

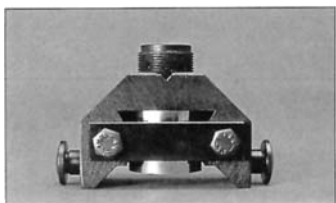

Area

FIG. 4 Test Pieces and Holders for Standard Tribological Contacts

9.1.2 Ensure that the machine is unloaded (indicated by a load reading of  $-13$  or  $-14$  N), and install the ball holder (upper specimen holder).

9.1.3 Place 0.3 mL of the lubricating oil to be tested on the cleaned disk. Then install the disk (place on the block). Tighten the fastening screw until resistance just begins.

9.1.4 Place the cleaned ball, using the tweezers, in the disassembled, cleaned, and dried ball holder. Tighten the fastening screw until resistance just begins.

9.1.5 Install the ball holder, and test ball in the test chamber.

9.1.6 Turn on the heater control, and preheat the disk holder to  $50^{\circ}\text{C}$ .

9.1.7 Apply a load of 50 N, loosen the fastening screws on both disk and ball holders, and then immediately tighten them with a torque wrench to 2.2 to 2.5 Nm.

#### 9.2 Test Run:

##### 9.2.1 Start of the Test Run:

9.2.1.1 Allow 10 min for the test pieces and test oil to reach and stabilize at the test temperature. The test can be run at constant temperatures selected in  $+10$  K ( $+10^{\circ}\text{C}$ ) increments starting at  $+233\text{K}$  to  $+553\text{K}$  ( $-40^{\circ}\text{C}$  to  $+280^{\circ}\text{C}$ ).<sup>8</sup>

NOTE 5—An initial hardness of 62.5 HRC at room temperature of AISI 52100 will drop to 61 HRC after 100 h at  $149^{\circ}\text{C}$  and will exist as a hot hardness of 60 HRC over 100 h.<sup>8</sup>

9.2.1.2 When the temperature has stabilized, turn on the chart recorder paper feed (or the computer) and lower the recording pens. Depress the drive start toggle switch until the timer begins to count and then adjust the stroke amplitude knob to 1.00 mm.

NOTE 6—Stroke should be checked periodically by measuring the wear track length minus the ball scar diameter. The difference must be smaller than  $\pm 10\%$  of the set stroke.

9.2.1.3 When the digital timer reaches 30 s, increase the load to 300 N and run at that load for  $2\text{ h} \pm 15\text{ s}$ .

##### 9.2.2 Terminating the Test Run:

9.2.2.1 The test is automatically terminated by the timer when the preset test time has elapsed. The machine will automatically stop.

NOTE 7—Power automatically turns off at the end of the test.

NOTE 8—If, due to seizure, the friction coefficient exceeds the limit  $f = 0.35$ , the test should be terminated. If the machine does not automatically shut down at this point, it may have to be switched off manually.

<sup>8</sup> Zaretsky, E. V., "Tribology for Aerospace Applications," STLE SP-37, 1997, p. 358.

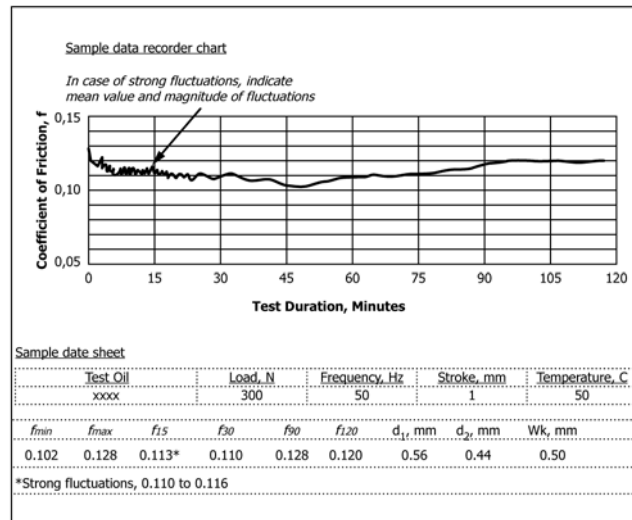

FIG. 5 Sample Recording Chart and Data Sheet for Evaluating Coefficients of Friction and Wear Scar Diameters

9.2.2.2 At the end of the test, turn off the heater control, turn power back on, and reduce the load to -13 or -14 N for disassembly.

9.2.2.3 Remove and clean the test ball and disk in accordance with 9.1.1.

9.3 Evaluation:

9.3.1 Place the cleaned test ball on a suitable holder, and using a microscope, measure to the nearest 0.01 mm the scar width in the direction of sliding ( $d_1$ ) and again at 90° to the direction of sliding ( $d_2$ ). The mean wear scar diameter (WSD or  $W_k$ ) is the average of these two measurements ( $WSD = (d_1 + d_2)/2$ ). If the wear scar diameter is smaller than 1.1 times the Hertzian contact diameter, the profile of the wear scar in the center should be measured in order to calculate the wear volume,  $W_v$ . If the wear scar diameter is greater than 1.1 times the Hertzian contact diameter, the wear scar diameter should only be reported (see Fig. 5). The wear volume,  $W_v$  ( $mm^3$ ), should be used.

NOTE 9—It is preferable to measure wear volume. A procedure for measuring the wear profile and calculating the wear volume is described in DIN 51834:2000, part 3. An official English translation of this procedure is in preparation by DIN.<sup>3</sup>

9.3.2 Although not specifically part of the procedure, when additional wear analysis is required, perform a profilometric trace across the wear scar on the test disk in accordance with the profilometer manufacturer’s instructions.

9.3.3 Measure the minimum and maximum coefficients of friction ( $f_{min}$ ,  $f_{max}$ ) and the coefficients at 15, 30, 90, and 120 min ( $f_{15}$ ,  $f_{30}$ ,  $f_{90}$ ,  $f_{120}$ ) from the chart recorder graph or computer, with a precision of 0.001.

9.3.4 If strong fluctuations (band width  $\geq 0.005$ ) in the coefficient of friction are indicated on the chart recorder or other output device adjacent to the point at which the coefficient is measured, record the mean value and the magnitude of the fluctuations at that point (see Fig. 5).

9.3.5 The load carrying capacity can be additionally reported as geometric contact pressure  $P_{geom.}$  at test end according to the following equation:

$$P_{geom.} = \frac{4 F_N}{\pi W_k^2} \quad (2)$$

where:

- $F_N$  = normal force (test load),
- $P_{geom.}$  = geometric contact pressure, and
- $WSD$  or  $W_k$  = mean wear scar diameter.

10. Report

10.1 Report the following information:

10.1.1 All parameters used to evaluate materials as follows:

- 10.1.1.1 Test temperature, °C,
- 10.1.1.2 Test break-in load, N,
- 10.1.1.3 Test frequency, Hz,
- 10.1.1.4 Test stroke, mm,
- 10.1.1.5 Test ball material,
- 10.1.1.6 Test disk material, and
- 10.1.1.7 Test oil sample.

10.2 Report both wear scar measurements taken on the ball ( $d_1$ ,  $d_2$ ) and the average WSD.

10.3 Report all measurements of the coefficient of friction,  $f_{min}$ ,  $f_{max}$ ,  $f_{15}$ ,  $f_{30}$ ,  $f_{90}$ ,  $f_{120}$ , and the magnitude of any strong fluctuations in the coefficients of friction, and when required by specification, include a copy of the friction recording.

10.4 Report the depth of the wear scar on the lower specimen disk if a profilometer reading was made.

11. Precision and Bias

11.1 Data for the precision calculations of this test method were obtained by DIN 51834-2:1997. Twenty-two cooperators tested three lubricating oils, an engine oil, an anti-wear hydraulic oil, and an industrial EP gear oil, in the SRV apparatus. The test load for the engine and hydraulic oils was 300 N and that for the gear oil was 200 N. The test temperature was 50°C, the frequency was 50 Hz, and the stroke amplitude was 1 mm for all three test oils. Average coefficients of friction ranged from 0.126 to 0.140 for the engine oil, 0.111 to 0.119 for the hydraulic oil, and 0.112 to 0.127 for the gear oil.

Average ball wear scars (WSD) were 0.77 mm with the engine oil, 0.51 with the hydraulic oil, and 0.62 with the gear oil.<sup>9</sup>

11.1.1 The current precision statements were taken from DIN 51834-2:2001 based on the international round robin tests from 1997-2000 using FN= 300N, 1 mm of stroke, 0.03 mL of the lubricating oil, and T= 50°C.

NOTE 10—The repeatability and reproducibility values depend on the oil that has been used. The values stated in 11.2.1.1 and 11.2.1.2 represent maximum values. In singular cases, smaller values were determined in RR tests according to DIN 51834, part 2.

11.1.2 The values for precision were refined. These results were published<sup>10,11,12</sup> and filed as new research report.<sup>9</sup>

NOTE 11—“The extension to a test temperature of +150°C depends from the anti-oxidation resistance of the test fluid and the extreme pressure additives suited for such a test temperature and that no seizure occurs at +150°C. If so, then the repeatability and reproducibility for testing at +150°C lie within the existing set limits for precision (See the research report RR:D02-1454).”

11.2 *Precision*—The precision of this test method, as determined by statistical examination of the interlaboratory test results described in 11.1 is:

11.2.1 *Average Ball WSD*:

11.2.1.1 *Repeatability*—The difference between successive results obtained by the same operator with the same apparatus under constant operating conditions on identical test material would, in the long run, in the normal and correct operation of

the test method, exceed the following value in only one case in twenty.

0.07 mm

11.2.1.2 *Reproducibility*—The difference between two single and independent results obtained by different operators working in different laboratories on the identical test material would, in the long run, in the normal and correct operation of the test method, exceed the following value in only one case in twenty.

0.2 mm

11.2.2 *Coefficient of Friction, f*:

11.2.2.1 *Repeatability*—The difference between successive results obtained by the same operator with the same apparatus under constant operating conditions on identical test material would, in the long run, in the normal and correct operation of the test method, exceed the following value in only one case in twenty.

0.01

11.2.2.2 *Reproducibility*—The difference between two single and independent results obtained by different operators working in different laboratories on the identical test material would, in the long run, in the normal and correct operation of the test method, exceed the following value in only one case in twenty.

0.03

11.3 *Bias*—The evaluation of friction and wear properties of lubricating oil by this test method has no bias because coefficients of friction and WSD can be defined only in terms of the test method.

## 12. Keywords

12.1 coefficient of friction; EP additives; EP lubricants; lubricating oil; oscillation; SRV; wear

<sup>9</sup> Supporting data have been filed at ASTM International Headquarters and may be obtained by requesting Research Report RR:D02-1454. The RR data at 80°C and 120°C were filed as Research Report RR:D02-1579.

<sup>10</sup> Tribologie & Schmierungstechnik, 44(6), 1997, p. 284.

<sup>11</sup> Tribologie & Schmierungstechnik, 46(2), 1999, p. 36.

<sup>12</sup> *Bench Testing of Industrial Fluid Lubrication and Wear Properties Used in Machinery Applications*, ASTM STP 1404, Totten, G. E., Wedeven, L. D., Dickey, J. R., Anderson, M., Eds., ASTM International, W. Conshohocken, PA, 2001, pp.199-209.

**Hertzian stress condition**  
for AISI 52100 against AISI 52100 in ball/disk arrangement

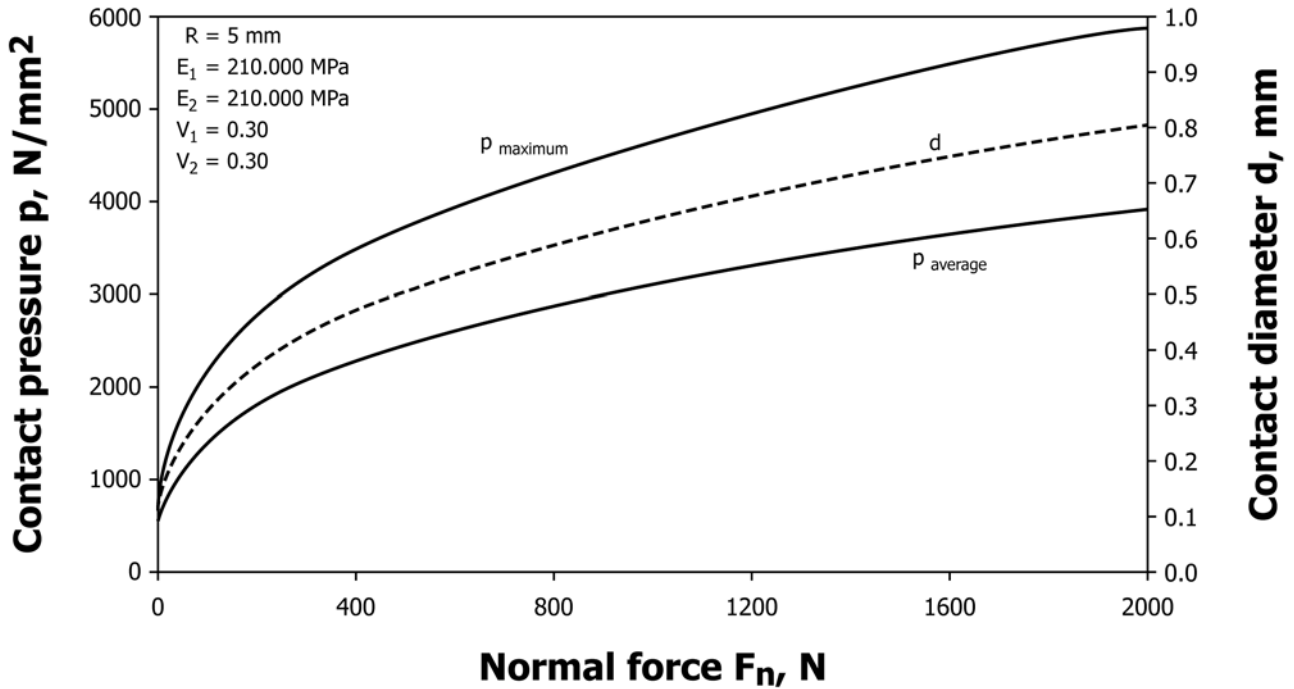

$P_{\text{maximum}}$  = Maximum of the Hertzian stress (N/mm<sup>2</sup>)  
 $P_{\text{average}}$  = Average of the Hertzian stress (N/mm<sup>2</sup>)

FIG. 6 Evaluation of Hertzian Contact Diameter and Contact Pressure over Test Load

APPENDIX

X1. PRECISION DATA MEASURED AT HIGHER TEMPERATURES

X1.1 Test Method D6425 allows test temperatures other than 50°C, and the precision statements in Section 11 are determined at 50°C. Table X1.1 and Table X1.2 present

precision data determined in international round-robin tests in 2002 and 2003 with two commercial oils at 80°C and 120°C in comparison to the data at 50°C of the same oils.

TABLE X1.1 6th International Round Robin Test—2002<sup>A</sup>

Year	RR2002		RR2002		RR2001	
	Industrial Oil A VG 220		Industrial Oil A VG 220		Industrial Oil A VG 220	
Test Oils	120°C		80°C		50°C	
Temperature	120°C		80°C		50°C	
Statistical Quantities (D2PP)	Coefficient of friction	Wear scar diameter of the ball	Coefficient of friction	Wear scar diameter of the ball	Coefficient of friction	Wear scar diameter of the ball
	$f_{\text{END}}$	$W_{\text{K-average}}$ [mm]	$f_{\text{END}}$	$W_{\text{K-average}}$ [mm]	$f_{\text{END}}$	$W_{\text{K-average}}$ [mm]
Degree of freedom	31	29	29	26	33	34
Mean	0.0895	0.4824	0.0919	0.477	0.1006	0.4683
Standard deviation	±0.0095	±0.0226	±0.00701	±0.0261	±0.0128	±0.0216
Reproducibility (R)	0.0287	0.0654	0.0203	0.00758	0.0369	0.062
	(set point: ≤0.03)	(set point: ≤0.2)	(set point: ≤0.03)	(set point: ≤0.2)	(set point: ≤0.03)	(set point: ≤0.2)
Repeatability (r)	0.0132	0.035	0.00778	0.026	0.00873	0.0266
	(set point: ≤0.01)	(set point: ≤0.07)	(set point: ≤0.01)	(set point: ≤0.07)	(set point: ≤0.01)	(set point: ≤0.07)

<sup>A</sup> Statistical analysis using ASTM D2PP software >55 single results per test oil. (Test conditions:  $F_N = 300 \text{ N}$ ;  $T = 50^\circ\text{C}$ ;  $t = 120 \text{ min}$ ;  $\Delta x = 1 \text{ mm}$ ;  $n_v = 50 \text{ Hz}$ ; lapped AISI52100-disks; polished AISI52100-balls,  $\varnothing = 10 \text{ mm}$ )

**TABLE X1.2 7th International Round Robin Test—2003<sup>A</sup>**

Year	RR2003		RR2003		RR2000	
	Industrial Oil B VG 220		Industrial Oil B VG 220		Industrial Oil B VG 220	
Test Oils	120°C		80°C		50°C	
Temperature	120°C		80°C		50°C	
Statistical Quantities (D2PP)	Coefficient of friction	Wear scar diameter of the ball	Coefficient of friction	Wear scar diameter of the ball	Coefficient of friction	Wear scar diameter of the ball
	$f_{END}$	$W_{K-average}$ [mm]	$f_{END}$	$W_{K-average}$ [mm]	$f_{END}$	$W_{K-average}$ [mm]
Degree of Freedom	23	27	24	27	39	45
Mean	0.0986	0.4835	0.1038	0.403	0.1105	0.47397
Standard Deviation	±0.00839	±0.0189	±0.00699	±0.0257	±0.00891	±0.0403
Reproducibility (R)	0.0246	0.0548	0.0195	0.0747	0.02540	0.1146
Repeatability (r)	(set point: ≤0.03)	(set point: ≤0.2)	(set point: ≤0.03)	(set point: ≤0.2)	(set point: ≤0.03)	(set point: ≤0.2)
	0.00439 (set point: ≤0.01)	0.0277 (set point: ≤0.07)	0.00491 (set point: ≤0.01)	0.0326 (set point: ≤0.07)	0.00772 (set point: ≤0.01)	0.6680 (set point: ≤0.07)

<sup>A</sup> Statistical analysis using ASTM D2PP software >43 single results per test oil. (Test conditions:  $F_N = 300$  N;  $T = 50^\circ\text{C}$ ;  $t = 120$  min;  $\Delta x = 1$  mm;  $n_v = 50$  Hz; lapped AISI52100-disks; polished AISI52100-balls,  $\varnothing = 10$  mm)

## SUMMARY OF CHANGES

Subcommittee D02.L0 has identified the location of selected changes to this standard since the last issue (D6425–05(2010)<sup>e1</sup>) that may impact the use of this standard.

(1) Cleaned up Section 3, Terminology.

*ASTM International takes no position respecting the validity of any patent rights asserted in connection with any item mentioned in this standard. Users of this standard are expressly advised that determination of the validity of any such patent rights, and the risk of infringement of such rights, are entirely their own responsibility.*

*This standard is subject to revision at any time by the responsible technical committee and must be reviewed every five years and if not revised, either reapproved or withdrawn. Your comments are invited either for revision of this standard or for additional standards and should be addressed to ASTM International Headquarters. Your comments will receive careful consideration at a meeting of the responsible technical committee, which you may attend. If you feel that your comments have not received a fair hearing you should make your views known to the ASTM Committee on Standards, at the address shown below.*

*This standard is copyrighted by ASTM International, 100 Barr Harbor Drive, PO Box C700, West Conshohocken, PA 19428-2959, United States. Individual reprints (single or multiple copies) of this standard may be obtained by contacting ASTM at the above address or at 610-832-9585 (phone), 610-832-9555 (fax), or service@astm.org (e-mail); or through the ASTM website (www.astm.org). Permission rights to photocopy the standard may also be secured from the Copyright Clearance Center, 222 Rosewood Drive, Danvers, MA 01923, Tel: (978) 646-2600; http://www.copyright.com/*