



Standard Guide for Sampling of Drums and Similar Containers by Field Personnel¹

This standard is issued under the fixed designation D6063; the number immediately following the designation indicates the year of original adoption or, in the case of revision, the year of last revision. A number in parentheses indicates the year of last reapproval. A superscript epsilon (ϵ) indicates an editorial change since the last revision or reapproval.

1. Scope

1.1 This guide covers information, including flow charts, for field personnel to follow in order to collect samples from drums and similar containers.

1.2 The purpose of this guide is to help field personnel in planning and obtaining samples from drums and similar containers, using equipment and techniques that will ensure that the objectives of the sampling activity will be met. It can also be used as a training tool.

1.3 *This standard does not purport to address all of the safety concerns, if any, associated with its use. It is the responsibility of the user of this standard to establish appropriate safety and health practices and determine the applicability of regulatory limitations prior to use. See specific Warnings in 7.4.3 and 7.4.4.*

2. Referenced Documents

2.1 ASTM Standards:²

- D783 Practice for Core Sampling of Graphite Electrodes
- D1452 Practice for Soil Exploration and Sampling by Auger Borings
- D1586 Test Method for Penetration Test (SPT) and Split-Barrel Sampling of Soils
- D1587 Practice for Thin-Walled Tube Sampling of Soils for Geotechnical Purposes
- D2113 Practice for Rock Core Drilling and Sampling of Rock for Site Investigation
- D4448 Guide for Sampling Ground-Water Monitoring Wells
- D4687 Guide for General Planning of Waste Sampling
- D4700 Guide for Soil Sampling from the Vadose Zone
- D4823 Guide for Core Sampling Submerged, Unconsolidated Sediments

¹ This guide is under the jurisdiction of ASTM Committee D34 on Waste Management and is the direct responsibility of Subcommittee D34.01.02 on Sampling Techniques.

Current edition approved Nov. 15, 2011. Published December 2011. Originally approved in 1996. Last previous edition approved in 2006 as D6063 – 96 (2006). DOI: 10.1520/D6063-11.

² For referenced ASTM standards, visit the ASTM website, www.astm.org, or contact ASTM Customer Service at service@astm.org. For *Annual Book of ASTM Standards* volume information, refer to the standard's Document Summary page on the ASTM website.

- D4840 Guide for Sample Chain-of-Custody Procedures
- D5088 Practice for Decontamination of Field Equipment Used at Waste Sites
- D5283 Practice for Generation of Environmental Data Related to Waste Management Activities: Quality Assurance and Quality Control Planning and Implementation
- D5358 Practice for Sampling with a Dipper or Pond Sampler
- D5451 Practice for Sampling Using a Trier Sampler
- D5495 Practice for Sampling With a Composite Liquid Waste Sampler (COLIWASA)

3. Terminology

3.1 Definitions:

3.1.1 *bung, n*—usually a 2-in. (5-cm) or 3/4-in. (1.3-cm) diameter threaded plug specifically designed to close a bung hole.

3.1.2 *bung hole, n*—an opening in a barrel or drum through which it can be filled, emptied or vented.

3.1.3 *consolidated solid, n*—*as used in this guide*, a compact solid not easily compressed or broken into smaller portions.

3.1.4 *drum, n*—implies any drum, barrel or non-bulk container of 5 to 110 gal (19 to 400 L) capacity.

3.1.5 *representative sample, n*—a sample collected such that it reflects one or more characteristics of interest (as defined by the project objectives) of the population from which it was collected.

3.1.6 *sample, n*—one or more items or portions collected from a lot or population.

3.1.7 *sampler, n*—the device used to obtain a sample.

3.1.8 *sludge, n*—*as used in this guide*, any mixture of solids that settles out of solution; sludges contain liquids that are not apparent as free liquids.

3.1.9 *unconsolidated solid, n*—*as used in this guide*, uncemented or uncompacted material that is easily separated into smaller portions.

3.1.10 *work plans, n*—plans that are specific to sampling at a particular site; examples are Health and Safety Plans and Sampling and Analysis Plans.

4. Summary of Guide

4.1 This guide uses a decision-tree format to lead persons intending to sample waste materials from drums and similar containers through a series of questions. The answers to the questions result in recommended actions, including the selection of appropriate sampling equipment. Brief instructions on the use of the equipment are included.

4.2 This guide addresses commonly used sampling equipment and devices; it is not intended to cover all that might be purchased or custom made.

5. Significance and Use

5.1 This guide is intended to assist field personnel in obtaining samples from drums and similar containers for field and laboratory analysis. The need for accurate data and the costs associated with sampling and analysis make it essential that samples be taken correctly before submitting them for chemical analysis or physical testing, or both. Incorrect sampling can invalidate resulting data.

5.2 This guide may be used by personnel who have no formal workplan. It draws their attention to issues that must be

addressed before, during, and after taking a sample. It provides guidance in choosing the sampling technique and equipment suitable for specific situations. It can serve as a training tool for those who are unfamiliar with sampling. It is recommended that this guide be used as a supplement to a written workplan.

5.3 Some sections of this guide contain flow charts (see Figs. 1-5) that must be worked through, starting from the top of each page. By answering the questions in the diamond-shaped boxes, and following the appropriate arrows, the person planning to sample will be guided towards the most suitable procedures and equipment. The numbers at the bottom of some boxes refer to corresponding paragraphs in the text, which provide information to help the person sampling answer the questions.

5.4 Figs. 6-15 are examples of types of equipment. Similar devices that do the same job in the same way are not intended to be excluded.

6. Objectives of Sampling

6.1 The purpose of sampling is to collect a representative sample of all or part of the contents of the drum or similar

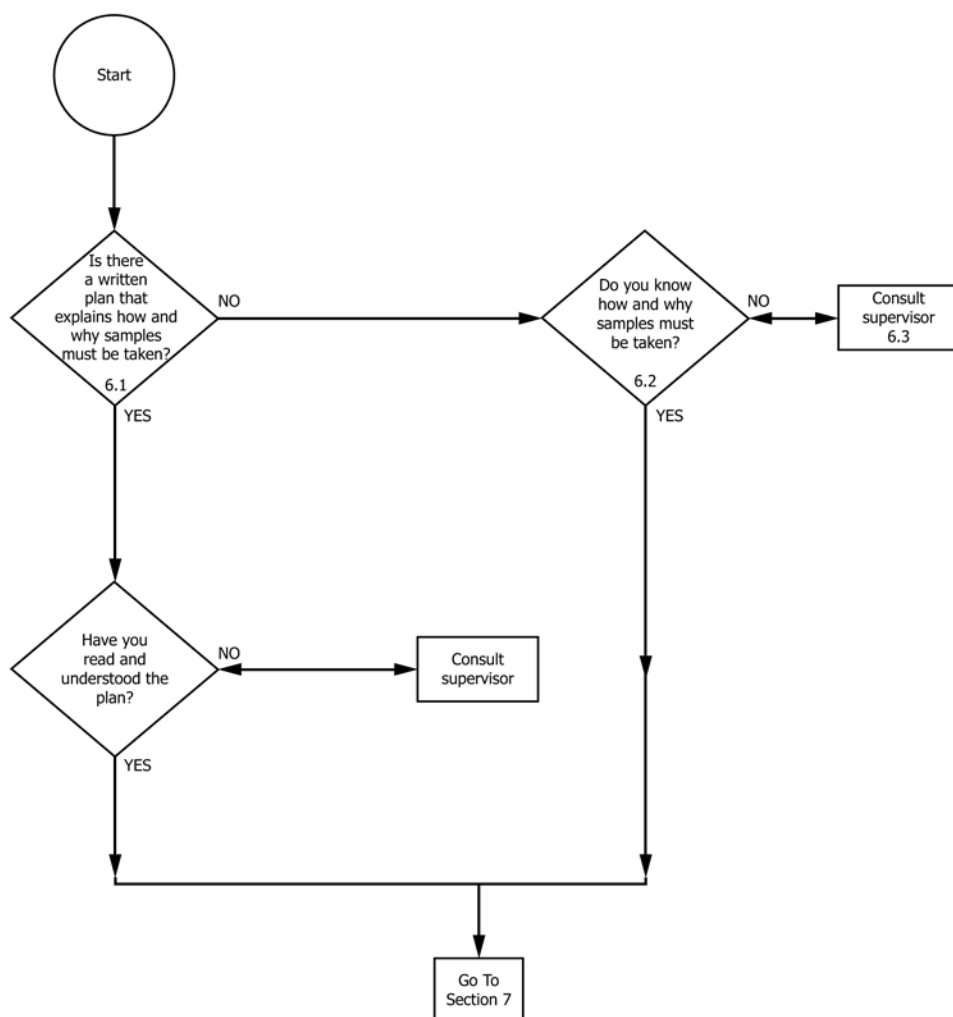

NOTE 1—This flow chart should be used with Section 6 in the text.

FIG. 1 Objectives of Sampling

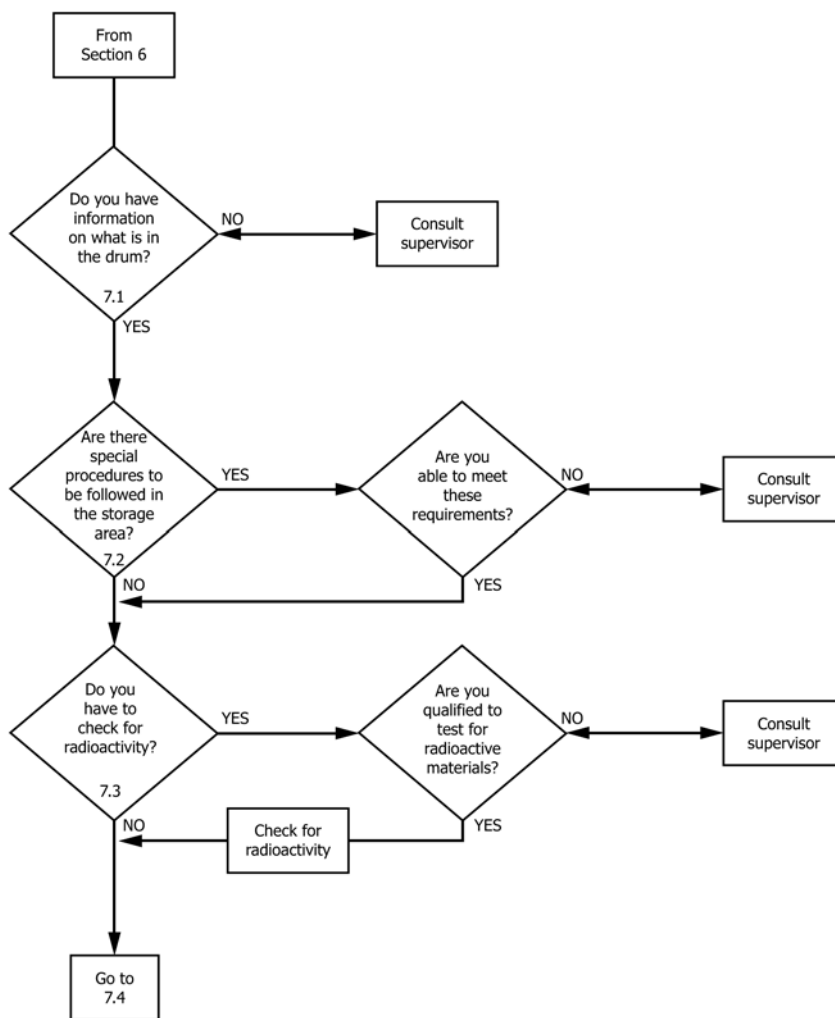

NOTE 1—This flow chart should be used with Sections 7.1 to 7.3 in the text.

FIG. 2 Pre-Sampling Inspection

container, to determine the physical and chemical characteristics of those contents (see Fig. 1). This information may then be used to:

- 6.1.1 Select suitable methods of treatment and disposal of the contents,
- 6.1.2 Provide evidence for use in a court of law,
- 6.1.3 Comply with regulations, such as those for the transportation of hazardous materials,
- 6.1.4 Confirm that the drums contain what is written on the label, manifest or other type of documentation, and
- 6.1.5 Find out if any drums in a lot contain different materials from the majority.

6.2 In most cases there is a written plan that describes the work to be done (Guide D4687). In other cases, there is no written plan and the instructions are only verbal.

6.3 If the objectives of sampling are unclear or unknown to the field personnel, they should question their supervisor or project manager about the objectives. Well-informed field personnel are then alert to unforeseen circumstances or events that might invalidate the samples.

7. Pre-Sampling Inspection

7.1 Information about the contents of the drums may be available from (see Fig. 2):

- 7.1.1 Previous analysis of drum contents from the same source,
- 7.1.2 The supplier/source of the material in the drums,
- 7.1.3 Manifest (shipping) documents,
- 7.1.4 Labels and other markings on the drums, or
- 7.1.5 Knowledge of the waste generating process.

7.2 Personnel doing the pre-sampling and sampling must be aware of any special procedures that are to be followed at a given site. Workplans include a worker health and safety section because there are potential hazards associated with opening drums as well as with potentially hazardous contents.^{3,4} Examples of special procedures are change of

³ *Drum Handling Practices at Hazardous Waste Sites*, EPA/600/2-86/013, January 1986.

⁴ *Field Sampling Procedures Manual*, New Jersey Department of Environmental Protection, Division of Remedial Support, August 2005 (available online).

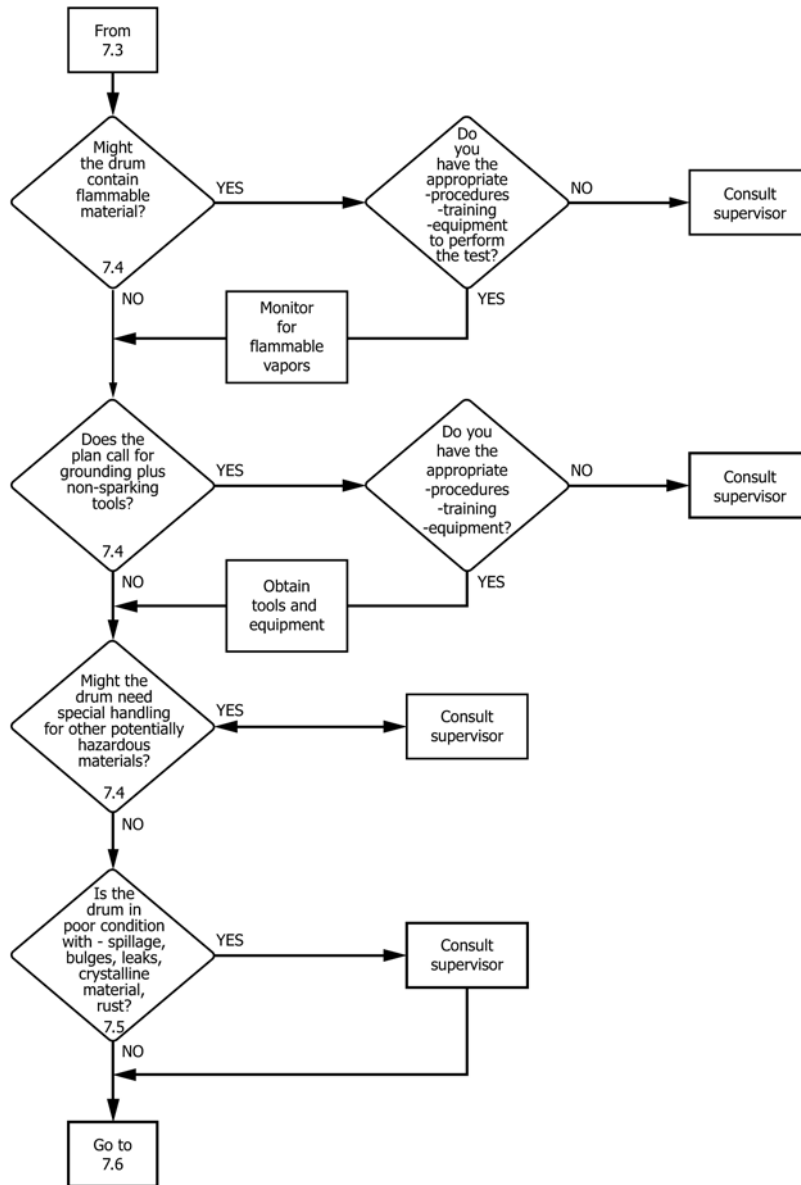

NOTE 1—This flow chart should be used with Sections 7.3 to 7.5 in the text.

FIG. 2 Pre-Sampling Inspection (continued)

clothing, use of safety equipment of various kinds, evacuation procedures, fire and explosion procedures and vehicle cleaning procedures such as water washing before leaving the site or storage area, and many others that would be site or storage specific.

7.3 If you are certain that the drum does not contain radioactive material and the workplan does not require you to check for radioactivity, proceed to 7.4.

7.3.1 Many facilities are not licensed to handle radioactive materials and are legally obliged to prove that they do not knowingly accept them. Some facilities are licensed to handle radioactive materials; they need to have a measure of how radioactive the material is for the safety of their workers.

7.3.2 Hand-held monitors that check for radioactivity should always be used if you suspect that radioactive material might be present or if the workplan requires it. It is important

that the monitor has been calibrated correctly, according to the manufacturer’s instructions. Monitoring should be done only by those with the appropriate written procedures, training and equipment.

7.3.3 It is prudent to monitor a storage area before entering it. If radioactive material is found to be present when it should not be, leave the area immediately, post warning signs to alert other workers, and consult your supervisor.

7.4 Drums may contain flammable materials, strong oxidizers or reducing materials, light-sensitive materials, corrosive acids or bases, and materials sensitive to moisture or movement, or both. All of these drums require special handling, including segregation, when possible.

7.4.1 Many solvents, like benzene, evaporate into air space in and around the drum where the vapor may be easily ignited.

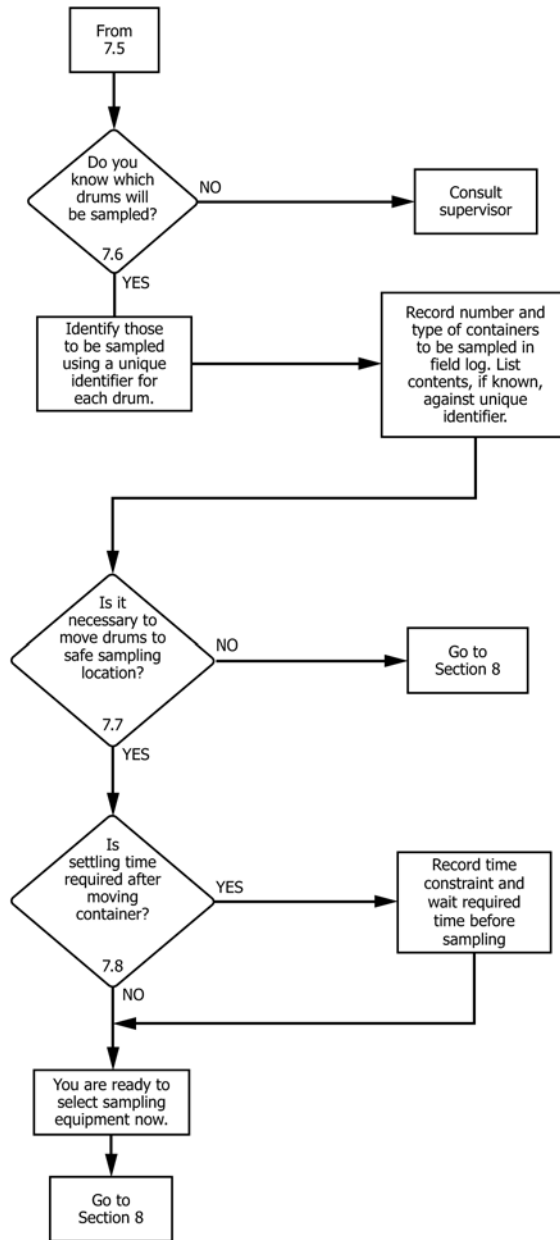

NOTE 1—This flow chart should be used with Sections 7.6 to 7.8 in the text.

FIG. 2 Pre-Sampling Inspection (continued)

7.4.2 If you are sampling a potentially flammable or unknown material, non-sparking tools should be used and the drums should be grounded.

7.4.3 If the drums are stored in a closed room or confined space, the air in the area should be tested by a hand-held monitor to check for flammable vapors. It is important that the monitor has been calibrated according to the manufacturer's instructions. The monitoring should be done by those with the appropriate training and written procedures. **(Warning—**Flammable materials should be sampled in a well-ventilated area. There are other safety considerations that must be

considered regarding confined spaces. It may be necessary to check for explosivity or oxygen levels.)

7.4.4 Labels on drums of waste materials may not be accurate. Unless the drums come from a reliable source, for example, the generator of the material and the process that created the waste are known to you, it is prudent to assume that the labels may not match the contents. **(Warning—**Attempting to open a drum that is in poor condition can expose a worker to the possibility of a serious, even fatal, accident. Special precautions should be taken when the bungs are rusted or corroded since the drum top may give way, exposing the

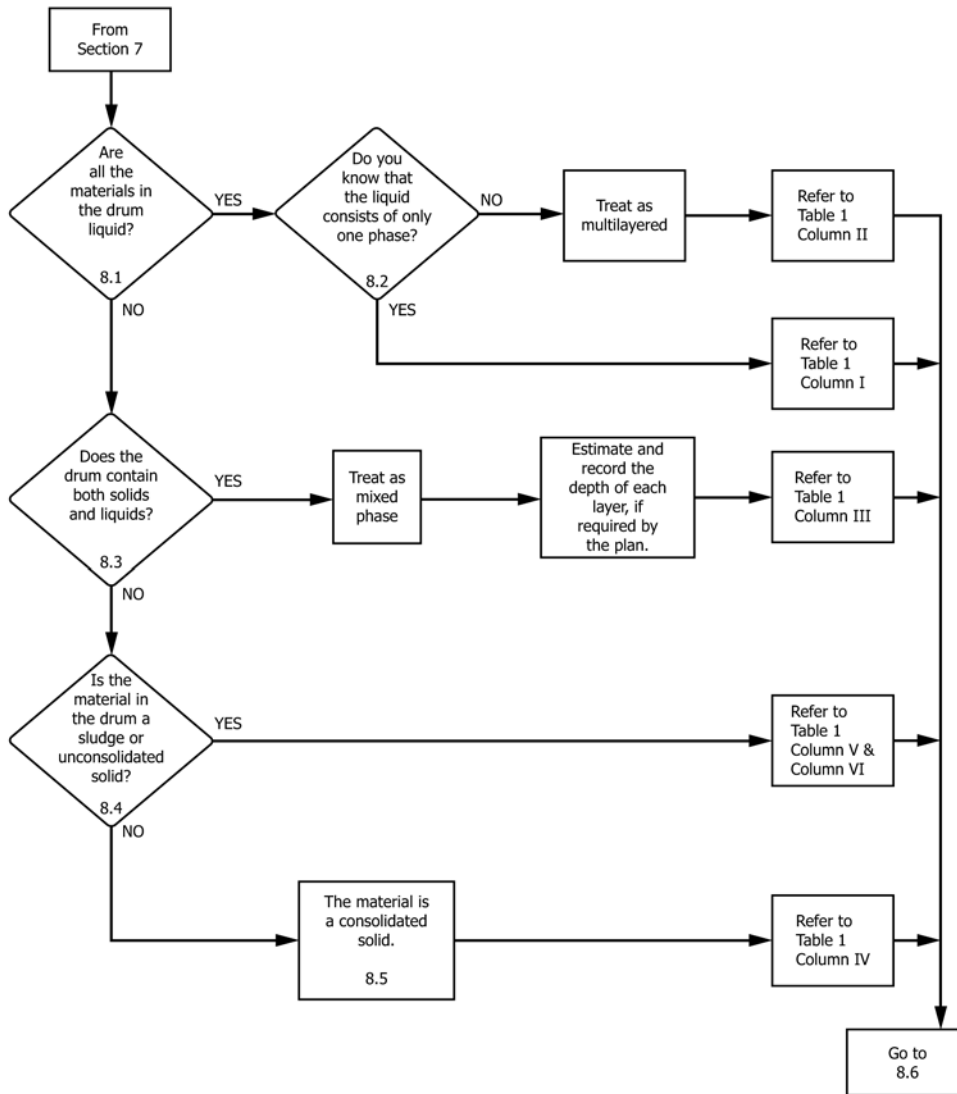

NOTE 1—This flow chart should be used with Sections 8.1 to 8.5 in the text.

FIG. 3 Selection of Suitable Sampling Procedure

worker to vapor or liquid. Overpacking before sampling should be considered for drums in poor condition.)

7.5 It is not always necessary to sample every drum in a lot. The workplans provide direction as to how many, and possibly which, drums should be sampled. Each drum that will be sampled must be identified in a unique way in case a second sample has to be taken later. Colored labels, crayons, paint sticks or pens, or stenciled paint can be used to identify drums. Any new identification system should not cover the existing labels or identifiers.

7.6 Sometimes drums have to be moved to another location for sampling; this is known as “drum staging.” This is required if:

7.6.1 Sampling the drum in its present location poses a high risk to surrounding property or individuals, or both,

7.6.2 The drum cannot be accessed for sampling in its current location, or

7.6.3 Exposure to climatic conditions alter the sample, for example, formation of ice; or create a health and safety risk, for example, the sun heating a drum containing solvents.

7.7 The physical condition of drums must be evaluated before attempting to open or move them (see Warning in 7.4.4). Drum carriers, which lock on the drum lip, should not be used to move the drum if the condition is poor.

7.8 Materials in layers, such as oil with water, can become mixed together when moved. If you want to sample each layer separately, the material may need time to settle before opening and sampling the drum.

8. Selection of Suitable Sampling Procedure

8.1 The physical state(s) of the material(s) being sampled is an important criterion when sampling (see Fig. 3).

8.2 A drum containing one liquid, such as water, or a mixture of liquids, such as a stable emulsion like hand cream,

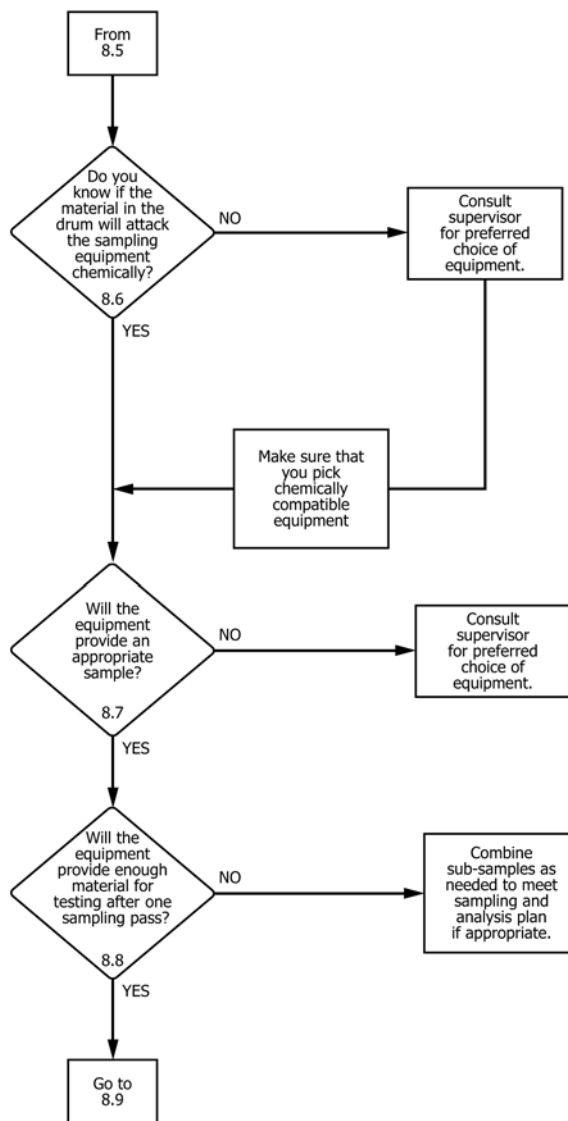

NOTE 1—This flow chart should be used with Sections 8.6 to 8.8 in the text.

FIG. 3 Selection of Suitable Sampling Procedure (continued)

that does not separate into two layers regardless of time, is said to contain one phase. A drum containing two liquids, such as oil and water, which form two distinct layers when they are not stirred is said to contain two phases.

8.3 When it is necessary to know the amounts of solid and liquid layers in a drum, a calibrated measuring device or the sampling equipment (for example, a COLIWASA) can be inserted into the opened drum (see Section 12) and the liquid level measured.

8.4 Although sludges behave like sticky solids and are not usually pumped, they can contain quite a high proportion of liquids, such as oil or water, which is not visible as free liquid.

8.5 An unconsolidated solid is a material like sand or a powder. A consolidated solid consists of material, like sandstone or concrete.

8.5.1 A drum containing mixed materials, such as disposable personal protective equipment and laboratory supplies, is treated as one with unconsolidated solids.

8.6 If the waste material is likely to attack the sampling equipment, such as an acid corroding a metal thief:

8.6.1 The equipment may partially dissolve, adding constituents, such as metals to the sample. Faulty conclusions may be drawn about the composition of the sample, leading to costly and unnecessary remedial actions, and

8.6.2 The equipment will have to be replaced frequently, adding costs to the project.

8.7 When selecting equipment, it is important to be aware of the limitations of the tools. The design of some equipment can result in part of the material not being sampled. For example, if the size of the opening(s) that allow the sample to enter a

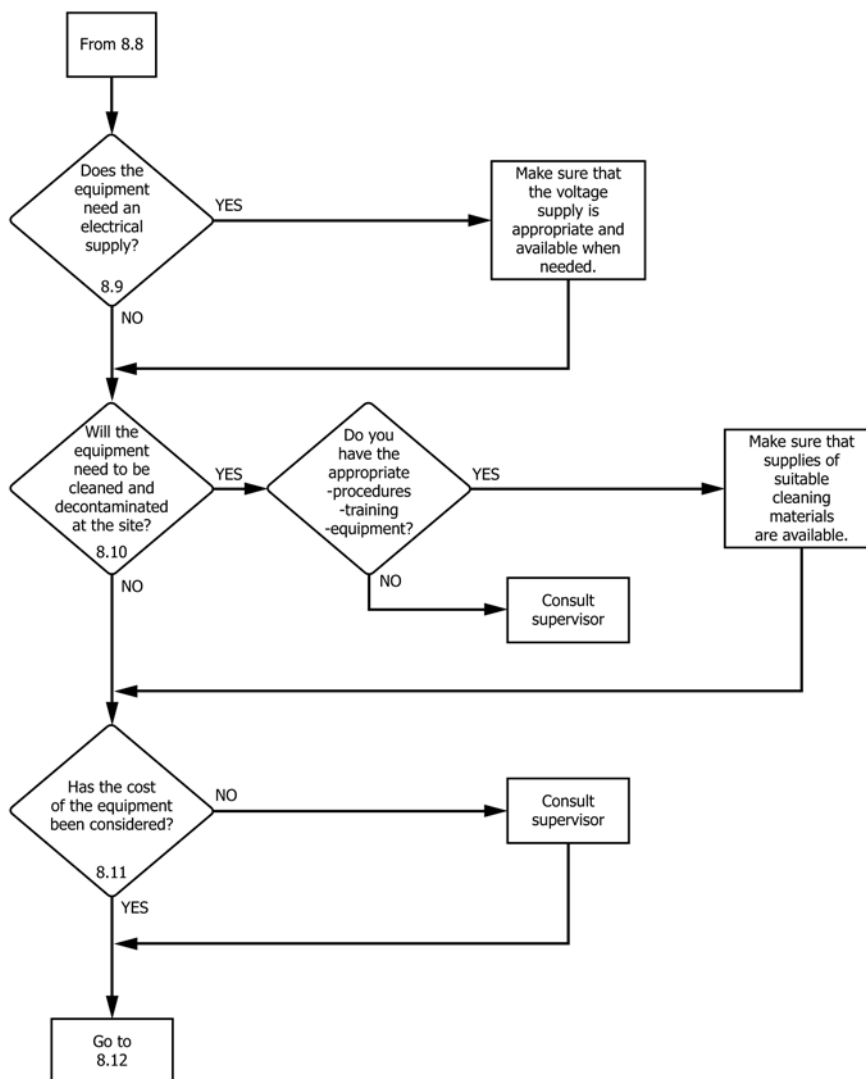

NOTE 1—This flow chart should be used with Sections 8.9 to 8.11 in the text.

FIG. 3 Selection of Suitable Sampling Procedure (continued)

trier is smaller than some of the particles in the drum, the sample will not be representative.

8.7.1 Volatile organic constituents are likely to be lost if the sampling equipment causes a buildup of heat or agitation of the sample, as will exposure to air for more than a very short time or storage in a sample container with a headspace above the sample.

8.7.2 See Table 1 for more information on the limitations of sampling equipment.

8.8 When the quantity of material that is removed from a drum by the equipment will not provide enough for the laboratory to perform all the required tests, a number of subsamples must be taken and combined. In doing this it is critical not to disturb layers; this could result in an unsuitable sample.

8.9 Pumps may require electricity to operate. If the sampling location is outdoors, they may need to be protected from

the weather. If flammable vapors were observed in 7.4, consult your supervisor about sources of ignition, such as pumps, electrical connections and switches.

8.10 Consideration should be given to having a separate clean sampling device for each drum since this eliminates cross-contamination and may be more efficient than cleaning one sampling device after each drum. It is generally easier to clean the sampling devices and other equipment in the laboratory or another suitable place where solvent disposal and drying equipment are readily available.

8.11 It is worthwhile to make a comparison of the costs of cleaning or decontaminating equipment, or both, including disposal of the cleaning agents, versus using disposable equipment when selecting and preparing equipment. The initial purchase price of the equipment may also be a factor in the selection. There may be more than one suitable device (see Table 2).

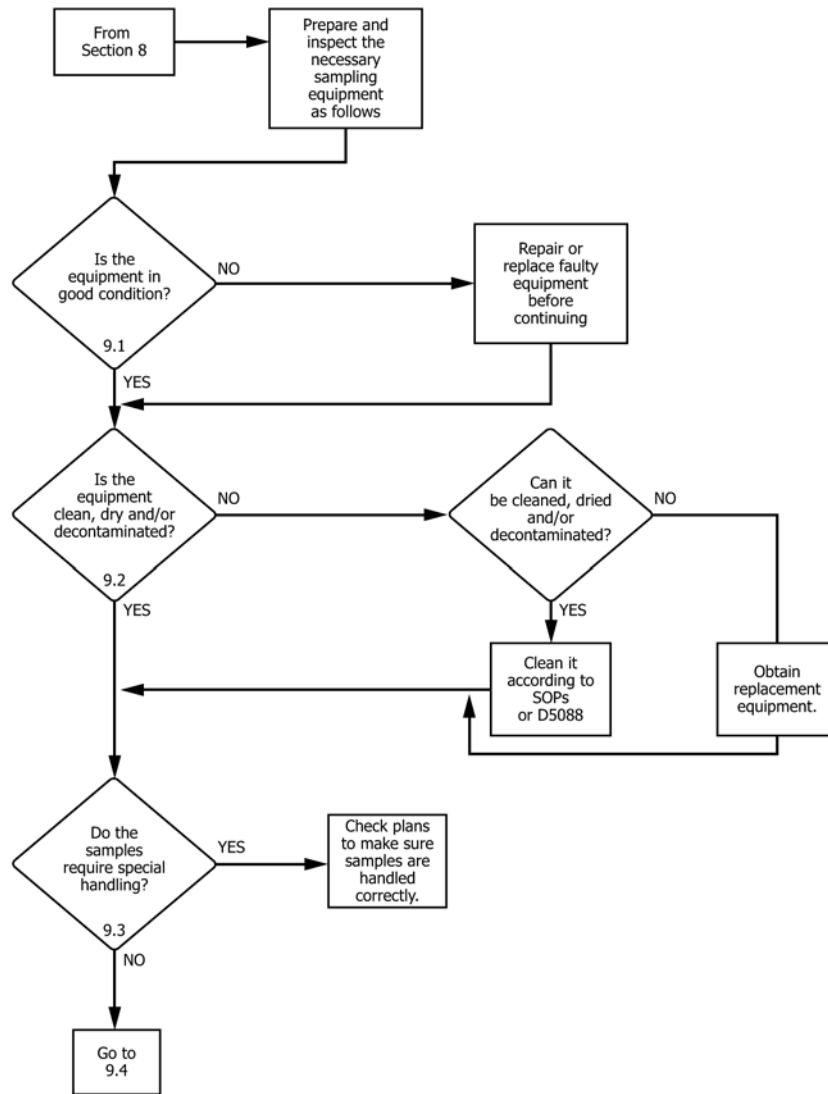

NOTE 1—This flow chart should be used with Sections 9.1 to 9.3 in the text.

FIG. 4 Preparation of Sampling Equipment

8.12 Table 1 and Table 2 list equipment that is commonly used for sampling liquid and solid wastes, and their limitations. They contain more than one type of equipment for some types of waste materials but are not intended to include all possible equipment or devices.

8.12.1 Other factors that will guide you in making the final choice follow in Section 13.

9. Preparation of Sampling Equipment

9.1 Damaged sampling equipment can affect the sample, for example, dull cutting edges or chipped glass parts. It may also be a safety hazard for the worker (see Fig. 4).

9.2 Cleaning and decontamination procedures should be identified in the plan (see Practice D5088).

9.3 Check the workplan for preservatives, cooling/refrigeration, holding times, type and size of sample container, packaging, and shipping requirements. If the samples are going

to be analyzed for volatile organic compounds, such as gasoline, special bottles must be used.

9.4 If the samples are going to be analyzed for trace amounts of volatile organic compounds, such as solvents, plan to fill and seal the special sample bottles required for this analysis first, before filling the other sample containers.

9.5 Personal safety equipment will vary depending on the hazards associated with the task. It must comply with the health and safety requirements of the organization that employs you.

9.5.1 Basic safety equipment includes:

- 9.5.1.1 Safety glasses,
- 9.5.1.2 Synthetic rubber gloves,
- 9.5.1.3 Safety shoes or boots, and
- 9.5.1.4 Protective clothing.

9.5.2 More hazardous situations may require equipment such as:

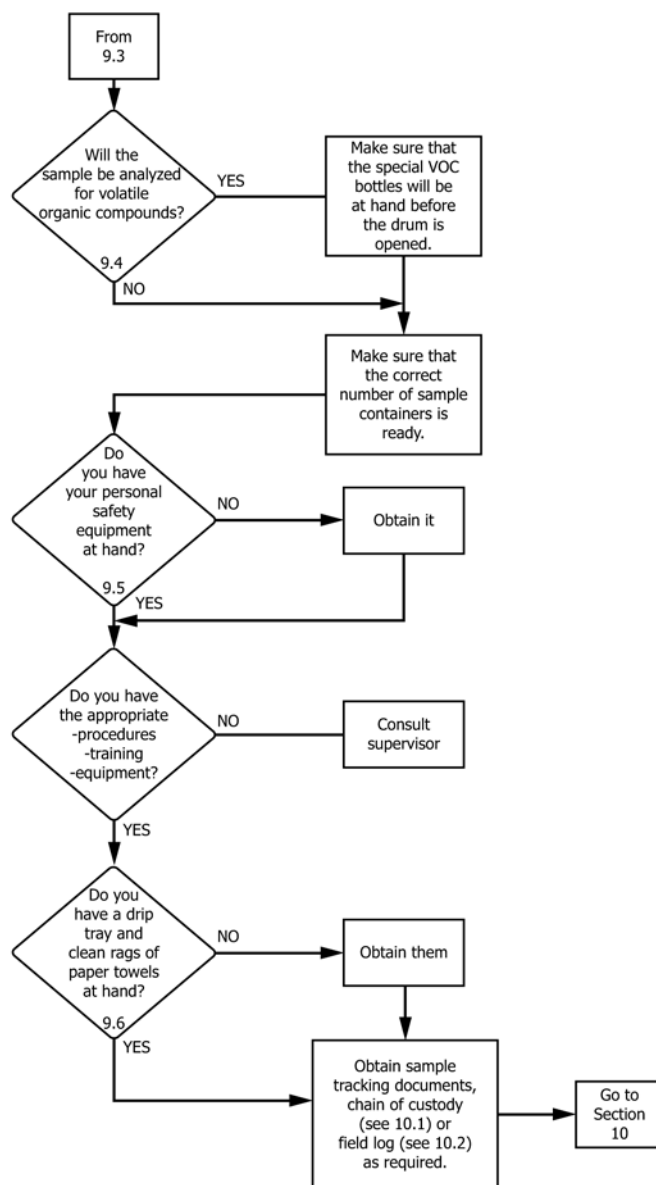

NOTE 1—This flow chart should be used with Sections 9.4 to 10.2 in the text.

FIG. 4 Preparation of Sampling Equipment (continued)

- 9.5.2.1 Hard hat,
- 9.5.2.2 Respirators,
- 9.5.2.3 Face shields,
- 9.5.2.4 Chemically-resistant suits,
- 9.5.2.5 Self-contained breathing apparatus, and
- 9.5.2.6 Two way radio communication.

9.5.3 If appropriate, segregate the drums and surrounding area from casual intrusion by using barricades or caution tape.

9.5.4 When sampling inside buildings, ventilation may be desirable.

9.6 Records that associate a sample with a drum are usually required. A field technician’s log and chain of custody forms are commonly used (see Section 10).

10. Report

10.1 Chain of Custody Forms:

10.1.1 The purpose of chain of custody forms is to show that the samples analyzed are the same ones that were collected. They are required for regulatory purposes. They serve as legal documentation that sample custody was maintained. When complete, they should show that there were no lapses in accountability. It is not always necessary to use chain of custody procedures but some form of sample tracking is necessary.

10.1.2 A chain of custody form may originate with the laboratory at the time the sample containers are prepared or in the field after the sample has been taken. Each time the samples

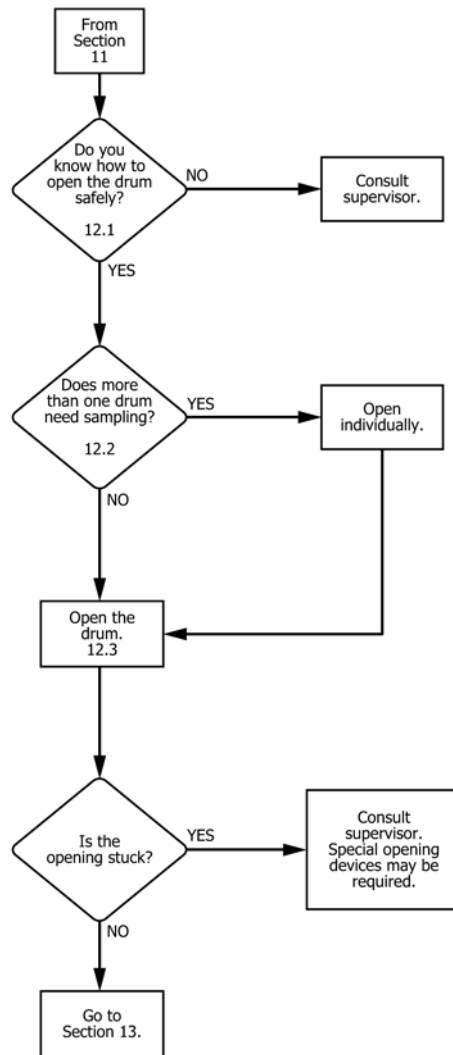

NOTE 1—This flow chart should be used with Sections 12.1 to 12.3 in the text.

FIG. 5 Opening the Drum

change hands, the chain of custody form must be signed. The originator of the chain of custody keeps one copy to confirm that the samples were passed on and to whom; they may have been given directly to the laboratory or to a courier. The completed form, with all remaining copies intact, must accompany the samples. Copies of the custody forms will be returned to the parties involved, to confirm that the samples have been received at the laboratory.

10.1.3 Sometimes security seals are placed over the caps of empty, clean sample containers and signed off by the laboratory. The person sampling must break these seals in order to fill the containers. Security seals may also be attached after the sample container has been filled. The date, time of sampling and name of the person sampling are then written on the seals. The purpose of the seal is to indicate possible tampering with the sample. (See Guide D4840.) Other tamper-evident methods, such as tamper-evident bags, may be utilized also.

10.2 Field Log:

10.2.1 Ideally, a field log is maintained in a bound book with printed page numbers. Information should be recorded in

indelible ink. Errors should be crossed out with a single line and initialed/dated. Items normally documented include:

- 10.2.1.1 Type of waste, for example, sludge, wastewater,
- 10.2.1.2 Suspected waste composition, including concentrations, if known,
- 10.2.1.3 Number and volume of sample taken,
- 10.2.1.4 Description of sampling point and sampling method,
- 10.2.1.5 Date, time and location of each sample collected,
- 10.2.1.6 Preservatives used, if any (including ice),
- 10.2.1.7 Analytical parameters to be measured,
- 10.2.1.8 Unique sample identification number,
- 10.2.1.9 Types and number of QC samples,
- 10.2.1.10 Equipment used to obtain samples,
- 10.2.1.11 Field observations; unusual events that may have an impact on the sample(s),
- 10.2.1.12 Markings, stencils, and label information on drum,
- 10.2.1.13 Field measurements and results (for example, pH),

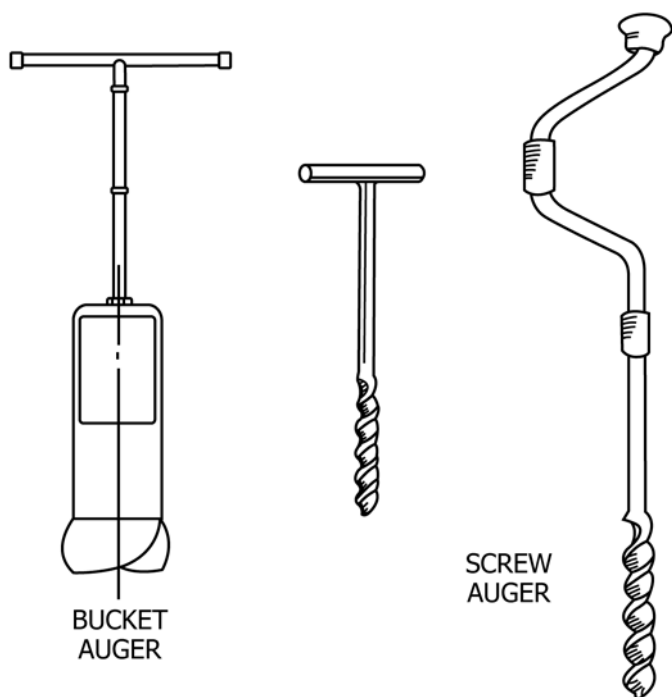

FIG. 6 Augers

- 10.2.1.14 Signature of person who took the sample, and
- 10.2.1.15 Names of personnel on sampling team.
- 10.2.2 Additional information may be specified in the workplan. (See Practice D5283.)

10.3 *Sample Labels or Tags, or Both:*

- 10.3.1 Information written on sample container labels may include:
 - 10.3.1.1 Sample ID number,
 - 10.3.1.2 Name of person sampling,
 - 10.3.1.3 Initials or signature of person sampling,
 - 10.3.1.4 Date and time of sampling,
 - 10.3.1.5 Sample location,
 - 10.3.1.6 Sampling information (for example, grab or composite),
 - 10.3.1.7 Preservative/preservation required,
 - 10.3.1.8 Special instructions, and
 - 10.3.1.9 Analysis request.
- 10.3.2 Labels may be put on containers before or after sampling. Consult the workplan.

11. Mixing of Liquids, With or Without Solids, Before Sampling

11.1 Thorough mixing of the material prior to sampling is not always possible or necessary. When deciding whether or not to mix, the following points should be considered.

11.1.1 Does the plan require that the materials in the drum be mixed before sampling? Or does the plan prohibit mixing?

11.1.2 If the material is hazardous and mixing it will create a safety problem, such as allowing acidic fumes to escape, do not mix.

11.1.3 The results of the laboratory tests that the sample will undergo may be influenced by mixing. Examples are (1) if the material contains volatile compounds that could be lost during

the mixing process, do not mix, and (2) if a thin layer of solids on the bottom of the drum contain the metals of concern, mixing is necessary.

11.1.4 If the sampling plan has been designed such that several smaller samples will be taken from various locations and combined into one sample, or if numerous discrete samples will be taken, there is less need to mix the material because the sampling plan has addressed variations in the material.

11.1.5 Sampling equipment designed to take a profile of the waste (for example, COLIWASA) does not require the material to be mixed first.

11.1.6 If the drum was moved or agitated before sampling, samples may be taken only when the contents of the drum are either completely settled or are thoroughly mixed.

11.2 If the materials are going to be mixed, do so in such a way that no contamination is introduced to the drum and sample container and no material is lost. It should be performed in a safe manner (for example, don't roll a 200-L drum back and forth with the hope of mixing the contents—it rarely works and the potential for injury is high).

11.3 A recirculating pump can be used to mix a liquid material in, for example, a 200-L drum.

12. Opening the Drum

12.1 The bung, ring or other fastening device that secures the lid should be removed slowly, allowing any pressure or vacuum to equalize (see Fig. 5).

12.1.1 Pails with “snap-on” lids may be difficult to open. Be careful to avoid splashing the contents when opening them.

12.1.2 If the top of the drum is dished inward (dimpled), solid or liquid materials, or both, may have accumulated there. The lid may “pop” when equalizing pressure, spraying the person sampling with any material that has accumulated on the lid. To avoid this, material on top of the drum must be removed before opening the drum.

12.1.3 If the top of the drum is bulging, opening it too quickly may cause the top to fly upward, possibly injuring the person sampling.

12.1.4 If there is evidence of a chemical reaction or sudden pressure buildup (for example, fumes escaping, heat build-up, rocking drum), the person sampling should leave the area immediately and decide if remote drum opening equipment should be used. This is also true for crystallization noted on the bung hole or removable drum lid.

12.1.5 Drums should be grounded before being opened, if grounding is required, and non-sparking drum opening tools must be used to open drum if volatile materials may be present.

12.2 Drums should be opened, sampled and closed individually to minimize possible volatilization of organic compounds and also exposure of the person sampling to the material(s).

12.3 When opening a drum with a bung, if the lid is dimpled or bulging, loosen the smaller bung first. This will make it easier to control the release of pressure. Also, cover a manual bung wrench with a cloth to control potential liquid spray. Then remove the large bung.

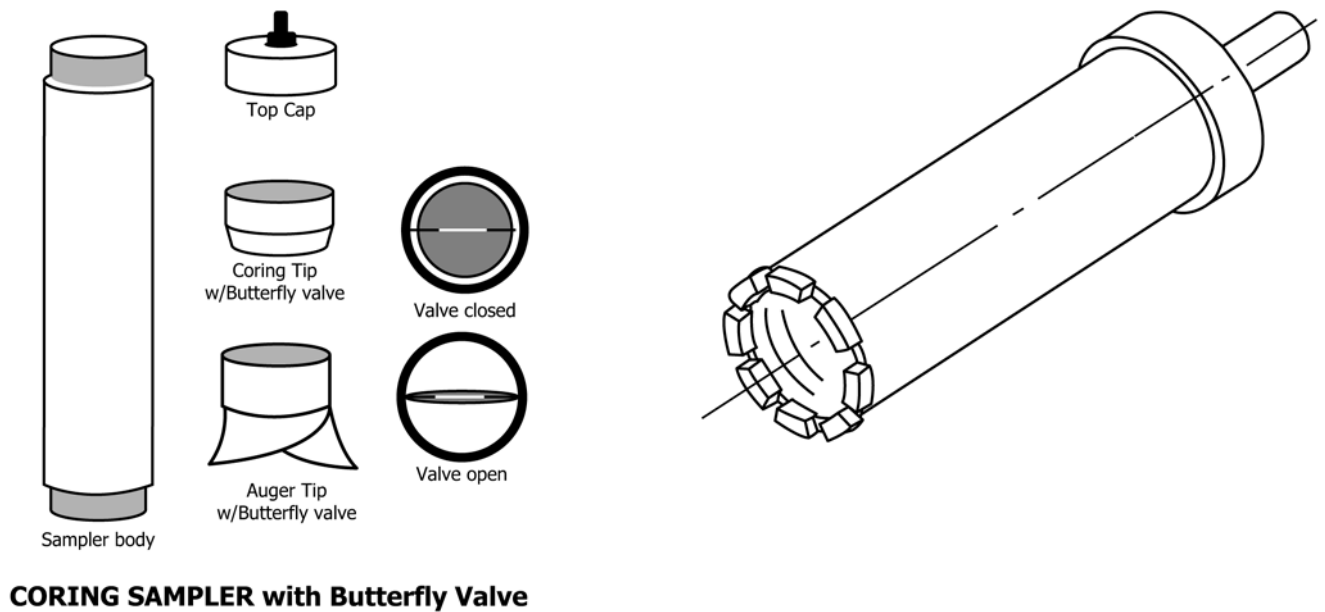
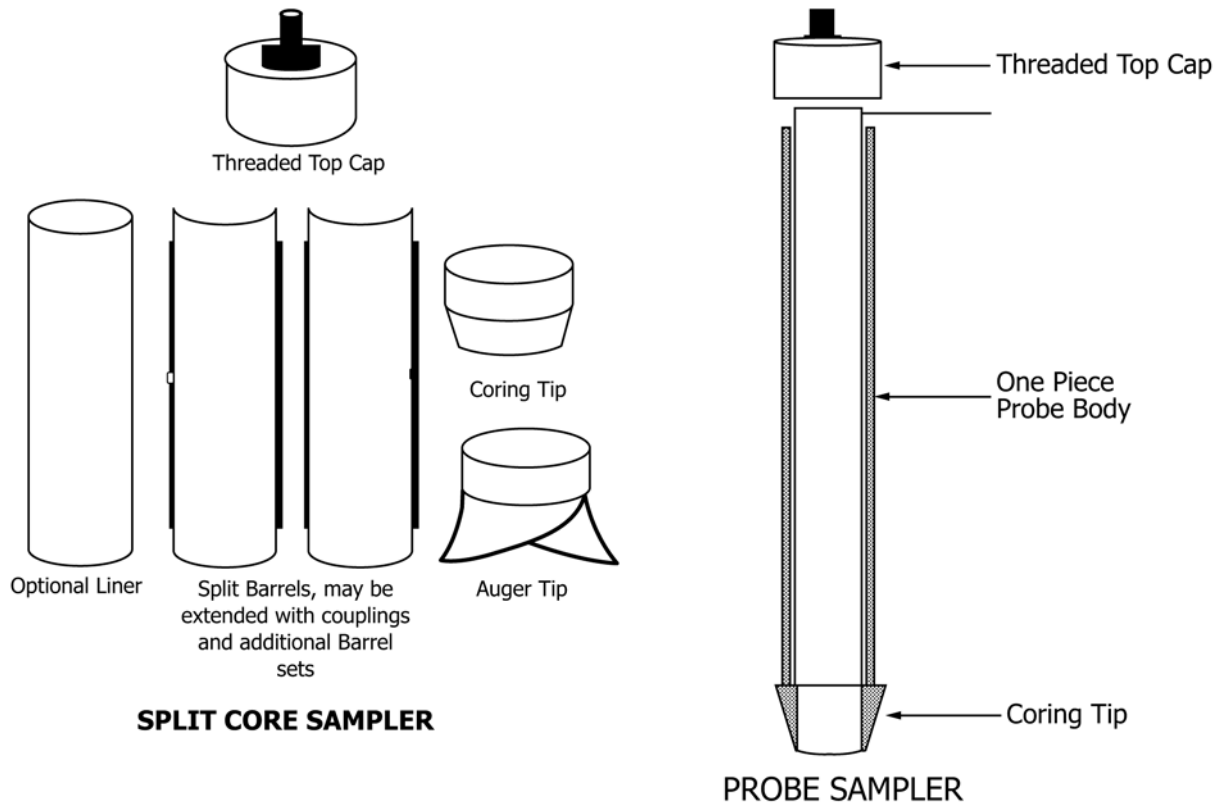

FIG. 7 Coring Devices

12.3.1 When opening a drum with a removable lid, slowly loosen the bolt with a manual wrench or an air impact wrench. If the lid is dimpled or bulging, allow the pressure to equalize before completely loosening the bolt. Remove the bolt, the ring and the lid.

12.3.2 When opening a pail with a removable lid (side-lever lock ring), slowly release the lever. If the lid is dimpled or bulging, allow the pressure to equalize before loosening the ring sufficiently for lid removal.

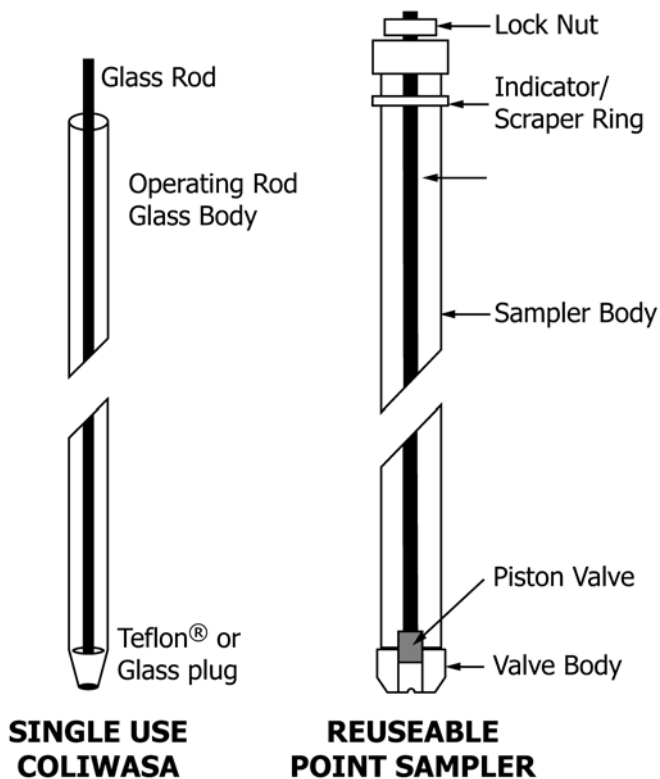

FIG. 8 COLIWASA

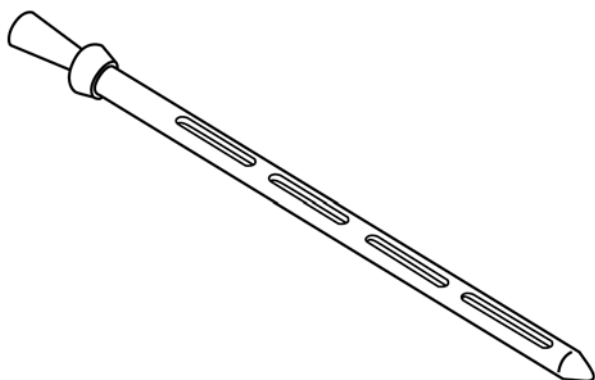

FIG. 9 Concentric Tube Thief

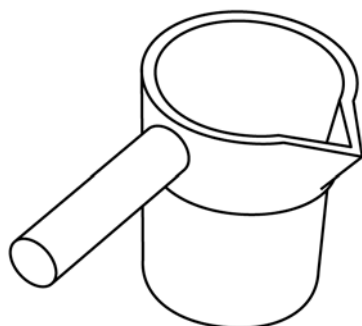

FIG. 10 Dipper

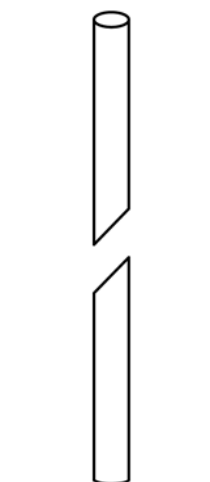

FIG. 11 Drum Thief

13. How to Use the Equipment

13.1 Auger:

13.1.1 *Description*—An auger samples hard or packed solid materials or soil. It consists of sharpened spiral blades attached to a hard metal central shaft (see Fig. 6).

13.1.2 Steps to Extract a Sample:

13.1.2.1 Collect the sample by rotating the handle of the auger in a clockwise direction while applying slight downwards pressure.

13.1.2.2 Continue turning until the desired depth has been reached. Pull the auger straight up out of the material.

13.1.2.3 Remove the material that has been withdrawn in the screw thread of the auger, and place it in the container. This is usually done with the auger placed on a clean plastic sheet.

13.1.2.4 Transfer the material to the appropriate container for analysis.

13.2 Coring Devices:

13.2.1 *Description*—A coring device samples hard or packed solid waste or soil (see Fig. 7). They are available with coring tips on all types and auger tips on some. The coring tip cuts a sample a little smaller than the inside diameter of the sampler body. The sampler is connected to a metal extension that allows the sampler to be driven into the material either with downward hand pressure or with a slide hammer. When a sampler with an auger tip is used, the sampler is rotated into the material being sampled, using the extension and attached cross handle. The coring sampler with butterfly valve is designed for use in sludges and liquid-saturated materials. The valve closes and prevents loss of sludges and semi-solids when raised from the sampling medium.

13.2.1.1 A stainless steel or plastic liner may be inserted into the hollow tube prior to use.

NOTE 1—Plastic liners may be inappropriate if the sample will be analyzed for organics.

13.2.2 Steps to Extract a Sample:

13.2.2.1 Place the coring device on the surface of the material to be sampled.

13.2.2.2 Twist the device slightly, and apply downward pressure to begin penetration. This steadies the device for the next step.

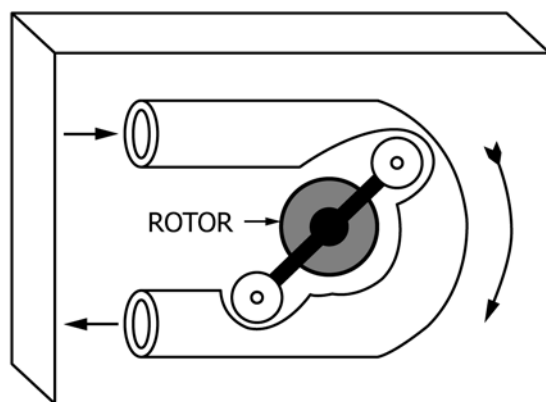

PERISTALTIC PUMP

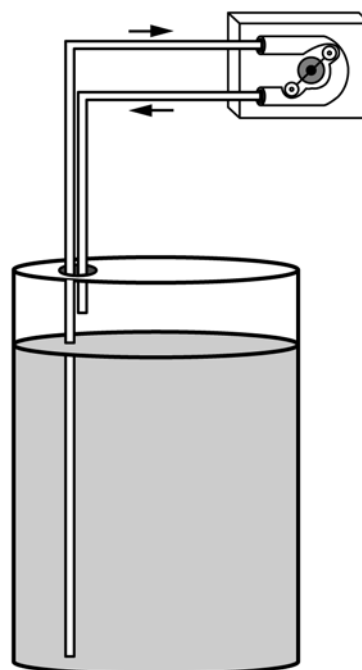

FIG. 12 Peristaltic Pumps

13.2.2.3 Use the slide hammer when manual pressure is no longer effective to drive the coring device into the material, until the desired depth is reached. Always mark the extension with a reference point equivalent to when the tip is near the bottom of the container. Take care not to overdrive the sampler to prevent damage to the bottom of the drum or container.

13.2.2.4 Twist the device again to break the core off from the bottom.

13.2.2.5 Pull the coring device straight up out of the material.

13.2.2.6 Open the device. Either cap off the liner, if present, or remove the material and place it into the appropriate sample container for analysis. This is usually done with the coring device placed on a clean plastic sheet.

13.3 Composite Liquid Waste Sampler (COLIWASA):

13.3.1 *Description*—COLIWASAs are available commercially with different types of stoppers and mechanisms, but they all operate using the same principle (see Fig. 8). They can be constructed of materials such as polyvinyl chloride (PVC), glass, metal or polytetrafluoroethylene (PTFE). They usually consist of two sections. The outer section is a sleeve that may be tapered at the end. The inner section is a rod with some type of stopper on the end. When the inner section is fitted inside the outer section, a seal is formed, and the unit is locked. There are variations in the mechanisms of opening and closing COLIWASAs. They can be used to obtain samples from specific depths. Sometimes it is necessary to enter the drum a number of times with this sampler to obtain enough sample to meet the needs of the analytical laboratory.

13.3.2 Steps to Extract a Sample:

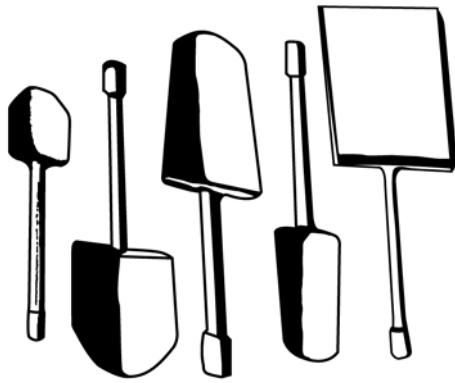

Stainless Steel Scoops
 sizes #2,3,6,8,12 denote ozs.

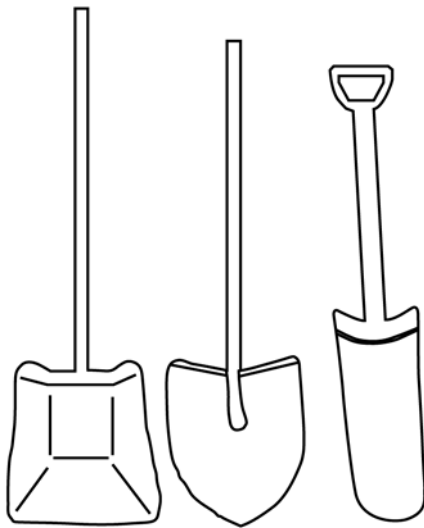

Stainless Steel Shovels

FIG. 13 Scoop, Spoon, Trowel

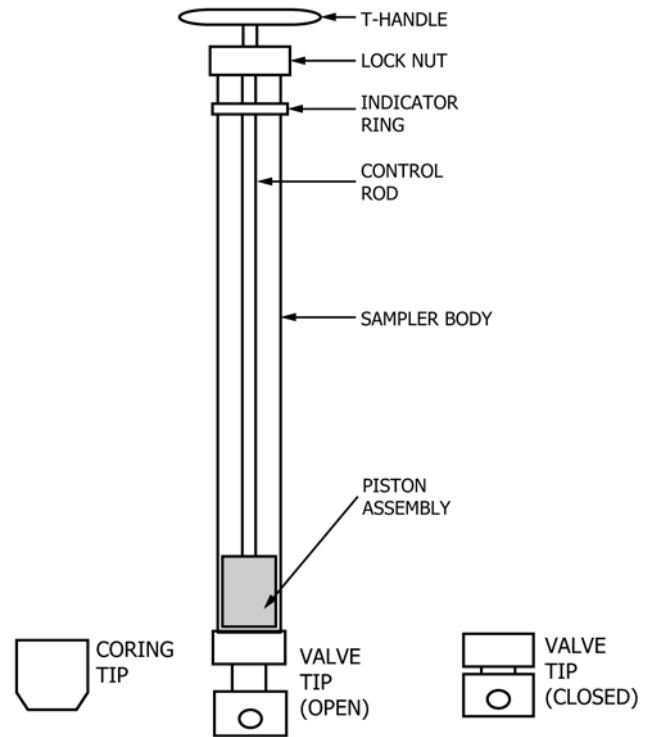

FIG. 14 Syringe Sampler

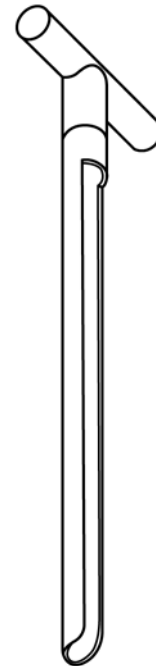

FIG. 15 Trier

slotted concentric tubes, usually made of stainless steel or brass. The outer tube has a conical pointed tip that permits the sampler to penetrate the material being sampled. The inner tube is rotated to open and close the sampler.

13.4.2 *Steps to Extract a Sample:*

13.4.2.1 Ensure the sampler is in the closed position to start.

13.4.2.2 Insert the sampler into the material so that the largest cross-section of material will be sampled.

13.3.2.1 Place the COLIWASA in the open position.

13.3.2.2 Lower the COLIWASA slowly into the liquid, keeping it vertical at all times, making sure that the level of the liquid inside and outside the sampler tube remain about the same.

13.3.2.3 When the unit touches the bottom of the container, or has reached the desired depth, close the COLIWASA.

13.3.2.4 Remove the sampler from the liquid with one hand while wiping the outer tube with a disposable cloth or rag with the other hand.

13.3.2.5 Open the COLIWASA over the sample container. The complete column of liquid should be placed into the sample container (e.g., do not release portions of liquid from a COLIWASA column of liquid into multiple sample containers).

13.4 *Concentric Tube Thief:*

13.4.1 *Description*—A concentric tube thief (grain sampler) (see Fig. 9) is used to sample free-flowing, dry granules or powdery materials whose particle diameter is less than one-third the width of the slots in the sampler. It consists of two

TABLE 1 Sampling Equipment Limitations

| Sampling Equipment | Variables | Limitations |
|---|-------------------------------------|---|
| Auger (see 13.1) | Cross-contamination General use | Will disturb matrix during sampling. May not reach all layers of the drum if the contents are multi-layered, and so may bias results. |
| COLIWASA (see 13.3) | Stability of drum Angle of use | Equipment may penetrate the bottom of the drum. The angle of descent must be perpendicular to the surface of the material, or the resulting sample may be biased. |
| | Bottom layer | This sampler cannot be used to sample the material in the bottom of the drum. The actual depth of unsampled material varies depending on the COLIWASA used. |
| | Speed of use | If the speed of descent is too fast, the materials inside the tube will not be at the same level as those outside the tube, causing incorrect proportions in the sample. |
| | Speed of use | If the speed of descent is too fast, the layers of multi-layered materials will be disturbed. |
| Dipper (see 13.5) | General use | This sampler is used to grab materials from the surface of a drum, so the resulting sample may be biased. |
| Drum Thief (see 13.6) | Material of sampler Angle of use | If sampler is made of glass, chips or cracks can cause an imperfect seal. The angle of descent must be perpendicular to the surface of the material, or the resulting sample may be biased. |
| | Bottom layer | May lose the bottom layers of material during sampling. The depth of the unsampled material varies with density, surface tension and viscosity of the material being sampled, for example, chlorosolvents, such as chloroform, are difficult to sample whereas water is easy. |
| | Consistency | With viscous materials, more material may end up on the outside of the tube than inside it. |
| | Speed of use | If the speed of descent is too fast, the liquid in the tube will not be at the same level as the liquid outside the tube, causing incorrect proportions in the sample. |
| Concentric Tube Thief (see 13.4) | General use | Can be used only for dry, powdery or granular materials. |
| | Particle size | Excludes certain particle sizes, including those that are over one third the slot width of the sampler. |
| Impact Devices Chipper Hammer Chisel | General use | Can be used only with consolidated solids. |
| | General use | These samplers are used to break off chunks of a consolidated solid from the surface only and so may bias resulting sample. |
| Push Coring Devices Split Barrel (see 13.2) | Media | Materials to be sampled must be moist enough to remain in the device. |
| Push Coring Devices Thin-walled | Stability of drum Media | Equipment may penetrate the bottom of the drum. Tube will be damaged if pushed past the point of refusal. |
| | Consistency | Retrieving an intact core is difficult if the material is not sticky. Cannot be used in coarse, rocky materials. |
| | Stability of drum | Care required when used at bottom of drum to prevent penetration, particularly when auger tip is used. |
| Pump, Peristaltic (see 13.7) | Particle size | It is critical to realize that this sampler pumps suspendable solids, not heavy sludge. An example would be rainwater with suspended solids. |
| Rotating Core Device Concrete Corer (see 13.2) | General use | Used to sample consolidated solids only. May not get all the layers of a multi-layered drum, so may bias the sample. |
| | Power source | This device must be attached to a power drill. |
| Scissors and Tongs | General use | Used to cut pieces of unconsolidated solids within a drum, for example, to cut dark spots off gloves or rags to look for "worst case" areas. May not provide sample representative of all "parts" of the drum. |
| Scoop, Spoon and Trowel (see 13.8) | Particle size | May exclude certain particle sizes, especially large aggregates. |
| Syringe Sampler (see 13.9) | General use | Used to grab material from the top of a drum and so may bias results. |
| | Speed of use Angle of use | The sampler must be lowered slowly into the drum to minimize mixing. The angle of descent should be perpendicular to the surface of the material to be sampled. |
| | Media | Material to be sampled must be viscous enough to remain in the device when the coring tip is used. The valve tip cannot be used with viscous materials. |
| Trier (see 13.10) | Consistency | Material will not be held in place during removal if it is not sticky. |
| | Cross-contamination | There may be some contamination of the material within the bounds of the trier by the material outside the bounds. |

13.4.2.3 Open the unit by rotating the inner tube.

13.4.2.4 Jiggle the sample to encourage the material to enter the sampler.

13.4.2.5 Close the unit by rotating the inner tube and remove the sampler from the material.

13.4.2.6 Lay the sampler on a clean surface with the slots facing upwards. This is usually done on a clean plastic sheet.

NOTE 2—Some types of grain samplers allow the two tubes to separate

from each other, allowing for easier removal of the sample, or for the sample to be poured out of the top of the sampler directly into the sample container.

13.4.2.7 Remove the sample and place in appropriate container for analysis.

13.5 Dipper:

13.5.1 *Description*—A dipper samples single phased liquids (see Fig. 10). It consists of a glass, metal or plastic beaker

TABLE 2 Equipment Selection

| Equipment or Device | ASTM Standard | One Liquid Layer | Two or More Layers of Liquids | Both Liquid and Solid Layers | Consolidated Solids ^A | Unconsolidated Solids ^A | Sludge ^A | See Paragraph |
|----------------------------|----------------|------------------|-------------------------------|------------------------------|----------------------------------|------------------------------------|---------------------|---------------|
| Column Number | | I | II | III | IV | V | VI | |
| Auger | D4700 D1452 | B | — | — | X ^C | X | — | 13.1 |
| Chipper, Hammer and Chisel | | — | — | — | X | N ^D | — | — |
| COLIWASA | D5495 | X | X | N | — | — | N | 13.3 |
| Concentric Tube Thief | | — | — | — | — | X | — | 13.4 |
| Dipper | D5358 | X | — | N | — | — | N | 13.5 |
| Drum Thief | | X | X | X | — | — | X | 13.6 |
| Peristaltic Pump | D4448 | X | X | N | — | — | N | 13.7 |
| Push Coring Devices: | D1586 D1587 | | | | | | | |
| Split Barrel | D4700 | — | — | — | N | X | N | 13.2 |
| Thin-walled Tube | D4823 | — | — | — | N | X | — | |
| Butterfly Valve | | — | — | N | — | N | X | |
| Rotating Coring Device | C783 D2113 | — | — | — | X | — | — | 13.2 |
| Scissors and Tongs | | — | — | — | — | X | — | — |
| Scoop, Spoon and Trowel | | N | — | — | — | X | N | 13.8 |
| Syringe Sampler | | N | N | X | — | — | X | 13.9 |
| Trier | D5451 | — | — | — | — | N | N | 13.10 |

^A The suitability of the sampling device depends on the consistency of the material to be sampled.

^B Equipment is probably unsuitable.

^C Equipment may usually be used with this type of waste.

^D Not equipment of choice but may be used at discretion of supervisor.

clamped to the end of a two- or three-piece telescoping aluminum or fiberglass pole that serves as a handle. Samples are taken at, or just below, the surface.

13.5.2 Steps to Extract a Sample:

13.5.2.1 Submerge the dipper into the material slowly, to cause minimum surface disturbance.

13.5.2.2 Allow the beaker to fill and slowly bring it to the surface.

13.5.2.3 Slowly pour the contents into the sample container.

13.6 Drum Thief:

13.6.1 *Description*—A drum thief is used to sample liquids (see Fig. 11). It consists of an open-ended tube, usually made of glass or stainless steel. Narrow bore tubes can be used for liquids with low surface tension, such as chlorinated solvents, and wider bore tubes can be used to sample sludges.

13.6.2 Steps to Extract a Sample:

13.6.2.1 Slowly lower the thief into the liquid, keeping it vertical at all times, until it hits touches the bottom of the container.

13.6.2.2 Place your thumb, or a stopper, over the top to create a vacuum. This will hold the sample in the tube while it is removed from the container. Use caution as this form of vacuum does not always hold the sample in place. If the material releases prematurely from the bottom of the thief, this equipment is unsuitable.

13.6.2.3 Place the thief over the appropriate container for analysis and release the vacuum by removing your thumb or the stopper.

NOTE 3—If it is important to have a regulatory-recognized, representative sample of the liquid contents of a drum, then a COLIWASA may need to be used.

13.7 Peristaltic Pumps:

13.7.1 *Description*—Peristaltic pumps (see Fig. 12), in which a cam rotates against flexible tubing, thereby moving the

material inside the tube through it, are used for sampling liquids and slurries (see Guide D4448). Hosing should be compatible with the material being sampled. General-use plastic tubing works well for low hazard situations where the sample is water-based, contains few or no organic constituents, and will not be analyzed for organics. High hazard materials and situations where organic compounds are present, and which may be analyzed, should be sampled using fluorocarbon resin tubing.

13.7.2 Steps to Extract a Sample:

13.7.2.1 Place the end of the inlet tubing within the container at the depth from which the sample will be extracted.

13.7.2.2 Place the end of the outlet tubing within the container and turn on the pump.

13.7.2.3 Once the sample is adequately mixed, turn off the pump and place the end of the outlet tubing into the appropriate container for analysis.

13.7.2.4 Turn on the pump and collect the sample into the container.

13.8 Scoop, Spoon, Trowel:

13.8.1 *Description*—Scoops, spoons and trowels (see Fig. 13) are used to sample a wide variety of materials, including sludge, soil, powder or hard solid waste.

13.8.2 Steps to Extract a Sample:

13.8.2.1 Collect sample from the appropriate depth by digging and rotating the sampler. Trowels may not be suitable for collecting solids from depths, or if digging is limited by the sides of the container.

13.8.2.2 Transfer the material to the appropriate container for analysis.

13.9 Syringe Sampler:

13.9.1 *Description*—A syringe sampler (see Fig. 14) is used to sample thick liquids, sludges and tar-like substances. It can also draw samples when only a small amount remains at the

bottom of a drum or tank. Syringe samplers are available commercially. They usually include a manually operated piston assembly consisting of a T-handle, lock nut, control rod (polytetrafluoroethylene-covered aluminum rod facilitates operation of the piston), piston assembly, sampling tube and two tips for the lower end, one with a closeable valve and one with a coring tip.

13.9.2 *Steps to Extract a Sample:*

13.9.2.1 Make sure that the top and bottom fittings are secured to the sampling tube and the valve tip, if used, is open. The piston assembly should be at the lower end of the sampler.

13.9.2.2 Slowly lower the syringe sampler into the drum or tank until it contacts the surface of the material to be sampled.

13.9.2.3 To collect a point sample, hold the sampler body, loosen the lock nut and gradually raise the T-handle to draw the sample into the sampler.

13.9.2.4 To collect a core sample with the coring tip, loosen the lock nut, hold the T-handle and slowly push the sampler body down into the material.

13.9.2.5 When the desired sample is obtained, hand tighten the lock nut to secure the piston rod.

13.9.2.6 Remove the sampler from the drum with one hand while wiping the sampler body with a disposable cloth or rag with the other hand.

13.9.2.7 Hold the syringe sampler over the sample container; open the valve tip, if fitted and closed.

13.9.2.8 Loosen the lock nut and force the sample out of the sampler by depressing the piston rod.

13.10 *Trier:*

13.10.1 *Description*—A trier is used to sample moist or sticky solids with a particle diameter less than one-half the diameter of the trier. It consists of a handle and a tube cut in half lengthwise, with a sharpened tip that allows the sampler to cut into sticky materials and loosen solids.

13.10.2 *Steps to Extract a Sample:*

13.10.2.1 Hold the trier either horizontally or with the handle end tilted slightly downwards.

13.10.2.2 Insert the trier into the material to be sampled, at this angle.

13.10.2.3 Cut a core of the material by rotating the trier once or twice.

13.10.2.4 Stop the rotation with the open face pointing upwards.

13.10.2.5 Slowly remove the trier and empty the contents into the appropriate container for analysis.

14. Keywords

14.1 drum; sampling; waste

ASTM International takes no position respecting the validity of any patent rights asserted in connection with any item mentioned in this standard. Users of this standard are expressly advised that determination of the validity of any such patent rights, and the risk of infringement of such rights, are entirely their own responsibility.

This standard is subject to revision at any time by the responsible technical committee and must be reviewed every five years and if not revised, either reapproved or withdrawn. Your comments are invited either for revision of this standard or for additional standards and should be addressed to ASTM International Headquarters. Your comments will receive careful consideration at a meeting of the responsible technical committee, which you may attend. If you feel that your comments have not received a fair hearing you should make your views known to the ASTM Committee on Standards, at the address shown below.

This standard is copyrighted by ASTM International, 100 Barr Harbor Drive, PO Box C700, West Conshohocken, PA 19428-2959, United States. Individual reprints (single or multiple copies) of this standard may be obtained by contacting ASTM at the above address or at 610-832-9585 (phone), 610-832-9555 (fax), or service@astm.org (e-mail); or through the ASTM website (www.astm.org). Permission rights to photocopy the standard may also be secured from the ASTM website (www.astm.org/COPYRIGHT/).