



Standard Guide for Displaying the Results of Chemical Analyses of Ground Water for Major Ions and Trace Elements—Trilinear Diagrams for Two or More Analyses¹

This standard is issued under the fixed designation D 5754; the number immediately following the designation indicates the year of original adoption or, in the case of revision, the year of last revision. A number in parentheses indicates the year of last reapproval. A superscript epsilon (ϵ) indicates an editorial change since the last revision or reapproval.

1. Scope

1.1 This guide describes the category of water analysis diagrams that use two-dimensional trilinear graphs as a technique for displaying the common chemical components from two or more complete analyses of natural ground water (see Section 3) on a single diagram. This category includes not only trilinear-shaped diagrams but also the diamond- or parallelogram-, rectangular-, or square-shaped graphs that have trilinear subdivisions.

1.2 This guide is the first of several documents to inform professionals in the field of hydrology with the traditional graphical methods available to display ground water chemistry.

NOTE 1—Subsequent guides are planned that will describe the other categories of diagrams that have been developed to display ground water chemical analyses.

(1) A guide for diagrams based on data analytical calculations will include those categories of water analysis graphs in which one analysis is plotted on each diagram (for example, the pattern, bar, radial, and circle diagrams).

(2) A guide for statistical diagrams will include those categories of water analysis graphs in which multiple analyses are analyzed statistically and the results plotted on the diagram (for example, the box, etc.).

1.3 Numerous methods have been developed to display the ions dissolved in water on trilinear diagrams. These diagrams are valuable as a means of interpreting the physical and chemical mechanisms controlling the composition of water.

1.4 The most commonly used trilinear methods were developed by Hill (1-3),² Langelier and Ludwig (4), Piper (5, 6), and Durov (7-13). These techniques are proven systems for interpreting the origin of the ions in natural ground water and for facilitating the comparison of results from a large number of analyses.

NOTE 2—The use of trade names in this guide is for identification purposes only and does not constitute endorsement by ASTM.

1.5 *This guide offers an organized collection of information or a series of options and does not recommend a specific*

course of action. This document cannot replace education or experience and should be used in conjunction with professional judgment. Not all aspects of this guide may be applicable in all circumstances. This ASTM standard is not intended to represent or replace the standard of care by which the adequacy of a given professional service must be judged, nor should this document be applied without consideration of a project's many unique aspects. The word "Standard" in the title of this document means only that the document has been approved through the ASTM consensus process.

2. Referenced Documents

2.1 ASTM Standards:

D 596 Practice for Reporting Results of Analysis of Water³

D 653 Terminology Relating to Soil, Rock, and Contained Fluids⁴

D 1129 Terminology Relating to Water³

3. Terminology

3.1 *Definitions*—Except as listed as follows, all definitions are in accordance with Terminology D 653.

3.1.1 *anion*—an ion that moves or would move toward an anode; the term is thus nearly always synonymous with *negative ion*.

3.1.2 *cation*—an ion that moves or would move toward a cathode; the term is thus nearly always synonymous with *positive ion*.

3.1.3 *equivalent per million (epm)*—for water chemistry, an equivalent weight unit expressed in English terms and also expressed as milligram-equivalent per kilogram. When the concentration of an ion, expressed in parts per million (ppm), is multiplied by the equivalent weight (combining weight) factor (see *equivalent weight factor*) of that ion, the result is expressed in epm.

3.1.3.1 Discussion—

(1) For a completely determined chemical analysis of a water sample, the total epm value of the cations will equal the total epm value of the anions (chemically balanced). The plotted values on the water analysis diagrams described in this guide can be expressed in percentages of the total epm (although all

¹ This guide is under the jurisdiction of ASTM Committee D18 on Soil and Rock and is the direct responsibility of Subcommittee D18.21 on Ground Water and Vadose Zone Investigations.

Current edition approved August 15, 1995. Published September 1995.

² The boldface numbers in parentheses refer to the list of references at the end of this guide.

³ *Annual Book of ASTM Standards*, Vol 11.01.

⁴ *Annual Book of ASTM Standards*, Vol 04.08.

illustrations are in milliequivalent per litre) of the cations and anions of each water analysis. In order to use the diagrams, analyses must therefore be converted from ppm to epm by multiplying each ion by its equivalent weight factor and determining the percent of each ion of the total cation or anion.

(2) For a completely determined chemical analysis of a water sample, the total value of the cations will equal the total value of the anions (chemically balanced). The plotted values on the water analysis diagrams described in this guide are expressed in percentages of the total milliequivalent per litre (meq/L) of the cations and anions of each water analysis. In order to use the diagrams, analyses must therefore be converted from milligram per litre (mg/L) to meq/L by multiplying each ion by its equivalent weight factor and determining the percent of each ion of the total cation or anion.

3.1.4 *equivalent weight factor*—also called the combining weight factor and reaction coefficient, this is used for converting chemical constituents expressed in ppm to epm and mg/L to meq/L (see *equivalent per million* and *milliequivalent per litre*). To determine the equivalent weight factor, divide the formula weight of the solute component into the valence of the solute component:

$$(\text{equivalent weight factor}) = \frac{(\text{valence solute component})}{(\text{formula weight solute component})} \quad (1)$$

To then determine the equivalent weight (meq/L) of the solute component, multiply the mg/L value of the solute component times the equivalent weight factor, as follows;

$$(\text{meq/L solute component}) = (\text{mg/L solute component}) \times (\text{equivalent weight factor}) \quad (2)$$

For example, the formula weight of Ca^{2+} is 40.10 and the ionic charge is 2 (as shown by the 2 +), and the equivalent weight value is computed to be 0.9975 meq/L for a value of 20 mg/L Ca:

$$(0.9975 \text{ meq/L Ca}) = (20 \text{ mg/L Ca}) \times \frac{(2)}{(40.10)} \quad (3)$$

3.1.4.1 *Discussion*—Many general geochemistry publications (14) and water encyclopedias (15) have a complete table of equivalent weight factors for the ions found in natural ground water.

3.1.5 *grains per U.S. gallon (gpg)*—for water chemistry, a weight-per-volume unit; also, for irrigation water, it can be expressed in tons per acre-foot (ton/acre-ft). The weight (grains or tons) of solute within the volume (gallon or acre-foot) of solution. A grain is commonly used to express the hardness of water, where one grain is equal to 17.12 ppm CaCO_3 .

3.1.6 *hydrochemical facies*—as described by Back (16), the diagnostic chemical character of water solutions in aquifers. These facies reflect the effects of chemical processes in the lithologic environment and the contained ground water flow patterns. Freeze and Cherry (17) state, “Hydrochemical facies are distinct zones that have cation and anion concentrations describable within defined composition categories.” The definition of a composition category is commonly based on subdivisions of the trilinear diagram, as described by Back (16, 18).

3.1.7 *milliequivalent per litre (meq/L)*—for water chemistry, an equivalent weight unit expressed in metric terms and also expressed as milligram-equivalent per litre. The result is expressed in meq/L when the concentration of an ion, expressed in mg/L, is multiplied by the equivalent weight (combining weight) factor (see *equivalent weight factor*) of that ion.

3.1.8 *milligrams per kilogram (mg/kg)*—for water chemistry, a weight-per-weight unit expressed in metric terms. The number of mg of solute (for example, Na) per kg of solution (water). For example, if the total weight of the solution (one million mg/kg) has 99 % solvent and 1 % solute, this is the same as 990 000 mg/kg solution and 10 000 ppm solute in the 1 000 000 mg/kg of solution.

3.1.9 *milligrams per litre (mg/L)*—for water chemistry, a weight-per-volume unit expressed in metric terms. The weight in mg (10^{-3} g) of the solute within the volume (L) of solute and solution. The weight can be also expressed in micrograms (μm) (10^{-6} g). The use of the mg/L unit is the world-wide standard for the analysis and reporting of water chemistry.

3.1.9.1 *Discussion*—The ppm and mg/L values of the constituents in natural ground water are nearly equal (within anticipated analytical errors) until the concentration of the dissolved solids reaches approximately 7000 mg/L. A density correction should be used when computing ppm from mg/L (14) for highly mineralized waters.

3.1.10 *natural ground water*—as defined for this guide, water positioned under the land’s surface that consists of the basic elements, hydrogen and oxygen (H_2O), and numerous major dissolved chemical constituents, such as calcium (Ca), magnesium (Mg), sodium (Na), potassium (K), carbonate (CO_3), bicarbonate (HCO_3), chloride (Cl), and sulfate (SO_4).

3.1.10.1 *Discussion*—

(1) In special cases, other major constituents can include aluminum (Al), boron (B), fluoride (F), iron (Fe), nitrate (NO_3), and phosphorus (PO_4). Minor and trace elements that can occur in natural ground water vary widely, but they can include arsenic (As), copper (Cu), lead (Pb), mercury (Hg), radium (Ra), and zinc (Zn). In addition, natural ground water may contain dissolved gases, such as hydrogen sulfide (H_2S), carbon dioxide (CO_2), oxygen (O_2), methane (CH_4), ammonia (NH_3), argon (Ar), helium (He), and radon (Rn). Neutrally charged mineral species such as silicate (SiO_2), naturally occurring organics such as tannic acids and colloidal materials, and particulates such as bacteria viruses and naturally charged pollen spores.

(2) Most natural ground water is part of the hydrologic cycle, which is the constant circulation of meteoric water as vapor in the atmosphere as a result of evaporation from the earth’s surface (land and ocean), liquid and solid (ice) on and under the land as a result of precipitation from the atmosphere, and liquid returned to the ocean from the land. A very small amount of the ground water may be magmatic water originating from rocks deep within the crust of the earth. Other ground water is connate in that it is trapped in sediments and has not moved actively in the hydrologic cycle for a period measured in geologic time.

(3) While moving through the hydrologic cycle, chemical

elements in the water are exchanged with other ions and dissolved into and precipitated out of the water, depending on reactions with air and other gases, rock minerals, biological agents, hydraulic pressure, and ambient temperature. The chemical composition of natural ground water ranges from that similar to distilled water with a minor amount of dissolved solids to a brines, with at least 100 000 mg/L dissolved solids (19). (Naturally occurring brine has been analyzed with more than 300 000 mg/L dissolved chemical solids.)

3.1.11 *Parts per million (ppm)*—for water chemistry, a dimensionless ratio of unit-of-measurement per unit-of-measurement expressed in English terms. One part per million is equivalent to 1 mg of solute to 1 kg of solution. For example, if the total weight of the solution (1 000 000 ppm) has 99 % solvent and 1 % solute, this is the same as 990 000 ppm solvent and 10 000 ppm solute in the 1 000 000 parts of solution.

3.1.12 *water analysis*—a set of data showing the concentration of chemical ions as analyzed from a water sample. In this guide, it normally includes the common constituents as found in natural ground water (see 3.1.10).

3.1.13 *water analysis diagram*—as used in this guide, a graphical display method for multiple water analyses. This method can be used to assist in scientific interpretation of the occurrence of cations and anions in natural ground water. The method consists of various combinations of triangular-shaped cation and anion diagrams and diamond- or square-shaped integrated cation and anion diagrams. The sides of the diagrams are divided into equal parts (commonly fifty 2 % or ten 10 % segments) for representing the percentage of each of the cations or anions within the total cation or anion concentration (100 %). The plotted positions of the cations and anions on the diagrams offer an indication of the origin of a water sample, chemical composition of the water (hydrochemical facies), and interrelationship of a number of water samples within the studied area.

4. Summary of Guide

4.1 This guide includes descriptions of the water analysis diagrams that graphically display common chemical components of multiple sets of water analyses from natural ground water sources.

4.1.1 The historical development of four of the more commonly used diagrams (1-13) is described in Section 1.

4.1.2 Other less commonly known methods of graphically displaying multiple sets of water analyses are described briefly.

4.2 The minimum required chemical constituents from each water analysis for inclusion on the four more commonly used diagrams are listed.

4.3 The recommended analytical accuracy or chemical balance of the minimum required chemical constituents is defined.

4.4 Calculations required for the preparation of an analysis for plotting on a diagram are described.

4.5 Detailed descriptions and applications for the following more commonly used water analysis diagrams are given:

4.5.1 Hill geochemical pattern diagram,

4.5.2 Langelier and Ludwig water classification diagram,

4.5.3 Piper water analysis diagram, and

4.5.4 Durov water classification diagram.

4.6 Automated procedures (computer-aided graphics) for

basic calculations and the placement of analysis plot symbols onto computer-generated water analysis diagrams are described.

4.7 A list of references is cited and provided for additional information.

4.8 A bibliography (non-referenced documents) is provided for further sources of information.

5. Significance and Use

5.1 Many thousands of water samples are collected each year and the chemical components are determined from natural ground water sources.

5.2 A single analysis can be interpreted easily regarding composition and geochemical type; however, it is difficult to comprehend all of the factors of similarities, interrelationships, and differences when large numbers of analyses are being compared.

5.3 One of the methods of interpreting the implication of these chemical components in the water is by displaying a number of related water analyses graphically on a visually summarizing water analysis diagram.

5.4 The water analysis diagrams described in this guide display the percentages of the individual cation and anion weights of the total cation and anion weights on graphs shaped as triangles, squares, diamonds, and rectangles.

NOTE 3—The concentration of dissolved solids determined for each analysis is not evident by the plotted location. Scaled symbols, usually circles, can represent the amount of dissolved solids for each analysis plotted on the diagrams.

5.5 Classification of the composition of natural ground water is a major use of water analysis diagrams.

NOTE 4—Palmer (20) developed a tabular system for the classification of natural water. Hill (1) classified water by composition using two trilinear and one diamond-shaped diagrams of his own design combined. Back (21) improved the classification techniques for determining the hydrochemical facies of the ground water by a modification of the Piper diagram.

5.6 The origin of the water or degree of mixing may be postulated by examination of the placement and relationship of the cations and anions from different water samples that are plotted on the diagrams.

5.7 Numerous interpretive methods are possible from the examination of water analysis diagrams. For example, it is reasonable to hypothesize the path that the ground water has traveled while in the hydrologic regime, the amount of mixing that has occurred with water from a different origin, and the effects of ambient conditions, such as air, temperature, rock, and man-induced contaminants, on the water.

NOTE 5—It should be noted that for many hydrochemical research problems involving the interpretation of the origin, chemical reactions, and mixing of natural water, the water analysis diagram is only one segment of several analytical methods necessary to understand the condition.

6. Documentation

6.1 Introduction:

6.1.1 An outline of graphical plots by Hem (14) describes the trilinear plotting systems developed to display the chemical composition of natural waters. Hem's summary states, "All

trilinear plotting techniques are, in a sense, descendants of the geochemical classification scheme of Palmer” (20).

NOTE 6—The publication by Hem (14) offers an overview of the geochemistry of natural waters and was used throughout this guide as a source of information. A number of other excellent publications are available for the geochemistry of natural ground water; most of those are referred to in the text and listed in the bibliography.

6.1.2 The earliest reference to the use of trilinear plots to study ground water was by Emmons and Harrington (22) for the study of mine water composition. Their method was designed principally to examine some of the less common ions that are found in the mineralized waters associated with mines, not with potable ground water.

NOTE 7—Earlier uses of the trilinear diagram, attributed to Goldschmidt (23), were in the study of the geochemistry of metamorphic rocks in Norway. Brownlow (24) has numerous examples of the use of trilinear diagrams in the study of igneous and metamorphic rocks. Bumb, et al (25) presented a trilinear diagram designed by the U.S. Department of Agriculture, Soil Conservation Service, that delineates the basic soil texture classification.

6.1.3 The first documented use of the cation and anion trilinear diagrams that incorporated a combined cation/anion diamond-shaped diagram for assisting in the interpretation of quality data for potable ground water was by Hill (1) (Fig. 1). Developed from work performed by Palmer (20), Hill’s diagram provides a graphical representation of the chemical characteristics of different natural waters and mixtures of these waters.

6.1.4 Langelier and Ludwig (4) developed a rectangular graph without the trilinear plots (Fig. 2) that they described as an adaptation of the trilinear method of Hill (1). They changed the outward form of the diagram in order to permit the use of standard triangular graph paper.

6.1.5 Piper (5, 6) developed a method (Fig. 3) similar to Hill’s independently. He describes the graphical procedure as “an effective tool in segregating analytical data for critical study with respect to sources of the dissolved constituents in waters, modifications in the character of a water as it passes through an area, and related geochemical problems.”

NOTE 8—The method developed by Piper was distributed originally as an unpublished document to his coworkers in the Ground Water Branch of the Water Resources Division (WRD), U.S. Geological Survey (USGS), on Oct. 5, 1942. Because of Piper’s influence and his promotion of the technique, the trilinear form that he identified as the water analysis diagram became used widely and known subsequently as the Piper diagram (Fig. 3).

6.1.6 Durov developed a series of diagrams (7-13) similar to those of Hill, Langelier and Ludwig, and Piper that provides the percentage of cations and anions on individual trilinear diagrams, and the intersection of lines extended from the cation and anion diagrams to a square gives the major-ion type of the water (Fig. 4). However, in addition, Durov extended the cation and anion lines to two rectangles adjacent to the square to provide for the representation of two other parameters, for example, dissolved solids, pH, specific conductance, etc. (described by Freeze and Cherry (17)).

6.1.7 Other researchers developed graphical display methods that are similar to those described above.

6.1.7.1 Käss (26) developed a square four-coordinate dia-

gram in which the alkaline earths are compared with the alkalis on the vertical axis, while the anions chloride, sulfate, and hydrogen carbonate (bicarbonate) appear on the horizontal axis (Fig. 5a). The analysis is represented on the diagram by a horizontal line, the length of which corresponds to the percentage of sulfate content (27).

6.1.7.2 Water-type diagrams were developed by Tolstichin (Fig. 5b) (28) and Furtak and Langguth (Fig. 5c) (29) that designate a number for the water type, depending on where the analysis plots on the diagram (27). For example, for the example analysis (Table 1), the water type numbers are 11 for the Tolstichin diagram and 98 for the Furtak and Langguth diagram (classified as a Ca-HCO₃ water).

6.1.7.3 Schwille (30) devised a hardness triangle to compare total hardness, carbonate hardness, and noncarbonate hardness (Fig. 5d) (27). In German hardness or meq/L units (one German unit in degrees = 17.8 mg/L hardness), the scale of the diagram is determined by the highest hardness value to be plotted. The plot symbol can represent the sampling category (for example, aquifer unit, lithology, etc.). Equal symbols can be enclosed by lines and the enclosed areas filled in with a pattern to emphasize a particular category. In addition, other ion values (for example, Cl and SO₄) for each analysis can be plotted on scaled rectangular diagrams that are positioned parallel to the sides of the triangular hardness diagram. Fig. 5d demonstrates the technique of plotting the individual ions.

6.1.7.4 Filatov (31) proposed a two-point system with cation and anion equilateral triangles having a common side (Fig. 6a), thus forming a diamond-shaped diagram (described by Hem (14)). Each triangle is divided into ten segments. The segments are of three different sizes. Each segment is identified by the predominate ion or ions. Areas with no predominate ion are classified as mixed.

NOTE 9—The diagram is scaled with each side representing 50 % of the total ions (cations plus anions), so that a cation or anion plot position would be computed, for example, as follows:

$$\% \text{ Ca} = \frac{\text{Ca meq/L units}}{(\text{Ca} + \text{Mg} + \text{Na} + \text{Cl} + \text{SO}_4 + \text{HCO}_3) \text{ meq/L units}} \quad (4)$$

Filatov presented an anion coefficient that identifies mixed waters numerically (see Analysis 3 in Table 2). Anion coefficients that are in the range from 0.5 to 1.0 units plot in the mixed area of the diagram. The same is true with cation coefficients. The anion computation is as follows:

$$\text{anion coefficient} = \frac{\% \text{ predominate anion}}{\sum \% \text{ remaining anions}} \quad (5)$$

6.1.7.5 The method given by Franko, et al (32) uses a water chemistry classification based on the principle of ion combinations that is attributed to the Gadza (33) and a modification of the Palmer system (20). The classification diagram of chemistry of mineral water (Fig. 6b) shown by Franko, et al (32) consists of two trilinear plots with a log-scaled, rectangular-shaped graph placed between the bases of the trilinear plots. The trilinear plots are for providing the percentages of the combined ion meq/L values. The rectangular-shaped graph is for providing the mg/L value of the dissolved solids for each analysis.

NOTE 10—Table 3 lists selected analyses from Franko, et al (32). Table 3 also gives the combined ion meq/L percentages in the order dictated by

using the principle of ion combinations. Fig. 6b uses these meq/L percentages as plot positions. The dissolved solids value is positioned on the rectangular graph at right angles to the plotted point on the trilinear diagram.

NOTE 11—In Fig. 6b and Table 3, the symbol S1 is primary salinity, S2 is secondary salinity, S3 is tertiary salinity, A1 is primary alkalinity, A2 is secondary alkalinity, and is tertiary alkalinity. In Fig. 6b and Table 3, the S1 (Cl) is combined with S1 (SO₄), and the S2 (Cl) is combined with S2 (SO₄) + S3 for plotting. The A2 and A3 (CaHCO₃ and MgHCO₃) are also combined.

6.1.7.6 D'Amore, et al (34) proposed a classification diagram that uses the diamond-shaped plot of Piper in conjunction with rectangular-shaped graphs (Fig. 7). The purpose of the combined graphs is to improve the definition of hydrochemical facies and to determine the percentages of parent waters in mixed waters better. The number of rectangular graphs included on a complete classification diagram depends on the number of categories to be portrayed, with a category being one or more water analyses from an individual aquifer, lithologic unit, or distinct hydrologic source.

NOTE 12—The Piper plot is conventional, with the cations meq/L % plotted against anions meq/L %. As defined by D'Amore, et al, the rectangular graph uses six computations (Parameters A through F) to emphasize distinct water groups. Parameters other than those defined may be useful, depending on the geochemistry of the area studied. The anion and cation components are in meq/L units in the computations (see Table 4 for four analyses from four different sources). The minimum, maximum, and mean values can be plotted for each parameter when multiple analyses exist for a single source. Fig. 7 includes an example of the symbol used for multiple samples. Resultant parameters are normalized between -100 and +100 to widen the range of the plotted values. The computations as given by D'Amore are as follows:

$$\text{Parameter A: } \frac{100}{\sum (\text{anions})} (\text{HCO}_3 - \text{SO}_4) \quad (6)$$

Parameter A assists in distinguishing between water that circulates through calcareous terrains and those occurring in evaporitic rocks.

$$\text{Parameter B: } 100 \left(\frac{\text{SO}_4}{\sum (\text{anions})} - \frac{\text{Na}}{\sum (\text{cations})} \right) \quad (7)$$

Parameter B discriminates between sulfate-enriched waters circulating in evaporitic terrains and sodium-enriched waters that have encountered marly, clayey sedimentary terrains.

$$\text{Parameter C: } 100 \left(\frac{\text{Na}}{\sum (\text{cations})} - \frac{\text{Cl}}{\sum (\text{anions})} \right) \quad (8)$$

Parameter C tends to distinguish between waters deriving from volcanites and those coming from carbonate-evaporitic series or from a regional quartzitic schistose basement.

$$\text{Parameter D: } 100 \left(\frac{\text{Na} - \text{Mg}}{\sum (\text{cations})} \right) \quad (9)$$

Parameter D distinguishes between waters that have circulated in dolomitized limestones.

$$\text{Parameter E: } 100 \left(\frac{\text{Ca} + \text{Mg}}{\sum (\text{cations})} - \frac{\text{HCO}_3}{\sum (\text{anions})} \right) \quad (10)$$

Parameter E distinguishes between waters that have circulated in carbonate aquifers and those in sulfate-bearing aquifers.

$$\text{Parameter F: } 100 \left(\frac{\text{Ca} - \text{Na} - \text{K}}{\sum (\text{cations})} \right) \quad (11)$$

Parameter F reveals the increase of K concentration in water samples.

6.1.7.7 Carreño (14, 35) described a system (he attributed to Hermion Larios) that consists of individual cation and anion trilinear diagrams (Fig. 8) that are divided into ten equal areas. These areas are numbered from zero through nine.

NOTE 13—The four small triangles shown within the larger triangles of Fig. 8 individually have the same area as each of the six irregular polygons. The plotted position (based on a 100 % meq/L scale) of the meq/L percentage cations or anions of an analysis falls within a numbered segment of each diagram. The cation number is combined with the anion number to signify a two-digit classification number, for example, Analysis 4 is classified 44, a sodium chloride water, such as from the ocean. Others shown in Fig. 8 and listed in Table 2 include Analyses 1 and 3 (99, calcium bicarbonate with a quantity of magnesium and sulfate) and Analysis 2 (38, sodium sulfate with a quantity of calcium and bicarbonate).

6.2 *Minimum Data Requirements*—The basic water analysis diagram requires water analyses that have a minimum number of major ions determined. The constituents used commonly on the diagrams are the cations calcium (Ca), magnesium (Mg), sodium (Na), and potassium (K) and the anions bicarbonate (HCO₃), carbonate (CO₃), sulfate (SO₄), and chloride (Cl). If some other ions, such as dissolved iron (Fe²⁺) and ammonia (NH₄⁺), exceed the conventional group described above in special circumstances, and all water analyses for the study include these constituents, they can replace or be added to the ion with which they are most similar. If the major anions and cations do not balance within a reasonable percent, normally 0 to ±10 %, the analysis cannot be used (16, 18).

NOTE 14—Natural potable waters normally contain relatively few dissolved constituents in concentrations greater than 1 mg/L. The maximum recommended dissolved solids for drinking water by the U.S. Public Health Service is 500 mg/L. The World Health Organization (36) guidelines recommend a maximum of 1000 mg/L dissolved solids.

6.3 *Recommended Accuracy for Chemical Balance*—The chemical balance or chemical equilibrium of a complete analysis (all major ions determined) is calculated by converting the ions from mg/L to meq/L values and adding the cations together and the anions together. The computation for percent balance is as follows, with zero as the optimum percentage value (the percentage is determined by multiplying the computed value times 100):

%chemical balance (±)

$$= \frac{\text{total cations} - \text{total anions (meq/L)}}{\text{total cations} + \text{total anions (meq/L)}} \times 100 \quad (12)$$

Recommended Chemical Balance for Use of Analyses on Water Analysis Diagrams

Dissolved Solids	Chemical Balance
0 to 100 mg/L	within ± 5 %
101 to 250 mg/L	within ± 3 %
greater than 250 mg/L	within ± 2 %

NOTE 15—Minor amounts of ions such as fluoride (F), nitrate (NO₃), iron (Fe), and barium (Ba) may occur in natural ground water, but normally they do not influence the chemical balance significantly. If any of these ions (for example, NO₃) occur in amounts that alter the chemical balance, they can be included in the computations for construction of water analysis diagrams (for example, include the NO₃ with Cl + SO₄ on the diamond-shaped diagram and SO₄ + NO₃ on the trilinear anion diagram). Other constituents may occur in minor amounts in a colloidal or

suspended state, such as silica (SiO₂), iron hydroxide (Fe), and aluminum compounds (Al), and they are not considered in the chemical balance because they are not dissolved constituents.

NOTE 16—In a study of the Delmarva Peninsula, Hamilton, et al (37) used 10 % as the error limit for the ionic charge balance of analyses with a complete set of major ions (nitrate was excluded as a major ion). In addition, there may be circumstances under which the ionic balance is greater than 10 % due to analytical error. If so, specify the circumstances.

6.4 Required Calculations for Diagram Construction:

6.4.1 *Equivalent Weight Factors*—The factors (see 3.1.4) used for converting the most common ions (used on the water analysis diagrams) to meq/L from mg/L or ep_m from ppm values are as follows:

Cations	Anions
calcium, 0.04990	bicarbonate, 0.01639
magnesium, 0.08229	carbonate, 0.03333
sodium, 0.04350	sulfate, 0.02082
potassium, 0.02558	chloride, 0.02821

6.4.2 *Individual Cation and Anion Diagram*—The percentage values used for plotting on the water analysis diagram are determined by multiplying by 100 the number derived from dividing the total meq/L or ep_m value of either the cations or anions into the individual cation or anion value. For example, the number derived from dividing the total cation value (Ca + Mg + Na + K) into the meq/L or ep_m value of Ca is multiplied by 100 to yield the percentage of Ca in the total cations (by weight).

$$\% \text{ Ca} = \frac{\text{meq/L Ca}}{\text{meq/L (Ca + Mg + Na + K)}} \times 100 \quad (13)$$

This percentage is the plot value for Ca on the cation trilinear diagram. This procedure of computation is followed for each of the remaining cations (Mg and (Na + K)) (Fig. 9) and for each of the anions (Cl, SO₄, and (HCO₃ + CO₃)) for the anion trilinear diagram.

6.4.3 *Combined Cation and Anion Diagram*—The values used for plotting on the diamond-shaped, square, or rectangular diagram are determined by multiplying by 100 the number derived from dividing the total meq/L or ep_m value of either the cations or anions into the combined value of cations or anions. For example, the number derived by dividing the total cation value (Ca + Mg + Na + K) into the combined value of Ca + Mg is multiplied by 100 to yield the percentage of Ca + Mg of the total cations.

$$\% (\text{Ca} + \text{Mg}) = \frac{\text{meq/L (Ca + Mg)}}{\text{meq/L (Ca + Mg + Na + K)}} \times 100 \quad (14)$$

NOTE 17—The above percentage is the plot value for Ca + Mg on the cation axis of the diagram. The percentage of the cations (Na + K) is the remaining amount (percent of (Ca + Mg) + percent of (Na + K), equals 100 %); only one plotted position is therefore required along the cation axis (oriented from the lower right to upper left) (Fig. 10). The position on the anion axis (oriented from the lower left to upper right) is determined using a similar procedure with the anion values. For example, the total anion value (SO₄ + Cl + CO₃ + HCO₃) divided in the combined value of SO₄ + Cl yields the percentage SO₄ + Cl of the total anions. This percentage is the plot position for SO₄ + Cl on the anion axis of the diamond-shaped diagram. The plot position of the cation value on the cation axis is therefore placed at the cross point for the plot position of the anion value on the anion axis.

6.4.4 *Example of Computations Using an Actual Chemical Analysis*—An example of the computations required to prepare

a complete chemical analysis for plotting on standard water analysis diagrams is given in Table 5.

6.4.4.1 *Chemical Analysis*—The following is the chemical analysis that is used as an example for demonstrating the steps needed for to plot constituent values.

(1) *Example of meq/L Computation:*

$$1.15 \text{ meq/L Ca} = 23 \text{ mg/L Ca} \times 0.04990 \text{ (conversion factor)} \quad (15)$$

6.4.4.2 *Chemical Balance*—The chemical balance of the analysis is checked as follows:

$$\begin{aligned} 97 \% \text{ (balance)} &= \frac{3.09 \text{ (anions)}}{3.18 \text{ (cations)}} \\ &= \frac{2.80 + 0 + 0.02 + 0.27 \text{ (anions)}}{1.15 + 0.39 + 1.52 + 0.12 \text{ (cations)}} \times 100 \end{aligned} \quad (16)$$

6.4.4.3 *Cation Trilinear Diagram*—Plot positions (the percentage of each cation constituent) for the cation trilinear diagram are determined by dividing the total cation amount in meq/L into the meq/L amount for each cation (Fig. 11).

NOTE 18—Plot values are rounded to a whole number for illustration in Fig. 11.

(1) *Example of Plot Value (Cation Percentage) Computation:*

$$36.2 \% \text{ Ca} = \frac{1.15 \text{ meq/L Ca}}{3.18 \text{ meq/L cations}} \times 100 \quad (17)$$

$$12.2 \% \text{ Mg} = \frac{0.39 \text{ meq/L Mg}}{3.18 \text{ meq/L cations}} \times 100 \quad (18)$$

$$51.6 \% \text{ Na} + \text{K} = \frac{1.52 \text{ meq/L Na} + 0.12 \text{ meq/L K}}{3.18 \text{ meq/L cations}} \times 100 \quad (19)$$

6.4.4.4 *Anion Trilinear Diagram*—Plot positions (the percentage of each anion constituent) for the anion trilinear diagram are determined by dividing the total anion amount in meq/L into the meq/L amount for each anion.

(1) *Example of Plot Value (Anion Percentage) Computation:*

$$90.6 \% \text{ HCO}_3 + \text{CO}_3 = \frac{2.80 \text{ meq/L HCO}_3 + 0 \text{ meq/L CO}_3}{3.09 \text{ meq/L anions}} \times 100 \quad (20)$$

6.4.4.5 *Cation/Anion Diamond or Square Diagram:*

$$0.7 \% \text{ SO}_4 = \frac{0.02 \text{ meq/L SO}_4}{3.09 \text{ meq/L anions}} \times 100 \quad (21)$$

$$8.7 \% \text{ Cl} = \frac{0.27 \text{ meq/L Cl}}{3.09 \text{ meq/L anions}} \times 100 \quad (22)$$

Plot positions for the cation/anion diamond diagram are determined by dividing the Ca + Mg meq/L value and the Na + K meq/L value by the total cation meq/L value. The anion portion is determined by dividing the HCO₃ + CO₃ meq/L value and the SO₄ + Cl meq/L value by the total anion meq/L value.

(1) *Example of Plot Value (Cation/Anion Percentage) Computation:*

$$48.4 \% \text{ Ca} + \text{Mg} = \frac{1.15 \text{ meq/L Ca} + 0.39 \text{ meq/L Mg}}{3.18 \text{ meq/L cations}} \times 100 \quad (23)$$

$$51.6 \% \text{ Na} + \text{K} = \frac{1.52 \text{ meq/L Na} + 0.12 \text{ meq/L K}}{3.18 \text{ meq/L cations}} \times 100 \quad (24)$$

$$90.6 \% \text{ HCO}_3 + \text{CO}_3 = \frac{2.80 \text{ meq/L HCO}_3 + 0 \text{ meq/L CO}_3}{3.09 \text{ meq/L anions}} \times 100 \quad (25)$$

$$9.4 \% \text{ SO}_4 + \text{Cl} = \frac{0.02 \text{ meq/L SO}_4 + 0.27 \text{ meq/L Cl}}{3.09 \text{ meq/L anions}} \times 100 \quad (26)$$

NOTE 19—Dissolved Fe (Fe^{+2} and Fe^{+3}) can be a larger component in some aquifers of terrestrial origin than Na + K (for example, coals, iron bog ores, and deltaic deposits). The Fe usually occurs in the deposits as an iron carbonate (FeCO_3) that dissolves to Fe and CO_3 in the water or an iron sulfate (FeSO_4) that dissolves to Fe and SO_4 in the water.

6.5 Water Analysis Diagrams:

6.5.1 Hill Geochemical Pattern Diagram:

6.5.1.1 The geochemical display designed by Hill (1) consists of three interconnected diagrams, a triangular-shaped cation, a triangular-shaped anion, and a diamond-shaped combined cation-anion graph (see Fig. 1).

NOTE 20—The bottom diagram in Fig. 1 is presented to assist in geochemical classification of the analyses by identifying the positions of the primary types and subtypes on the upper diagram.

6.5.1.2 The Hill diagram was the first trilinear graph to be described in the United States that incorporated a combination of cation and anion fields to display the chemical constituents of natural water.

6.5.1.3 The diagram was designed primarily to be a geochemical chart that incorporates a modification of the geochemical classification as proposed by Palmer (20), used by Rogers (39), and developed subsequently by Clarke (40).

NOTE 21—Clarke (41) later concluded that the Palmer method was limited because “it takes no account of the silica in natural waters and is of little use in the study of mineral springs and mine waters.”

6.5.1.4 Hill states, “Palmer grouped the strong acids together and arrived at four principal geochemical classifications: primary salinity; primary alkalinity; secondary salinity; and secondary alkalinity.” Hill also states, “For engineering and agricultural use, it seemed advisable to modify Palmer’s grouping and to use the following geochemical classifications”:

(1) *Group Z1*—The common salt group or primary salinity, including sodium chloride, potassium chloride, sodium nitrate, and potassium nitrate (Primary Types VII and VIII).

(2) *Group Z2*—The alkali group or primary alkalinity, including sodium sulfate, sodium bicarbonate or carbonate, potassium sulfate, and potassium bicarbonate or carbonate (Primary Types IV and VI).

(3) *Group Z3*—The bitter group or secondary salinity, including calcium chloride, magnesium chloride, calcium nitrate, and magnesium nitrate (Primary Types III and V).

(4) *Group Z4*—The hardness group or secondary alkalinity, including calcium bicarbonate or carbonate, magnesium bicarbonate or carbonate, calcium sulfate, and magnesium sulfate (Primary Types I and II).

(5) *Group Undefined*—Water that plots near the center of the diamond diagram is not defined regarding geochemical group (Primary Type X).

6.5.1.5 The dominant geochemical subtypes of the cations

and anions are defined for an analysis by use of the lower left and lower right triangular portions as delineated in the bottom diagram (Fig. 1). The two diagrams are subdivided into four smaller triangular segments, with each representing a dominant ion subtype, described as follows:

Cation Subtypes

- a—Mg dominant
- b—no cation dominant
- c—Ca dominant
- d—Na + K dominant

Anion Subtypes

- a— SO_4 dominant
- b—no anion dominant
- c— $\text{HCO}_3 + \text{CO}_3$ dominant
- d—Cl + NO_3 dominant

6.5.1.6 Examples of geochemical classifications as determined on the Hill diagram and described by Langelier and Ludwig (4) are illustrated in Fig. 12. Analysis 1 is classed as cIIc (c cation, II primary type, and c anion). Cation c is Ca dominant, Primary Type II is in the Z4 group (hardness or secondary alkalinity), and anion c is $\text{HCO}_3 + \text{CO}_3$ dominant.

NOTE 22—The method for computing the ion plot positions for the Hill diagram is described in 6.4.

NOTE 23—The lines connecting the analyses numbers (1, 2, and 3) in Fig. 12 are to illustrate the relationship of the three plot points for each analysis and are usually not included on the final diagram.

6.5.1.7 Analysis 2 in Fig. 12 is classed dVIIIId, which defines the cation d as Na + K dominant, Primary Type VIII as in the Z1 group (common salt or primary salinity), and anion d as Cl + NO_3 dominant.

6.5.1.8 Analysis 3 in Fig. 12 is classed dIVa, which defines the cation d as Na + K dominant, Primary Type IV as in the Z2 group (alkali or primary alkalinity), and anion a as SO_4 dominant.

6.5.1.9 Symbols for the ion plot positions on the Hill diagram can be scaled circles representing the amount of dissolved solids in the water, numbers for cross-referenced analyses given in a separate table and described in a report, or a variety of symbols (squares, circles, etc.) to identify the geologic source of the water, etc. The objective of the water study project routinely dictates how the plot positions are symbolized on the Hill diagram.

6.5.2 Langelier and Ludwig Water Classification Diagram:

6.5.2.1 The diagram presented by Langelier and Ludwig (4) consists of a square-shaped combined cation-anion graph (see Fig. 2) that is a modification of the design by Hill (1).

6.5.2.2 Being familiar with the trilinear diagram method as developed by Hill (1), Langelier and Ludwig felt that “this three-point method seems to be unnecessarily cumbersome in execution and, in graph, difficult to visual interpretation.” Also, “a more practicable method is one in which the general character of the sample is indicated by the position of a single point, and where-in more specific or critical data are indicated by special characters or symbols.”

6.5.2.3 The diagram is designed primarily to assist in the classification of waters based on the major chemical constituents, using a geochemical grouping as devised by Palmer (20).

6.5.2.4 The Langelier and Ludwig water classification diagram is made of a square divided into two triangles by a 45° line running from the lower left corner of the square to its

upper right corner. The upper triangle, the A triangle, represents an alkali group, while the lower B triangle represents a hardness group. Each of the two type triangles is divided into four subtype triangles: the alkali A triangle into AA, A1, A2, and A3 and the hardness B triangle into BB, B1, B2, and B3. The plot location of the analysis in the subtype triangles indicates the dominant property class, as follows:

Dominant Classes as Indicated by Subdivisions on the Diagram

- AA—carbonate alkali (Na_2SO_4 , NaHCO_3 , Na_2CO_3 , K_2SO_4 , KHCO_3 , and K_2CO_3)
- BB—non-carbonate hardness (NaCl , KCl , NaNO_3 , and KNO_3)
- A1 and B1—carbonate hardness ($\text{Ca}(\text{HCO}_3)_2$, CaCO_3 , $\text{Mg}(\text{HCO}_3)_2$, MgCO_3 , CaSO_4 , and MgSO_4)
- A3 and B3—non-carbonate alkali (CaCl_2 , MgCl_2 , $\text{Ca}(\text{NO}_3)_2$, and $\text{Mg}(\text{NO}_3)_2$)
- A2 and B2—no dominant class

6.5.2.5 In Fig. 13, the plot position for analysis number one is in the A1 triangle (carbonate hardness), the second is in the AA triangle (carbonate alkali), the third is in A3 (non-carbonate alkali), and the fourth is in B2 (no dominant class).

NOTE 24—The method for computing the ion plot positions for the Langelier and Ludwig diagram is described in 6.4.

6.5.2.6 The analysis numbers (see Nos. 1, 2, 3, and 4 in Fig. 13) are a cross-reference index to an accompanying table of chemical constituent values in meq/L, percentages of individual ion weights, dissolved solids in mg/L, and the Langelier/Ludwig classifications (Table 6). The analyses used by Langelier and Ludwig (4) are from a publication by Collins, et al (42).

6.5.2.7 Symbols shown on the original Langelier and Ludwig diagram are scaled circles, with the size representing the dissolved solids value, in meq/L, for each plotted analysis. The approximate value is determined by comparing the diameter of the circle with an accompanying scale (Fig. 13).

NOTE 25—The method of determining the meq/L value of the Analysis No. 1 circle is given by comparing the scale shown on the full diagram, the offset, and the expanded scale. Note that each 1 % value on the full diagram and the offset represents 1 unit on the expanded scale. The circle of Analysis No. 1 is approximately 6.5 units (6.5 %) in diameter. Therefore, as given on the expanded unit and meq/L log scale, 6.5 units is equal to approximately 11 meq/L of dissolved solids.

6.5.3 Piper Water Analysis Diagram:

6.5.3.1 The Piper diagram consists of three interrelated diagrams: a triangular-shaped cation, a triangular-shaped anion, and a diamond-shaped combined cation-anion graph (see Fig. 3). The combined cation-anion diagram is essentially a mirror image of the Langelier and Ludwig water classification diagram; however, the shape is a diamond with trilinear coordinates instead of being a square with Cartesian coordinates.

NOTE 26—According to Zaporozec (43), “Actually, Piper’s diagram in the version now used is a Hill’s modification from 1944” that was given in the Discussion section of Piper’s article.

NOTE 27—The Piper diagram is basically used as support for evaluating scientific interpretations of the hydrology of ground water aquifers. This diagram and modifications of the diagram are the most common methods used in the United States by the hydrologic profession for illustrating a number of chemical analyses, with each as single point on a graph.

NOTE 28—Names that the diagram has been referred to are the Piper diagram, Piper trilinear diagram, water analysis diagram, hydrochemical classification system, trilinear diagram, and water chemistry diagram.

6.5.3.2 Piper (5) described the method as having “certain fundamental principles in a graphic procedure which appears to be an effective tool in segregating analytical data for critical study with respect to sources of the dissolved constituents in waters, modifications in the character of a water as it passes through the area, and related geochemical problems.”

6.5.3.3 Piper stressed the usefulness of the diagram as a means for evaluating mixtures evolving from such phenomenon as salt-water intrusion into aquifers of coastal areas. Piper states, “Mixtures of two waters in all proportions, if all products remain in solution, plot in the three fields on respective straight lines that join the points representing the respective chemical characters of the two waters mixed” (see Analyses A, B, and M in Fig. 14). A study by Poland, et al (44) is one of the many examples of this type of evaluation.

NOTE 29—The following equations can be used to estimate the volumes of parent Waters A and B in the assumed Mixture M (after Walton (45)):

$$E_m = \frac{E_a E_b (a_i + b_i)}{a_i E_a + b_i E_b} \quad (27)$$

$$V_a = \frac{b_i E_b}{a_i E_a + b_i E_b}$$

$$V_b = \frac{a_i E_a}{a_i E_a + b_i E_b}$$

$$C_m = C_a V_a + C_b V_b$$

where:

- E_m = concentration of Mixture M (mg/L or meq/L),
- E_a = concentration of Water A (mg/L or meq/L),
- E_b = concentration of Water B (mg/L or meq/L),
- a_i = intercept between the plotting of A and M, measured in any of the three fields (cation trilinear, anion trilinear, or cation/anion diamond) of the diagram and any convenient scale,
- b_i = intercept between the plotting of B and M, measured in any of the three fields (cation trilinear, anion trilinear, or cation/anion diamond) of the diagram and any convenient scale,
- V_a = proportionate volume in Mixture M of water having Composition A,
- V_b = proportionate volume in Mixture M of water having Composition B,
- C_m = concentration in mixture Water M (mg/L or meq/L),
- C_a = concentration in component Water A (mg/L or meq/L), and
- C_b = concentration in component Water B (mg/L or meq/L).

For example, in Fig. 14, if the hypothetical concentration of parent Water A is 50 meq/L (E_a) and parent Water B is 100 meq/L (E_b), the computed concentration (E_m) of mixed Water M is 83 meq/L (the line between A and B is 10 units in length, 8 units between A and M (a_i), and 2 units between B and M (b_i)).

$$\frac{83 \text{ meq/L } (E_m) = (50 \text{ meq/L } (E_a) \times 100 \text{ meq/L } (E_b)) \times (8 \text{ units } (a_i) + 2 \text{ units } (b_i))}{(8 \text{ units } (a_i) \times 50 \text{ meq/L } (E_a)) + (2 \text{ units } (b_i) \times 100 \text{ meq/L } (E_b))} \quad (28)$$

If this value is in agreement with the analytical concentration of M (along with other hydrologic data), it can be assumed that M is a mixture of parent Waters A and B. This would indicate that the mixed water consists of a 0.333 portion (33.3 %) of parent Water A (V_a) and 0.667 (66.7 %) of parent water B (V_b).

$$0.333 (V_a) = \frac{2 \text{ units } (b_i) \times 100 \text{ meq/L } (E_b)}{(8 \text{ units } (a_i) \times 50 \text{ meq/L } (E_a)) + (2 \text{ units } (b_i) \times 100 \text{ meq/L } (E_b))} \quad (29)$$

$$= \frac{0.667 (V_b)}{(8 \text{ units } (a_i) \times 50 \text{ meq/L } (E_a)) + (2 \text{ units } (b_i) \times 100 \text{ meq/L } (E_b))} \quad (30)$$

Many altering factors are involved in nature, such as base exchange and sulfate reduction; the plot positions of the three analyses may therefore not fall on a line and the volumes determined from the proportions of chemical components may not be absolute.

6.5.3.4 A mixture of three parent waters can be evaluated by use of the above computation method (see Analyses A, B, C, and M in Fig. 15). The plot position of the assumed mixed water (M) will fall within a triangular area formed by connecting the plot positions of the three parent waters (A, B, and C) (5).

NOTE 30—To determine the proportionate volumes of three hypothetical parent waters in the mixed water, draw a line from one of the parent waters (for example, C) through the presumed mixed water (M) to intersect (Point X) a line drawn between the other two parent waters (A and B). The point X represents a hypothetical mixture of parent Waters A and B in the same proportions that these waters would enter into the mixed water (M). Use the above two-parent waters formulas to compute the composition and concentration of hypothetical Water X from the known values of parent Waters A and B. In turn, determine the value of the mixed water (M) from the value of parent Water C and hypothetical Water X.

6.5.3.5 Back (15, 21) presented the concept of hydrochemical facies for the study of ground water in the Atlantic Coastal Plain. Back used the parallelogram or diamond diagram for this study as a method for categorizing the chemical analyses into the various facies. The evolution of the hydrochemical facies as the water moves through the aquifer was shown by the use of a combined cation-anion diamond diagram in a ground water study of the Gulf Coastal Plain in Louisiana (46). Seaber (47) included the cation and anion triangular diagrams along with the diamond diagram (see Fig. 16), thereby strengthening the method by being able to comprehend the relationships of the individual ions more easily.

6.5.3.6 Water analysis diagrams can be used to illustrate the hydrochemical facies change by the use of arrows to indicate the direction that the water moves from the recharge area to the discharge zone of the ground water aquifer (Fig. 17 and Table 7) (48) (see p. B18 in Hamilton, et al (37)) or from the recharge area to the salt-water interface (46). Poland, et al (44) used arrows to indicate a time sequence of salt-water contamination of ground water over a 15-year period in a well field at El Segundo, CA.

6.5.3.7 Schmidt, et al (49) demonstrated the value of using the trilinear diagram to study the pollution of a ground water aquifer resulting from the disposal of brines into surface pits. The salt-water plume was traced over a 26-year period as the polluted water moved down the hydraulic gradient. Other possible uses of the diagram are in studies of pollution from highway salting, septic tanks, or other situations in which a water of one type is contaminated deliberately or inadvertently by a foreign liquid or dissolvable substance.

6.5.3.8 Another example of use of the Piper diagram is demonstrated by a study of the infiltration of moderately contaminated water from a river and the upflow of water from an underlying carbonate bedrock aquifer, both of which are induced by the pumping of wells in a contiguous glacial-drift ground water aquifer (50). The resulting hydrochemical mix-

ture of these three types of water is demonstrated by plotting the analyses on the diagram.

6.5.3.9 Symbols on the Piper diagram are used as an identification of the water source (49, 51-54). For example, Fig. 18 shows three diverse symbols for water from the peripheral bedrock (a solid circle), alluvial fans, and outer basin fill (an open square), and salt flats (an “x”).

6.5.3.10 Symbols consisting of scaled circles (usually log scale) are used to represent the dissolved solid concentrations in ppm, mg/L, epm, or meq/L units (5, 37, 43, 55-58). Examples of scaled symbols using meq/L are shown in Fig. 13.

6.5.3.11 Concentrations of other ions of interest to a particular study, for example, selenium (Se) or oxygen-18 (59), can be shown on the diagrams by the use of scaled or distinctive symbols. Piper, et al (58) used scaled lines extending from the center of the analysis plot position to give the concentrations, in meq/L %, of the Mg and SO₄ ions.

6.5.3.12 Numbers adjacent to the plot points or symbols are used for cross reference to an accompanying table of analyses (60), sample collection depths (61), geographical area of data collection (18), aquifer identification (62), cross reference to an areal map (37, 63), or identifications on a geologic section (46).

6.5.3.13 Three statistical methods were developed by Helsel and Slack (64) to provide repeatable and quantitative procedures for illustrating curves representing chemical characteristics, directions of chemical change, and group boundaries on the Piper diagram. Based on smoothing procedures, the first method characterizes the general location of data. The second method draws a line that defines the central backbone of the data. The third method draws envelopes of confidence intervals for locations of data groups when multivariate normality can be assumed.

6.5.3.14 Distinct groups of plotted points or symbols can be highlighted by enclosing the group with a line or an envelope (64, 65) (Fig. 18). Further emphasis can be placed on various groups in the diagram by the use of a pattern within the enclosed area (62).

6.5.3.15 An example of contouring directly on a Piper diagram is demonstrated by illustrating a chemical change in water moving down dip in two related aquifers (60). The dissolved solid values were contoured to show the relationship of the hydrochemical facies (which changed from a calcium-magnesium bicarbonate to a sodium bicarbonate and a sodium sulfate type) and the dissolved solids (which increased from less than 400 mg/L to over 1000 mg/L).

6.5.3.16 A three-dimensional (3-D) version of the Piper diagram has been developed by Briel (66). This computer-driven procedure projects Z-dimension data from the surface of an ordinary X- Y dimension Piper plot into a triangular prism to indicate how variations in chemical composition can be related to variations in other water quality variables. Any third dimension variable relating to the analyses can be illustrated, such as the sample depth, specific conductance, dissolved solids, and pH. The 3-D Piper diagram can be rotated about all three axes (X, Y, and Z) to permit the data to be seen from many different viewpoints and reduce the bias introduced by any single viewpoint.

6.5.4 *Durov Water Classification Diagram:*

6.5.4.1 The Durov diagram consists of three interconnected diagrams, a triangular-shaped cation, an inverted triangular-shaped anion, and a combined cation-anion square-shaped graph (see Fig. 4). In addition, the interconnected diagram has rectangular extensions to plot additional water characteristic values of importance to the study.

NOTE 31—Durov was a prominent Russian hydrologist who developed a water classification diagram over a period of time, beginning in 1948. He originally designed an inverted triangular diagram and later modified the graph to one similar to that shown in Fig. 13. The discussions of the Durov Classification Diagram by Zaporozec (43) and Chilingir (67) are very informative.

6.5.4.2 As defined by Chilingir (67), the purpose of the Durov diagram is to classify natural waters on the basis of ionic composition. Durov (7) divided the natural waters into five classes:

(1) Class I (primary waters) results from the action of atmospheric precipitation on the Earth's surface that was leached of readily soluble salts.

(2) Class II (secondary waters) results from the enrichment of primary waters with sulfates and chlorides of sodium and magnesium that are present in sedimentary rocks.

(3) Class III (sulfate waters) results from secondary waters upon the removal of bicarbonates and if the chlorides are of secondary importance.

(4) Class IV (chloride waters) results from enrichment with chlorides and the simultaneous loss of bicarbonates and sulfates, due to the precipitation of CaCO_3 , $\text{CaMg}(\text{CO}_3)_2$, and CaSO_4 , with the secondary waters changing to chloride-predominant waters.

(5) Class V (alkaline bicarbonate waters) results from the secondary waters upon the colloidal-chemical removal of Ca^{2+} , Mg^{2+} , and SO_4^{2-} ions by fresh-water clays.

6.5.4.3 An example of a Durov diagram with plotted values is shown in Fig. 19. The method is similar to other techniques (1, 4, 6), with the addition of the rectangular extensions.

NOTE 32—The Durov diagram illustrated in Fig. 19 shows the concentrations (Table 8) of the dissolved solids and free CO_2 on the extensions. As shown in the cation trilinear diagram, Analysis 2 has 22 % Ca, 73 % Na + K, and 5 % Mg of the total cation mg/L. As shown in the anion diagram, Analysis 2 has 25 % Cl, 35 % $\text{HCO}_3 + \text{CO}_3$, and 40 % SO_4 of the total anion mg/L. The dashed horizontal line extends from Analysis 2 of the cation diagram into the square diagram and on into the rectangular extension to yield the value of the dissolved solids (8500 mg/L). The dashed vertical line extends from Analysis 2 of the anion diagram into the square diagram, where it crosses the horizontal line (the cross point yields the major ion composition on a percentage basis) and on into the rectangular extension to yield the value of the free CO_2 (1600 mg/L). The water type for Analysis 2 is a transition between Class III and Class V (sulfate and alkaline bicarbonate).

NOTE 33—The method for computing the ion plot positions for the Durov diagram is described in 6.4.

6.5.4.4 An example of a modification of the Durov diagram was used by Knobel and Phillips (68) in a study of the Magothy aquifer in Maryland where the Fe concentration in the sampled water was significant. They modified the traditional trilinear cation portion of the diagram (see Fig. 4) by replacing the Mg ion with Fe. The Mg was then combined with the Ca ion.

6.5.4.5 As developed by Helsel and Slack (64) for the Piper diagrams, the method of using a polar smoothing routine was

used by Welch (69) on the Durov diagram to group, by statistically determined envelopes, the analyses of water from three aquifers in the Carson and Eagle Valleys of Nevada.

6.5.4.6 Numbered solid circles have been used to identify the analyses on each of the segments of the diagram (cation and anion trilinear plots, major-ion square plot, and two rectangular extensions). The plotted numbers are normally cross-referenced to an accompanying table of constituent values.

6.5.4.7 Symbols (for example, triangles, squares, and circles) have been used to represent the five Durov chemical classes of the water. Various combinations of shading of the symbols have been used to portray transitional stages between the classes (67).

6.5.4.8 As shown in Fig. 19 for giving the TDS and Free CO_2 values, the rectangular extensions can be used to furnish the values of Ph, specific conductance, hardness, and so forth. Welch, et al (70) used the diagram in a traditional manner with dissolved solids and pH on the extensions. In addition to pH, Knobel and Phillips (68) used an extension to give the “distance along flowpath, in miles” (the distance of sample collection from the outcrop area of the aquifer) to reveal the progressive change in the hydrochemical facies as the water moves down gradient in the aquifer. Katz and Choquette (71) used an extension to display the depth of the wells from which the water samples were collected. Ward, et al (72) effectively used an extension as a time scale to illustrate the change in the quality of water from 1963 to 1979 in monitoring wells near two waste injection facilities.

6.5.4.9 Several examples of the use of the Durov diagram for assisting in interpretation of the geochemistry of ground water are by Jackson and Lloyd (73) and Howard (74). They used an adaptation of the diagram to interpret the regional flow characteristics of aquifers in Eastern England. Sen and Al-Dakheel (75) used the diagram in a study of the Umm Er Radhuma carbonate aquifer of Saudi Arabia. Many general geochemistry documents and texts provide descriptions of the method; however, the use of the Durov diagram has not been common in interpretative studies of the United States.

6.6 Automated Procedures for Water Analysis Diagrams:

NOTE 34—Literature searches and verbal inquiries found computerized procedures for the Piper and Durov diagrams. Although procedures for the other water analysis diagrams discussed in this guide are probably available, none could be found. Additional sources of computerized procedures can be added in the subsequent revisions of this guide.

6.6.1 The Piper diagram was automated in 1966 for use with computerized ground water quality files and a line printer (76). The plot symbols on the water analysis diagram are identified by adjacent numbers, for either geologic units (aquifer) or chemical analyses. These numbers are listed in accompanying tables. Analyses are checked for completeness and balance of cations and anions; both conditions must meet the quality standard to be plotted. A diagram showing the average plot position of each source aquifer is an option of the procedure.

NOTE 35—The cation/anion part of the first documented computerized Piper diagram was patterned after the square-grid-shaped diagram that Dingman and Ferguson (77) had modified from the design of Langelier and Ludwig (4). A listing of the FORTRAN IV program for the Piper diagram was published in 1969 (78) by the Kansas Geological Survey. The

original computer procedure was modified in the early 1970s to the classic diamond shape.

6.6.2 A computer program PIPER, written by Morris, et al (79) in BASIC language, is designed to run on a Hewlett-Packard desktop computer with a cathode-ray tube (CRT), thermal printer, and peripheral X- Y plotter. Many of the concepts developed by Piper are incorporated into the program output. The input water quality data are converted from ppm to meq/L units, and the percentage reacting values (plot values) are computed. Both the input and output values are listed in accompanying tables. The graphical output is of the standard diagram with the analysis plot points or symbols numbered for identification in the tables. The analysis plot points on the diamond part of the diagram have corresponding scaled circles (either arithmetic or logarithmic) that indicate the dissolved solids concentration. Along with either two or three parents, assumed mixed waters are examined numerically and are included in the output if the results indicate mixing.

6.6.3 A relational ground water database with an extensive collection of ground water, geology, and areal map procedures (GEOBASE 6.0) for desktop computers is available from Earthware of California. Included in this program package are routines for display of the Piper and Durov diagrams. For further information, contact Earthware of California, 30100 Town Center Drive No. 196, Laguna Niguel, CA 92677, (714) 495-5727.

6.6.4 A package of software (ROCKSTAT) from Rockware Scientific Software contains routines for plotting water analysis diagrams on a desktop computer. Included is a version of the Piper diagram. For further information, contact Rockware Scientific Software, 4251 Kipling St., Suite 595, Wheat Ridge, CO 80033, (303) 423-5645.

6.6.5 Three statistical methods were developed by Helsel and Slack (64) to provide repeatable and quantitative procedures for illustrating curves representing chemical characteristics, directions of chemical change, and group boundaries for

analyses plotted on the Piper diagram. These techniques were used on the Durov diagram by Welch (69).

6.6.6 A package of six water quality diagrams is available through documentation from the USGS (66). Two versions of the Piper diagram are included in the package. Of great significance is a newly developed 3-D Piper diagram. This version of the Piper “projects data from the surface of a two-dimensional Piper plot into a triangular prism to indicate how variations in chemical composition may be related to variations in an independent variable.” The third dimension variables illustrated were the specific conductance, dissolved solids, and pH. For further information, contact USGS Books and Reports Sales, Federal Center, Box 25425, Denver, CO 80225, (303) 236-7476.

6.6.7 A graphics package called PLOTCHEM^{EM} includes a version of the Piper diagram in which water quality data may be entered directly or from a separate ASCII file. The program has options for plotting a separate symbol for each sample point and also symbols for representing multiple, overlapping points. Circles representing dissolved solids concentrations can be plotted using either arithmetic or logarithmic scales. Waters that are presumed mixtures of two or three parent waters can be evaluated by the software and the results plotted and tabulated. For further information, contact Scientific Software Group, P.O. Box 23041, Washington, DC 20026-3041, (703) 620-9214.

6.6.8 A comprehensive environmental database management system (GIS/KEY) includes a version of the PIPER diagram. For further information, contact GIS Solutions, 1800 Sutter Street, Suite 830, Concord, CA 94520-2500, (505) 827-5400.

7. Keywords

7.1 chemical ions; geochemical classification; ground water; hydrochemical facies; trilinear diagram; water analysis diagram

REFERENCES

- (1) Hill, R. A., “Geochemical Patterns in Coachella Valley, California,” *American Geophysical Union Transactions*, Vol 21, 1940, pp. 46–53.
- (2) Hill, R. A., “Salts in Irrigation Water,” *American Society of Civil Engineers Proceedings*, Vol 67, 1941, pp. 975–990.
- (3) Hill, R. A., “Salts in Irrigation Water,” *American Society of Civil Engineers Proceedings*, Vol 107, 1942, pp. 1478–1493.
- (4) Langelier, W. F., and Ludwig, H. F., “Graphical Methods for Indicating the Mineral Character of Natural Waters,” *American Water Works Association Journal*, Vol 34, 1942, pp. 335–352.
- (5) Piper, A. M., “A Graphic Procedure in the Geochemical Interpretation of Water Analyses,” *American Geophysical Union Transactions*, Vol 25, 1944, pp. 914–923.
- (6) Piper, A. M., “A Graphic Procedure in the Geochemical Interpretation of Water Analyses,” *U.S. Geological Survey Ground Water Note 12*, 1953, p. 14.
- (7) Durov, S. A., “Classification of Natural Waters and Graphic Representation of Their Composition,” *Doklady Akad. Nauk SSSR*, Vol 59, No. 1, 1948, pp. 87–90.
- (8) Durov, S. A., “Triangular Diagrams in Graphic Representation of Ground-Water Analyses and Their Use in the Classification of Natural Waters,” *Gidokhem. Materialy*, No. 16, 1949, p. 54.
- (9) Durov, S. A., “Doubled Tetrahedral Diagram and Chemical Composition of Natural Waters,” *Izvestija Sektora Fcha.*, Vol 20, 1950, p. 238.
- (10) Durov, S. A., “Origin of Salts in River Waters,” *Doklady Akad. Nauk SSSR*, Vol 81, No. 5, 1951, pp. 875–878.
- (11) Durov, S. A., “Sources of Accumulation of Salts in Small Rivers of Ukraine SSR,” *Doklady Akad. Nauk SSSR*, Vol 84, No. 5, 1952, pp. 1005–1008.
- (12) Durov, S. A., and Fedorova, N. E., “Sources of Ionic-Salt Composition of Atmospheric Precipitation in USSR,” *Doklady Akad. Nauk SSSR*, Vol 103, No. 4, 1955, pp. 663–665.
- (13) Durov, S. A., “Geometrical Methods in Hydrochemistry,” *Rostov, U.S.S.R.*, 1959.
- (14) Hem, J. D., “Study and Interpretation of the Chemical Characteristics of Natural Water,” *U.S. Geological Survey Water-Supply Paper 2254*, 1989, p. 263.
- (15) van der Leedan, F., Troise, F. L., and Todd, D. K., *The Water Encyclopedia, Geraghty and Miller Ground-Water Series*, 2nd Ed., Lewis Publishers, Inc., Chelsea, MD, 1990.
- (16) Back, W., “Techniques for Mapping Hydrochemical Facies,” *U.S.*

- Geological Survey Prof. Paper 424-D*, 1961, pp. D380–D382.
- (17) Freeze, R. A., and Cherry, J. A., *Groundwater*, Prentice-Hall, Inc., Englewood Cliffs, NJ, 1979, pp. 237–302.
- (18) Back, W., “Hydrochemical Facies and Ground-Water Flow Patterns in Northern Part of Atlantic Coastal Plain,” *U.S. Geological Survey Prof. Paper 498-A*, 1966, p. 42.
- (19) Davis, S. N., and DeWiest, R. J. M., *Hydrogeology*, John Wiley and Sons, New York, NY, 1966, pp. 77–83 and 96–128.
- (20) Palmer, C., “The Geochemical Interpretation of Water Analyses,” *U.S. Geological Survey Bulletin 479*, 1911, p. 31.
- (21) Back, W., “Origin of Hydrochemical Facies of Ground Water in the Atlantic Coastal Plain,” *21st International Geologic Congress*, Copenhagen 1960, Reports, Pt. 1, 1960, pp. 87–95.
- (22) Emmons, W. H., and Harrington, G. L., “A Comparison of Waters of Mines and of Hot Springs,” *Economic Geology*, Vol 8, 1913, pp. 653–669.
- (23) Goldschmidt, V. M., “Die kontaktmetamorphose in Kristianiagebiet,” *Kristiania Vidensk. Skr.*, I, Mat-Naturv. Klasse, 1911, p. 483.
- (24) Brownlow, A. H., *Geochemistry*, Prentice-Hall, Inc., Englewood Cliffs, NJ, 1979, pp. 356–413.
- (25) Bumb, A. C., Murphy, C. L., and Everett, L. G., “A Comparison of Three Functional Forms for Representing Soil Moisture Characteristics,” *Ground Water*, Vol 30, No. 2, 1992, pp. 177–185.
- (26) Käss, W., “Zur Geochemie einiger neuerschlossener Buntsandstein-Mineralwässer am Schwarzwald-Ostrand,” *Jahrb. Geologisches Landesamt*, Baden-Württemberg, Vol 9, 1967, pp. 81–104.
- (27) Matthes, G., *The Properties of Groundwater*, John Wiley and Sons, New York, 1982, pp. 299–335.
- (28) Alekin, O. A., *Grundlagen der Wasserchemie, Eine einföhrung in die chemie natürlicher wässer*, Leipzig, 1962, p. 260.
- (29) Furtak, H., and Langguth, H. R., “Zur hydrochemischen kennzeichnung von grundwässern und grundwassertypen mittels kennzahlen,” *International Association Hydrogeology Memoirs*, Hannover, Vol 7, 1967, pp. 89–96.
- (30) Schwillie, F., “Das Härtedreieck,” *Gas-Wasserfach*, Munich, Vol 98, No. 12, 1957, pp. 280–282.
- (31) Filatov, K. V., “Graphic Representation of Chemical Analyses of Water,” *Doklady Akad. Nauk SSSR*, Vol 59, 1948, pp. 91–94.
- (32) Franko, O., Gazda, S., and Michalíček, M., “Tvorba a Klasifikácia Mineralnych Vöd Zapadnych Karpat,” *Geologický Ústav Dionýza Stúra*, Bratislava, 1975, p. 230.
- (33) Gazda, S., “Modifikácia Palmerovho klasifikačného systému,” *Hydrogeologická ročenka*, Bratislava, 1971, pp. 122–126.
- (34) D’Amore, F., Scandiffo, G., and Pavichi, G., “Some Observations on the Chemical Classification of Ground Waters,” *Geothermics*, Vol 12, Nos. 2/3, 1983, pp. 141–148.
- (35) Carreno, D. O. A., “Las Provincias Geohidrológicas de México (primera parte),” *Universidad Nacional de México*, Instituto de Geología Boletín, Vol 56, 1951, p. 137.
- (36) World Health Organization, *Guidelines for Drinking Water Standards*, Geneva, Switzerland, 1984.
- (37) Hamilton, P. A., Shedlock, R. J., and Phillips, P. J., “Water-Quality Assessment of the Delmarva Peninsula, Delaware, Maryland, and Virginia—Analysis of Available Ground-Water-Quality Data Through 1987, Chapter B,” *U.S. Geological Survey Water-Supply Paper 2355*, 1991, p. B65.
- (38) Fetter, C. W., *Applied Hydrogeology*, 2nd Ed., Merrill Publishing Co., Columbus, OH, 1988, pp. 325–366.
- (39) Rogers, G. S., “Chemical Relations of the Oil-Field Waters in San Joaquin Valley, California,” *U.S. Geological Survey Bulletin 653*, 1917, p. 119.
- (40) Clarke, F. W., *The Data of Geochemistry*, 4th Ed., *U.S. Geological Survey Bulletin 695*, 1920, pp. 62–64.
- (41) Clarke, F. W., *The Data of Geochemistry*, 5th Ed., *U.S. Geological Survey Bulletin 770*, 1924, pp. 66–68.
- (42) Collins, W. D., Lamar, W. L., and Lohr, E. W., “The Industrial Utility of Public Water Supplies in the United States, 1932,” *U.S. Geological Survey Water-Supply Paper 658*, 1934, p. 135.
- (43) Zaporozec, A., “Graphical Interpretation of Water-Quality Data,” *Ground Water*, Vol 10, No. 2, 1972, pp. 32–43.
- (44) Poland, J. F., Garrett, A. A., and Sinnott, A., “Geology, Hydrology, and Chemical Character of Ground Waters in the Torrance-Santa Monica Area, California,” *U.S. Geological Survey Water-Supply Paper 1461*, 1959, p. 425.
- (45) Walton, W. C., *Groundwater Resource Evaluation*, McGraw-Hill, New York, NY, 1970, pp. 452–456.
- (46) Morgan, C. O., and Winner, M. D., Jr., “Hydrochemical Facies in the 400-Foot and 600-Foot Sand of the Baton Rouge Area, Louisiana,” *U.S. Geological Survey Prof. Paper 450-B*, 1962, pp. B120–B123.
- (47) Seaber, P. R., “Variations in Chemical Character of Water in the Englishtown Formation, New Jersey,” *U.S. Geological Survey Prof. Paper 498-B*, 1965, p. A42.
- (48) Krothe, N. C., and Bergeron, M. P., “Hydrochemical Facies in a Tertiary Basin in the Milligan Canyon Area, Southwest Montana,” *Ground Water*, Vol 19, No. 4, 1981, pp. 392–399.
- (49) Schmidt, K. D., Krancher, J. A., and Bisel, G., Jr., “Brine Pollution at Fresno—Twenty-Six Years Later,” *Ground Water*, Vol 19, No. 1, 1981, pp. 12–19.
- (50) Childress, C. J. O., Sheets, R. A., and Bair, E. S., “Hydrology and Water Quality Near the South Well Field, Southern Franklin County, Ohio, with Emphasis on the Simulation of Ground-Water Flow and Transport of Scioto River,” *U.S. Geological Survey Water-Resources Investigations Report 91-4080*, 1991, p. 78.
- (51) Boyd, F. M., and Kreidler, C. W., “Hydrogeology of a Gypsum Playa, Northern Salt Basin, Texas,” *Bureau of Economic Geology Report of Investigations No. 158*, The University of Texas at Austin, 1986, p. 37.
- (52) Weaver, T. R., and Bahr, J. M., “Geochemical Evolution in the Cambrian-Ordovician Sandstone Aquifer, Eastern Wisconsin: 1. Major Ion and Radionuclide Distribution,” *Ground Water*, Vol 29, No. 3, 1991, pp. 350–356.
- (53) Weaver, T. R., and Bahr, J. M., “Geochemical Evolution in the Cambrian-Ordovician Sandstone Aquifer, Eastern Wisconsin: 2. Correlation Between Flow Paths and Ground-Water Chemistry,” *Ground Water*, Vol 29, No. 4, 1991, pp. 510–515.
- (54) Gerla, Philip J., “Pathline and Geochemical Evolution of Ground Water in a Regional Discharge Area, Red River Valley, North Dakota,” *Ground Water*, Vol 30, No. 5, 1992, pp. 743–754.
- (55) Dulas, R., “The Baseline Diagram: A New Water Quality Diagram in Short Papers on Research in 1977,” *Kansas Geological Survey Bulletin 211*, Part 4, 1977, pp. 10–16.
- (56) Domenico, P. A., and Schwartz, F. W., *Physical and Chemical Hydrogeology*, John Wiley and Sons, New York, NY, 1990, pp. 411–420.
- (57) Nielsen, D. M., ed., *Practical Handbook of Ground-Water Monitoring*, Lewis Publishers, Chelsea, MD, 1991, pp. 555–558.
- (58) Piper, A. M., Garrett, A. A., et al, “Native and Contaminated Ground Waters in the Long Beach-Santa Ana Area, California,” *U.S. Geological Survey Water-Supply Paper 1136*, 1953, p. 320.
- (59) Dubrovsky, N. M., Neil, J. M., Welker, M. C., and Evenson, K. D., “Geochemical Relations and Distribution of Selected Trace Elements in Ground Water of the San Joaquin Valley, California,” *U.S. Geological Survey Water-Supply Paper 2380*, 1991, p. 51.
- (60) Hall, W. D., and Turk, L. J., “Aquifer Evaluation Using Depositional Systems: An Example in North-Central Texas,” *Ground Water*, Vol 13, No. 6, 1975, pp. 269–274.
- (61) Pucci, A. A., Jr., and Owens, J. P., “Geochemical Variations in a Core of Hydrogeologic Units Near Freehold, New Jersey,” *Ground Water*, Vol 27, No. 6, 1989, pp. 802–812.
- (62) McNellis, J. M., Morgan, C. O., and Lowell, B. H., “Computer-Produced Tables, Maps, and Diagrams as Tools in the Interpretation of Brine Data from Southeastern Kansas,” *Chemical Geology*, Vol 4, 1969, pp. 303–324.
- (63) Maclay, R. W., and Winter, T. C., “Geochemistry and Ground-Water

- Movement in Northwestern Minnesota,” *Ground Water*, Vol 5, No. 1, 1967, pp. 11–19.
- (64) Helsel, D. R., and Slack, J. R., “Diamond in the Rough: Enhancements to Piper Diagrams,” submitted to *Journal of Ground Water*, will be available as *U.S. Geological Survey Open-File Report*, 1993.
- (65) Helsel, D. R., and Hirsch, R. M., *Statistical Methods in Water Resources*, *Studies in Environmental Science 49*, Elsevier, Amsterdam, 1992, p. 552.
- (66) Briel, L. I., “Documentation of a Multiple-Technique Computer Program for Plotting Major-Ion Composition of Natural Waters,” *U.S. Geological Survey Open-File Report 93-74*, 1993.
- (67) Chilingar, G. V., “Durov’s Classification of Natural Waters and Chemical Composition of Atmospheric Precipitation in USSR: A Review,” *Am. Geoph. Union Trans.*, Vol 37, No. 2, 1956, pp. 193–196.
- (68) Knobel, L. L., and Phillips, S. W., “Aqueous Geochemistry of the Magothy Aquifer, Maryland,” *U.S. Geological Survey Water-Supply Paper 2323*, 1988, p. 28.
- (69) Welch, A. H., “Geochemistry of Ground Water in Carson and Eagle Valleys, Western Nevada and Eastern California,” *U.S. Geological Survey Open-File Report 93-33*, 1993.
- (70) Welch, A. H., Plume, R. W., Frick, E. A., and Hughes, J. L., “Ground-Water-Quality Assessment of the Carson River Basin, Nevada and California: Analysis of Available Water-Quality Data through 1987,” *U.S. Geological Survey Open-File Report 89-382*, 1991, p. 115.
- (71) Katz, B. G., and Choquette, A. F., “Aqueous Geochemistry of the Sand- and Gravel Aquifer, Northwest, Florida,” *Ground Water*, Vol 29, No. 1, 1991, pp. 47–55.
- (72) Ward, D. S., Mercer, J. W., and August, L. L., “Analysis of Ground-Water Flow and Injection Fluid Transport in the Floridan Aquifer Near Pensacola, Florida,” *Ground Water*, Vol 30, No. 3, 1992, pp. 403–414.
- (73) Jackson, D., and Lloyd, J. W., “An Integrated Hydrochemical Approach to Deduce the Response of an Aquifer System During its History of Abstraction,” *Ground Water*, Vol 22, No. 6, 1984, pp. 735–745.
- (74) Howard, K. W. F., “A Multistage Model for the Development of Hydrochemical Zonation in Chalk Ground Waters,” *Ground Water*, Vol 23, No. 1, 1985, pp. 4–9.
- (75) Sen, Z., and Al-Dakheel, A., “Hydrochemical Facies Evaluation in Umm Er Radhuma Limestone, Eastern Saudi Arabia,” *Ground Water*, Vol 24, No. 5, 1986, pp. 626–635.
- (76) Morgan, C. O., Dingman, R. J., and McNellis, J. M., “Digital Computer Methods for Water-Quality Data,” *Ground Water*, Vol 4, No. 3, 1966, pp. 35–42.
- (77) Dingman, R. J., and Ferguson, H. R., “The Water Resources of Baltimore and Harford Counties (Maryland),” *Mines and Water Resources Bulletin 17*, *Maryland Department of Geology*, 1956, p. 233.
- (78) McNellis, J. M., and Morgan, C. O., “Modified Piper Diagrams by the Digital Computer,” *Kansas Geological Survey Spec. Distrib. Pub. 45*, 1969, p. 36.
- (79) Morris, M. D., Berk, J. A., Krulik, J. W., and Eckstein, Y., “A Computer Program for a Trilinear Diagram Plot and Analysis of Water Mixing Systems,” *Ground Water*, Vol 21, No. 1, 1983, pp. 67–78.

BIBLIOGRAPHY

- (80) Al-Ruwaih, F., “Ground-Water Chemistry of Dibdiba Formation, North Kuwait,” *Ground Water*, Vol 22, No. 4, 1984, pp. 412–417.
- Appelo, C. A. J., and Geirnaert, W., “Processes Accompanying the Intrusion of Salt Water in Hydrology of Salt Water Intrusion, a Selection of SWIM Papers,” *International Contributions to Hydrogeology*, Vol 11, International Association of Hydrogeologists, Hannover, 1991, pp. 291–303.
- Arad, A., “B, F and Sr as Tracers in Carbonate Aquifers and in Karstic Geothermal Systems in Israel,” *Proceedings of IAH 21st Congress*, Vol XXI, Part 2, International Association of Hydrogeologists, 1988, pp. 922–934.
- Chambers, J. M., Cleveland, W. S., Kiner, B., and Tukey, P. A., “Graphical Methods for Data Analysis,” Wadsworth and Brooks/Cole Publishing Company, Pacific Grove, 1983, p. 395.
- Cheng, S., “Trilinear Diagram Revisited: Application, Limitation, and an Electronic Spreadsheet Program,” *Ground Water*, Vol 26, No. 4, 1988, pp. 505–510.
- Colby, B. R., Hembree, C. H., and Rainwater, F. H., “Sedimentation and Chemical Quality of Surface Water in the Wind River Basin, Wyoming,” *U.S. Geological Survey Water-Supply Paper 1373*, 1956, p. 336.
- Dalton, M. G., and Upchurch, S. B., “Interpretation of Hydrochemical Facies by Factor Analysis,” *Ground Water*, Vol 16, No. 4, 1978, pp. 228–233.
- De Breuck, W., and De Moor, G., “The Evolution of the Coastal Aquifer of Belgium in Hydrology of Salt Water Intrusion, A Selection of SWIM Papers,” *International Contributions to Hydrogeology*, Vol II, International Association of Hydrogeologists, Hannover, 1991, pp. 35–47.
- Driscoll, F. G., *Groundwater and Wells*, Johnson Division, St. Paul, MN, 1986, pp. 114–117.
- Dutton, Alan R., “Brackish Water in Unsaturated Confining Beds at a Texas Lignite Mine,” *Ground Water*, Vol 23, No. 1, 1985, pp. 68–80.
- Franko, G., Gazda, S., and Michalcek, M., “Tvorba a Klasifikácia Mineralnych Vôd Zapadnych Karpat,” *Geologický Ústav Dionýza Stúra*, Bratislava, 1975, p. 230.
- Green, C., “Sea Water Intrusion in California, Appendix B, Laboratory Studies and Research Relative to Investigational Work for Prevention and Control of Sea Water Intrusion,” *State of California Department of Water Resources Bulletin No. 63*, Appendix B, Report by Los Angeles County Flood Control District, Dec. 20, 1954, 1957, pp. 89–112.
- Hahn, J., “Aspects in Groundwater Salinization in the Wittmund (East Friesland) Coastal Area in Hydrology of Salt Water Intrusion, A Selection of SWIM Papers,” *International Contributions to Hydrogeology*, Vol 11, International Association of Hydrogeologists, Hannover, 1991, pp. 251–269.
- Heath, R. C., “Basic Ground-Water Hydrology,” *U.S. Geological Survey Water-Supply Paper 2220*, 1983, p. 84.
- Hollett, K. J., Danskin, W. R., McCaffrey, W. F., and Walti, C. L., “Geology and Water Resources of Owens Valley, California, Chapter B,” *U.S. Geological Survey Water-Supply Paper 2370-B*, 1991, p. 77.
- Huntoon, P. W., “Fault Controlled Ground-Water Circulation Under the Colorado River, Marble Canyon, Arizona,” *Ground Water*, Vol 19, No. 1, 1981, pp. 20–27.
- Huntoon, P. W., and Lundy, D. A., “Fracture-Controlled Ground-Water Circulation and Well Siting in the Vicinity of Laramie, Wyoming,” *Ground Water*, Vol 17, No. 5, 1979, pp. 463–469.
- Krauskopf, K. B., *Introduction to Geochemistry*, McGraw-Hill, New York, NY, 1967, pp. 336–345, 376–387, and 534–572.
- Krothe, N. C., “Hydrologic Connection Between Spring Water and the Evaporite of the Lower St. Louis Limestone, Karst Mitchell Plain of Southern Indiana,” *Proceedings of IAH 21st Congress*, Vol XXI, Part 1, International Association of Hydrogeologists, 1988, pp. 406–416.

Loehnert, E. P., and Papakonstantinou, A., "Relationship Between Karst and Porous Aquifers on Chalkidiki Peninsula, Greece," *Proceedings of IAH 21st Congress*, Vol XXI, Part 1, International Association of Hydrogeologists, 1988, pp. 321–338.

McNeil, V. H., McNeil, A. G., and Poplawski, W. A., "Development of a Water Quality Monitoring System in Queensland," *Proceedings International Symposium on the Design of Water-Quality Information Systems*, Colorado Water Resources Research Institute, Information Series No. 61, 1989, pp. 73–86.

Memon, B. A., Kazi, A., and Bazuhair, A. S., "Hydrogeology of Wadi Al-Yammaniyah, Saudi Arabia," *Ground Water*, Vol 22, No. 4, 1984, pp. 406–411.

Nejand, S., and Khan, R. A., "Ground-Water Quality in the Shiraz Basin, South Iran," *Ground Water*, Vol 13, No. 3, 1975, pp. 269–274.

Niggli, P., *Rocks and Mineral Deposits*, W. H. Freeman and Company, San Francisco, CA, p. 559.

Ophori, D. U., and Toth, J., "Patterns of Ground-Water Chemistry, Ross Creek Basin, Alberta, Canada," *Ground Water*, Vol 27, No. 1, 1989, pp. 20–26.

Pionke, H. B., and Urban, J. B., "Effect of Agricultural Land Use on Ground-Water Quality in a Small Pennsylvania Watershed," *Ground Water*, Vol 23, No. 1, 1985, pp. 68–80.

Rhines, F. N., *Phase Diagrams in Metallurgy, Their Development and Application*, McGraw-Hill, New York, NY, 1956, p. 340.

Rogers, R. J., "Geochemical Comparison of Ground Water in Areas of New England, New York, and Pennsylvania," *Ground Water*, Vol 27, No. 5, 1989, pp. 690–712.

Scanlon, B. R., "Physical Controls and Hydrochemical Variability in the Inner Bluegrass Karst Region of Central Kentucky," *Ground Water*, Vol 27, No. 5, 1989, pp. 639–646.

Schwille, F., "Ionenumtausch und der Chemismus von Grundund Mineralwässern," *Z. Dtsch. Geol. Ges.*, Hannover, Vol 106, No. 1, 1955, pp. 16–22.

Seaber, P. R., "Cation Hydrochemical Facies of Ground Water in the Englishtown Formation, New Jersey," *U.S. Geological Survey Prof. Paper 450-B*, 1962, pp. B124–B126.

Stevanović, Z. P., "The Regime of the Quality of Karst Ground Waters in Eastern Serbia—Yugoslavia," *Proceedings of IAH 21st Congress*, Vol XXI, Part 2, International Association of Hydrogeologists, 1988, pp. 1000–1005.

Stuyfzand, P. J., "A New Hydrochemical Classification of Water Types: Principles and Application to the Coastal-Dunes Aquifer System of the Netherlands in Hydrology of Salt Water Intrusion, A Selection of SWIM Papers," *International Contribution to Hydrogeology*, Vol II, International Association of Hydrogeologists, Hannover, 1991, pp. 329–343.

Summers, W. K., and Weber, P. A., "The Relationship of Grain-Size Distribution and Hydraulic Conductivity—An Alternate Approach," *Ground Water*, Vol 22, No. 4, 1984, pp. 474–475.

Tukey, J. W., *Exploratory Data Analysis*, Addison-Wesley, Reading, PA, 1977, p. 688.

Xue, Y., Wu, J., Liu, P., Wang, J., Jiang, Q., and Shi, H., "Sea-Water Intrusion in the Coastal Area of Laizhou Bay, China: 1. Distribution of Sea-Water Intrusion and Its Hydrochemical Characteristics," *Ground Water*, Vol 31, No. 4, 1993, pp. 532–537.

TABLE 1 Water Analysis^A

Cations	mg/L	meq/L	meq %
Na ⁺	8.26	0.3593	5.35
K ⁺	1.17	0.0299	0.45
NH ₄ ⁺	0.12	0.0080	0.10
Ca ²⁺	84.3	4.207	62.69
Mg ²⁺	25.5	2.098	31.26
Fe ^{total}	0.24	0.0086	0.13
Mn ²⁺	0.03	0.0011	0.02
Totals		6.711	100.00
Anions	mg/L	meq/L	meq%
SO ₄ ²⁻	22.2	0.4622	6.87
Cl ⁻	12.8	0.3610	5.37
NO ₃ ⁻	2.61	0.0421	0.62
HCO ₃ ⁻	357.5	5.86	87.13
HPO ₄ ²⁻	0.02	0.0004	0.01
Totals		6.726	100.00
Total hardness		17.7° German units	
Carbonate hardness		16.4° German units	
Non-carbonate hardness		1.3° German units	
(one German unit in degrees = 17.8 mg/L)			
Dissolved solids, evaporated residue = 350.5 mg/L			

^AAnalysis selected from Ref (27).

TABLE 2 Ion Percentages, Anion Coefficient, and Anion Classification^A

	Analysis 1	Analysis 2	Analysis 3	Analysis 4
Anions				
%Cl	5.9	7.25	2.5	48.26
%SO ₄	15.4	33.35	24.0	0.02
%HCO ₃	28.7	9.4	23.5	1.72
Cations				
%Ca	29.5	14.6	23.7	7.8
%Mg	11.3	11.2	18.6	3.5
%Na	9.2	24.2	7.7	38.7
Coefficient of predominate anion	1.3	2.0	0.92	27.8
Anion classification	HCO ₃ -SO ₄	SO ₄	SO ₄ - HCO ₃ -Cl	Cl

^AAnalyses selected from Ref (31).

TABLE 3 Water Chemical Data and Gazda Classification

Chemical Parameters	Analysis 17 ^A	Analysis 56 ^A	Analysis 96 ^A	Analysis 110 ^A
Cations—meq/L (%) Ca	26.2 (35.62)	7.44 (1.97)	0.60 (20.03)	24.6 (1.75)
Sr + Ba + Mn + Fe + Al	0.35 (0.48)	0.53 (0.15)	0.08 (2.51)	4.87 (0.34)
Mg	8.80 (11.96)	2.84 (0.75)	0.25 (8.34)	12.8 (0.91)
Na + K	1.27 (1.74)	170.0 (45.14)	0.57 (19.02)	659.0 (46.82)
Li + NH ₄	0.15 (0.20)	7.49 (1.99)	0.01 (0.10)	2.49 (0.18)
Anions—meq/L (%) Cl	0.08 (0.10)	84.0 (22.02)	0.19 (6.01)	697.0 (49.13)
Br + B + F + NO ₂ + NO ₃	0.04 (0.05)	0.31 (0.09)	0.05 (1.67)	1.84 (0.13)
SO ₄	30.9 (42.30)	0.09 (0.02)	0.11 (3.57)	0.09 (0.01)
HCO ₃	5.50 (7.53)	106.0 (27.83)	1.20 (38.56)	10.4 (0.73)
CO ₃ + HPO ₄ + OH	0.02 (0.02)	0.15 (0.04)	0.01 (0.19)	0.01 (0.00)
Total mg/L	2504	13 754	121	41 646
Classification	17	56	96	110
S1(Cl) NaCl ^B	0.30 %	44.22 %	15.36 %	94.00 %
Remaining Na	1.79 %	25.02 %	11.44 %	0 %
Remaining Cl	0 %	0 %	0 %	2.26 %
S2(Cl) Ca(Mg)Cl ^C	0 %	0 %	0 %	4.52 %
Remaining Ca	48.06 %	2.86 %	30.88 %	0.74 %
Remaining Cl	0 %	0 %	0 %	0 %
S1(SO ₄) NaSO ₄ ^D	3.58 %	0.04 %	7.14 %	0.00 %
Remaining Na	0 %	25.00 %	7.87 %	0 %
Remaining SO ₄	40.51 %	0 %	0 %	0.01 %
S2(SO ₄) + S3 Ca(Mg)SO ₄ ^E	81.02 %	0 %	0 %	0.02 %
Remaining Ca	7.55 %	2.86 %	30.88 %	0.73 %
Remaining SO ₄	0 %	0 %	0 %	0 %
A2 + A3 Ca(Mg)HCO ₃ ^F	15.20 %	5.74 %	61.76 %	1.46 %
Remaining Ca	0 %	0 %	0 %	0 %
Remaining HCO ₃	0 %	25.00 %	7.87 %	0 %
A1 NaHCO ₃ ^G	0 %	50.00 %	15.74 %	0.00 %
Remaining Na	0 %	0 %	0 %	0 %
Remaining HCO ₃	0 %	0 %	0 %	0 %

^AAnalyses from Ref (32).

^BNa includes Na + K + Li + NH₄, and Cl includes Cl + Br + B + F + NO₂ + NO₃.

^CCa includes Ca + Mg + Sr + Ba + Mn + Fe + Al and Cl (see Footnote B).

^DNa (see Footnote B) and SO₄ includes SO₄.

^ECa (see Footnote C), and SO₄(see Footnote D).

^FCa (see Footnote C) and HCO₃ includes HCO₃ + CO₃ + HPO₄ + OH.

^GNa (see Footnote B) and HCO₃(see Footnote G).

TABLE 4 Water Chemistry and D'Amore Classification Parameters^A

	Aquifer 1	Aquifer 2	Aquifer 3	Aquifer 4
Cations—meq/L (%)				
Ca	4.04 (6.7)	1.00 (13.7)	0.15 (1.5)	3.14 (38.7)
Mg	5.92 (9.7)	1.15 (15.8)	0.33 (3.3)	4.11 (50.6)
Na	50.90 (83.6)	5.13 (70.5)	9.44 (95.2)	0.87 (10.7)
Total	60.86	7.28	9.92	8.12
Anions—meq/L (%)				
Cl	25.39 (41.6)	0.31 (4.2)	0.54 (5.3)	0.65 (7.9)
SO ₄	27.90 (45.7)	0.96 (13.2)	2.96 (29.0)	1.31 (15.9)
HCO ₃	7.74 (12.7)	6.03 (82.6)	6.70 (65.7)	6.28 (76.2)
Total	61.03	7.30	10.20	8.24
Parameter A	-33.03	69.45	36.67	60.32
B	-37.91	-57.32	-50.98	5.18
C	42.03	66.22	89.87	2.83
D	73.91	54.67	91.83	-39.90
E	3.68	-53.07	-60.85	13.07
F	-72.00	-56.73	-93.65	27.96

^AAnalyses selected from Ref (60).

TABLE 5 Chemical Constituents of Ground Water Sample as Determined by Laboratory Analyses (After Ref (38))

	Ca ²⁺	Mg ²⁺	Na ⁺	K ⁺	HCO ₃ ⁻	CO ₃ ⁻	SO ₄ ²⁻	Cl ⁻
mg/L	23	4.7	Laboratory Determined Value 35 4.7		171	0	1.0	9.5
Factor	0.04990	0.08229	Multiplied by 0.04350 0.02558		0.01639	0.03333	0.02082	0.02821
meq/L	1.15	0.39	Results 1.52 0.12		2.80	0	0.02	0.27
Percent	36.2	12.2	Plot Value (Ion Percentage) 47.8 3.8		90.6	0	0.7	8.7

TABLE 6 Water Chemistry and Langelier/Ludwig Classification^A

	Analysis 1	Analysis 2	Analysis 3	Analysis 4
Cations—meq/L (%)				
Ca	1.20 (60.3)	1.10 (17.4)	0.12 (11.9)	3.39 (53.9)
Mg	0.34 (17.1)	0.48 (7.6)	0.06 (5.9)	2.14 (34.0)
Na + K	0.25 (12.6)	4.75 (75.0)	0.83 (82.2)	0.76 (12.1)
Total	1.99	6.33	1.01	6.29
Anions—meq/L (%)				
Cl	0.04 (2.3)	1.35 (20.9)	0.42 (38.5)	0.48 (7.6)
SO ₄	0.16 (9.0)	0.16 (2.5)	0.33 (30.3)	2.96 (46.8)
HCO ₃	1.57 (88.7)	4.93 (76.6)	0.34 (31.2)	2.88 (45.6)
Total	1.77	6.44	1.09	6.32
Dissolved solids (mg/L)	107	362	67	398
Classification	A1-1.8	AA-6.5	A3-1.1	B2-6.3

^AAnalysis selected from Ref (42).

TABLE 7 Ion Percentages^A

	Analysis 1	Analysis 2	Analysis 3	Analysis 4
Anions %				
% Cl	3.84	9.88	1.67	7.06
% SO ₄	15.95	76.95	71.66	53.83
% HCO ₃	80.21	13.17	26.67	39.11
Cations %				
% Ca	47.54	65.80	68.13	33.74
% Mg	42.03	26.23	19.62	1.34
% Na + K	10.43	7.97	12.25	64.92
Total concentration (meq/L)	10.06	73.13	33.63	15.78

^AAnalyses selected from Ref (48).

TABLE 8 Ion Percentages, Dissolved Solids, and Free CO₂^A

	Analysis 1	Analysis 2	Analysis 3
Anions %			
% Cl	2.05	20.63	6.50
% SO ₄	2.82	43.11	13.90
% HCO ₃	95.10	36.23	79.50
Cations %			
% Ca	18.50	20.51	50.60
% Mg	11.40	9.41	45.60
% Na + K	68.24	70.24	4.40
Dissolved solids	929	8343	480
Free CO ₂	...	1700	...

^AAnalyses selected from Ref (43).

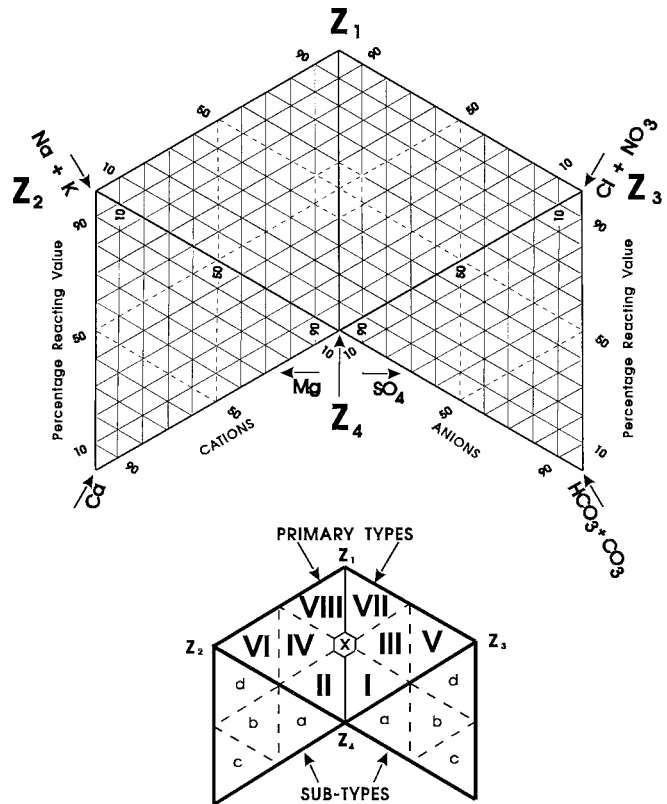

FIG. 1 Geochemical Pattern Diagram (Adapted from Refs (1) and (4))

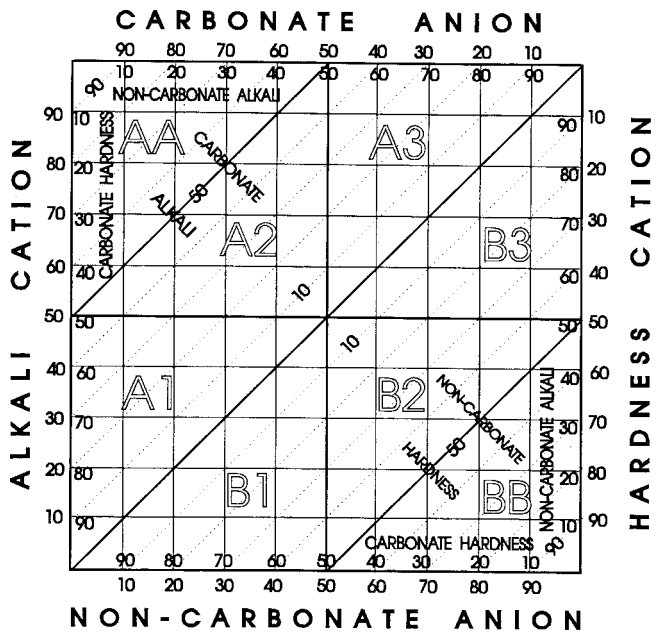

FIG. 2 Water Classification Diagram (Adapted from Ref (4))

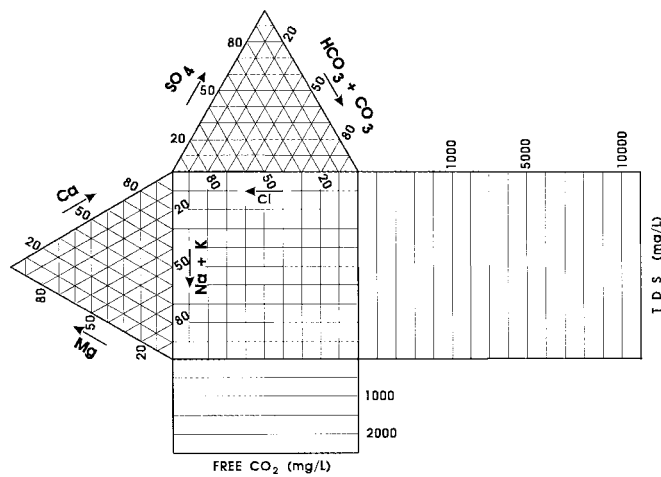

FIG. 4 Water Classification Diagram (Adapted from Ref (7))

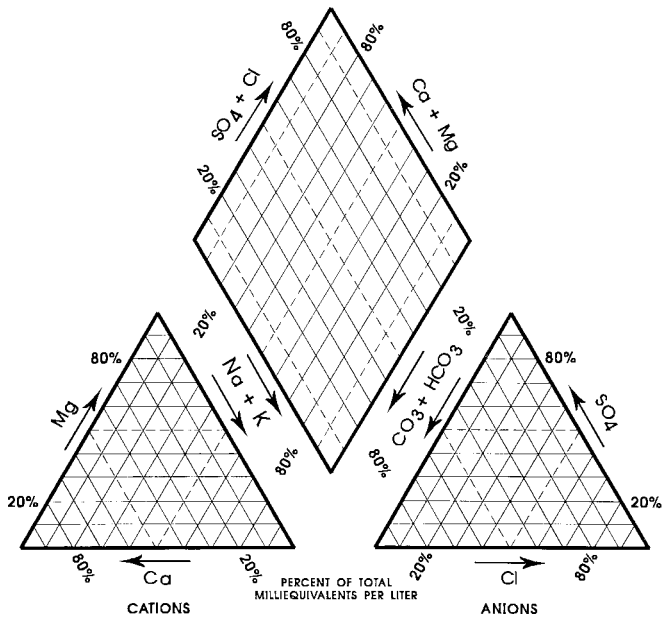

FIG. 3 Water Analysis Diagram (Adapted from Refs (5) and (6))

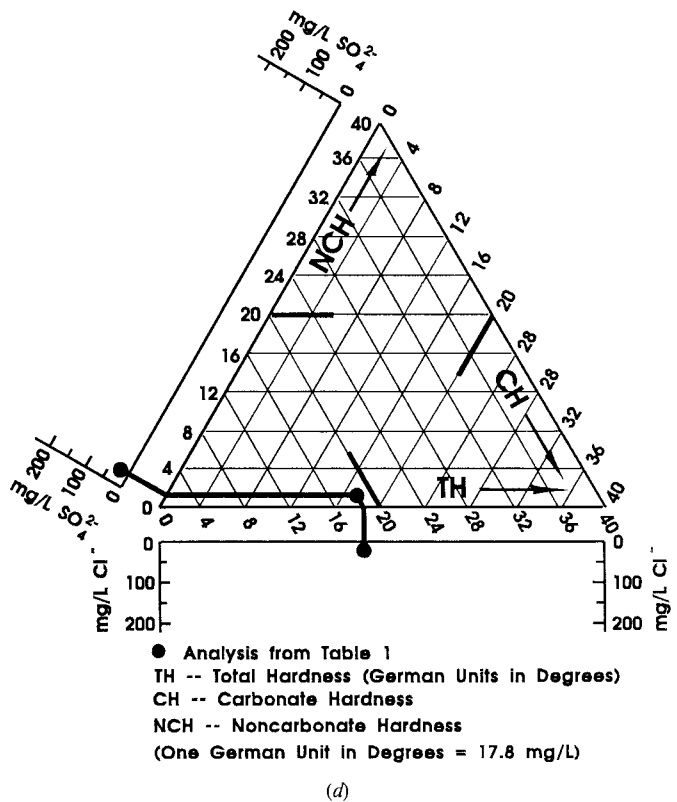
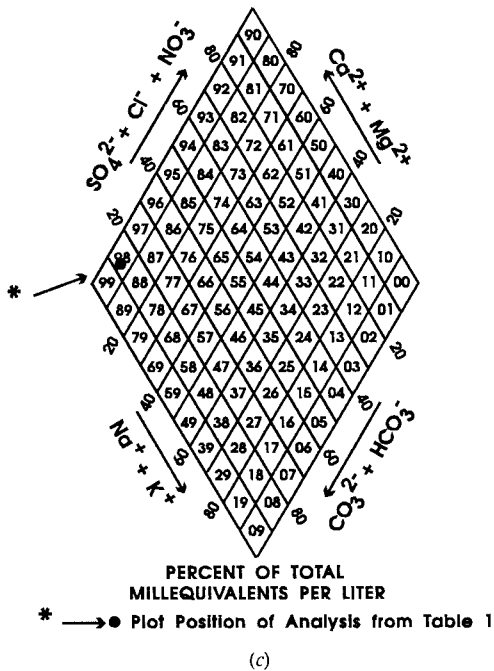
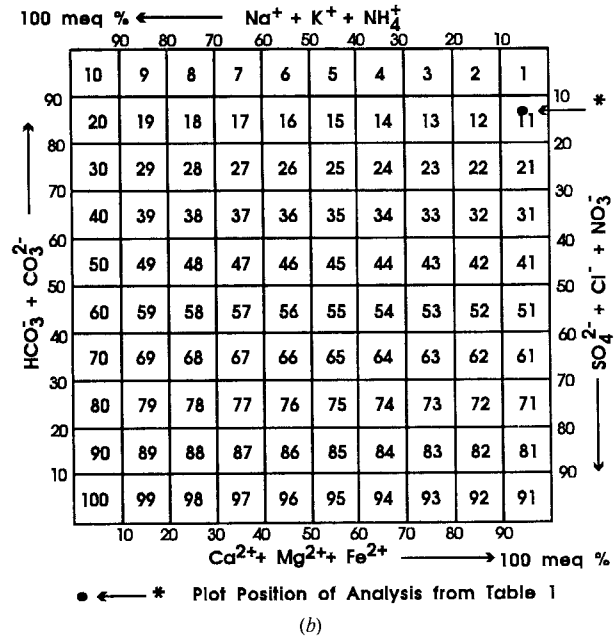
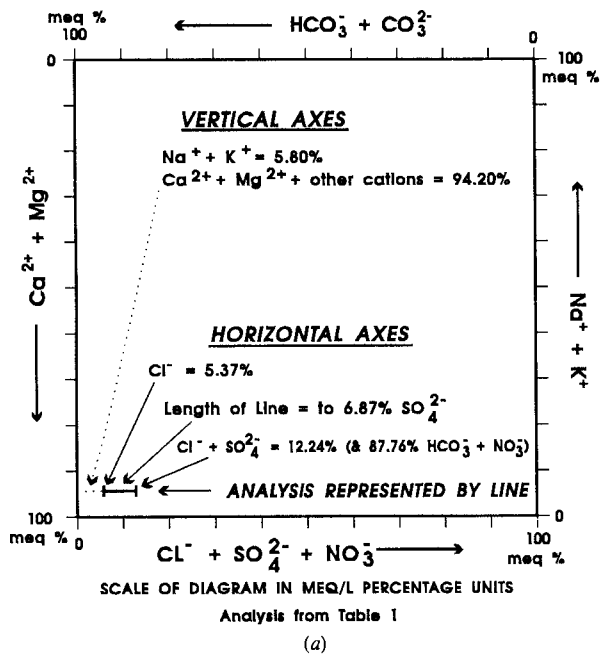
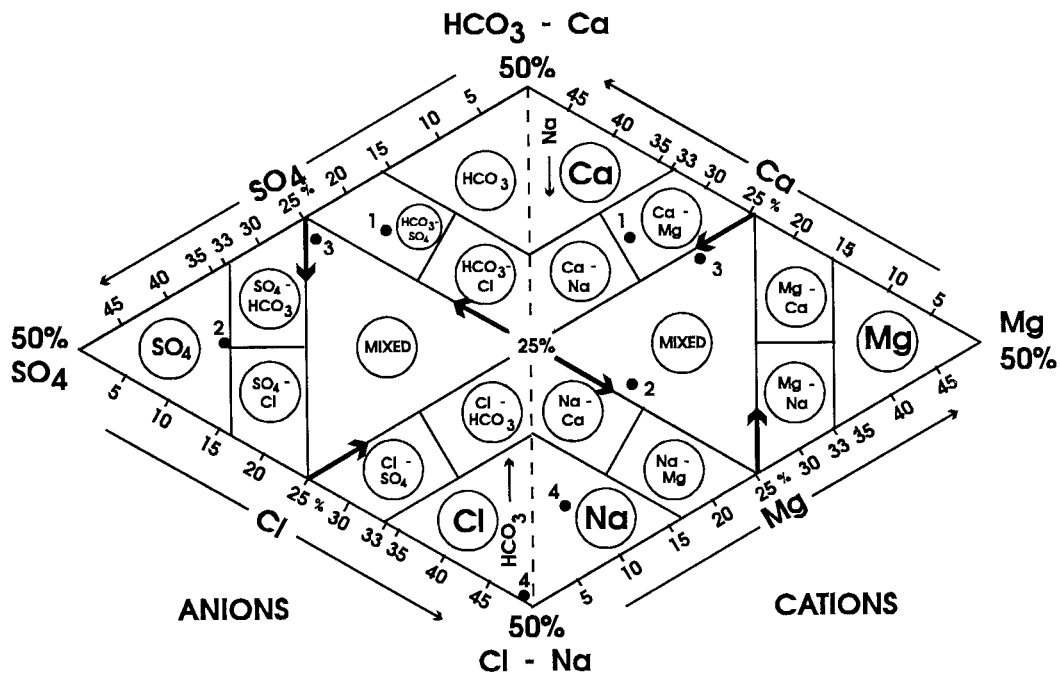

FIG. 5 Examples of Other Coordinate Diagrams: (a) Käss Four Coordinate Diagram, (b) Tolstichen Water-Type Diagram (See Ref (28)), (c) Furtak and Langguth Water-Type Diagram, and (d) Schwille Trilinear Hardness Diagram

D 5754



SCALE OF DIAGRAM IN MEQ/L PERCENTAGE UNITS

● 1, 2, 3, 4 -- ANALYSES FROM TABLE 2

(a)

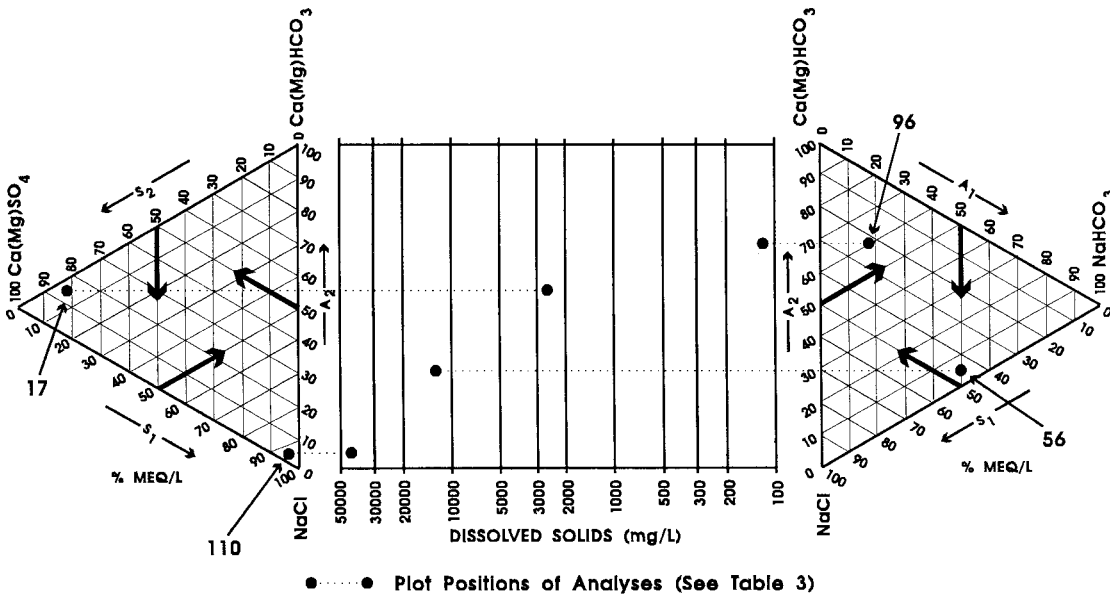

(b)

FIG. 6 Filatov and Gazda Trilinear Diagrams: (a) Filatov Graphical Representation of Water Chemistry (Adapted from Ref (31)), and (b) Gazda Classification Diagram of Chemistry of Mineral Water (Adapted from Ref (32))

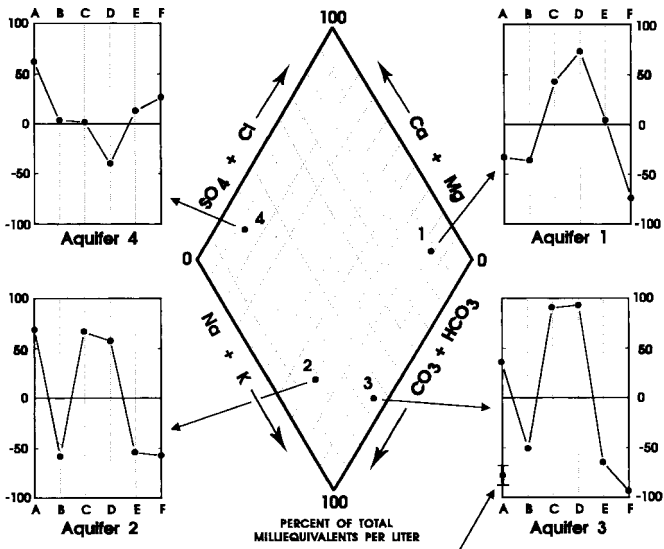

NOTE: Multiple Analyses From A Source Are Shown By The Following Symbol -- I Maximum
Minimum
FIG. 7 D'Amore, et al Classification Diagram (see Table 4 for Plotted Parameters)

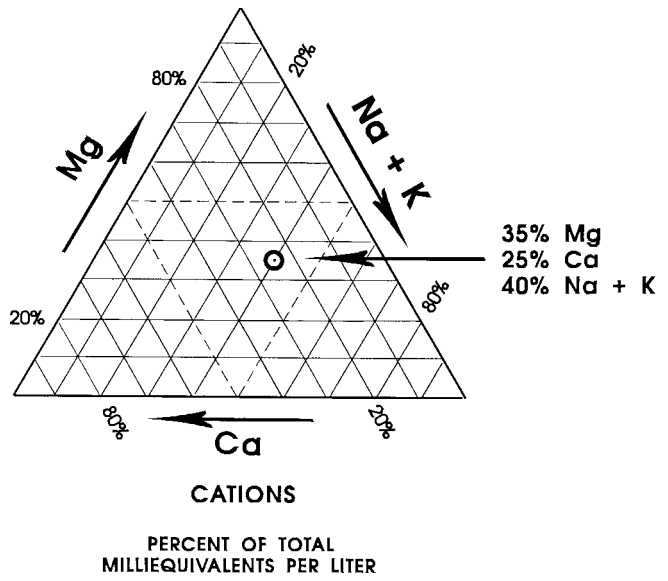

PERCENT OF TOTAL MILLIEQUIVALENTS PER LITER
FIG. 9 Example of Trilinear Plot (Adapted from Refs (5) and (6))

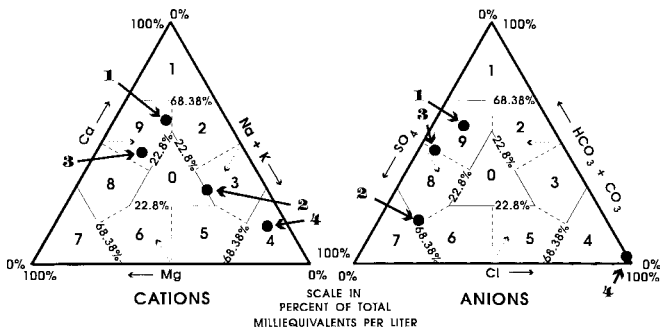

● Plot Position of Analysis from Table 2
Alinement of 50 Percent Unit Line
FIG. 8 Carreno Trilinear Classification Diagram (Adapted from Ref (35))

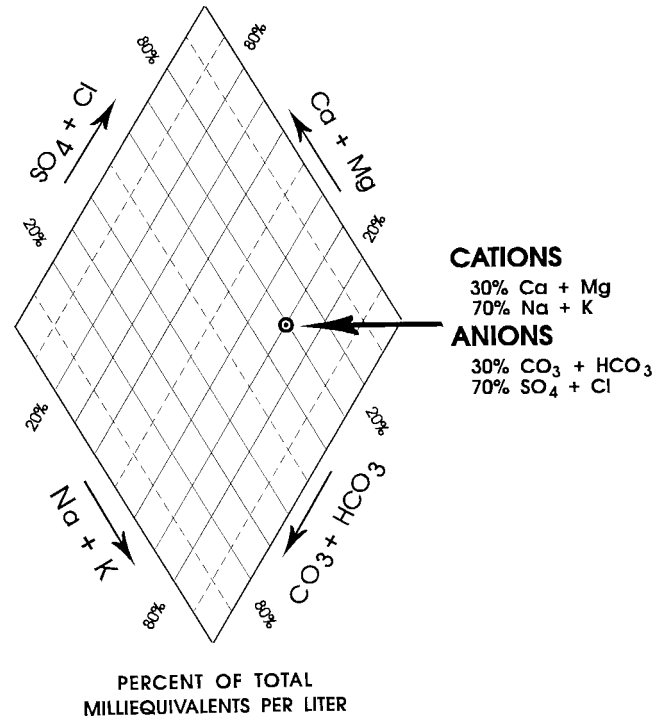

PERCENT OF TOTAL MILLIEQUIVALENTS PER LITER
FIG. 10 Example of Diamond Diagram (Adapted from Refs (5) and (6))

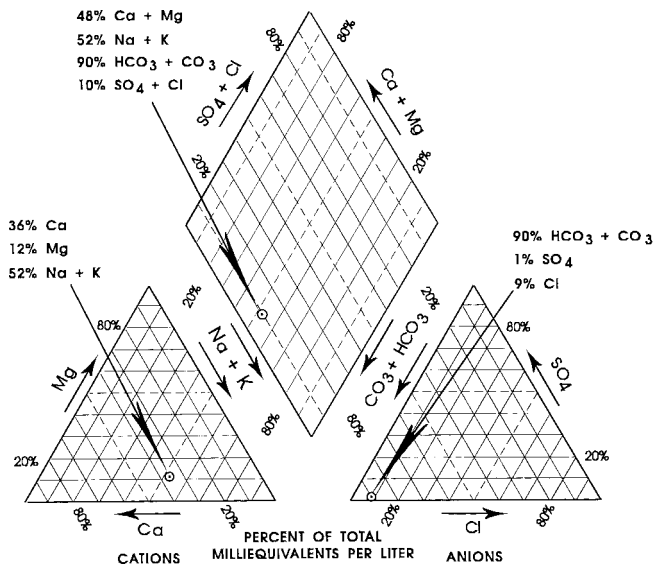

FIG. 11 Example of Water Analysis Diagram (Adapted from Refs (5) and (6))

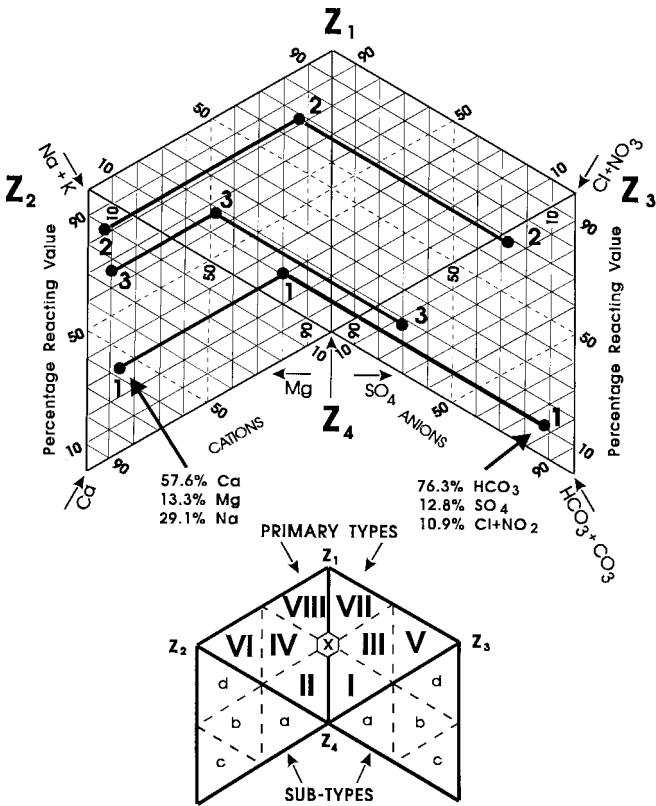
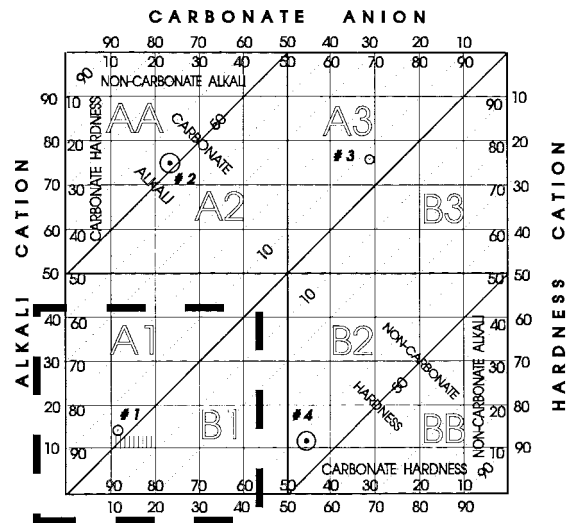

FIG. 12 Example of Hill Geochemical Pattern Diagram (Adapted from Ref (1))



PERCENT OF TOTAL MILLIGRAM EQUIVALENTS PER LITER
(See Table 5 for Analyses)

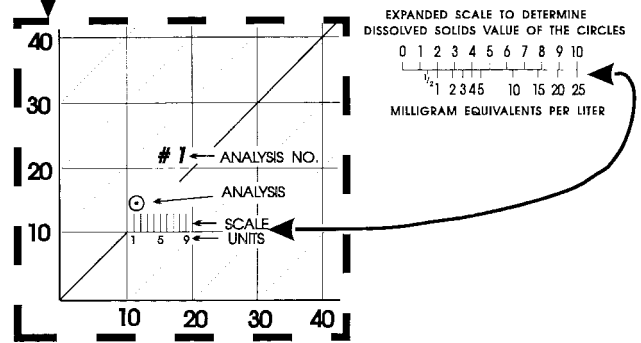
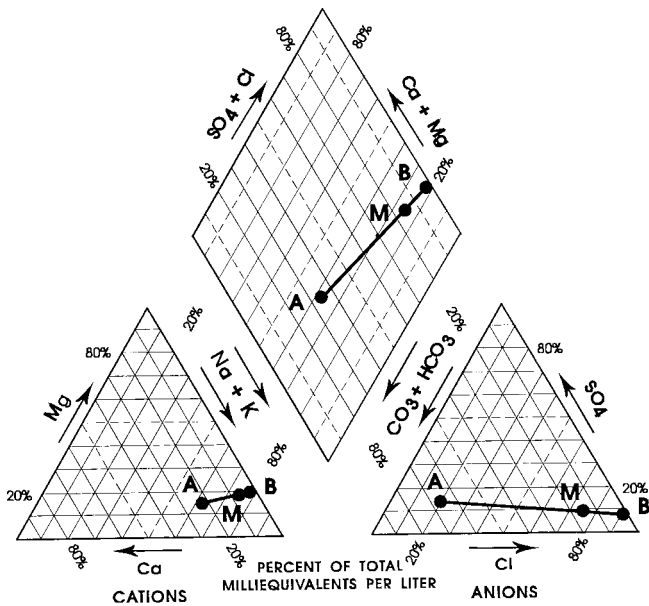

FIG. 13 Example of Water Classification Diagram (Adapted from Ref (4))



HYPOTHETICAL ANALYSES

- A -- Aquifer Water
- B -- Ocean Water
- M -- Mixture of A and B

FIG. 14 Example of Piper Diagram Showing Mixture of Two Parent Waters (Adapted from Ref (5))

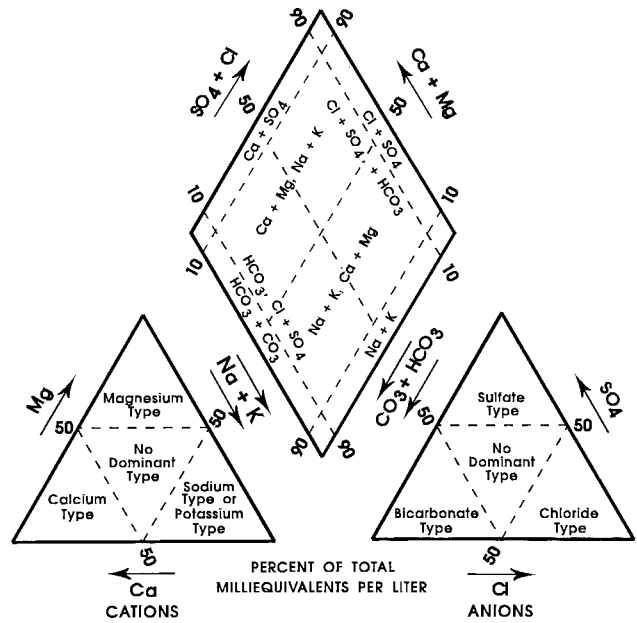
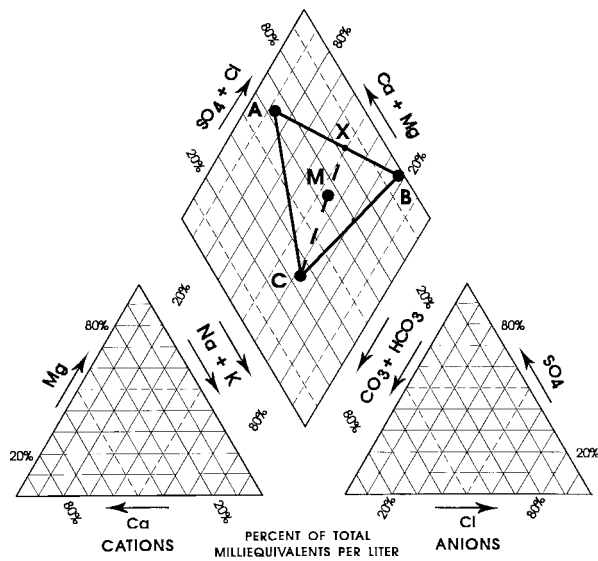

FIG. 16 Piper Diagram Showing Classification of Hydrochemical Facies (Adapted from Ref (47))



HYPOTHETICAL ANALYSES

- A -- Parent Water 1
- B -- Parent Water 2
- C -- Parent Water 3
- M -- Mixture of Parent Waters 1, 2, and 3
- X -- Theoretical Mixture of Parent Waters 1 and 2

FIG. 15 Example of Piper Diagram Showing Mixture of Three Parent Waters (Adapted from Ref (5))

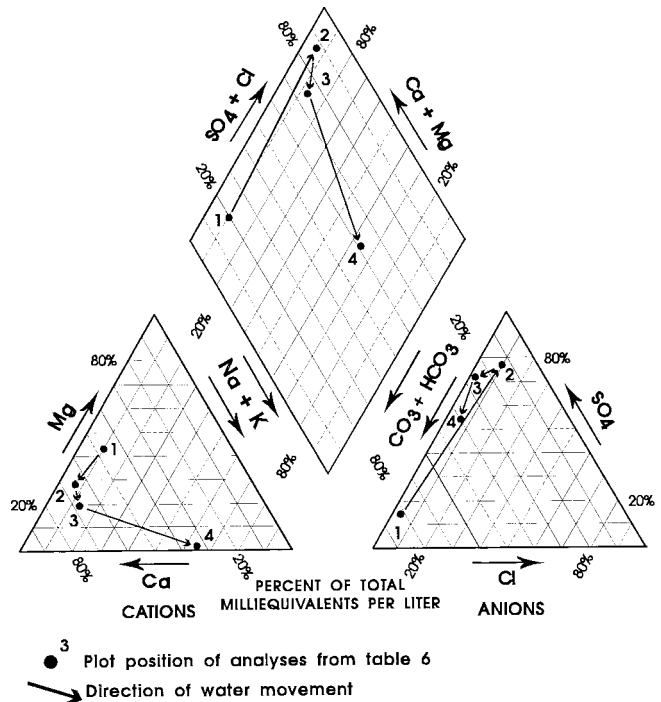

- 3 Plot position of analyses from table 6
- Direction of water movement

FIG. 17 Example of Piper Diagram Showing Chemical Changes from Recharge (1) to Discharge Area (4) (Adapted from Ref (48))

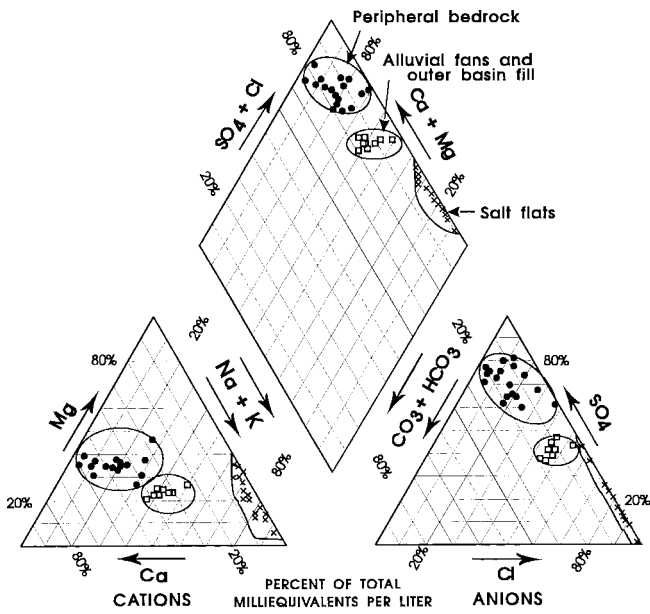

Source of Analyses (Note: Analyses Not Included With Standard)

- Peripheral bedrock
- Alluvial fans and outer basin fill
- × Salt flats

FIG. 18 Example of Piper Diagram with Water Source Symbols (Adapted from Ref (51)) and Enclosed Water Areas (Adapted from Ref (60))

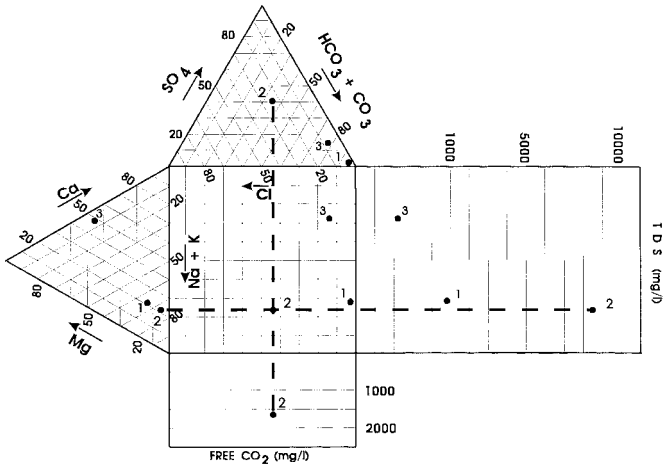

• Plot positions of analyses from table 7

FIG. 19 Example of Durov Water Classification Diagram (Adapted from Ref (43))

 **D 5754**

The American Society for Testing and Materials takes no position respecting the validity of any patent rights asserted in connection with any item mentioned in this standard. Users of this standard are expressly advised that determination of the validity of any such patent rights, and the risk of infringement of such rights, are entirely their own responsibility.

This standard is subject to revision at any time by the responsible technical committee and must be reviewed every five years and if not revised, either reapproved or withdrawn. Your comments are invited either for revision of this standard or for additional standards and should be addressed to ASTM Headquarters. Your comments will receive careful consideration at a meeting of the responsible technical committee, which you may attend. If you feel that your comments have not received a fair hearing you should make your views known to the ASTM Committee on Standards, at the address shown below.

This standard is copyrighted by ASTM, 100 Barr Harbor Drive, PO Box C700, West Conshohocken, PA 19428-2959, United States. Individual reprints (single or multiple copies) of this standard may be obtained by contacting ASTM at the above address or at 610-832-9585 (phone), 610-832-9555 (fax), or service@astm.org (e-mail); or through the ASTM website (www.astm.org).