



# Standard Test Method for Determination of Benzene and Toluene in Finished Motor and Aviation Gasoline by Gas Chromatography<sup>1</sup>

This standard is issued under the fixed designation D3606; the number immediately following the designation indicates the year of original adoption or, in the case of revision, the year of last revision. A number in parentheses indicates the year of last reapproval. A superscript epsilon ( $\epsilon$ ) indicates an editorial change since the last revision or reapproval.

<sup>ε</sup><sup>1</sup> NOTE—Subsection 1.3 and Note 7 were corrected editorially in April 2016.

## 1. Scope\*

1.1 This test method covers the determination of benzene and toluene in finished motor and aviation gasolines by gas chromatography.

1.2 Benzene can be determined between the levels of 0.1 and 5 volume % and toluene can be determined between the levels of 2 and 20 volume %.

1.3 The precision for this test method was determined using conventional gasoline as well as gasolines containing oxygenates (ethers such as methyl *tert*-butyl ether, ethyl *tert*-butyl ether, *tert*-amyl methyl ether, and ethanol).

1.4 Methanol may cause interference. Appendix X1 provides an option for modifying the test method for analyzing samples containing ethanol.

1.5 The values stated in SI units are to be regarded as standard. The values given in parentheses are for information only.

1.6 *This standard does not purport to address all of the safety concerns, if any, associated with its use. It is the responsibility of the user of this standard to establish appropriate safety and health practices and determine the applicability of regulatory limitations prior to use.*

## 2. Referenced Documents

2.1 *ASTM Standards*:<sup>2</sup>

D4057 Practice for Manual Sampling of Petroleum and Petroleum Products

E694 Specification for Laboratory Glass Volumetric Apparatus

<sup>1</sup> This test method is under the jurisdiction of ASTM Committee D02 on Petroleum Products, Liquid Fuels, and Lubricants and is the direct responsibility of Subcommittee D02.04.0L on Gas Chromatography Methods.

Current edition approved Oct. 1, 2010. Published November 2010. Originally approved in 1977. Last previous edition approved in 2007 as D3606–07. DOI: 10.1520/D3606-10E01.

<sup>2</sup> For referenced ASTM standards, visit the ASTM website, www.astm.org, or contact ASTM Customer Service at service@astm.org. For *Annual Book of ASTM Standards* volume information, refer to the standard's Document Summary page on the ASTM website.

E969 Specification for Glass Volumetric (Transfer) Pipets  
E1044 Specification for Glass Serological Pipets (General Purpose and Kahn)  
E1293 Specification for Glass Measuring Pipets

## 3. Summary of Test Method

3.1 An internal standard, methyl ethyl ketone (MEK), is added to the sample which is then introduced into a gas chromatograph equipped with two columns connected in series. The sample passes first through a column packed with a nonpolar phase such as dimethylpolysiloxane (8.1.1) which separates the components according to boiling point. After octane has eluted, the flow through the nonpolar column is reversed, flushing out the components heavier than octane. The octane and lighter components then pass through a column packed with a highly polar phase such as 1, 2, 3-tris(2-cyanoethoxy) propane (8.1.2) which separates the aromatic and nonaromatic compounds. The eluted components are detected by a thermal conductivity detector. The detector response is recorded, the peak areas are measured, and the concentration of each component is calculated with reference to the internal standard.

## 4. Significance and Use

4.1 Benzene is classed as a toxic material. A knowledge of the concentration of this compound can be an aid in evaluating the possible health hazard to persons handling and using the gasoline. This test method is not intended to evaluate such hazards.

## 5. Apparatus

5.1 *Chromatograph*—Any chromatographic instrument that has a backflush system and thermal conductivity detector, and that can be operated at the conditions given in Table 1, can be employed. Two backflush systems are shown. Fig. 1 is a pressure system and Fig. 2 is a switching valve system. Either one can be used.

\*A Summary of Changes section appears at the end of this standard

**TABLE 1 Instrument Parameters**

Detector	thermal conductivity
Columns:	two, stainless steel
Length, m	(A) 0.8; (B) 4.6
Outside diameter, mm	3.2
Stationary phase	(A) dimethylpolysiloxane, 10 mass % (B) TCEP, 20 mass %
Support	(A) Chromosorb W, 60 to 80-mesh (B) Chromosorb P, 80 to 100-mesh
Reference column	Any column or restriction may be used.
Temperature:	
Sample inlet system, °C	200
Detector, °C	200
Column, °C	145
Carrier Gas:	helium
Linear Gas Rate, cm/s	6
Volume flow rate, cm <sup>3</sup> /min	approximately 30
Column head pressure, kPa (psi)	approximately 200 (30)
Recorder range, mV	0 to 1
Chart speed, cm/min	1
Sample size, µL	2
Total cycle time, min	8
Backflush, min	approximately 0.75 <sup>4</sup>

<sup>4</sup> This back flush time must be determined for each column system.

## 5.2 Columns:

5.2.1 *Column A*—One 0.8 m (2.5 ft) by 3.2 mm ( $\frac{1}{8}$  in.) outside diameter stainless steel column packed with 10 mass % dimethylpolysiloxane (for example, OV-101) on Chromosorb W, 60 to 80 mesh.

5.2.2 *Column B*—One 4.6 m (15 ft) by 3.2 mm outside diameter stainless steel column packed with 20 mass % TCEP on Chromosorb P, 80 to 100 mesh.

5.3 *Recorder*—a strip chart recorder. An electronic integrating device or a computer capable of graphical presentation of the chromatogram. The electronic integrating device or computer must be capable of measuring 0.1 volume % MEK with satisfactory signal-to-noise. If a strip chart recorder is to be used, a 0 mV to 1 mV range recording potentiometer with a response time of 2 s or less and a maximum noise level of  $\pm 0.3$  % of full scale is recommended. The detector strip chart recorder combination must produce a 4 mm deflection for a 2 µL sample containing 0.1 volume % MEK when operated at maximum sensitivity.

5.4 *Microsyringe*—5 µL capacity.

5.5 *Volumetric Pipets, Class A*—0.5, 1, 5, 10, 15, and 20 mL capacities (see Specification E694 and E969).

5.6 *Measuring Pipets*—1 mL and 2 mL capacities calibrated in 0.01 mL; 5 mL calibrated in 0.1 mL, for use in dispensing volumes of benzene and toluene not covered by the volumetric pipets (see Specification E1044 and E1293) during preparation of standard samples (see 11.1).

NOTE 1—Other volume dispensing equipment capable of delivering the specified volumes within the stated tolerance limits may be used as an alternative to the requirements stated in 5.5 and 5.6.

5.7 *Flasks*—volumetric, 25 mL and 100 mL capacity.

5.8 *Vibrator*—electric.

5.9 *Vacuum Source*.

5.10 *Evaporator*—vacuum, rotary.

5.11 *Flask*—boiling, round-bottom, short-neck, with  $2\frac{3}{4}$  standard taper joint, 500 mL capacity. Suitable for use with evaporator (5.10).

5.12 *Lamp*—infrared.

5.13 *Burets*—automatic, with integral reservoir, 25 mL capacity.

## 6. Materials

6.1 *Carrier Gas*—Helium, 99.99 % pure. (**Warning**—Compressed gas under high pressure.)

6.2 *Support*—Crushed firebrick, acid-washed, 60 to 80-mesh and 80 to 100-mesh.

6.3 *Liquid Phases*—1, 2, 3-Tris(2-cyanoethoxy) propane (TCEP) and methyl silicone.<sup>3</sup>

6.4 *Solvents*:

6.4.1 *Methanol*—reagent grade. (**Warning**—Flammable. Vapor harmful. Can be fatal or cause blindness if swallowed or inhaled.)

6.4.2 *Chloroform*—reagent grade. (**Warning**—Can be fatal if swallowed. Harmful if inhaled.)

6.4.3 *Methylene Chloride*—for cleaning columns. (**Warning**—Harmful if inhaled. High concentrations can cause unconsciousness or death.)

6.4.4 *Acetone*—for cleaning columns. (**Warning**—Extremely flammable. Vapors can cause flash fires.)

6.5 *Internal Standard*:

6.5.1 *Methyl Ethyl Ketone (MEK)*—99.5% minimum purity. (**Warning**—Flammable. Vapor can be harmful.)

6.6 *Calibration Standards*—

6.6.1 *Benzene*—99+ mol %. (**Warning**—Poison. Carcinogen. Harmful or fatal if swallowed. Extremely flammable. Vapors can cause flash fires.)

6.6.2 *Isooctane (2,2,4-trimethyl pentane)*—99+ mol %. (**Warning**—Extremely flammable. Harmful if inhaled.)

6.6.3 *Toluene*—(**Warning**—Flammable. Vapor harmful.)

6.6.4 *n-Nonane*—99+ mol %. (**Warning**—Flammable. Vapor harmful.)

## 7. Sampling

7.1 *Gasoline*—(**Warning**—Extremely flammable. Vapors harmful if inhaled.) Samples to be analyzed by this test method shall be obtained using the procedures outlined in Practice D4057.

## 8. Preparation of Column Packings

8.1 Prepare two packing materials (one packing material consists of 10 mass % dimethylpolysiloxane on Chromosorb W; the other, 20 mass % TCEP on Chromosorb P) in accordance with the following procedures:

8.1.1 *Dimethylpolysiloxane Packing*—Weigh 45 g of the Chromosorb W, 60 to 80 mesh and pour into the 500 mL flask

<sup>3</sup> Packed column liquid phases such as OV 101 are considered to be of the dimethylpolysiloxane type. Other equivalent phases can also be used. Consult with the column manufacturer or phase supplier for information.

A. PIPING AND INSTRUMENTATION

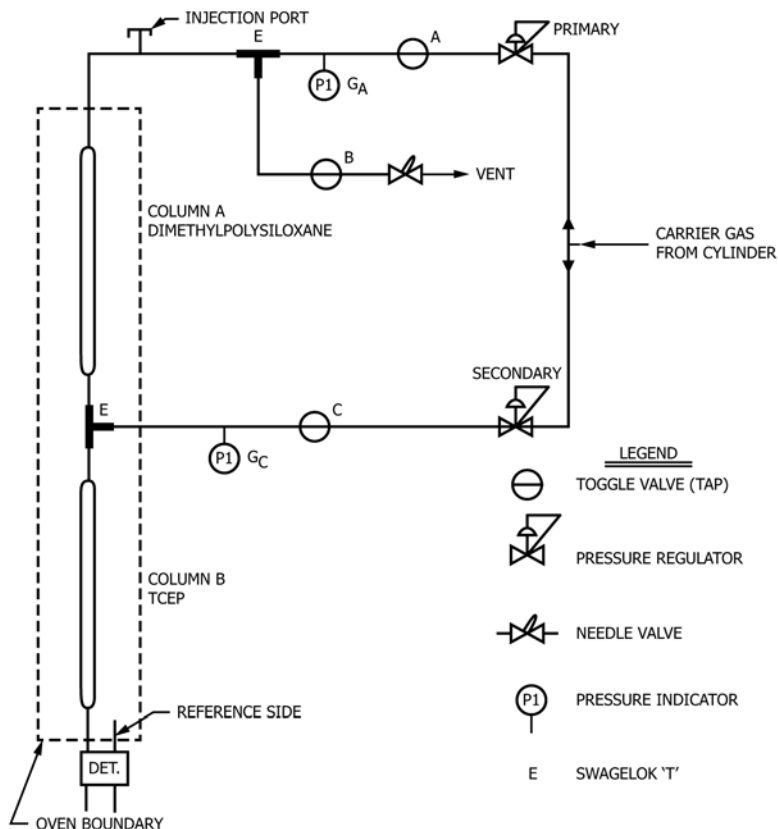

B. FLOW SWITCHING SYSTEM

1. FORWARD FLOW

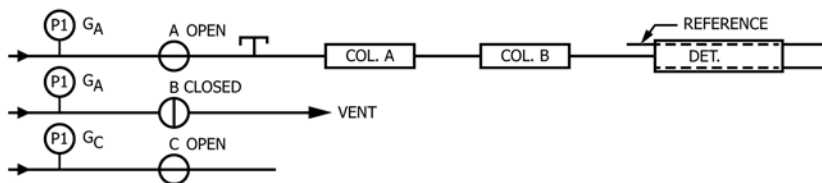

2. BACKFLUSH

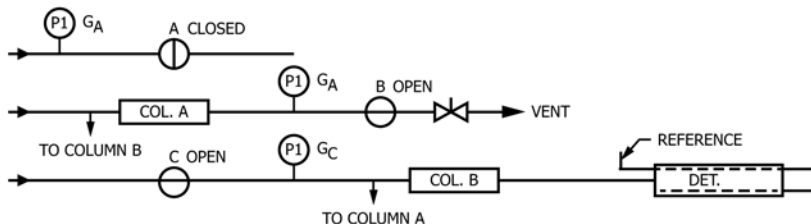

FIG. 1 Pressure Backflush

(5.11). Dissolve 5 g of the dimethylpolysiloxane in approximately 50 mL of chloroform. (**Warning**—Can be fatal if swallowed. Harmful if inhaled.) Pour the methyl silicone-chloroform solution into the flask containing the Chromosorb W. Attach the flask to the evaporator (5.10), connect the

vacuum, and start the motor. Turn on the infrared lamp and allow the packing to mix thoroughly until dry.

8.1.2 *1, 2, 3-Tris(2-cyanoethoxy) Propane (TCEP) Packing*—Weigh 80 g of Chromosorb P, 80 to 100 mesh and pour into the 500 mL flask (5.11). Dissolve 20 g of TCEP in

A. PIPING AND INSTRUMENTATION

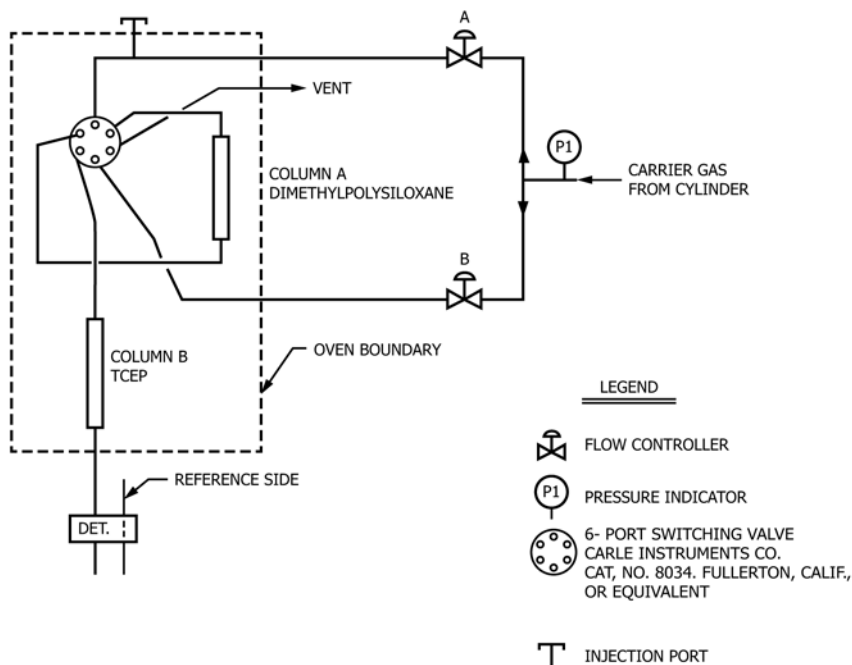

B. FLOW SWITCHING SYSTEM

1. FORWARD FLOW

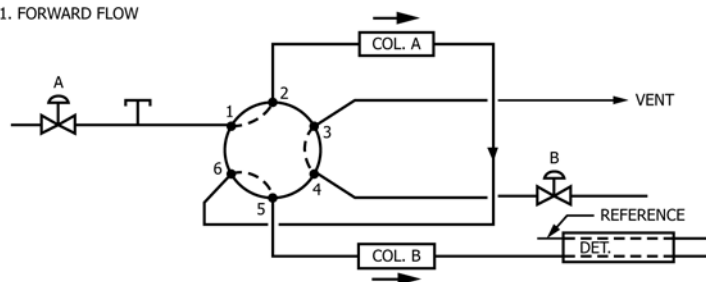

2. BACKFLUSH

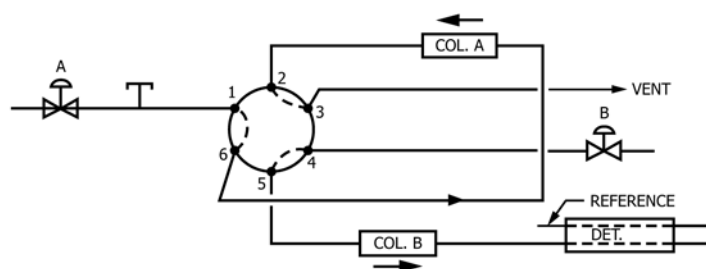

FIG. 2 Valve Backflush

200 mL of methanol and pour into the flask containing the Chromosorb P. Attach the flask to the evaporator (5.10), connect the vacuum, and start the motor. Turn on the infrared lamp and allow the packing to mix thoroughly until dry. (Do not heat the packing over 180 °C.)

9. Preparation of Column

9.1 *Cleaning Column*—Clean the stainless steel tubing as follows. Attach a metal funnel to one end of the steel tubing.

Hold or mount the stainless steel tubing in an upright position and place a drain beaker under the outlet end of the tubing. Pour about 50 mL of methylene chloride (**Warning**—Harmful if inhaled. High concentrations can cause unconsciousness or death) into the funnel and allow it to drain through the steel tubing and into the drain beaker. Repeat the washing procedure with 50 mL of acetone. (**Warning**—Harmful if inhaled. High concentrations can cause unconsciousness or death.) Remove the funnel and attach the steel tubing to an air line, using vinyl

tubing to make the connection. Remove all solvent from the steel tubing by blowing filtered, oil-free air through or pulling a vacuum.

**9.2 Packing Columns**—Preform Columns A and B separately to fit the chromatograph. Pack the 0.8 m tubing (Column A) with the dimethylpolysiloxane packing (8.1.1) and the 4.6 m tubing (Column B) with the TCEP packing (8.1.2) using the following procedure. Close one end of each tubing with a small, glass wool plug, and connect this end to a vacuum source by means of a glass wool-packed tube. To the other end connect a small polyethylene funnel by means of a short length of vinyl tubing. Start the vacuum and pour the appropriate packing into the funnel until the column is full. While filling each column, vibrate the column with the electric vibrator to settle the packing. Remove the funnel and shut off the vacuum source. Remove the top 6 mm (1/4 in.) of packing and insert a glass wool plug in this end of the column.

## 10. Configuration of Apparatus and Establishment of Conditions

**10.1 Conditioning Column**—Install Columns A and B as shown in Fig. 1 or Fig. 2 in accordance with the system preferred (5.1). Do not connect the exit end of Column B to the detector until the columns have been conditioned. Pass helium gas through the column at approximately 40 cm<sup>3</sup>/min. Condition the column at the listed temperatures for the specified time periods.

Temperature, °C	Hours at Temperature
50	1/2
100	1/2
150	1
170	3

**10.2 Assembly**—Connect the outlet of Column B to the detector port. Adjust the operating conditions to those listed in Table 1, but do not turn on the detector circuits. Check the systems for leaks.

### 10.3 Flow Rate Adjustment:

**10.3.1 Column System Setup for Pressure Backflushing (Fig. 1):**

**10.3.1.1** Open Tap A and B and close C; set the primary pressure regulator to give the desired flow (Table 1) through the column system (at an approximate gage pressure of 205 kPa (30 psi)). Measure the flow rate at the detector vent, sample side. Observe the pressure on gage G<sub>C</sub>.

**10.3.1.2** Close Tap A and open B and C. The pressure reading on gage G<sub>A</sub> should fall to zero immediately. If not, open the needle valve until the pressure falls to zero.

**10.3.1.3** Close Tap B. Adjust the secondary pressure regulator until the reading of gage G<sub>C</sub> is 3.5 kPa to 7 kPa (0.5 psi to 1 psi) higher than observed in 10.3.1.1.

**10.3.1.4** Open Tap B and adjust the backflush vent control needle valve until the pressure recorded on G<sub>A</sub> approximates a gage pressure of 14 kPa to 28 kPa (2 to 4 psi).

**10.3.1.5 Forward Flow**—Open Taps A and C and close Tap B (Fig. 1 B1).

**10.3.1.6 Backflush**—Close Tap A and open Tap B. (There should be no baseline shift on switching from forward flow to

backflush. If there is a baseline shift increase the secondary pressure slightly.) (Fig. 1)

**10.3.2 Column System Setup for Valve Backflushing (Fig. 2):**

**10.3.2.1** Set the valve in the forward flow mode (Fig. 2 B1), and adjust flow control A to give the desired flow (Table 1). Measure the flow rate at the detector vent, sample side.

**10.3.2.2** Set the valve in the backflush position (Fig. 2 B2), measure the flow rate at the detector vent, sample side. If the flow has changed, adjust flow control B to obtain the correct flow. (Flows should match to within ±1 cm<sup>3</sup>/min).

**10.3.2.3** Change the valve from forward flow to the backflush position several times and observe the baseline. There should be no baseline shift or drift after the initial valve kick that results from the pressure surge. If there is a baseline shift, increase or decrease flow control B slightly to balance the baseline. (A persistent drift could indicate leaks somewhere in the system.)

**10.4 Determine Time to Backflush**—The time to backflush will vary for each column system and must be determined experimentally as follows. Prepare a mixture of 5 volume % isooctane in n-nonane. Using the injection technique described in 11.4 and with the preferred system (10.3) in the forward flow mode, inject 1 μL of the isooctane – n-nonane mixture. Allow the chromatogram to run until the n-nonane has eluted and the detector signal has returned to baseline. Measure the time in seconds, from the injection until the detector signal returns to baseline between the isooctane and n-nonane peaks. At this point all of the isooctane, but essentially none of the n-nonane, should have eluted. One half of the time determined should approximate the “time to backflush” and should be from 30 s to 60 s. Repeat the run, including the injection, but switching the system to the backflush mode at the predetermined “time to backflush.” This should result in a chromatogram of isooctane with little or no n-nonane visible. If necessary, make additional runs, adjusting the “time to backflush” until this condition of all the iso octane and little or no n-nonane is attained. The “time to backflush” so established, including the actual valve operations, must be used in all subsequent calibrations and analyses.

## 11. Calibration and Standardization

**11.1 Standard Samples**—Prepare seven standard samples covering the range 0 to 5 volume % benzene and 0 to 20 volume % toluene as follows: For each standard, measure the volume of benzene and of toluene listed below into a 100 mL volumetric flask. Dilute to volume with isooctane (2,2,4-trimethyl pentane), with all components and glassware at ambient temperature.

Benzene		Toluene	
Volume %	mL	Volume %	mL
5	5.0	20	20.0
2.5	2.5	15	15.0
1.25	1.25	10	10.0
0.67	0.67	5	5.0
0.33	0.33	2.5	2.50
0.12	0.12	1	1.0
0.06	0.06	0.5	0.50

**11.2 Calibration Blends**—Accurately measure 1.0 mL of MEK into a 25 mL volumetric flask, and fill to the mark with

the first standard sample (11.1). Continue doing this until all blends have been prepared.

NOTE 2—Commercially prepared calibration standards may be used, including those that are pre-mixed with the MEK internal standard.

11.3 *Chromatographic Analysis*—Chromatograph each of the calibration blends using the conditions established in 10.4 using the following injection technique:

11.4 *Injection of Sample:*

11.4.1 Use of an automatic liquid sample injection system is highly recommended. If manual injections are to be made, the injection technique in 11.4.2 is necessary so that sharp symmetrical peaks will be obtained.

11.4.2 Flush the 5 µL microsyringe at least three times with the sample mixture and then fill with about 3 µL of the sample. (Avoid including any air bubbles in the syringe.) Slowly eject the sample until 2.0 µL remains in the syringe; wipe the needle with tissue and draw back the plunger to admit 1 µL to 2 µL of air into the syringe. Insert the needle of the syringe through the septum cap of the chromatograph and push until the barrel of the syringe is resting against the septum cap; then push the plunger to the hilt and remove the syringe immediately from the chromatograph.

11.5 *Calibration*—Measure the area of both aromatic peaks and of the internal standard peak as directed in 12.4. Calculate the ratio of the benzene peak area to the MEK peak area. Plot the concentration of benzene versus the ratio. Make the same calculation and plot for toluene. See Fig. 3 for an example. This must be done to ensure that the entire chromatographic system is operating properly and that the concentration of any one component has not exceeded the linear response range of any

part of the system: column, detector, integrator, and other components. The calibration should be linear.

NOTE 3—Calibrations using computer-based chromatography systems are an acceptable alternative to the calibration procedure specified in 11.5.

NOTE 4—If the calibration has been shown to be linear, a least squares calculation may be performed to calculate a calibration factor. The precision statement in Section 15 was developed from data obtained from calibration plots and may not apply if calibration factors are used.

12. Procedure

12.1 *Preparation of Sample*—Accurately measure 1.0 mL of MEK into a 25 mL volumetric flask. Fill to the mark with the sample to be tested and mix well.

12.2 *Chromatographic Analysis*—Chromatograph the sample, using the conditions established in 10.4 “time to backflush” and the injection technique described in 11.4. The valves must be turned to *backflush* mode at the time determined in 10.4 so that undesirable components do not enter Column B.

12.3 *Interpretation of Chromatogram*—Identify on the chromatogram the benzene, toluene, and the internal standard MEK peaks from the retention times of the standards.

NOTE 5—The order of elution will be nonaromatic hydrocarbons, benzene, MEK, and toluene using the prescribed dimethylpolysiloxane and TCEP. Fig. 4 is an example of a typical chromatogram.

12.4 *Measurement of Area*—Measure the areas under the aromatic peaks and under the MEK peak by conventional methods.

NOTE 6—The precision statement in Section 15 was developed from data obtained using electronic integrators or on-line computers. The precision statement may not apply if other methods of integration or peak area measurement are used.

13. Calculation

13.1 Calculate the ratios of the peak areas of benzene and toluene to the peak area of MEK. Determine from the appropriate calibration curve the liquid volume percent of benzene and toluene corresponding to the calculated peak ratios.

13.2 If the results are desired on a mass basis, convert to mass percent as follows:

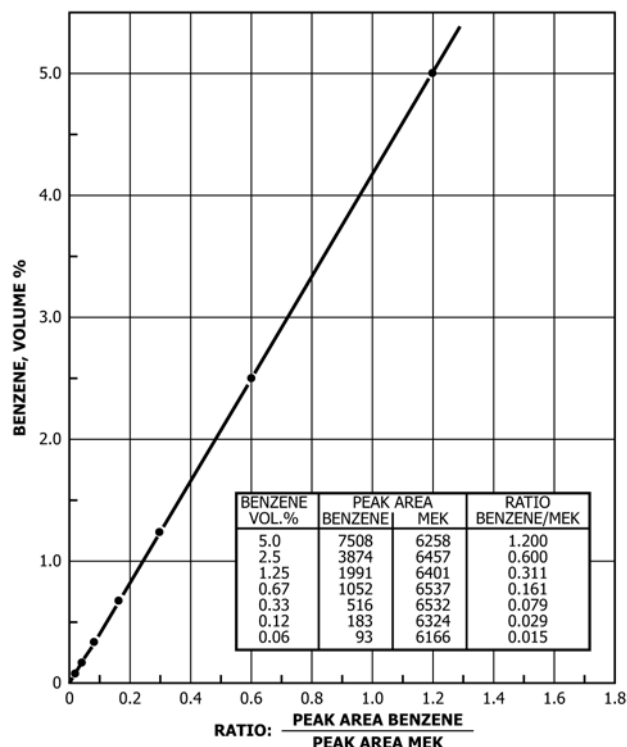

FIG. 3 Typical Calibration Curve for Benzene (Determine for Each Analytical System)

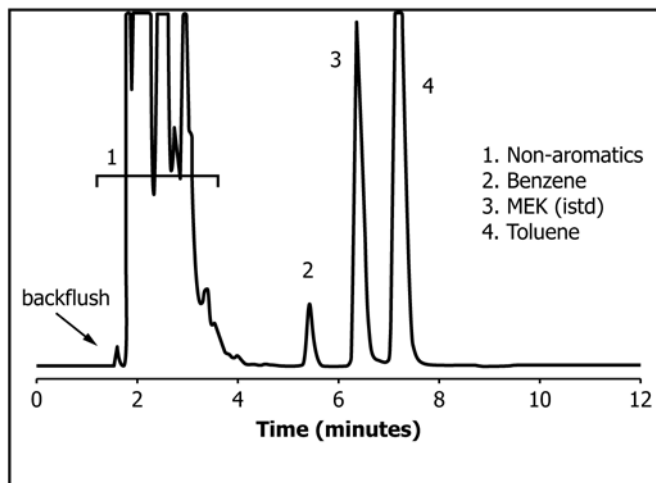

FIG. 4 Typical Chromatogram

$$\text{Benzene, mass \%} = (V_B/D) \times 0.8844 \quad (1)$$

where:

$V_B$  = volume percent benzene, and  
 $D$  = relative density of sample at 15.6/15.6 °C (60/60 °F).

$$\text{Toluene, mass \%} = (V_T/D) \times 0.8719 \quad (2)$$

where:

$V_T$  = volume percent toluene, and  
 $D$  = relative density of sample at 15.6/15.6 °C (60/60 °F).

## 14. Report

14.1 Report the benzene and toluene contents in liquid volume percent to the nearest 0.01 %.

## 15. Precision and Bias

15.1 The following criteria should be used for judging the acceptability of results (95 % confidence). The user should choose the precision statement that reflects the concentration range of each component under study.

15.1.1 *Repeatability*—The difference between successive test results, obtained by the same operator with the same apparatus under constant operating conditions on identical test material would, in the long run, in the normal and correct operation of the test method, exceed the values in **Table 2** only in 1 case in 20:

**TABLE 2 Repeatability**

NOTE 1— $X$  = the mean volume % of the component.

Component	Range, volume %	Repeatability	See Note
Benzene	0.1–1.5	0.03( $X$ ) + 0.01	Note 7
Benzene	>1.5	0.03	Note 8
Toluene	1.7–9	0.03( $X$ ) + 0.02	Note 7
Toluene	>9	0.62	Note 8

15.1.2 *Reproducibility*—The difference between two, single and independent results, obtained by different operators working in different laboratories on identical test material would, in the long run, in the normal and correct operation of the test method, exceed the values in **Table 3** only 1 case in 20:

**TABLE 3 Reproducibility**

NOTE 1— $X$  = the mean volume % of the component.

Component	Range, volume %	Reproducibility	See Note
Benzene	0.1–1.5	0.13( $X$ ) + 0.05	Note 7
Benzene	>1.5	0.28( $X$ )	Note 8
Toluene	1.7–9	0.12( $X$ ) + 0.07	Note 7
Toluene	>9	1.15	Note 8

NOTE 7—In order to reflect changes in gasoline composition, the precision for this test method was determined in 1994 using both conventional gasolines as well as gasolines containing oxygenates (ethers such as methyl *tert*-butyl ether, ethyl *tert*-butyl ether, and *tert*-amyl methyl ether, and alcohols such as ethanol). This precision should be used when the concentration of benzene (0.1 to 1.5 volume %) and toluene (1.7 to 9 volume %) fall within the specified range. The sample composition and results of the cooperative study are filed at ASTM International.<sup>4</sup>

NOTE 8—The precision was determined using conventional motor gasolines purchased on the open market. This precision should be used when the concentration of benzene exceeds 1.5 volume % and toluene 9 volume %. The sample compositions and results of the cooperative study are filed at ASTM International.<sup>4</sup>

15.2 *Bias*—Since there is no accepted reference method suitable for measuring bias for this method, no statement of bias can be made.

## 16. Keywords

16.1 aviation gasoline; benzene; gas chromatography; gasoline; toluene

<sup>4</sup> Supporting data have been filed at ASTM International Headquarters and may be obtained by requesting Research Report RR:D02-1042.

## APPENDIX

### (Nonmandatory Information)

#### X1. RESOLVING BENZENE FROM ETHANOL

##### X1.1 Summary

X1.1.1 The presence of ethanol interferes with the determination of benzene by Test Method D3606. There are a number of modifications to Test Method D3606 that can be employed to resolve benzene from ethanol. This appendix presents a modification suggested in an EPA Q&A document.

##### X1.2 Modification A

X1.2.1 Three column sections are employed, in the following order:

X1.2.1.1 *Column 1*—5 ft × 1/8 in. ID methyl silicone on Chromosorb (10 % OV101 on Chromosorb PAW 80/100).

X1.2.1.2 (-valve-).

X1.2.1.3 *Column 2*—5 ft × 1/8 in. ID TCEP on Chromosorb (20 % TCEP on Chromosorb PAW 80/100).

X1.2.1.4 *Column 3*—15 ft × 1/8 in. ID Carbowax 1540 (15 %) on Chromosorb W 60/80.

X1.2.1.5 (-detector-).

X1.2.2 The total column length is extended by 5 ft. The original 15 ft section of TCEP is replaced by two sections of column totaling 20 ft and connected in series, or one 20 ft column is packed to simulate the two columns. This combined 20 ft section of column is connected in the same way as the original 15 ft TCEP, except that the TCEP end of the combined column is toward the valve (which places the Carbowax end next to the detector). See **Fig. X1.1** for a valve diagram showing the arrangement of the columns.

X1.2.3 The internal standard is changed from 2-butanone (methyl ethyl ketone or MEK) to 2-butanol (sec-butyl alcohol or SBA).

X1.2.4 Gas chromatographic parameter changes are as follows:

Column Temperature	Isothermal at 135 °C
Column Head Pressure	Approximately 65 psi
Volume Flow Rate	Approximately 26.6 cm <sup>3</sup> /min

X1.2.5 For a sample chromatogram using this modification, see Fig. X1.2.

X1.2.6 *Precision*—Based on one set of data from three different laboratories, each of which analyzed a different sample, the repeatability standard deviation has been determined to be 0.02 volume % for benzene when using this modification. The reproducibility is still being determined.

### X1.3 Modification B

X1.3.1 An alternative column set has been developed<sup>5</sup> to more accurately quantify benzene in gasoline containing the oxygenate ethanol. A requirement for such column or equivalent is that a resolution (R) values > 3.00 be obtained when used in the configuration of X1.3.3 to eliminate ethanol interference with benzene. The analytical packed column<sup>5</sup> contains a proprietary chromatographic phase. The two column set can be used to quantify benzene in gasoline with or without ethanol. The robustness of the column set also permits the use of N<sub>2</sub> (nitrogen) carrier gas with no detrimental analytical effects (see Fig. X1.3).

X1.3.2 A two column set is employed in the following order (see Fig. X1.4):

X1.3.2.1 *Column 1*—6 ft (1.8 m) × 1/8 in. OD × 2 mm ID (10 % Rtx 1 on 100/120 Silcoport)—Nonpolar Backflush.

X1.3.2.2 Backflush valve.

X1.3.2.3 *Column 2*—15.5 ft (4.76 m) × 1/8 in. × 2 mm id (BenzoSep proprietary polymer)—Analytical Column.<sup>5</sup>

<sup>5</sup> The sole source of supply of Column 2 known to the committee at this time is Restek, Inc., 110 Benner Circle, Bellefonte, PA 16823. If you are aware of alternative suppliers, please provide this information to ASTM International Headquarters. Your comments will receive careful consideration at a meeting of the responsible technical committee, which you may attend.

X1.3.2.4 TCD–Detector.

NOTE X1.1—It is acceptable to replace the MXT (Restek) Column 1 (which is the nonpolar PDMS backflush column) with a column from an alternative supplier. However, it is imperative that the tubing, and the solid support used to prepare the PDMS packing material be properly deactivated to prevent excessive tailing of the ethanol into benzene. Should this occur, accurate quantitation of benzene will be difficult, if not impossible. The symmetry value (S) of ethanol at 10 % peak height should not exceed 2.8 when using an alternative Column 1. The symmetry value of ethanol can be calculated either electronically or manually as follows (see Fig. X1.3) by drawing a vertical line from the apex of the ethanol peak down to the baseline, dividing the peak into two sections. The peak height of ethanol is then measured from the apex to the baseline. This value is multiplied by 10 % and the resulting value is measured and marked above the baseline inside the peak. A horizontal line is then drawn parallel to the baseline through the 10 % peak height indicating mark. As indicated in the drawing below, the leading edge of the peak is designated as “A” and the trailing edge of the peak is designated as “B.” The distance is measured from the peak leading edge and trailing edge to the vertical line at 10 % peak height. The symmetry value is then determined as S = B/A.

X1.3.3 The total length of the two set is 21 ft (6.57 m). The nonpolar backflush column and the main analytical column are installed as illustrated in Fig. X1.5.

X1.3.4 The internal standard is changed from 2-butanone (methyl ethyl ketone or MEK) to 2-butanol (sec-butyl alcohol or SBA).

X1.3.5 Gas chromatographic parameter changes are as follows:

Column Temperature	Isothermal at 135 °C
Column Head Pressure	Approximately 65 psi
Volume Flow Rate	Approximately 20 cm <sup>3</sup> /min

X1.3.6 For a sample chromatogram with helium carrier using this modification, see Fig. X1.6.

X1.3.7 *Precision*—Based on one set of data from three different laboratories, each of which analyzed a different sample, the repeatability standard deviation has been determined to be 0.0038 volume % for benzene when using this modification. The reproducibility is still being determined.



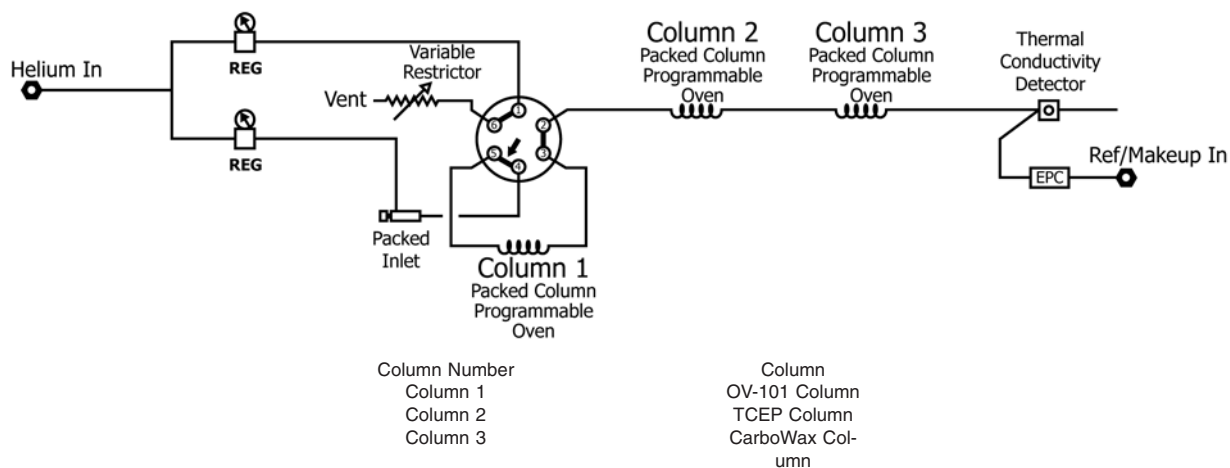

FIG. X1.1 Valve Diagram Showing Arrangement of the Columns

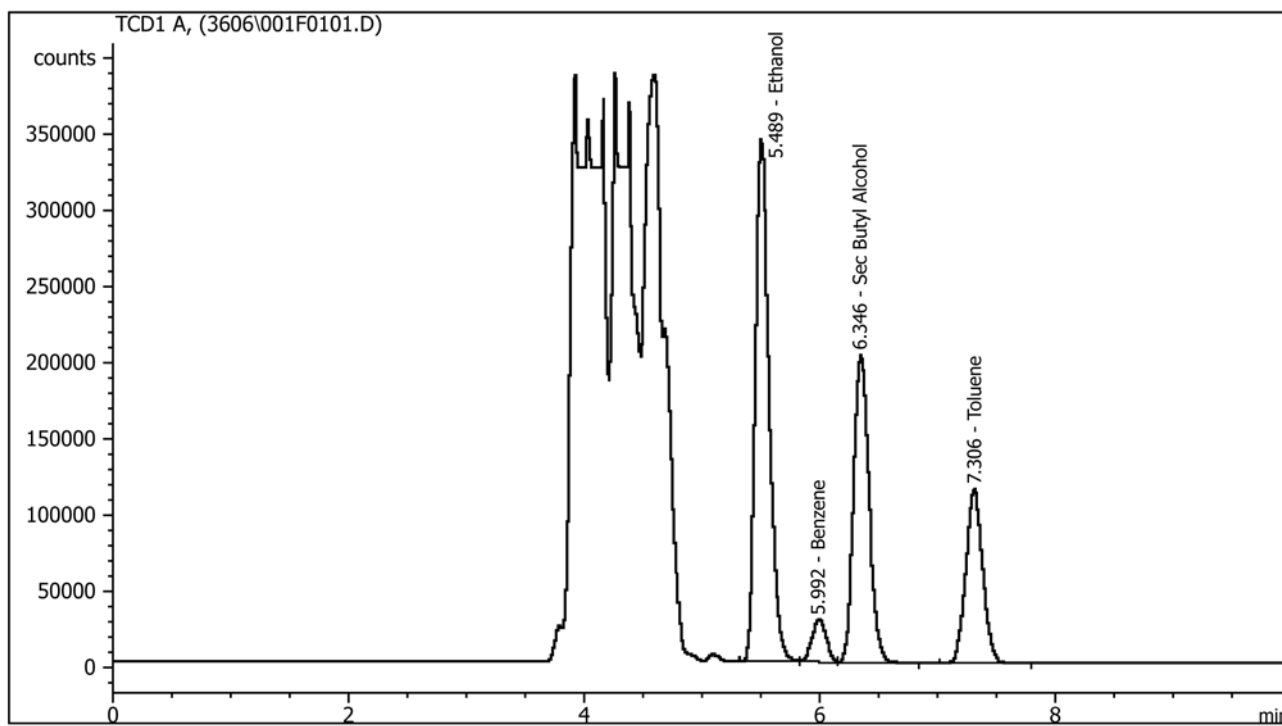

FIG. X1.2 Example Chromatogram

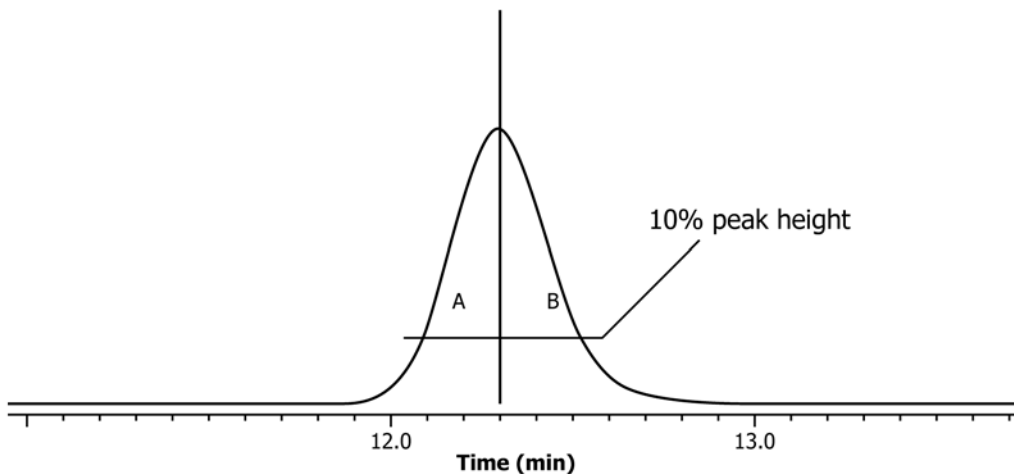

FIG. X1.3 Symmetry Value of Ethanol

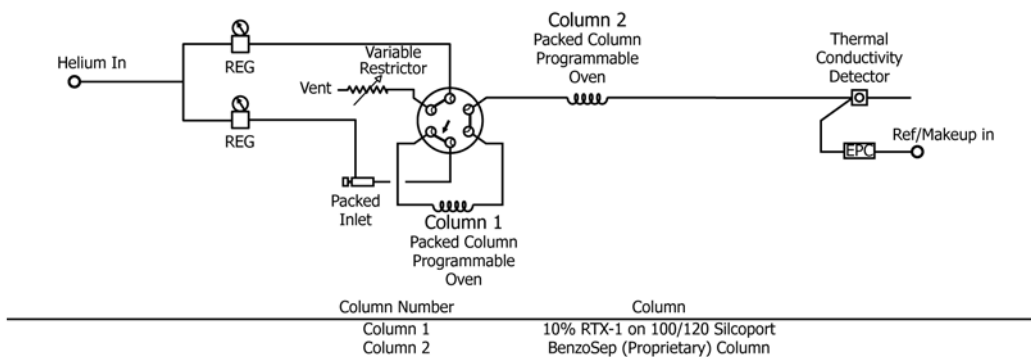

FIG. X1.4 Valve Diagram Showing Arrangement of the Columns

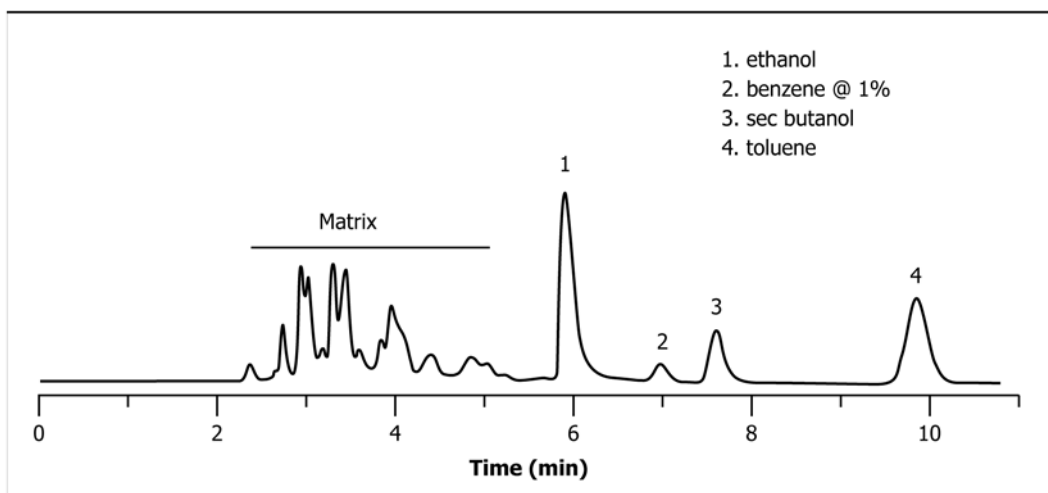

FIG. X1.5 Example Chromatogram (Helium Carrier)

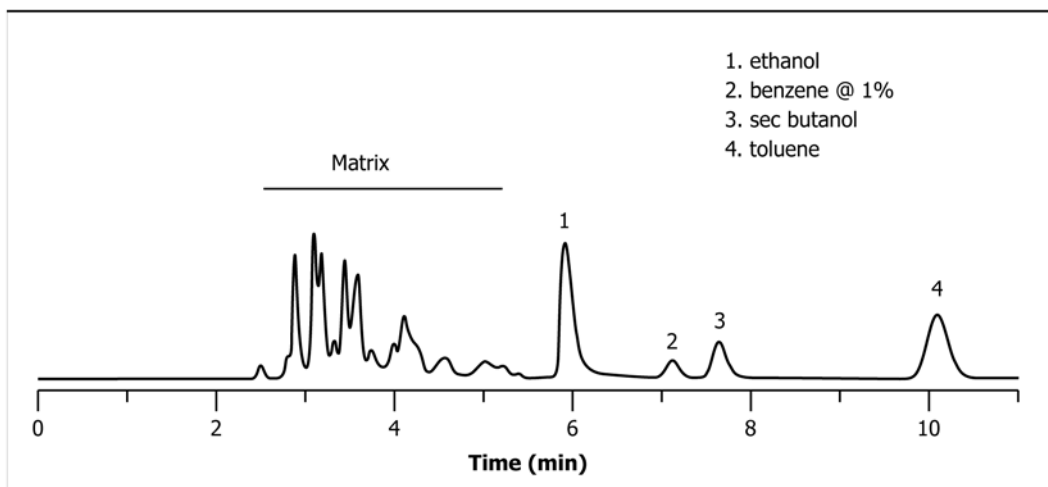

FIG. X1.6 Example Chromatogram (Nitrogen Carrier)

### SUMMARY OF CHANGES

Subcommittee D02.04.0L has identified the location of selected changes to this standard since the last issue (D3606 – 07) that may impact the use of this standard.

- (1) Modified title of Section X1.2.
- (2) Added Section X1.3.

- (3) Added Figs. X1.3-X1.6.

*ASTM International takes no position respecting the validity of any patent rights asserted in connection with any item mentioned in this standard. Users of this standard are expressly advised that determination of the validity of any such patent rights, and the risk of infringement of such rights, are entirely their own responsibility.*

*This standard is subject to revision at any time by the responsible technical committee and must be reviewed every five years and if not revised, either reapproved or withdrawn. Your comments are invited either for revision of this standard or for additional standards and should be addressed to ASTM International Headquarters. Your comments will receive careful consideration at a meeting of the responsible technical committee, which you may attend. If you feel that your comments have not received a fair hearing you should make your views known to the ASTM Committee on Standards, at the address shown below.*

*This standard is copyrighted by ASTM International, 100 Barr Harbor Drive, PO Box C700, West Conshohocken, PA 19428-2959, United States. Individual reprints (single or multiple copies) of this standard may be obtained by contacting ASTM at the above address or at 610-832-9585 (phone), 610-832-9555 (fax), or service@astm.org (e-mail); or through the ASTM website (www.astm.org). Permission rights to photocopy the standard may also be secured from the Copyright Clearance Center, 222 Rosewood Drive, Danvers, MA 01923, Tel: (978) 646-2600; http://www.copyright.com/*