



Standard Test Method for Resistance to Growth of Mold on the Surface of Interior Coatings in an Environmental Chamber¹

This standard is issued under the fixed designation D3273; the number immediately following the designation indicates the year of original adoption or, in the case of revision, the year of last revision. A number in parentheses indicates the year of last reapproval. A superscript epsilon (ϵ) indicates an editorial change since the last revision or reapproval.

This standard has been approved for use by agencies of the U.S. Department of Defense.

1. Scope

1.1 This test method describes a small environmental chamber and the conditions of operation to evaluate reproducibly in a 4-week period the relative resistance of paint films to surface mold fungi, mildew growth in a severe interior environment. The apparatus is designed so it can be easily built or obtained² by any interested party and will duplicate results obtained in a large tropical chamber.

1.2 This test method can be used to evaluate the comparative resistance of interior coating to accelerated mildew growth. Performance at a certain rating does not imply any specific period of time for a fungal free coating. However, a better rated coating nearly always performs better in actual end use.

NOTE 1—This test method is intended for the accelerated evaluation of an interior coatings' resistance to fungal defacement. Use of this test method for evaluating exterior coatings' performance has not been validated, nor have the limitations for such use been determined. If this test method is to be used for the testing of an exterior coating system, a precautionary statement regarding interpretation of results as being outside of the scope of this test method must be included. Any accelerated weathering (leaching, weathering machine exposure, etc.) should be reported and should also bear reference to the fact that it is beyond the current scope of this test method.

1.3 Temperature and humidity must be effectively controlled within the relatively narrow limits specified in order for the chamber to function reproducibly during the short test period. Severity and rate of mold growth on a film is a function of the moisture content of both the film and the substrate. A relative humidity of $95 \pm 3\%$ at a temperature of $32.5 \pm 1^\circ\text{C}$ ($90 \pm 2^\circ\text{F}$) is necessary for test panels to develop rapidly and maintain an adequate moisture level to support mold growth.

¹ This test method is under the jurisdiction of ASTM Committee D01 on Paint and Related Coatings, Materials, and Applications and is the direct responsibility of Subcommittee D01.28 on Biodeterioration.

Current edition approved June 1, 2016. Published July 2016. Originally approved in 1973. Last previous edition approved in 2012 as D3273 – 12^{\epsilon}. DOI: 10.1520/D3273-16.

² Additional specifications for construction of a chamber that has been found suitable for this method may be obtained from New Jersey Industrial Controls, P.O. Box 601, Rockaway, NJ 07866.

1.4 The values stated in SI units are to be regarded as the standard. The values given in parentheses are for information only.

1.5 *This standard does not purport to address all of the safety concerns, if any, associated with its use. It is the responsibility of the user of this standard to establish appropriate safety and health practices and determine the applicability of regulatory limitations prior to use.*

2. Referenced Documents

2.1 *ASTM Standards:*³

E177 Practice for Use of the Terms Precision and Bias in ASTM Test Methods

E691 Practice for Conducting an Interlaboratory Study to Determine the Precision of a Test Method

3. Significance and Use

3.1 An accelerated test for determining the resistance of interior coatings to mold growth is useful in estimating the performance of coatings designed for use in interior environments that promote mold growth and in evaluating compounds that may inhibit such growth and the aggregate levels for their use (see also Note 1).

3.2 This test method should preferably be used by persons who have had basic microbiological training.

4. Apparatus

4.1 *Environmental Chamber*, capable of maintaining a relative humidity of $95 \pm 3\%$ at a temperature of $32.5 \pm 1^\circ\text{C}$ ($90 \pm 2^\circ\text{F}$) while providing a continuous inoculation of the surface of exposed panels with mold spores. The chamber should be kept in a room controlled to no less than 21°C (75°F) so that heat loss from the cabinet is insignificant and that 92 to 98 % relative humidity is readily obtained at the test temperature. Alternatively the cabinet must be insulated with suitable materials to minimize heat loss.

³ For referenced ASTM standards, visit the ASTM website, www.astm.org, or contact ASTM Customer Service at service@astm.org. For *Annual Book of ASTM Standards* volume information, refer to the standard's Document Summary page on the ASTM website.

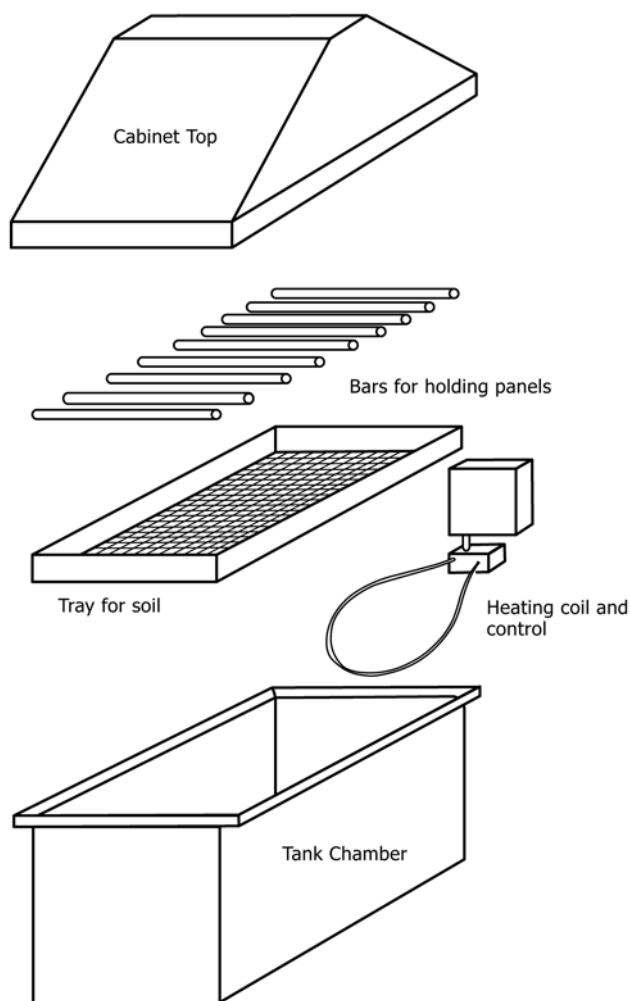

FIG. 1 Environmental Cabinet Assembly

4.2 *Cabinet*, suitable to accommodate the desired number of test panels, typically a minimum of twenty-five 75 by 100-mm (3 by 4-in.) panels under these test conditions can be constructed as follows (Fig. 1):

4.2.1 *Tank*, polypropylene or polyethylene or glass, with an offset shoulder at the top rim is used as the chamber.⁴ The minimum recommended tank size is 46 by 46 by 61 cm (18 by 18 by 24 in.). A pitched top with straight sides should be constructed out of acrylic plastic so moisture condensation will run down the sides and be recirculated instead of dripping onto the panels. A pitched top is not necessary if the chamber is incubated in a temperature-controlled warm room that is maintained at $32.5 \pm 1^\circ\text{C}$ ($90 \pm 2^\circ\text{F}$) which prevents condensation on the interior panel surfaces.

4.2.2 *Heating Coil*,⁵ installed in the bottom of the chamber by water tight connections through the end wall. The heater

⁴ Tanks of this type available in dimensions approximating 69 by 46 by 46 cm (27 by 18 by 18 in.) are available from laboratory supply companies. Nalgene tanks have been found suitable.

⁵ The sole source of supply of a $\frac{7}{8}$ -mm (0.315-in.) diameter inconel sheathed heater, Model STRI (STRI-1248/120), known to the committee at this time is Omega Engineering, Inc., One Omega Drive, Stamford, CT 06907, www.omega.com.

should be sized to allow reasonable recovery time and uniform heating of the water when the chamber is opened and closed to place or inspect samples.⁶ It is so placed that it is immersed when there are 50 to 75 mm (2 to 3 in.) of water in the bottom of the chamber. A heating coil is not necessary if the chamber is incubated in a temperature-controlled warm room that is maintained at $32.5 \pm 1^\circ\text{C}$ ($90 \pm 2^\circ\text{F}$). The temperature in the chamber should be monitored and controlled by placing a suitable thermocouple or RTD⁷ in an area near the test panels. The temperature can be displayed and controlled by a solid state proportional controller.⁸ The heating coil is not necessary if the chamber is incubated in a temperature-controlled warm room that is maintained at $32.5 \pm 1^\circ\text{C}$ ($90 \pm 2^\circ\text{F}$).

4.2.3 *Soil Tray*, stainless steel, aluminum or plastic, approximately 25 mm (1 in.) smaller than the inside dimensions of the chamber and 25 to 75 mm (1 to 3 in.) deep with a non-corrodible metal⁹ mesh bottom should be supported 25 mm (1 in.) above the water level and centered in the chamber. One layer of fine plastic or fiberglass screen may be placed over the metal mesh, if needed for holding soil.

NOTE 2—It has been found that eliminating the plastic screen helps improve water vapor transfer into soil, and maintain active fungal cultures.

4.2.4 *Series of Wood, Glass, or Fiberglass Reinforced Plastic Bars*, suspended across the width of the chamber at a height and spacing that allows the use of test panels 75 by 100 mm (3 by 4 in.), hung vertically, with approximately 75-mm (3-in.) clearance above the inoculated soil with a suitable method of fastening. Screw eyes are used with the wooden panels while a wire frame, plastic cable ties or a large clip is used with the gypsum board panels. Other support systems may be utilized.

NOTE 3—Other angles of exposure may be used but may alter the rate and severity of mold growth. This change of positioning must be included in the final report.

4.3 *Psychrometer*, for measuring relative humidity in the test area. A temperature/humidity datalogger may also be used if the accuracy of the relative humidity sensor is $\pm 3\%$.

5. Reagents and Materials

5.1 *Soil*—A good quality greenhouse-grade potting soil, suitable for plant propagation, containing 25 % peat moss. The pH range of the soil should fall from 5.5 to 7.0. Do not allow soil to become compacted. Additional peat moss can be added to lower the pH into the required range.

5.2 Cultures:

5.2.1 *Aureobasidium pullulans*,¹⁰ ATCC 9348.

⁶ For a 46 by 46 by 61-cm (18 by 18 by 24-in.) tank, a 250-watt heater is recommended. For a 61 by 61 by 91-cm (24 by 24 by 36-in.) tank, an 800-watt heater is recommended.

⁷ A grounded 1.5 mm ($\frac{1}{16}$) or 2.4 mm ($\frac{3}{32}$ -in.) "J" type stainless thermocouple gives good response for this application.

⁸ A Eurotherm Model 91 controlling the heater via solid state relay has demonstrated that it can be calibrated and provide calibratable, accurate, and reliable performance.

⁹ 150-mesh 316 stainless screen gives a high percentage of open area and will not allow dirt to contaminate the water.

¹⁰ Cultures can be obtained from American Type Culture Collection, P.O. Box 1549, Manassas, VA 20108. Cultures can be maintained on malt agar or potato dextrose agar. Prepared slants can be obtained from microbiological supply companies.

5.2.2 *Aspergillus niger*,¹⁰ ATCC 6275.

5.2.3 *Penicillium sp.*,¹⁰ 12667 or ATCC 9849.

5.3 Test Panels:

5.3.1 *Softwood Sapwood, such as Ponderosa Pine (Pinus ponderosa Laws) Sapwood Panels*, approximately 13 mm (½ in.) thick, 75 by 100 mm (3 by 4 in.), free of excessive resins, knots, growth rings or other abnormalities, surfaced smooth on four sides. Wood shall be kiln dried after sawing to avoid infestation of wood-rotting fungi, and any wood showing evidence of infestation such as blue stain shall be eliminated as test material. Wood shall be weighed after conditioning at room temperature in a dry room to 15 % moisture content. Calculated weight shall fall between 365 and 425 kg/m³ (6.0 and 7.0 g/in.³). Panels containing heartwood areas should not be used as they will inhibit mold growth under test conditions.

5.3.2 *Gypsum Board Panels*, 13 to 25 mm (½ to 1 in.) thick, 75 by 100 mm (3 by 4 in.).

5.3.3 *Other Substrates such as Drawdown Paper, Tongue Depressors, Glass, etc.*, may be used as agreed upon by the parties involved. However, when comparing the relative performance of various coatings, the substrates must be the same in order for the results to be meaningful. When using substrates that are not themselves susceptible to attack (like glass), use another type of positive growth control rather than the uncoated panel as specified in 7.2.

5.4 The water used in the tank chamber is required to be DI or equivalent.

6. Preparation of Apparatus

6.1 Place greenhouse soil in the tray in the cabinet and add water to the tank chamber to the desired depth. Allow the cabinet to equilibrate for 24 h before inoculating the soil with the specified mold suspensions.

6.2 Prepare fungus plates or slants of all three cultures and incubate 10 to 14 days. Prepare suspensions from each fungus by the following procedure: Add one drop of 25 % nonionic surfactant¹¹ solution to 95 to 100 mL sterile deionized or distilled water and gently mix. Dispense 5 to 10 mL of this solution onto each of the fungus cultures. Scrub the surface of the slant with a sterile cotton swab or sterile glass rod to remove as much spore and mycelial growth as possible without digging up the surface of the agar. Pour the water from the scrubbed slant back into the surfactant-sterile water mixture for dilution. If necessary, shake gently to break up clumps of spores. Distribute the fungal suspensions evenly over the surface of the greenhouse soil in the tray in the cabinet.

6.3 Before starting a test, verify the readiness of the soil by having untreated controls achieve a rating of 4 to 6 within 2 to 3 weeks of being placed in the chamber. It should not be necessary to continually re-inoculate the chamber soil after sufficient microorganism growth has been established. If the

chamber is maintained in continuous operation, a tray of soil can produce mold spores for many months, but should be replaced with a fresh inoculated soil twice per year.

6.4 Viability of the mold growth in the cabinet can also be checked by placing several malt agar or potato dextrose agar plates,¹² open and face up, at several locations on the panel support rods. After 1 h, cover plates and place in incubator at 32.5 ± 1°C (90 ± 2°F) for 5 to 7 days. If an incubator is not available, leave the covered plates in the cabinet. Conformational fungus growth must be that of test organisms, be medium-heavy to heavy and cover the complete surface of the agar plate.

7. Procedure

7.1 *Preparation of Test Panels*—Wear disposable plastic or equivalent gloves or utilize other techniques when handling panels to avoid fingerprints. Prepare triplicate panels by applying two coats of the material under test to both faces and to all edges of the panels at a spreading rate of approximately 11 m²/L (450 ft²/gal) per coat or as specified by the coating manufacturer, allowing 1 day between coats unless otherwise specified. Duplicates may be run instead of triplicates, if agreed upon by parties involved. Condition the panels at 23 ± 2°C (73.5 ± 3.5°F) and 50 ± 5 % relative humidity for 4 days after application of the last coat before placing in the test chamber for start of environmental exposure. Test pieces may also be prepared by the customer and submitted to the laboratory for testing.

7.2 *Exposure*—Hang the panels vertically with the bottom approximately 3 in. (75 mm) above the surface of the inoculated soil and with sufficient spacing to allow free circulation of air and to prevent contact between panels or with wall surfaces. Place replicate panels randomly in the cabinet. Include uncoated control panels, or panels coated with a material known to fail under the test condition if the substrate is not susceptible to mildew growth, in all tests. If the cabinet is operating properly, unpainted panels should develop a 4 to 6 mold growth rating within 2 to 3 weeks. If this growth is not obtained, the cabinet conditions are not satisfactory or there is some interfering treatment on a panel.

7.3 *Rating*—Rate the panels for mold growth each week for 4 weeks on a 0 to 10 rating scale by estimating the percentage of surface defacement with 10 being no defacement and 0 being completely defaced. Include both test and non-test fungal growth in the rating. Test panels and controls should be picked up and examined under good light. Use the drawings in Figs. 2-11 as a guide for the rating scale. A grid has been superimposed on each panel to assist in the fungal growth estimates. Record the temperature and relative humidity each week when the chamber is opened to confirm the target parameters are being achieved.

¹¹ Octyl phenol ethoxylates, 9–10 mole EO, have been found suitable.

¹² Prepared agar plates are available from microbiological supply companies.

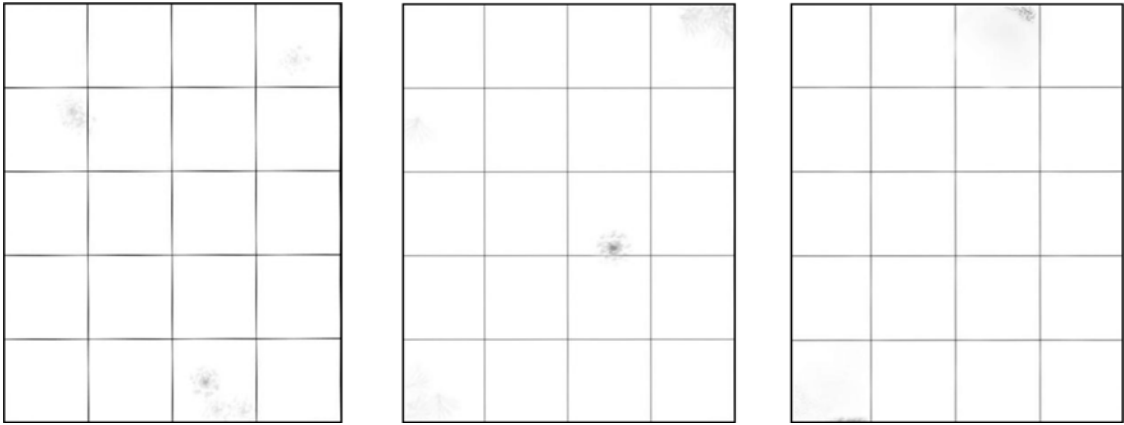

FIG. 2 Rating of 9 = 1 to 10 % Defacement

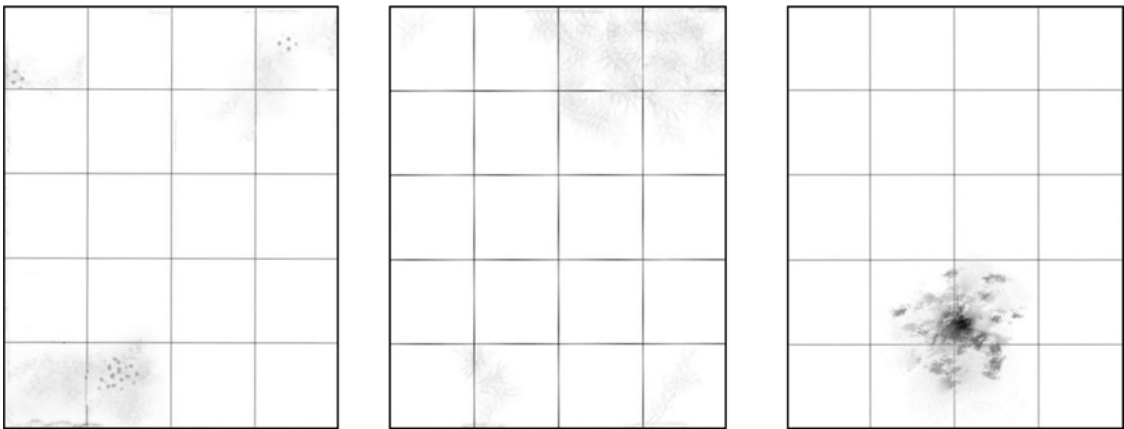

FIG. 3 Rating of 8 = 11 to 20 % Defacement

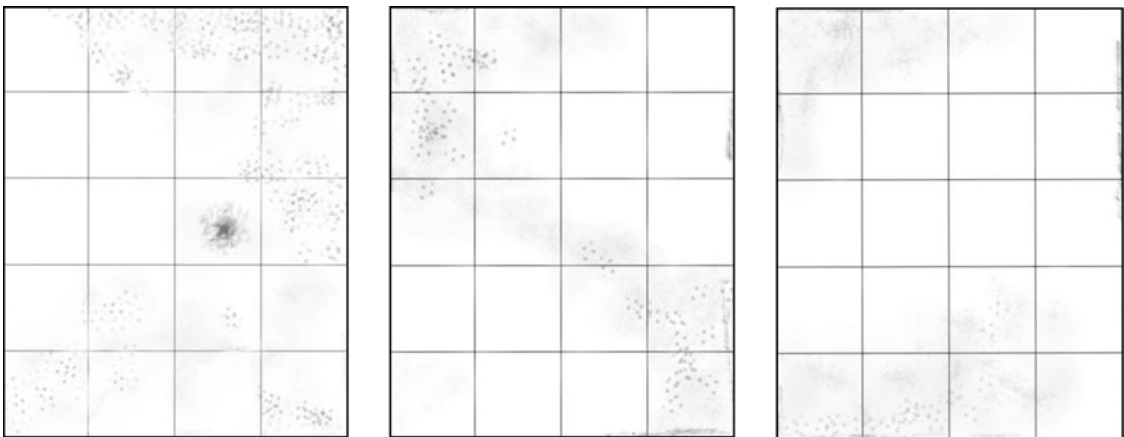

FIG. 4 Rating of 7 = 21 to 30 % Defacement

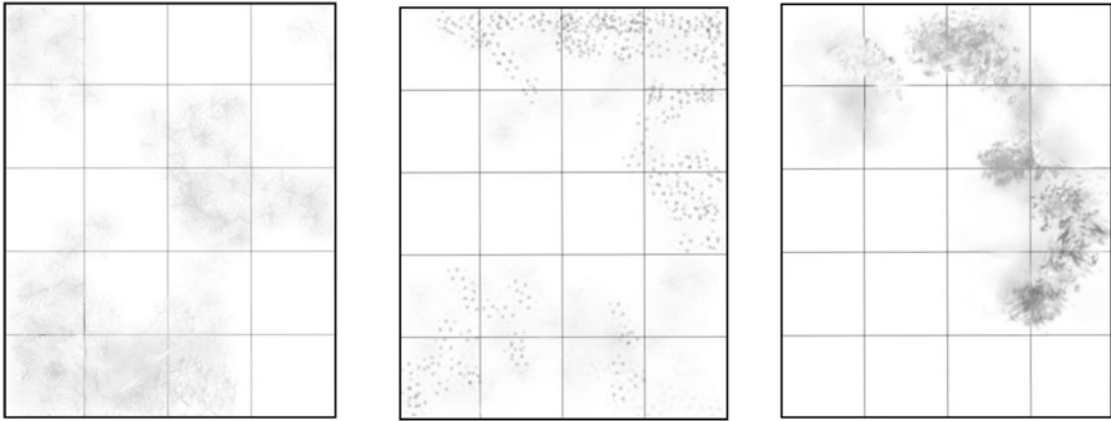

FIG. 5 Rating of 6 = 31 to 40 % Defacement

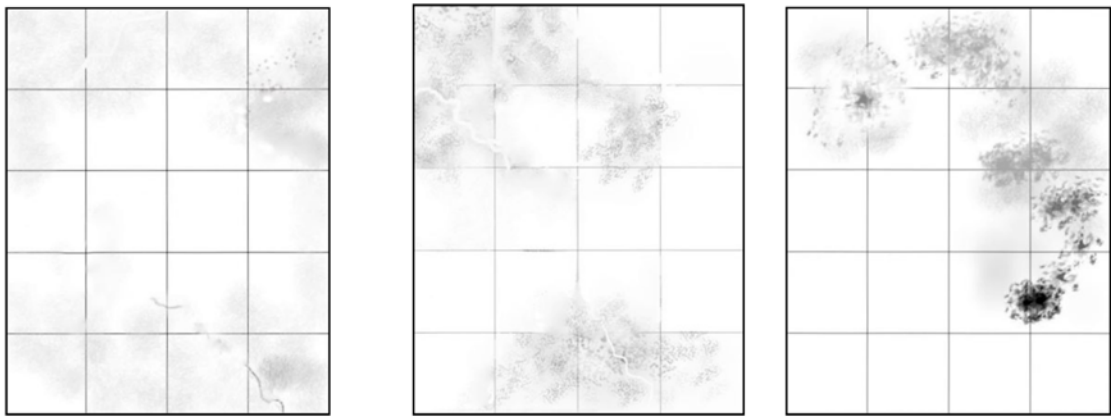

FIG. 6 Rating of 5 = 41 to 50 % Defacement

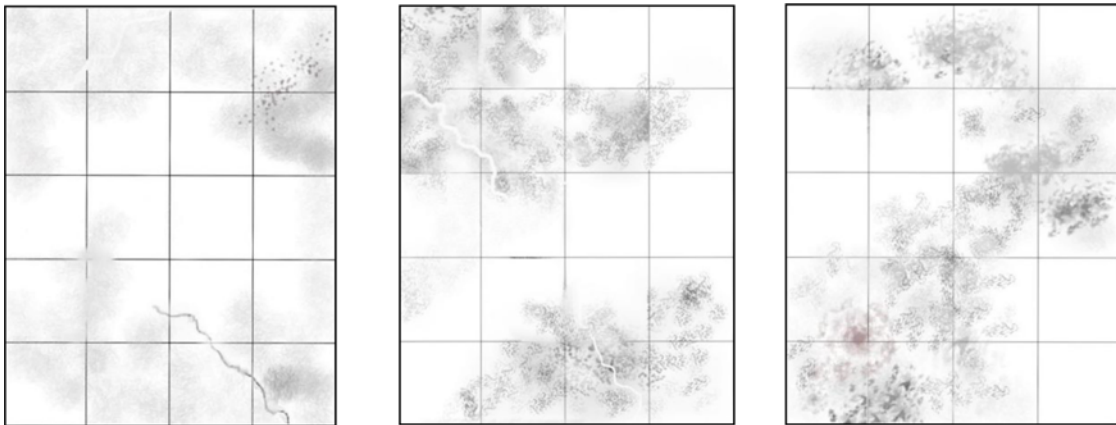

FIG. 7 Rating of 4 = 51 to 60 % Defacement

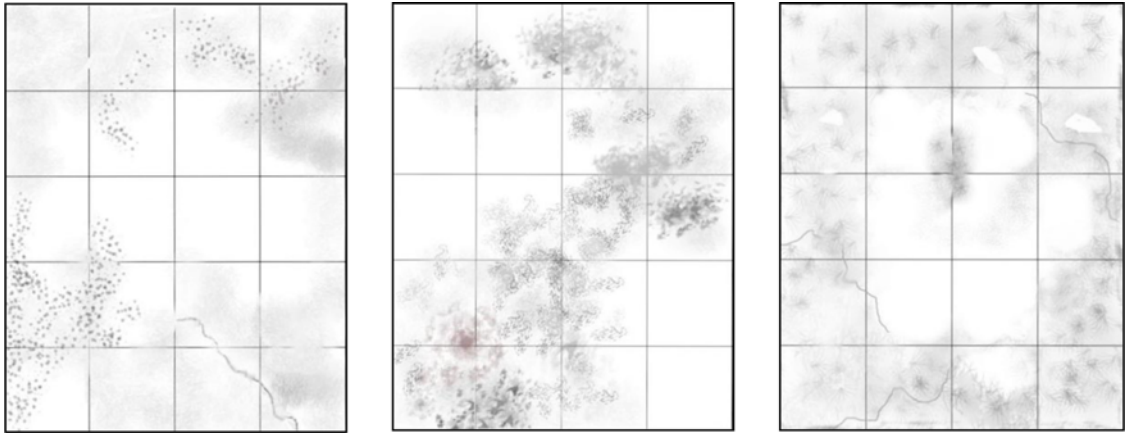

FIG. 8 Rating of 3 = 61 to 70 % Defacement

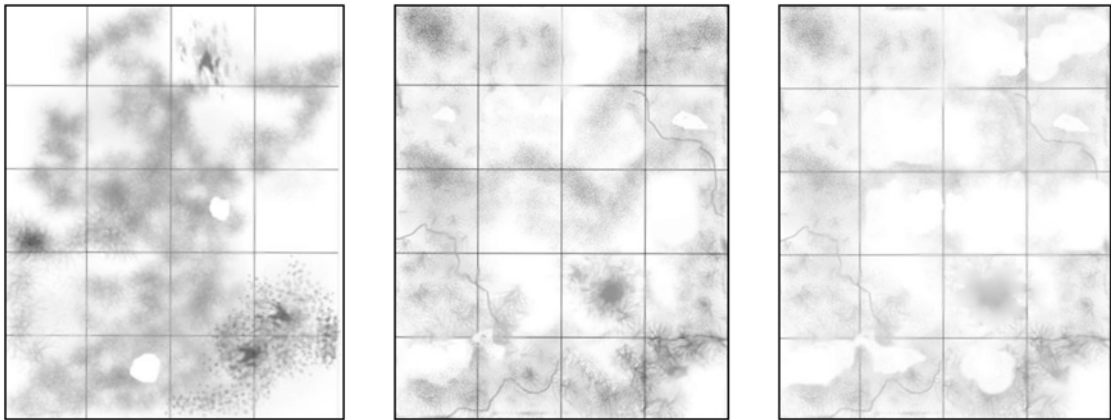

FIG. 9 Rating of 2 = 71 to 80 % Defacement

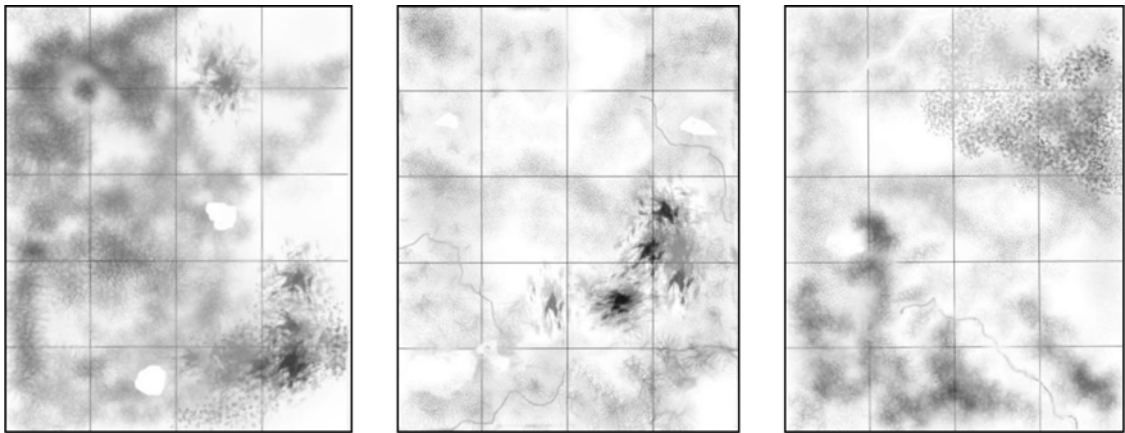

FIG. 10 Rating of 1 = 81 to 90 % Defacement

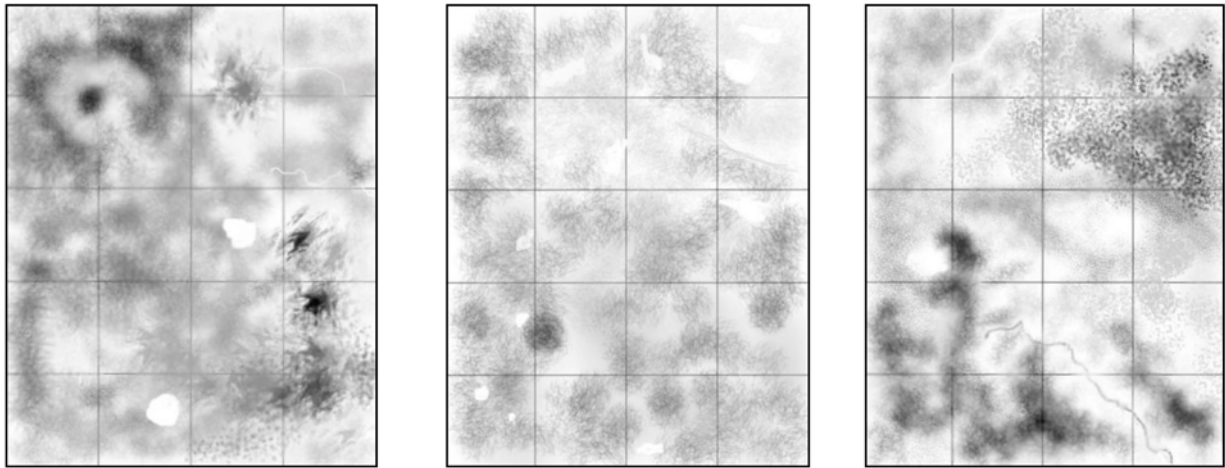

FIG. 11 Rating of 0 = 100 % Defacement

Ratings:

- Rating of 10 = 0 defacement
- Rating of 9 = 1 to 10 % defacement
- Rating of 8 = 11 to 20 % defacement
- Rating of 7 = 21 to 30 % defacement
- Rating of 6 = 31 to 40 % defacement
- Rating of 5 = 41 to 50 % defacement
- Rating of 4 = 51 to 60 % defacement
- Rating of 3 = 61 to 70 % defacement
- Rating of 2 = 71 to 80 % defacement
- Rating of 1 = 81 to 90 % defacement
- Rating of 0 = 91 to 100 % defacement

8. Report

8.1 Report the results at the end of the 4-week exposure giving the weekly ratings of all panels and controls. The result from any panel that differs by more than 2 rating units from either of the others in that set can be considered manifestly faulty and discarded. If all panels in a set differ by more than 2 units in their ratings, discard all results and repeat the test. Include in the report the weekly temperature and humidity measurement in addition to any modifications to the test method.

9. Precision and Bias¹³

9.1 The precision of this test method is based on an interlaboratory study of ASTM Test Method D3273, Standard Test Method for Resistance to Growth of Mold on the Surface of Interior Coatings in an Environmental Chamber, conducted in 2010. A single laboratory participated in this study, recording the changes observed on three specimens over a four week

¹³ Supporting data have been filed at ASTM International Headquarters and may be obtained by requesting Research Report RR:D01-1162. Contact ASTM Customer Service at service@astm.org.

period. This procedure was repeated 40 times in order to determine the precision of the test method. Every “test result” represents an individual observation. Except for the use of only one laboratory, Practice E691 was followed for the design and analysis of the data; the details are given in ASTM Research Report No. RR:D01-1162.

9.1.1 *Repeatability Limit (r)*—Two test results obtained within one laboratory shall be judged not equivalent if they differ by more than the “r” value for that material; “r” is the interval representing the critical difference between two test results for the same material, obtained by the same operator using the same equipment on the same day in the same laboratory.

9.1.1.1 Repeatability limits are listed in Tables 1-4.

9.1.2 *Reproducibility Limit (R)*—Two test results shall be judged not equivalent if they differ by more than the “R” value for that material; “R” is the interval representing the critical difference between two test results for the same material, obtained by different operators using different equipment in different laboratories.

9.1.2.1 Reproducibility limits cannot be calculated from a single laboratory’s results.

9.1.3 The above terms (repeatability limit and reproducibility limit) are used as specified in Practice E177.

9.1.4 Any judgment in accordance with statement 9.1.1 would normally have an approximate 95 % probability of being correct, however the precision statistics obtained in this ILS must not be treated as exact mathematical quantities which are applicable to all circumstances and uses. The limited number of laboratories reporting replicate results guarantees that there will be times when differences greater than predicted by the ILS results will arise, sometimes with considerably

TABLE 1 Week 1 (Defacement Rating)

	Average ^A	Repeatability Standard Deviation	Repeatability Limit
	\bar{X}	S_r	r
Board	9.0	0.3	0.7

^A The average of 120 successive trials.

TABLE 2 Week 2 (Defacement Rating)

	Average ^A	Repeatability Standard Deviation	Repeatability Limit
	\bar{X}	S_r	r
Board	7.0	1.0	2.8

^A The average of 120 successive trials.

TABLE 3 Week 3 (Defacement Rating)

	Average ^A	Repeatability Standard Deviation	Repeatability Limit
	\bar{X}	S_r	r
Board	4.3	1.4	3.8

^A The average of 120 successive trials.

TABLE 4 Week 4 (Defacement Rating)

	Average ^A	Repeatability Standard Deviation	Repeatability Limit
	\bar{X}	S_r	r
Board	2.4	1.6	4.5

^A The average of 120 successive trials.

greater or smaller frequency than the 95 % probability limit would imply. Consider the repeatability limit as a general guide, and the associated probability of 95 % limit would imply. Consider the repeatability limit as a general guide, and the associated probability of 95 % as only a rough indicator of what can be expected.

9.2 *Bias*—At the time of the study, there was no accepted reference material suitable for determining the bias for this test method, therefore no statement on bias is being made.

9.3 The precision statement was determined through statistical examination of 480 results, from a single laboratory, on the material described below:

Board: Untreated gypsum wallboard

10. Keywords

10.1 environmental chamber; mold; surface interior coatings

ASTM International takes no position respecting the validity of any patent rights asserted in connection with any item mentioned in this standard. Users of this standard are expressly advised that determination of the validity of any such patent rights, and the risk of infringement of such rights, are entirely their own responsibility.

This standard is subject to revision at any time by the responsible technical committee and must be reviewed every five years and if not revised, either reapproved or withdrawn. Your comments are invited either for revision of this standard or for additional standards and should be addressed to ASTM International Headquarters. Your comments will receive careful consideration at a meeting of the responsible technical committee, which you may attend. If you feel that your comments have not received a fair hearing you should make your views known to the ASTM Committee on Standards, at the address shown below.

This standard is copyrighted by ASTM International, 100 Barr Harbor Drive, PO Box C700, West Conshohocken, PA 19428-2959, United States. Individual reprints (single or multiple copies) of this standard may be obtained by contacting ASTM at the above address or at 610-832-9585 (phone), 610-832-9555 (fax), or service@astm.org (e-mail); or through the ASTM website (www.astm.org). Permission rights to photocopy the standard may also be secured from the Copyright Clearance Center, 222 Rosewood Drive, Danvers, MA 01923, Tel: (978) 646-2600; http://www.copyright.com/