



Designation: D2809 – 09 (Reapproved 2017)

Standard Test Method for Cavitation Corrosion and Erosion-Corrosion Characteristics of Aluminum Pumps With Engine Coolants¹

This standard is issued under the fixed designation D2809; the number immediately following the designation indicates the year of original adoption or, in the case of revision, the year of last revision. A number in parentheses indicates the year of last reapproval. A superscript epsilon (ϵ) indicates an editorial change since the last revision or reapproval.

1. Scope

1.1 This test method covers the evaluation of the cavitation corrosion and erosion-corrosion characteristics of aluminum automotive water pumps with coolants.

NOTE 1—During the development of this test method, it was found that results obtained when testing two-phase coolants did not correlate with results from field tests. Therefore, the test method cannot be recommended as being a significant test for determining cavitation effects of two-phase coolants.

1.2 The values stated in SI units are to be regarded as the standard. The values given in parentheses are for information only.

1.3 *This standard does not purport to address all of the safety concerns, if any, associated with its use. It is the responsibility of the user of this standard to establish appropriate safety and health practices and determine the applicability of regulatory limitations prior to use.* Specific warning statements are given in 5.2.

1.4 *This international standard was developed in accordance with internationally recognized principles on standardization established in the Decision on Principles for the Development of International Standards, Guides and Recommendations issued by the World Trade Organization Technical Barriers to Trade (TBT) Committee.*

2. Referenced Documents

2.1 *ASTM Standards:*²

- D1176 Practice for Sampling and Preparing Aqueous Solutions of Engine Coolants or Antirusts for Testing Purposes
- E177 Practice for Use of the Terms Precision and Bias in ASTM Test Methods

¹ This test method is under the jurisdiction of ASTM Committee D15 on Engine Coolants and Related Fluids and is the direct responsibility of Subcommittee D15.09 on Simulated Service Tests.

Current edition approved April 1, 2017. Published April 2017. Originally approved in 1969 as D2809–69T. Last previous edition approved in 2009 as D2809-09. DOI: 10.1520/D2809-09R17.

² For referenced ASTM standards, visit the ASTM website, www.astm.org, or contact ASTM Customer Service at service@astm.org. For *Annual Book of ASTM Standards* volume information, refer to the standard's Document Summary page on the ASTM website.

2.2 *ASTM Adjunct:*³

Pump test stand (7 drawings and Bill of Materials)

3. Summary of Test Method

3.1 This test method consists of pumping an aqueous coolant solution at 113°C (235°F) through a pressurized 103-kPa (15-psig) simulated automotive coolant system (Note 2). An aluminum automotive water pump, driven at 4600 r/min by an electric motor, is used to pump the solution and to serve as the object specimen in evaluating the cavitation erosion-corrosion effect of the coolant under test. The pump is examined to determine the extent of cavitation erosion-corrosion damage and is rated according to the system given in Table 1. Photographs of typical eroded pumps after testing appear in the Appendix.

NOTE 2—Tests run at other than 113 °C (235 °F) might show more or less cavitation depending upon the coolant formulation.

4. Significance and Use

4.1 This test method can be used to distinguish between coolants that contribute to cavitation corrosion and erosion-corrosion of aluminum automotive water pumps and those that do not. It is not intended that a particular rating number, as determined from this test, will be equivalent to a certain number of miles in a vehicle test; however, limited correlation between bench and field service tests has been observed with single-phase coolants. Field tests under severe operating conditions should be conducted as the final test if the actual effect of the coolant on cavitation corrosion and erosion-corrosion is to be appraised. It is also possible, with proper control of the test variables, to determine the effect of pump design, materials of construction, and pump operating conditions on cavitation corrosion and erosion-corrosion damage.

5. Apparatus

5.1 *Pump Test Stand*—Detailed drawings are available.³ The copper, brass, and bronze flow circuit is illustrated in Fig. 1.

³ Detail drawings of this apparatus and accompanying table of parts are available from ASTM International Headquarters. Order Adjunct No. ADJD2809. Original adjunct produced in 1985.

TABLE 1 Rating System^{A, B}

Rating	Condition
10	No corrosion or erosion present; no metal loss. No change from original casting configuration. Staining permitted.
9	Minimal corrosion or erosion. Some rounding of sharp corners or light smoothing or both, or polishing of working surfaces.
8	Light corrosion or erosion may be generalized on working surfaces. Dimensional change not to exceed 0.4 mm ($\frac{1}{64}$ in.).
7	Corrosion or erosion with dimensional change not to exceed 0.8 mm ($\frac{1}{32}$ in.). Random pitting to 0.8 mm permitted.
6	Corrosion or erosion with dimensional change not to exceed 0.8 mm. Depressions, grooves, clusters of pits, or scalloping, or both, within 0.8 mm dimensional change limit permitted.
5	Corrosion or erosion with dimensional change not to exceed 1.6 mm ($\frac{1}{16}$ in.). Small localized areas of metal removal in high-impingement regions or random pits to 1.6 mm permitted.
4	Corrosion or erosion with dimensional change not to exceed 1.6 mm. Small localized areas of metal removal in high-impingement regions, clusters of pits within 1.6 mm dimensional change. Random pits to 2.4 mm ($\frac{3}{32}$ in.) permitted.
3	Corrosion or erosion with dimensional change not to exceed 2.4 mm. Depressions, grooves, clusters of pits or scalloping, or both, permitted.
2	Corrosion or erosion with any dimensional change over 2.4 mm, and short of pump case failure.
1	Pump case leaking due to corrosion or erosion.

^A If placement in a rating group is uncertain or border-line, elevate the rating to the higher of the two groups in question.

^B Ratings 1 to 3 are dependent on pump-wall thickness and are intended to be used as relative ratings for tests using a given pump.

The apparatus should be assembled upon a suitable platform or structure, with provisions for mounting controls and gages.

5.2 Warning—*The entire stand should be screened or housed to protect personnel from hazardous scalding coolant in case of rupture in the pump, hose, or tubing.* All belts and pulleys should be properly shielded.

5.3 Test Pump—Standard aluminum automotive water pump and engine front cover assemblies shall be used. The same make and model must be used throughout a series of tests when tests are conducted to evaluate coolants.⁴

NOTE 3—If it is desired to evaluate pumps on this test apparatus, a coolant of a known level of cavitation corrosion and erosion-corrosion protection should be used.

6. Test Solution

6.1 The test coolant is prepared by adding one part engine coolant concentrate to five parts corrosive water by volume. The water shall contain 100 ppm each of sulfate, chloride, and bicarbonate ions, added as sodium salts.

NOTE 4—The specified corrosive water can be prepared by dissolving the following amounts of reagent grade anhydrous sodium salts in a quantity of distilled or deionized water:

sodium sulfate	148 mg
sodium chloride	165 mg
sodium bicarbonate	138 mg

The resulting solution should be made up to a volume of 1 L with distilled or deionized water at 20 °C.

⁴ 1984 Buick pump GM #25527536 and engine front cover GM 25515465 shall be designated as test standards. The pump gasket is GM #1358410, and the gasket at the back of the front engine cover is GM #25519994. In the event that GM #25527536 is not available, AC Delco 12307821 or Master CP1018 may be used.

If relatively large amounts of corrosive water are needed for testing, a concentrate may be prepared by dissolving ten times the above amounts of the three chemicals, in distilled or deionized water, and adjusting the total volume to 1 L by further additions of distilled or deionized water. When needed, the corrosion water concentrate is diluted to the ratio of one part by volume of concentrate to nine parts of distilled or deionized water.

7. Sampling

7.1 The coolant concentration shall be sampled in accordance with Practice D1176.

8. Procedure

8.1 Before each test is begun, clean the test apparatus as follows:

8.1.1 Remove and replace all hose (hose shall not be used for more than one test), set the throttling valve to full open position, and install a standard automotive water pump as the flushing pump to circulate cleaning solution.

8.1.2 Fill the system with a solution made of 162 g (5.7 oz) of detergent⁵ in 17 L (18 qt) of cool tap water. (The total capacity of the system is approximately 17.5 L (18.5 qt).) Reduce the pump speed to approximately 2675 r/min to minimize heat buildup. Start the pump and circulate for 15 min. Drain.

8.1.3 Fill with tap water. Start the pump and circulate for 5 min. Drain. Perform this operation three times.

NOTE 5—This cleaning procedure supercedes one using chromic acid, a recognized hazard. A Subcommittee D15.09 task force is currently qualifying this cleaning procedure.

8.1.4 Fill the system with a cleaning solution containing 73.5 g of oxalic acid dihydrate and 52.5 g of citric acid per litre of water. (These chemicals may be technical grade.)

8.1.5 Raise the temperature to 82°C (180°F) with the pump operating at approximately 2675 r/min and the heater on. When the temperature is reached, turn off the heater. Circulate the cleaning solution for 1 h. (If the temperature rises above 90°C (194°F), cool the system with the fan.) Drain the system.

8.1.6 Repeat step 8.1.3.

8.1.7 Circulate a solution made of 820 g (1.8 lb) of sodium carbonate (technical grade) in 17 L (18 qt) of cool tap water for 10 min. Circulating this solution in excess of 10 min may cause carbonates to form on copper components. Drain.

8.1.8 Fill with tap water and circulate water for approximately 3 min. Drain.

8.1.9 Repeat step 8.1.8 three times.

8.1.10 Take a sample of the last flush water. Make a 5 mass % solution of calcium chloride (reagent grade) with a sample of the water. If turbidity or precipitation results, repeat steps 8.1.8 and 8.1.10 until solution is clear.

8.2 Install a new test pump assembly on the test stand. Do not use a gasket sealer in assembling the pump.

8.3 Shake the test coolant well and fill the main system with approximately 14 L (14.5 qt). Engage the pump in a few momentary starts to allow trapped air to vent out the fill hole. Add 2 L (2 qt) of test coolant to the expansion tank (see Section 5).

⁵ Alconox detergent, E. H. Sargent & Co., has been found satisfactory for this purpose.

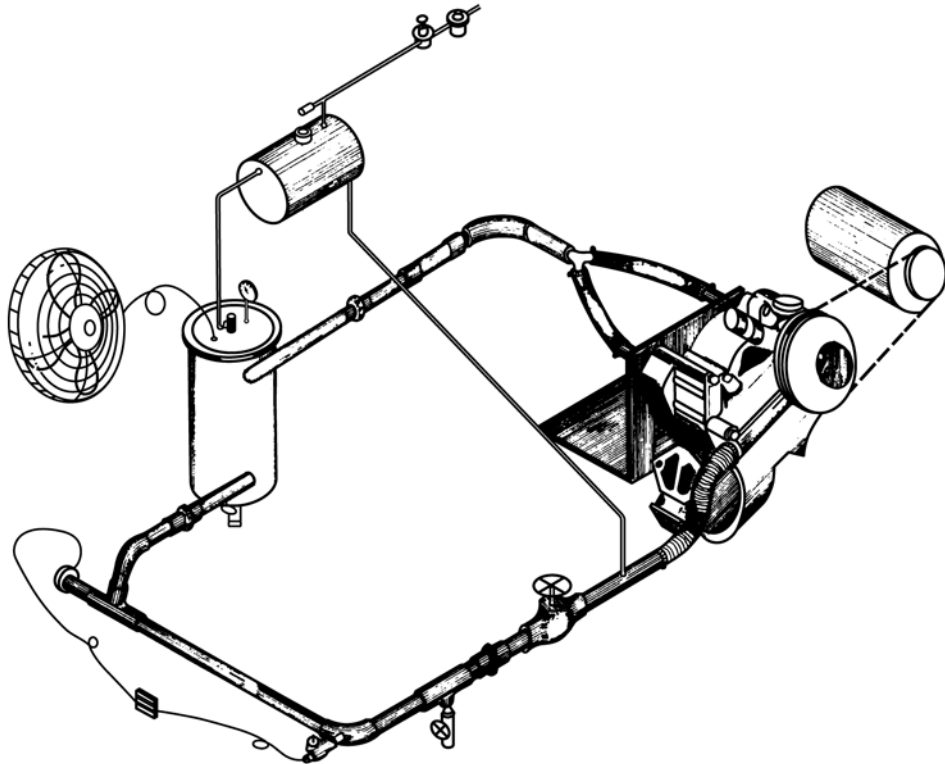

FIG. 1 Aluminum Pump Cavitation Corrosion and Erosion-Corrosion Test Stand

8.4 Start the test and adjust to the following conditions:

8.4.1 Pump speed to 4600 ± 100 r/min. Speed may be measured by digital tachometer, optical tachometer, or any other method that gives the required accuracy.

8.4.2 Coolant temperature to 35 to 38 °C (95 to 100 °F).

8.4.3 System pressure to 103 ± 3 kPa (15 ± 0.5 psig).

8.4.4 Inlet pressure at pump to provide a gage reading of 6.8 kPa (2.0 in. Hg) vacuum by adjusting the throttling valve.

8.5 After test conditions in 8.4 are obtained, increase the coolant temperature to 113 ± 1 °C (235 ± 2 °F). Do not adjust the throttling valve from the position obtained in 8.4.4. Maintain the system pressure at 103 kPa (15 psig).

8.6 Operate the pump for 100 h.

8.6.1 The pump may be stopped for nightly equipment shutdown and to maintain liquid level.

8.6.2 No more than 1 L (1 qt) of coolant makeup solution may be added during the total duration of the test.

8.7 Remove the pump assembly, wash the pump, front cover, and impeller with clean water, and dry parts for visual observation.

9. Rating System

9.1 Rate the degree of corrosion and erosion-corrosion in accordance with the ratings described in Table 1.

10. Precision and Bias

10.1 The precision of this test method is based on interlaboratory study of Test Method D2809, conducted in 2008. Each of four laboratories tested two coolants. Every “test result” represents an individual determination. Each laboratory was asked to report duplicate rating results. Except for the limited variety of materials tested, and the availability of replicate data from only four laboratories, Practice E691 was followed for the design and analysis of the data; the details are given in a research report.⁶

10.1.1 *Repeatability Limit (r)*—Two test results obtained within one laboratory shall be judged not equivalent if they differ by more than the “*r*” value for that material; “*r*” is the

⁶ Supporting data have been filed at ASTM International Headquarters and may be obtained by requesting RR:D15-1025.

TABLE 2 Cavitation Rating (units)

Material	Average ^A \bar{x}	Repeatability Standard Deviation S_r	Reproducibility Standard Deviation S_R	Repeatability Limit r	Reproducibility Limit R
Sample 1 Pink	8.5	0.5	0.5	1.4	1.5
Sample 2 Green	9.3	1.2	1.2	3.2	3.2

^A The average of the laboratories’ calculated averages.

interval representing the critical difference between two test results for the same material, obtained by the same operator using the same equipment on the same day in the same laboratory.

10.1.1.1 Repeatability limits are listed in **Table 2**.

10.1.2 *Reproducibility Limit (R)*—Two test results shall be judged not equivalent if they differ by more than the “R” value for that material; “R” is the interval representing the critical difference between two test results for the same material, obtained by different operators using different equipment in different laboratories.

10.1.2.1 Reproducibility limits are listed in **Table 2**.

10.1.3 The above terms (repeatability limit and reproducibility limit) are used as specified in Practice **E177**.

10.1.4 Any judgment in accordance with **10.1.1** and **10.1.2** would normally have an approximate 95 % probability of being correct, however the precision statistics obtained in the ILS must not be treated as exact mathematical quantities which are applicable to all circumstances and uses. The limited number

of reporting laboratories, and materials tested, guarantees that there will be times when differences greater than predicted by the ILS results will arise, sometimes with considerably greater or smaller frequency than the 95 % probability limit would imply. Consider the repeatability limit and the reproducibility limit as general guides, and the associated probability of 95 % as only a rough indicator of what can be expected.

10.2 *Bias*—At the time of the study, there was no accepted reference material suitable for determining the bias for this test method, therefore no statement on bias is being made.

10.3 The precision statement was determined through statistical examination of 16 results, from four laboratories, on the two coolants described below:

Sample 1 Pink

Sample 2 Green

11. Keywords

11.1 aluminum; automotive; cavitation corrosion; engine coolant; erosion-corrosion; pumps; test

APPENDIXES

(Nonmandatory Information)

X1. TYPICALLY ERODED PUMPS AFTER TEST

X1.1 See **Figs. X1.1-X1.10**.

NOTE X1.1—Ratings 3 and 4 are not pictured, but will be more severe

versions of Rating 5 with the final rating determined by actual measurement.

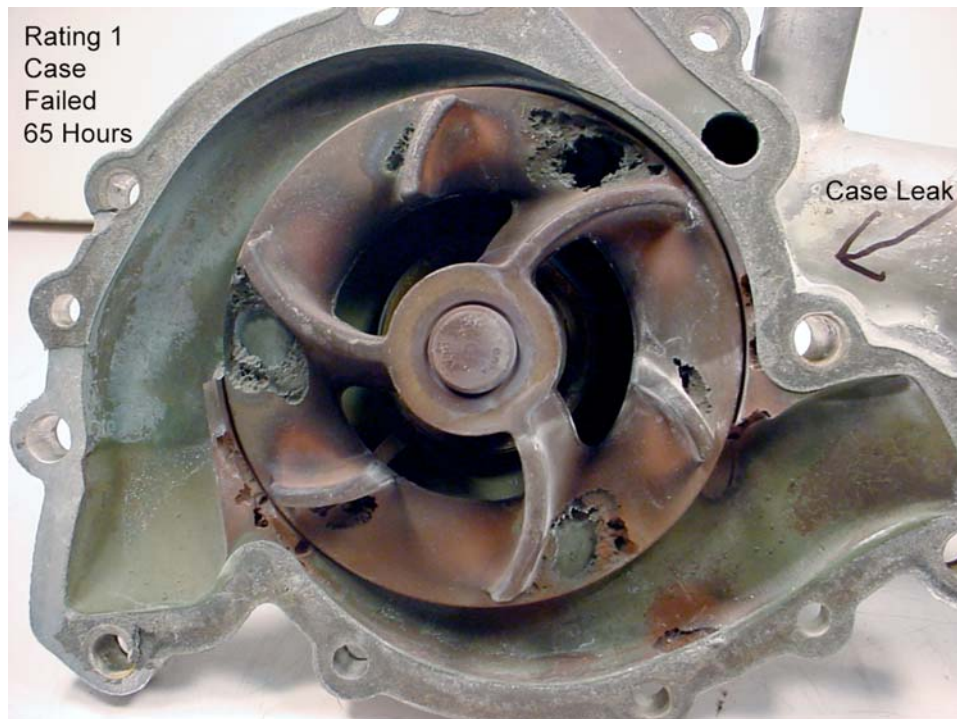

FIG. X1.1 Rating 1

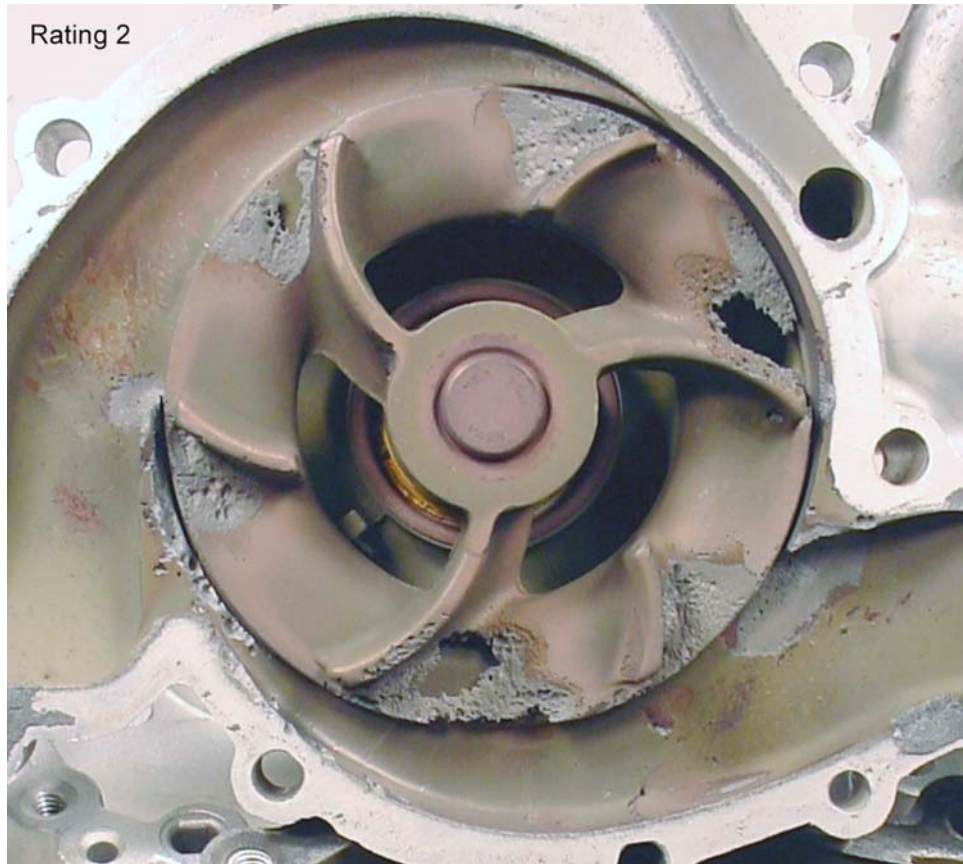

FIG. X1.2 Rating 2

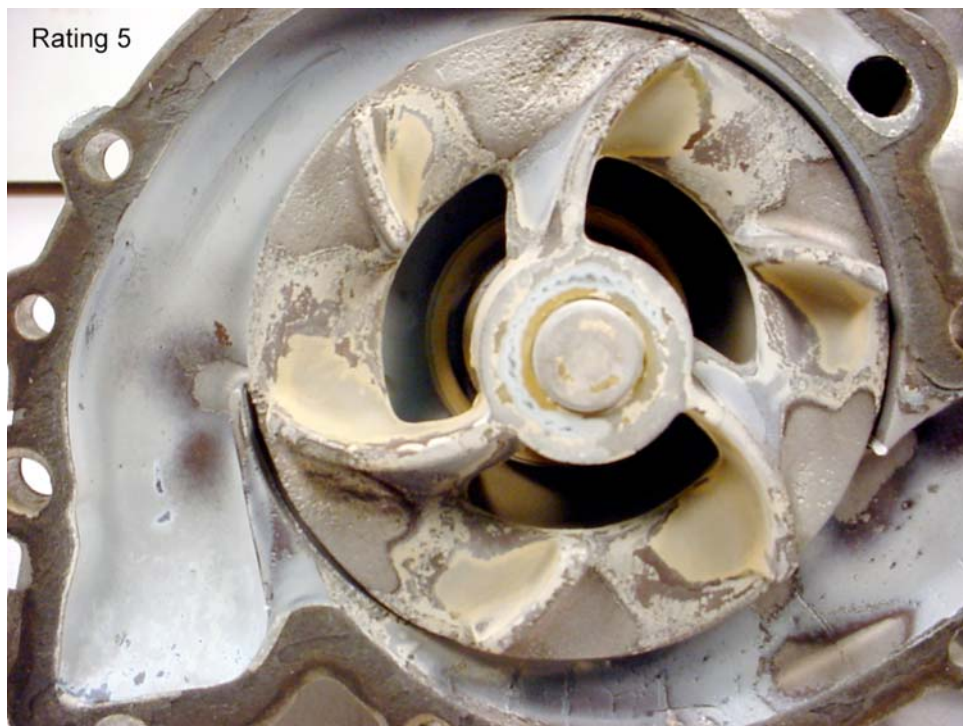

FIG. X1.3 Rating 5

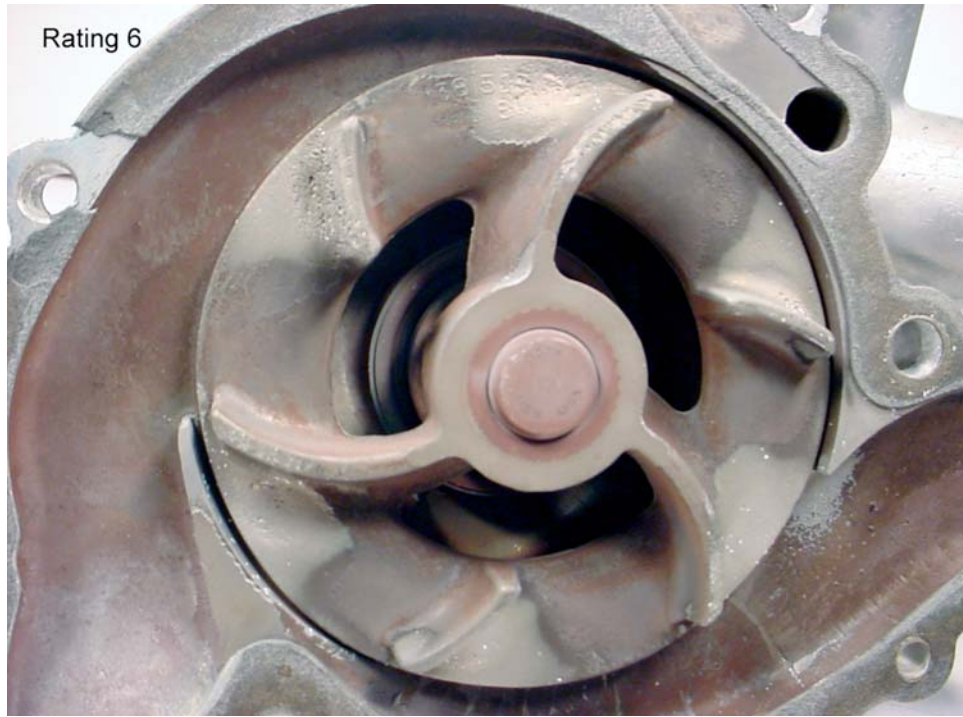

FIG. X1.4 Rating 6



FIG. X1.5 Rating 7-Example 1

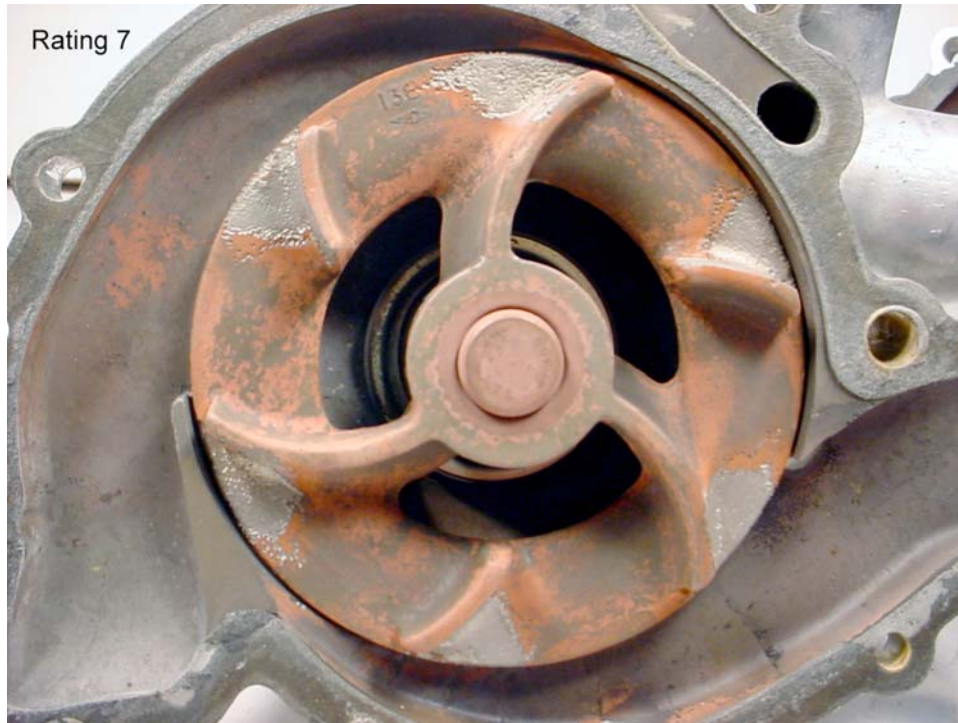

FIG. X1.6 Rating 7—Example 2

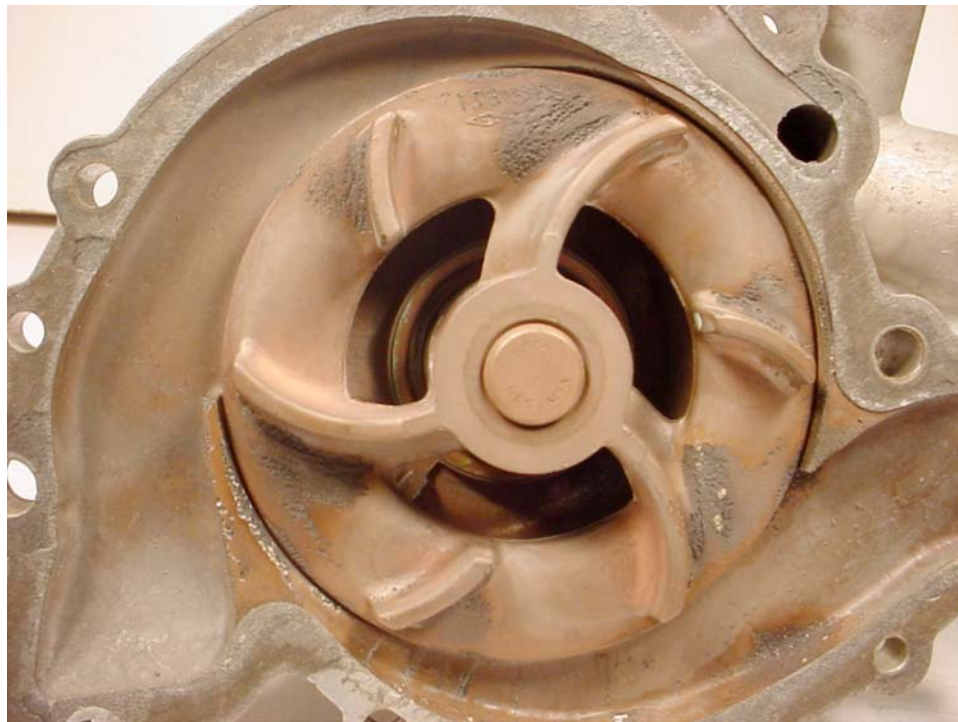

FIG. X1.7 Rating 8—Example 1

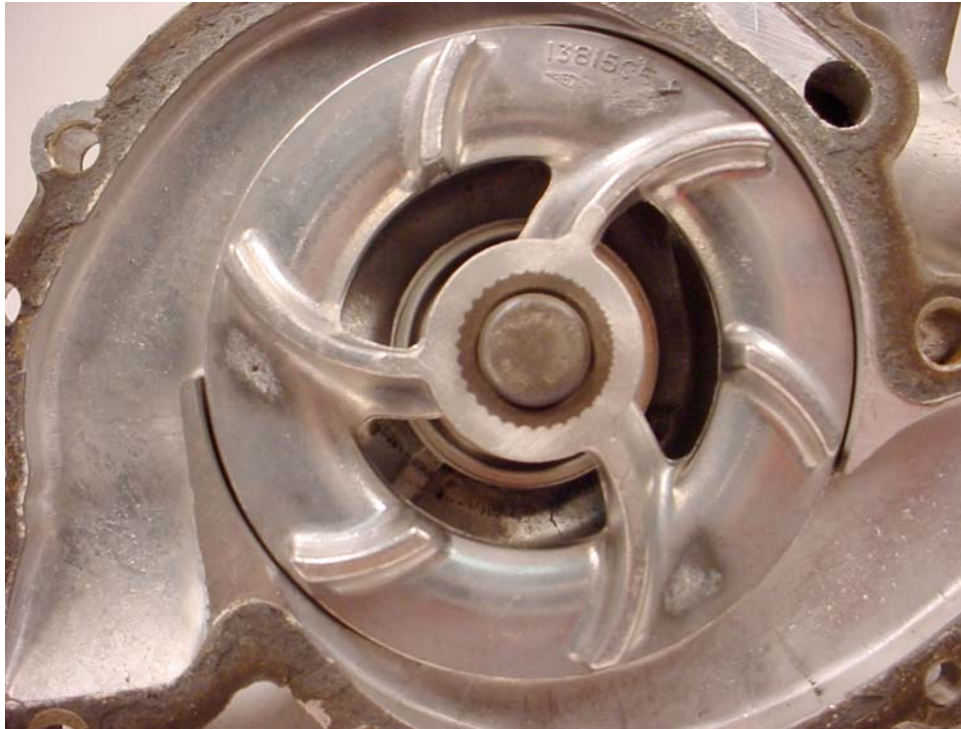

FIG. X1.8 Rating 8—Example 2

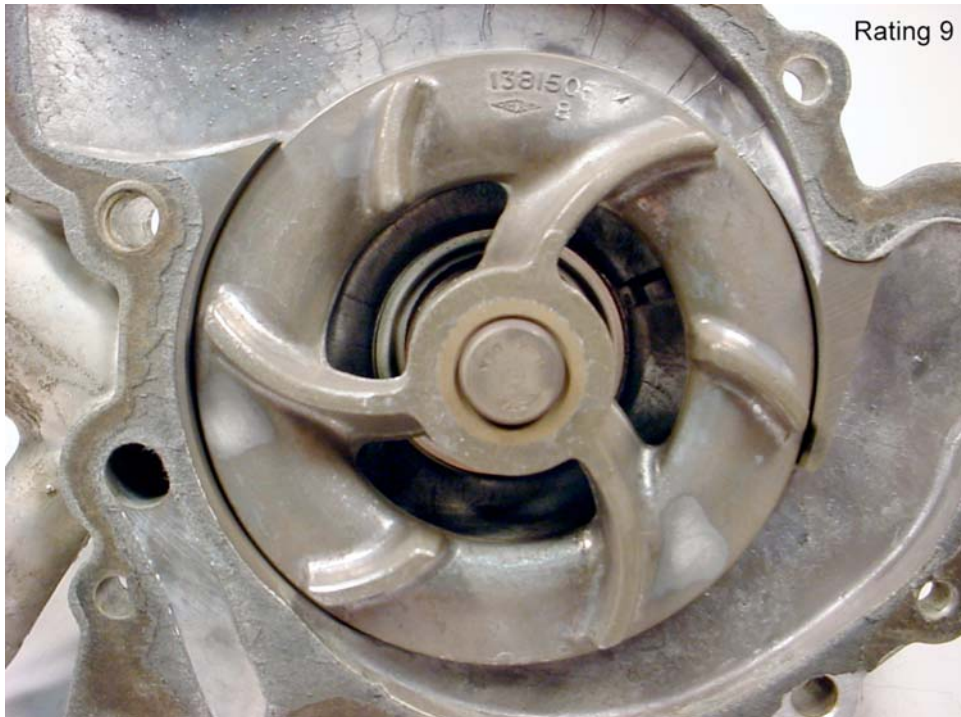

FIG. X1.9 Rating 9

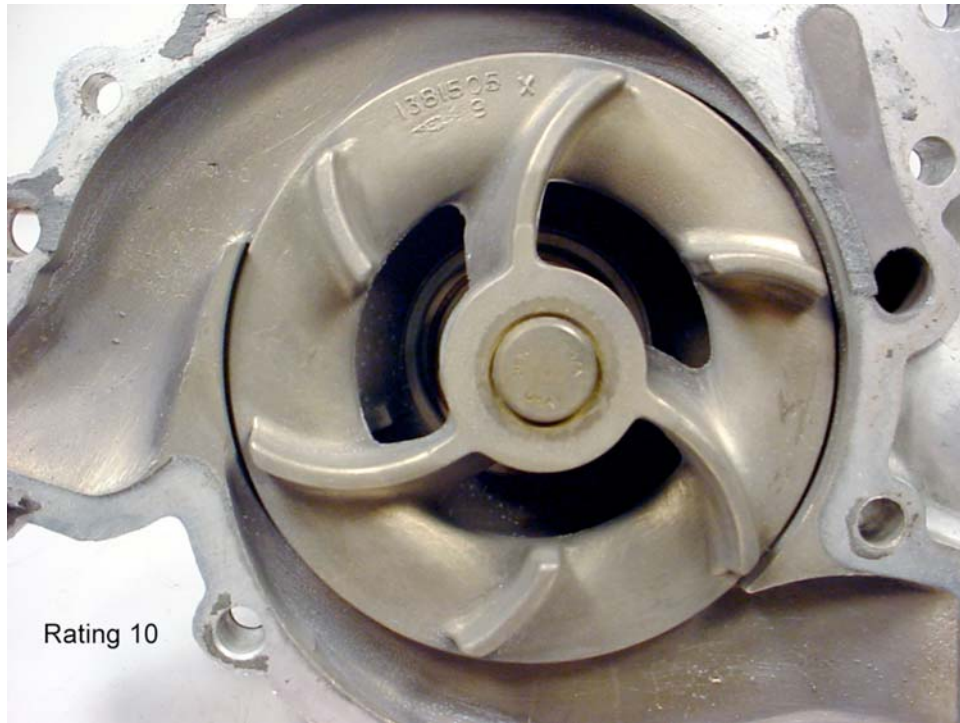

FIG. X1.10 Rating 10

X2. MEASURING DIMENSIONAL CHANGE

X2.1 A suggestion for quantifying the dimensional change of pump erosion damage follows. See [Fig. X2.1](#).

Tools required:
A calibrated micrometer with both caliper and probe capabilities.



Using the probe and bridging the shoulders of the eroded area, measure the damaged area carefully in between each impeller vane. Repeat the measurement three times and calculate the average. Use the average of the three measurements to determine the rating of the pump. A total of six areas are to be measured.



The table at right is an example of a set of measurements. Since the deepest damage was found to average 0.32 mm in area "1", this pump would merit a rating of "8". The pump areas are illustrated below:

	Area					
	1	2	3	4	5	6
1	0.42	0.31	0.24	0.12	0.15	0.19
2	0.22	0.22	0.18	0.25	0.11	0.18
3	0.32	0.17	0.23	0.16	0.08	0.16
average	0.32	0.23	0.22	0.18	0.11	0.18

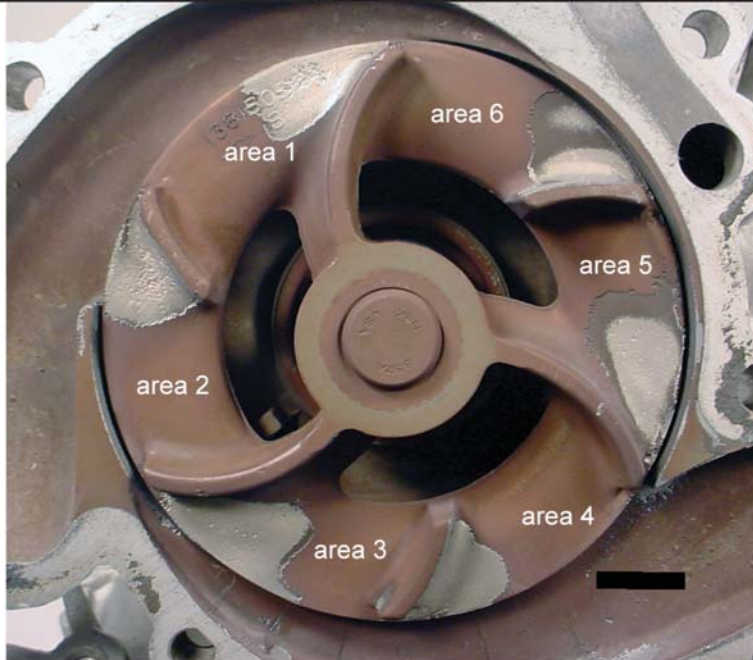



FIG. X2.1

 **D2809 – 09 (2017)**

ASTM International takes no position respecting the validity of any patent rights asserted in connection with any item mentioned in this standard. Users of this standard are expressly advised that determination of the validity of any such patent rights, and the risk of infringement of such rights, are entirely their own responsibility.

This standard is subject to revision at any time by the responsible technical committee and must be reviewed every five years and if not revised, either reapproved or withdrawn. Your comments are invited either for revision of this standard or for additional standards and should be addressed to ASTM International Headquarters. Your comments will receive careful consideration at a meeting of the responsible technical committee, which you may attend. If you feel that your comments have not received a fair hearing you should make your views known to the ASTM Committee on Standards, at the address shown below.

This standard is copyrighted by ASTM International, 100 Barr Harbor Drive, PO Box C700, West Conshohocken, PA 19428-2959, United States. Individual reprints (single or multiple copies) of this standard may be obtained by contacting ASTM at the above address or at 610-832-9585 (phone), 610-832-9555 (fax), or service@astm.org (e-mail); or through the ASTM website (www.astm.org). Permission rights to photocopy the standard may also be secured from the Copyright Clearance Center, 222 Rosewood Drive, Danvers, MA 01923, Tel: (978) 646-2600; <http://www.copyright.com/>