



Standard Test Method for Resistance to Environmental Degradation of Electrical Pressure Connections Involving Aluminum and Intended for Residential Applications¹

This standard is issued under the fixed designation B812; the number immediately following the designation indicates the year of original adoption or, in the case of revision, the year of last revision. A number in parentheses indicates the year of last reapproval. A superscript epsilon (ϵ) indicates an editorial change since the last revision or reapproval.

INTRODUCTION

Electrical pressure connection systems involving aluminum are those in which one or more of the components of the system in the direct electrical path or carrying any electrical current is fabricated of aluminum, including aluminum wires, aluminum bus bars, aluminum bolts, aluminum terminations, or any other aluminum current-carrying member. Included are systems which must carry current for safety purposes such as ground shields or straps attached to aluminum framing or other structural members. Pressure connection systems can be evaluated by this test method. Such systems are comprised of the wire or other structure being connected and the means of connection, any element of which is made of aluminum.

Connection systems tested are exposed sequentially to ambients of high relative humidity and temperature cycles of 75°C, such as may be encountered by some connections in actual residential applications. Periodic observation of the potential drop across the connection interfaces while carrying rated current provides a measurement of connection performance.

1. Scope

1.1 This test method covers all residential pressure connection systems. Detailed examples of application to specific types of connection systems, set-screw neutral bus connectors and twist-on wire-splicing connectors, are provided in [Appendix X1](#) and [Appendix X2](#).

1.2 The purpose of this test method is to evaluate the performance of residential electrical pressure connection systems under conditions of cyclic temperature change (within rating) and high humidity.

1.3 The limitations of the test method are as follows:

1.3.1 This test method shall not be considered to confirm a specific lifetime in application environments.

1.3.2 The applicability of this test method is limited to pressure connection systems rated at or below 600 V d-c or a-c RMS.

1.3.3 This test method is limited to temperature and water vapor exposure in addition to electrical current as required to measure connection resistance.

1.3.4 This test method does not evaluate degradation which may occur in residential applications due to exposure of the electrical connection system to additional environmental constituents such as (but not limited to) the following examples:

1.3.4.1 Household chemicals (liquid or gaseous) such as ammonia, bleach, or other cleaning agents.

1.3.4.2 Chemicals as may occur due to normal hobby or professional activities such as photography, painting, sculpture, or similar activities.

1.3.4.3 Environments encountered during construction or remodeling such as direct exposure to rain, uncured wet concrete, welding or soldering fluxes and other agents.

1.3.5 This test method is limited to evaluation of pressure connection systems.

1.4 *This standard does not purport to address all of the safety concerns, if any, associated with its use. It is the responsibility of the user of this standard to become familiar with all hazards including those identified in the appropriate Material Safety Data Sheet (MSDS) for this product/material as provided by the manufacturer, to establish appropriate safety and health practices, and determine the applicability of regulatory limitations prior to use.*

1.5 *This standard should be used to measure and describe the properties of materials, products, or assemblies in response to electrical current flow under controlled laboratory conditions and should not be used to describe or appraise the fire*

¹ This test method is under the jurisdiction of ASTM Committee B02 on Nonferrous Metals and Alloys and is the direct responsibility of Subcommittee B02.11 on Electrical Contact Test Methods.

Current edition approved Aug. 1, 2013. Published August 2013. Originally approved in 1990. Last previous edition approved in 2008 as B812 – 96 (2008). DOI: 10.1520/B0812-96R13.

hazard or fire risk of materials, products, or assemblies under actual installation conditions or under actual fire conditions. However, results of this test may be used as elements of a fire risk assessment which takes into account all of the factors which are pertinent to an assessment of the fire hazard of a particular end use.

2. Referenced Documents

2.1 *ASTM Standards*:²

B542 [Terminology Relating to Electrical Contacts and Their Use](#)

2.2 *Underwriter Laboratory Standards*:

UL486B [Standard for Wire Connectors For Use With Aluminum Conductors, ANSI/UL 486B](#)³

UL486C [Standard for Splicing Wire Connectors](#)³

2.3 *NEC Document*:

ANSI/NFPA 70 [National Electric Code](#)⁴

3. Terminology

3.1 *residential applications, n*—residential applications are those involving a structure or vehicle used entirely for permanent or temporary human habitation. Included are homes (single or multiple-unit houses and mobile or modular structures), motels, hotels, dormitories, hospitals, rest homes, and recreational vehicles. Excluded are railroad cars, boats, airplanes, nonresidential, commercial (office buildings, stores) and industrial applications (factories, warehouses).

3.2 *pressure connection system, n*—an electrical connection intended to carry current between components or conductors in contact under mechanical pressure.

3.2.1 *Discussion*—The mechanical pressure may be applied by clamping, tightening of threaded components, spring force, crimping, swaging, or other means. For the purpose of the test procedure, the connection system consists of all components normally present in the application, including both current-carrying and other metallic components, and non-metallic components (insulators, insulation, protective boots or sleeve, etc.). Also see definition of “Connection, Pressure (Solderless),” in Article 100 of reference noted in Section 2.3 (NEC).

3.3 *aluminum, n*—as the term “aluminum,” the material of which conductors (wire, cable, busbars, etc.), connection components, and test board components may be made, includes aluminum metal and its alloys.

3.4 *reference conductor, n*—a continuous length of the same conductor material (wire, cable, busbar, etc.) incorporated in the connection system being tested by being mounted on the same test board assembly and connected in the same series circuit.

² For referenced ASTM standards, visit the ASTM website, www.astm.org, or contact ASTM Customer Service at service@astm.org. For *Annual Book of ASTM Standards* volume information, refer to the standard’s Document Summary page on the ASTM website.

³ Available from Underwriters Laboratories (UL), 333 Pfingsten Rd., Northbrook, IL 60062-2096, <http://www.ul.com>.

⁴ Available from National Fire Protection Association (NFPA), 1 Batterymarch Park, Quincy, MA 02169-7471, <http://www.nfpa.org>.

3.5 *reference connection system, n*—the reference connection system is the same connection system as that which is under evaluation, but which is exposed only to a dry environment at normal room temperature.

4. Summary of Test Method

4.1 The environmental exposure of the connections tested consists of weekly sequences consisting of five thermal cycles of 75°C temperature change (taking a maximum of 8 h to accomplish), followed by exposure for the balance of the week to conditions at or near 100 % relative humidity at room temperature. The text exposure cycle is repeated for a minimum of four one-week cycles. Reference connections are kept in a dry environment at room temperature for the same duration. Potential drop measurements, at rated current, are made prior to each weekly environmental exposure cycle, and a final set of measurements is taken at the end of the test.

5. Significance and Use

5.1 The principal underlying the test is the sensitivity of the electrical contact interface to temperature and humidity cycling that electrical pressure connection systems experience as a result of usage and installation environment. The temperature cycling may cause micromotion at the mating electrical contact surfaces which can expose fresh metal to the local ambient atmosphere. The humidity exposure is known to facilitate corrosion on freshly exposed metal surfaces. Thus, for those connection systems that do not maintain stable metal-to-metal contact surfaces under the condition of thermal cycling and humidity exposure, repeated sequences of these exposures lead to degradation of the contacting surface indicated by potential drop increase.

5.2 The test is of short duration relative to the expected life of connections in residential usage. Stability of connection resistance implies resistance to deterioration due to environmental conditions encountered in residential service. Increasing connection resistance as a result of the test exposure indicates deterioration of electrical contact interfaces. Assurance of long term reliability and safety of connection types that deteriorate requires further evaluation for specific specified environments and applications.

5.3 *Use*—It is recommended that this test method be used in one of two ways. First, it may be used to evaluate and report the performance of a particular connection system. For such use, it is appropriate to report the results in a summary (or tabular) format such as shown in Section 17, together with the statement “The results shown in the summary (or table) were obtained for (insert description of connection) when tested in accordance with Test Method B812. Second, it may be used as the basis for specification of acceptability of product. For this use, the minimum test time and the maximum allowable increase in potential drop must be established by the specifier. Specification of connection systems in accordance with this use of the standard test method would be of the form: “The maximum potential drop increase for any connection, when tested in accordance with Test Method B812 for a period of weeks, shall be mV relative to the reference connections.” Connection systems that are most resistant to thermal-cycle/

humidity deterioration, within the limitations of determination by this test method, show no increase in potential drop, relative to the reference connections, when tested for indefinite time. Connections that are less resistant to thermal-cycle/humidity conditions applied by this test will demonstrate progressive increases in potential drop with increasing time on test. Thus, the following examples of specifications are in the order of most stringent (No. 1) to least stringent (No. 3).

	Duration, weeks	Maximum Potential Drop Increase, mV
1.	52	0
2.	16	0.2
3.	4	1.0

6. Interferences

6.1 *Temperature*—Because resistance of metallic conductors is a function of temperature, provision of a standard length of conductor wire has been provided to permit correction for room temperature changes for potential drop measurements. However, degraded electrical connections among the test samples can be a source of abnormal heat during the measurements (when current is flowing), causing temperature variations from point-to-point on the test assembly. If individual connections are noted to be heating abnormally when potential drop measurements are being made (as determined by relatively high potential drop), it is desirable to minimize temperature nonuniformity by using temporary thermal isolation barriers.

6.2 *Current*—Current variation during the measurement leads to erratic results. Calibration of the required constant current source shall be maintained.

6.3 *Instruments*—Instrument stability shall be maintained by means of frequent calibration checks. Stability of reference voltage drop across a standard resistor should be maintained to within the instrument ratings by checks both before and after each group of measurements.

6.4 *Magnetic Fields*—Voltage signals resulting from stray magnetic fields intersecting the voltage probe leads or power supply leads need to be assessed prior to beginning each series of measurements. Generally, this can be done by moving the leads and observing the resultant voltage changes. Alternatively, a source of stray magnetic field such as an energized autotransformer can be moved adjacent to the measurement circuit for detection of voltage changes. If voltage instability is observed, corrective action such as shielding or removal of magnetic field sources is required.

7. Apparatus

7.1 *Materials*—Other than materials normally considered to be part of the connection system being evaluated, materials selected for use in the test system (for construction of test frames, fixturing, humidity chamber, etc.) shall be resistant to outgassing at the maximum temperature of use in the test.

7.2 *Humidity Vessel*—The humidity vessel shall be a clean sealed chamber, the bottom of which is covered with deionized water to a depth of approximately 30 mm, and a platform for samples above the water level. The vessel shall include a shield to prevent condensate dripping onto test samples. The material of the humidity vessel shall be inert with regards to humidity

such that no contamination of test samples or deionized water occurs. The vessel is to be operated in a normal laboratory environment which has continuous temperature control during the period of the test.

NOTE 1—This apparatus is intended to expose samples to relative humidity at or near 100 %.

7.3 *Temperature Chamber*—The temperature chamber shall be capable of control at the defined upper temperature of the thermal cycle such that chamber temperature stability, uniformity, and control accuracy shall be within $\pm 2^\circ\text{C}$. The lower temperature of the cycle may be achieved in the same chamber, if it is capable of cooling to the lower defined temperature. Alternatively, the thermal cycle can be achieved by transfer between the high-temperature chamber and a room-temperature environment or cold chamber, depending on the prescribed low temperature of the thermal cycle.

7.4 *Power*—A 50/60 Hz ac constant current supply is required, capable of continuously maintaining the specified test current within $\pm 1\%$. For safety reasons, the maximum output potential at open circuit shall be 12 V and the supply output must be isolated from the 120/240 volt alternating current (VAC) primary circuit.

7.5 *Test Board*—A mounting board or frame shall be provided for the test samples such that the board or frame be inert with regard to humidity and dimensionally stable with regard to the thermal cycle of 75°C temperature change. To the extent possible, the thermal expansion coefficient shall match that of the material being tested. (Example: frame shall be aluminum if aluminum wire or cable is a major part of the connection system being tested.) The board or frame shall provide for mechanical mounting of the test samples such that individual samples are independent of adjacent samples in regards to effects of mounting or the process of obtaining electrical measurements. As required by dimensions of the thermal or humidity chambers used, the test sample population may be divided among several test boards.

7.6 *Temperature Measurement*—Ambient and chamber temperature shall be measured by such apparatus as can detect 0.5°C temperature change within the desired range. A calibrated glass thermometer is acceptable for this purpose.

7.7 *Current Measurement*—An a-c ammeter capable of resolution of 0.5 % of the applied measurement current is required.

7.8 *Potential Drop Measurement*—A millivoltmeter capable of resolution of 0.01 mV is required for potential drop measurements.

8. Hazards

8.1 *Fire Hazards*—Degradation of electrical connections can lead to high resistance paths that are capable of significant self heating at the measuring current specified. Such high resistance paths can generate sufficient heat to provide a means of ignition of adjacent flammable material. Emergency power-off switches shall be provided in the immediate vicinity of the measurement apparatus. A fire extinguisher shall be available adjacent to the experiment. Care must be taken to ensure

freedom of the work area from stray flammable materials. If hazardous self heating of a connection or termination is observed, such connection or termination must be isolated or removed from the circuit so no further current flows through the degraded connection or termination before continuing with the evaluation.

8.2 Electrical Hazards—The test method provides for bare metal carrying current during the resistance measurement portion of the evaluation. Precautions shall be made to ensure that all test operators are informed as to the hazard associated with touching bare metal current carrying conductors so as to ensure that inadvertent contact with the test assembly is avoided. Voltage drop through the test samples is expected to be sufficiently low that little hazard is encountered even if inadvertent contact is made to the conductors unless the circuit is improperly assembled such that a high resistance path is provided. Voltage drop to ground must be measured prior to any other activity in order to assure absence of hazard. The voltage drop for the test setup from any point in the measurement circuit to ground should be less than 12 Vac. Should it be required, the test specimens may be measured in small groups so as to facilitate limiting the open-circuit potential.

9. Test Specimens

9.1 Connections tested shall be made of components and materials (connectors, aluminum conductor, bus bar, etc.) that are representative of the application, and, whenever possible, shall be products procured from the normal chain of distribution.

10. Sample Preparation, Mounting, and Interconnection

10.1 Sample size for each test group shall comprise a minimum of 20 individual identical connections.

10.2 For connection types that encompass a range of combinations of sizes or numbers of conductors, or both, a sufficient number of test sample groups (20 connections, minimum, each group) spanning the range of applications with respect to conductor size, number, and type of conductors, or other key variables, or a combination thereof, shall be tested to meet the following criterion. The estimated coefficient of variation of any possible untested sample group shall lie within a factor of two of the observed coefficient of variation measured over all groups tested, at a confidence level of 90 %. This criterion requires five groups to be tested, spanning the range of application combinations. Obtain the coefficient of variation for a tested group by dividing the standard deviation of the group by the mean of the group. (Procedures for estimating the coefficient of variation of untested sample groups can be found in **Note 2**.) A more stringent ratio limit or higher confidence level than those previously noted (2X at 90 % confidence level), or both, may be specified. (Examples: 2X at 99 % confidence level requires a minimum of seven groups to be tested; 1.5X at 90 % confidence level requires a minimum of ten groups to be tested.)

NOTE 2—Hogg, R. B., and Craig, A. T., Introduction to *Mathematical Statistics*, 4th edition, Macmillan, 1974.

10.3 Modifications to components of the connection system (bus bar, connectors, etc.) may be required for mounting or

other purposes associated with the test. Such modifications shall be made so that the test connections and contact interfaces are not changed relative to standard installation or application. As examples, protect contact interfaces from contamination with cutting or threading lubricant, particulate contamination, and solvent cleaning, any of which may influence connection test performance. Take precautions to protect the contact interfaces and keep them in normal state prior to assembling the connections. (Example: see **Appendix X1** for precautions taken when cutting neutral bus into short sections.)

10.4 **Mounting of Test Samples**—Mount the test samples to the test board via insulating ceramic standoffs or other appropriate structure of an insulating material resistant to outgassing at the upper limit of the temperature cycle. Electrically isolate each test sample from the test board. When through-threaded insulating standoffs are utilized, with screws inserted from both openings, provide at least 3 mm (1/8 in.) spacing between the ends of the screws to assure electrical isolation.

10.5 **Interconnecting Test Samples**—Connect test samples into a series circuit. To avoid unusual stresses on the test connections due to thermal expansion or other factors or both incorporate bends or offsets, or both, into the design of the mechanical layout (see **Appendix X1** and **Appendix X2** for examples). Position and firmly fasten down all the components before final tightening of the test connections.

10.6 **Provision for Making Potential Drop Measurements**—There are two methods of providing for potential drop measurements; the choice of which one is used depends on the configuration of the test connection.

10.6.1 **Four-Wire Method**—This method is used when the test connection allows access to non-current carrying extensions of the primary conductors. Schematically, this is shown in **Fig. 1**. Access to bare-metal conductor is provided at points X and Y for attachment of the meter probes. The potential drop measured in this way is essentially that due to the contact resistance alone. An example of the application of this method is in **Appendix X1**.

10.6.2 **Alternative Method**—When the four-wire method cannot be applied due to the particular configuration of the connection being tested, access to metallic conductor is to be provided at points in the current path, as shown schematically in **Fig. 2**. The measurement access points X and Y are to be uniformly distanced from the test connection for each sample. Potential drop measured by this method includes bulk conductor resistance as well as contact resistance. An example of this case is shown in **Appendix X2**. For this method, a length of

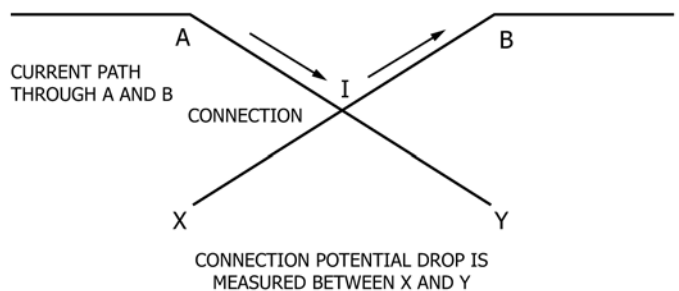

FIG. 1 Four-Wire Method of Measuring Connection Potential Drop

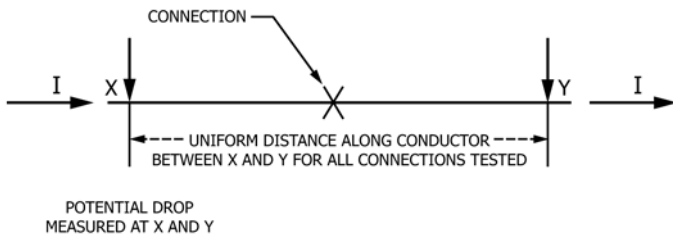

FIG. 2 Alternative Method of Measuring Connection Potential Drop

reference conductor of the same material and with bulk resistance approximately equal to the bulk resistance included in the connection measurements shall be installed in the series circuit of each test board.

10.7 Standoffs shall be used to support conductors at points where potential drop measurement probes are to be applied so as to minimize the mechanical disturbance of the test connections during attachment and removal of the probes.

10.8 *Installing Test Connections*—Make all test connections in accordance with manufacturer’s instructions. Abrasion of wire surface, application of corrosion inhibitor, or other installation practices sometimes employed shall not be used unless specifically required by the manufacturer’s written installation or assembly instructions provided with the product as sold. With respect to tightening torque of bolted, setscrew, twist-on, or other threaded tool or hand-tightened connection types, use the tightening torque or tightening procedure specified by the manufacturer in the instructions normally supplied with the product. When no torque value or tightening procedure is specified in the manufacturer’s instructions, use the heat-cycle torque values in the appropriate tables of UL486B or UL486C (See Section 2 on Referenced Documents) to select the installation torque. When required to tighten to a specific torque value, use a torque-measuring or torque-limiting wrench or driver at assembly to assure uniform tightening of the test connections. Connections to be tested shall be tightened last, after all conductor support and strain-relief attachment points are tightened.

10.9 *Measurement Points*

10.9.1 *Mechanical Support*—To minimize the possibility of mechanical disturbance of the test connections when potential drop measurements are made, conductors shall be mechanically supported at the points designated for the attachment of the instrument probes. This may be accomplished, for example, by the use of electrically-insulating standoffs mounted to the test board base.

10.9.2 *Strain Relief*—Conductors between the test connections and the measurement points shall be configured with right-angle or U bends to minimize stresses imposed on the test conductors by thermal expansion/contraction or by mechanical handling of the test board.

10.9.3 *Permanent Taps*—To assure consistent conductor length between measurement points for potential drop measurements of the reference conductor and for connections when the alternative method is used (Fig. 2 and Fig. 3), permanent taps shall be attached to the conductors. For the four-wire method, (Fig. 1 and Fig. 4), permanent taps may be used at the connector measurement points but are not mandatory. Permanent taps may be pressure connections, or spot welded or soldered. Pressure connections for this purpose may be integral with the mechanical support provided for the measurement points, as is illustrated in Appendix X1 and Appendix X2. If welded or soldered taps are used, make a provision to assure that the conductor at the connection is not changed from its original (as manufactured) condition by heat or chemicals, or both (such as soldering flux).

11. **Test Board Circuit**

11.1 When completed, each test board is a series circuit comprising the test connections, the interconnecting conductors, and reference conductors. Reference conductor length shall be such that its measured potential drop at the selected current is at least 100 times the resolution of the potential drop measurement instrument. Fig. 3 and Fig. 4 show the schematic circuits for the four-wire and alternative methods, respectively.

12. **Reference Connections**

12.1 Reference connection test boards, identical to those exposed to the thermal-cycle/humidity conditioning (below) are kept in a dry box (relative humidity <20 %) at room temperature, with measurements made at time-zero and at end of the test.

13. **Selection of Thermal Cycle Upper and Lower Temperatures**

13.1 A temperature difference of 75°C is required for this test, which can be most easily achieved by cycling between room temperature (25°C) and 100°C. If the connection system under test, or any component on the test board (such as wire insulation) has a rating lower than 100°C, then the lowest rated temperature is used as the upper boundary of the thermal cycle and the lower boundary of the thermal cycle is set at 75°C below that, requiring the use of a chamber that can cool below room temperature.

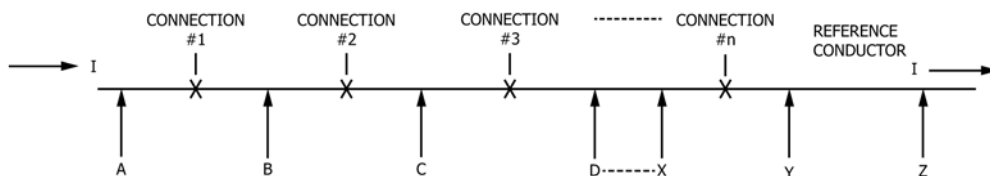

NOTE 1—Potential drop for connection No. 1 is measured between A and B, for connection No. 2 between B and C, etc. Test board may be configured with separate measurement points for adjacent connections if required due to mechanical configuration.

FIG. 3 Test Board Schematic, Alternative Method

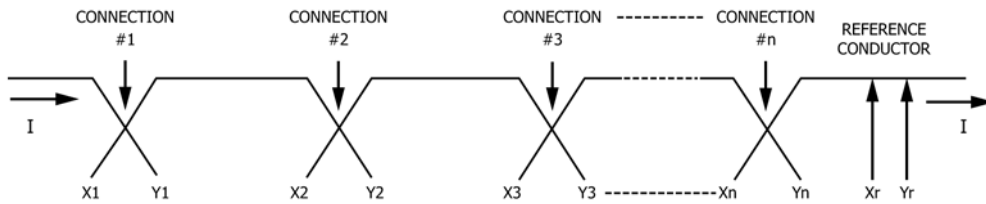

NOTE 1—Potential drop for connection No. 1 is measured between X1 and Y1, for connection No. 2 between X2 and Y2, etc.

FIG. 4 Test Board Schematic, Four-Wire Method

13.2 For the purpose of establishing the upper limit of the thermal cycle, the rated temperature of a component of the test system is considered to be that marked on the component (connector, cable insulation, etc.) itself, on its label or package, or in the installation instructions as normally supplied by the manufacturer. Should there be contradictions in the marked temperature (example: connector marked with different temperature than instructions), then the highest value of those marked shall be considered as the rated temperature.

13.3 When no rating is evident per the previous section, then set 100°C as the upper limit of the thermal cycle.

14. Test Chamber Conditioning

14.1 *Temperature*—Precondition the chamber to the selected upper temperature. The chamber shall be considered to be stabilized if it has operated within the specified range for one half hour or more.

14.2 *Humidity*—Precondition the humidity vessel by operation overnight in a sealed condition with the specified water supply in place prior to the first loading of test boards. Thereafter, maintain water supply and sealing whenever test boards are removed for readout or thermal cycle.

15. Test Procedure

15.1 *Summary*—The tested connections are measured for time-zero potential drop at rated current, and are then subjected to five cycles of 75°C temperature change (approximately 1 h each), remeasured for potential drop, and subjected for the rest of the 1-week period to conditions at or near 100 % relative humidity at room temperature. This overall cycle is repeated for the specified number of weeks, at the end of which a final set of potential drop measurements is taken.

15.2 Potential Drop Measurement:

15.2.1 Connect power supply to test board power supply support post tabs and adjust load current to rated current ± 1 % for the connection system being tested and allow to stabilize.

15.2.2 Using a millivoltmeter, read and record the voltage drop across each test connection, and the reference conductors if applicable.

NOTE 3—Allow meter to stabilize before reading, and assure that voltage probes are in electrical contact with the readout tabs.

High-potential drop across some individual connections may indicate abnormal heating due to degradation at the contact interfaces. When this condition is observed, precautions should be taken to minimize the consequent heating of adjacent or nearby test connections (see 6.1).

15.2.3 Remove the measurement current and allow the connections to cool.

15.2.4 Reapply current across board, allow to stabilize and read and record the voltage drop across the total group of test junctions for each board. This voltage is known as the group voltage.

15.2.5 Remove measurement current and allow test terminations and connections to cool to room temperature. Fan cooling is acceptable for this procedure in order to speed equilibration.

15.3 Thermal Cycling:

15.3.1 After completion of the measurement of 15.2, transfer the boards into the preconditioned (at high thermal cycle boundary) temperature chamber.

15.3.2 Maintain the chamber at the required temperature and allow test connections to remain inside for 50 min ± 3 min, or longer if required to achieve temperature equilibrium (see Note 4).

NOTE 4—Preliminary instrumented tests will generally be required to determine the time required to achieve thermal equilibrium for the particular connection system, test board configuration, and thermal conditioning system used.

15.3.3 Remove the boards from the temperature chamber and allow the test terminations and connectors to cool to room temperature using forced air cooling if required. Test boards should remain outside the chamber for the minimum time required to achieve temperature equilibrium (see Note 4). Alternatively, for the case where the lower temperature of the thermal cycle is below room temperature, transfer the boards to the lower temperature chamber and hold until test connection temperature has equilibrated at desired lower temperature (see Note 4). If the test boards are manually transferred between chambers, use care to avoid mechanical disturbance.

15.3.4 Repeat the operations indicated in 15.3.1, 15.3.2, and 15.3.3 for a total of five cycles.

15.3.5 Repeat the voltage measurement and cooling step indicated in 15.2.4 and 15.2.5.

15.4 Humidity Exposure

15.4.1 After the completion of the procedures of 15.3, transfer the test boards into the preconditioned humidity vessel. Seal the vessel and allow the test boards to remain in the humidity chamber until the morning following the sixth day in the chamber.

15.4.2 Remove the test boards from the chamber and inspect for any visible condensation on test connections. Record observations.

15.4.3 Perform group voltage measurements and cooling step in accordance with 15.2.4 and 15.2.5.

15.4.4 Perform individual connection potential drop measurements in accordance with 15.2.1, 15.2.2, and 15.2.3.

15.5 *Test Sequence Repetition*—Repeat the procedure of Sections 15.2, 15.3 and 15.4 until the specified number of weeks of testing has been completed.

15.6 *Tap Resistance Test*—This measurement is required to assure that high probe connection resistance has not influenced the potential drop measurement results. The measurement is to be made at the end of the test sequence, or earlier if it is desired to confirm that observed increases in potential drop of individual connections are in fact due to test connection resistance increase rather than probe connection resistance increase. Check that the probe connection resistance does not exceed 0.05 % of the input impedance of the instrument used to measure potential drop. This may be done by measuring the resistance between adjacent pairs of tap connections in the test board circuit, using an ohmmeter and connecting it by the same method as previously utilized for potential drop measurements. Should high readings be encountered, additional ohmmeter tests may be used to isolate the particular connection(s) causing the high reading. If it is found that tap or probe clip connection resistance is high, it is necessary to estimate the influence on test results and determine if the test is valid or if it must be repeated using an improved method of installation of the taps or connection of the probe leads, or both.

16. Calculation

16.1 *Normalization of Raw Data*—Potential drop data for the tested connections is normalized to the conditions of the first set of data by multiplying by the ratio of reference conductor potential drop measurements. This essentially eliminates variations in the data that are due to differences in current and ambient temperature at the time of measurement and instrumentation calibration shift. In general, the normalized data will differ most significantly from the raw data for the alternate method of potential drop measurement, which is most sensitive to these variables.

16.1.1 The normalizing factor is calculated as follows:
Normalizing Factor

$$= (\text{time-zero Reference Conductor Potential Drop}) / \text{Reference Conductor Potential Drop}$$

16.1.2 An illustration of the application of the normalizing factor is as follows:

Raw Data

Time-Zero Reference Conductor Potential Drop = 56.5 mV
At subsequent measurement:
Reference Conductor Potential Drop = 57.7 mV
Test Connection No. N Potential Drop = 12.2 mV

Calculation

Normalized Potential Drop for Test Connection No. N
= $12.2 \times (56.5/57.7)$
= 11.9 mV

16.1.3 Round off and report normalized data in the same number of significant figures as the raw data.

16.2 The ratio of average connection potential drop increase, relative to the reference connections, is calculated using the normalized data. For each test connection group, including the reference connections, the average initial and

final potential drop of the individual connections is calculated and the difference is determined. Determine the ratio as follows:

$$\text{Ratio} = \frac{T - I}{F - A}$$

where:

T = test final,
 I = initial,
 F = reference final, and
 A = reference initial.

17. Report

17.1 Report the following:

- 17.1.1 Identification of connection system tested,
- 17.1.2 Date of test completion,
- 17.1.3 Identification of party performing the test,
- 17.1.4 Brief description of connection system tested (including connector/connection type or model number, type of conductors used, mechanical configurations etc.),
- 17.1.5 Total number of test connections,
- 17.1.6 Total number of reference connections,
- 17.1.7 Applied temperature cycle limits,
- 17.1.8 Test duration, number of weeks,
- 17.1.9 Average Potential drop increase of test connections relative to reference connections,
- 17.1.10 Maximum individual connection increase in potential drop,
- 17.1.11 General description of visual appearance changes of connections tested (corrosion, discoloration, etc.),
- 17.1.12 Measurement current used for potential drop measurements, and
- 17.1.13 Availability of detailed test data in accordance with 16.2.

17.2 Permanently record the following detailed test data for each test connection group during the performance of the test sequence.

- 17.2.1 For Each Connection Group Tested:
 - 17.2.1.1 Dates (start of test, each measurement set, significant events),
 - 17.2.1.2 Identification of party performing the test,
 - 17.2.1.3 Complete description of connection system tested (Type and Model No. of connector/connection system tested, type of wire, cable busbar, or other conductor(s) used in the connection system, mechanical configuration, etc.),
 - 17.2.1.4 Connection installation/assembly procedure,
 - 17.2.1.5 Diagrams and description of test boards, with identification of individual connection positions,
 - 17.2.1.6 Description of measurement and conditioning apparatus,
 - 17.2.1.7 Detailed description of applied test and measurement conditions, including standard procedure followed, optional deviations (such as use of fan cooling), and variations in the procedure relative to the prescribed test method,
 - 17.2.1.8 Tables of individual, group, and reference conductor potential drop measurements, with individual connection identification correlated to the diagrams and descriptions of the test boards,

- 17.2.1.9 Tables of conditioned (normalized to the reference conductor) potential drop data for individual connections,
 - 17.2.1.10 Results of measurement tap resistance test, with estimate of effect of high tap resistance if encountered,
 - 17.2.1.11 Unusual conditions noted during performance of test, and
 - 17.2.1.12 Detailed description of visual appearance changes of connections tested (corrosion, discoloration, etc.).
- 17.2.2 Overall Test
- 17.2.2.1 Data compilations and calculations used to prepare summary report (see Sections 15 and 16).

18. Precision and Bias⁵

18.1 The precision of this test method is presently being evaluated by ASTM Committee B04. Precision of a similar test

⁵ Supporting data have been filed at ASTM International Headquarters and may be obtained by requesting Research Report RR:B04-1002. Contact ASTM Customer Service at service@astm.org.

method has been measured and found to be acceptable for purposes of this standard.

18.2 The bias of this test method is not measurable as results are reported only in reference to internal controls provided for each test. As such, this test method has no bias.

19. Keywords

19.1 aluminum; aluminum connections; contacts; environmental testing; humidity testing; mixed environmental testing; mixed stress testing; neutral bar; pressure connection; stress testing; thermal cycling; twist-on connector

APPENDICES

(Nonmandatory Information)

XI. APPLICATION TO NEUTRAL BUS

XI.1 Introduction—This appendix provides details of specimen preparation and installation as the test method would be applied to aluminum-bodied neutral bus connections for use with small branch circuit sizes of aluminum and copper wire. This is a specific connection system of the type that can be measured by the four-wire method. The procedure described is based on experience gained in a round-robin test under ASTM Task Group B04.04.07 on Aluminum/Environmental. (For additional information and experimental results, refer to the round-robin No. 2 test report, Test Method B812.)

XI.2 Specimen Preparation:

XI.2.1 Neutral Bus—Continuous-strip aluminum neutral bus, as available for residential service panels, 100A, is procured for testing. Strips shall be cut into discrete segments having four positions. The outer two positions are modified (that is: remove terminal screw, drill through as per Fig. XI.1) to provide for mounting to the test board assembly. Cut and drill without lubricants, to eliminate the need to clean with solvents. While cutting and drilling, protect the inner two terminal positions so as to prevent contamination with cutting or drilling debris. Clean all chips or other cutting debris before removing protection over inner terminal positions.

XI.2.2 Wire—Aluminum and copper test conductors shall each be supplied from a single source as a single lot of material. Strip insulation from the wire end for the appropriate length using a conventional stripping tool in such fashion as to insure a complete absence of abrasion or nicking of the wire surface. Wire ends are not to be treated by abrasion or application of antioxidant coating, unless specifically called for in the manufacturers instructions supplied with the neutral bus.

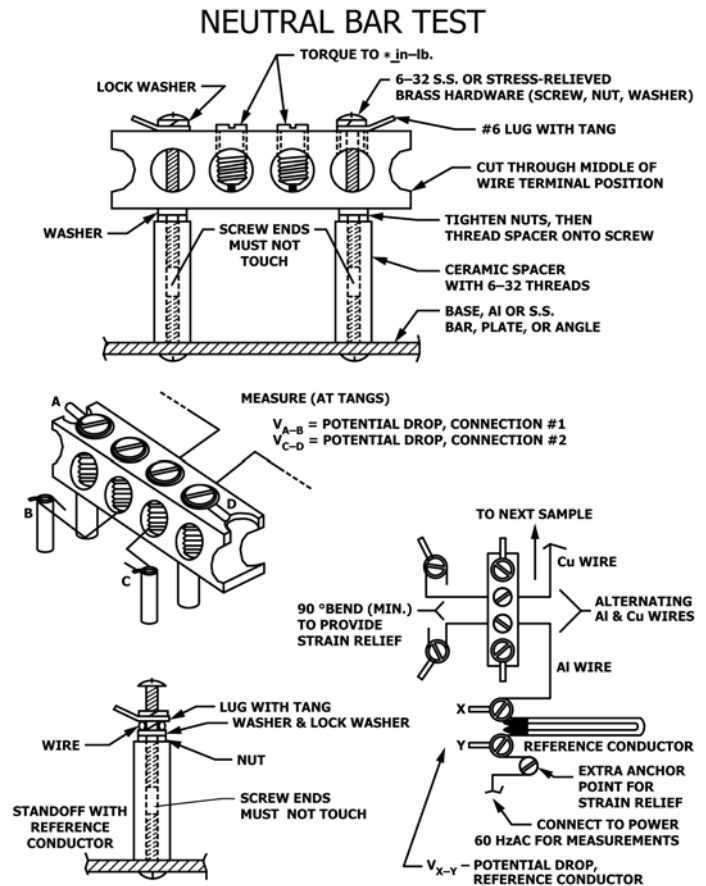

FIG. X1.1 Neutral Bar Test

X1.3 Test Board Assembly:

X1.3.1 Sample size for each test group shall comprise a minimum of 20 individual connections.

X1.3.2 *Test Samples*—Mount the prepared bus segments to an aluminum board free from materials which might outgas during the test in accordance with Fig. X1.1. Mount readout support posts on the test board. (Two for each segment mounted at least 12 mm from the segment and offset from the axis of the connection hole in the segment to allow for strain relief as shown in Fig. X1.1, plus two support posts for each reference conductor in accordance with Fig. X1.1.) Using 200 mm (8 in.) lengths of conductor wire bent to a U shape, insert the wire through the two nearest terminals in adjacent bus segments such that the base of the U is no nearer the segments than 1 in. and the wire extends beyond the segments for connection to the readout support posts as shown in Fig. X1.1. Bend the wire as shown to provide strain relief and wrap the wire ends around the readout support posts and fasten securely, attaching a probe contact tab as indicated in Fig. X1.1. Assemble all the readout support posts and the power supply contact support posts with the conductor wire. After all of the conductors are in place and after all the other screws have been secured, tighten the wire terminal set screws on all the bus segments to the torque specified in the manufacturer’s installation instruction sheet supplied with the neutral bus (or, if lacking in the manufacturers instructions, from the *heat-cycle* test values in UL486B).

X1.3.3 *Test Boards*—Test boards containing the fully assembled test conductors, test terminals and test connectors shall be configured in accordance with Fig. X1.2.

X1.4 Test Parameters:

X1.4.1 *Thermal Cycle*—The particular neutral bus strips procured for testing are marked indicating a 75°C rating, and therefore a thermal cycle upper limit of 75°C is selected. The lower limit of the thermal cycle is therefore 0°C.

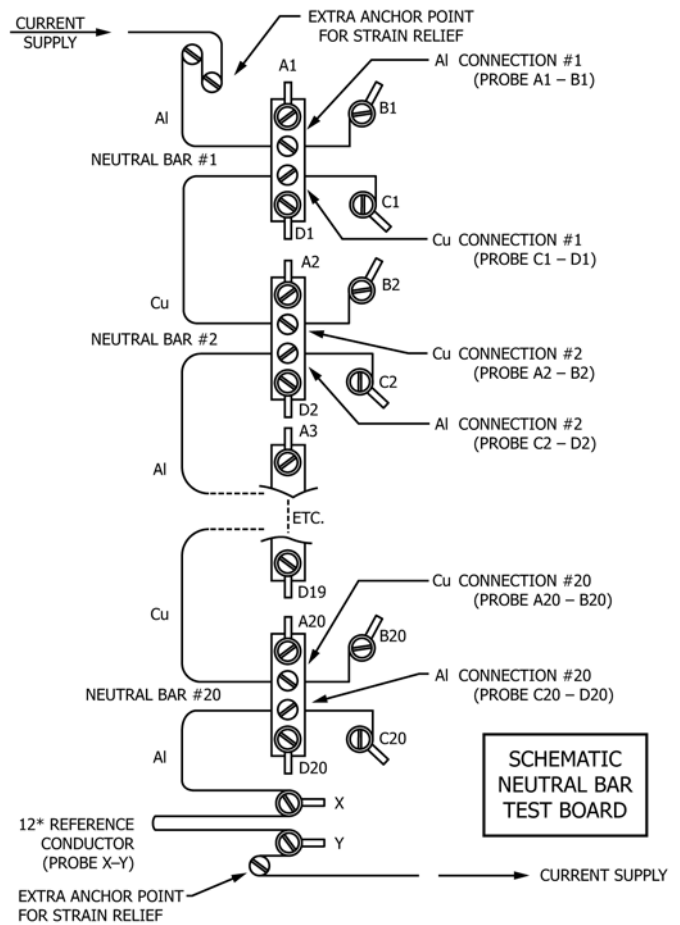

FIG. X1.2 Schematic Neutral Bar Test Board

X1.4.2 *Applied current for potential drop measurement*—Based on the referenced document of Section 2.3, the No. 10 AWG aluminum wire and the No. 12 copper wire are considered to be rated at 20 A for most residential circuit applications. Therefore, the current applied for the purpose of potential drop measurements is 20 A.

X2. APPLICATION TO TWIST-ON SPLICING CONNECTORS

X2.1 *Introduction* —This appendix provides details of specimen preparation and installation as the test method would be applied to twist-on connectors for use with small branch circuit sizes of aluminum and aluminum-copper wire combinations. This is a specific connection system of the type that shall be measured by the alternative method. The procedure described is based on experience gained in a round-robin test under ASTM Task Group B04.04.07 on Aluminum/Environmental. (For additional information and experimental results, refer to the round-robin No. 1 test report, Test Method B812.)

X2.2 Specimen Preparation:

X2.2.1 *Twist-on Connectors*—Connectors shall be identified as suitable for aluminum to aluminum or aluminum to copper wire combinations.

X2.2.2 *Wire*—Aluminum and copper test conductors shall each be supplied from a single source as a single lot of material. Strip insulation from the wire end for the appropriate length using a conventional stripping tool in such fashion as to insure a complete absence of abrasion or nicking of the wire surface. Wire ends are not to be treated by abrasion or application of antioxidant coating, unless specifically called for in the manufacturers instructions supplied with the connectors.

X2.3 Test Board Assembly:

X2.3.1 Sample size for each test shall comprise a minimum of 20 individual connections.

X2.3.2 *Assembly*—Conductor wire readout support posts are to be mounted in a straight line 50 mm (2 in.) apart in accordance with Fig. X2.1. Power supply attachment support posts are to be mounted as indicated in the same figure. Using

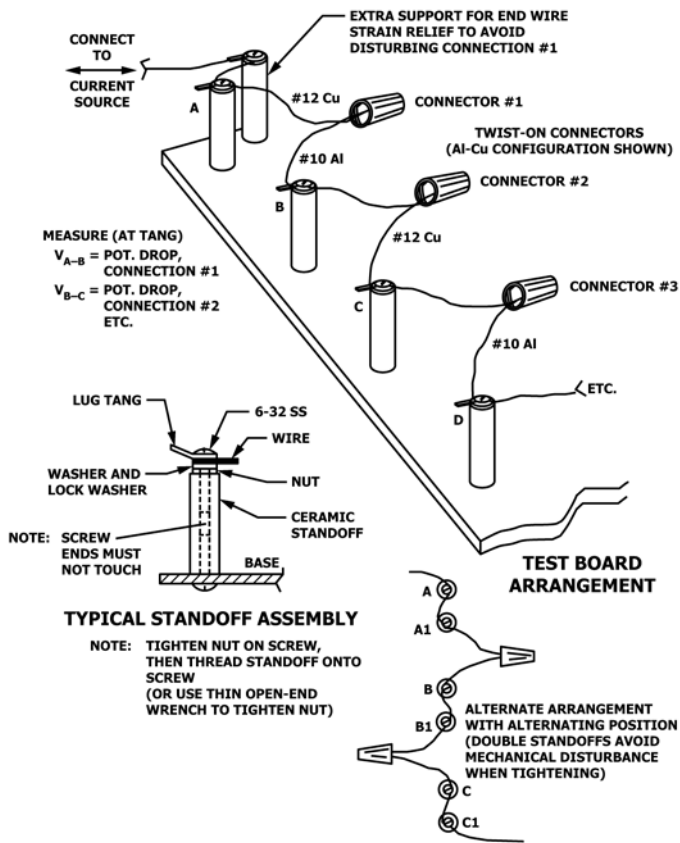

FIG. X2.1 Twist-on-Connectors

165 mm (6.5 in.) lengths of conductor, shape a U to fit around the screw in the readout support posts. Using a 450 mm (18 in.)

length of conductor wire, shape a 300 mm (12 in.) reference length and attach in accordance with Fig. X2.1. Use probe contact tabs on all readout and power supply connections. Connect the free ends of the conductor wires in such fashion as to form a series circuit in accordance with Fig. X2.1 using 20 twist-on connectors. Insert the wire ends into the connectors and torque the connectors in accordance with the manufacturer's instructions or, lacking specific tightening instructions, to the torque specified in UL486C, paragraph 7.20. Adhere to manufacturer's recommendations with the preceding exceptions. A sample of the conductor that is used on a given board shall also be used as a reference conductor. The reference conductor should be 300 mm (12 in.) long and mounted on the test boards as shown in Fig. X2.2.

X2.3.3 *Test Boards*—Test boards containing the fully assembled test conductor and sample connectors shall be configured in accordance with Fig. X2.1.

X2.3.4 *Test Circuits*—The testing circuits shall be in general accordance with Fig. X2.2.

X2.4 *Test Parameters:*

X2.4.1 *Thermal Cycle*—The particular connectors procured for testing are marked indicating a 105°C rating, and therefore a thermal cycle upper limit of 100°C is selected. The lower limit of the thermal cycle is therefore 25°C room temperature.

X2.4.2 *Applied current for potential drop measurement.* Based on the referenced document of Section 2.3, the No. 10 AWG aluminum wire and the No. 12 copper wire are considered to be rated at 20 A for most residential circuit applications. Therefore, the current applied for the purpose of potential drop measurements is 20 A.

SCHEMATIC
TWIST-ON CONNECTOR TEST BOARD

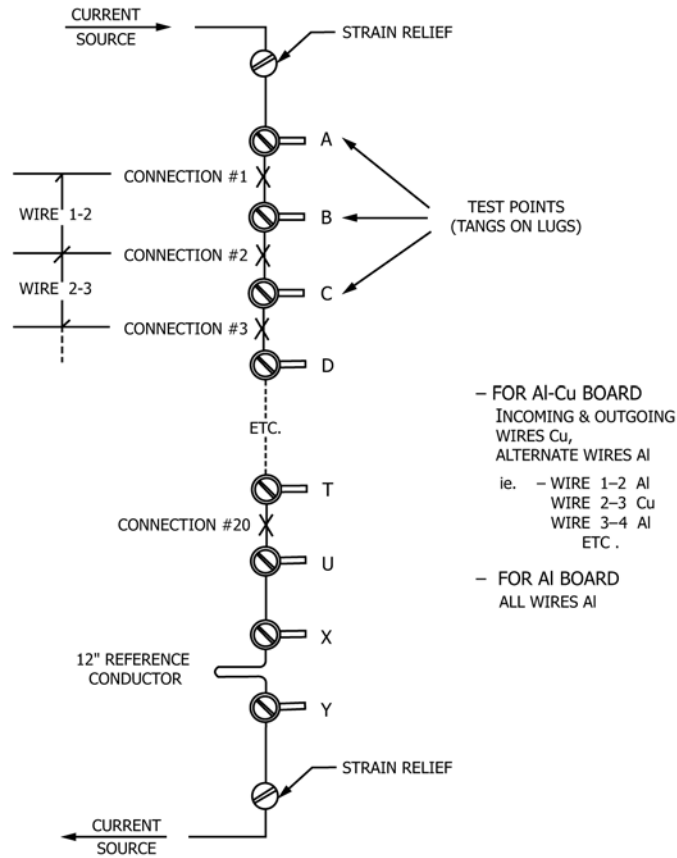

FIG. X2.2 Schematic Twist on Connector Test Board

ASTM International takes no position respecting the validity of any patent rights asserted in connection with any item mentioned in this standard. Users of this standard are expressly advised that determination of the validity of any such patent rights, and the risk of infringement of such rights, are entirely their own responsibility.

This standard is subject to revision at any time by the responsible technical committee and must be reviewed every five years and if not revised, either reapproved or withdrawn. Your comments are invited either for revision of this standard or for additional standards and should be addressed to ASTM International Headquarters. Your comments will receive careful consideration at a meeting of the responsible technical committee, which you may attend. If you feel that your comments have not received a fair hearing you should make your views known to the ASTM Committee on Standards, at the address shown below.

This standard is copyrighted by ASTM International, 100 Barr Harbor Drive, PO Box C700, West Conshohocken, PA 19428-2959, United States. Individual reprints (single or multiple copies) of this standard may be obtained by contacting ASTM at the above address or at 610-832-9585 (phone), 610-832-9555 (fax), or service@astm.org (e-mail); or through the ASTM website (www.astm.org). Permission rights to photocopy the standard may also be secured from the Copyright Clearance Center, 222 Rosewood Drive, Danvers, MA 01923, Tel: (978) 646-2600; http://www.copyright.com/